

Automated Driving Toolbox™

Reference



MATLAB® & SIMULINK®

R2023a



How to Contact MathWorks



Latest news: www.mathworks.com
Sales and services: www.mathworks.com/sales_and_services
User community: www.mathworks.com/matlabcentral
Technical support: www.mathworks.com/support/contact_us



Phone: 508-647-7000



The MathWorks, Inc.
1 Apple Hill Drive
Natick, MA 01760-2098

Automated Driving Toolbox™ Reference

© COPYRIGHT 2017–2023 by The MathWorks, Inc.

The software described in this document is furnished under a license agreement. The software may be used or copied only under the terms of the license agreement. No part of this manual may be photocopied or reproduced in any form without prior written consent from The MathWorks, Inc.

FEDERAL ACQUISITION: This provision applies to all acquisitions of the Program and Documentation by, for, or through the federal government of the United States. By accepting delivery of the Program or Documentation, the government hereby agrees that this software or documentation qualifies as commercial computer software or commercial computer software documentation as such terms are used or defined in FAR 12.212, DFARS Part 227.72, and DFARS 252.227-7014. Accordingly, the terms and conditions of this Agreement and only those rights specified in this Agreement, shall pertain to and govern the use, modification, reproduction, release, performance, display, and disclosure of the Program and Documentation by the federal government (or other entity acquiring for or through the federal government) and shall supersede any conflicting contractual terms or conditions. If this License fails to meet the government's needs or is inconsistent in any respect with federal procurement law, the government agrees to return the Program and Documentation, unused, to The MathWorks, Inc.

Trademarks

MATLAB and Simulink are registered trademarks of The MathWorks, Inc. See www.mathworks.com/trademarks for a list of additional trademarks. Other product or brand names may be trademarks or registered trademarks of their respective holders.

Patents

MathWorks products are protected by one or more U.S. patents. Please see www.mathworks.com/patents for more information.

Revision History

March 2017	Online only	New for Version 1.0 (Release 2017a)
September 2017	Online only	Revised for Version 1.1 (Release 2017b)
March 2018	Online only	Revised for Version 1.2 (Release 2018a)
September 2018	Online only	Revised for Version 1.3 (Release 2018b)
March 2019	Online only	Revised for Version 2.0 (Release 2019a)
September 2019	Online only	Revised for Version 3.0 (Release 2019b)
March 2020	Online only	Revised for Version 3.1 (Release 2020a)
September 2020	Online only	Revised for Version 3.2 (Release 2020b)
March 2021	Online only	Revised for Version 3.3 (Release 2021a)
September 2021	Online only	Revised for Version 3.4 (Release 2021b)
March 2022	Online only	Revised for Version 3.5 (Release 2022a)
September 2022	Online only	Revised for Version 3.6 (Release 2022b)
March 2023	Online only	Revised for Version 3.7 (Release 2023a)

1	<u>Apps</u>
2	<u>Blocks</u>
3	<u>Functions</u>
4	<u>Objects</u>
5	<u>Scene Dimensions</u>
6	<u>Vehicle Dimensions</u>
7	<u>RoadRunner Scenario Blocks</u>
8	<u>RoadRunner Scenario Objects</u>

Apps

Bird's-Eye Scope

Visualize sensor coverages, detections, and tracks

Description

The **Bird's-Eye Scope** visualizes aspects of a driving scenario found in your Simulink® model.

Using the scope, you can:

- Inspect the coverage areas of radar, vision, lidar and ultrasonic sensors.
- Analyze the sensor detections of actors, road boundaries, and lane boundaries.
- Analyze the tracking results of moving actors within the scenario.

To get started, open the scope and click **Find Signals**. The scope updates the block diagram, finds signals representing aspects of the driving scenario, organizes the signals into groups, and displays the signals. You can then analyze the signals as you simulate, organize the signals into new groups, and modify the graphical display of the signals.

For more details about using the scope, see “Visualize Sensor Data and Tracks in Bird's-Eye Scope”.

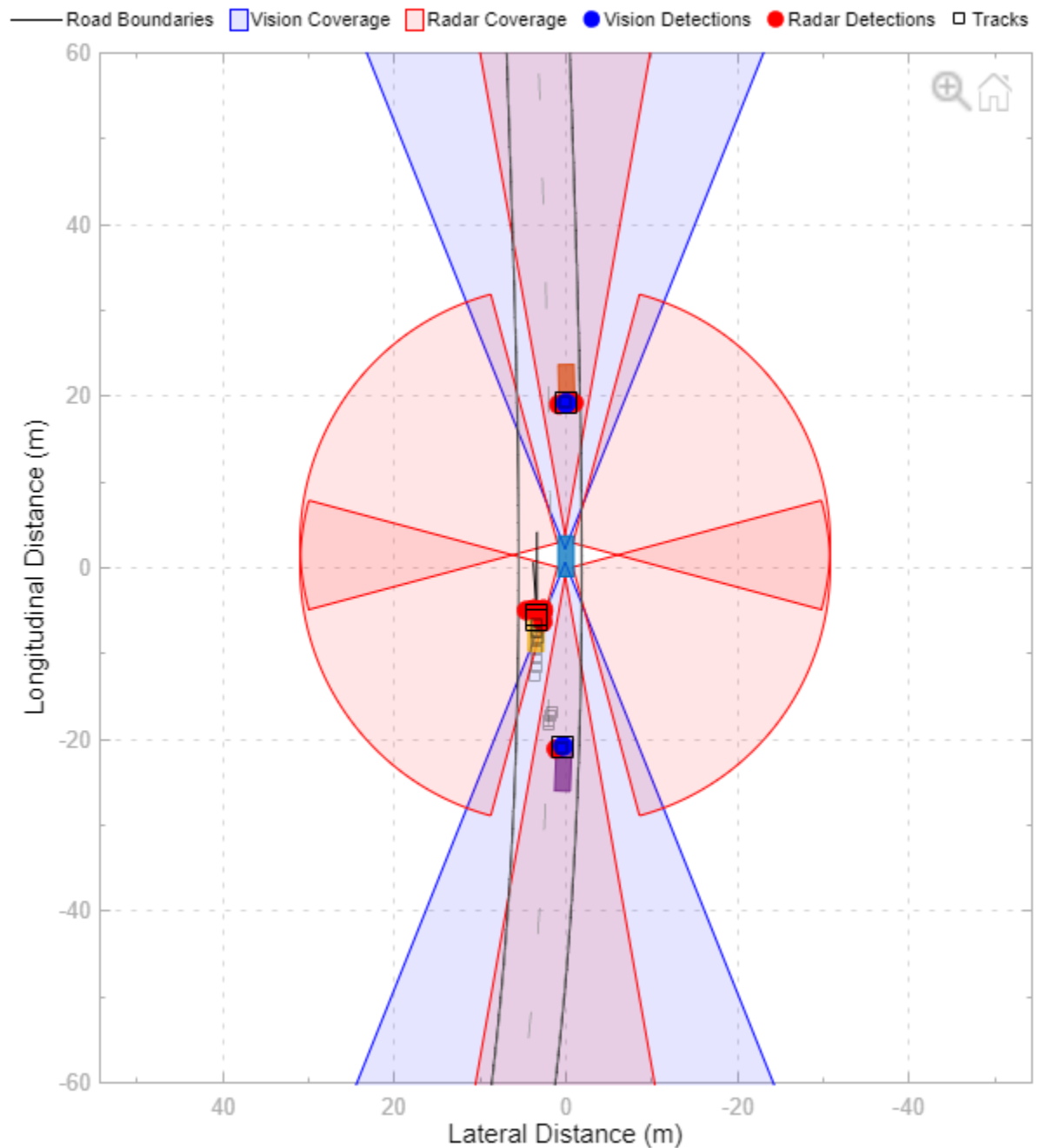

Open the Bird's-Eye Scope App

Simulink Toolstrip:

- On the **Simulation** tab, under **Review Results**, click **Bird's-Eye Scope**.
- On the **Apps** tab, under **Signal Processing and Wireless Communications**, click **Bird's-Eye Scope**.

Examples

- “Visualize Sensor Data and Tracks in Bird's-Eye Scope”
- “Visualize Sensor Data from Unreal Engine Simulation Environment”
- “Sensor Fusion Using Synthetic Radar and Vision Data in Simulink”
- “Lane Following Control with Sensor Fusion and Lane Detection”
- “Autonomous Emergency Braking with Sensor Fusion”
- “Test Open-Loop ADAS Algorithm Using Driving Scenario”
- “Test Closed-Loop ADAS Algorithm Using Driving Scenario”

Parameters

Settings > Vehicle Coordinates View

Longitudinal axis limits — Longitudinal axis limits

`[-60,60]` (default) | `[min, max]` vector

Longitudinal axis limits, specified as a `[min, max]` vector.

Tunable: Yes

Lateral axis limits — Lateral axis limits

`[-30,30]` (default) | `[min, max]` vector

Lateral axis limits, specified as a `[min, max]` vector.

Tunable: Yes

Track position selector — Selection matrix used to extract positions of tracked objects

`[1,0,0,0,0,0; 0,0,1,0,0,0]` (default) | 2-by- n matrix of zeros and ones

Selection matrix used to extract the positions of tracks output by the Multi-Object Tracker block. The scope extracts the positions from the state vectors of the tracks, which are stored in the `State` fields of the output track structures. If you specify the wrong selection, then the scope displays incorrect track positions.

Specify **Track position selector** as a 2-by- n matrix of zeros and ones, where n is the size of the state vectors across all tracks. These state vectors contain position, velocity, acceleration, and other state information about the tracked objects.

The default selection matrix selects track positions from a 3-D constant-velocity state vector of the form `[x;vx;y;vy;z;vz]`. For each track, the scope multiplies the selection matrix by the state vector to obtain the x-position and y-position, as shown here:

$$[1,0,0,0,0,0; 0,0,1,0,0,0] * [x;vx;y;vy;z;vz] = [x;y]$$

For MATLAB® code examples illustrating this selection process, see the `getTrackPositions` function and `multiObjectTracker` object.

The formats of the state vector and corresponding selection matrix depend on the Kalman filter that the Multi-Object Tracker block uses to track objects. Suppose the Multi-Object Tracker block is initialized to use a 2-D constant-velocity linear Kalman filter, where the **Filter initialization**

function name parameter of the block is set to the `initcvkf` function. For this type of filter, track states are of the form $[x; vx; y; vy]$. To visualize the positions of tracks output by this block, set **Track position selector** to $[1, 0, 0, 0; 0, 0, 1, 0]$.

Tunable: No

Track velocity selector — Selection matrix used to extract velocities of tracked objects
 $[0, 1, 0, 0, 0, 0; 0, 0, 0, 1, 0, 0]$ (default) | 2-by- n matrix of zeros and ones

Selection matrix used to extract the velocities of tracks output by the Multi-Object Tracker block. The scope extracts the velocities from the state vectors of the tracks, which are stored in the **State** fields of the output track structures. If you specify the wrong selection, then the scope displays incorrect track velocities.

Specify **Track velocity selector** as a 2-by- n matrix of zeros and ones, where n is the size of the state vectors across all tracks. These state vectors contain position, velocity, acceleration, and other state information about the tracked objects.

The default selection matrix selects track velocities from a 3-D constant-velocity state vector of the form $[x; vx; y; vy; z; vz]$. For each track, the scope multiplies the selection matrix by the state vector to obtain the track velocities in the x-direction, vx , and y-direction, vy , as shown here:

$$[0, 1, 0, 0, 0, 0; 0, 0, 0, 1, 0, 0] * [x; vx; y; vy; z; vz] = [vx; vy]$$

For MATLAB code examples illustrating this selection process, see the `getTrackVelocities` function and `multiObjectTracker` object.

The formats of the state vector and corresponding selection matrix depend on the Kalman filter that the Multi-Object Tracker block uses to track objects. Suppose the Multi-Object Tracker block is initialized to use a 2-D constant-velocity linear Kalman filter, where the **Filter initialization function name** parameter of the block is set to the `initcvkf` function. For this type of filter, track states are of the form $[x; vx; y; vy]$. To visualize the velocities of tracks output by this block, set **Track velocity selector** to $[0, 1, 0, 0; 0, 0, 0, 1]$.

Tunable: No

Settings > Global

Display short signal names — Display signal names without path information
 on (default) | off

- Select this parameter to display short signal names (signals without path information).
- Clear this parameter to display long signal names (signals with path information).

Consider the signal `VisionDetection` within subsystem `Sensor Simulation`. When you select this parameter, the short name, `VisionDetection`, is displayed. When you clear this parameter, the long name, `Sensor Simulation/VisionDetection`, is displayed.

Tunable: Yes

Signal Properties (Subset Only)

Alpha — Transparency of coverage area
 0.1 (default) | real scalar in the range [0, 1]

Transparency of the coverage area, specified as a real scalar in the range [0, 1]. A value of 0 makes the coverage area fully transparent. A value of 1 makes the coverage area fully opaque.

This property is available only for signals in the **Sensor Coverage** group.

Tunable: Yes

Velocity Scaling — Scale factor for magnitude length of velocity vectors
1 (default) | real scalar in the range [0, 20]

Scale factor for the magnitude length of the velocity vectors, specified as a real scalar in the range [0, 20]. The scope renders the magnitude vector value as $M \times \text{Velocity Scaling}$, where M is the magnitude of the velocity.

This property is available only for signals in the **Detections** or **Tracks** groups.

Tunable: Yes

Limitations

General Limitations

- Referenced models are not supported. To visualize signals that are within referenced models, move the output of these signals to the top-level model.
- Rapid accelerator mode is not supported.
- External mode and simulating a model from a generated executable is not supported.
- If you initialize your model in fast restart, then after the first time you simulate, the **Find Signals** or **Update Signals** button is disabled. To enable **Find Signals** or **Update Signals** again, on the **Debug** tab of the Simulink toolstrip, click **Fast Restart**.

Scenario Reader Block Limitations

- The **Bird's-Eye Scope** does not support visualization in a model that contains:
 - More than one Scenario Reader block.
 - A Scenario Reader block within a nonvirtual subsystem, such as an atomic or enabled subsystem.
 - A Scenario Reader block that is configured to output actors and lane boundaries in world coordinates (**Coordinate system of outputs** parameter set to **World Coordinates**).
- For Scenario Reader blocks in which you specify the ego vehicle using the **Ego Vehicle** input port, the ego vehicle signal must be connected directly to the block. Visualization of ego vehicle signals that are output from a nonvirtual subsystem or referenced model are not supported.

3D Simulation Block Limitations

- The visualization of roads, lanes, and actors from Simulation 3D Scene Configuration blocks is not supported. If your block contains a Simulation 3D Scene Configuration block, the **Bird's-Eye Scope** still displays an ego vehicle, but it has default vehicle dimensions.

More About

Applicable Signals

When the **Bird's-Eye Scope** finds signals in your model, it automatically groups signals by type. These groupings are based on the sources of the signals within the model.

Signal Group	Description	Signal Sources
Ground Truth	<p>Road boundaries, lane markings and barriers in the scenario</p> <p>You cannot modify this group or any of its signals.</p> <p>To inspect large road networks, use the World Coordinates View window. See “Vehicle and World Coordinate Views” on page 1-9.</p>	<ul style="list-style-type: none"> Scenario Reader block
Actors	<p>Actors in the scenario, including the ego vehicle</p> <p>You cannot modify this group or any of its signals or subgroups.</p> <p>To view actors that are located away from the ego vehicle, use the World Coordinates View window. See “Vehicle and World Coordinate Views” on page 1-9.</p>	<ul style="list-style-type: none"> Scenario Reader block Vision Detection Generator, Driving Radar Data Generator, and Lidar Point Cloud Generator blocks (for actor profile information only, such as the length, width, and height of actors) If actor profile information is not set or is inconsistent between blocks, the scope sets the actor profiles to the default actor profile values for each block. The profile of the ego vehicle is always set to the default profile for each block.

Signal Group	Description	Signal Sources
<p>Sensor Coverage</p>	<p>Coverage areas of vision, radar, and lidar sensors, sorted into Vision, Radar, Lidar, and Ultrasonic subgroups</p> <p>You can modify signals in this group.</p> <p>You can rename or delete subgroups but not the top-level Sensor Coverage group. You can also add subgroups and move signals between subgroups. If you delete a subgroup, its signals move to the top-level Sensor Coverage group.</p>	<ul style="list-style-type: none"> • Vision Detection Generator block • Simulation 3D Vision Detection Generator block • Driving Radar Data Generator block • Simulation 3D Probabilistic Radar block • Lidar Point Cloud Generator block • Simulation 3D Lidar block • Ultrasonic Detection Generator
<p>Detections</p>	<p>Detections obtained from vision, radar, and lidar sensors, sorted into Vision, Radar, Lidar, and Ultrasonic subgroups</p> <p>You can modify signals in this group.</p> <p>You can rename or delete subgroups but not the top-level Detections group. You can also add subgroups and move signals between subgroups. If you delete a subgroup, its signals move to the top-level Detections group.</p>	<ul style="list-style-type: none"> • Vision Detection Generator block • Simulation 3D Vision Detection Generator block • Driving Radar Data Generator block • Lidar Point Cloud Generator block • Simulation 3D Probabilistic Radar block • Simulation 3D Lidar block • Ultrasonic Detection Generator
<p>Tracks</p>	<p>Tracks of objects in the scenario</p> <p>You can modify signals in this group.</p> <p>You can rename or delete subgroups but not the top-level Tracks group. You can also add subgroups to this group and move signals into them. If you delete a subgroup, its signals move to the top-level Tracks group.</p>	<ul style="list-style-type: none"> • Multi-Object Tracker block • Tracker blocks in Sensor Fusion and Tracking Toolbox™ <p>The Bird's-Eye Scope displays tracks in ego vehicle coordinates. Tracks in any other coordinate system will appear as offset in the scope.</p>

Signal Group	Description	Signal Sources
<p>Other Applicable Signals</p>	<p>Signals that the scope cannot automatically group, such as ones that combine information from multiple sensors</p> <p>You can modify signals in this group but you cannot add subgroups.</p> <p>Signals in this group do not display during simulation.</p>	<ul style="list-style-type: none"> • Blocks that combine or cluster signals (such as the Detection Concatenation block) • Vehicle To World and World To Vehicle blocks • Any blocks that create nonvirtual Simulink buses containing actor poses <p>For details on the actor pose information required when creating these buses, see the Actors output port of the Scenario Reader block.</p> <ul style="list-style-type: none"> • Any blocks that create nonvirtual Simulink buses containing detections <p>For details on the detection information required when creating these buses, see the Object Detections and Lane Detections output ports of the Vision Detection Generator block.</p> <ul style="list-style-type: none"> • Any blocks that create nonvirtual Simulink buses containing tracks <p>For details on the track information required when creating these buses, see the Confirmed Tracks output port of the Multi-Object Tracker block.</p>

To view a model that includes samples of all these signals types, see the “Sensor Fusion Using Synthetic Radar and Vision Data in Simulink” example.

Vehicle and World Coordinate Views

In the **Bird's-Eye Scope**, the default view displays the driving scenario in vehicle coordinates. During simulation, this view displays the scenario from the perspective of the ego vehicle. Use this view to inspect aspects of the scenario in the immediate vicinity of the ego vehicle.

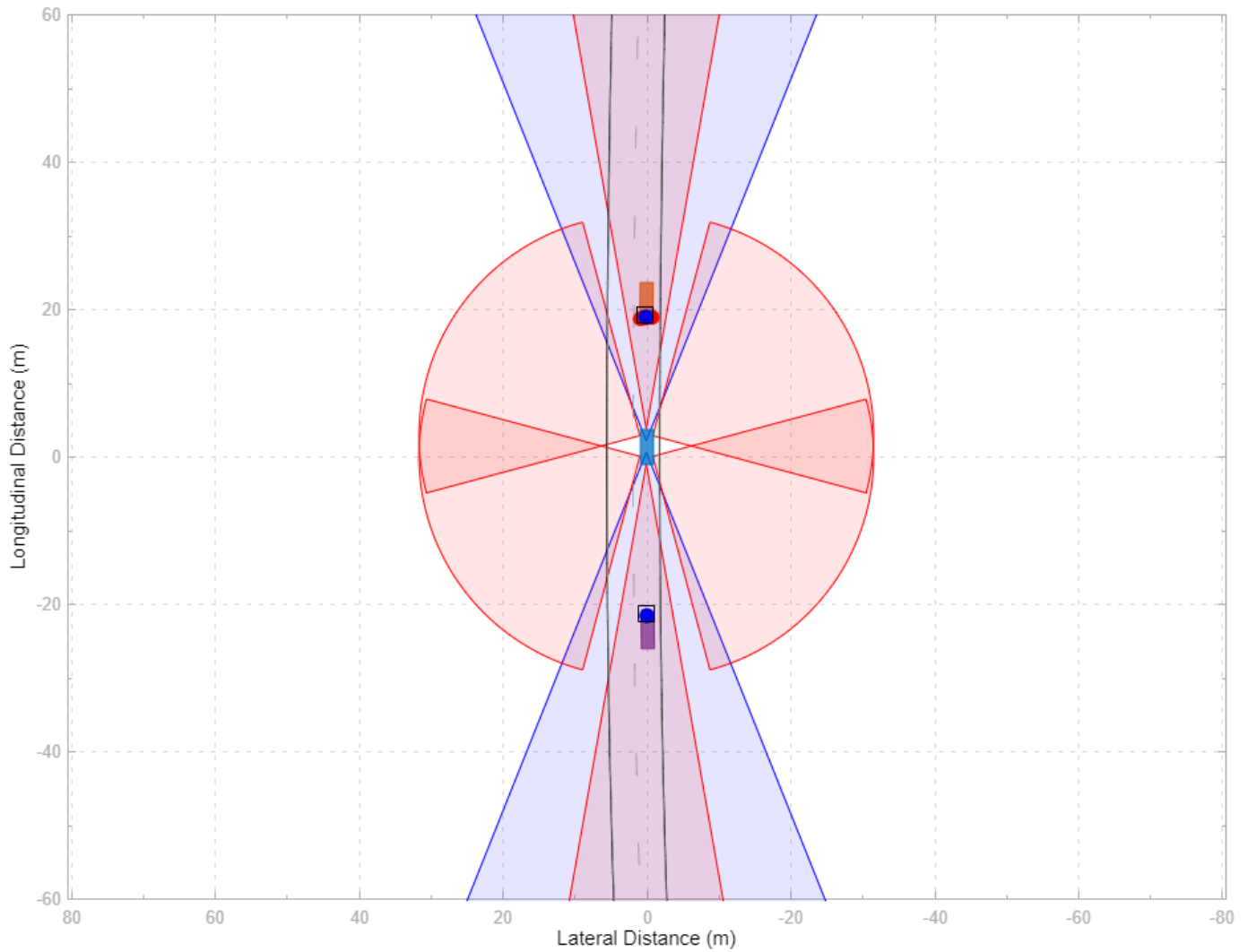

You can also display the driving scenario in world coordinates. On the scope toolstrip, click **World Coordinates** to open the **World Coordinates View** window. Use this window to view the scenario as a whole. You can also use this view to inspect the trajectories of actors that are not in the immediate vicinity of the ego vehicle.

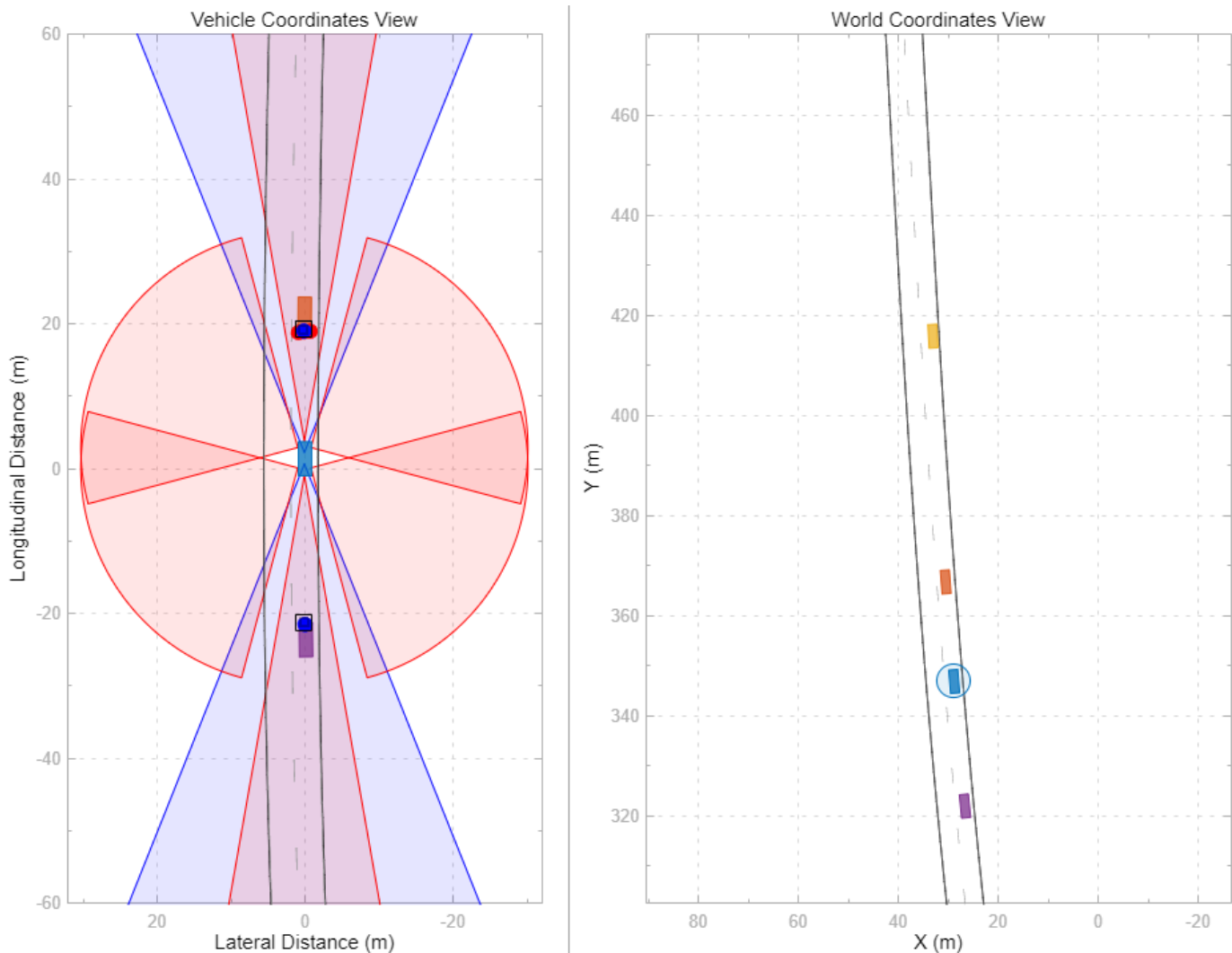

To display the roads and lanes within the **World Coordinates View**, click **Find Signals**. To display the ego vehicle and other actors in the scenario, run the simulation. This view does not display detections, tracks, sensor coverage areas, and other applicable signals. You can view these signals only in the **Vehicle Coordinates View** window.

Note In the **World Coordinates View** window, the circle around the ego vehicle highlights the location of the vehicle in the scenario. It is not a sensor coverage area.

Tips

- To find the source of a signal within the model, in the left pane of the scope, right-click a signal and select **Highlight in Model**.
- You can show or hide signals while simulating. For example, to hide a sensor coverage, first select it from the left pane. Then, from the **Properties** tab, clear the **Show Sensor Coverage** check box.

- When you reopen the scope after saving and closing a model, the scope canvas is initially blank. If you clicked **Find Signals** in a previous session, then click **Run** to run the simulation and visualize the previously found signals. The signals have the same properties from when you last saved the model. If you did not make a graphical change to the scope when you previously had it open, then the **Run** button is not enabled until you click **Find Signals**. Graphical changes include dragging signals to new groups, enabling the legend or **World Coordinates View** window, changing axes limits, or changing the visual properties of actors, lane markings, or sensor coverage areas.

To log and visualize new signals, click **Update Signals**, and then click **Run** to run the simulation.

- If the simulation runs too quickly, you can slow it down by using simulation pacing. On the **Simulation** tab of the Simulink toolstrip, select **Run > Simulation Pacing**. Then, select the **Enable pacing to slow down simulation** check box and decrease the simulation time to less than the default of one second per wall clock second.
- To better inspect the scenario, you can pan and zoom within the **Vehicle Coordinates View** and **World Coordinates View** windows. To return to the default display of either window, in the upper-right corner of that window, click the home button .

Version History

Introduced in R2018b

See Also

Scenario Reader | Detection Concatenation | Driving Radar Data Generator | Vision Detection Generator | Simulation 3D Probabilistic Radar | Simulation 3D Lidar | Lidar Point Cloud Generator | Simulation 3D Vision Detection Generator | Multi-Object Tracker

Topics

“Visualize Sensor Data and Tracks in Bird's-Eye Scope”
“Visualize Sensor Data from Unreal Engine Simulation Environment”
“Sensor Fusion Using Synthetic Radar and Vision Data in Simulink”
“Lane Following Control with Sensor Fusion and Lane Detection”
“Autonomous Emergency Braking with Sensor Fusion”
“Test Open-Loop ADAS Algorithm Using Driving Scenario”
“Test Closed-Loop ADAS Algorithm Using Driving Scenario”

Driving Scenario Designer

Design driving scenarios, configure sensors, and generate synthetic data

Description

The **Driving Scenario Designer** app enables you to design synthetic driving scenarios for testing your autonomous driving systems.

Using the app, you can:

- Create road and actor models using a drag-and-drop interface.
- Configure vision, radar, lidar, INS, and ultrasonic sensors mounted on the ego vehicle. You can use these sensors to generate actor and lane boundary detections, point cloud data, and inertial measurements.
- Load driving scenarios representing European New Car Assessment Programme (Euro NCAP[®]) test protocols [1][2][3] and other prebuilt scenarios.
- Import ASAM OpenDRIVE[®] roads and lanes into a driving scenario. The app supports OpenDRIVE[®] file versions 1.4 and 1.5, as well as ASAM OpenDRIVE file version 1.6.
- Import road data from OpenStreetMap[®], HERE HD Live Map ¹, or Zenrin Japan Map API 3.0 (Itsumo NAVI API 3.0) ² web services into a driving scenario.

Importing data from the Zenrin Japan Map API 3.0 (Itsumo NAVI API 3.0) service requires Automated Driving Toolbox Importer for Zenrin Japan Map API 3.0 (Itsumo NAVI API 3.0) Service.

- Export the road network in a driving scenario to the ASAM OpenDRIVE file format. The app supports OpenDRIVE file versions 1.4 and 1.5, as well as ASAM OpenDRIVE file version 1.6.
- Export road network, actors, and trajectories in a driving scenario to the ASAM OpenSCENARIO[®] 1.0 file format.
- Export synthetic sensor detections to MATLAB.
- Generate MATLAB code of the scenario and sensors, and then programmatically modify the scenario and import it back into the app for further simulation.
- Generate a Simulink model from the scenario and sensors, and use the generated models to test your sensor fusion or vehicle control algorithms.

To learn more about the app, see these videos:

- [Sensor Simulation and Virtual Scene Design with the Driving Scenario Designer App, Part 1](#)
- [Sensor Simulation and Virtual Scene Design with the Driving Scenario Designer App, Part 2](#)

¹ You need to enter into a separate agreement with HERE in order to gain access to the HDLM services and to get the required credentials (access_key_id and access_key_secret) for using the HERE Service.

² To gain access to the Zenrin Japan Map API 3.0 (Itsumo NAVI API 3.0) service and get the required credentials (a client ID and secret key), you must enter into a separate agreement with ZENRIN DataCom CO., LTD.

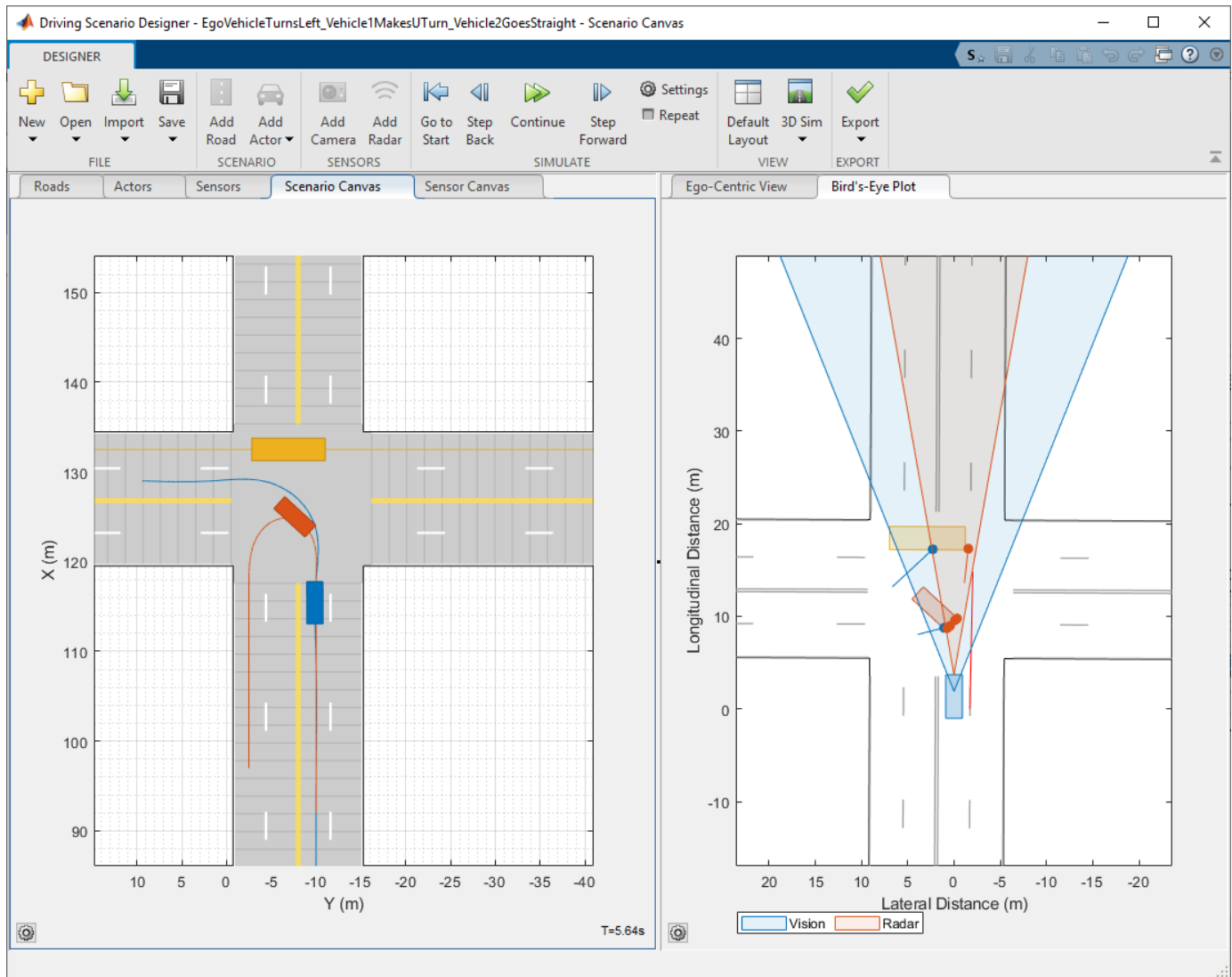

Open the Driving Scenario Designer App

- MATLAB Toolstrip: On the **Apps** tab, under **Automotive**, click the app icon.
- MATLAB command prompt: Enter `drivingScenarioDesigner`.

Examples

Create a Driving Scenario

Create a driving scenario of a vehicle driving down a curved road, and export the road and vehicle models to the MATLAB workspace. For a more detailed example of creating a driving scenario, see "Create Driving Scenario Interactively and Generate Synthetic Sensor Data".

Open the **Driving Scenario Designer** app.

drivingScenarioDesigner

Create a curved road. On the app toolbar, click **Add Road**. Click the bottom of the canvas, extend the road path to the middle of the canvas, and click the canvas again. Extend the road path to the top of the canvas, and then double-click to create the road. To make the curve more complex, click and drag the road centers (open circles), double-click the road to add more road centers, or double-click an entry in the **heading (°)** column of the **Road Centers** table to specify a heading angle as a constraint to a road center point.

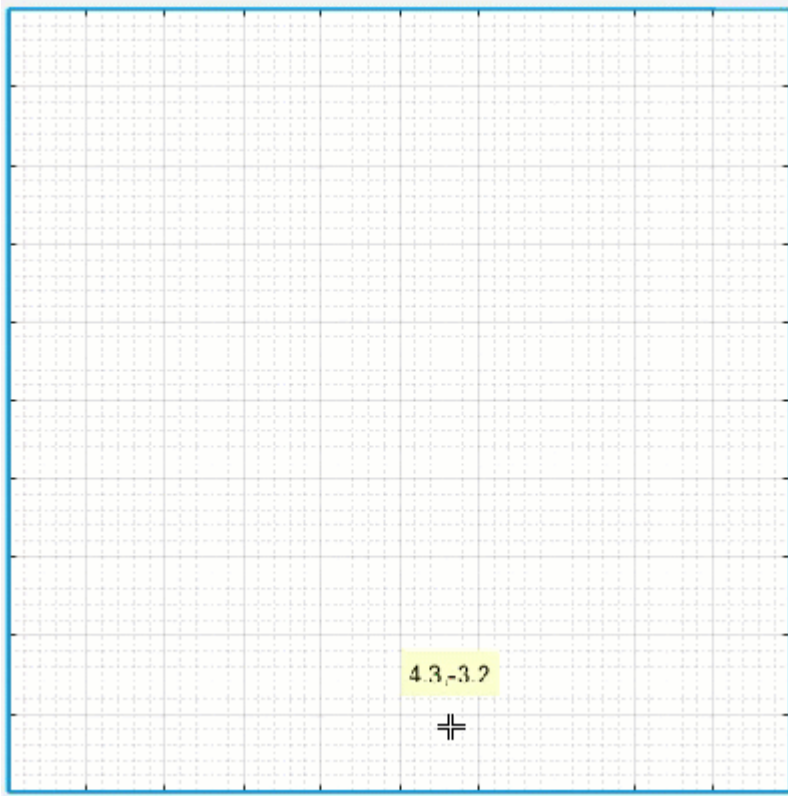

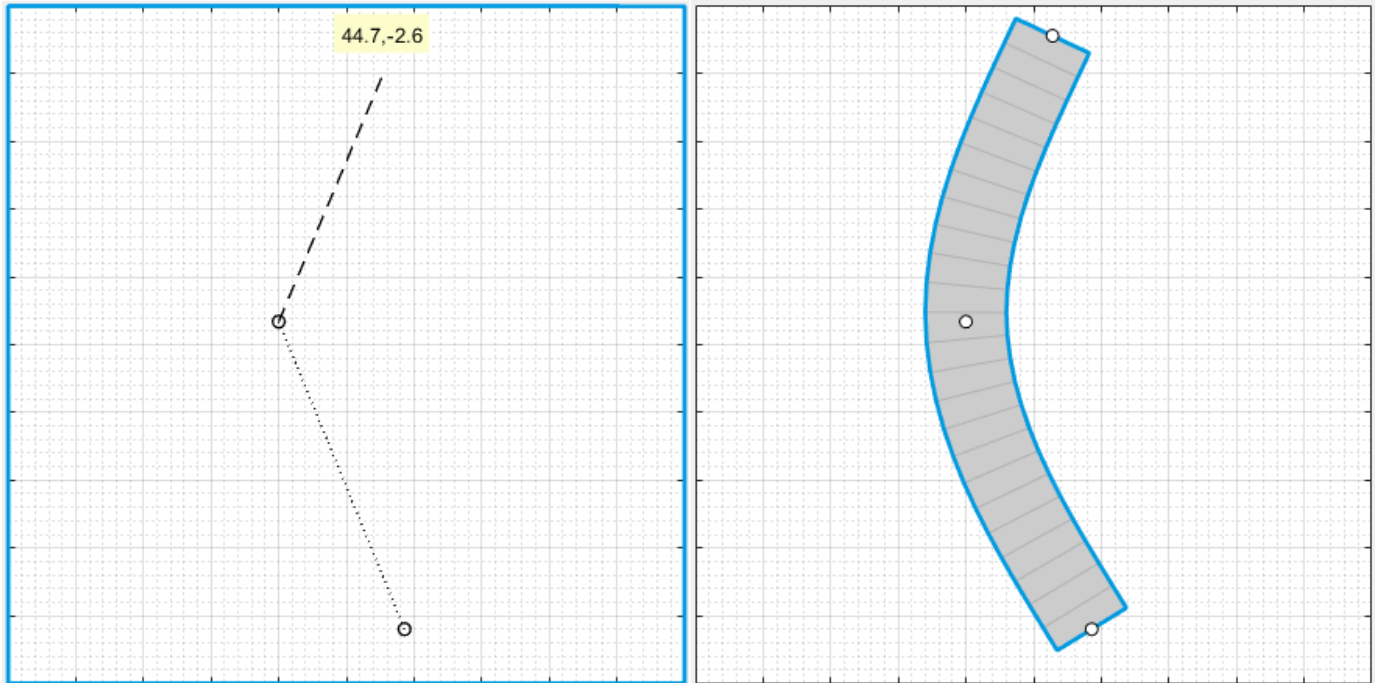

Add lanes to the road. In the left pane, on the **Roads** tab, expand the **Lanes** section. Set **Number of Lanes** to 2. By default, the road is one-way and has solid lane markings on either side to indicate the shoulder.

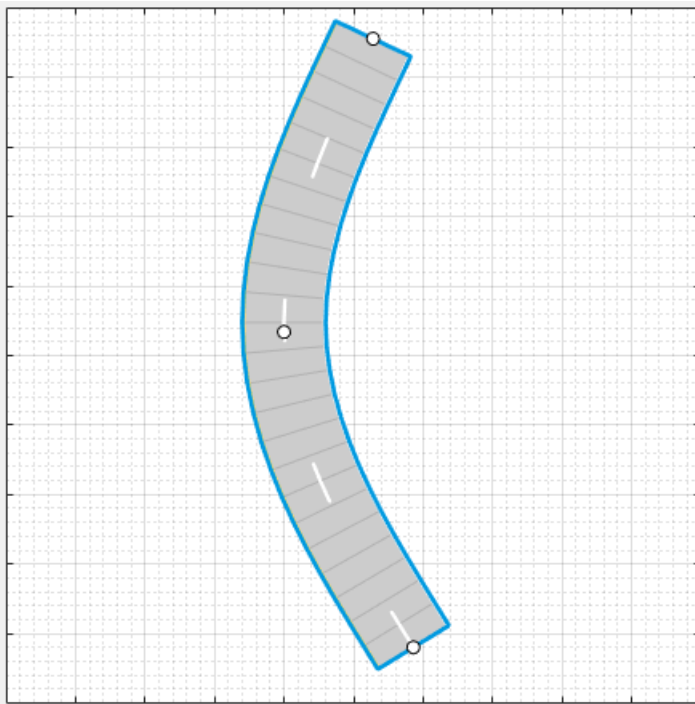

Add a vehicle at one end of the road. On the app toolstrip, select **Add Actor** > **Car**. Then click the road to set the initial position of the car.

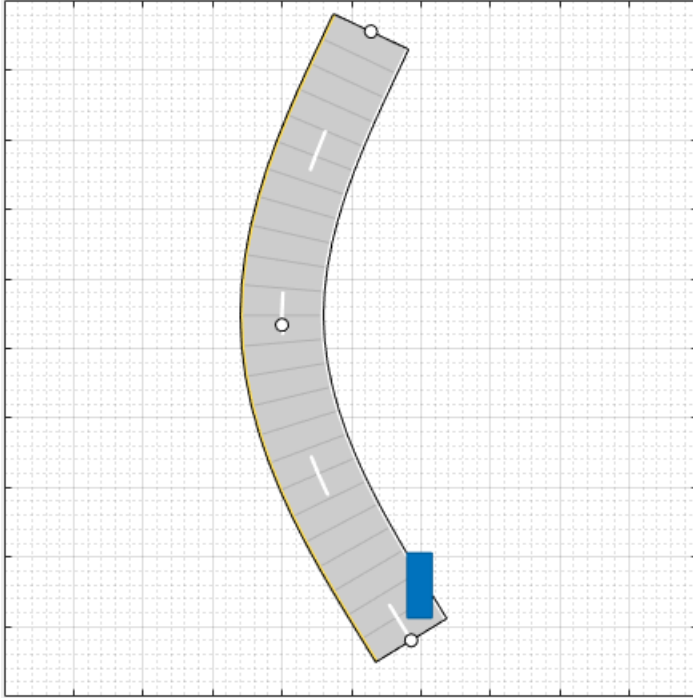

Set the driving trajectory of the car. Right-click the car, select **Add Forward Waypoints**, and add waypoints for the car to pass through. After you add the last waypoint, press **Enter**. The car autorotates in the direction of the first waypoint.

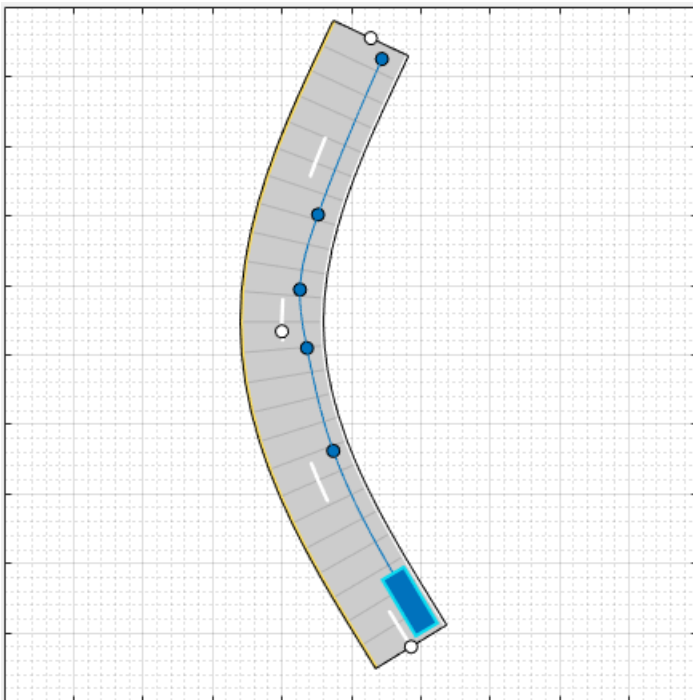

Adjust the speed of the car as it passes between waypoints. In the **Waypoints, Speeds, Wait Times, and Yaw** table in the left pane, set the velocity, v (m/s), of the ego vehicle as it enters each waypoint

segment. Increase the speed of the car for the straight segments and decrease its speed for the curved segments. For example, the trajectory has six waypoints, set the v (m/s) cells to 30, 20, 15, 15, 20, and 30.

v (m/s)
30
20
15
15
20
30

Run the scenario, and adjust settings as needed. Then click **Save > Roads & Actors** to save the road and car models to a MAT file.

Generate Sensor Data from Scenario

Generate lidar point cloud data from a prebuilt Euro NCAP driving scenario.

- For more details on prebuilt scenarios available from the app, see “Prebuilt Driving Scenarios in Driving Scenario Designer”.
- For more details on available Euro NCAP scenarios, see “Euro NCAP Driving Scenarios in Driving Scenario Designer”.

Load a Euro NCAP autonomous emergency braking (AEB) scenario of a collision with a pedestrian child. At collision time, the point of impact occurs 50% of the way across the width of the car.

```
path = fullfile(matlabroot, 'toolbox', 'shared', 'drivingscenario', ...
    'PrebuiltScenarios', 'EuroNCAP');
addpath(genpath(path)) % Add folder to path
drivingScenarioDesigner('AEB_PedestrianChild_Nearside_50width.mat')
rmpath(path) % Remove folder from path
```

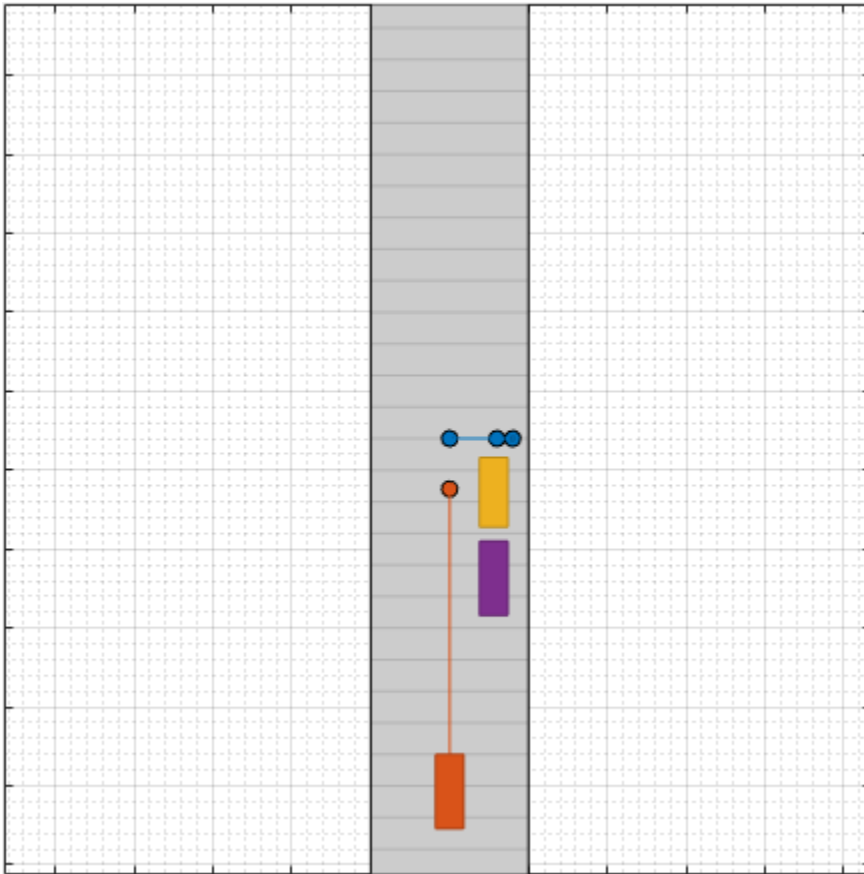

Add a lidar sensor to the ego vehicle. First click **Add Lidar**. Then, on the **Sensor Canvas**, click the predefined sensor location at the roof center of the car. The lidar sensor appears in black at the predefined location. The gray color that surrounds the car is the coverage area of the sensor.

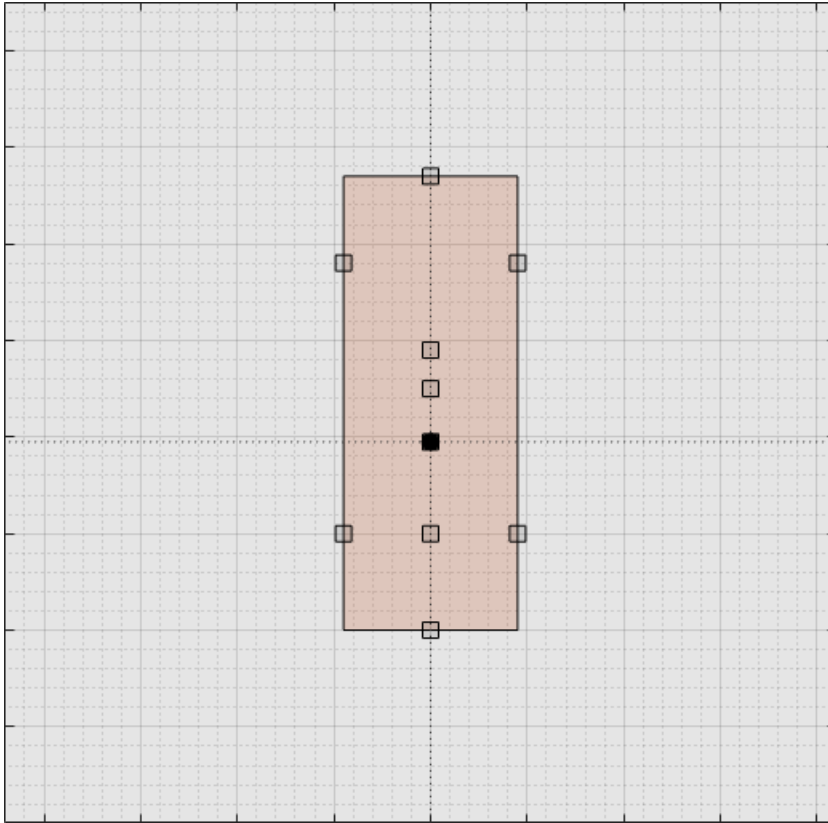

Run the scenario. Inspect different aspects of the scenario by toggling between canvases and views. You can toggle between the **Sensor Canvas** and **Scenario Canvas** and between the **Bird's-Eye Plot** and **Ego-Centric View**.

In the **Bird's-Eye Plot** and **Ego-Centric View**, the actors are displayed as meshes instead of as cuboids. To change the display settings, use the **Display** options on the app toolbar.

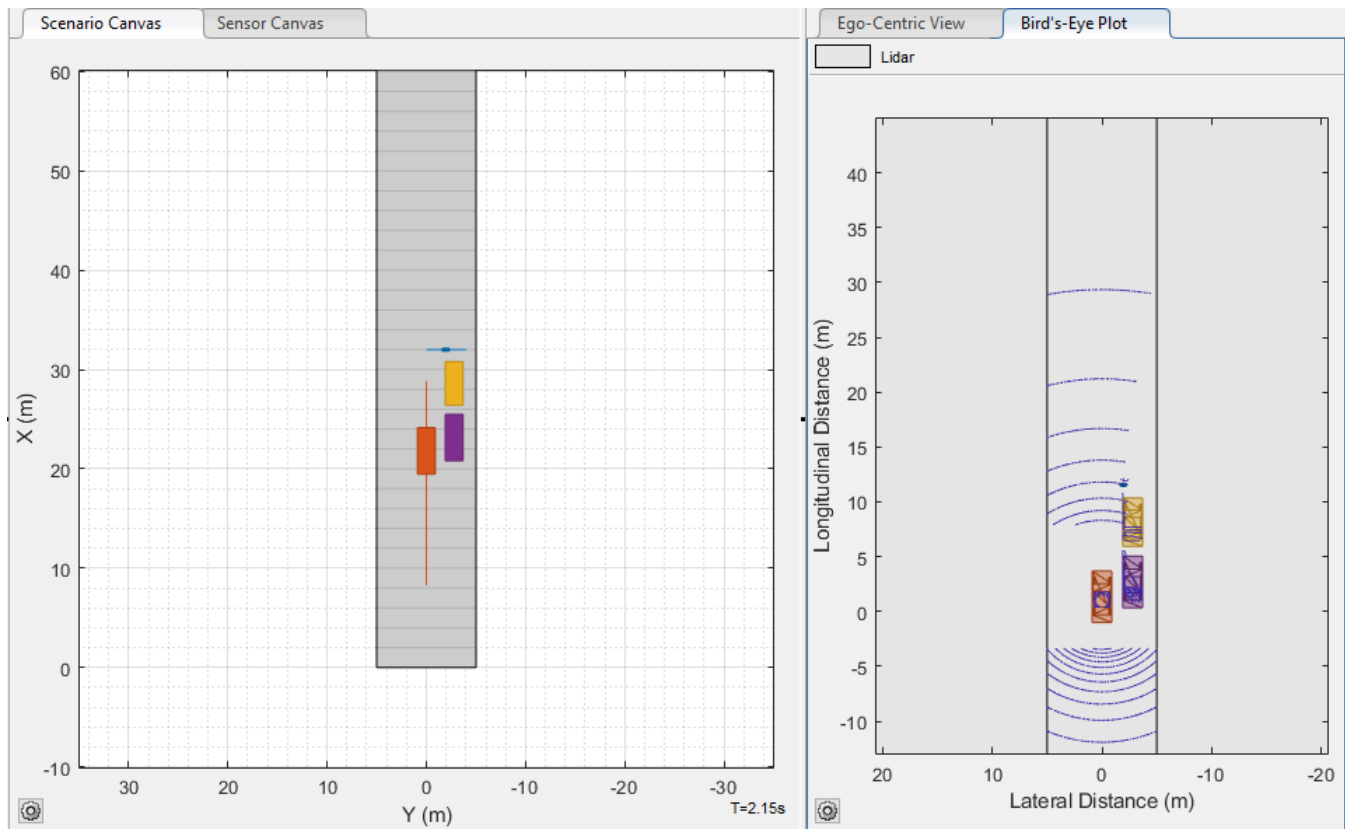

Export the sensor data to the MATLAB workspace. Click **Export** > **Export Sensor Data**, enter a workspace variable name, and click **OK**.

Import Programmatic Driving Scenario and Sensors

Programmatically create a driving scenario, radar sensor, and camera sensor. Then import the scenario and sensors into the app. For more details on working with programmatic driving scenarios and sensors, see “Create Driving Scenario Variations Programmatically”.

Create a simple driving scenario by using a `drivingScenario` object. In this scenario, the ego vehicle travels straight on a 50-meter road segment at a constant speed of 30 meters per second. For the ego vehicle, specify a `ClassID` property of 1. This value corresponds to the app **Class ID** of 1, which refers to actors of class `Car`. For more details on how the app defines classes, see the **Class** parameter description in the “Actors” on page 1-0 parameter tab.

```
scenario = drivingScenario;
roadCenters = [0 0 0; 50 0 0];
road(scenario,roadCenters);

egoVehicle = vehicle(scenario,'ClassID',1,'Position',[5 0 0]);
waypoints = [5 0 0; 45 0 0];
speed = 30;
smoothTrajectory(egoVehicle,waypoints,speed)
```

Create a radar sensor by using a `drivingRadarDataGenerator` object, and create a camera sensor by using a `visionDetectionGenerator` object. Place both sensors at the vehicle origin, with the radar facing forward and the camera facing backward.

```
radar = drivingRadarDataGenerator('MountingLocation',[0 0 0]);  
camera = visionDetectionGenerator('SensorLocation',[0 0],'Yaw',-180);
```

Import the scenario, front-facing radar sensor, and rear-facing camera sensor into the app.

```
drivingScenarioDesigner(scenario,{radar,camera})
```

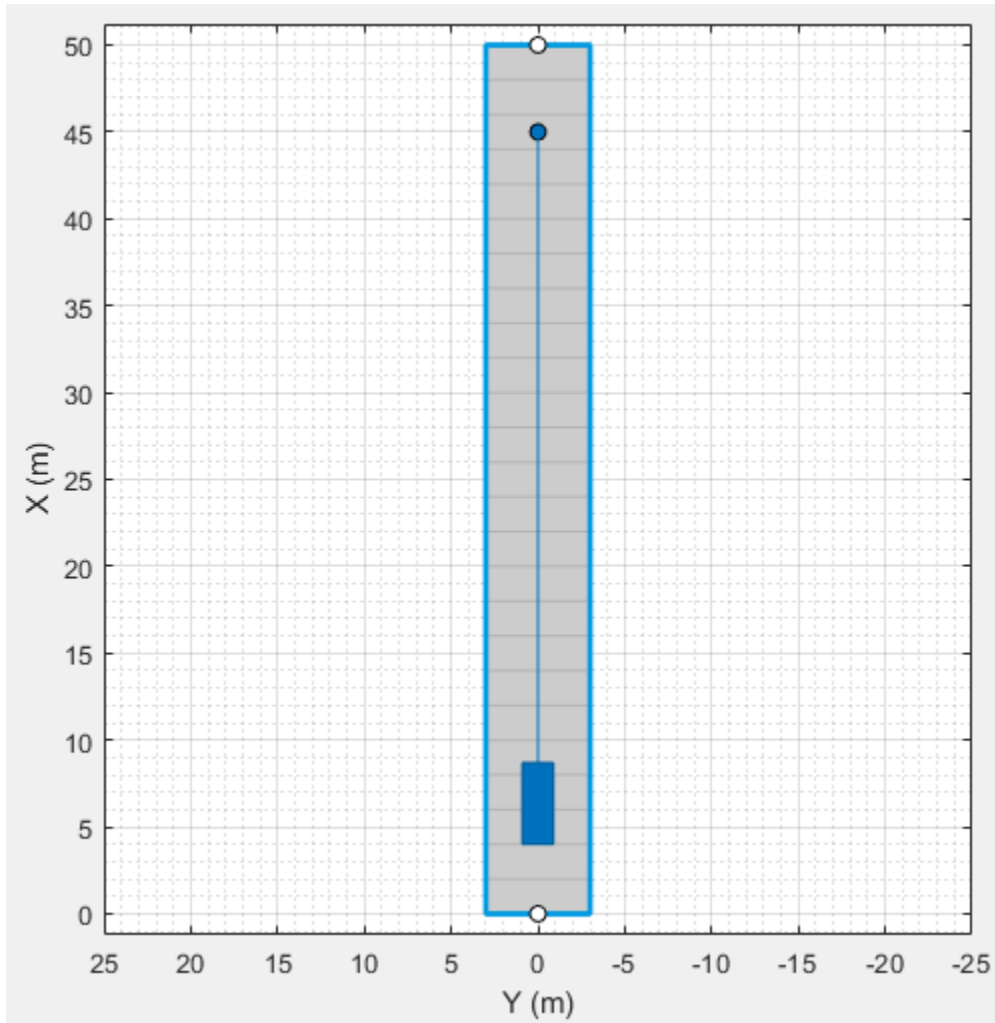

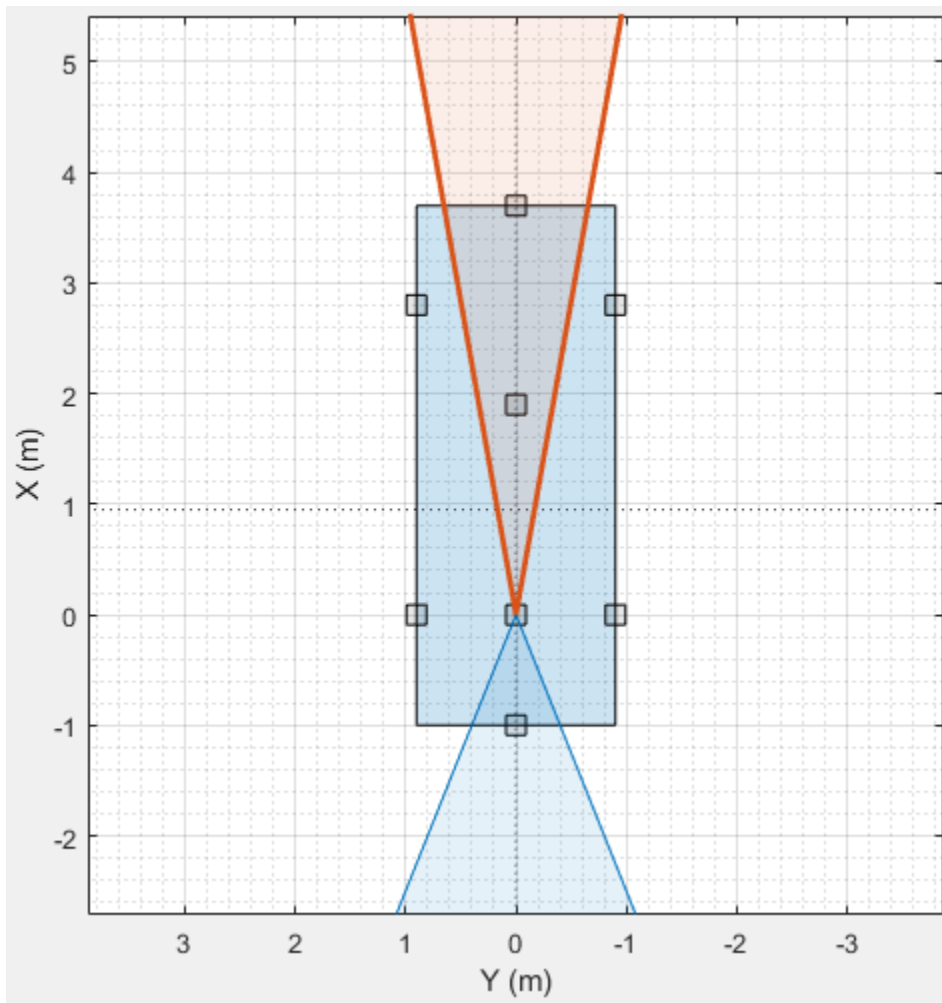

You can then run the scenario and modify the scenario and sensors. To generate new `drivingScenario`, `drivingRadarDataGenerator`, and `visionDetectionGenerator` objects, on the app toolstrip, select **Export** > **Export MATLAB Function**, and then run the generated function.

Generate Simulink Model of Scenario and Sensor

Load a driving scenario containing a sensor and generate a Simulink model from the scenario and sensor. For a more detailed example on generating Simulink models from the app, see “Generate Sensor Blocks Using Driving Scenario Designer”.

Load a prebuilt driving scenario into the app. The scenario contains two vehicles crossing through an intersection. The ego vehicle travels north and contains a camera sensor. This sensor is configured to detect both objects and lanes.

```
path = fullfile(matlabroot, 'toolbox', 'shared', 'drivingScenario', 'PrebuiltScenarios');
addpath(genpath(path)) % Add folder to path
drivingScenarioDesigner('EgoVehicleGoesStraight_VehicleFromLeftGoesStraight.mat')
rmpath(path) % Remove folder from path
```

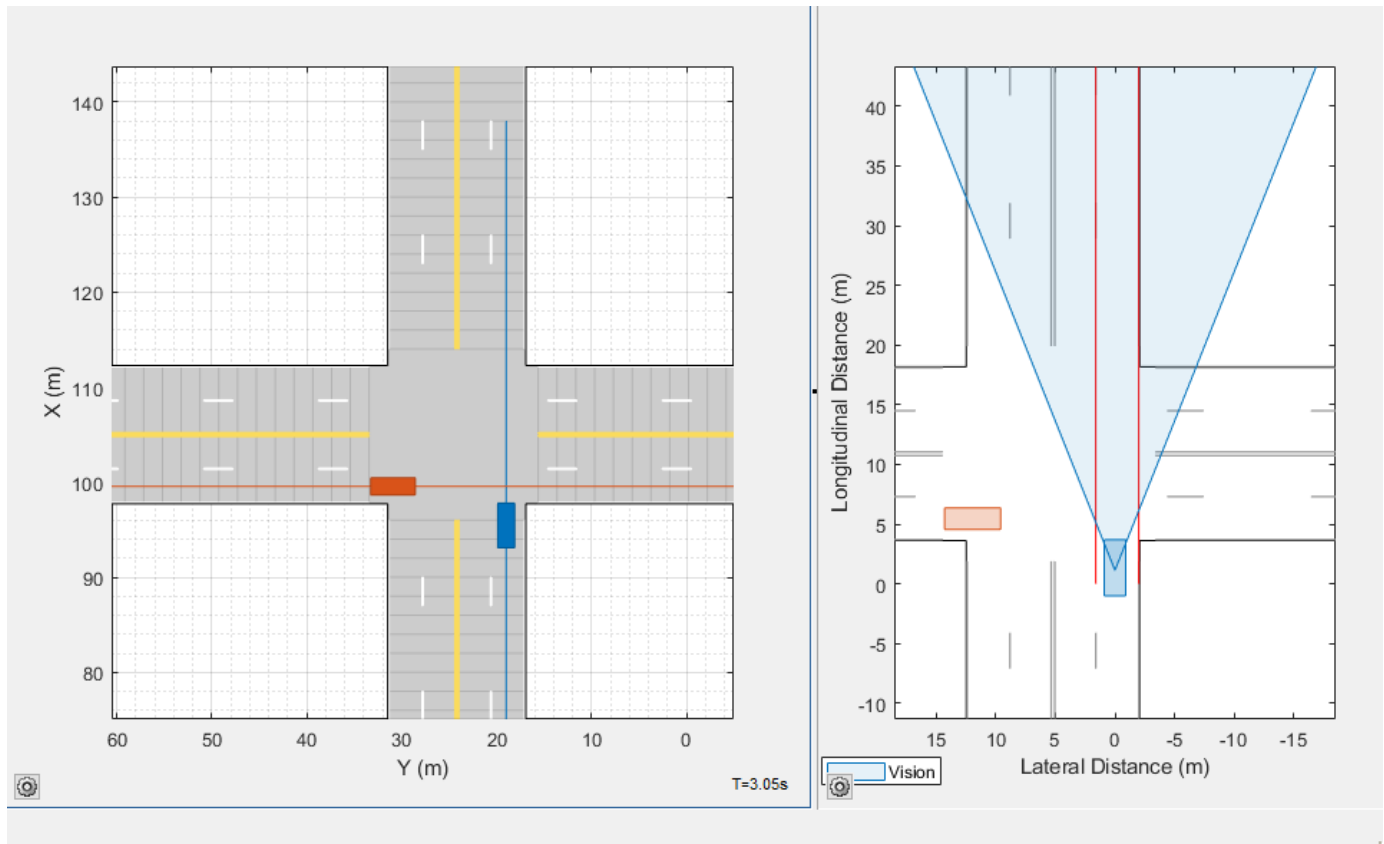

Generate a Simulink model of the scenario and sensor. On the app toolstrip, select **Export > Export Simulink Model**. If you are prompted, save the scenario file.

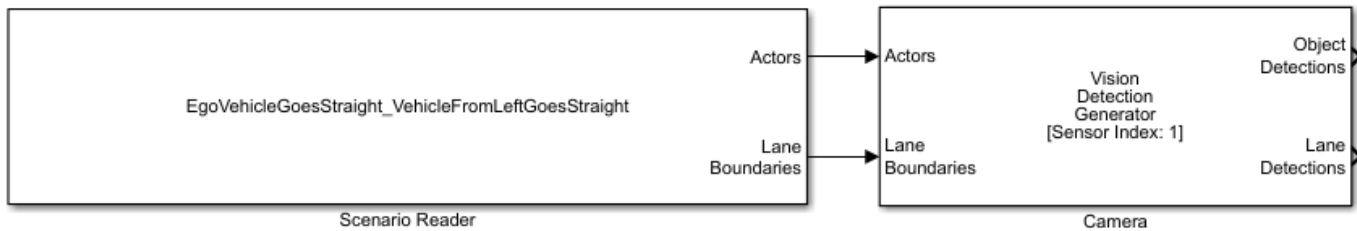

The Scenario Reader block reads the road and actors from the scenario file. To update the scenario data in the model, update the scenario in the app and save the file.

The Vision Detection Generator block recreates the camera sensor defined in the app. To update the sensor in the model, update the sensor in the app, select **Export > Export Sensor Simulink Model**, and copy the newly generated sensor block into the model. If you updated any roads or actors while updating the sensors, then select **Export > Export Simulink Model**. In this case, the Scenario Reader block accurately reads the actor profile data and passes it to the sensor.

Specify Vehicle Trajectories for 3D Simulation

Create a scenario with vehicle trajectories that you can later recreate in Simulink for simulation in a 3D environment.

Open one of the prebuilt scenarios that recreates a default scene available through the 3D environment. On the app toolstrip, select **Open > Prebuilt Scenario > Simulation3D** and select a scenario. For example, select the `DoubleLaneChange.mat` scenario.

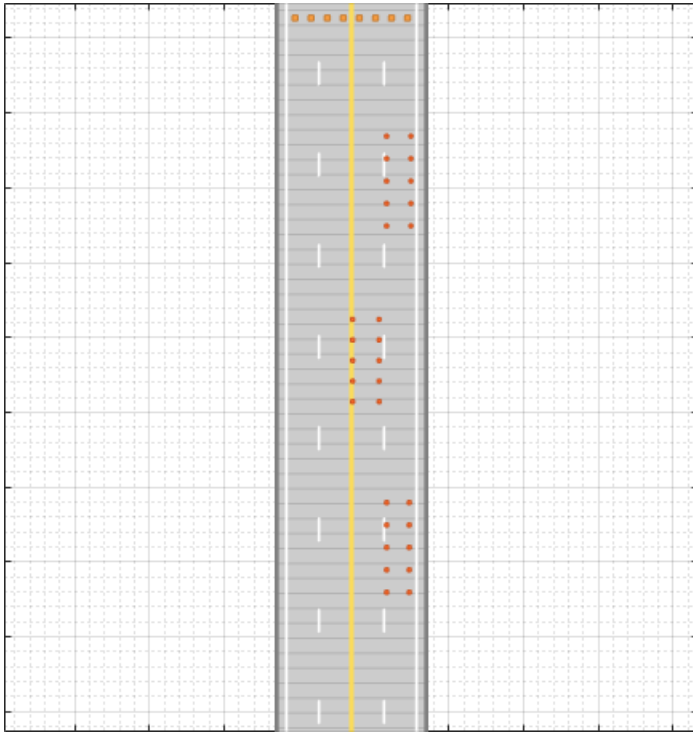

Specify a vehicle and its trajectory.

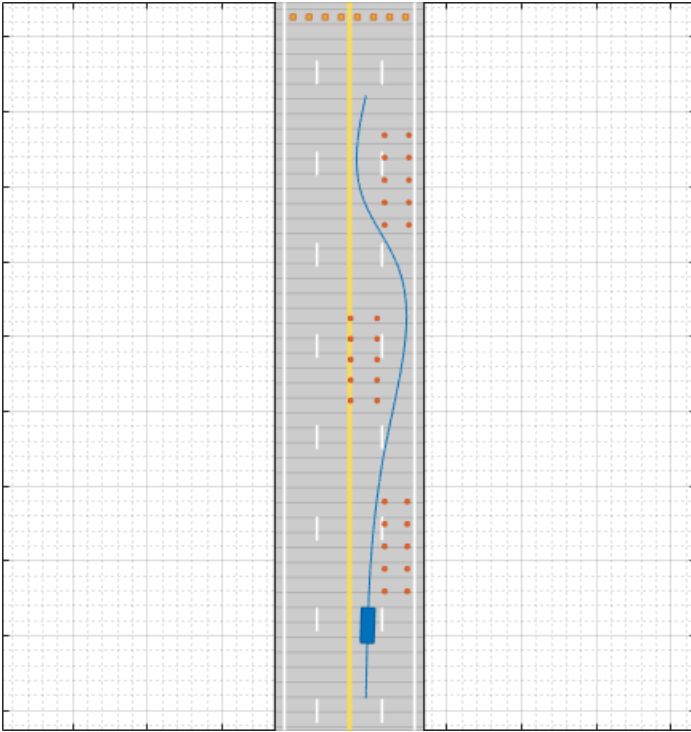

Update the dimensions of the vehicle to match the dimensions of the predefined vehicle types in the 3D simulation environment.

- 1 On the **Actors** tab, select the **3D Display Type** option you want.
- 2 On the app toolstrip, select **3D Display > Use 3D Simulation Actor Dimensions**. In the **Scenario Canvas**, the actor dimensions update to match the predefined dimensions of the actors in the 3D simulation environment.

Preview how the scenario will look when you later recreate it in Simulink. On the app toolstrip, select **3D Display > View Simulation in 3D Display**. After the 3D display window opens, click **Run**.

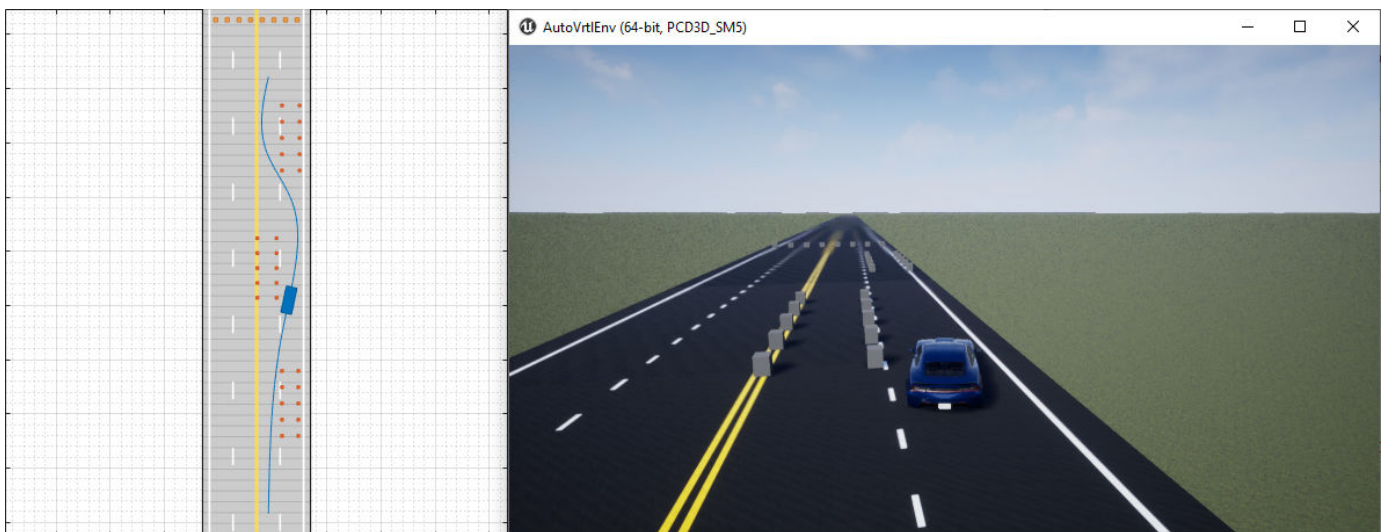

Modify the vehicle and trajectory as needed. Avoid changing the road network or the actors that were predefined in the scenario. Otherwise, the app scenario will not match the scenario that you later recreate in Simulink. If you change the scenario, the 3D display window closes.

When you are done modifying the scenario, you can recreate it in a Simulink model for use in the 3D simulation environment. For an example that shows how to set up such a model, see “Visualize Sensor Data from Unreal Engine Simulation Environment”.

- “Create Driving Scenario Interactively and Generate Synthetic Sensor Data”
- “Create Roads with Multiple Lane Specifications Using Driving Scenario Designer”
- “Generate INS Sensor Measurements from Interactive Driving Scenario”
- “Create Reverse Motion Driving Scenarios Interactively”
- “Import ASAM OpenDRIVE Roads into Driving Scenario”
- “Import HERE HD Live Map Roads into Driving Scenario”
- “Import OpenStreetMap Data into Driving Scenario”
- “Import Zenrin Japan Map API 3.0 (Itsumo NAVI API 3.0) into Driving Scenario”
- “Generate Sensor Blocks Using Driving Scenario Designer”

Parameters

Roads — Road width, bank angle, heading angle, lane specifications, and road center locations
tab

To enable the **Roads** parameters, add at least one road to the scenario. Then, select a road from either the **Scenario Canvas** or the **Road** parameter. The parameter values in the **Roads** tab are based on the road you select.

Parameter	Description
Road	Road to modify, specified as a list of the roads in the scenario.
Name	Name of the road. The name of an imported road depends on the map service. For example, when you generate a road using OpenStreetMap data, the app uses the name of the road when it is available. Otherwise, the app uses the road ID specified by the OpenStreetMap data.
Width (m)	Width of the road, in meters, specified as a decimal scalar in the range (0, 50]. If the curvature of the road is too sharp to accommodate the specified road width, the app does not generate the road. Default: 6

Parameter	Description
Number of Road Segments	<p>Number of road segments, specified as a positive integer. Use this parameter to enable composite lane specification by dividing the road into road segments. Each road segment represents a part of the road with a distinct lane specification. Lane specifications differ from one road segment to another. For more information on composite lane specifications, see “Composite Lane Specification” on page 1-86.</p> <p>Default: 1</p>
Segment Range	<p>Normalized range for each road segment, specified as a row vector of values in the range (0, 1). The length of the vector must be equal to the Number of Road Segments parameter value. The sum of the vector must be equal to 1.</p> <p>By default, the range of each road segment is the inverse of the number of road segments.</p> <p>Dependencies</p> <p>To enable this parameter, specify a Number of Road Segments parameter value greater than 1.</p>
Road Segment	<p>Select a road segment from the list to specify its Lanes parameters.</p> <p>Dependencies</p> <p>To enable this parameter, specify a Number of Road Segments parameter value greater than 1.</p>

Lanes — Lane specifications, such as lane types and lane markings
tab section

Use these parameters to specify lane information, such as lane types and lane markings. When the value of the **Number of Road Segments** parameter is greater than 1, these parameters apply to the selected road segment.

Parameter	Description
Number of Lanes	<p>Number of lanes in the road, specified as one of these values:</p> <ul style="list-style-type: none"> • Integer, M, in the range $[1, 30]$ — Creates an M-lane road whose default lane markings indicate that the road is one-way. • Two-element vector, $[M N]$, where M and N are positive integers whose sum must be in the range $[2, 30]$ — Creates a road with $(M + N)$ lanes. The default lane markings of this road indicate that it is two-way. The first M lanes travel in one direction. The next N lanes travel in the opposite direction. <p>If you increase the number of lanes, the added lanes are of the width specified in the Lane Width (m) parameter. If Lane Width (m) is a vector of differing lane widths, then the added lanes are of the width specified in the last vector element.</p>
Lane Width (m)	<p>Width of each lane in the road, in meters, specified as one of these values:</p> <ul style="list-style-type: none"> • Decimal scalar in the range $(0, 50]$ — The same width applies to all lanes. • N-element vector of decimal values in the range $(0, 50]$ — A different width applies to each lane, where N is the total number of lanes specified in the Number of lanes parameter. <p>The width of each lane must be greater than the width of the lane markings it contains. These lane markings are specified by the Marking > Width (m) parameter.</p>
Lane Types	<p>Lanes in the road, specified as a list of the lane types in the selected road. To modify one or more lane parameters that include lane type, color, and strength, select the desired lane from the drop-down list.</p>

Parameter	Description												
<p>Lane Types > Type</p>	<p>Type of lane, specified as one of these values:</p> <ul style="list-style-type: none"> 'Driving' — Lanes for driving. 'Border' — Lanes at the road borders. 'Restricted' — Lanes reserved for high occupancy vehicles. 'Shoulder' — Lanes reserved for emergency stopping. 'Parking' — Lanes alongside driving lanes, intended for parking vehicles. <p>Default: 'Driving'</p>												
<p>Lane Types > Color</p>	<p>Color of lane, specified as an RGB triplet with default values as:</p> <table border="1" data-bbox="865 810 1474 1104"> <thead> <tr> <th>Type</th> <th>Color (Default values)</th> </tr> </thead> <tbody> <tr> <td>'Driving'</td> <td>[0.8 0.8 0.8]</td> </tr> <tr> <td>'Border'</td> <td>[0.72 0.72 0.72]</td> </tr> <tr> <td>'Restricted'</td> <td>[0.59 0.56 0.62]</td> </tr> <tr> <td>'Shoulder'</td> <td>[0.59 0.59 0.59]</td> </tr> <tr> <td>'Parking'</td> <td>[0.28 0.28 0.28]</td> </tr> </tbody> </table> <p>Alternatively, you can also specify some common colors as an RGB triplet, hexadecimal color code, color name, or short color name. For more information, see “Color Specifications for Lanes and Markings” on page 1-82.</p>	Type	Color (Default values)	'Driving'	[0.8 0.8 0.8]	'Border'	[0.72 0.72 0.72]	'Restricted'	[0.59 0.56 0.62]	'Shoulder'	[0.59 0.59 0.59]	'Parking'	[0.28 0.28 0.28]
Type	Color (Default values)												
'Driving'	[0.8 0.8 0.8]												
'Border'	[0.72 0.72 0.72]												
'Restricted'	[0.59 0.56 0.62]												
'Shoulder'	[0.59 0.59 0.59]												
'Parking'	[0.28 0.28 0.28]												
<p>Lane Types > Strength</p>	<p>Saturation strength of lane color, specified as a decimal scalar in the range [0, 1].</p> <ul style="list-style-type: none"> A value of 0 specifies that the lane color is fully unsaturated, resulting in a gray colored lane. A value of 1 specifies that the lane color is fully saturated, resulting in a true colored lane. <p>Default: 1</p>												
<p>Lane Markings</p>	<p>Lane markings, specified as a list of the lane markings in the selected road. To modify one or more lane marking parameters which include marking type, color, and strength, select the desired lane marking from the drop-down list.</p> <p>A road with N lanes has $(N + 1)$ lane markings.</p>												

Parameter	Description
Lane Markings > Specify multiple marker types along a lane	<p>Select this parameter to define composite lane markings. A composite lane marking comprises multiple marker types along a lane. The portion of the lane marking that contains each marker type is referred as a marker segment. For more information on composite lane markings, see Composite Lane Marking on page 1-85.</p>
Lane Markings > Number of Marker Segments	<p>Number of marker segments in a composite lane marking, specified as an integer greater than or equal to 2. A composite lane marking must have at least two marker segments. The app supports a maximum of 10 marker segments for every 1 meter of road length. For example, when you specify composite lane marking for a 10-meter road segment, the number of marker segments must be less than or equal to 100.</p> <p>Default: 2</p> <p>Dependencies</p> <p>To enable this parameter, select the Specify multiple marker types along a lane parameter.</p>
Lane Markings > Segment Range	<p>Normalized range for each marker segment in a composite lane marking, specified as a row vector of values in the range [0, 1]. The length of the vector must be equal to the Number of Marker Segments parameter value.</p> <p>Default: [0.5 0.5]</p> <p>Dependencies</p> <p>To enable this parameter, select the Specify multiple marker types along a lane parameter.</p>
Lane Markings > Marker Segment	<p>Marker segments, specified as a list of marker types in the selected lane marking. To modify one or more marker segment parameters that include marking type, color, and strength, select the desired marker segment from the drop-down list.</p> <p>Dependencies</p> <p>To enable this parameter, select the Specify multiple marker types along a lane parameter.</p>

Parameter	Description
Lane Markings > Type	<p>Type of lane marking, specified as one of these values:</p> <ul style="list-style-type: none"> • Unmarked — No lane marking • Solid — Solid line • Dashed — Dashed line • DoubleSolid — Two solid lines • DoubleDashed — Two dashed lines • SolidDashed — Solid line on left, dashed line on right • DashedSolid — Dashed line on left, solid line on right <p>By default, for a one-way road, the leftmost lane marking is a solid yellow line, the rightmost lane marking is a solid white line, and the markings for the inner lanes are dashed white lines. For two-way roads, the default outermost lane markings are both solid white lines and the dividing lane marking is two solid yellow lines.</p> <p>If you enable the Specify multiple marker types along a lane parameter, then this value is applied to the selected marker segment in a composite lane marking.</p>
Lane Markings > Color	<p>Color of lane marking, specified as an RGB triplet, hexadecimal color code, color name, or short color name. For a lane marker specifying a double line, the same color is used for both lines.</p> <p>You can also specify some common colors as an RGB triplet, hexadecimal color code, color name, or short color name. For more information, see “Color Specifications for Lanes and Markings” on page 1-82.</p> <p>If you enable the Specify multiple marker types along a lane parameter, then this value is applied to the selected marker segment in a composite lane marking.</p>

Parameter	Description
Lane Markings > Strength	<p>Saturation strength of lane marking color, specified as a decimal scalar in the range [0, 1].</p> <ul style="list-style-type: none"> • A value of 0 specifies that the lane marking color is fully unsaturated, resulting in a gray colored lane marking. • A value of 1 specifies that the lane marking color is fully saturated, resulting in a true colored lane marking. <p>For a lane marker specifying a double line, the same strength is used for both lines.</p> <p>Default: 1</p> <p>If you enable the Specify multiple marker types along a lane parameter, then this value is applied to the selected marker segment in a composite lane marking.</p>
Lane Markings > Width (m)	<p>Width of lane marking, in meters, specified as a positive decimal scalar.</p> <p>The width of the lane marking must be less than the width of its enclosing lane. The enclosing lane is the lane directly to the left of the lane marking.</p> <p>For a lane marker specifying a double line, the same width is used for both lines.</p> <p>Default: 0.15</p> <p>If you enable the Specify multiple marker types along a lane parameter, then this value is applied to the selected marker segment in a composite lane marking.</p>
Lane Markings > Length (m)	<p>Length of dashes in dashed lane markings, in meters, specified as a decimal scalar in the range (0, 50].</p> <p>For a lane marker specifying a double line, the same length is used for both lines.</p> <p>Default: 3</p> <p>If you enable the Specify multiple marker types along a lane parameter, then this value is applied to the selected marker segment in a composite lane marking.</p>

Parameter	Description
Lane Markings > Space (m)	<p>Length of spaces between dashes in dashed lane markings, in meters, specified as a decimal scalar in the range (0, 150].</p> <p>For a lane marker specifying a double line, the same space is used for both lines.</p> <p>Default: 9</p> <p>If you enable the Specify multiple marker types along a lane parameter, then this value is applied to the selected marker segment in a composite lane marking.</p>

Segment Taper — Specifications of taper between two road segments
tab section

To enable the **Segment Taper** parameters, specify a **Number of Road Segments** parameter value greater than 1, and specify a distinct value for either the **Number of Lanes** or **Lane Width (m)** parameter of at least one road segment. Then, select a taper from the drop-down list to specify taper parameters.

A road with N road segments has $(N - 1)$ segment tapers. The L^{th} taper, where $L < N$, is part of the L^{th} road segment.

Parameter	Description
Shape	<p>Taper shape of the road segment, specified as either Linear or None.</p> <p>Default: None</p>
Length (m)	<p>Taper length of the road segment, specified as a positive scalar. Units are in meters.</p> <p>The default taper length is the smaller of 241 meters or 75 percent of length of the road segment containing the taper.</p> <p>The specified taper length must be less than the length of the corresponding road segment. Otherwise, the app resets it to a value that is 75 percent of the length of the corresponding road segment.</p> <p>Dependencies</p> <p>To enable this parameter, set the Shape parameter to Linear.</p>

Parameter	Description
Position	<p>Edge of the road segment from which to add or drop lanes, specified as one of these values:</p> <ul style="list-style-type: none"> • Right — Add or drop lanes from the right edge of the road segment. • Left — Add or drop lanes from the left edge of the road segment. • Both — Add or drop lanes from both edges of the road segment. <p>You can specify the value of this parameter for connecting two one-way road segments. When connecting two-way road segments to each other, or one-way road segments to two-way road segments, the app determines the value of this parameter based on the specified Number of Lanes parameter.</p> <p>To add or drop lanes from both edges of a one-way road segment, the number of lanes in the one-way road segments must differ by an even number.</p> <p>Default: Right</p> <p>Dependencies</p> <p>To enable this parameter, specify different integer scalars for the Number of Lanes parameters of different road segments.</p>

Road Centers — Road center locations
tab section

Use these parameters to specify the orientation of the road.

Parameter	Description
Bank Angle (deg)	<p>Side-to-side incline of the road, in degrees, specified as one of these values:</p> <ul style="list-style-type: none"> • Decimal scalar — Applies a uniform bank angle along the entire length of the road • N-element vector of decimal values — Applies a different bank angle to each road center, where N is the number of road centers in the selected road <p>When you add an actor to a road, you do not have to change the actor position to match the bank angles specified by this parameter. The actor automatically follows the bank angles of the road.</p> <p>Default: 0</p>

Each row of the **Road Centers** table contains the x -, y -, and z -positions, as well as the heading angle, of a road center within the selected road. All roads must have at least two unique road center positions. When you update a cell within the table, the **Scenario Canvas** updates to reflect the new road center position. The orientation of the road depends on the values of the road centers and the heading angles. The road centers specify the direction in which the road renders in the **Scenario Canvas**. For more information, see Draw Direction of Road and Numbering of Lanes on page 1-82.

Parameter	Description
x (m)	x -axis position of the road center, in meters, specified as a decimal scalar.
y (m)	y -axis position of the road center, in meters, specified as a decimal scalar.

Parameter	Description
z (m)	<p>z-axis position of the road center, in meters, specified as a decimal scalar.</p> <ul style="list-style-type: none"> The z-axis specifies the elevation of the road. If the elevation between road centers is too abrupt, adjust these elevation values. When you add an actor to a road, you do not have to change the actor position to match changes in elevation. The actor automatically follows the elevation of the road. When two elevated roads form a junction, the elevation around that junction can vary widely. The exact amount of elevation depends on how close the road centers of each road are to each other. If you try to place an actor at the junction, the app might be unable to compute the precise elevation of the actor. In this case, the app cannot place the actor at that junction. <p>To address this issue, in the Scenario Canvas, modify the intersecting roads by moving the road centers of each road away from each other. Alternatively, manually adjust the elevation of the actor to match the elevation of the road surface.</p> <p>Default: 0</p>
heading (°)	<p>Heading angle of the road about its x-axis at the road center, in degrees, specified as a decimal scalar.</p> <p>When you specify a heading angle, it acts as a constraint on that road center point and the app automatically determines the other heading angles. Specifying heading angles enables finer control over the shape and orientation of the road in the Scenario Canvas. For more information, see “Heading Angle” on page 4-546.</p> <p>When you export the driving scenario to a MATLAB function and run that function, MATLAB wraps the heading angles of the road in the output scenario, to the range [-180, 180].</p>

Road Group Centers — Intersection center locations tab section

Each row of the **Road Group Centers** table contains the x-, y-, and z-positions of a center within the selected intersection of an imported road network. These center location parameters are read-only

parameters since intersections cannot be created interactively. Use the `roadGroup` function to add an intersection to the scenario programmatically.

Parameter	Description
x (m)	x-axis position of the intersection center, in meters, specified as a decimal scalar.
y (m)	y-axis position of the intersection center, in meters, specified as a decimal scalar.
z (m)	<p>z-axis position of the road center, in meters, specified as a decimal scalar.</p> <ul style="list-style-type: none"> The z-axis specifies the elevation of the intersection. When you try to place an actor at the intersection formed by elevated roads, the app might be unable to compute the precise elevation of the actor. Manually adjust the elevation of the actor to match the elevation of the intersection surface. <p>Dependencies</p> <p>To enable this parameter, select the intersection from the Scenario Canvas. The app enables this parameter for these cases only:</p> <ul style="list-style-type: none"> You load a scenario that contains an intersection defined using the <code>roadGroup</code> function. You import a HERE HD Live Map road network containing an intersection.

Actors — Actor positions, orientations, RCS patterns, and trajectories
tab

To enable the **Actors** parameters, add at least one actor to the scenario. Then, select an actor from either the **Scenario Canvas** or from the list on the **Actors** tab. The parameter values in the **Actors** tab are based on the actor you select. If you select multiple actors, then many of these parameters are disabled.

Parameter	Description
<p>Color</p>	<p>To change the color of an actor, next to the actor selection list, click the color patch for that actor.</p>  <p>Then, use the color picker to select one of the standard colors commonly used in MATLAB graphics. Alternatively, select a custom color from the Custom Colors tab by first clicking  in the upper-right corner of the Color dialog box. You can then select custom colors from a gradient or specify a color using an RGB triplet, hexadecimal color code, or HSV triplet.</p> <p>By default, the app sets each newly created actor to a new color. This color order is based on the default color order of Axes objects. For more details, see the <code>ColorOrder</code> property for Axes objects.</p> <p>To set a single default color for all newly created actors of a specific class, on the app toolbar, select Add Actor > Edit Actor Classes. Then, select Set Default Color and click the corresponding color patch to set the color. To select a default color for a class, the Scenario Canvas must contain no actors of that class.</p> <p>Color changes made in the app are carried forward into Bird's-Eye Scope visualizations.</p>
<p>Set as Ego Vehicle</p>	<p>Set the selected actor as the ego vehicle in the scenario.</p> <p>When you add sensors to your scenario, the app adds them to the ego vehicle. In addition, the Ego-Centric View and Bird's-Eye Plot windows display simulations from the perspective of the ego vehicle.</p> <p>Only actors who have vehicle classes, such as <code>Car</code> or <code>Truck</code>, can be set as the ego vehicle. The ego vehicle must also have a 3D Display Type parameter value other than <code>Cuboid</code>.</p> <p>For more details on actor classes, see the Class parameter description.</p>
<p>Name</p>	<p>Name of actor.</p>

Parameter	Description														
<p>Class</p>	<p>Class of actor, specified as the list of classes to which you can change the selected actor.</p> <p>You can change the class of vehicle actors only to other vehicle classes. The default vehicle classes are Car and Truck. Similarly, you can change the class of nonvehicle actors only to other nonvehicle classes. The default nonvehicle classes are Pedestrian, Bicycle, Jersey Barrier, and Guardrail.</p> <p>The list of vehicle and nonvehicle classes appear in the app toolstrip, in the Add Actor > Vehicles and Add Actor > Other or Add Actor > Barriers sections, respectively.</p> <p>Actors created in the app have default sets of dimensions, radar cross-section patterns, and other properties based on their Class ID value. The table shows the default Class ID values and actor classes.</p> <table border="1" data-bbox="678 846 1474 1150"> <thead> <tr> <th data-bbox="678 846 1075 888">Class ID</th> <th data-bbox="1075 846 1474 888">Actor Class</th> </tr> </thead> <tbody> <tr> <td data-bbox="678 888 1075 930">1</td> <td data-bbox="1075 888 1474 930">Car</td> </tr> <tr> <td data-bbox="678 930 1075 972">2</td> <td data-bbox="1075 930 1474 972">Truck</td> </tr> <tr> <td data-bbox="678 972 1075 1014">3</td> <td data-bbox="1075 972 1474 1014">Bicycle</td> </tr> <tr> <td data-bbox="678 1014 1075 1056">4</td> <td data-bbox="1075 1014 1474 1056">Pedestrian</td> </tr> <tr> <td data-bbox="678 1056 1075 1098">5</td> <td data-bbox="1075 1056 1474 1098">Jersey Barrier</td> </tr> <tr> <td data-bbox="678 1098 1075 1140">6</td> <td data-bbox="1075 1098 1474 1140">Guardrail</td> </tr> </tbody> </table> <p>To modify actor classes or create new actor classes, on the app toolstrip, select Add Actor > Edit Actor Classes or Add Actor > New Actor Class, respectively.</p>	Class ID	Actor Class	1	Car	2	Truck	3	Bicycle	4	Pedestrian	5	Jersey Barrier	6	Guardrail
Class ID	Actor Class														
1	Car														
2	Truck														
3	Bicycle														
4	Pedestrian														
5	Jersey Barrier														
6	Guardrail														

Parameter	Description																	
3D Display Type	<p>Display type of actor as it appears in the 3D display window, specified as the list of display types to which you can change the selected actor.</p> <p>To display the scenario in the 3D display window during simulation, on the app toolstrip, click 3D Display > View Simulation in 3D Display. The app renders this display by using the Unreal Engine® from Epic Games®.</p> <p>For any actor, the available 3D Display Type options depend on the actor class specified in the Class parameter.</p>																	
	<table border="1"> <thead> <tr> <th data-bbox="678 653 1073 688">Actor Class</th> <th data-bbox="1073 653 1466 688">3D Display Type Options</th> </tr> </thead> <tbody> <tr> <td data-bbox="678 688 1073 730">Car</td> <td data-bbox="1073 688 1466 772"> <ul style="list-style-type: none"> Sedan (default for Car class) </td> </tr> <tr> <td data-bbox="678 730 1073 772">Truck</td> <td data-bbox="1073 772 1466 814"> <ul style="list-style-type: none"> Muscle Car </td> </tr> <tr> <td data-bbox="678 772 1073 1213"> Custom vehicle class To create a custom vehicle class: <ol style="list-style-type: none"> On the app toolstrip, select Add Actor > New Actor Class. In the Class Editor window, select the Vehicle parameter. Set other class properties as needed and click OK. </td> <td data-bbox="1073 814 1466 1213"> <ul style="list-style-type: none"> SUV Small Pickup Truck Hatchback Box Truck (default for Truck class) Cuboid (default for custom vehicle classes) </td> </tr> <tr> <td data-bbox="678 1213 1073 1255">Bicycle</td> <td data-bbox="1073 1213 1466 1297"> <ul style="list-style-type: none"> Bicyclist (default for Bicycle class) </td> </tr> <tr> <td data-bbox="678 1255 1073 1297">Pedestrian</td> <td data-bbox="1073 1297 1466 1381"> <ul style="list-style-type: none"> Male Pedestrian (default for Pedestrian class) </td> </tr> <tr> <td data-bbox="678 1297 1073 1339">Jersey Barrier</td> <td data-bbox="1073 1381 1466 1423"> <ul style="list-style-type: none"> Female Pedestrian </td> </tr> <tr> <td data-bbox="678 1339 1073 1381">Guardrail</td> <td data-bbox="1073 1423 1466 1465"> <ul style="list-style-type: none"> Barrier (default for Jersey Barrier class) </td> </tr> <tr> <td data-bbox="678 1381 1073 1816"> Custom nonvehicle class To create a custom nonvehicle class: <ol style="list-style-type: none"> On the app toolstrip, select Add Actor > New Actor Class. In the Class Editor window, clear the Vehicle parameter. Set other class properties as needed and click OK. </td> <td data-bbox="1073 1465 1466 1816"> <ul style="list-style-type: none"> Cuboid (default for Guardrail class and custom nonvehicle classes) </td> </tr> </tbody> </table>	Actor Class	3D Display Type Options	Car	<ul style="list-style-type: none"> Sedan (default for Car class) 	Truck	<ul style="list-style-type: none"> Muscle Car 	Custom vehicle class To create a custom vehicle class: <ol style="list-style-type: none"> On the app toolstrip, select Add Actor > New Actor Class. In the Class Editor window, select the Vehicle parameter. Set other class properties as needed and click OK. 	<ul style="list-style-type: none"> SUV Small Pickup Truck Hatchback Box Truck (default for Truck class) Cuboid (default for custom vehicle classes) 	Bicycle	<ul style="list-style-type: none"> Bicyclist (default for Bicycle class) 	Pedestrian	<ul style="list-style-type: none"> Male Pedestrian (default for Pedestrian class) 	Jersey Barrier	<ul style="list-style-type: none"> Female Pedestrian 	Guardrail	<ul style="list-style-type: none"> Barrier (default for Jersey Barrier class) 	Custom nonvehicle class To create a custom nonvehicle class: <ol style="list-style-type: none"> On the app toolstrip, select Add Actor > New Actor Class. In the Class Editor window, clear the Vehicle parameter. Set other class properties as needed and click OK.
Actor Class	3D Display Type Options																	
Car	<ul style="list-style-type: none"> Sedan (default for Car class) 																	
Truck	<ul style="list-style-type: none"> Muscle Car 																	
Custom vehicle class To create a custom vehicle class: <ol style="list-style-type: none"> On the app toolstrip, select Add Actor > New Actor Class. In the Class Editor window, select the Vehicle parameter. Set other class properties as needed and click OK. 	<ul style="list-style-type: none"> SUV Small Pickup Truck Hatchback Box Truck (default for Truck class) Cuboid (default for custom vehicle classes) 																	
Bicycle	<ul style="list-style-type: none"> Bicyclist (default for Bicycle class) 																	
Pedestrian	<ul style="list-style-type: none"> Male Pedestrian (default for Pedestrian class) 																	
Jersey Barrier	<ul style="list-style-type: none"> Female Pedestrian 																	
Guardrail	<ul style="list-style-type: none"> Barrier (default for Jersey Barrier class) 																	
Custom nonvehicle class To create a custom nonvehicle class: <ol style="list-style-type: none"> On the app toolstrip, select Add Actor > New Actor Class. In the Class Editor window, clear the Vehicle parameter. Set other class properties as needed and click OK. 	<ul style="list-style-type: none"> Cuboid (default for Guardrail class and custom nonvehicle classes) 																	
	<p>If you change the dimensions of an actor using the Actor Properties parameters, the app applies these changes in the</p>																	

Parameter	Description
	<p>Scenario Canvas display but not in the 3D display. This case does not apply to actors whose 3D Display Type is set to Barrier or Cuboid. The dimensions of these actors change in both displays.</p> <p>In the 3D display, actors of all other display types have predefined dimensions. To use the same dimensions in both displays, you can apply the predefined 3D display dimensions to the actors in the Scenario Canvas display. On the app toolstrip, under 3D Display, select Use 3D Simulation Actor Dimensions.</p>

Actor Properties — Actor properties, including position and orientation tab section

Use these parameters to specify properties such as the position and orientation of an actor.

Parameter	Description
Length (m)	<p>Length of actor, in meters, specified as a decimal scalar in the range (0, 60].</p> <p>For vehicles, the length must be greater than (Front Overhang + Rear Overhang).</p>
Width (m)	<p>Width of actor, in meters, specified as a decimal scalar in the range (0, 20].</p>
Height (m)	<p>Height of actor, in meters, specified as a decimal scalar in the range (0, 20].</p>
Front Overhang	<p>Distance between the front axle and front bumper, in meters, specified as a decimal scalar.</p> <p>The front overhang must be less than (Length (m) - Rear Overhang).</p> <p>This parameter applies to vehicles only.</p> <p>Default: 0.9</p>
Rear Overhang	<p>Distance between the rear axle and rear bumper, in meters, specified as a decimal scalar.</p> <p>The rear overhang must be less than (Length (m) - Front Overhang).</p> <p>This parameter applies to vehicles only.</p> <p>Default: 1</p>



Parameter	Description
Roll (°)	<p>Orientation angle of the actor about its x-axis, in degrees, specified as a decimal scalar.</p> <p>Roll (°) is clockwise-positive when looking in the forward direction of the x-axis, which points forward from the actor.</p> <p>When you export the MATLAB function of the driving scenario and run that function, the roll angles of actors in the output scenario are wrapped to the range [-180, 180].</p> <p>Default: 0</p>
Pitch (°)	<p>Orientation angle of the actor about its y-axis, in degrees, specified as a decimal scalar.</p> <p>Pitch (°) is clockwise-positive when looking in the forward direction of the y-axis, which points to the left of the actor.</p> <p>When you export the MATLAB function of the driving scenario and run that function, the pitch angles of actors in the output scenario are wrapped to the range [-180, 180].</p> <p>Default: 0</p>
Yaw (°)	<p>Orientation angle of the actor about its z-axis, in degrees, specified as a decimal scalar.</p> <p>Yaw (°) is clockwise-positive when looking in the forward direction of the z-axis, which points up from the ground. However, the Scenario Canvas has a bird's-eye-view perspective that looks in the reverse direction of the z-axis. Therefore, when viewing actors on this canvas, Yaw (°) is counterclockwise-positive.</p> <p>When you export the MATLAB function of the driving scenario and run that function, the yaw angles of actors in the output scenario are wrapped to the range [-180, 180].</p> <p>Default: 0</p>

Radar Cross Section — RCS of actor tab section

Use these parameters to manually specify the radar cross-section (RCS) of an actor. Alternatively, to import an RCS from a file or from the MATLAB workspace, expand this parameter section and click **Import**.

Parameter	Description
Azimuth Angles (deg)	Horizontal reflection pattern of actor, in degrees, specified as a vector of monotonically increasing decimal values in the range [-180, 180]. Default: [-180 180]
Elevation Angles (deg)	Vertical reflection pattern of actor, in degrees, specified as a vector of monotonically increasing decimal values in the range [-90, 90]. Default: [-90 90]
Pattern (dBsm)	RCS pattern, in decibels per square meter, specified as a Q -by- P table of decimal values. RCS is a function of the azimuth and elevation angles, where: <ul style="list-style-type: none"> • Q is the number of elevation angles specified by the Elevation Angles (deg) parameter. • P is the number of azimuth angles specified by the Azimuth Angles (deg) parameter.

Trajectory — Actor trajectories tab section

Use the **Waypoints, Speeds, Wait Times, and Yaw** table to manually set or modify the positions, speeds, wait times, and yaw orientation angles of actors at their specified waypoints. When specifying trajectories, to switch between adding forward and reverse motion waypoints, use the add forward and reverse motion waypoint buttons  .

Parameter	Description
Constant Speed (m/s)	Default speed of actors as you add waypoints, specified as a positive decimal scalar in meters per second. If you set specific speed values in the v (m/s) column of the Waypoints, Speeds, Wait Times, and Yaw table, then the app clears the Constant Speed (m/s) value. If you then specify a new Constant Speed (m/s) value, then the app sets all waypoints to the new constant speed value. The default speed of an actor varies by actor class. For example, cars and trucks have a default constant speed of 30 meters per second, whereas pedestrians have a default constant speed of 1.5 meters per second.

Parameter	Description
Waypoints, Speeds, Wait Times, and Yaw	<p>Actor waypoints, specified as a table.</p> <p>Each row corresponds to a waypoint and contains the position, speed, and orientation of the actor at that waypoint. The table has these columns:</p> <ul style="list-style-type: none"> • x (m) — World coordinate x-position of each waypoint in meters. • y (m) — World coordinate y-position of each waypoint in meters. • z (m) — World coordinate z-position of each waypoint in meters. • v (m/s) — Actor speed, in meters per second, at each waypoint. By default, the app sets the v (m/s) of newly added waypoints to the Constant Speed (m/s) parameter value. To specify a reverse motion between trajectories, set v (m/s) to a negative value. Positive speeds (forward motions) and negative speeds (reverse motions) must be separated by a waypoint with a speed of 0. • wait (s) — Wait time for an actor, in seconds, at each waypoint. When you set the wait time to a positive value, the corresponding velocity value v (m/s) resets to 0. You cannot set wait times at consecutive waypoints along the trajectory of an actor to positive values. • yaw (°) — Yaw orientation angle of an actor, in degrees, at each waypoint. Yaw angles are counterclockwise-positive when looking at the scenario from the top down. By default, the app computes the yaw automatically based on the specified trajectory. To constrain the trajectory so that the vehicle has specific orientations at certain waypoints, set the desired yaw (°) values at those waypoints. To restore a yaw back to its default value, right-click the waypoint and select Restore Default Yaw.

Parameter	Description
Use smooth, jerk-limited trajectory	<p>Select this parameter to specify a smooth trajectory for the actor. Smooth trajectories have no discontinuities in acceleration and are required for INS sensor simulation. If you mount an INS sensor to the ego vehicle, then the app updates the ego vehicle to use a smooth trajectory.</p> <p>If the app is unable to generate a smooth trajectory, try making these adjustments:</p> <ul style="list-style-type: none"> • Increase the distance between waypoints. • Reduce the speed between waypoints. • Increase the maximum jerk by using the Jerk (m/s³) parameter. <p>The app computes smooth trajectories by using the smoothTrajectory function.</p> <p>Default: off</p>
Jerk (m/s³)	<p>Maximum longitudinal jerk of the actor, in meters per second cubed, specified as a real-valued scalar greater than or equal to 0.1.</p>

Actor Spawn and Despawn During Simulation

Parameter	Description
Actor spawn and despawn	<p>Select this parameter to spawn or despawn an actor in the driving scenario, while the simulation is running. To enable this parameter, you must first select an actor in the scenario by clicking on the actor.</p> <p>Specify values for the Entry Time (s) and Exit Time (s) parameters to make the actor enter (spawn) and exit (despawn) the scenario, respectively.</p> <p>Default: off</p>
Entry Time (s)	<p>Entry time at which an actor spawns into the scenario during simulation, specified as one of these values:</p> <ul style="list-style-type: none"> • Positive scalar — Spawn an actor only once. • Vector of positive values — Spawn an actor multiple times. <p>The default value for entry time is 0. Units are in seconds.</p>

Parameter	Description
Exit Time (s)	<p>Exit time at which an actor despawns from the scenario during simulation, specified as one of these values:</p> <ul style="list-style-type: none"> • Positive scalar — Despawn an actor only once. • Vector of positive values — Despawn an actor multiple times. <p>The default value for exit time is <code>Inf</code>. Units are in seconds.</p>

To get expected spawning and despawning behavior, the **Entry Time (s)** and **Exit Time (s)** parameters must satisfy these conditions:

- Each value for the **Entry Time (s)** parameter must be less than the corresponding value for the **Exit Time (s)** parameter.
- Each value for the **Entry Time (s)** and the **Exit Time (s)** parameters must be less than the entire simulation time that is set by either the stop condition or the stop time.
- When the **Entry Time (s)** and **Exit Time (s)** parameters are specified as vectors:
 - The elements of each vector must be in ascending order.
 - The lengths of both the vectors must be the same.

Barriers — Barrier segment properties, barrier center locations, and RCS patterns
tab

To enable the **Barriers** parameters, add at least one barrier to the scenario. Then, select a barrier from either the **Scenario Canvas** or from the **Barriers** tab. The parameter values in the **Barriers** tab are based on the barrier you select.

Parameter	Description
Color	<p>To change the color of a barrier, next to the actor selection list, click the color patch for that barrier.</p> <p>Then, use the color picker to select one of the standard colors commonly used in MATLAB graphics. Alternatively, select a custom color from the Custom Colors tab by first clicking  in the upper-right corner of the Color dialog box. You can then select custom colors from a gradient or specify a color using an RGB triplet, hexadecimal color code, or HSV triplet.</p> <p>Color changes made in the app are carried forward into Bird's-Eye Scope visualizations.</p>
Name	Name of barrier

Parameter	Description
Bank Angle (°)	<p>Side-to-side incline of the barrier, in degrees, specified as one of these values:</p> <ul style="list-style-type: none"> • Decimal scalar — Applies a uniform bank angle along the entire length of the barrier • N-element vector of decimal values — Applies a different bank angle to each barrier Segment, where N is the number of barrier centers in the selected barrier <p>This property is valid only when you add a barrier using barrier centers. When you add a barrier to a road, the barrier automatically takes the bank angles of the road.</p> <p>Default: 0</p>
Barrier Type	<p>Barrier type, specified as one of the following options:</p> <ul style="list-style-type: none"> • Jersey Barrier • Guardrail

Barrier Properties — Barrier properties

tab section

Use these parameters to specify physical properties of the barrier.

Parameter	Description
Width (m)	<p>Width of the barrier, in meters, specified as a decimal scalar in the range (0,20] .</p> <p>Default:</p> <ul style="list-style-type: none"> • Jersey Barrier: 0.61 • Guardrail: 0.433
Height (m)	<p>Height of the barrier, in meters, specified as a decimal scalar in the range (0,20] .</p> <p>Default:</p> <ul style="list-style-type: none"> • Jersey Barrier: 0.81 • Guardrail: 0.75
Segment Length (m)	<p>Length of each barrier segment, in meters, specified as a decimal scalar in the range (0,100].</p> <p>Default: 5</p>

Parameter	Description
Segment Gap (m)	Gap between consecutive barrier segments, in meters, specified as a decimal scalar in the range [0,Segment Length]. Default: 0

Radar Cross Section — RCS of barrier tab section

Use these parameters to manually specify the radar cross-section (RCS) of a barrier. Alternatively, to import an RCS from a file or from the MATLAB workspace, expand this parameter section and click **Import**.

Parameter	Description
Azimuth Angles (deg)	Horizontal reflection pattern of barrier, in degrees, specified as a vector of monotonically increasing decimal values in the range [-180, 180]. Default: [-180 180]
Elevation Angles (deg)	Vertical reflection pattern of barrier, in degrees, specified as a vector of monotonically increasing decimal values in the range [-90, 90]. Default: [-90 90]
Pattern (dBsm)	RCS pattern, in decibels per square meter, specified as a Q -by- P table of decimal values. RCS is a function of the azimuth and elevation angles, where: <ul style="list-style-type: none"> Q is the number of elevation angles specified by the Elevation Angles (deg) parameter. P is the number of azimuth angles specified by the Azimuth Angles (deg) parameter.

Barrier Centers — Barrier center locations tab section

Each row of the **Barrier Centers** table contains the x -, y -, and z -positions of a barrier center within the selected barrier. All barriers must have at least two unique barrier center positions. When you update a cell within the table, the **Scenario Canvas** updates to reflect the new barrier center position. The orientation of the barrier depends on the values of the barrier centers. The barrier centers specifies the direction in which the barrier renders in the **Scenario Canvas**.

Parameter	Description
Road Edge Offset (m)	Distance by which the barrier is offset from the road edge in the lateral direction, in meters, specified as a decimal scalar.

Parameter	Description
x (m)	x-axis position of the barrier center, in meters, specified as a decimal scalar.
y (m)	y-axis position of the barrier center, in meters, specified as a decimal scalar.
z (m)	z-axis position of the barrier center, in meters, specified as a decimal scalar. Default: 0

Sensors (Camera) — Camera sensor placement, intrinsic camera parameters, and detection parameters tab

To access these parameters, add at least one camera sensor to the scenario by following these steps:

- 1 On the app toolbar, click **Add Camera**.
- 2 From the **Sensors** tab, select the sensor from the list. The parameter values in this tab are based on the sensor you select.

Parameter	Description
Enabled	Enable or disable the selected sensor. Select this parameter to capture sensor data during simulation and visualize that data in the Bird's-Eye Plot pane.
Name	Name of sensor.
Update Interval (ms)	<p>Frequency at which the sensor updates, in milliseconds, specified as an integer multiple of the app sample time defined under Settings, in the Sample Time (ms) parameter.</p> <p>The default Update Interval (ms) value of 100 is an integer multiple of the default Sample Time (ms) parameter value of 10. When the update interval is a multiple of the sample time, it ensures that the app samples and generates the data found at each update interval during simulation.</p> <p>If you update the app sample time such that a sensor is no longer a multiple of the app sample time, the app prompts you with the option to automatically update the Update Interval (ms) parameter to the closest integer multiple.</p> <p>Default: 100</p>
Type	Type of sensor, specified as Radar , Vision , Lidar , INS , or Ultrasonic .

Sensor Placement — Camera position and orientation

tab section

Use these parameters to set the position and orientation of the selected camera sensor.

Parameter	Description
X (m)	<p>X-axis position of the sensor in the vehicle coordinate system, in meters, specified as a decimal scalar.</p> <p>The X-axis points forward from the vehicle. The origin is located at the center of the vehicle's rear axle.</p>
Y (m)	<p>Y-axis position of the sensor in the vehicle coordinate system, in meters, specified as a decimal scalar.</p> <p>The Y-axis points to the left of the vehicle. The origin is located at the center of the vehicle's rear axle.</p>
Height (m)	<p>Height of the sensor above the ground, in meters, specified as a positive decimal scalar.</p>
Roll (°)	<p>Orientation angle of the sensor about its X-axis, in degrees, specified as a decimal scalar.</p> <p>Roll (°) is clockwise-positive when looking in the forward direction of the X-axis, which points forward from the sensor.</p>
Pitch (°)	<p>Orientation angle of the sensor about its Y-axis, in degrees, specified as a decimal scalar.</p> <p>Pitch (°) is clockwise-positive when looking in the forward direction of the Y-axis, which points to the left of the sensor.</p>
Yaw (°)	<p>Orientation angle of the sensor about its Z-axis, in degrees, specified as a decimal scalar.</p> <p>Yaw (°) is clockwise-positive when looking in the forward direction of the Z-axis, which points up from the ground. The Sensor Canvas has a bird's-eye-view perspective that looks in the reverse direction of the Z-axis. Therefore, when viewing sensor coverage areas on this canvas, Yaw (°) is counterclockwise-positive.</p>

Camera Settings — Intrinsic camera parameters

tab section

Use these parameters to set the intrinsic parameters of the camera sensor.

Parameter	Description
Focal Length X	Horizontal point at which the camera is in focus, in pixels, specified as a positive decimal scalar. The default focal length changes depending on where you place the sensor on the ego vehicle.
Focal Length Y	Vertical point at which the camera is in focus, in pixels, specified as a positive decimal scalar. The default focal length changes depending on where you place the sensor on the ego vehicle.
Image Width	Horizontal camera resolution, in pixels, specified as a positive integer. Default: 640
Image Height	Vertical camera resolution, in pixels, specified as a positive integer. Default: 480
Principal Point X	Horizontal image center, in pixels, specified as a positive decimal scalar. Default: 320
Principal Point Y	Vertical image center, in pixels, specified as a positive decimal scalar. Default: 240

Sensor Parameters — Camera detection parameters
tab section

To view all camera detection parameters in the app, expand the **Sensor Limits**, **Lane Settings**, and **Accuracy & Noise Settings** sections.

Parameter	Description
Detection Type	Type of detections reported by camera, specified as one of these values: <ul style="list-style-type: none"> • Objects — Report object detections only. • Objects & Lanes — Report object and lane boundary detections. • Lanes — Report lane boundary detections only. Default: Objects
Detection Probability	Probability that the camera detects an object, specified as a decimal scalar in the range (0, 1]. Default: 0.9

Parameter	Description
False Positives Per Image	<p>Number of false positives reported per update interval, specified as a nonnegative decimal scalar. This value must be less than or equal to the maximum number of detections specified in the Limit # of Detections parameter.</p> <p>Default: 0 . 1</p>
Limit # of Detections	<p>Select this parameter to limit the number of simultaneous object detections that the sensor reports. Specify Limit # of Detections as a positive integer less than 2^{63}.</p> <p>To enable this parameter, set the Detection Type parameter to Objects or Objects & Lanes.</p> <p>Default: off 50 (when on)</p>
Detection Coordinates	<p>Coordinate system of output detection locations, specified as one of these values:</p> <ul style="list-style-type: none"> • Ego Cartesian — The app outputs detections in the coordinate system of the ego vehicle. • Sensor Cartesian — The app outputs detections in the coordinate system of the sensor. <p>Default: Ego Cartesian</p>

Sensor Limits

Parameter	Description
Max Speed (m/s)	Fastest relative speed at which the camera can detect objects, in meters per second, specified as a nonnegative decimal scalar. Default: 100
Max Range (m)	Farthest distance at which the camera can detect objects, in meters, specified as a positive decimal scalar. Default: 150
Max Allowed Occlusion	Maximum percentage of object that can be blocked while still being detected, specified as a decimal scalar in the range [0, 1). Default: 0.5
Min Object Image Width	Minimum horizontal size of objects that the camera can detect, in pixels, specified as positive decimal scalar. Default: 15
Min Object Image Height	Minimum vertical size of objects that the camera can detect, in pixels, specified as positive decimal scalar. Default: 15

Lane Settings

Parameter	Description
Lane Update Interval (ms)	<p>Frequency at which the sensor updates lane detections, in milliseconds, specified as a decimal scalar.</p> <p>Default: 100</p>
Min Lane Image Width	<p>Minimum horizontal size of objects that the sensor can detect, in pixels, specified as a decimal scalar.</p> <p>To enable this parameter, set the Detection Type parameter to Lanes or Objects & Lanes.</p> <p>Default: 3</p>
Min Lane Image Height	<p>Minimum vertical size of objects that the sensor can detect, in pixels, specified as a decimal scalar.</p> <p>To enable this parameter, set the Detection Type parameter to Lanes or Objects & Lanes.</p> <p>Default: 20</p>
Boundary Accuracy	<p>Accuracy with which the sensor places a lane boundary, in pixels, specified as a decimal scalar.</p> <p>To enable this parameter, set the Detection Type parameter to Lanes or Objects & Lanes.</p> <p>Default: 3</p>
Limit # of Lanes	<p>Select this parameter to limit the number of lane detections that the sensor reports. Specify Limit # of Lanes as a positive integer.</p> <p>To enable this parameter, set the Detection Type parameter to Lanes or Objects & Lanes.</p> <p>Default: off 30 (when on)</p>

Accuracy & Noise Settings

Parameter	Description
Bounding Box Accuracy	Positional noise used for fitting bounding boxes to targets, in pixels, specified as a positive decimal scalar. Default: 5
Process Noise Intensity (m/s²)	Noise intensity used for smoothing position and velocity measurements, in meters per second squared, specified as a positive decimal scalar. Default: 5
Has Noise	Select this parameter to enable adding noise to sensor measurements. Default: off

Sensors (Radar) — Radar sensor placement and detection parameters
tab

To access these parameters, add at least one radar sensor to the scenario.

- 1 On the app toolstrip, click **Add Radar**.
- 2 On the **Sensors** tab, select the sensor from the list. The parameter values change based on the sensor you select.

Parameter	Description
Enabled	Enable or disable the selected sensor. Select this parameter to capture sensor data during simulation and visualize that data in the Bird's-Eye Plot pane.
Name	Name of sensor.

Parameter	Description
Update Interval (ms)	<p>Frequency at which the sensor updates, in milliseconds, specified as an integer multiple of the app sample time defined under Settings, in the Sample Time (ms) parameter.</p> <p>The default Update Interval (ms) value of 100 is an integer multiple of the default Sample Time (ms) parameter value of 10. When the update interval is a multiple of the sample time, it ensures that the app samples and generates the data found at each update interval during simulation.</p> <p>If you update the app sample time such that a sensor is no longer a multiple of the app sample time, the app prompts you with the option to automatically update the Update Interval (ms) parameter to the closest integer multiple.</p> <p>Default: 100</p>
Type	Type of sensor, specified as Radar , Vision , Lidar , INS , or Ultrasonic .

Sensor Placement — Radar position and orientation tab section

Use these parameters to set the position and orientation of the selected radar sensor.

Parameter	Description
X (m)	<p>X-axis position of the sensor in the vehicle coordinate system, in meters, specified as a decimal scalar.</p> <p>The X-axis points forward from the vehicle. The origin is located at the center of the vehicle's rear axle.</p>
Y (m)	<p>Y-axis position of the sensor in the vehicle coordinate system, in meters, specified as a decimal scalar.</p> <p>The Y-axis points to the left of the vehicle. The origin is located at the center of the vehicle's rear axle.</p>
Height (m)	Height of the sensor above the ground, in meters, specified as a positive decimal scalar.

Parameter	Description
Roll (°)	Orientation angle of the sensor about its X-axis, in degrees, specified as a decimal scalar. Roll (°) is clockwise-positive when looking in the forward direction of the X-axis, which points forward from the sensor.
Pitch (°)	Orientation angle of the sensor about its Y-axis, in degrees, specified as a decimal scalar. Pitch (°) is clockwise-positive when looking in the forward direction of the Y-axis, which points to the left of the sensor.
Yaw (°)	Orientation angle of the sensor about its Z-axis, in degrees, specified as a decimal scalar. Yaw (°) is clockwise-positive when looking in the forward direction of the Z-axis, which points up from the ground. The Sensor Canvas has a bird's-eye-view perspective that looks in the reverse direction of the Z-axis. Therefore, when viewing sensor coverage areas on this canvas, Yaw (°) is counterclockwise-positive.

Sensor Parameters — Radar detection parameters
tab section

To view all radar detection parameters in the app, expand the **Advanced Parameters** and **Accuracy & Noise Settings** sections.

Parameter	Description
Detection Probability	Probability that the radar detects an object, specified as a decimal scalar in the range (0, 1]. Default: 0.9
False Alarm Rate	Probability of a false detection per resolution rate, specified as a decimal scalar in the range [1e-07, 1e-03]. Default: 1e-06
Field of View Azimuth	Horizontal field of view of radar, in degrees, specified as a positive decimal scalar. Default: 20
Field of View Elevation	Vertical field of view of radar, in degrees, specified as a positive decimal scalar. Default: 5

Parameter	Description
Max Range (m)	Farthest distance at which the radar can detect objects, in meters, specified as a positive decimal scalar. Default: 150
Range Rate Min, Range Rate Max	Select this parameter to set minimum and maximum range rate limits for the radar. Specify Range Rate Min and Range Rate Max as decimal scalars, in meters per second, where Range Rate Min is less than Range Rate Max . Default (Min): -100 Default (Max): 100
Has Elevation	Select this parameter to enable the radar to measure the elevation of objects. This parameter enables the elevation parameters in the Accuracy & Noise Settings section. Default: off
Has Occlusion	Select this parameter to enable the radar to model occlusion. Default: on

Advanced Parameters

Parameter	Description
Reference Range	<p>Reference range for a given probability of detection, in meters, specified as a positive decimal scalar.</p> <p>The reference range is the range at which the radar detects a target of the size specified by Reference RCS, given the probability of detection specified by Detection Probability.</p> <p>Default: 100</p>
Reference RCS	<p>Reference RCS for a given probability of detection, in decibels per square meter, specified as a nonnegative decimal scalar.</p> <p>The reference RCS is the target size at which the radar detects a target, given the reference range specified by Reference Range and the probability of detection specified by Detection Probability.</p> <p>Default: 0</p>
Limit # of Detections	<p>Select this parameter to limit the number of simultaneous detections that the sensor reports. Specify Limit # of Detections as a positive integer less than 2^{63}.</p> <p>Default: off 50 (when on)</p>
Detection Coordinates	<p>Coordinate system of output detection locations, specified as one of these values:</p> <ul style="list-style-type: none"> • Body — The app outputs detections in the coordinate system of the ego vehicle body. • Sensor Rectangular — The app outputs detections in the coordinate system of the sensor. • Sensor Spherical — The app outputs detections in a spherical coordinate system. This coordinate system is centered at the radar and aligned with the orientation of the radar on the ego vehicle. <p>Default: Ego Cartesian</p>

Accuracy & Noise Settings

Parameter	Description
Azimuth Resolution	<p>Minimum separation in azimuth angle at which the radar can distinguish between two targets, in degrees, specified as a positive decimal scalar.</p> <p>The azimuth resolution is typically the 3 dB downpoint in the azimuth angle beamwidth of the radar.</p> <p>Default: 4</p>
Azimuth Bias Fraction	<p>Maximum azimuth accuracy of the radar, specified as a nonnegative decimal scalar.</p> <p>The azimuth bias is expressed as a fraction of the azimuth resolution specified by the Azimuth Resolution parameter. Units are dimensionless.</p> <p>Default: 0.1</p>
Elevation Resolution	<p>Minimum separation in elevation angle at which the radar can distinguish between two targets, in degrees, specified as a positive decimal scalar.</p> <p>The elevation resolution is typically the 3 dB downpoint in the elevation angle beamwidth of the radar.</p> <p>To enable this parameter, in the Sensor Parameters section, select the Has Elevation parameter.</p> <p>Default: 5</p>
Elevation Bias Fraction	<p>Maximum elevation accuracy of the radar, specified as a nonnegative decimal scalar.</p> <p>The elevation bias is expressed as a fraction of the elevation resolution specified by the Elevation Resolution parameter. Units are dimensionless.</p> <p>To enable this parameter, under Sensor Parameters, select the Has Elevation parameter.</p> <p>Default: 0.1</p>
Range Resolution	<p>Minimum range separation at which the radar can distinguish between two targets, in meters, specified as a positive decimal scalar.</p> <p>Default: 2.5</p>

Parameter	Description
Range Bias Fraction	<p>Maximum range accuracy of the radar, specified as a nonnegative decimal scalar.</p> <p>The range bias is expressed as a fraction of the range resolution specified in the Range Resolution parameter. Units are dimensionless.</p> <p>Default: 0.05</p>
Range Rate Resolution	<p>Minimum range rate separation at which the radar can distinguish between two targets, in meters per second, specified as a positive decimal scalar.</p> <p>To enable this parameter, in the Sensor Parameters section, select the Range Rate Min, Range Rate Max parameter and set the range rate values.</p> <p>Default: 0.5</p>
Range Rate Bias Fraction	<p>Maximum range rate accuracy of the radar, specified as a nonnegative decimal scalar.</p> <p>The range rate bias is expressed as a fraction of the range rate resolution specified in the Range Rate Resolution parameter. Units are dimensionless.</p> <p>To enable this parameter, in the Sensor Parameters section, select the Range Rate Min, Range Rate Max parameter and set the range rate values.</p> <p>Default: 0.05</p>
Has Noise	<p>Select this parameter to enable adding noise to sensor measurements.</p> <p>Default: on</p>
Has False Alarms	<p>Select this parameter to enable false alarms in sensor detections.</p> <p>Default: on</p>

Sensors (Lidar) — Lidar sensor placement, point cloud reporting, and detection parameters tab

To access these parameters, add at least one lidar sensor to the scenario.

- 1 On the app toolstrip, click **Add Lidar**.
- 2 On the **Sensors** tab, select the sensor from the list. The parameter values change based on the sensor you select.

When you add a lidar sensor to a scenario, the **Bird's-Eye Plot** and **Ego-Centric View** display the mesh representations of actors. For example, here is a sample view of actor meshes on the **Ego-Centric View**.

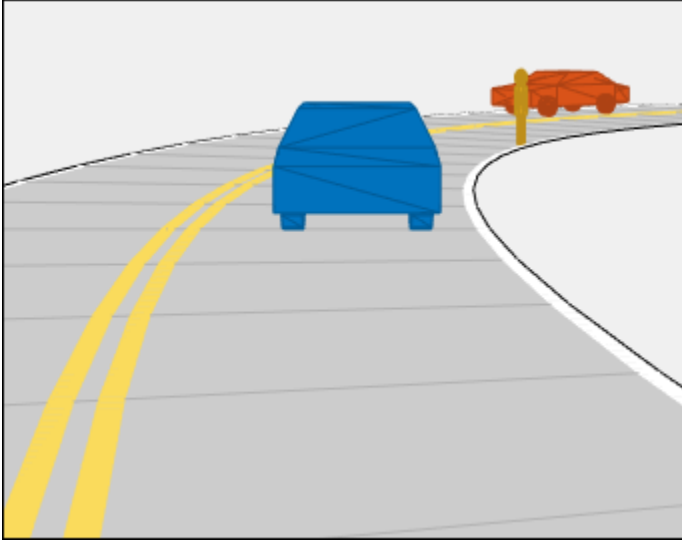

The lidar sensors use these more detailed representations of actors to generate point cloud data. The **Scenario Canvas** still displays only the cuboid representations. The other sensors still base their detections on the cuboid representations.

To turn off actor meshes, use the properties under **Display** on the app toolbar. To modify the mesh display types of actors, select **Add Actor > Edit Actor Classes**. In the Class Editor, modify the **Mesh Display Type** parameter of that actor class.

Parameter	Description
Enabled	Enable or disable the selected sensor. Select this parameter to capture sensor data during simulation and visualize that data in the Bird's-Eye Plot pane.
Name	Name of sensor.

Parameter	Description
Update Interval (ms)	<p>Frequency at which the sensor updates, in milliseconds, specified as an integer multiple of the app sample time defined under Settings, in the Sample Time (ms) parameter.</p> <p>The default Update Interval (ms) value of 100 is an integer multiple of the default Sample Time (ms) parameter value of 10. When the update interval is a multiple of the sample time, it ensures that the app samples and generates the data found at each update interval during simulation.</p> <p>If you update the app sample time such that a sensor is no longer a multiple of the app sample time, the app prompts you with the option to automatically update the Update Interval (ms) parameter to the closest integer multiple.</p> <p>Default: 100</p>
Type	Type of sensor, specified as Radar , Vision , Lidar , INS , or Ultrasonic .

Sensor Placement — Lidar position and orientation tab section

Use these parameters to set the position and orientation of the selected lidar sensor.

Parameter	Description
X (m)	<p>X-axis position of the sensor in the vehicle coordinate system, in meters, specified as a decimal scalar.</p> <p>The X-axis points forward from the vehicle. The origin is located at the center of the vehicle's rear axle.</p>
Y (m)	<p>Y-axis position of the sensor in the vehicle coordinate system, in meters, specified as a decimal scalar.</p> <p>The Y-axis points to the left of the vehicle. The origin is located at the center of the vehicle's rear axle.</p>
Height (m)	Height of the sensor above the ground, in meters, specified as a positive decimal scalar.

Parameter	Description
Roll (°)	<p>Orientation angle of the sensor about its X-axis, in degrees, specified as a decimal scalar.</p> <p>Roll (°) is clockwise-positive when looking in the forward direction of the X-axis, which points forward from the sensor.</p>
Pitch (°)	<p>Orientation angle of the sensor about its Y-axis, in degrees, specified as a decimal scalar.</p> <p>Pitch (°) is clockwise-positive when looking in the forward direction of the Y-axis, which points to the left of the sensor.</p>
Yaw (°)	<p>Orientation angle of the sensor about its Z-axis, in degrees, specified as a decimal scalar.</p> <p>Yaw (°) is clockwise-positive when looking in the forward direction of the Z-axis, which points up from the ground. The Sensor Canvas has a bird's-eye-view perspective that looks in the reverse direction of the Z-axis. Therefore, when viewing sensor coverage areas on this canvas, Yaw (°) is counterclockwise-positive.</p>

Point Cloud Reporting — Point cloud reporting parameters
tab section

Parameter	Description
Detection Coordinates	<p>Coordinate system of output detection locations, specified as one of these values:</p> <ul style="list-style-type: none"> • Ego Cartesian — The app outputs detections in the coordinate system of the ego vehicle. • Sensor Cartesian — The app outputs detections in the coordinate system of the sensor. <p>Default: Ego Cartesian</p>
Output organized point cloud locations	<p>Select this parameter to output the generated sensor data as an organized point cloud. If you clear this parameter, the output is unorganized.</p> <p>Default: on</p>
Include ego vehicle in generated point cloud	<p>Select this parameter to include the ego vehicle in the generated point cloud.</p> <p>Default: on</p>

Parameter	Description
Include roads in generated point cloud	Select this parameter to include roads in the generated point cloud. Default: off

Sensor Parameters — Lidar detection parameters
tab section

Sensor Limits

Parameter	Description
Max Range (m)	Farthest distance at which the lidar can detect objects, in meters, specified as a positive decimal scalar. Default: 50
Range Accuracy (m)	Accuracy of range measurements, in meters, specified as a positive decimal scalar. Default: 0.002
Azimuth	Azimuthal resolution of the lidar sensor, in degrees, specified as a positive decimal scalar. The azimuthal resolution defines the minimum separation in azimuth angle at which the lidar can distinguish two targets. Default: 1.6
Elevation	Elevation resolution of the lidar sensor, in degrees, specified as a positive decimal scalar. The elevation resolution defines the minimum separation in elevation angle at which the lidar can distinguish two targets. Default: 1.25
Azimuthal Limits (deg)	Azimuthal limits of the lidar sensor, in degrees, specified as a two-element vector of decimal scalars of the form [min, max]. Default: [-45 45]
Elevation Limits (deg)	Elevation limits of the lidar sensor, in degrees, specified as a two-element vector of decimal scalars of the form [min, max]. Default: [-20 20]
Has Noise	Select this parameter to enable adding noise to sensor measurements. Default: off

Sensors (INS) — INS sensor placement, measurement parameters tab

To access these parameters, add at least one INS sensor to the scenario by following these steps:

- 1 On the app toolbar, click **Add INS**.
- 2 From the **Sensors** tab, select the sensor from the list. The parameter values in this tab are based on the sensor you select.

Parameter	Description
Enabled	Enable or disable the selected sensor. Select this parameter to capture sensor data during simulation and visualize that data in the Bird's-Eye Plot pane.
Name	Name of sensor.
Update Interval (ms)	<p>Frequency at which the sensor updates, in milliseconds, specified as an integer multiple of the app sample time defined under Settings, in the Sample Time (ms) parameter.</p> <p>The default Update Interval (ms) value of 100 is an integer multiple of the default Sample Time (ms) parameter value of 10. When the update interval is a multiple of the sample time, it ensures that the app samples and generates the data found at each update interval during simulation.</p> <p>If you update the app sample time such that a sensor is no longer a multiple of the app sample time, the app prompts you with the option to automatically update the Update Interval (ms) parameter to the closest integer multiple.</p> <p>Default: 100</p>
Type	Type of sensor, specified as Radar , Vision , Lidar , INS , or Ultrasonic .

Sensor Placement — INS position tab section

Use these parameters to set the position of the selected INS sensor. The orientation of the sensor is assumed to be aligned with the ego vehicle origin, so the **Roll (°)**, **Pitch (°)**, and **Yaw (°)** properties are disabled for this sensor.

Parameter	Description
X (m)	<p>X-axis position of the sensor in the vehicle coordinate system, in meters, specified as a decimal scalar.</p> <p>The X-axis points forward from the vehicle. The origin is located at the center of the vehicle's rear axle.</p>
Y (m)	<p>Y-axis position of the sensor in the vehicle coordinate system, in meters, specified as a decimal scalar.</p> <p>The Y-axis points to the left of the vehicle. The origin is located at the center of the vehicle's rear axle.</p>
Height (m)	Height of the sensor above the ground, in meters, specified as a positive decimal scalar.
Roll (°)	<p>Orientation angle of the sensor about its X-axis, in degrees, specified as a decimal scalar.</p> <p>Roll (°) is clockwise-positive when looking in the forward direction of the X-axis, which points forward from the sensor.</p>
Pitch (°)	<p>Orientation angle of the sensor about its Y-axis, in degrees, specified as a decimal scalar.</p> <p>Pitch (°) is clockwise-positive when looking in the forward direction of the Y-axis, which points to the left of the sensor.</p>
Yaw (°)	<p>Orientation angle of the sensor about its Z-axis, in degrees, specified as a decimal scalar.</p> <p>Yaw (°) is clockwise-positive when looking in the forward direction of the Z-axis, which points up from the ground. The Sensor Canvas has a bird's-eye-view perspective that looks in the reverse direction of the Z-axis. Therefore, when viewing sensor coverage areas on this canvas, Yaw (°) is counterclockwise-positive.</p>

Sensor Parameters — INS measurement parameters

tab section

For additional details about these parameters, see the `insSensor` object reference page.

Parameter	Description
Roll Accuracy (°)	Roll accuracy, in degrees, specified as a nonnegative decimal scalar. This value sets the standard deviation of the roll measurement noise. Default: 0.2
Pitch Accuracy (°)	Pitch accuracy, in degrees, specified as a nonnegative decimal scalar. This value sets the standard deviation of the pitch measurement noise. Default: 0.2
Yaw Accuracy (°)	Yaw accuracy, in degrees, specified as a nonnegative decimal scalar. This value sets the standard deviation of the yaw measurement noise. Default: 1
Position Accuracy (m)	Accuracy of x-, y-, and z-position measurements, in meters, specified as a decimal scalar or three-element decimal scalar. This value sets the standard deviation of the position measurement noise. Specify a scalar to set the accuracy of all three positions to this value. Default: [1 1 1]
Velocity Accuracy (m/s)	Accuracy of velocity measurements, in meters per second, specified as a decimal scalar. This value sets the standard deviation of the velocity measurement noise. Default: 0.05
Acceleration Accuracy	Accuracy of acceleration measurements, in meters per second squared, specified as a decimal scalar. This value sets the standard deviation of the acceleration measurement noise. Default: 0
Angular Velocity Accuracy	Accuracy of angular velocity measurements, in degrees per second, specified as a decimal scalar. This value sets the standard deviation of the angular velocity measurement noise. Default: 0
Has GNSS Fix	Enable global navigation satellite system (GNSS) receiver fix. If you clear this parameter, then position measurements drift at a rate specified by the Position Error Factor parameter. Default: on

Parameter	Description
Position Error Factor	Position error factor without GNSS fix, specified as a nonnegative decimal scalar or 1-by-3 decimal vector. Default: [0 0 0]
Random Stream	Source of random number stream, specified as one of these options: <ul style="list-style-type: none"> • Global stream -- Generate random numbers using the current global random number stream. • mt19937ar with seed -- Generate random numbers using the mt19937ar algorithm, with the seed specified by the Seed parameter. Default: Global stream
Seed	Initial seed of the mt19937ar random number generator algorithm, specified as a nonnegative integer. Default: 67

Sensors (Ultrasonic) — Ultrasonic sensor placement, measurement parameters tab

To access these parameters, add at least one ultrasonic sensor to the scenario by following these steps:

- 1 On the app toolstrip, click **Add Ultrasonic**.
- 2 From the **Sensors** tab, select the sensor from the list. The parameter values in this tab are based on the sensor you select.

Parameter	Description
Enabled	Enable or disable the selected sensor. Select this parameter to capture sensor data during simulation and visualize that data in the Bird's-Eye Plot pane.
Name	Name of sensor.

Parameter	Description
Update Interval (ms)	<p>Frequency at which the sensor updates, in milliseconds, specified as an integer multiple of the app sample time defined under Settings, in the Sample Time (ms) parameter.</p> <p>The default Update Interval (ms) value of 100 is an integer multiple of the default Sample Time (ms) parameter value of 10. When the update interval is a multiple of the sample time, it ensures that the app samples and generates the data found at each update interval during simulation.</p> <p>If you update the app sample time such that a sensor is no longer a multiple of the app sample time, the app prompts you with the option to automatically update the Update Interval (ms) parameter to the closest integer multiple.</p> <p>Default: 100</p>
Type	Type of sensor, specified as Radar , Vision , Lidar , INS , or Ultrasonic .

Sensor Placement — Ultrasonic position tab section

Use these parameters to set the position of the selected Ultrasonic sensor.

Parameter	Description
X (m)	<p>X-axis position of the sensor in the vehicle coordinate system, in meters, specified as a decimal scalar.</p> <p>The X-axis points forward from the vehicle. The origin is located at the center of the vehicle's rear axle.</p>
Y (m)	<p>Y-axis position of the sensor in the vehicle coordinate system, in meters, specified as a decimal scalar.</p> <p>The Y-axis points to the left of the vehicle. The origin is located at the center of the vehicle's rear axle.</p>
Height (m)	Height of the sensor above the ground, in meters, specified as a positive decimal scalar.

Parameter	Description
Roll (°)	Orientation angle of the sensor about its X-axis, in degrees, specified as a decimal scalar. Roll (°) is clockwise-positive when looking in the forward direction of the X-axis, which points forward from the sensor.
Pitch (°)	Orientation angle of the sensor about its Y-axis, in degrees, specified as a decimal scalar. Pitch (°) is clockwise-positive when looking in the forward direction of the Y-axis, which points to the left of the sensor.
Yaw (°)	Orientation angle of the sensor about its Z-axis, in degrees, specified as a decimal scalar. Yaw (°) is clockwise-positive when looking in the forward direction of the Z-axis, which points up from the ground. The Sensor Canvas has a bird's-eye-view perspective that looks in the reverse direction of the Z-axis. Therefore, when viewing sensor coverage areas on this canvas, Yaw (°) is counterclockwise-positive.

Sensor Parameters — Ultrasonic measurement parameters
tab section

For additional details about these parameters, see the `ultrasonicDetectionGenerator` object reference page.

Parameter	Description
Field of View Azimuth	Horizontal field of view of ultrasonic sensor, in degrees, specified as a positive decimal scalar. Default: 70
Field of View Elevation	Vertical field of view of ultrasonic sensor, in degrees, specified as a positive decimal scalar. Default: 35
Max Range (m)	Farthest distance at which the ultrasonic sensor can detect objects and report distance values, in meters, specified as a positive decimal scalar. Default: 5.5
Min Range (m)	Nearest distance at which the ultrasonic sensor can detect objects and report distance values, in meters, specified as a positive decimal scalar. Default: 0.15

Parameter	Description
Min Detection-Only Range (m)	<p>Nearest distance at which the ultrasonic sensor can only detect objects but not report distance values, in meters, specified as a positive decimal scalar.</p> <p>Default: 0.03</p>

Settings — Simulation sample time, stop condition, and stop time dialog box

To access these parameters, on the app toolstrip, click **Settings**.

Simulation Settings

Parameter	Description
Sample Time (ms)	<p>Frequency at which the simulation updates, in milliseconds.</p> <p>Increase the sample time to speed up simulation. This increase has no effect on actor speeds, even though actors can appear to go faster during simulation. The actor positions are just being sampled and displayed on the app at less frequent intervals, resulting in faster, choppier animations. Decreasing the sample time results in smoother animations, but the actors appear to move slower, and the simulation takes longer.</p> <p>The sample time does not correlate to the actual time. For example, if the app samples every 0.1 seconds (Sample Time (ms) = 100) and runs for 10 seconds, the amount of elapsed actual time might be less than the 10 seconds of elapsed simulation time. Any apparent synchronization between the sample time and actual time is coincidental.</p> <p>Default: 10</p>

Parameter	Description
Stop Condition	<p>Stop condition of simulation, specified as one of these values:</p> <ul style="list-style-type: none"> • First actor stops — Simulation stops when the first actor reaches the end of its trajectory. • Last actor stops — Simulation stops when the last actor reaches the end of its trajectory. • Set time — Simulation stops at the time specified by the Stop Time (s) parameter. <p>Default: First actor stops</p>
Stop Time (s)	<p>Stop time of simulation, in seconds, specified as a positive decimal scalar.</p> <p>To enable this parameter, set the Stop Condition parameter to Set time.</p> <p>Default: 0.1</p>
Use RNG Seed	<p>Select this parameter to use a random number generator (RNG) seed to reproduce the same results for each simulation. Specify the RNG seed as a nonnegative integer less than 2^{32}.</p> <p>Default: off</p>

Programmatic Use

`drivingScenarioDesigner` opens the **Driving Scenario Designer** app.

`drivingScenarioDesigner(scenarioFileName)` opens the app and loads the specified scenario MAT file into the app. This file must be a scenario file saved from the app. This file can include all roads, actors, and sensors in the scenario. It can also include only the roads and actors component, or only the sensors component.

If the scenario file is not in the current folder or not in a folder on the MATLAB path, specify the full path name. For example:

```
drivingScenarioDesigner('C:\Desktop\myDrivingScenario.mat');
```

You can also load prebuilt scenario files. Before loading a prebuilt scenario, add the folder containing the scenario to the MATLAB path. For an example, see “Generate Sensor Data from Scenario” on page 1-18.

`drivingScenarioDesigner(scenario)` loads the specified `drivingScenario` object into the app. The `ClassID` properties of actors in this object must correspond to these default **Class ID** parameter values in the app:

- 1 — Car
- 2 — Truck
- 3 — Bicycle
- 4 — Pedestrian
- 5 — Jersey Barrier
- 6 — Guardrail

When you create actors in the app, the actors with these **Class ID** values have a default set of dimensions, radar cross-section patterns, and other properties. The camera and radar sensors process detections differently depending on type of actor specified by the **Class ID** values.

When importing `drivingScenario` objects into the app, the behavior of the app depends on the `ClassID` of the actors in that scenario.

- If an actor has a `ClassID` of 0, the app returns an error. In `drivingScenario` objects, a `ClassID` of 0 is reserved for an object of an unknown or unassigned class. The app does not recognize or use this value. Assign these actors one of the app **Class ID** values and import the `drivingScenario` object again.
- If an actor has a nonzero `ClassID` that does not correspond to a **Class ID** value, the app returns an error. Either change the `ClassID` of the actor or add a new actor class to the app. On the app toolbar, select **Add Actor > New Actor Class**.
- If an actor has properties that differ significantly from the properties of its corresponding **Class ID** actor, the app returns a warning. The `ActorID` property referenced in the warning corresponds to the ID value of an actor in the list at the top of the **Actors** tab. The ID value precedes the actor name. To address this warning, consider updating the actor properties or its `ClassID` value. Alternatively, consider adding a new actor class to the app.

`drivingScenarioDesigner(____, sensors)` loads the specified sensors into the app, using any of the previous syntaxes. Specify `sensors` as a `drivingRadarDataGenerator`, `visionDetectionGenerator`, `lidarPointCloudGenerator` or `insSensor` object, or as a cell array of such objects. If you specify `sensors` along with a scenario file that contains sensors, the app does not import the sensors from the scenario file.

For an example of importing sensors, see “Import Programmatic Driving Scenario and Sensors” on page 1-21.

Limitations

Clothoid Import/Export Limitations

- Driving scenarios presently support only the clothoid interpolated roads. When you import roads created using other geometric interpolation methods, the generated road shapes might contain inaccuracies.

Heading Limitations to Road Group Centers

- When you load a `drivingScenario` object containing a road group of road segments with specified headings into the **Driving Scenario Designer** app, the generated road network might contain inaccuracies. These inaccuracies occur because the app does not support heading angle information in the **Road Group Centers** table.

Parking Lot Limitations

- The importing of parking lots created using the `parkingLot` function is not supported. If you import a scenario containing a parking lot into the app, the app omits the parking lot from the scenario.

Sensor Import/Export Limitations

- When you import a `drivingRadarDataGenerator` sensor that reports clustered detections or tracks into the app and then export the sensor to MATLAB or Simulink, the exported sensor object or block reports unclustered detections. This change in reporting format occurs because the app supports the generation of unclustered detections only.

OpenStreetMap — Import Limitations

When importing OpenStreetMap data, road and lane features have these limitations:

- Lane-level information is not imported from OpenStreetMap roads. Lane specifications are based only on the direction of travel specified in the OpenStreetMap road network, where:
 - One-way roads are imported as single-lane roads with default lane specifications. These lanes are programmatically equivalent to `lanespec(1)`.
 - Two-way roads are imported as two-lane roads with bidirectional travel and default lane specifications. These lanes are programmatically equivalent to `lanespec([1 1])`.

The table shows these differences in the OpenStreetMap road network and the road network in the imported driving scenario.

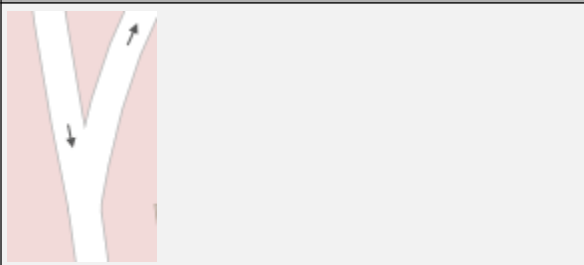
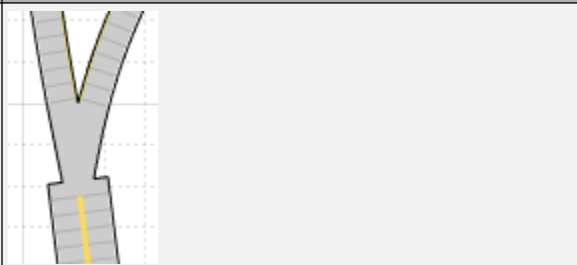
OpenStreetMap Road Network	Imported Driving Scenario
	

- When importing OpenStreetMap road networks that specify elevation data, if elevation data is not specified for all roads being imported, then the generated road network might contain inaccuracies and some roads might overlap.
- OpenStreetMap files containing large road networks can take a long time to load. In addition, these road networks can make some of the app options unusable. To avoid this limitation, import files that contain only an area of interest, typically smaller than 20 square kilometers.
- The basemap used in the app can have slight differences from the map used in the OpenStreetMap service. Some imported road issues might also be due to missing or inaccurate map data in the OpenStreetMap service. To check whether the data is missing or inaccurate due to the map service, consider viewing the map data on an external map viewer.

HERE HD Live Map — Import Limitations

- Importing HERE HDLM roads with lanes of varying widths is not supported. In the generated road network, each lane is set to have the maximum width found along its entire length. Consider a HERE HDLM lane with a width that varies from 2 to 4 meters along its length. In the generated road network, the lane width is 4 meters along its entire length. This modification to road networks can sometimes cause roads to overlap in the driving scenario.

- The basemap used in the app might have slight differences from the map used in the HERE HDLM service.
- Some issues with the imported roads might be due to missing or inaccurate map data in the HERE HDLM service. For example, you might see black lines where roads and junctions meet. To check where the issue stems from in the map data, use the HERE HD Live Map Viewer to view the geometry of the HERE HDLM road network. This viewer requires a valid HERE license. For more details, see the HERE Technologies website.

HERE HD Live Map – Route Selection Limitations

When selecting HERE HD Live Map roads to import from a region of interest, the maximum allowable size of the region is 20 square kilometers. If you specify a driving route that is greater than 20 square kilometers, the app draws a region that is optimized to fit as much of the beginning of the route as possible into the display. This figure shows an example of a region drawn around the start of a route that exceeds this maximum size.

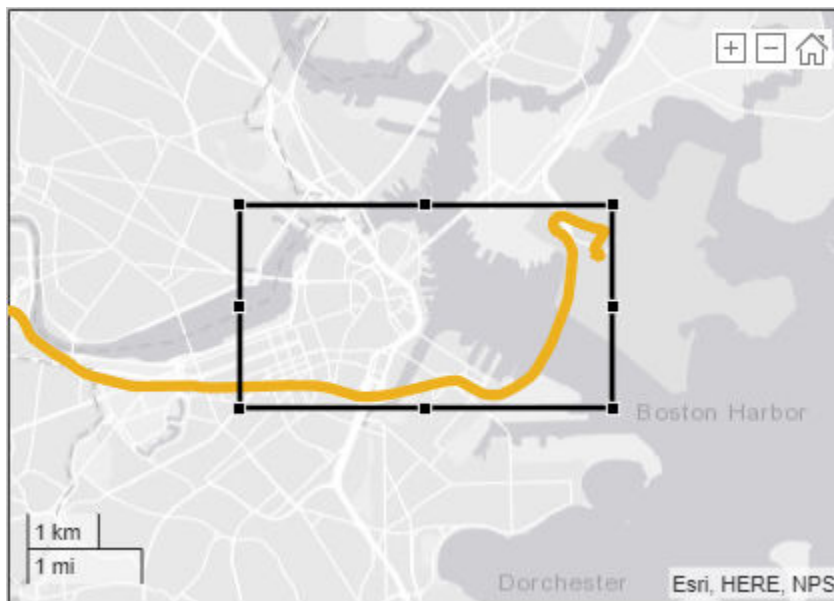

Zenrin Japan Map API 3.0 (Itsumo NAVI API 3.0) – Import Limitations

When you import Zenrin Japan Map API 3.0 (Itsumo NAVI API 3.0) data, the generated road network has these limitations. As a result of these limitations, the generated network might contain inaccuracies and the roads might overlap.

- The generated road network uses road elevation data when the Zenrin Japan Map API 3.0 (Itsumo NAVI API 3.0) provides it. Otherwise, the generated network uses terrain elevation data provided by the service.
- When the Zenrin Japan Map API 3.0 (Itsumo NAVI API 3.0) service provides information using a range, such as by specifying a road with two to three lanes or a road between 3–5.5 meters wide, the generated road network uses scalar values instead. Consider a Zenrin Japan Map API 3.0 (Itsumo NAVI API 3.0) road that has two to three lanes. The generated road network has two lanes.
- Lanes within roads in the generated network have a uniform width. Consider a road that is 4.25 meters wide with two lanes. In the generated road network, each lane is 2.125 meters wide.

- Where possible, the generated road network uses road names provided by the Zenrin Japan Map API 3.0 (Itsumo NAVI API 3.0) service. Otherwise, the generated road network uses default names, such as Road1 and Road2.

Zenrin Japan Map API 3.0 (Itsumo NAVI API 3.0) – Route Selection Limitations

When selecting Zenrin Japan Map API 3.0 (Itsumo NAVI API 3.0) roads to import from a region of interest, the maximum allowable size of the region is 500 square meters. If you specify a driving route that is greater than 500 square meters, the app draws a region that is optimized to fit as much of the beginning of the route as possible into the display. This figure shows an example of a region drawn around the start of a route that exceeds this maximum size.



ASAM OpenDRIVE Import Limitations

- You can import only lanes, lane type information, and roads. The import of road objects and traffic signals is not supported.
- ASAM OpenDRIVE files containing large road networks can take up to several minutes to load. In addition, these road networks can cause slow interactions on the app canvas. Examples of large road networks include ones that model the roads of a city or ones with roads that are thousands of meters long.
- Lanes with variable widths are not supported. The width is set to the highest width found within that lane. For example, if a lane has a width that varies from 2 meters to 4 meters, the app sets the lane width to 4 meters throughout.
- When you import one-way roads with multiple lane specifications, the app supports only those segment taper positions that match the travel direction of lane. For example, the app supports importing only right taper position for the right lanes. Left or both types of taper position are not supported for right lanes.
- Roads with lane type information specified as driving, border, restricted, shoulder, and parking are supported. Lanes with any other lane type information are imported as border lanes.
- Lane marking styles Bott Dots, Curbs, and Grass are not supported. Lanes with these marking styles are imported as unmarked.

ASAM OpenDRIVE Export Limitations

- The cubic polynomial and the parametric cubic polynomial geometry types in the scenario are exported as spiral geometry types. This causes some variations in the exported road geometry if the road is a curved road.
- When segments of adjacent roads overlap with each other, the app does not export the overlapping segments of the roads.
- When a road with multiple lane specifications contains a taper between two road segments, the app exports the road without taper.
- When a road consisting of multiple segments is connected to a junction, the app does not export the road.
- The junctions of the road network are processed without lane connection information, so the junction shapes may not be accurate in the exported scenario.
- The app does not export any actor that is present either on a junction or on a road with multiple road segments.
- When a junction is not connected to any road, the app does not export such junction.

Euro NCAP Limitations

- Scenarios of speed assistance systems (SAS) are not supported. These scenarios require the detection of speed limits from traffic signs, which the app does not support.

3D Display Limitations

These limitations describe how **3D Display** visualizations differ from the cuboid visualizations that appear on the **Scenario Canvas**.

- Roads do not form junctions with unmarked lanes at intersections. The roads and their lane markings overlap.
- Not all actor or lane marking colors are supported. The 3D display matches the selected color to the closest available color that it can render.
- Lane type colors of nondriving lanes are not supported. If you select a nondriving lane type, in the 3D display, the lane displays as a driving lane.
- On the **Actors** tab, specified **Roll (°)** and **Pitch (°)** parameter values of an actor are ignored. In the **Waypoints** table, **z (m)** values (that is, elevation values) are also ignored. During simulation, actors follow the elevation and banking angle of the road surface.
- Multiple marking styles along a lane are not supported. The 3D display applies the first lane marking style of the first lane segment along the entire length of the lane.
- Actors with a **3D Display Type** of **Cuboid** do not move in the 3D display. During simulation, these actors remain stationary at their initial specified positions.

More About

Actor and Vehicle Positions and Dimensions

In driving scenarios, an actor is a cuboid (box-shaped) object with a specific length, width, and height. Actors also have a radar cross-section (RCS) pattern, specified in dBsm, which you can refine by setting angular azimuth and elevation coordinates. The position of an actor is defined as the center of its bottom face. This center point is used as the actor's rotational center, its point of contact with the ground, and its origin in its local coordinate system. In this coordinate system:

- The X-axis points forward from the actor.
- The Y-axis points left from the actor.
- The Z-axis points up from the ground.

Roll, pitch, and yaw are clockwise-positive when looking in the forward direction of the X-, Y-, and Z-axes, respectively.

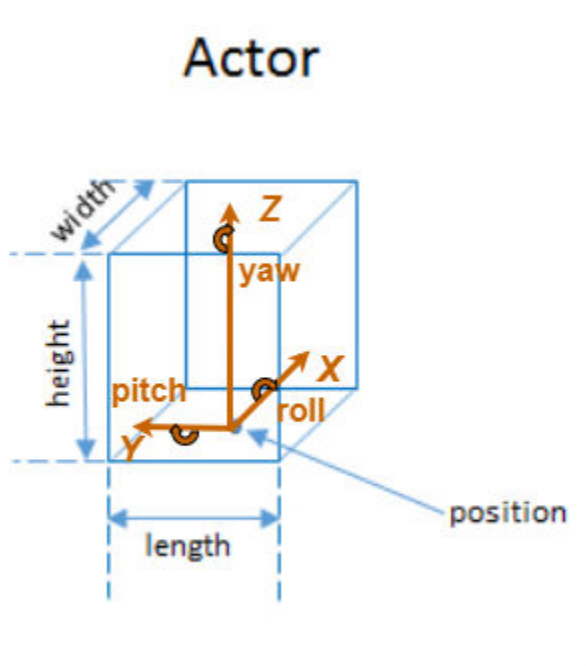

A vehicle is an actor that moves on wheels. Vehicles have three extra properties that govern the placement of their front and rear axle.

- Wheelbase — Distance between the front and rear axles
- Front overhang — Distance between the front of the vehicle and the front axle
- Rear overhang — Distance between the rear axle and the rear of the vehicle

Unlike other types of actors, the position of a vehicle is defined by the point on the ground that is below the center of its rear axle. This point corresponds to the natural center of rotation of the vehicle. As with nonvehicle actors, this point is the origin in the local coordinate system of the vehicle, where:

- The X-axis points forward from the vehicle.
- The Y-axis points left from the vehicle.
- The Z-axis points up from the ground.

Roll, pitch, and yaw are clockwise-positive when looking in the forward direction of the X-, Y-, and Z-axes, respectively.

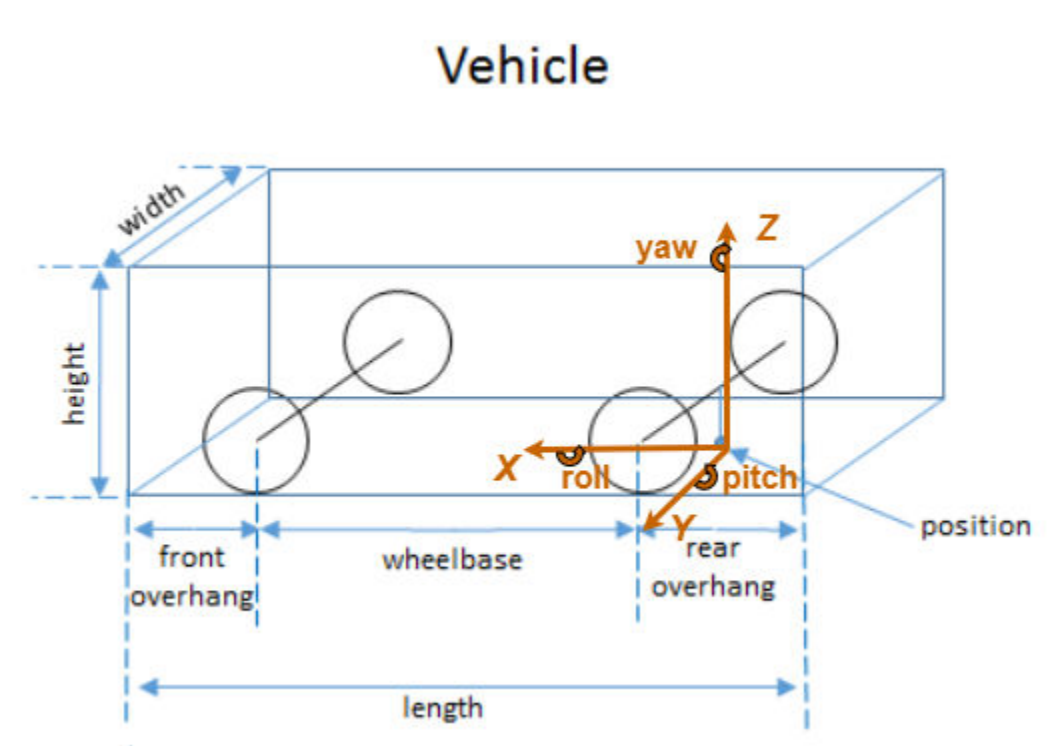

The origin (that is, the position) of cuboid vehicles differs from the origin of vehicles in the 3D simulation environment. In the 3D simulation environment, vehicle origins are on the ground, at the geometric center of the vehicle.







Cuboid Vehicle Origin	3D Simulation Vehicle Origin

For nonvehicle actors, the origins are identical and located at the bottom of the geometric center of the actors.

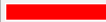
In Simulink, to convert a vehicle from the cuboid origin to the 3D simulation origin, use a Cuboid To 3D Simulation block. For more details about 3D simulation coordinates, see “Coordinate Systems for Unreal Engine Simulation in Automated Driving Toolbox”.

Color Specifications for Lanes and Markings

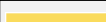
This table lists the named color options, the equivalent RGB triplets, and hexadecimal color codes that you can use for specifying the color of lanes and markings in a road.

Color Name	Short Name	RGB Triplet	Hexadecimal Color Code	Appearance
red	r	[1 0 0]	#FF0000	
green	g	[0 1 0]	#00FF00	
blue	b	[0 0 1]	#0000FF	
cyan	c	[0 1 1]	#00FFFF	
magenta	m	[1 0 1]	#FF00FF	
yellow	y	[0.98 0.86 0.36]	#FADB5C	
black	k	[0 0 0]	#000000	
white	w	[1 1 1]	#FFFFFF	

Draw Direction of Road and Numbering of Lanes

To create a road by using the road function, specify the road centers as a matrix input. The function creates a directed line that traverses the road centers, starting from the coordinates in the first row of the matrix and ending at the coordinates in the last row of the matrix. The coordinates in the first two rows of the matrix specify the draw direction of the road. These coordinates correspond to the first two consecutive road centers. The draw direction is the direction in which the roads render in the scenario plot.

To create a road by using the **Driving Scenario Designer** app, you can either specify the **Road Centers** parameter or interactively draw on the **Scenario Canvas**. For a detailed example, see “Create a Driving Scenario” on page 1-14. In this case, the draw direction is the direction in which roads render in the **Scenario Canvas**.

- For a road with a top-to-bottom draw direction, the difference between the x-coordinates of the first two consecutive road centers is positive.
- For a road with a bottom-to-top draw direction, the difference between the x-coordinates of the first two consecutive road centers is negative.

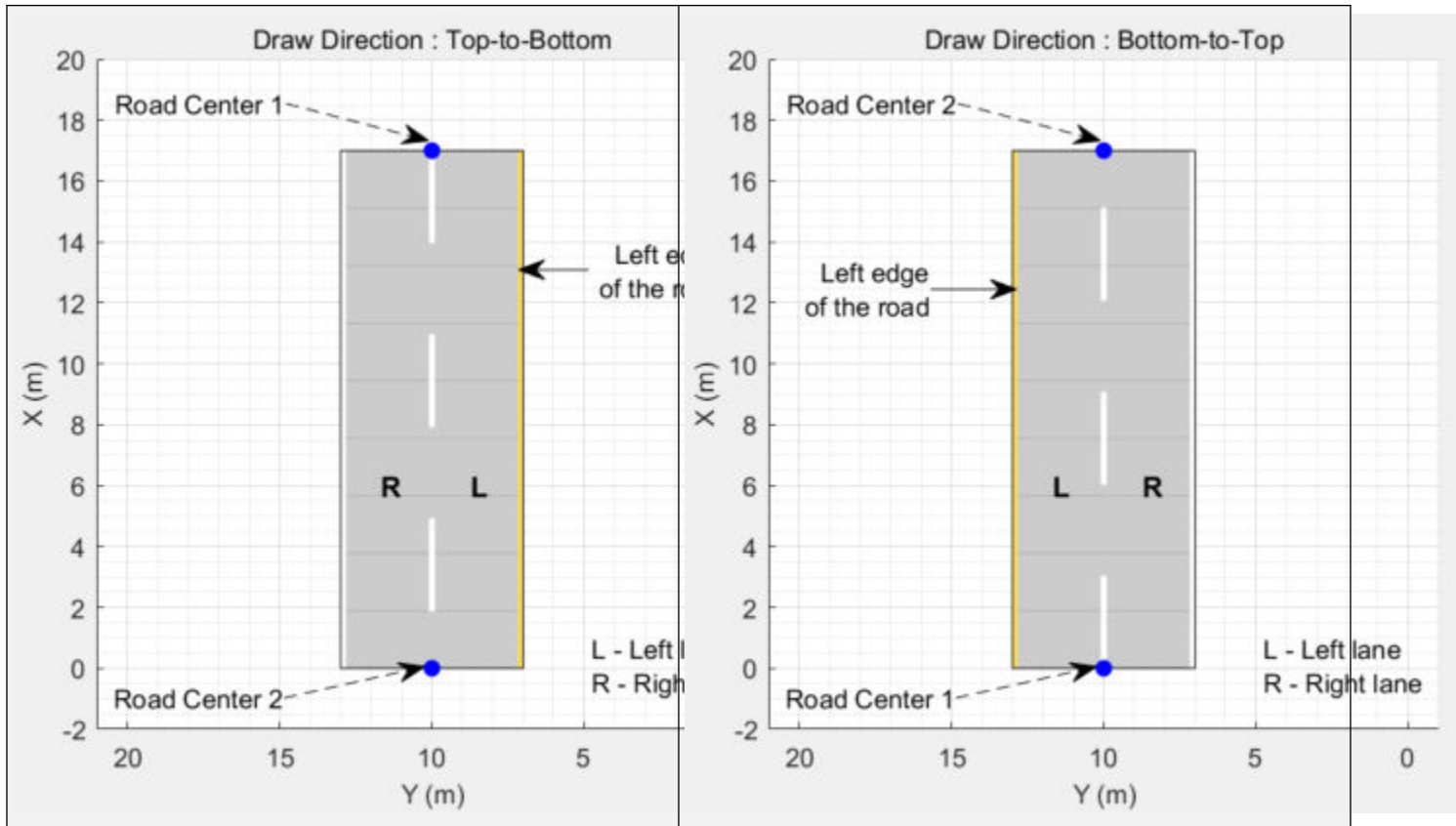

- For a road with a left-to-right draw direction, the difference between the y-coordinates of the first two consecutive road centers is positive.
- For a road with a right-to-left draw direction, the difference between the y-coordinates of the first two consecutive road centers is negative.

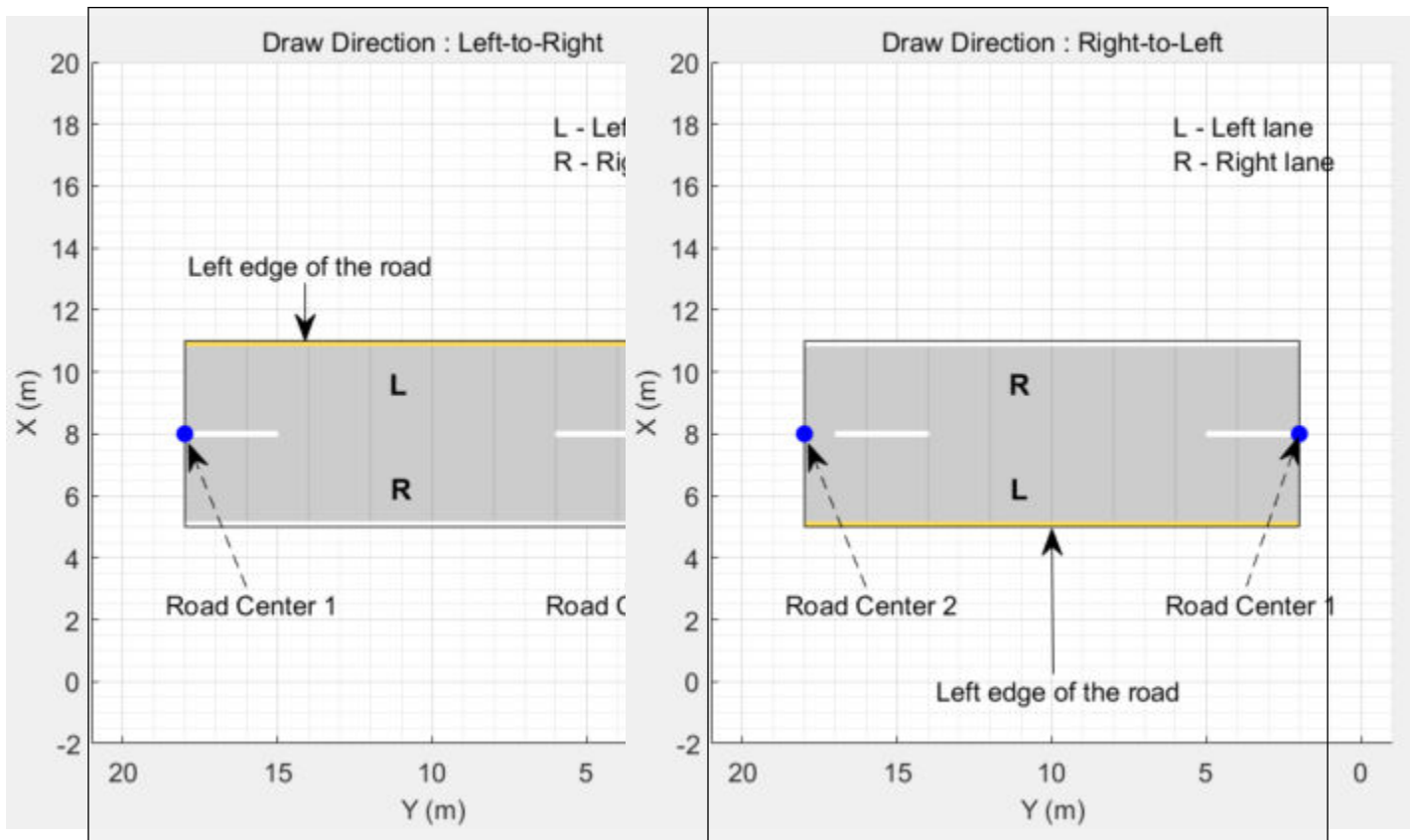

Numbering Lanes

Lanes must be numbered from left to right, with the left edge of the road defined relative to the draw direction of the road. For a one-way road, by default, the left edge of the road is a solid yellow marking which indicates the end of the road in transverse direction (direction perpendicular to draw direction). For a two-way road, by default, both edges are marked with solid white lines.

For example, these diagrams show how the lanes are numbered in a one-way and two-way road with a draw direction from top-to-bottom.

Numbering Lanes in a One-Way Road	Numbering Lanes in a Two-Way Road
--	--

Specify the number of lanes as a positive integer for a one-way road. If you set the integer value as 3, then the road has three lanes that travel in the same direction. The lanes are numbered starting from the left edge of the road.

1, 2, 3 denote the first, second, and third lanes of the road, respectively.

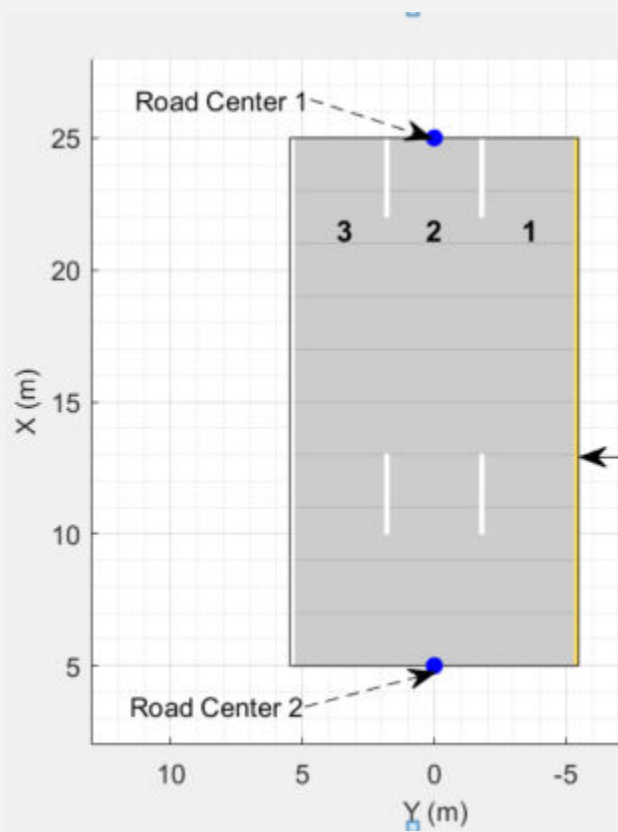

Specify the number of lanes as a two-element vector of positive integer for a two-way road. If you set the vector as [1 2], then the road has three lanes: two lanes traveling in one direction and one lane traveling in the opposite direction. Because of the draw direction, the road has one left lane and two right lanes. The lanes are numbered starting from the left edge of the road.

1L denote the only left lane of the road. **1R** and **2R** denote the first and second right lanes of the road, respectively.

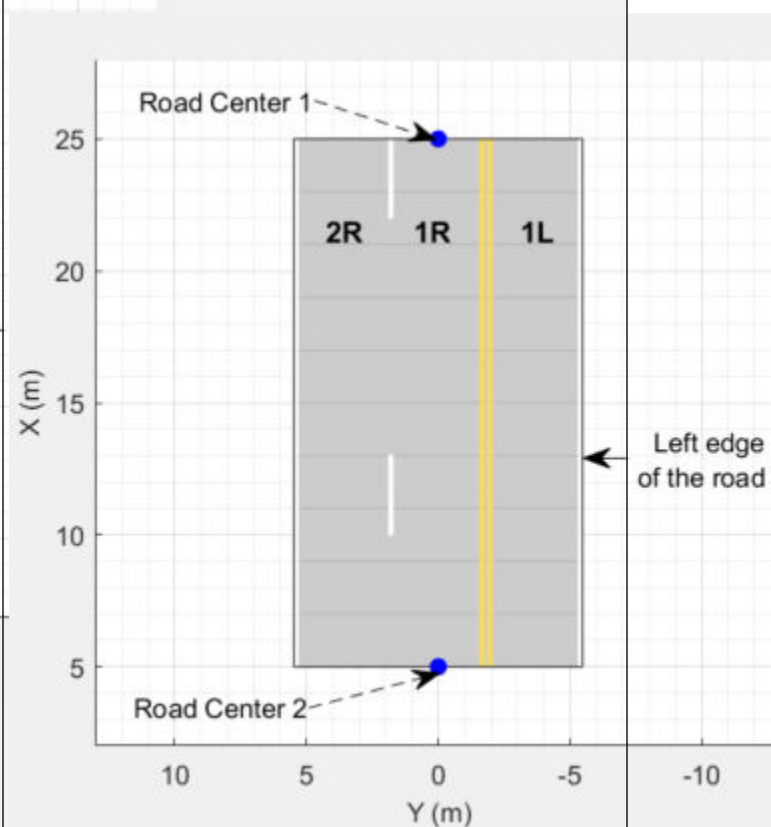

The lane specifications apply by the order in which the lanes are numbered.

Composite Lane Marking

A composite lane marking comprises two or more marker segments that define multiple marking types along a lane. The geometric properties for a composite lane marking include the geometric properties of each marking type and the normalized lengths of the marker segments.

The order in which the specified marker segments occur in a composite lane marking depends on the draw direction of the road. Each marker segment is a directed segment with a start point and moves towards the last road center. The first marker segment starts from the first road center and moves towards the last road center for a specified length. The second marker segment starts from the end point of the first marker segment and moves towards the last road center for a specified length. The

same process applies for each marker segment that you specify for the composite lane marking. You can set the normalized length for each of these marker segments by specifying the range input argument.

For example, consider a one-way road with two lanes. The second lane marking from the left edge of the road is a composite lane marking with marking types `Solid` and `Dashed`. The normalized range for each marking type is 0.5. The first marker segment is a solid marking and the second marker segment is a dashed marking. These diagrams show the order in which the marker segments apply for left-to-right and right-to-left draw directions of the road.

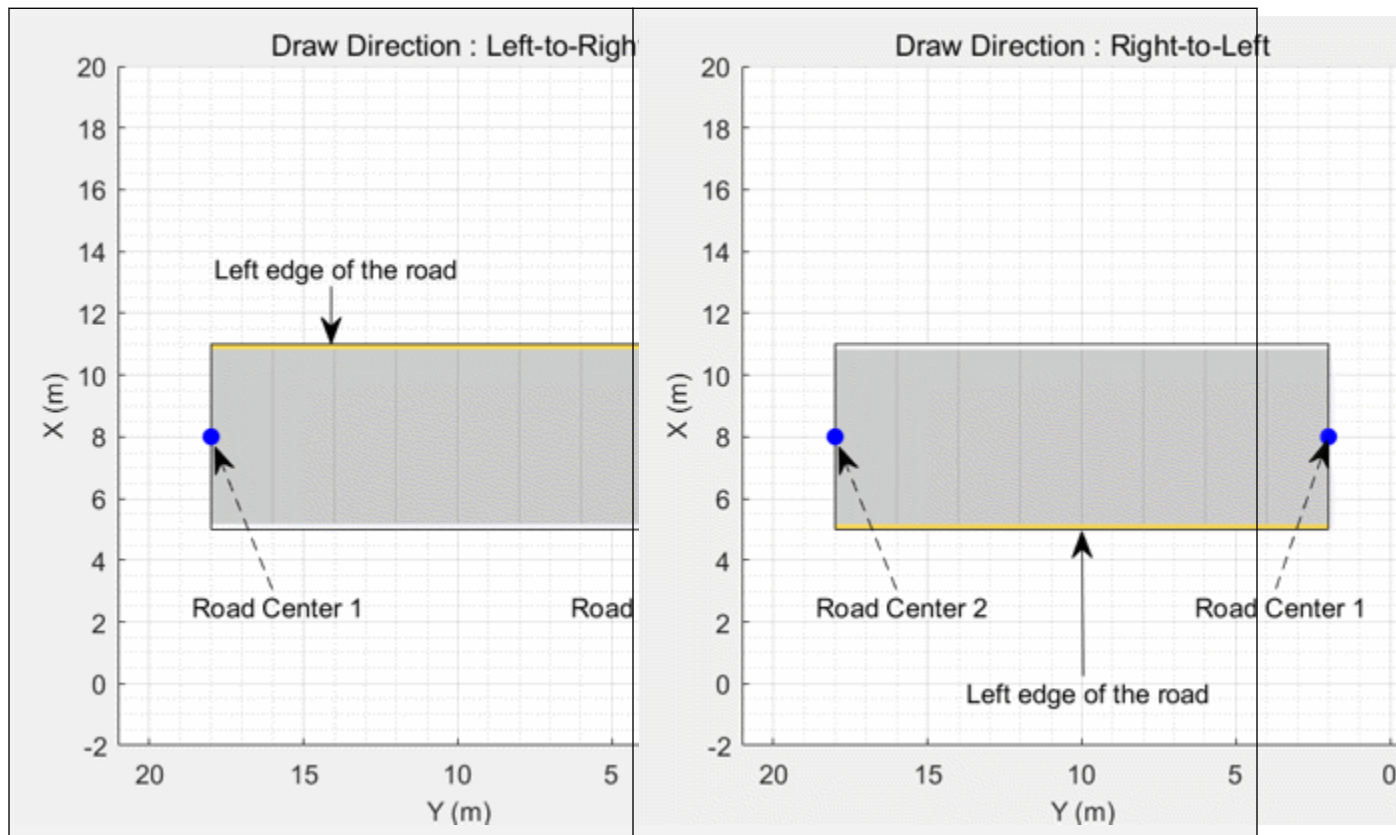

For information on the geometric properties of lane markings, see “Lane Specifications” on page 4-656.

Composite Lane Specification

A *composite lane specification* consists of an array of two or more lane specifications for a single road. Each lane specification defines a *road segment*, which is a section of the road with independent geometric properties, normalized range, and taper.

Each road segment is a directed segment that moves toward the final road center, with the first segment beginning at the first road center, the second segment starting where the first ends, and so on. The range of each road segment is a normalized distance that specifies a proportion of the total length of the road. When a road segment adds or drops lanes from a previous segment, the preceding segment tapers along a specified distance to accommodate the change in number of lanes.

When you render a road with composite lane specifications, the road segments render in the draw direction of the road. For example, consider a one-way road with two road segments and a default

normalized range of 0.5 for each road segment. The first road segment contains four lanes and the second segment contains only two lanes. The first segment tapers from four lanes to two lanes, dropping one lane from each side, as it approaches the halfway point of the road, which is the start point of the second segment. These diagrams show the direction in which the road segments render, and how the taper applies to the road, for both the left-to-right and right-to-left draw directions.

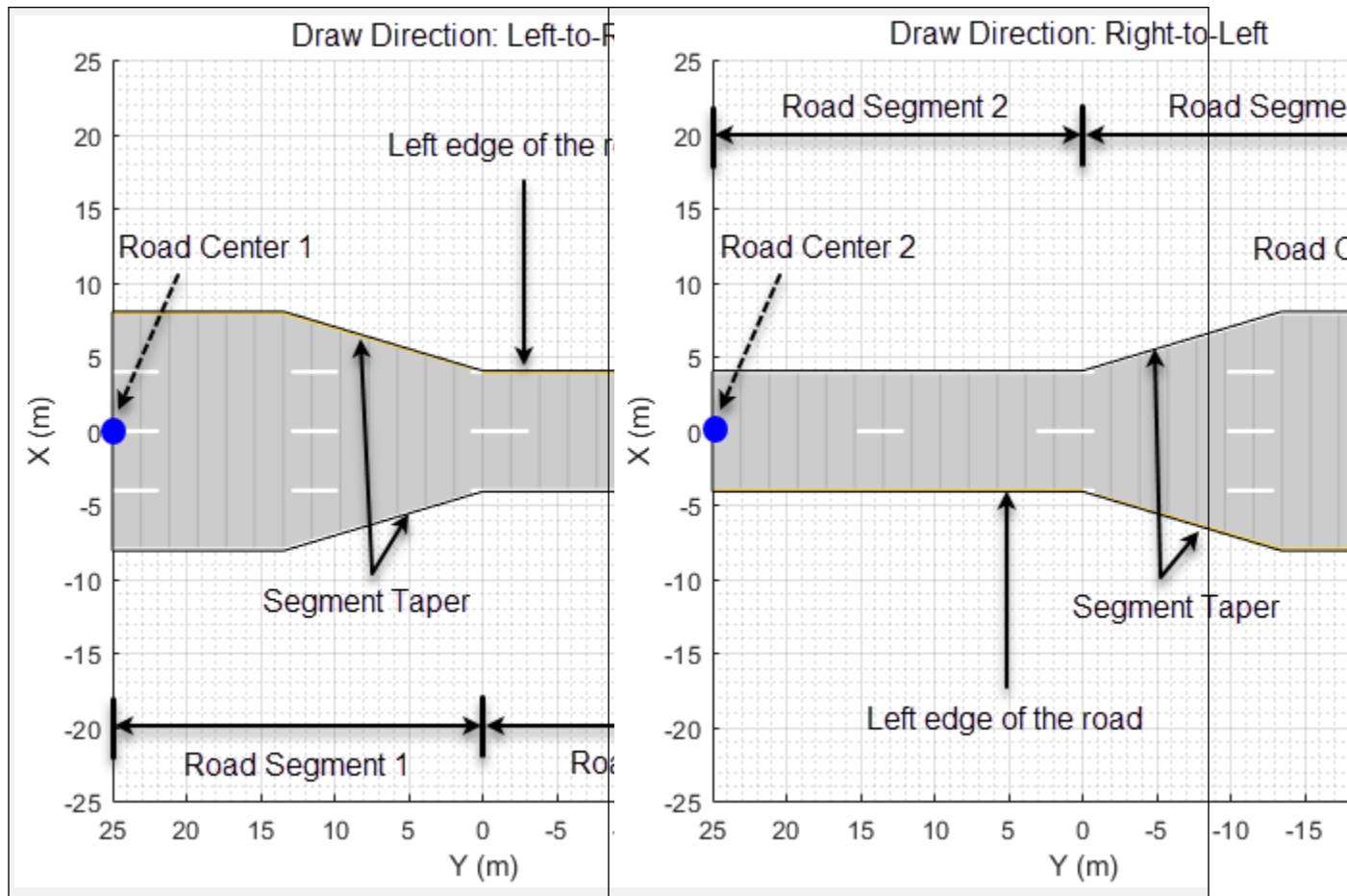

For information on the geometric properties of lanes, see “Lane Specifications” on page 4-656.

Tips

- When importing map data, the map regions you specify and the number of roads you select have a direct effect on app performance. To improve performance, specify the smallest map regions and select the fewest roads that you need to create your driving scenario.
- You can undo (press **Ctrl+Z**) and redo (press **Ctrl+Y**) changes you make on the scenario and sensor canvases. For example, you can use these shortcuts to delete a recently placed road center or redo the movement of a radar sensor. For more shortcuts, see “Keyboard Shortcuts and Mouse Actions for Driving Scenario Designer”
- In scenarios that contain many actors, to keep track of the ego vehicle, you can add an indicator around the vehicle. On the app toolbar, select **Display > Show ego indicator**. The circle around the ego vehicle highlights the location of the vehicle in the scenario. This circle is not a sensor coverage area.

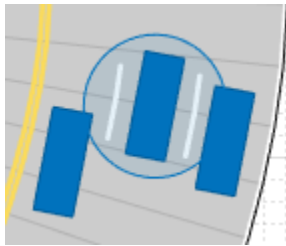

Version History

Introduced in R2018a

R2018b: Corrections to Image Width and Image Height camera parameters of Driving Scenario Designer

Behavior changed in R2018b

Starting in R2018b, in the **Camera Settings** group of the **Driving Scenario Designer** app, the **Image Width** and **Image Height** parameters set their expected values. Previously, **Image Width** set the height of images produced by the camera, and **Image Height** set the width of images produced by the camera.

If you are using R2018a, to produce the expected image sizes, transpose the values set in the **Image Width** and **Image Height** parameters.

References

- [1] European New Car Assessment Programme. *Euro NCAP Assessment Protocol - SA*. Version 8.0.2. January 2018.
- [2] European New Car Assessment Programme. *Euro NCAP AEB C2C Test Protocol*. Version 2.0.1. January 2018.
- [3] European New Car Assessment Programme. *Euro NCAP LSS Test Protocol*. Version 2.0.1. January 2018.

See Also

Apps

Bird's-Eye Scope

Blocks

Scenario Reader | Driving Radar Data Generator | Vision Detection Generator | Lidar Point Cloud Generator | Ultrasonic Detection Generator

Objects

drivingScenario | drivingRadarDataGenerator | visionDetectionGenerator | lidarPointCloudGenerator | insSensor | ultrasonicDetectionGenerator

Topics

“Create Driving Scenario Interactively and Generate Synthetic Sensor Data”

“Create Roads with Multiple Lane Specifications Using Driving Scenario Designer”

“Generate INS Sensor Measurements from Interactive Driving Scenario”
“Create Reverse Motion Driving Scenarios Interactively”
“Import ASAM OpenDRIVE Roads into Driving Scenario”
“Import HERE HD Live Map Roads into Driving Scenario”
“Import OpenStreetMap Data into Driving Scenario”
“Import Zenrin Japan Map API 3.0 (Itsumo NAVI API 3.0) into Driving Scenario”
“Generate Sensor Blocks Using Driving Scenario Designer”
“Keyboard Shortcuts and Mouse Actions for Driving Scenario Designer”
“Prebuilt Driving Scenarios in Driving Scenario Designer”

External Websites

Euro NCAP Safety Assist Protocols
ASAM OpenDRIVE
HERE Technologies
openstreetmap.org
ZENRIN DataCom CO., LTD.

Ground Truth Labeler

Label ground truth data for automated driving applications

Description

The **Ground Truth Labeler** app enables you to label ground truth data in multiple videos, image sequences, or lidar point clouds.

Using the app, you can:

- Simultaneously label multiple time-overlapped signals representing the same scene.
- Define rectangular region of interest (ROI) labels, polyline ROI labels, pixel ROI labels, cuboid ROI labels for lidar labeling, and scene label definitions. Use these labels to interactively label your ground truth data.
- Use the **Projected View** option to view the labels in top, front and side views simultaneously.
- Use the **XY View**, **YZ View**, and **XZ View** options to get the top view, front view, and side view of a point cloud scene, respectively.
- Use built-in detection or tracking algorithms to label ground truth data.
- Write, import, and use custom automation algorithms to automatically label ground truth data.
- Evaluate the performance of your label automation algorithms by using a visual summary.
- Export the ground truth labels as a `groundTruthMultisignal` object. You can use this object for system verification or for training an object detector or semantic segmentation network.
- Display time-synchronized signals, such as CAN bus data, by using the `driving.connector.Connector` API.

To learn more about this app, see “Get Started with Ground Truth Labelling”.

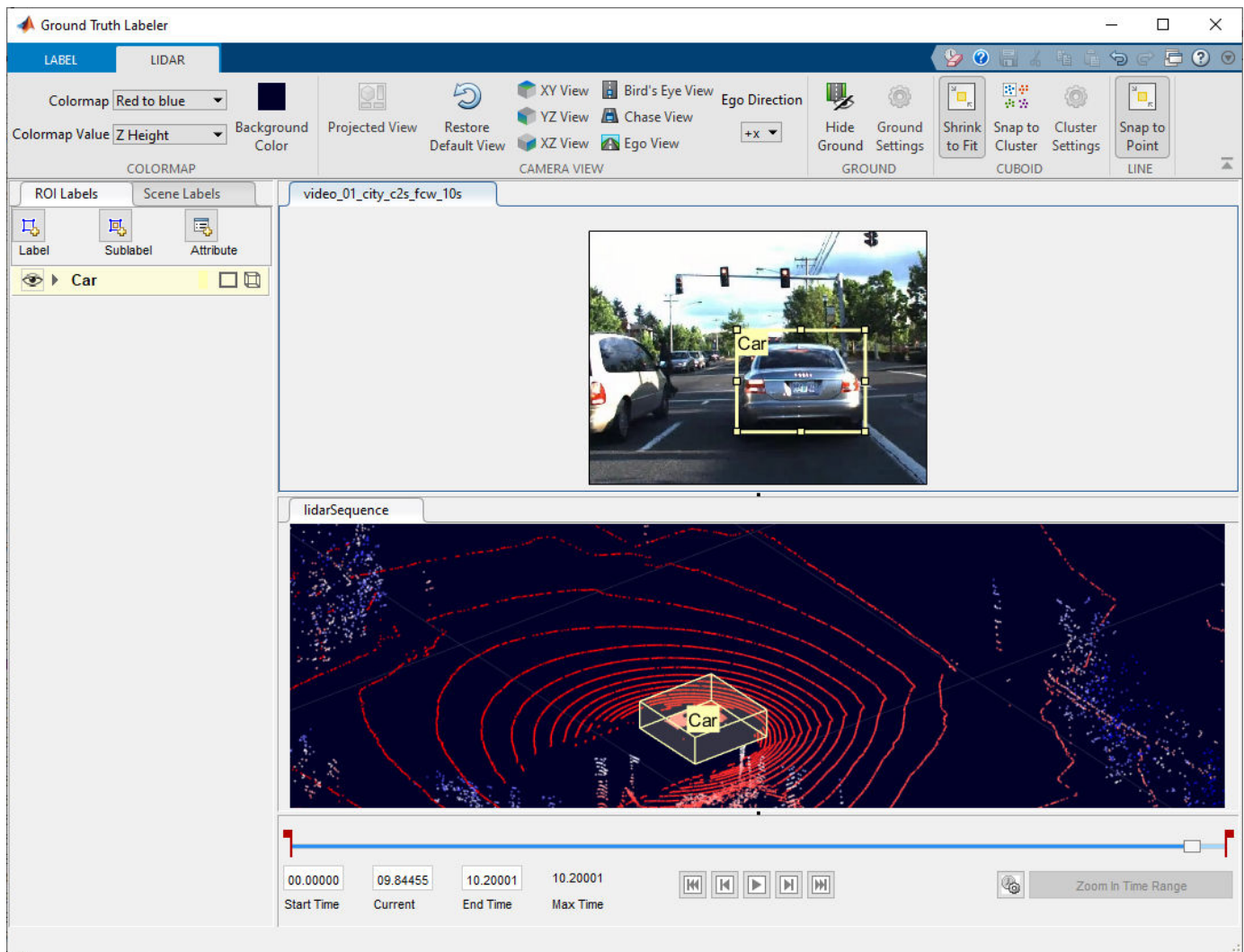

Open the Ground Truth Labeler App

- MATLAB Toolstrip: On the **Apps** tab, under **Automotive**, click the app icon.
- MATLAB command prompt: Enter `groundTruthLabeler`.

Examples

- “Get Started with Ground Truth Labelling”
- “Automate Ground Truth Labeling Across Multiple Signals”
- “Automate Ground Truth Labeling of Lane Boundaries”
- “Automate Ground Truth Labeling for Semantic Segmentation”
- “Automate Attributes of Labeled Objects”
- “Evaluate Lane Boundary Detections Against Ground Truth Data”

- “Evaluate and Visualize Lane Boundary Detections Against Ground Truth”

Programmatic Use

`groundTruthLabeler` opens a new session of the app, enabling you to label ground truth data.

`groundTruthLabeler(videoFileName)` opens the app and loads the input video. The video file must have an extension supported by `VideoReader`.

Example: `groundTruthLabeler('caltech_cordova1.avi')`

`groundTruthLabeler(imageSeqFolder)` opens the app and loads the image sequence from the input folder. An image sequence is an ordered set of images that resembles a video.

`imageSeqFolder` must be a string scalar or character vector that specifies the folder containing the image files. The image files must have extensions supported by `imformats` and are loaded in the order returned by the `dir` function.

`groundTruthLabeler(imageSeqFolder,timestamps)` opens the app and loads a sequence of images with their corresponding timestamps. `timestamps` must be a duration vector of the same length as the number of images in the sequence.

For example, load a sequence of road images and their corresponding timestamps into the app.

```
imageDir = fullfile(toolboxdir('driving'),'drivingdata','roadSequence');  
load(fullfile(imageDir,'timeStamps.mat'))  
groundTruthLabeler(imageDir,timeStamps)
```

`groundTruthLabeler(____, 'ConnectorTargetHandle', connector)` opens the app and loads both of these components:

- A video or image sequence signal, depending on the input argument combination you specify
- An external analysis or visualization tool that is time-synchronized with the specified signal

The `connector` input is a handle to a `driving.connector.Connector` class that implements the external tool.

For example, this syntax opens the app with a video signal and synchronized lidar visualization tool.

```
groundTruthLabeler('01_city_c2s_fcw_10s.mp4','ConnectorTargetHandle',@LidarDisplay);
```

When you have an external tool connected to a signal in the app, consider these tips.

- If you remove the signal that is connected to the tool, the app disconnects the tool and closes it.
- The signal connected to the tool must be the main signal, that is, the signal whose timestamps are used in the playback controls at the bottom of the app. If you change the main signal, the app disconnects the tool and closes it.
- If you start a new app session, the app disconnects the tool and closes it.

`groundTruthLabeler(sessionFile)` opens the app and loads a saved app session, `sessionFile`. The `sessionFile` input contains the path and file name. The MAT-file that `sessionFile` points to contains the saved session.

`groundTruthLabeler(gTruth)` opens the app and loads a `groundTruth` object. The ground truth object data source must be an image sequence, video, or a custom data source.

Limitations

- Lidar signals do not support line or pixel ROI labels.
- Pixel ROI labels do not support sublabels or attributes.
- Cuboid ROI labels do not support sublabels.
- The Label Summary window does not support sublabels or attributes
- Importing `groundTruth` object created from **Image Labeler** app is not supported.

More About

ROI Labels, Sublabels, and Attributes



On the left side of the app, the **ROI Labels** pane contains the region of interest (ROI) label definitions that you can mark on the frames. You can create label definitions directly from this pane. Alternatively, you can create label definitions programmatically by using a `labelDefinitionCreatorMultisignal` object and then import these label definitions into an app session.

The app supports the definition of ROI labels, sublabels, and attributes.

ROI Labels

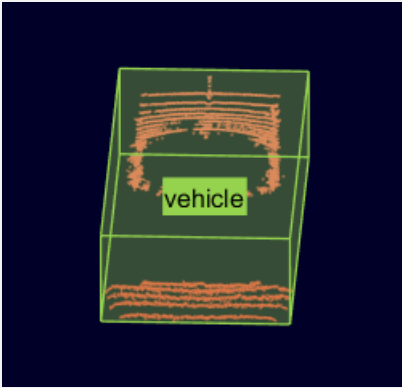
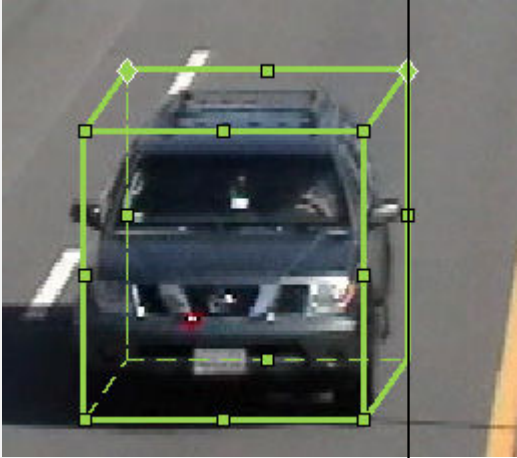
An ROI label is a label that corresponds to a region of interest (ROI) in a signal frame. The table describes the supported label types.

ROI Label	Description	Scene
<p>Rectangle/Cuboid</p>	<p>Draw rectangular or cuboidal ROI labels around objects, depending on the signal type.</p> <ul style="list-style-type: none"> In image signals, draw rectangular ROI labels (2-D bounding boxes). In lidar signals, draw cuboidal ROI labels (3-D bounding boxes). For more on lidar labeling, see “Label Lidar Point Clouds for Object Detection”. 	<p>Vehicles, pedestrians, road signs</p> <p>Rectangle:</p>  <p>Cuboid:</p> 
<p>Projected cuboid</p>	<p>Draw cuboidal ROI labels (3-D bounding boxes).</p>	

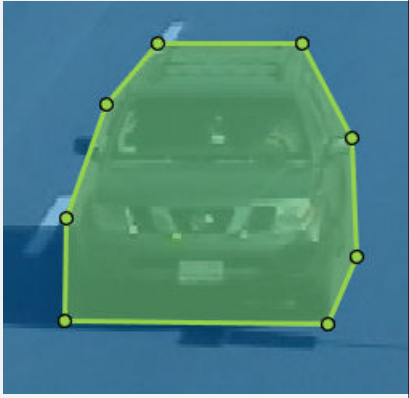

ROI Label	Description	Scene
Line	Draw linear ROI labels to represent lines. To draw a polyline ROI, use two or more points.	Lane boundaries, guard rails, road curbs 
Pixel label	Assign labels to pixels for semantic segmentation. You can label pixels manually using polygons, brushes, or flood fill. For more on pixel labeling, see “Label Pixels for Semantic Segmentation”.	Vehicles, road surface, trees, pavement 
Polygon	Draw polygon ROI labels. You can label distinct instances of the same class. For more information on drawing polygon ROI labels for instance and semantic segmentation networks, see “Label Objects Using Polygons”	Vehicles, road surface, trees, pavement 



ROI Sublabels

An ROI sublabel is an ROI label that belongs to a parent label. Use ROI sublabels to provide a greater level of detail about the ROIs in your labeled ground truth data. For example, a **vehicle** label might contain **headlight**, **licensePlate**, and **wheel** sublabels. You can create sublabels only for rectangular

and polyline labels. For more details about sublabels, see “Use Sublabels and Attributes to Label Ground Truth Data”.

Show or Hide Labels and Sublabels

You can show or hide the labels or sublabels in a labeled ground truth data by using the  icon on the **ROI Labels** pane. The  appears only after you define a label or sublabel. By default, the app displays all the labels and the sublabels.

To hide a label or sublabel, click on the  icon along side the label or sublabel name. The app hides the corresponding label or sublabel and displays the  icon.

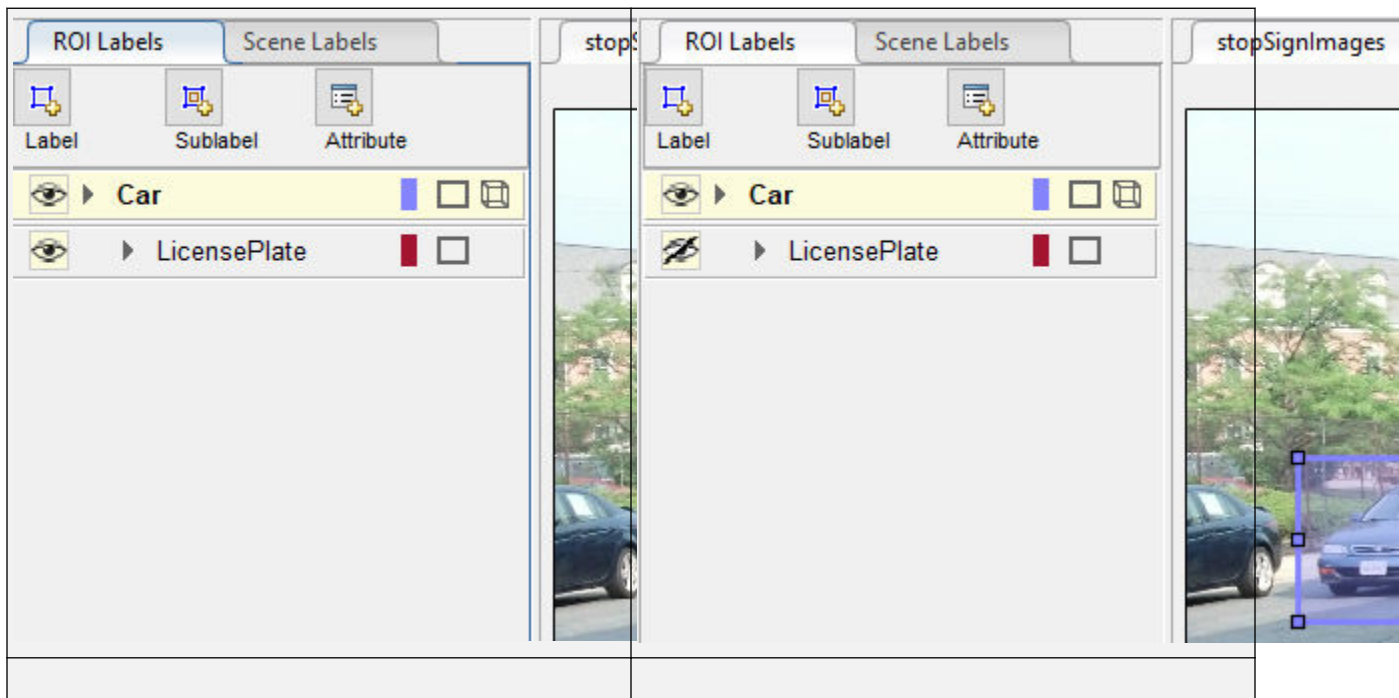

ROI Attributes

An ROI attribute specifies additional information about an ROI label or sublabel. For example, in a driving scene, attributes might include the type or color of a vehicle. The table describes the supported attribute types.

Attribute Type	Sample Attribute Definition	Sample Default Values
Numeric Value	Attribute Name <input type="text" value="numDoors"/> Default Scalar Value (Optional) <input type="text" value="4"/>	

Attribute Type	Sample Attribute Definition	Sample Default Values
String	Attribute Name <input type="text" value="color"/> String	<input type="text" value=""/>
Logical	Attribute Name <input type="text" value="inMotion"/> Logical	<input type="text" value="Nissan"/> <input type="text" value="True"/> <input type="text" value="Blue"/>
List	Attribute Name <input type="text" value="carType"/> List	<input type="text" value="4"/> <input type="text" value="Sedan"/> <input type="text" value="Sedan"/> <input type="text" value="Hatchback"/> <input type="text" value="Wagon"/>

For more details about attributes, see “Use Sublabels and Attributes to Label Ground Truth Data”.

Tips

- To avoid having to relabel ground truth with new labels, organize the labeling scheme you want to use before marking your ground truth.
- You can copy and paste labels between signals that are of the same type.

Algorithms

You can use label automation algorithms to speed up labeling within the app. To create your own label automation algorithm to use within the app, see “Create Automation Algorithm for Labeling”. You can also use one of the built-in algorithms by following these steps:

- 1 Import the data you want to label, and create at least one label definition.
- 2 On the app toolbar, click **Select Algorithm** and select one of the built-in automation algorithms.
- 3 If you imported multiple signals, click **Select Signals** and, in the Select Signals window, select one or more signals to automate. Click **OK**.
- 4 Click **Automate**, and then follow the automation instructions in the right pane of the automation window.

ACF Vehicle Detector

Detect and label vehicles using aggregate channel features (ACF). This algorithm is based on the `vehicleDetectorACF` function. To use this algorithm, you must define at least one rectangle ROI label. You do not need to draw any ROI labels.

To help improve the algorithm results, first click **Settings**. You can change any of these settings.

- The pretrained vehicle detector model that the algorithm uses — The 'full-view' model was trained using unoccluded images of the front, rear, left, and right sides of vehicles. The 'front-rear-view' model was trained using images of only the front and rear sides of the vehicle.
- The overlap ratio threshold, from 0 to 1, for detecting vehicles — When rectangle ROIs overlap by more than this threshold, the algorithm discards one of the ROIs.
- The classification score threshold for detecting vehicles — Increase the score to increase the prediction confidence of the algorithm. Rectangles with scores below this threshold are discarded.

You can also configure the detector with a calibrated monocular camera by importing a `monoCamera` object into the MATLAB workspace. Specify the length and width ranges of the vehicle in world units, such as meters.

ACF People Detector

Detect and label people using aggregate channel features (ACF). This algorithm is based on the `peopleDetectorACF` function. To use this algorithm, you must define at least one rectangle ROI label. You do not need to draw any ROI labels.

To help improve the algorithm results, first click **Settings**. You can change any of these settings.

- The pretrained people detector model that the algorithm uses — The 'inria-100x41' model was trained using the INRIA person data set. The 'caltech-50x21' model was trained using the Caltech Pedestrian data set.
- The overlap ratio threshold, from 0 to 1, for detecting people — When rectangle ROIs overlap by more than this threshold, the algorithm discards one of the ROIs.
- The classification score threshold for detecting people — Increase the score to increase the prediction confidence of the algorithm. Rectangles with scores below this threshold are discarded.

Point Tracker

Track and label one or more rectangle ROI labels over short intervals by using the Kanade-Lucas-Tomasi (KLT) algorithm. This algorithm is based on the `vision.PointTracker` System object™. To use this algorithm, you must define at least one rectangle ROI label, but you do not need to draw any ROI labels.

To change the feature detector used to obtain the initial points for tracking, click **Settings**. This table shows the feature detector options.

Feature Detector	Description	Equivalent Function
Minimum Eigen Value	Detect corners by using the minimum eigenvalue algorithm.	<code>detectMinEigenFeatures</code>
Harris	Detect corners by using the Harris-Stephens algorithm.	<code>detectHarrisFeatures</code>

Feature Detector	Description	Equivalent Function
FAST	Detect corners by using the features from accelerated segment test (FAST) algorithm.	detectFASTFeatures
BRISK	Detect features by using the binary robust invariant scalable keypoints (BRISK) algorithm.	detectBRISKFeatures
KAZE	Detect features by using nonlinear diffusion to construct a scale space of an image, and then detecting multiscale corner features (KAZE features) from that scale space.	detectKAZEFeatures
SURF	Detect blob features by using the speeded-up robust features (SURF) algorithm.	detectSURFFeatures
MSER	Detect regions by using the maximally stable extremal regions (MSER) algorithm.	detectMSERFeatures

Temporal Interpolator

Estimate rectangle ROIs or projected cuboid ROIs between frames by interpolating the ROI locations across the time range. To use this algorithm, you must draw a rectangle ROI or a projected cuboid ROI on a minimum of two frames: one at the beginning of the interval and one at the end of the interval. The interpolation algorithm estimates and draws ROIs in the intermediate frames.

Consider a video with 10 frames. The first frame has a rectangle ROI centered at [5, 5]. The 10th frame has a rectangle ROI centered at [25, 25]. At each frame, the algorithm moves the ROI 2 pixels in the x -direction and 2 pixels in the y -direction. Therefore, the algorithm centers the ROI at [7, 7] in the second frame, [9, 9] in the third frame, and so on, up to [23, 23] in the second-to-last frame.

Point Cloud Temporal Interpolator

Estimate cuboid ROIs between point cloud frames by interpolating the ROI locations across the time range. To use this algorithm, you must draw a cuboid ROI on a minimum of two frames: one at the beginning of the interval and one at the end of the interval. The interpolation algorithm estimates and draws ROIs in the intermediate frames.

Consider a point cloud sequence with 10 frames. The first frame has a cuboid ROI centered at [5, 5, 0]. The 10th frame has a cuboid ROI centered at [25, 25, 0]. At each frame, the algorithm moves the ROI 2 points in the x -direction, 2 points in the y -direction, and 0 points in the z -direction. Therefore, the algorithm centers the ROI at [7, 7, 0] in the second frame, [9, 9, 0] in the third frame, and so on, up to [23, 23, 0] in the second-to-last frame.

Lane Boundary Detector

Detect and label lane boundaries using an estimated bird's-eye-view projected image. To use this algorithm, you must define at least one line ROI label. You do not need to draw any ROI labels. To detect lane boundaries, the algorithm follows these steps:

- 1 It makes an initial guess at the placement of the lane boundaries in the image.
- 2 It transforms the ROI around the lanes into a bird's-eye view image to make the lanes parallel and remove distortion.
- 3 It uses this image to segment the lane boundaries.

To help improve the algorithm results, first click **Settings**. You can change any of these settings.

- The placement of the lane lines for generating the bird's-eye view image
- The ROI around the lanes, which you can expand to include more than just the ego lane boundaries in the image
- The pixel width of detected lane boundaries in the image

You can also change the number of lane boundaries that you want to detect. The default number of lane boundaries is 2.

Version History

Introduced in R2017a

R2020a: Ground Truth Labeler app no longer exports groundTruth objects

Behavior change in future release

If you import labels or open an app session created before R2020a, the **Ground Truth Labeler** exports labeled data as a `groundTruthMultisignal` object instead of as a `groundTruth` object.

If you do not need to label multiple signals simultaneously and do not require lidar labeling, import the labels or session into the **Video Labeler** app instead. The **Video Labeler** app continues to export `groundTruth` objects.

See Also

Apps

Image Labeler | **Video Labeler**

Objects

`groundTruthMultisignal` | `groundTruthDataSource` |
`labelDefinitionCreatorMultisignal`

Classes

`vision.labeler.loading.MultiSignalSource` | `vision.labeler.AutomationAlgorithm` |
`vision.labeler.mixin.Temporal` | `driving.connector.Connector`

Topics

“Get Started with Ground Truth Labelling”
“Automate Ground Truth Labeling Across Multiple Signals”
“Automate Ground Truth Labeling of Lane Boundaries”
“Automate Ground Truth Labeling for Semantic Segmentation”
“Automate Attributes of Labeled Objects”
“Evaluate Lane Boundary Detections Against Ground Truth Data”
“Evaluate and Visualize Lane Boundary Detections Against Ground Truth”
“Choose an App to Label Ground Truth Data”
“Keyboard Shortcuts and Mouse Actions for Ground Truth Labeler”

“Label Pixels for Semantic Segmentation”

“Label Lidar Point Clouds for Object Detection”

“Create Class for Loading Custom Ground Truth Data Sources”

“Create Automation Algorithm for Labeling”

“Share and Store Labeled Ground Truth Data”

Blocks

Bicycle Model

Implement a single track 3DOF rigid vehicle body to calculate longitudinal, lateral, and yaw motion

Description

The Bicycle Model block implements a rigid two-axle single track vehicle body model to calculate longitudinal, lateral, and yaw motion. The block accounts for body mass, aerodynamic drag, and weight distribution between the axles due to acceleration and steering. There are two types of Bicycle Model blocks.

Block	Implementation
<p>Bicycle Model - Velocity Input</p> <p>Bicycle Model - Velocity Input</p>	<ul style="list-style-type: none"> Block assumes that the external longitudinal velocity is quasi-steady state so the longitudinal acceleration is approximately zero. Since the motion is quasi-steady, the block calculates only lateral forces using the tire slip angles and linear cornering stiffness.
<p>Bicycle Model - Force Input</p> <p>Bicycle Model - Force Input</p>	<ul style="list-style-type: none"> Block uses the external longitudinal force to accelerate or brake the vehicle. Block calculates lateral forces using the tire slip angles and linear cornering stiffness.

To calculate the normal forces on the front and rear axles, the block uses rigid-body vehicle motion, suspension system forces, and wind and drag forces. The block resolves the force and moment components on the rigid vehicle body frame.

Ports

Input

WhlAngF — Wheel angle
scalar

Front wheel angle, in rad.

FxF — Force Input: Total longitudinal force on the front axle
scalar

Longitudinal force on the front axle, F_{x_F} , along vehicle-fixed x-axis, in N.

Bicycle Model - Force Input block input port.

FxR — Force Input: Total longitudinal force on the rear axle
scalar

Longitudinal force on the rear axle, F_{xR} , along vehicle-fixed x-axis, in N.

Bicycle Model - Force Input block input port.

xdotin — Velocity Input: Longitudinal velocity
scalar

Vehicle CG velocity along vehicle-fixed x-axis, in m/s.

Bicycle Model - Velocity Input block input port.

Output

Info — Bus signal
bus

Bus signal containing these block values.

Signal				Description	Value	Units
InertFrm	Cg	Disp	X	Vehicle CG displacement along the earth-fixed X-axis	Computed	m
			Y	Vehicle CG displacement along the earth-fixed Y-axis	Computed	m
			Z	Vehicle CG displacement along the earth-fixed Z-axis	0	m
		Vel	Xdot	Vehicle CG velocity along the earth-fixed X-axis	Computed	m/s
			Ydot	Vehicle CG velocity along the earth-fixed Y-axis	Computed	m/s
			Zdot	Vehicle CG velocity along the earth-fixed Z-axis	0	m/s
		Ang	phi	Rotation of the vehicle-fixed frame about the earth-fixed X-axis (roll)	0	rad
			theta	Rotation of the vehicle-fixed frame about the earth-fixed Y-axis (pitch)	0	rad
			psi	Rotation of the vehicle-fixed frame about the earth-fixed Z-axis (yaw)	Computed	rad

Signal				Description	Value	Units
	FrntAxl	Disp	X	Front wheel displacement along the earth-fixed X-axis	Computed	m
			Y	Front wheel displacement along the earth-fixed Y-axis	Computed	m
			Z	Front wheel displacement along the earth-fixed Z-axis	0	m
		Vel	Xdot	Front wheel velocity along the earth-fixed X-axis	Computed	m/s
			Ydot	Front wheel velocity along the earth-fixed Y-axis	Computed	m/s
			Zdot	Front wheel velocity along the earth-fixed Z-axis	0	m/s
	RearAxl	Disp	X	Rear wheel displacement along the earth-fixed X-axis	Computed	m
			Y	Rear wheel displacement along the earth-fixed Y-axis	Computed	m
			Z	Rear wheel displacement along the earth-fixed Z-axis	0	m
		Vel	Xdot	Rear wheel velocity along the earth-fixed X-axis	Computed	m/s
			Ydot	Rear wheel velocity along the earth-fixed Y-axis	Computed	m/s
			Zdot	Rear wheel velocity along the earth-fixed Z-axis	0	m/s
	Hitch	Disp	X	Hitch offset from axle plane along the earth-fixed X-axis	Computed	m
			Y	Hitch offset from center plane along the earth-fixed Y-axis	Computed	m
			Z	Hitch offset from axle plane along the earth-fixed Z-axis	Computed	m
Vel		Xdot	Hitch offset velocity from axle plane along the earth-fixed X-axis	Computed	m	

Signal			Description	Value	Units	
	Geom	Disp	Ydot	Hitch offset velocity from center plane along the earth-fixed Y-axis	Computed	m
			Zdot	Hitch offset velocity from axle plane along the earth-fixed Z-axis	Computed	m
		X	X	Vehicle chassis offset from axle plane along the earth-fixed X-axis	Computed	m
			Y	Vehicle chassis offset from center plane along the earth-fixed Y-axis	Computed	m
			Z	Vehicle chassis offset from axle plane along the earth-fixed Z-axis	Computed	m
		Vel	Xdot	Vehicle chassis offset velocity along the earth-fixed X-axis	Computed	m/s
			Ydot	Vehicle chassis offset velocity along the earth-fixed Y-axis	Computed	m/s
			Zdot	Vehicle chassis offset velocity along the earth-fixed Z-axis	Computed	m/s
		BdyFrm	Cg	Vel	xdot	Vehicle CG velocity along the vehicle-fixed x-axis
ydot	Vehicle CG velocity along the vehicle-fixed y-axis				Computed	m/s
zdot	Vehicle CG velocity along the vehicle-fixed z-axis				0	m/s
Ang	Beta			Body slip angle, β $\beta = \frac{V_y}{V_x}$	Computed	rad
AngVel	p			Vehicle angular velocity about the vehicle-fixed x-axis (roll rate)	0	rad/s
	q			Vehicle angular velocity about the vehicle-fixed y-axis (pitch rate)	0	rad/s
	r			Vehicle angular velocity about the vehicle-fixed z-axis (yaw rate)	Computed	rad/s

Signal				Description	Value	Units
	Acc	ax	ax	Vehicle CG acceleration along the vehicle-fixed x-axis	Computed	gn
			ay	Vehicle CG acceleration along the vehicle-fixed y-axis	Computed	gn
			az	Vehicle CG acceleration along the vehicle-fixed z-axis	0	gn
			xddot	Vehicle CG acceleration along the vehicle-fixed x-axis	Computed	m/s ²
			yddot	Vehicle CG acceleration along the vehicle-fixed y-axis	Computed	m/s ²
			zddot	Vehicle CG acceleration along the vehicle-fixed z-axis	0	m/s ²
		AngAcc	pdot	Vehicle angular acceleration about the vehicle-fixed x-axis	0	rad/s
			qdot	Vehicle angular acceleration about the vehicle-fixed y-axis	0	rad/s
			rdot	Vehicle angular acceleration about the vehicle-fixed z-axis	Computed	rad/s
		DCM	Direction cosine matrix			Computed
	Forces	Body	Fx	Net force on vehicle CG along the vehicle-fixed x-axis	Computed	N
			Fy	Net force on vehicle CG along the vehicle-fixed y-axis	Computed	N
			Fz	Net force on vehicle CG along the vehicle-fixed z-axis	0	N
		Ext	Fx	External force on vehicle CG along the vehicle-fixed x-axis	Computed	N
			Fy	External force on vehicle CG along the vehicle-fixed y-axis	Computed	N

Signal			Description	Value	Units	
		Fz	External force on vehicle CG along the vehicle-fixed z-axis	0	N	
	Hitch	Fx	Hitch force applied to body at the hitch location along the vehicle-fixed x-axis	Input	N	
		Fy	Hitch force applied to body at the hitch location along the vehicle-fixed y-axis	Input	N	
		Fz	Hitch force applied to body at the hitch location along the vehicle-fixed z-axis	Input	N	
	FrntAxl	Fx	Longitudinal force on front wheel, along the vehicle-fixed x-axis	Computed	N	
		Fy	Lateral force on front wheel along the vehicle-fixed y-axis	Computed	N	
		Fz	Normal force on front wheel, along the vehicle-fixed z-axis	Computed	N	
	RearAxl	Fx	Longitudinal force on rear wheel, along the vehicle-fixed x-axis	Computed	N	
		Fy	Lateral force on rear wheel along the vehicle-fixed y-axis	Computed	N	
		Fz	Normal force on rear wheel, along the vehicle-fixed z-axis	Computed	N	
	Tires	FrntTire	Fx	Front tire force, along the vehicle-fixed x-axis	Computed	N
			Fy	Front tire force, along the vehicle-fixed y-axis	Computed	N
			Fz	Front tire force, along the vehicle-fixed z-axis	Computed	N
		RearTire	FxFx	Rear tire force, along the vehicle-fixed x-axis	Computed	N
			Fy	Rear tire force, along the vehicle-fixed y-axis	Computed	N

Signal				Description	Value	Units		
			Fz	Rear tire force, along the vehicle-fixed z-axis	Computed	N		
		Drag	Fx	Drag force on vehicle CG along the vehicle-fixed x-axis	Computed	N		
			Fy	Drag force on vehicle CG along the vehicle-fixed y-axis	Computed	N		
			Fz	Drag force on vehicle CG along the vehicle-fixed z-axis	Computed	N		
		Grvty	Fx	Gravity force on vehicle CG along the vehicle-fixed x-axis	Computed	N		
			Fy	Gravity force on vehicle CG along the vehicle-fixed y-axis	Computed	N		
			Fz	Gravity force on vehicle CG along the vehicle-fixed z-axis	Computed	N		
	Moments	Body	Mx	Body moment on vehicle CG about the vehicle-fixed x-axis	0	N·m		
				My	Body moment on vehicle CG about the vehicle-fixed y-axis	Computed	N·m	
				Mz	Body moment on vehicle CG about the vehicle-fixed z-axis	0	N·m	
			Drag	Mx	Drag moment on vehicle CG about the vehicle-fixed x-axis	0	N·m	
					My	Drag moment on vehicle CG about the vehicle-fixed y-axis	Computed	N·m
					Mz	Drag moment on vehicle CG about the vehicle-fixed z-axis	0	N·m
			Ext	Mx	External moment on vehicle CG about the vehicle-fixed x-axis	0	N·m	
					My	External moment on vehicle CG about the vehicle-fixed y-axis	Computed	N·m

Signal			Description	Value	Units		
			Mz	External moment on vehicle CG about the vehicle-fixed z-axis	0	N·m	
		Hitch	Mx	Hitch moment at the hitch location about vehicle-fixed x-axis	0	N·m	
			My	Hitch moment at the hitch location about vehicle-fixed y-axis	Computed	N·m	
			Mz	Hitch moment at the hitch location about vehicle-fixed z-axis	0	N·m	
	FrntAxl	Disp	x	Front wheel displacement along the vehicle-fixed x-axis	Computed	m	
			y	Front wheel displacement along the vehicle-fixed y-axis	Computed	m	
			z	Front wheel displacement along the vehicle-fixed z-axis	Computed	m	
		Vel	x $\dot{}$	Front wheel velocity along the vehicle-fixed x-axis	Computed	m/s	
			y $\dot{}$	Front wheel velocity along the vehicle-fixed y-axis	Computed	m/s	
			z $\dot{}$	Front wheel velocity along the vehicle-fixed z-axis	0	m/s	
		Steer	WhlAngFL	Front left wheel steering angle	Computed	rad	
			WhlAngFR	Front right wheel steering angle	Computed	rad	
		RearAxl	Disp	x	Rear wheel displacement along the vehicle-fixed x-axis	Computed	m
				y	Rear wheel displacement along the vehicle-fixed y-axis	Computed	m
	z			Rear wheel displacement along the vehicle-fixed z-axis	Computed	m	
	Vel		x $\dot{}$	Rear wheel velocity along the vehicle-fixed x-axis	Computed	m/s	
			y $\dot{}$	Rear wheel velocity along the vehicle-fixed y-axis	Computed	m/s	

Signal				Description	Value	Units	
			zdot	Rear wheel velocity along the vehicle-fixed z-axis	0	m/s	
	Steer	WhlAngRL		Rear left wheel steering angle	Computed	rad	
		WhlAngRR		Rear right wheel steering angle	Computed	rad	
Hitch	Disp	x		Hitch offset from axle plane along the vehicle-fixed x-axis	Input	m	
		y		Hitch offset from center plane along the vehicle-fixed y-axis	Input	m	
		z		Hitch offset from axle plane along the earth-fixed z-axis	Input	m	
	Vel	xdot	t		Hitch offset velocity along the vehicle-fixed x-axis	Computed	m/s
		ydot	t		Hitch offset velocity along the vehicle-fixed y-axis	Computed	m/s
		zdot	t		Hitch offset velocity along the vehicle-fixed z-axis	Computed	m/s
	Pwr	Ext			Applied external power	Computed	W
		Hitch			Power loss due to hitch	Computed	W
		Drag			Power loss due to drag	Computed	W
Geom	Disp	x		Vehicle chassis offset from axle plane along the vehicle-fixed x-axis	Input	m	
		y		Vehicle chassis offset from center plane along the vehicle-fixed y-axis	Input	m	
		z		Vehicle chassis offset from axle plane along the earth-fixed z-axis	Input	m	
	Vel	xdot	t		Vehicle chassis offset velocity along the vehicle-fixed x-axis	Computed	m/s
		ydot	t		Vehicle chassis offset velocity along the vehicle-fixed y-axis	Computed	m/s
		zdot	t		Vehicle chassis offset velocity along the vehicle-fixed z-axis	0	m/s

Signal				Description	Value	Units
		Ang	Beta	Body slip angle, β $\beta = \frac{V_y}{V_x}$	Computed	rad

Signal			Description	Value	Units
PwrInfo	PwrTrnsfrd	PwrFxExt	Externally applied longitudinal force power	Computed	W
		PwrFyExt	Externally applied lateral force power	Computed	W
		PwrMzExt	Externally applied roll moment power	Computed	W
		PwrFwFx	Longitudinal force applied at the front axle power	Computed	W
		PwrFwFy	Lateral force applied at the front axle power	Computed	W
		PwrFwRx	Longitudinal force applied at the rear axle power	Computed	W
		PwrFwRy	Lateral force applied at the rear axle power	Computed	W
	PwrNotTrnsfrd	PwrFxDrag	Longitudinal drag force power	Computed	W
		PwrFyDrag	Lateral drag force power	Computed	W
		PwrMzDrag	Drag pitch moment power	Computed	W
	PwrStored	PwrStoredGrvty	Rate change in gravitational potential energy	Computed	W
		PwrStoredxdot	Rate of change of longitudinal kinetic energy	Computed	W
		PwrStoredydot	Rate of change of lateral kinetic energy	Computed	W
		PwrStoredr	Rate of change of rotational yaw kinetic energy	Computed	W

x_{dot} — Vehicle body longitudinal velocity
scalar

Vehicle CG velocity along vehicle-fixed x-axis, in m/s.

y_{dot} — Vehicle body lateral velocity
scalar

Vehicle CG velocity along vehicle-fixed y-axis, in m/s.

psi — Yaw
scalar

Rotation of the vehicle-fixed frame about earth-fixed Z-axis (yaw), in rad..

r — Yaw rate
scalar

Vehicle angular velocity, r , about the vehicle-fixed z-axis (yaw rate), in rad/s.

Parameters

Longitudinal

Number of wheels on front axle, NF — Front wheel count
2 (default) | scalar

Number of wheels on front axle, N_F . The value is dimensionless.

Number of wheels on rear axle, NR — Rear wheel count
2 (default) | scalar

Number of wheels on rear axle, N_R . The value is dimensionless.

Vehicle mass, m — Vehicle mass
2000 (default) | scalar

Vehicle mass, m , in kg.

Longitudinal distance from center of mass to front axle, a — Front axle distance
1.4 (default) | scalar

Horizontal distance a from the vehicle CG to the front wheel axle, in m.

Longitudinal distance from center of mass to rear axle, b — Rear axle distance
1.6 (default) | scalar

Horizontal distance b from the vehicle CG to the rear wheel axle, in m.

Vertical distance from center of mass to axle plane, h — Height
0.35 (default) | scalar

Height of vehicle CG above the axles, h , in m.

Longitudinal distance from center of mass to hitch, dh — Distance from CM to hitch
1 (default) | scalar

Longitudinal distance from center of mass to hitch, dh , in m.

Dependencies

To enable this parameter, on the **Input signals** pane, select **Hitch forces** or **Hitch moments**.

Vertical distance from hitch to axle plane, hh — Distance from hitch to axle plane
0.2 (default) | scalar

Vertical distance from hitch to axle plane, hh , in m.

Dependencies

To enable this parameter, on the **Input signals** pane, select **Hitch forces** or **Hitch moments**.

Initial inertial frame longitudinal position, X_o — Position
0 (default) | scalar

Initial vehicle CG displacement along earth-fixed X -axis, in m.

Initial longitudinal velocity, \dot{x}_o — Velocity
0 (default) | scalar

Initial vehicle CG velocity along vehicle-fixed x -axis, in m/s.

Dependencies

For the Vehicle Body 3DOF Single Track or Vehicle Body 3DOF Dual Track blocks, to enable this parameter, set **Axle forces** to one of these options:

- External longitudinal forces
- External forces

Lateral

Front tire corner stiffness, C_{y_f} — Stiffness
12e3 (default) | scalar

Front tire corner stiffness, C_{y_f} , in N/rad.

Dependencies

For the Vehicle Body 3DOF Single Track or Vehicle Body 3DOF Dual Track blocks, to enable this parameter:

- 1 Set **Axle forces** to one of these options:
 - External longitudinal velocity
 - External longitudinal forces
- 2 Clear **Mapped corner stiffness**.

Rear tire corner stiffness, C_{y_r} — Stiffness
11e3 (default) | scalar

Rear tire corner stiffness, C_{y_r} , in N/rad.

Dependencies

For the Vehicle Body 3DOF Single Track or Vehicle Body 3DOF Dual Track blocks, to enable this parameter:

- 1 Set **Axle forces** to one of these options:
 - External longitudinal velocity
 - External longitudinal forces

2 Clear Mapped corner stiffness.

Initial inertial frame lateral displacement, Y_o — Position
0 (default) | scalar

Initial vehicle CG displacement along earth-fixed Y-axis, in m.

Initial lateral velocity, $ydot_o$ — Velocity
0 (default) | scalar

Initial vehicle CG velocity along vehicle-fixed y-axis, in m/s.

Yaw

Yaw polar inertia, Izz — Inertia
4000 (default) | scalar

Yaw polar inertia, in $kg \cdot m^2$.

Initial yaw angle, psi_o — Psi rotation
0 (default) | scalar

Rotation of the vehicle-fixed frame about earth-fixed Z-axis (yaw), in rad.

Initial yaw rate, r_o — Yaw rate
0 (default) | scalar

Vehicle angular velocity about the vehicle-fixed z-axis (yaw rate), in rad/s.

Aerodynamic

Longitudinal drag area, Af — Effective vehicle cross-sectional area
2 (default) | scalar

Effective vehicle cross-sectional area, A_f , to calculate the aerodynamic drag force on the vehicle, in m^2 .

Longitudinal drag coefficient, Cd — Air drag coefficient
.3 (default) | scalar

Air drag coefficient, C_d . The value is dimensionless.

Longitudinal lift coefficient, Cl — Air lift coefficient
.1 (default) | scalar

Air lift coefficient, C_l . The value is dimensionless.

Longitudinal drag pitch moment, Cpm — Pitch drag
.1 (default) | scalar

Longitudinal drag pitch moment coefficient, C_{pm} . The value is dimensionless.

Relative wind angle vector, $beta_w$ — Wind angle
[0:0.01:0.3] (default) | vector

Relative wind angle vector, β_w , in rad.

Side force coefficient vector, Cs — Side force coefficient
[0:0.03:0.9] (default) | vector

Side force coefficient vector coefficient, C_s . The value is dimensionless.

Yaw moment coefficient vector, Cym — Yaw moment drag
[0:0.01:0.3] (default) | vector

Yaw moment coefficient vector coefficient, C_{ym} . The value is dimensionless.

Environment

Absolute air pressure, Pabs — Pressure
101325 (default) | scalar | scalar

Environmental absolute pressure, P_{abs} , in Pa.

Air temperature, Tair — Temperature
273 (default) | scalar

Environmental absolute temperature, T , in K.

Dependencies

To enable this parameter, clear **Air temperature**.

Gravitational acceleration, g — Gravity
9.81 (default) | scalar

Gravitational acceleration, g , in m/s^2 .

Nominal friction scaling factor, mu — Friction scale factor
1 (default) | scalar

Nominal friction scale factor, μ . The value is dimensionless.

Dependencies

For the Vehicle Body 3DOF Single Track or Vehicle Body 3DOF Dual Track blocks, to enable this parameter:

- 1 Set **Axle forces** to one of these options:
 - External longitudinal velocity
 - External longitudinal forces
- 2 Clear **External Friction**.

Simulation

Longitudinal velocity tolerance, xdot_tol — Tolerance
.01 (default) | scalar

Longitudinal velocity tolerance, in m/s.

Nominal normal force, Fznom — Normal force
5000 (default) | scalar

Nominal normal force, in N.

Dependencies

For the Vehicle Body 3DOF Single Track or Vehicle Body 3DOF Dual Track blocks, to enable this parameter, set **Axle forces** to one of these options:

- External longitudinal velocity
- External longitudinal forces

Geometric longitudinal offset from axle plane, longOff — Longitudinal offset
0 (default) | scalar

Vehicle chassis offset from axle plane along body-fixed x -axis, in m. When you use the 3D visualization engine, consider using the offset to locate the chassis independent of the vehicle CG.

Geometric lateral offset from center plane, latOff — Lateral offset
0 (default) | scalar

Vehicle chassis offset from center plane along body-fixed y -axis, in m. When you use the 3D visualization engine, consider using the offset to locate the chassis independent of the vehicle CG.

Geometric vertical offset from axle plane, vertOff — Vertical offset
0 (default) | scalar

Vehicle chassis offset from axle plane along body-fixed z -axis, in m. When you use the 3D visualization engine, consider using the offset to locate the chassis independent of the vehicle CG.

Wrap Euler angles, wrapAng — Selection
off (default) | on

Wrap the Euler angles to the interval $[-\pi, \pi]$. For vehicle maneuvers that might undergo vehicle yaw rotations that are outside of the interval, consider deselecting the parameter if you want to:

- Track the total vehicle yaw rotation.
- Avoid discontinuities in the vehicle state estimators.

Version History

Introduced in R2018a

References

- [1] Gillespie, Thomas. *Fundamentals of Vehicle Dynamics*. Warrendale, PA: Society of Automotive Engineers (SAE), 1992.

Cuboid To 3D Simulation

Convert actor from cuboid coordinates to 3D simulation coordinates

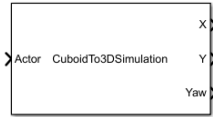

Libraries:

Automated Driving Toolbox / Driving Scenario and Sensor Modeling

Description

The Cuboid To 3D Simulation block converts a cuboid actor pose in world coordinates to the **X**, **Y**, and **Yaw** coordinates used by the Simulation 3D Vehicle with Ground Following block. Use the converted values to set vehicle positions within the 3D simulation environment for actors created using the **Driving Scenario Designer** app. The ground terrain of the scene determines the roll (x -axis rotation), pitch (y -axis rotation), and elevation (z -axis position) of the vehicle.

You can specify a bus containing a single actor pose or multiple actor poses. By default, the block converts the pose of the first actor in the bus. To specify the actor whose pose you want to convert, specify the ActorID of that actor.

In cuboid and 3D simulation driving scenarios, the coordinate systems are the same, but the origins of vehicles differ. In cuboid driving scenarios, the vehicle origin is on the ground, under the center of the rear axle. The block transforms this origin to the origin used in the 3D simulation environment, which is under the geometric center of the vehicle. The table shows the origin difference between the two environments. You must read the cuboid driving scenario using the Scenario Reader block.

Cuboid Vehicle Origin	3D Simulation Vehicle Origin

Ports

Input

Actor — Cuboid actor pose in world coordinates

Simulink bus containing MATLAB structure

Cuboid actor pose in world coordinates, specified as a Simulink bus containing a MATLAB structure.

To obtain this structure input, use the Scenario Reader block to read actors from a scenario. By default, the Scenario Reader block outputs actors in ego vehicle coordinates. To convert these poses from ego vehicle to world coordinates, use the Vehicle To World block.

The structure in this bus can contain a single actor pose or multiple actor poses.

Single-Pose Structure

To specify a single actor pose, the structure must contain these fields.

Field	Description
ActorID	Scenario-defined actor identifier, specified as a positive integer.
Position	Position of actor, specified as a real-valued vector of the form $[x \ y \ z]$. Units are in meters.
Velocity	Velocity (v) of actor in the x - y -, and z -directions, specified as a real-valued vector of the form $[v_x \ v_y \ v_z]$. Units are in meters per second.
Roll	Roll angle of actor, specified as a real-valued scalar. Units are in degrees.
Pitch	Pitch angle of actor, specified as a real-valued scalar. Units are in degrees.
Yaw	Yaw angle of actor, specified as a real-valued scalar. Units are in degrees.
AngularVelocity	Angular velocity (ω) of actor in the x -, y -, and z -directions, specified as a real-valued vector of the form $[\omega_x \ \omega_y \ \omega_z]$. Units are in degrees per second.

Multiple-Pose Structure

To specify multiple actor poses, the structure must contain these fields.

Field	Description	Type
NumActors	Number of actors	Nonnegative integer
Time	Current simulation time	Real-valued scalar
Actors	Actor poses	NumActors-length array of actor pose structures

Each actor pose structure in `Actors` must have these fields.

Field	Description
ActorID	Scenario-defined actor identifier, specified as a positive integer.
Position	Position of actor, specified as a real-valued vector of the form $[x\ y\ z]$. Units are in meters.
Velocity	Velocity (v) of actor in the x - y -, and z -directions, specified as a real-valued vector of the form $[v_x\ v_y\ v_z]$. Units are in meters per second.
Roll	Roll angle of actor, specified as a real-valued scalar. Units are in degrees.
Pitch	Pitch angle of actor, specified as a real-valued scalar. Units are in degrees.
Yaw	Yaw angle of actor, specified as a real-valued scalar. Units are in degrees.
AngularVelocity	Angular velocity (ω) of actor in the x -, y -, and z -directions, specified as a real-valued vector of the form $[\omega_x\ \omega_y\ \omega_z]$. Units are in degrees per second.

The block converts only one pose from the **Actors** array. To specify which pose to convert, select **Specify Actor ID**, and then specify the ActorID of the actor by using the **ActorID used for conversion** parameter.

Output

X — Longitudinal position of actor in 3D simulation coordinates
numeric scalar

Longitudinal position of the actor in 3D simulation coordinates, returned as a numeric scalar. Units are in meters.

In this coordinate system, when looking in the positive direction of the X -axis, the positive Y -axis points left, and the Z -axis points up.

To specify the X -position of a vehicle in the 3D simulation environment, connect this port to the **X** input port of a Simulation 3D Vehicle with Ground Following block.

Y — Lateral position of actor in 3D simulation coordinates
numeric scalar

Lateral position of the actor in 3D simulation coordinates, returned as a numeric scalar. Units are in meters.

In this coordinate system, when looking in the positive direction of the X -axis, the positive Y -axis points left, and the Z -axis points up.

To specify the Y -position of a vehicle in the 3D simulation environment, connect this port to the **Y** input port of a Simulation 3D Vehicle with Ground Following block.

Yaw — Yaw orientation angle of actor in 3D simulation coordinates
numeric scalar

Yaw orientation angle of the actor about the Z-axis in 3D simulation coordinates, returned as a numeric scalar. Units are in degrees.

In this coordinate system, when looking in the positive direction of the Z-axis, yaw is clockwise-positive. However, if you view the simulation from a 2D top-down perspective, then yaw is counterclockwise-positive, because you are viewing the scene along the negative Z-axis.

To specify the yaw orientation angle of a vehicle in the 3D simulation environment, connect this port to the **Yaw** input port of a Simulation 3D Vehicle with Ground Following block.

Parameters

Specify Actor ID — Enable ID specification of cuboid actor

off (default) | on

Select this parameter to enable the **ActorID used for conversion** parameter, where you can specify the ActorID of the cuboid actor pose to convert to 3D simulation coordinates.

If you clear this parameter, then the block converts the first actor pose in the input **Actor** bus.

ActorID used for conversion — ActorID value of cuboid actor

1 (default) | positive integer

ActorID value of the cuboid actor to convert to 3D simulation coordinates, specified as a positive integer. This parameter must be a valid ActorID from the input **Actor** bus.

Dependencies

To enable this parameter, select **Specify Actor ID**.

Simulate using — Type of simulation to run

Interpreted execution (default) | Code generation

- **Interpreted execution** — Simulate the model using the MATLAB interpreter. This option shortens startup time. In **Interpreted execution** mode, you can debug the source code of the block.
- **Code generation** — Simulate the model using generated C/C++ code. The first time you run a simulation, Simulink generates C/C++ code for the block. The C code is reused for subsequent simulations as long as the model does not change. This option requires additional startup time.

Version History

Introduced in R2020a

Extended Capabilities

C/C++ Code Generation

Generate C and C++ code using Simulink® Coder™.

See Also

Vehicle To World | World To Vehicle | Simulation 3D Vehicle with Ground Following | Scenario Reader

Topics

“Coordinate Systems in Automated Driving Toolbox”

“Coordinate Systems for Unreal Engine Simulation in Automated Driving Toolbox”

Detection Concatenation

Combine detection reports from different sensors

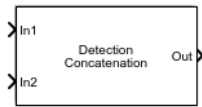

Libraries:

Automated Driving Toolbox
Sensor Fusion and Tracking Toolbox / Utilities

Description

The Detection Concatenation block combines detection reports from multiple sensors onto a single output bus. Concatenation is useful when detections from multiple sensor blocks are passed into a tracker block such as the Multi-Object Tracker block. You can accommodate additional sensors by changing the **Number of input sensors to combine** parameter to increase the number of input ports.

Ports

Input

In1, In2, ..., InN — Sensor detections to combine
Simulink buses containing MATLAB structures

Sensor detections to combine, where each detection is a Simulink bus containing a MATLAB structure. See “Create Nonvirtual Buses” (Simulink) for more details.

The structure has the form:

Field	Description	Type
NumDetections	Number of detections	integer
Detections	Object detections	Array of object detection structures. The first NumDetections of these detections are actual detections.

The fields of Detections are:

Field	Description	Type
Time	Measurement time	single or double
Measurement	Object measurements	single or double
MeasurementNoise	Measurement noise covariance matrix	single or double
SensorIndex	Unique ID of the sensor	single or double
ObjectClassID	Object classification ID	single or double

Field	Description	Type
MeasurementParameters	Parameters used by initialization functions of tracking filters	Simulink Bus
ObjectAttributes	Additional information passed to tracker	Simulink Bus

By default, the block includes two ports for input detections. To add more ports, use the **Number of input sensors to combine** parameter.

Output

Out — Combined sensor detections

Simulink bus containing MATLAB structure

Combined sensor detections from all input buses, returned as a Simulink bus containing a MATLAB structure. See “Create Nonvirtual Buses” (Simulink).

The structure has the form:

Field	Description	Type
NumDetections	Number of detections	integer
Detections	Object detections	Array of object detection structures. The first NumDetections of these detections are actual detections.

The fields of Detections are:

Field	Description	Type
Time	Measurement time	single or double
Measurement	Object measurements	single or double
MeasurementNoise	Measurement noise covariance matrix	single or double
SensorIndex	Unique ID of the sensor	single or double
ObjectClassID	Object classification ID	single or double
MeasurementParameters	Parameters used by initialization functions of tracking filters	Simulink Bus
ObjectAttributes	Additional information passed to tracker	Simulink Bus

The **Maximum number of reported detections** output is the sum of the **Maximum number of reported detections** of all input ports. The number of actual detections is the sum of the number of actual detections in each input port. The **ObjectAttributes** fields in the detection structure are the union of the **ObjectAttributes** fields in each input port.

Parameters

Number of input sensors to combine — Number of input sensor ports

2 (default) | positive integer

Number of input sensor ports, specified as a positive integer. Each input port is labeled **In1**, **In2**, ..., **InN**, where *N* is the value set by this parameter.

Data Types: double

Source of output bus name — Source of output bus name

Auto (default) | Property

Source of output bus name, specified as Auto or Property.

- If you select Auto, the block automatically generates a bus name.
- If you select Property, specify the bus name using the **Specify an output bus name** parameter.

Specify an output bus name — Name of output bus

no default

Dependencies

To enable this parameter, set the **Source of output bus name** parameter to Property.

Simulate using — Type of simulation to run

Interpreted execution (default) | Code generation

- **Interpreted execution** — Simulate the model using the MATLAB interpreter. This option shortens startup time. In **Interpreted execution** mode, you can debug the source code of the block.
- **Code generation** — Simulate the model using generated C/C++ code. The first time you run a simulation, Simulink generates C/C++ code for the block. The C code is reused for subsequent simulations as long as the model does not change. This option requires additional startup time.

Version History

Introduced in R2017b

R2023a: Simulink buses do not show in workspace

Behavior change in future release

As of R2023a, the Simulink buses created by this block no longer show in MATLAB workspace.

Extended Capabilities

C/C++ Code Generation

Generate C and C++ code using Simulink® Coder™.

See Also

Apps

Bird's-Eye Scope

Blocks

Scenario Reader | Driving Radar Data Generator | Vision Detection Generator | Multi-Object Tracker

Topics

“Create Nonvirtual Buses” (Simulink)

INS

Simulate INS sensor

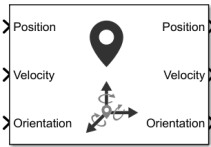

Libraries:

Navigation Toolbox / Multisensor Positioning / Sensor Models
 Automated Driving Toolbox / Driving Scenario and Sensor Modeling
 Sensor Fusion and Tracking Toolbox / Multisensor Positioning / Sensor Models
 UAV Toolbox / UAV Scenario and Sensor Modeling

Description

The block simulates an INS sensor, which outputs noise-corrupted position, velocity, and orientation based on the corresponding inputs. The block can also optionally output acceleration and angular velocity based on the corresponding inputs. To change the level of noise present in the output, you can vary the roll, pitch, yaw, position, velocity, acceleration, and angular velocity accuracies. The accuracy is defined as the standard deviation of the noise.

Ports

Input

Position — Position of INS sensor
 N -by-3 real-valued matrix

Position of the INS sensor relative to the navigation frame, in meters, specified as an N -by-3 real-valued matrix. N is the number of samples.

Data Types: `single` | `double`

Velocity — Velocity of INS sensor
 N -by-3 real-valued matrix of scalar

Velocity of the INS sensor relative to the navigation frame, in meters per second, specified as an N -by-3 real-valued matrix. N is the number of samples.

Data Types: `single` | `double`

Orientation — Orientation of INS sensor
 3 -by- 3 -by- N real-valued array | N -by-4 real-valued matrix | N -by-3 matrix of Euler angles

Orientation of the INS sensor relative to the navigation frame, specified as one of these formats:

- A 3 -by- 3 -by- N real-valued array, where each page of the array (3 -by- 3 matrix) is a rotation matrix.
- An N -by-4 real-valued matrix, where each row of the matrix is the four elements of a quaternion.
- An N -by-3 matrix of Euler angles, where each row of the matrix is the three Euler angles corresponding to the z - y - x rotation convention.

N is the number of samples.

Data Types: `single` | `double`

Acceleration — Acceleration of INS sensor*N*-by-3 real-valued matrix

Acceleration of the INS sensor relative to the navigation frame, in meters per second squared, specified as an *N*-by-3 real-valued matrix. *N* is the number of samples.

Dependencies

To enable this input port, select **Use acceleration and angular velocity**.

Data Types: `single` | `double`

AngularVelocity — Angular velocity of INS sensor*N*-by-3 real-valued matrix

Angular velocity of the INS sensor relative to the navigation frame, in degrees per second, specified as an *N*-by-3 real-valued matrix. *N* is the number of samples.

Dependencies

To enable this input port, select **Use acceleration and angular velocity**.

Data Types: `single` | `double`

HasGNSSFix — Enable GNSS fix*N*-by-1 logical vector

Enable GNSS fix, specified as an *N*-by-1 logical vector. *N* is the number of samples. Specify this input as `false` to simulate the loss of a GNSS receiver fix. When a GNSS receiver fix is lost, position measurements drift at a rate specified by the **Position error factor** parameter.

Dependencies

To enable this input port, select **Enable HasGNSSFix port**.

Data Types: `single` | `double`

Output**Position** — Position of INS sensor*N*-by-3 real-valued matrix

Position of the INS sensor relative to the navigation frame, in meters, returned as an *N*-by-3 real-valued matrix. *N* is the number of samples in the input.

Data Types: `single` | `double`

Velocity — Velocity of INS sensor*N*-by-3 real-valued matrix

Velocity of the INS sensor relative to the navigation frame, in meters per second, returned as an *N*-by-3 real-valued matrix. *N* is the number of samples in the input.

Data Types: `single` | `double`

Orientation — Orientation of INS sensor3-by-3-by-*N* real-valued array | *N*-by-4 real-valued matrix

Orientation of the INS sensor relative to the navigation frame, returned as one of the formats:

- A 3-by-3-by- N real-valued array, where each page of the array (3-by-3 matrix) is a rotation matrix.
- An N -by-4 real-valued matrix, where each row of the matrix is the four elements of a quaternion.
- An N -by-3 matrix of Euler angles, where each row of the matrix is the three Euler angles corresponding to the z-y-x rotation convention.

N is the number of samples in the input.

Data Types: `single` | `double`

Acceleration — Acceleration of INS sensor
 N -by-3 real-valued matrix

Acceleration of the INS sensor relative to the navigation frame, in meters per second squared, returned as an N -by-3 real-valued matrix. N is the number of samples.

Dependencies

To enable this output port, select **Use acceleration and angular velocity**.

Data Types: `single` | `double`

AngularVelocity — Angular velocity of INS sensor
 N -by-3 real-valued matrix

Angular velocity of the INS sensor relative to the navigation frame, in degrees per second, returned as an N -by-3 real-valued matrix. N is the number of samples.

Dependencies

To enable this output port, select **Use acceleration and angular velocity**.

Data Types: `single` | `double`

Parameters

Mounting location (m) — Location of sensor on platform (m)

[0 0 0] (default) | three-element real-valued vector of form [x y z]

Location of the sensor on the platform, in meters, specified as a three-element real-valued vector of the form [x y z]. The vector defines the offset of the sensor origin from the origin of the platform.

Data Types: `single` | `double`

Roll (X-axis) accuracy (deg) — Accuracy of roll measurement (deg)

0.2 (default) | nonnegative real scalar

Accuracy of the roll measurement of the sensor body in degrees, specified as a nonnegative real scalar.

Roll is defined as rotation around the x-axis of the sensor body. Roll noise is modeled as white process noise with standard deviation equal to the specified **Roll accuracy** in degrees.

Data Types: `single` | `double`

Pitch (Y-axis) accuracy (deg) — Accuracy of pitch measurement (deg)

0.2 (default) | nonnegative real scalar

Accuracy of the pitch measurement of the sensor body in degrees, specified as a nonnegative real scalar.

Pitch is defined as rotation around the y-axis of the sensor body. Pitch noise is modeled as white process noise with standard deviation equal to the specified **Pitch accuracy** in degrees.

Data Types: `single` | `double`

Yaw (Z-axis) accuracy (deg) — Accuracy of yaw measurement (deg)

1 (default) | nonnegative real scalar

Accuracy of the yaw measurement of the sensor body in degrees, specified as a nonnegative real scalar.

Yaw is defined as rotation around the z-axis of the sensor body. Yaw noise is modeled as white process noise with standard deviation equal to the specified **Yaw accuracy** in degrees.

Data Types: `single` | `double`

Position accuracy (m) — Accuracy of position measurement (m)

1 (default) | nonnegative real scalar | 1-by-3 vector of nonnegative values

Accuracy of the position measurement of the sensor body in meters, specified as a nonnegative real scalar or a 1-by-3 vector of nonnegative values. If you specify the parameter as a scalar value, then the block sets the accuracy of all three position components to this value.

Position noise is modeled as white process noise with a standard deviation equal to the specified **Position accuracy** in meters.

Data Types: `single` | `double`

Velocity accuracy (m/s) — Accuracy of velocity measurement (m/s)

0.05 (default) | nonnegative real scalar

Accuracy of the velocity measurement of the sensor body in meters per second, specified as a nonnegative real scalar.

Velocity noise is modeled as white process noise with a standard deviation equal to the specified **Velocity accuracy** in meters per second.

Data Types: `single` | `double`

Use acceleration and angular velocity — Use acceleration and angular velocity

off (default) | on

Select this check box to enable the block inputs of acceleration and angular velocity through the **Acceleration** and **AngularVelocity** input ports, respectively. Meanwhile, the block outputs the acceleration and angular velocity measurements through the **Acceleration** and **AngularVelocity**

output ports, respectively. Additionally, selecting this parameter enables you to specify the **Acceleration accuracy** and **Angular velocity accuracy** parameters.

Acceleration accuracy (m/s²) — Accuracy of acceleration measurement (m/s²)

0 (default) | nonnegative real scalar

Accuracy of the acceleration measurement of the sensor body in meters, specified as a nonnegative real scalar.

Acceleration noise is modeled as white process noise with a standard deviation equal to the specified **Acceleration accuracy** in meters per second squared.

Dependencies

To enable this parameter, select **Use acceleration and angular velocity**.

Data Types: `single` | `double`

Angular velocity accuracy (deg/s) — Accuracy of angular velocity measurement (deg/s)

0 (default) | nonnegative real scalar

Accuracy of the angular velocity measurement of the sensor body in meters, specified as a nonnegative real scalar.

Angular velocity noise is modeled as white process noise with a standard deviation equal to the specified **Angular velocity accuracy** in degrees per second.

Dependencies

To enable this parameter, select **Use acceleration and angular velocity**.

Data Types: `single` | `double`

Enable HasGNSSFix port — Enable HasGNSSFix input port

off (default) | on

Select this check box to enable the **HasGNSSFix** input port. When the **HasGNSSFix** input is specified as `false`, position measurements drift at a rate specified by the **Position error factor** parameter.

Position error factor — Position error factor (m)

[0 0 0] (default) | nonnegative scalar | 1-by-3 real-valued vector

Position error factor without GNSS fix, specified as a scalar or a 1-by-3 real-valued vector. If you specify the parameter as a scalar value, then the block sets the position error factors of all three position components to this value.

When the **HasGNSSFix** input is specified as `false`, the position error grows at a quadratic rate due to constant bias in the accelerometer. The position error for a position component $E(t)$ can be expressed as $E(t) = 1/2\alpha t^2$, where α is the position error factor for the corresponding component and t is the time since the GNSS fix is lost. The computed $E(t)$ values for the x , y , and z components are added to the corresponding position components of the **Position** output.

Dependencies

To enable this parameter, select **Enable HasGNSSFix port**.

Data Types: double

Seed — Initial seed for randomization

67 (default) | nonnegative integer

Initial seed of a random number generator algorithm, specified as a nonnegative integer.

Data Types: single | double

Simulate using — Type of simulation to run

Code Generation (default) | Interpreted Execution

- **Interpreted execution** — Simulate the model using the MATLAB interpreter. This option shortens startup time. In **Interpreted execution** mode, you can debug the source code of the block.
- **Code generation** — Simulate the model using generated C code. The first time that you run a simulation, Simulink generates C code for the block. The C code is reused for subsequent simulations if the model does not change. This option requires additional startup time.

Tips

- Ensure that the mounting location of the INS sensor is at the origin of the vehicle coordinates to avoid offset errors in measurements. If you are using the **Driving Scenario Designer** app, then the origin of the vehicle coordinates corresponds to the **Rear Window** mounting position.

Version History

Introduced in R2021b

Extended Capabilities

C/C++ Code Generation

Generate C and C++ code using Simulink® Coder™.

See Also

insSensor

Driving Radar Data Generator

Generate radar sensor detections and tracks from driving scenario

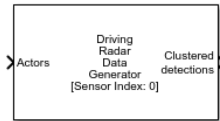

Libraries:

Automated Driving Toolbox / Driving Scenario and Sensor Modeling

Description

The Driving Radar Data Generator block generates detection or track reports of targets from an automotive radar sensor model. Use this block to generate sensor data from a driving scenario containing actors and trajectories, which you can read from a Scenario Reader block.

The Driving Radar Data Generator block can simulate clustered or unclustered detections with added random noise and also generate false alarm detections. You can fuse the generated detections with other sensor data and track objects by using a Multi-Object Tracker block. You can also output tracks directly from the Driving Radar Data Generator block. To configure whether targets are output as clustered detections, unclustered detections, or tracks, use the **Target reporting format** parameter.

Ports

Input

Actors — Scenario actor poses

Simulink bus containing MATLAB structure

Scenario actor poses in ego vehicle coordinates, specified as a Simulink bus containing a MATLAB structure.

The structure must contain these fields.

Field	Description	Type
NumActors	Number of actors	Nonnegative integer
Time	Current simulation time	Real-valued scalar
Actors	Actor poses	NumActors-length array of actor pose structures

Each actor pose structure in `Actors` must contain these fields.

Field	Description
ActorID	Scenario-defined actor identifier, specified as a positive integer.
Position	Position of actor, specified as a real-valued vector of the form $[x \ y \ z]$. Units are in meters.

Field	Description
Velocity	Velocity (v) of actor in the x - y -, and z -directions, specified as a real-valued vector of the form $[v_x v_y v_z]$. Units are in meters per second.
Roll	Roll angle of actor, specified as a real-valued scalar. Units are in degrees.
Pitch	Pitch angle of actor, specified as a real-valued scalar. Units are in degrees.
Yaw	Yaw angle of actor, specified as a real-valued scalar. Units are in degrees.
AngularVelocity	Angular velocity (ω) of actor in the x -, y -, and z -directions, specified as a real-valued vector of the form $[\omega_x \omega_y \omega_z]$. Units are in degrees per second.

Output

Clustered detections — Clustered object detections
Simulink bus containing MATLAB structure

Clustered object detections, returned as a Simulink bus containing a MATLAB structure. For more details about buses, see “Create Nonvirtual Buses” (Simulink).

With clustered detections, the block outputs a single detection per target, where each detection is the centroid of the unclustered detections for that target.

You can pass object detections from these sensors and other sensors to a tracker, such as a Multi-Object Tracker block, and generate tracks.

The structure contains these fields.

Field	Description	Type
NumDetections	Number of detections	Nonnegative integer
IsValidTime	False when updates are requested at times that are between block invocation intervals	Boolean
Detections	Object detections	Array of object detection structures of length set by the Maximum number of reported detections parameter. Only NumDetections of these are actual detections.

Each object detection structure contains these properties.

Property	Definition
Time	Measurement time

Property	Definition
Measurement	Object measurements
MeasurementNoise	Measurement noise covariance matrix
SensorIndex	Unique ID of the sensor
ObjectClassID	Object classification
MeasurementParameters	Parameters used by initialization functions of nonlinear Kalman tracking filters
ObjectAttributes	Additional information passed to tracker

- For rectangular coordinates, **Measurement** and **MeasurementNoise** are reported in the rectangular coordinate system specified by the **Coordinate system** parameter.
- For spherical coordinates, **Measurement** and **MeasurementNoise** are reported in the spherical coordinate system, which is based on the sensor rectangular coordinate system.

Measurement and MeasurementNoise

Coordinate System	Measurement and MeasurementNoise Coordinates				
Body	This table shows how coordinates are affected by the Enable range rate measurements parameter.				
Sensor rectangular				Enable range rate measurements	Coordinates
				on	[x;y;z;vx;vy;vz]
				off	[x;y;z]
Sensor spherical	This table shows how coordinates are affected by the Enable elevation angle measurements and Enable range rate measurements parameters.				
	Enable range rate measurements	Enable elevation angle measurements	Coordinates		
	on	on	[az;el;rng;rr]		
	on	off	[az;rng;rr]		
	off	on	[az;el;rng]		
	off	off	[az;rng]		

For **ObjectAttributes**, this table describes the additional information used for tracking.

ObjectAttributes

Attribute	Definition
TargetIndex	Identifier of the actor, ActorID, that generated the detection. For false alarms, this value is negative.
SNR	Signal-to-noise ratio of the detection. Units are in dB.

For MeasurementParameters, the measurements are relative to the parent frame. When you set the **Coordinate system** parameter to Body, the parent frame is the ego vehicle body. When you set **Coordinate system** to Sensor rectangular or Sensor spherical, the parent frame is the sensor.

MeasurementParameters

Parameter	Definition
Frame	Enumerated type indicating the frame used to report measurements. When Frame is set to 'rectangular', detections are reported in Cartesian coordinates. When Frame is set to 'spherical', detections are reported in spherical coordinates.
OriginPosition	3-D vector offset of the sensor origin from the parent frame origin.
Orientation	Orientation of the radar sensor coordinate system with respect to the parent frame.
HasVelocity	Indicates whether measurements contain velocity or range rate components.
HasElevation	Indicates whether measurements contain elevation components.

Dependencies

To enable this port, on the **Parameters** tab, set the **Target reporting format** parameter to Clustered detections.

Tracks — Object tracks

Simulink bus containing MATLAB structure

Object tracks, returned as a Simulink bus containing a MATLAB structure. See “Create Nonvirtual Buses” (Simulink).

This table shows the structure fields.

Field	Description
NumTracks	Number of tracks
Tracks	Array of track structures of a length set by the Maximum number of tracks parameter. Only the first NumTracks of these are actual tracks.

This table shows the fields of each track structure.

Field	Definition
TrackID	Unique track identifier used to distinguish multiple tracks.
BranchID	Unique track branch identifier used to distinguish multiple track branches.
SourceIndex	Unique source index used to distinguish tracking sources in a multiple tracker environment.
UpdateTime	Time at which the track is updated. Units are in seconds.
Age	Number of times the track was updated.
State	Value of state vector at the update time.
StateCovariance	Uncertainty covariance matrix.
ObjectClassID	Integer value representing the object classification. The value 0 represents an unknown classification. Nonzero classifications apply only to confirmed tracks.
TrackLogic	Confirmation and deletion logic type. This value is always 'History' for radar sensors, to indicate history-based logic.
TrackLogicState	Current state of the track logic type, returned as a 1-by-K logical array. K is the number of latest track logical states recorded. In the array, 1 denotes a hit and 0 denotes a miss.
IsConfirmed	Confirmation status. This field is true if the track is confirmed to be a real target.
IsCoasted	Coasting status. This field is true if the track is updated without a new detection.
IsSelfReported	Indicate if the track is reported by the tracker. This field is used in a track fusion environment. It is returned as true by default.
ObjectAttributes	Additional information about the track.

For more details about these fields, see `objectTrack`.

The block outputs only confirmed tracks, which are tracks to which the block assigns at least M detections during the first N updates after track initialization. To specify the values M and N , use the **M and N for the M-out-of-N confirmation** parameter.

Dependencies

To enable this port, on the **Parameters** tab, set the **Target reporting format** parameter to **Tracks**.

Detections — Unclustered object detections

Simulink bus containing MATLAB structure

Unclustered object detections, returned as a Simulink bus containing a MATLAB structure. For more details about buses, see “Create Nonvirtual Buses” (Simulink).

With unclustered detections, the block outputs all detections, and a target can have multiple detections.

You can pass object detections from these sensors and other sensors to a tracker, such as a Multi-Object Tracker block, and generate tracks.

The structure must contain these fields.

Field	Description	Type
NumDetections	Number of detections	integer
IsValidTime	False when updates are requested at times that are between block invocation intervals	Boolean
Detections	Object detections	Array of object detection structures of length set by the Maximum number of reported detections parameter. Only NumDetections of these are actual detections.

Each object detection structure contains these properties.

Property	Definition
Time	Measurement time
Measurement	Object measurements
MeasurementNoise	Measurement noise covariance matrix
SensorIndex	Unique ID of the sensor
ObjectClassID	Object classification
MeasurementParameters	Parameters used by initialization functions of nonlinear Kalman tracking filters
ObjectAttributes	Additional information passed to tracker

- For rectangular coordinates, **Measurement** and **MeasurementNoise** are reported in the rectangular coordinate system specified by the **Coordinate system** parameter.
- For spherical coordinates, **Measurement** and **MeasurementNoise** are reported in the spherical coordinate system, which is based on the sensor rectangular coordinate system.

Measurement and MeasurementNoise

Coordinate System	Measurement and MeasurementNoise Coordinates		
Body	This table shows how coordinates are affected by the Enable range rate measurements parameter.		
Sensor rectangular			
	Enable range rate measurements	Coordinates	
	on	[x;y;z;vx;vy;vz]	
	off	[x;y;z]	
Sensor spherical	This table shows how coordinates are affected by the Enable elevation angle measurements and Enable range rate measurements parameters.		
	Enable range rate measurements	Enable elevation angle measurements	Coordinates
	on	on	[az;el;rng;rr]
	on	off	[az;rng;rr]
	off	on	[az;el;rng]
	off	off	[az;rng]

For ObjectAttributes, this table describes the additional information used for tracking.

ObjectAttributes

Attribute	Definition
TargetIndex	Identifier of the actor, ActorID, that generated the detection. For false alarms, this value is negative.
SNR	Signal-to-noise ratio of the detection. Units are in dB.

For MeasurementParameters, the measurements are relative to the parent frame. When you set the **Coordinate system** parameter to Body, the parent frame is the ego vehicle body. When you set **Coordinate system** to Sensor rectangular or Sensor spherical, the parent frame is the sensor.

MeasurementParameters

Parameter	Definition
Frame	Enumerated type indicating the frame used to report measurements. When Frame is set to 'rectangular', detections are reported in Cartesian coordinates. When Frame is set to 'spherical', detections are reported in spherical coordinates.
OriginPosition	3-D vector offset of the sensor origin from the parent frame origin.
Orientation	Orientation of the radar sensor coordinate system with respect to the parent frame.
HasVelocity	Indicates whether measurements contain velocity or range rate components.
HasElevation	Indicates whether measurements contain elevation components.

Dependencies

To enable this port, on the **Parameters** tab, set the **Target reporting format** parameter to Detections.

Parameters

Parameters

Sensor Identification

Unique identifier of sensor — Unique sensor identifier

0 (default) | positive integer

Specify the unique sensor identifier as a positive integer. Use this parameter to distinguish between detections or tracks that come from different sensors in a multisensor system. Specify a unique value for each sensor. If you do not update **Unique identifier of sensor** from the default value of 0, then the radar returns an error at the start of simulation.

Update rate (Hz) — Sensor update rate

10 (default) | positive real scalar

Specify the sensor update rate in hertz as a positive real scalar. The reciprocal of the update rate must be an integer multiple of the simulation time interval. The radar generates new reports at intervals defined by this reciprocal value. Any sensor update requested between update intervals contains no detections or tracks.

Sensor Mounting

Translation [X, Y, Z] relative to ego origin (m) — Sensor location on ego vehicle (m)

[3.4, 0, 0.2] (default) | 1-by-3 real-valued vector of form [x y z]

Specify the sensor location on the ego vehicle body frame in meters as a 1-by-3 real-valued vector of the form $[x\ y\ z]$. This parameter defines the coordinates of the sensor along the x-axis, y-axis, and z-axis relative to the ego vehicle origin, where:

- The x-axis points forward from the vehicle.
- The y-axis points to the left of the vehicle.
- The z-axis points up from the ground.

The default value corresponds to a radar that is mounted at the center of the front grill of a sedan.

For more details on the ego vehicle coordinate system, see “Coordinate Systems in Automated Driving Toolbox”.

Rotation [Yaw, Pitch, Roll] relative to ego's frame (deg) — Mounting rotation angles of radar

`[0 0 0]` (default) | 1-by-3 real-valued vector of form $[z_{yaw}\ y_{pitch}\ x_{roll}]$

Specify the mounting rotation angles of the radar in degrees as a 1-by-3 real-valued vector of form $[z_{yaw}\ y_{pitch}\ x_{roll}]$. This parameter defines the intrinsic Euler angle rotation of the sensor around the z-axis, y-axis, and x-axis with respect to the ego vehicle body frame, where:

- z_{yaw} , or yaw angle, rotates the sensor around the z-axis of the ego vehicle.
- y_{pitch} , or pitch angle, rotates the sensor around the y-axis of the ego vehicle. This rotation is relative to the sensor position that results from the z_{yaw} rotation.
- x_{roll} , or roll angle, rotates the sensor about the x-axis of the ego vehicle. This rotation is relative to the sensor position that results from the z_{yaw} and y_{pitch} rotations.

These angles are clockwise-positive when looking in the forward direction of the z-axis, y-axis, and x-axis, respectively. If you visualize sensor data from a bird's-eye view perspective, then the yaw angle is counterclockwise-positive because you are viewing the data in the negative direction of the z-axis, which points up from the ground.

For more details on this coordinate system, see “Coordinate Systems in Automated Driving Toolbox”.

Detection Reporting

Enable elevation angle measurements — Enable radar to measure target elevation angles

`off` (default) | `on`

Select this parameter to model a radar sensor that can estimate target elevation.

Enable range rate measurements — Enable radar to measure target range rates

`on` (default) | `off`

Select this parameter to enable the radar to measure range rates from target detections.

Add noise to measurements — Enable addition of noise to radar sensor measurements

`on` (default) | `off`

Select this parameter to add noise to the radar measurements. Otherwise, the measurements have no noise. Even if you clear this parameter, the measurement noise covariance matrix, which is reported

in the `MeasurementNoise` field of the generated detections output, represents the measurement noise that is added when **Add noise to measurements** is selected.

Enable false reports — Enable creating false alarm radar detections

on (default) | off

Select this parameter to enable creating false alarm radar measurements. If you clear this parameter, the radar reports only actual detections.

Enable occlusion — Enable line-of-sight occlusion

on (default) | off

Select this parameter to enable line-of-sight occlusion, where the radar generates detection only from objects for which the radar has a direct line of sight. For example, with this parameter enabled, the radar does not generate a detection for a vehicle that is behind another vehicle and blocked from view.

Maximum number of target reports — Maximum number of detections or tracks

50 (default) | positive integer

Specify the maximum number of detections or tracks that the sensor reports as a positive integer. The sensor reports detections in the order of increasing distance from the sensor until reaching this maximum number.

Target reporting format — Format of generated target reports

Clustered detections (default) | Tracks | Detections

Specify the format of generated target reports as one of these options:

- `Clustered detections` — The block generates target reports as clustered detections, where each target is reported as a single detection that is the centroid of the unclustered target detections. The block returns clustered detections at the **Clustered detections** output port.
- `Tracks` — The block generates target reports as tracks, which are clustered detections that have been processed by a tracking filter. The block returns clustered detections at the **Tracks** output port.
- `Detections` — The block generates target reports as unclustered detections, where each target can have multiple detections. The block returns clustered detections at the **Detections** output port.

Coordinate system — Coordinate system of reported detections

Body (default) | Sensor rectangular | Sensor spherical

Coordinate system of reported detections, specified as one of these options:

- `Body` — Detections are reported in the rectangular body system of the ego vehicle.
- `Sensor rectangular` — Detections are reported in the rectangular body system of the radar sensor.
- `Sensor spherical` — Detections are reported in a spherical coordinate system that is centered at the radar sensor and aligned with the orientation of the radar on the ego vehicle.

Port Settings**Source of output bus name** — Source of output bus name

Auto (default) | Property

Source of output bus name, specified as one of these options:

- Auto — The block automatically creates a bus name.
- Property — Specify the bus name by using the **Specify an output bus name** parameter.

Specify an output bus name — Name of output bus

BusDrivingRadarDataGenerator (default) | valid bus name

Specify the name of the actor poses bus returned in the **Actors** output port.To enable this parameter, set the **Source of output bus name** parameter to Property.**Measurements****Resolution Settings****Azimuth resolution (deg)** — Azimuth resolution of radar

4 (default) | positive real scalar

Specify the azimuth resolution of the radar in degrees as a positive scalar. The azimuth resolution defines the minimum separation in azimuth angle at which the radar can distinguish between two targets. The azimuth resolution is typically the 3 dB downpoint of the azimuth angle beamwidth of the radar.

Elevation resolution (deg) — Elevation resolution of radar

5 (default) | positive real scalar

Specify the elevation resolution of the radar in degrees as a positive real scalar. The elevation resolution defines the minimum separation in elevation angle at which the radar can distinguish between two targets. The elevation resolution is typically the 3 dB downpoint in elevation angle beamwidth of the radar.

Dependencies

To enable this parameter, on the **Parameters** tab, select the **Enable elevation angle measurements** parameter.

Range resolution (m) — Range resolution of radar

2.5 (default) | positive real scalar

Specify the range resolution of the radar in meters as a positive real scalar. The range resolution defines the minimum separation in range at which the radar can distinguish between two targets.

Range rate resolution (m/s) — Range rate resolution of radar

0.5 (default) | positive real scalar

Specify the range rate resolution of the radar in meters per second as a positive real scalar. The range rate resolution defines the minimum separation in range rate at which the radar can distinguish between two targets.

Dependencies

To enable this parameter, on the **Parameters** tab, select the **Enable range rate resolution** parameter.

Bias Settings

Azimuth bias fraction — Azimuth bias fraction of radar

0.1 (default) | nonnegative scalar

Specify the azimuth bias fraction of the radar as a nonnegative scalar. Azimuth bias is expressed as a fraction of the azimuth resolution specified in the **Azimuth resolution (deg)** parameter. This value sets a lower bound on the azimuthal accuracy of the radar and is dimensionless.

Elevation bias fraction — Elevation bias fraction of radar

0.1 (default) | nonnegative scalar

Specify the elevation bias fraction of the radar as a nonnegative scalar. Elevation bias is expressed as a fraction of the elevation resolution specified by the **Elevation resolution (deg)** parameter. This value sets a lower bound on the elevation accuracy of the radar and is dimensionless.

Dependencies

To enable this parameter, on the **Parameters** tab, select the **Enable elevation angle measurements** parameter.

Range bias fraction — Range bias fraction

0.05 (default) | nonnegative scalar

Specify the range bias fraction of the radar as a nonnegative scalar. Range bias is expressed as a fraction of the range resolution specified by the **Range resolution (m)** property. This property sets a lower bound on the range accuracy of the radar and is dimensionless.

Range rate bias fraction — Range rate bias fraction

0.05 (default) | nonnegative scalar

Specify the range rate bias fraction of the radar as a nonnegative scalar. Range rate bias is expressed as a fraction of the range rate resolution specified by the **Range rate resolution (m/s)** parameter. This property sets a lower bound on the range rate accuracy of the radar and is dimensionless.

Dependencies

To enable this parameter, on the **Parameters** tab, select the **Enable range rate measurements** parameter.

Detector Settings

Total angular field of view [AZ, EL] (deg) — Angular field of view of radar

[20 5] (default) | 1-by-2 positive real-valued vector of form [azfov, elfov]

Specify the angular field of view of the radar in degrees as a 1-by-2 positive real-valued vector of the form [azfov elfov]. The field of view defines the total angular extent spanned by the sensor. The azimuth field of view, azfov, must lie in the interval (0, 360]. The elevation field of view, elfov, must lie in the interval (0, 180].

Range limits [MIN, MAX] (m) — Minimum and maximum range of radar

[0 150] (default) | 1-by-2 nonnegative real-valued vector of form [min max]

Specify the minimum and maximum range of the radar in meters as a 1-by-2 nonnegative real-valued vector of the form [min max]. The radar does not detect targets that are outside this range. The maximum range, max, must be greater than the minimum range, min.

Range rate limits [MIN, MAX] (m/s) — Minimum and maximum range rate of radar (m/s)

[-100 100] (default) | 1-by-2 real-valued vector of form [min max]

Specify the minimum and maximum range rate of radar in meters per second as a 1-by-2 real-valued vector of the form [min max]. The radar does not detect targets that are outside this range rate. The maximum range rate, max, must be greater than the minimum range rate, min.

Dependencies

To enable this parameter, on the **Parameters** tab, select the **Enable range rate measurements** parameter.

Detection probability — Probability of detecting a target

0.9 (default) | scalar in range (0, 1]

Specify the probability of detecting a target as a scalar in the range (0, 1]. This quantity defines the probability of detecting a target with a radar cross-section, with the radar cross-section specified by the **Reference target RCS (dBsm)** parameter at the reference detection range specified by the **Reference target range (m)** parameter.

False alarm rate — False alarm report rate

1e-06 (default) | positive real scalar in range [10⁻⁷, 10⁻³]

Specify the false alarm report rate within each radar resolution cell as a positive real scalar in the range [10⁻⁷, 10⁻³]. Units are dimensionless. The block determines resolution cells from the **Azimuth resolution (deg)** and **Range resolution (m)** parameters and, when enabled, from the **Elevation resolution (deg)** and **Range rate resolution (m/s)** parameters.

Reference target range (m) — Reference range for given probability of detection

100 (default) | positive real scalar

Specify the reference range for the given probability of detection and the given reference radar cross-section (RCS) in meters as a positive real scalar. The reference range is the range at which a

target having a radar cross-section specified by the **Reference target RCS (dBsm)** parameter is detected with a probability of detection specified by the **Detection probability** parameter.

Reference target RCS (dBsm) — Reference radar cross-section for given probability of detection

0 (default) | real scalar

Specify the reference radar cross-section (RCS) for a given probability of detection and reference range in decibel square meters as a real scalar. The reference RCS is the RCS value at which a target is detected with a probability specified by the **Detection probability** parameter at the specified **Reference target range (m)** parameter value.

Center frequency (Hz) — Center frequency of radar band

77e9 (default) | positive real scalar

Specify the center frequency of the radar band in hertz as a positive scalar.

Tracker Settings

Filter initialization function name — Kalman filter initialization function

initcvekf (default) | function name

Specify the Kalman filter initialization function as a function handle or as a character vector or string scalar of the name of a valid Kalman filter initialization function.

The table shows the initialization functions that you can use to specify **Filter initialization function name**.

Initialization Function	Function Definition
initcaabf	Initialize constant-acceleration alpha-beta Kalman filter
initcvabf	Initialize constant-velocity alpha-beta Kalman filter
initcakf	Initialize constant-acceleration linear Kalman filter.
initcvkf	Initialize constant-velocity linear Kalman filter.
initcaekf	Initialize constant-acceleration extended Kalman filter.
initctekf	Initialize constant-turnrate extended Kalman filter.
initcvekf	Initialize constant-velocity extended Kalman filter.
initcaukf	Initialize constant-acceleration unscented Kalman filter.
initctukf	Initialize constant-turnrate unscented Kalman filter.
initcvukf	Initialize constant-velocity unscented Kalman filter.

You can also write your own initialization function. The function must have the following syntax:

```
filter = filterInitializationFcn(detection)
```

The input to this function is a detection report like those created by an `objectDetection` object. The output of this function must be a tracking filter object, such as `trackingKF`, `trackingEKF`, `trackingUKF`, or `trackingABF`.

To guide you in writing this function, you can examine the details of the supplied functions from within MATLAB. For example:

```
type initcvkf
```

Dependencies

To enable this parameter, on the **Parameters** tab, set the **Target reporting format** parameter to Tracks.

M and N for the M-out-of-N confirmation — Threshold for track confirmation

[2 3] (default) | 1-by-2 vector of positive integers

Specify the threshold for track confirmation as a 1-by-2 vector of positive integers of the form [M N]. A track is confirmed if it receives at least M detections in the last N updates. M must be less than or equal to N.

- When setting M, take into account the probability of object detection for the sensors. The probability of detection depends on factors such as occlusion or clutter. You can reduce M when tracks fail to be confirmed or increase M when too many false detections are assigned to tracks.
- When setting N, consider the number of times you want the tracker to update before it makes a confirmation decision. For example, if a tracker updates every 0.05 seconds, and you want to allow 0.5 seconds to make a confirmation decision, set $N = 10$.

Dependencies

To enable this parameter, on the **Parameters** tab, set the **Target reporting format** parameter to Tracks.

P and R for the P-out-of-R deletion — Threshold for track deletion

[5 5] (default) | 1-by-2 vector of positive integers

Specify the threshold for track deletion as a two-element vector of 1-by-2 vector of positive integers of the form [P R]. If a confirmed track is not assigned to any detection P times in the last R tracker updates, then the track is deleted. P must be less than or equal to R.

Dependencies

To enable this parameter, on the **Parameters** tab, set the **Target reporting format** parameter to Tracks.

Random Number Generator Settings

Random number generation — Method to specify random number generator seed

Repeatable (default) | Specify seed | Not repeatable

Specify the method to set the random number generator seed as one of the options in the table.

Option	Description
Repeatable	The block generates a random initial seed for the first simulation and reuses this seed for all subsequent simulations. Select this parameter to generate repeatable results from the statistical sensor model. To change this initial seed, at the MATLAB command prompt, enter: <code>clear all</code> .
Specify seed	Specify your own random initial seed for reproducible results by using the Initial seed parameter.
Not repeatable	The block generates a new random initial seed after each simulation run. Select this parameter to generate nonrepeatable results from the statistical sensor model.

Initial seed — Random number generator seed

0 (default) | nonnegative integer less than 2^{32}

Specify the random number generator seed as a nonnegative integer less than 2^{32} .

Dependencies

To enable this parameter, set the **Random number generation** parameter to `Specify seed`.

Target Profiles

Target profiles definition — Method to specify target profiles

Parameters (default) | MATLAB expression | From Scenario Reader block

Specify the method to specify target profiles, which are the physical and radar characteristics of all targets in the driving scenario, as one of these options:

- **Parameters** — The block obtains the target profiles from the parameters enabled on the **Target Profiles** tab when you select this option.
- **MATLAB expression** — The block obtains the actor profiles from the MATLAB expression specified by the **MATLAB expression for target profiles** parameter.
- **From Scenario Reader block** — The block obtains the actor profiles from the scenario specified by the Scenario Reader block.

MATLAB expression for target profiles — MATLAB expression for target profiles

MATLAB structure | MATLAB structure array | valid MATLAB expression

Specify the MATLAB expression for actor profiles, as a MATLAB structure, a MATLAB structure array, or a valid MATLAB expression that produces such a structure or structure array.

If your Scenario Reader block reads data from a `drivingScenario` object, to obtain the actor profiles directly from this object, set this expression to call the `actorProfiles` function on the object. For example: `actorProfiles(scenario)`.

The default target profile expression produces a MATLAB structure and has this form:

```
struct('ClassID',0,'Length',4.7,'Width',1.8,'Height',1.4, ...
'OriginOffset',[-1.35 0 0],'RCSPattern',[10 10;10 10], ...
'RCSAzimuthAngles',[-180 180],'RCSElevationAngles',[-90 90])
```

Dependencies

To enable this parameter, set the **Target profiles definition** parameter to MATLAB expression.

Unique identifier for actors — Scenario-defined actor identifier

[] (default) | positive integer | length-*L* vector of unique positive integers

Specify the scenario-defined actor identifier as a positive integer or length-*L* vector of unique positive integers. *L* must equal the number of actors input into the **Actors** input port. The vector elements must match ActorID values of the actors. You can specify **Unique identifier for actors** as []. In this case, the same actor profile parameters apply to all actors.

Example: [1 2]

Dependencies

To enable this parameter, set the **Target profiles definition** parameter to Parameters.

User-defined integer to classify actors — User-defined classification identifier

0 (default) | integer | length-*L* vector of integers

Specify the user-defined classification identifier as an integer or length-*L* vector of integers. When **Unique identifier for actors** is a vector, this parameter is a vector of the same length with elements in one-to-one correspondence to the actors in **Unique identifier for actors**. When **Unique identifier for actors** is empty, [], you must specify this parameter as a single integer whose value applies to all actors.

Example: 2

Dependencies

To enable this parameter, set the **Target profiles definition** parameter to Parameters.

Length of actors' cuboids (m) — Length of actor cuboids

4.7 (default) | positive real scalar | length-*L* vector of positive values

Specify the length of actor cuboids as a positive real scalar or length-*L* vector of positive values. When **Unique identifier for actors** is a vector, this parameter is a vector of the same length with elements in one-to-one correspondence to the actors in **Unique identifier for actors**. When **Unique identifier for actors** is empty, [], you must specify this parameter as a positive real scalar whose value applies to all actors. Units are in meters.

Example: 6.3

Dependencies

To enable this parameter, set the **Target profiles definition** parameter to Parameters.

Width of actors' cuboids (m) — Width of actor cuboids1.8 (default) | positive real scalar | length- L vector of positive values

Specify the width of actor cuboids as a positive real scalar or length- L vector of positive values. When **Unique identifier for actors** is a vector, this parameter is a vector of the same length with elements in one-to-one correspondence to the actors in **Unique identifier for actors**. When **Unique identifier for actors** is empty, [], you must specify this parameter as a positive real scalar whose value applies to all actors. Units are in meters.

Example: 4.7

Dependencies

To enable this parameter, set the **Target profiles definition** parameter to Parameters.

Height of actors' cuboids (m) — Height of actor cuboids1.4 (default) | positive real scalar | length- L vector of positive values

Specify the height of actor cuboids as a positive real scalar or length- L vector of positive values. When **Unique identifier for actors** is a vector, this parameter is a vector of the same length with elements in one-to-one correspondence to the actors in **Unique identifier for actors**. When **Unique identifier for actors** is empty, [], you must specify this parameter as a positive real scalar whose value applies to all actors. Units are in meters.

Example: 2.0

Dependencies

To enable this parameter, set the **Target profiles definition** parameter to Parameters.

Rotational center of actors from bottom center (m) — Rotational center of actors{[-1.35, 0, 0]} (default) | length- L cell array of real-valued 1-by-3 vectors

Specify the rotational center of actors as a length- L cell array of real-valued 1-by-3 vectors. Each vector represents the offset of the rotational center of an actor from the bottom-center of the actor. For vehicles, the offset corresponds to the point on the ground beneath the center of the rear axle. When **Unique identifier for actors** is a vector, this parameter is a cell array of vectors with cells in one-to-one correspondence to the actors in **Unique identifier for actors**. When **Unique identifier for actors** is empty, [], you must specify this parameter as a cell array of one element containing an offset vector whose values apply to all actors. Units are in meters.

Example: {[-1.35, 0.2, 0.3]}

Dependencies

To enable this parameter, set the **Target profiles definition** parameter to Parameters.

Radar cross section pattern (dBsm) — Radar cross-section{[10, 10; 10, 10]} (default) | real-valued Q -by- P matrix | length- L cell array of real-valued Q -by- P matrices

Specify the radar cross-section (RCS) of actors as a real-valued Q -by- P matrix or length- L cell array of real-valued Q -by- P matrices. Q is the number of elevation angles specified by the corresponding cell

in the **Elevation angles defining RCSPattern (deg)** parameter. P is the number of azimuth angles specified by the corresponding cell in **Azimuth angles defining RCSPattern (deg)** parameter. When **Unique identifier for actors** is a vector, this parameter is a cell array of matrices with cells in one-to-one correspondence to the actors in **Unique identifier for actors**. The values of Q and P can differ between cells. When **Unique identifier for actors** is empty, `[]`, you must specify this parameter as a cell array with one element containing a matrix whose values apply to all actors. Units are in dBsm.

Example: `{[10 14 10; 9 13 9]}`

Dependencies

To enable this parameter, set the **Target profiles definition** parameter to `Parameters`.

Azimuth angles defining RCSPattern (deg) — Azimuth angles of radar cross-section pattern

`{[-180 180]}` (default) | length- L cell array of real-valued P -length vectors

Specify the azimuth angles of radar cross-section patterns as a length- L cell array of real-valued P -length vectors. Each vector represents the azimuth angles of the P columns of the radar cross-section specified in **Radar cross section pattern (dBsm)**. When **Unique identifier for actors** is a vector, this parameter is a cell array of vectors with cells in one-to-one correspondence to the actors in **Unique identifier for actors**. The value of P can differ between cells. When **Unique identifier for actors** is empty, `[]`, you must specify this parameter as a cell array with one element containing a vector whose values apply to all actors. Units are in degrees. Azimuth angles lie in the range -180° to 180° and must be in strictly increasing order.

When the radar cross-sections specified in the cells of **Radar cross section pattern (dBsm)** all have the same dimensions, you need only specify a cell array with one element containing the azimuth angle vector.

Example: `{[-90 90]}`

Dependencies

To enable this parameter, set the **Target profiles definition** parameter to `Parameters`.

Elevation angles defining RCSPattern (deg) — Elevation angles of radar cross-section pattern

`{[-90 90]}` (default) | length- L cell array of real-valued Q -length vectors

Specify the elevation angles of radar cross-section patterns as a length- L cell array of real-valued Q -length vectors. Each vector represent the elevation angles of the Q columns of the radar cross-section specified in **Radar cross section pattern (dBsm)**. When **Unique identifier for actors** is a vector, this parameter is a cell array of vectors with cells in one-to-one correspondence to the actors in **Unique identifier for actors**. The value of Q can differ between cells. When **Unique identifier for actors** is empty, `[]`, you must specify this parameter as a cell array with one element containing a vector whose values apply to all actors. Units are in degrees. Elevation angles lie in the range -90° to 90° and must be in strictly increasing order.

When the radar cross-sections that are specified in the cells of **Radar cross section pattern (dBsm)** all have the same dimensions, you need only specify a cell array with one element containing an elevation angle vector.

Example: `{[-25 25]}`

Dependencies

To enable this parameter, set the **Target profiles definition** parameter to Parameters.

Version History

Introduced in R2021a

See Also**Apps**

Bird's-Eye Scope | Driving Scenario Designer

Blocks

Detection Concatenation | Multi-Object Tracker | Scenario Reader | Vision Detection Generator | Lidar Point Cloud Generator

Objects

drivingRadarDataGenerator

Topics

“Create Nonvirtual Buses” (Simulink)

“Coordinate Systems in Automated Driving Toolbox”

Lateral Controller Stanley

Control steering angle of vehicle for path following by using Stanley method

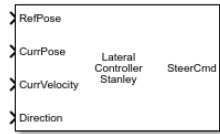

Libraries:

Automated Driving Toolbox / Vehicle Control

Description

The Lateral Controller Stanley block computes the steering angle command, in degrees, that adjusts the current pose of a vehicle to match a reference pose, given the vehicle's current velocity and direction. The controller computes this command using the Stanley method [1], whose control law is based on both a kinematic and dynamic bicycle model. To change between models, use the **Vehicle model** parameter.

- The kinematic bicycle model is suitable for path following in low-speed environments such as parking lots, where inertial effects are minimal.
- The dynamic bicycle model is suitable for path following in high-speed environments such as highways, where inertial effects are more pronounced. This vehicle model provides additional parameters that describe the dynamics of the vehicle.

Ports

Input

RefPose — Reference pose

$[x, y, \theta]$ vector

Reference pose, specified as an $[x, y, \theta]$ vector. x and y are in meters, and θ is in degrees.

x and y specify the reference point to steer the vehicle toward. θ specifies the orientation angle of the path at this reference point and is positive in the counterclockwise direction.

- For a vehicle in forward motion, the reference point is the point on the path that is closest to the center of the vehicle's front axle.

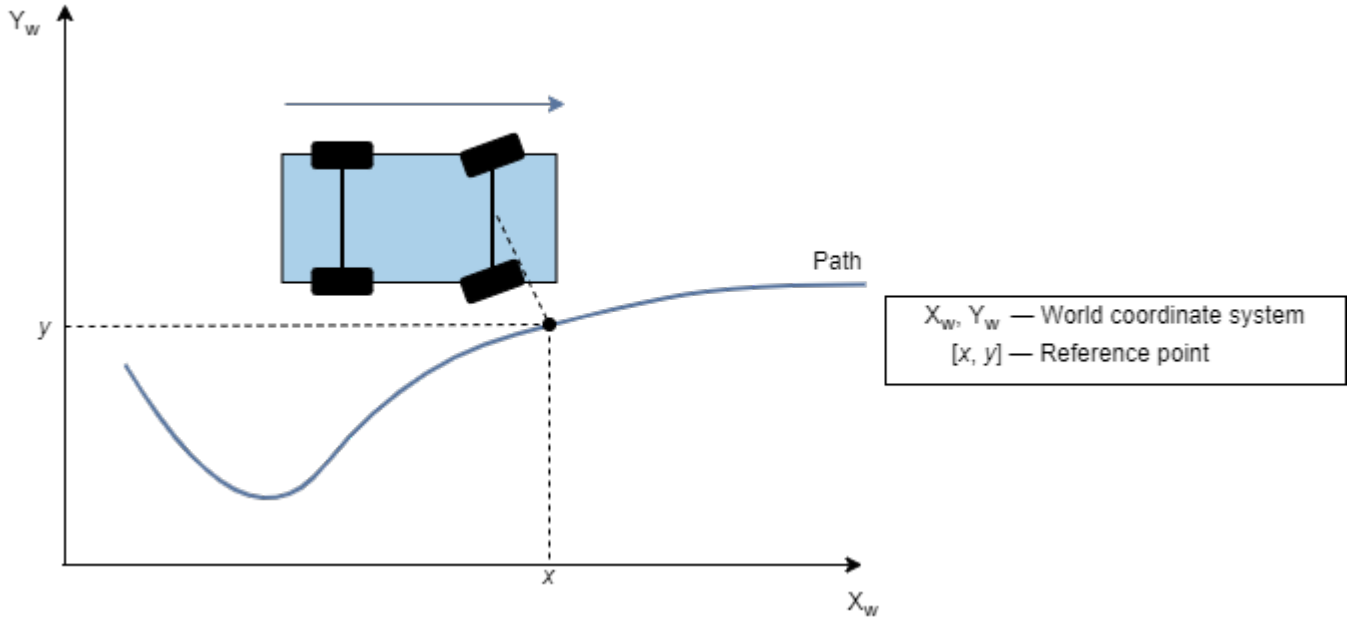

- For a vehicle in reverse motion, the reference point is the point on the path that is closest to the center of the vehicle's rear axle.

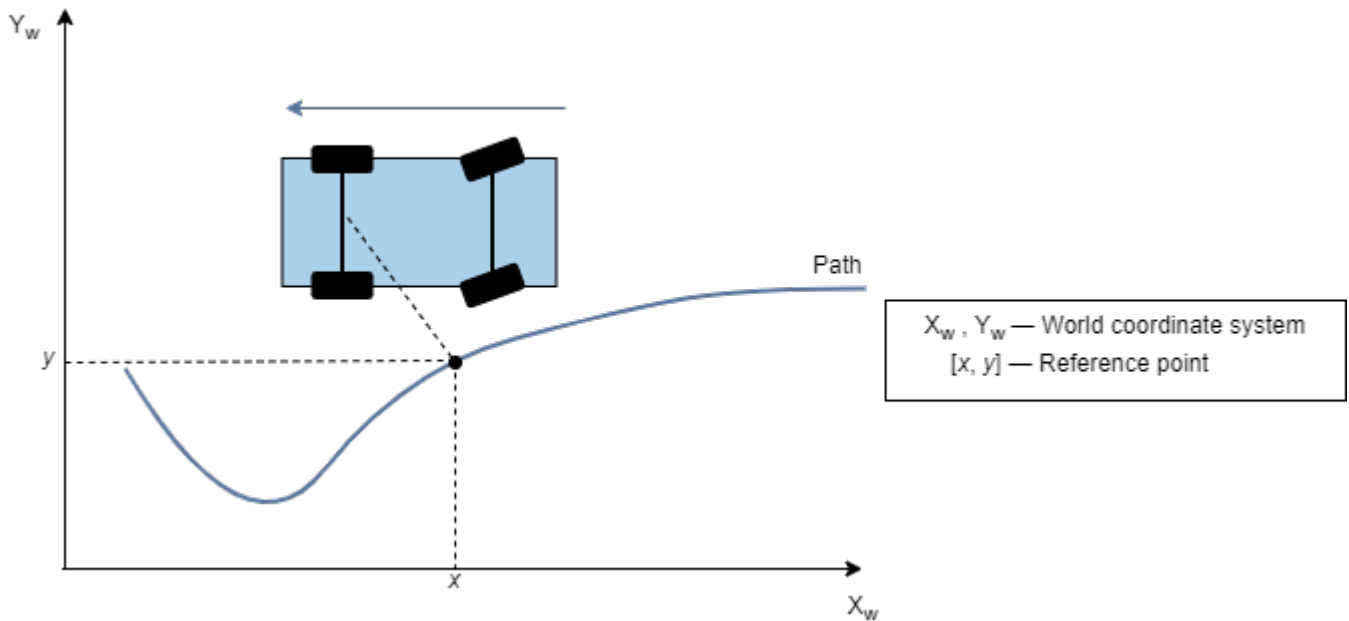

Data Types: single | double

CurrPose — Current pose
 $[x, y, \theta]$ vector

Current pose of the vehicle, specified as an $[x, y, \theta]$ vector. x and y are in meters, and θ is in degrees.

x and y specify the location of the vehicle, which is defined as the center of the vehicle's rear axle.

θ specifies the orientation angle of the vehicle at location (x,y) and is positive in the counterclockwise direction.

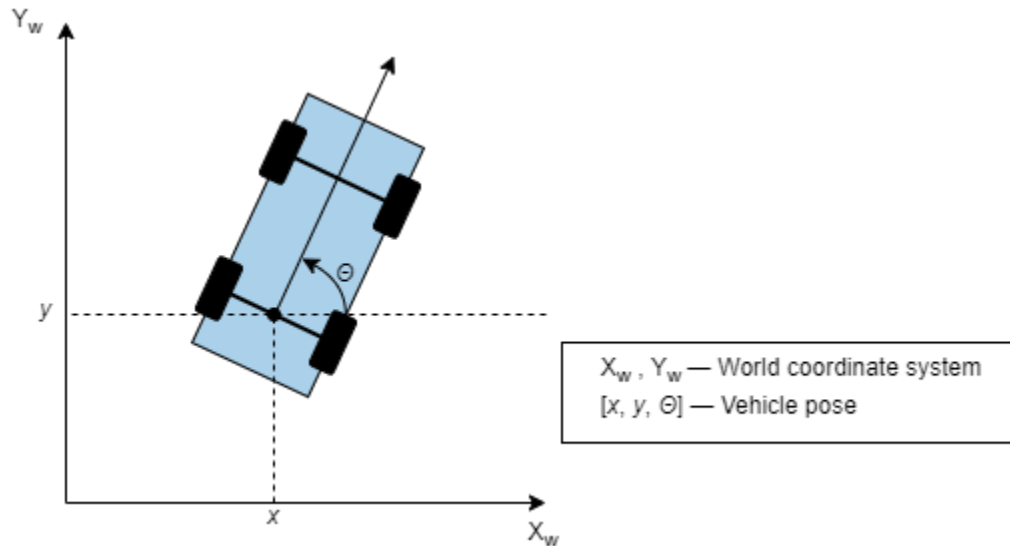

For more details on vehicle pose, see “Coordinate Systems in Automated Driving Toolbox”.

Data Types: `single` | `double`

CurrVelocity — Current longitudinal velocity
real scalar

Current longitudinal velocity of the vehicle, specified as a real scalar. Units are in meters per second.

- If the vehicle is in forward motion, then this value must be greater than 0.
- If the vehicle is in reverse motion, then this value must be less than 0.
- A value of 0 represents a vehicle that is not in motion.

Data Types: `single` | `double`

Direction — Driving direction of vehicle
1 (forward motion) | -1 (reverse motion)

Driving direction of the vehicle, specified as 1 for forward motion or -1 for reverse motion. The driving direction determines the position error and angle error used to compute the steering angle command. For more details, see “Algorithms” on page 2-59.

Curvature — Curvature of path
real scalar

Curvature of the path at the reference point, in radians per meter, specified as a real scalar.

- For a vehicle in forward motion, the reference point is the point on the path that is closest to the center of the vehicle's front axle.

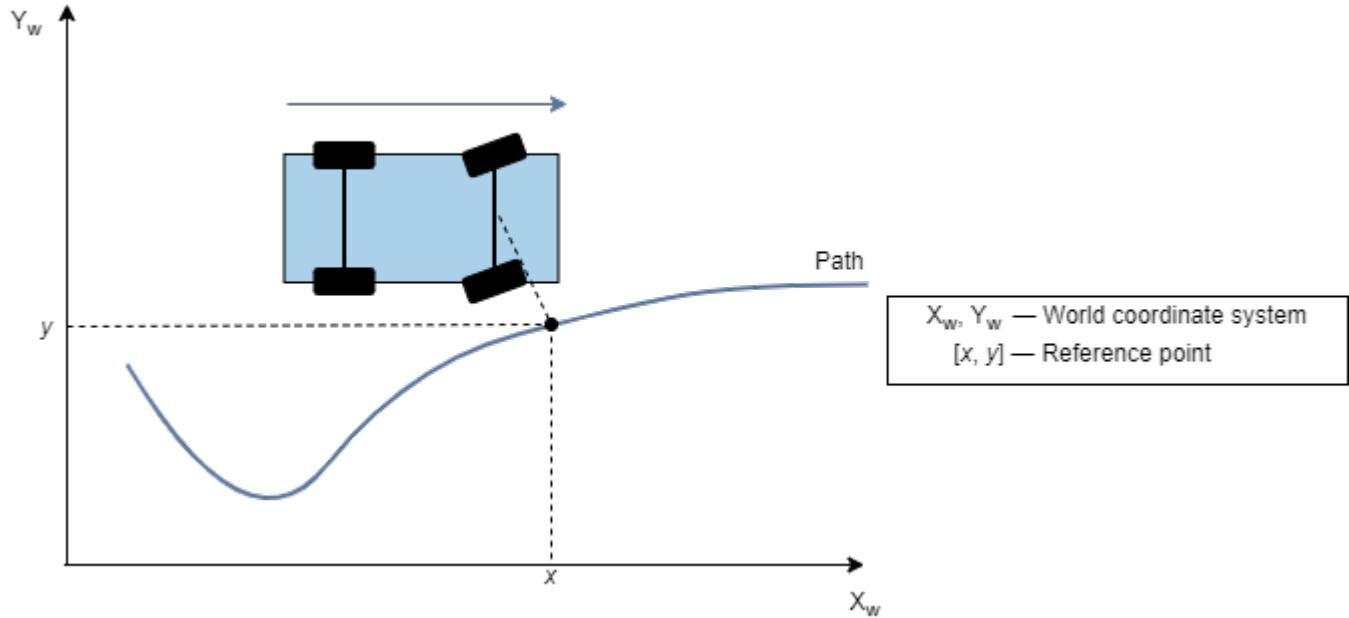

- For a vehicle in reverse motion, the reference point is the point on the path that is closest to the center of the vehicle's rear axle.

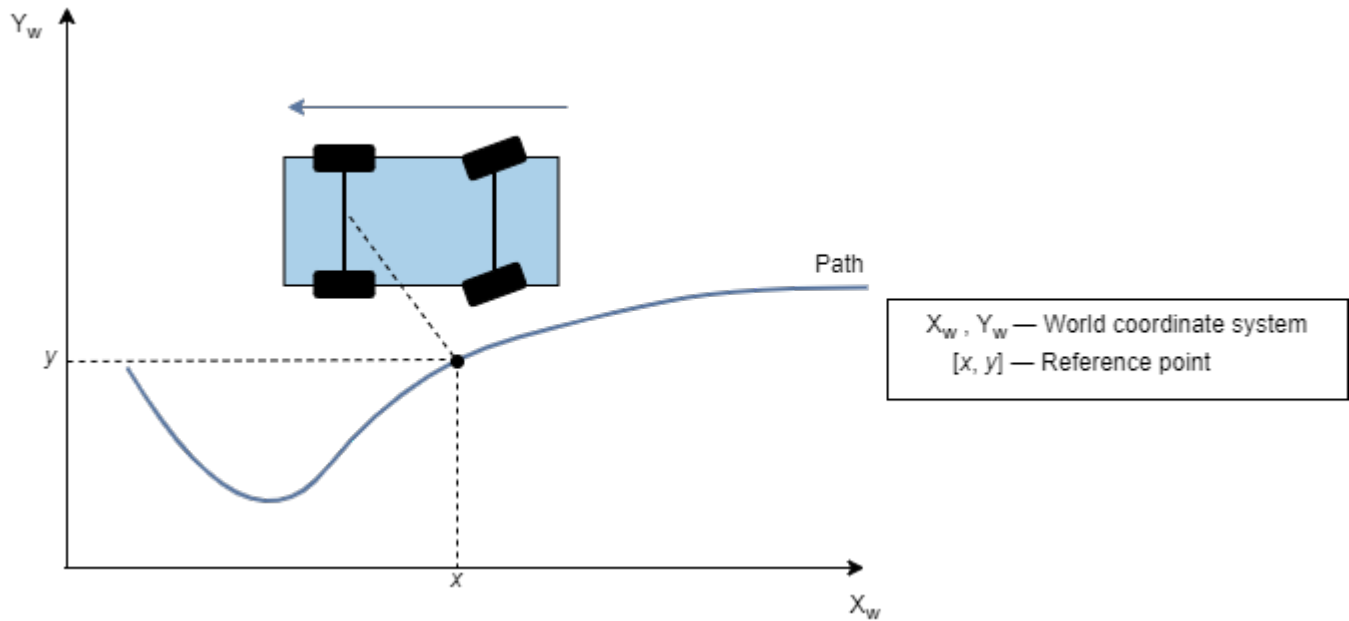

You can obtain the curvature of a path from the **Curvatures** output port of a Path Smoother Spline block. You can also obtain curvatures of lane boundaries from the output lane boundary structures of a Scenario Reader block.

Dependencies

To enable this port, set **Vehicle model** to `Dynamic bicycle model`.

CurrYawRate — Current yaw rate
real scalar

Current yaw rate of the vehicle, in degrees per second, specified as a real scalar. The current yaw rate is the rate of change in the angular velocity of the vehicle.

Dependencies

To enable this port, set **Vehicle model** to `Dynamic bicycle model`.

CurrSteer — Current steering angle
real scalar

Current steering angle of the vehicle, in degrees, specified as a real scalar. This value is positive in the counterclockwise direction.

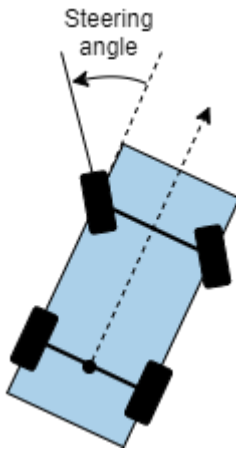

For more details, see “Coordinate Systems in Automated Driving Toolbox”.

Dependencies

To enable this port, set **Vehicle model** to `Dynamic bicycle model`.

Output

SteerCmd — Steering angle command
real scalar

Steering angle command, in degrees, returned as a real scalar. This value is positive in the counterclockwise direction.

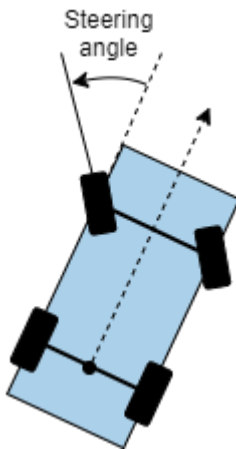

For more details, see “Coordinate Systems in Automated Driving Toolbox”.

Parameters

Vehicle model — Vehicle model

`Kinematic bicycle model (default)` | `Dynamic bicycle model`

Select the type of vehicle model to set the Stanley method control law used by the block.

- `Kinematic bicycle model` — Kinematic bicycle model for path following in low-speed environments such as parking lots, where inertial effects are minimal
- `Dynamic bicycle model` — Dynamic bicycle model for path following in high-speed environments such as highways, where inertial effects are more pronounced

Position gain of forward motion — Position gain of vehicle in forward motion

`2.5 (default)` | positive real scalar

Position gain of the vehicle when it is in forward motion, specified as a positive scalar. This value determines how much the position error affects the steering angle. Typical values are in the range [1, 5]. Increase this value to increase the magnitude of the steering angle.

Position gain of reverse motion — Position gain of vehicle in reverse motion

`2.5 (default)` | positive real scalar

Position gain of the vehicle when it is in reverse motion, specified as a positive scalar. This value determines how much the position error affects the steering angle. Typical values are in the range [1, 5]. Increase this value to increase the magnitude of the steering angle.

Yaw rate feedback gain — Yaw rate feedback gain

`2.5 (default)` | nonnegative real scalar

Yaw rate feedback gain, specified as a nonnegative real scalar. This value determines how much weight is given to the current yaw rate of the vehicle when the block computes the steering angle command.

Dependencies

To enable this parameter, set **Vehicle model** to `Dynamic bicycle model`.

Steering angle feedback gain — Steering angle feedback gain

2.5 (default) | nonnegative real scalar

Steering angle feedback gain, specified as a nonnegative real scalar. This value determines how much the difference between the current steering angle command, **SteerCmd**, and the current steering angle, **CurrSteer**, affects the next steering angle command.

Dependencies

To enable this parameter, set **Vehicle model** to `Dynamic bicycle model`.

Wheelbase of vehicle (m) — Distance between front and rear axle

2.8 (default) | real scalar

Distance between the front and rear axle of the vehicle, in meters, specified as a real scalar. This value applies only when the vehicle is in forward motion, that is, when the **Direction** input port is 1.

Dependencies

To enable this parameter, set **Vehicle model** to `Kinematic bicycle model`.

Vehicle mass (kg) — Vehicle mass

1575 (default) | positive real scalar

Vehicle mass, in kilograms, specified as a positive real scalar.

Dependencies

To enable this parameter, set **Vehicle model** to `Dynamic bicycle model`.

Longitudinal distance from center of mass to front axle (m) — Distance to front axle

1.2 (default) | positive real scalar

Longitudinal distance from the vehicle's center of mass to its front wheel axle, in meters, specified as a positive real scalar.

Dependencies

To enable this parameter, set **Vehicle model** to `Dynamic bicycle model`.

Longitudinal distance from center of mass to rear axle (m) — Distance to rear axle

1.6 (default) | positive real scalar

Longitudinal distance from the vehicle's center of mass to its rear wheel axle, in meters, specified as a positive real scalar.

Dependencies

To enable this parameter, set **Vehicle model** to `Dynamic bicycle model`.

Front tire corner stiffness (N/rad) — Cornering stiffness of front tires

19000 (default) | positive real scalar

Cornering stiffness of front tires, in Newtons per radian, specified as a positive real scalar.

Dependencies

To enable this parameter, set **Vehicle model** to `Dynamic bicycle model`.

Maximum steering angle (deg) — Maximum allowed steering angle

35 (default) | real scalar in the range (0, 180)

Maximum allowed steering angle of the vehicle, in degrees, specified as a real scalar in the range (0, 180).

The output from the **SteerCmd** port is saturated to the range $[-M, M]$, where M is the value of the **Maximum steering angle (deg)** parameter.

- Values below $-M$ are set to $-M$.
- Values above M are set to M .

Tips

- You can switch between bicycle models as the vehicle environment changes. Add two Lateral Controller Stanley blocks to a variant subsystem and specify a different bicycle model for each block. For an example, see “Lateral Control Tutorial”.

Algorithms

To compute the steering angle command, the controller minimizes the position error and the angle error of the current pose with respect to the reference pose. The driving direction of the vehicle determines these error values.

When the vehicle is in forward motion (**Direction** parameter is 1):

- The position error is the lateral distance from the center of the front axle to the reference point on the path.
- The angle error is the angle of the front wheel with respect to reference path.

When the vehicle is in reverse motion (**Direction** parameter is -1):

- The position error is the lateral distance from the center of the rear axle to the reference point on the path.
- The angle error is the angle of the rear wheel with respect to reference path.

For details on how the controller minimizes these errors for kinematic and dynamic bicycle models, see [1].

Version History

Introduced in R2018b

References

- [1] Hoffmann, Gabriel M., Claire J. Tomlin, Michael Montemerlo, and Sebastian Thrun. "Autonomous Automobile Trajectory Tracking for Off-Road Driving: Controller Design, Experimental Validation and Racing." *American Control Conference*. 2007, pp. 2296–2301. doi:10.1109/ACC.2007.4282788

Extended Capabilities

C/C++ Code Generation

Generate C and C++ code using Simulink® Coder™.

See Also

Blocks

Longitudinal Controller Stanley | Path Smoother Spline | Velocity Profiler

Functions

lateralControllerStanley

Objects

pathPlannerRRT

Topics

“Coordinate Systems in Automated Driving Toolbox”

Lidar Point Cloud Generator

Generate lidar point cloud data for driving scenario

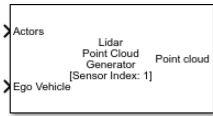

Libraries:

Automated Driving Toolbox / Driving Scenario and Sensor Modeling

Description

The Lidar Point Cloud Generator block generates a point cloud from lidar measurements taken by a lidar sensor mounted on an ego vehicle.

The block derives the point cloud from simulated roads and actor poses in a driving scenario and generates the point cloud at intervals equal to the sensor update interval. By default, detections are referenced to the coordinate system of the ego vehicle. The block can simulate added noise at a specified range accuracy by using a statistical model. The block also provides parameters to exclude the ego vehicle and roads from the generated point cloud.

The lidar generates point cloud data based on the mesh representations of the roads and actors in the scenario. A mesh is a 3-D geometry of an object that is composed of faces and vertices.

When building scenarios and sensor models using the **Driving Scenario Designer** app, the lidar sensors exported to Simulink are output as Lidar Point Cloud Generator blocks.

Limitations

- C/C++ code generation is not supported.
- For Each subsystems are not supported.
- Rapid acceleration mode is not supported.
- Use of the Detection Concatenation block with this block is not supported. You cannot concatenate point cloud data with detections from other sensors.
- If a model does not contain a Scenario Reader block, then this block does not include roads in the generated point cloud.
- Point cloud data is not generated for lane markings.

Ports

Input

Actors — Scenario actor poses

Simulink bus containing MATLAB structure

Scenario actor poses in ego vehicle coordinates, specified as a Simulink bus containing a MATLAB structure.

The structure must contain these fields.

Field	Description	Type
NumActors	Number of actors	Nonnegative integer
Time	Current simulation time	Real-valued scalar
Actors	Actor poses	NumActors-length array of actor pose structures

Each actor pose structure in `Actors` must have these fields.

Field	Description
ActorID	Scenario-defined actor identifier, specified as a positive integer.
Position	Position of actor, specified as a real-valued vector of the form $[x\ y\ z]$. Units are in meters.
Velocity	Velocity (v) of actor in the x - y -, and z -directions, specified as a real-valued vector of the form $[v_x\ v_y\ v_z]$. Units are in meters per second.
Roll	Roll angle of actor, specified as a real-valued scalar. Units are in degrees.
Pitch	Pitch angle of actor, specified as a real-valued scalar. Units are in degrees.
Yaw	Yaw angle of actor, specified as a real-valued scalar. Units are in degrees.
AngularVelocity	Angular velocity (ω) of actor in the x -, y -, and z -directions, specified as a real-valued vector of the form $[\omega_x\ \omega_y\ \omega_z]$. Units are in degrees per second.

Ego Vehicle — Ego vehicle pose

Simulink bus containing MATLAB structure

Ego vehicle pose, specified as a Simulink bus containing a MATLAB structure.

The structure must have these fields.

Field	Description
ActorID	Scenario-defined actor identifier, specified as a positive integer.
Position	Position of actor, specified as a real-valued vector of the form $[x\ y\ z]$. Units are in meters.
Velocity	Velocity (v) of actor in the x - y -, and z -directions, specified as a real-valued vector of the form $[v_x\ v_y\ v_z]$. Units are in meters per second.
Roll	Roll angle of actor, specified as a real-valued scalar. Units are in degrees.
Pitch	Pitch angle of actor, specified as a real-valued scalar. Units are in degrees.

Field	Description
Yaw	Yaw angle of actor, specified as a real-valued scalar. Units are in degrees.
AngularVelocity	Angular velocity (ω) of actor in the x -, y -, and z -directions, specified as a real-valued vector of the form $[\omega_x \ \omega_y \ \omega_z]$. Units are in degrees per second.

You can output the ego vehicle pose from a Scenario Reader block. In the Scenario Reader block used in your model, select the **Output ego vehicle pose** parameter.

Output

Point Cloud — Point cloud data

m -by- n -by-3 array of positive real-valued $[x, y, z]$ points

Point cloud data, returned as an m -by- n -by-3 array of positive real-valued $[x, y, z]$ points. m is the number of elevation (vertical) channels in the point cloud. n is the number of azimuthal (horizontal) channels in the point cloud. m and n define the number of points in the point cloud, as shown in this equation:

$$m \times n = \frac{V_{FOV}}{V_{RES}} \times \frac{H_{FOV}}{H_{RES}}$$

- V_{FOV} is the vertical field of view of the lidar, in degrees, as specified by the **Elevation limits of lidar (deg)** parameter.
- V_{RES} is the vertical angular resolution of the lidar, in degrees, as specified by the **Elevation resolution of lidar (deg)** parameter.
- H_{FOV} is the horizontal field of view of the lidar, in degrees, as specified by the **Azimuthal limits of lidar (deg)** parameter.
- H_{RES} is the horizontal angular resolution of the lidar, in degrees, as specified by the **Azimuthal resolution of lidar (deg)** parameter.

Each m -by- n entry in the array specifies the x -, y -, and z -coordinates of a detected point in the ego vehicle coordinate system. If the lidar does not detect a point at a given coordinate, then x , y , and z are returned as NaN.

By default, the Lidar Point Cloud Generator block includes road data in the generated point cloud. The block obtains the road data in world coordinates from a Scenario Reader block that is in the same model as the Lidar Point Cloud Generator block. The Lidar Point Cloud Generator block computes the road mesh in ego vehicle coordinates based on the road data and the ego vehicle pose at the **Ego Vehicle** input port. The **Maximum detection range (m)** parameter of the Lidar Point Cloud Generator block determines the extent of the road mesh. To exclude road data from the point cloud, clear the **Include roads in generated point cloud** parameter.

Parameters

Parameters

Sensor Identification

Unique identifier of sensor — Unique sensor identifier

1 (default) | positive integer

Unique sensor identifier, specified as a positive integer. The sensor identifier distinguishes detections that come from different sensors in a multisensor system. If a model contains multiple sensor blocks that have the same sensor identifier, the **Bird's-Eye Scope** displays an error.

Required interval between sensor updates (s) — Required time interval between sensor updates

0.1 (default) | positive scalar

Required time interval between sensor updates, specified as a positive scalar. The value of this parameter must be an integer multiple of the **Actors** input port data interval. Updates requested from the sensor between update intervals contain no detections. Units are in seconds.

Sensor Extrinsic

Sensor's (x,y) position (m) — Location of center of lidar sensor

[1.5 0] (default) | real-valued 1-by-2 vector

Location of the center of the lidar sensor, specified as a real-valued 1-by-2 vector. The **Sensor's (x,y) position (m)** and **Sensor's height (m)** parameters define the coordinates of the lidar sensor with respect to the ego vehicle coordinate system. The default value corresponds to a lidar sensor mounted on a sedan, at the center of the roof's front edge. Units are in meters.

Sensor's height (m) — Height of lidar sensor

1.6 (default) | positive scalar

Height of the lidar sensor above the ground plane, specified as a positive scalar. The **Sensor's (x,y) position (m)** and **Sensor's height (m)** parameters define the coordinates of the lidar sensor with respect to the ego vehicle coordinate system. The default value corresponds to a lidar sensor mounted on a sedan, at the center of the roof front edge. Units are in meters.

Yaw angle of sensor mounted on ego vehicle (deg) — Yaw angle of lidar sensor

0 (default) | real-valued scalar

Yaw angle of the lidar sensor, specified as a real-valued scalar. The yaw angle is the angle between the center line of the ego vehicle and the downrange axis of the lidar sensor. A positive yaw angle corresponds to a clockwise rotation when you look in the positive direction of the z-axis of the ego vehicle coordinate system. Units are in degrees.

Pitch angle of sensor mounted on ego vehicle (deg) — Pitch angle of lidar sensor

0 (default) | real-valued scalar

Pitch angle of the lidar sensor, specified as a real-valued scalar. The pitch angle is the angle between the downrange axis of the lidar sensor and the xy-plane of the ego vehicle coordinate system. A positive pitch angle corresponds to a clockwise rotation when you look in the positive direction of the y-axis of the ego vehicle coordinate system. Units are in degrees.

Roll angle of sensor mounted on ego vehicle (deg) — Roll angle of lidar sensor

0 (default) | real-valued scalar

Roll angle of the lidar sensor, specified as a real-valued scalar. The roll angle is the angle of rotation of the downrange axis of the lidar sensor around the x-axis of the ego vehicle coordinate system. A positive roll angle corresponds to a clockwise rotation when you look in the positive direction of the x-axis of the ego vehicle coordinate system. Units are in degrees.

Point Cloud Reporting

Coordinate system used to report point cloud — Coordinate system of reported detections

Ego Cartesian (default) | Sensor Cartesian

Coordinate system of reported detections, specified as one of these values:

- Ego Cartesian — Detections are reported in the ego vehicle Cartesian coordinate system.
- Sensor Cartesian — Detections are reported in the sensor Cartesian coordinate system.

Include ego vehicle in generated point cloud — Include ego vehicle in point cloud

on (default) | off

Select this parameter to include the ego vehicle in the generated point cloud.

ActorID of ego vehicle — ActorID value of ego vehicle

1 (default) | positive integer

ActorID value of the ego vehicle, specified as a positive integer. ActorID is the unique identifier for an actor. This parameter must be a valid ActorID from the input **Actor** bus.

Dependencies

To enable this parameter, select the **Include ego vehicle in generated point cloud** parameter.

Include roads in generated point cloud — Include roads in point cloud

on (default) | off

Select this parameter to include the roads in the generated point cloud.

Source of actor profiles — Source of actor profiles

From Scenario Reader block (default) | From workspace

Source of actor profiles, which are the physical and radar characteristics of all actors in the driving scenario, specified as one of these options:

- From Scenario Reader block — The block obtains the actor profiles from the scenario specified by the Scenario Reader block.
- From workspace — The block obtains the actor profiles from the MATLAB or model workspace variable specified by the **MATLAB or model workspace variable name** parameter.

MATLAB or model workspace variable name — Variable name of actor profiles

actor_profiles (default) | valid variable name

Variable name of actor profiles, specified as the name of a MATLAB or model workspace variable containing actor profiles.

Actor profiles are the physical and radar characteristics of all actors in a driving scenario and are specified as a structure or structure array.

- If the actor profiles variable contains a single structure, then all actors specified in the input **Actors** bus use this profile.
- If the actor profiles variable is a structure array, then each actor specified in the input **Actors** bus must have a unique actor profile.

To generate an array of structures for your driving scenario, use the `actorProfiles` function. The table shows the valid structure fields. If you do not specify a field, the fields are set to their default values.

Field	Description
ActorID	Scenario-defined actor identifier, specified as a positive integer.
ClassID	Classification identifier, specified as a nonnegative integer. 0 represents an object of an unknown or unassigned class.
Length	Length of actor, specified as a positive real-valued scalar. Units are in meters.
Width	Width of actor, specified as a positive real-valued scalar. Units are in meters.
Height	Height of actor, specified as a positive real-valued scalar. Units are in meters.
OriginOffset	Offset of actor's rotational center from its geometric center, specified as a real-valued vector of the form $[x, y, z]$. The rotational center, or origin, is located at the bottom center of the actor. For vehicles, the rotational center is the point on the ground beneath the center of the rear axle. Units are in meters.
MeshVertices	Mesh vertices of actor, specified as an n -by-3 real-valued matrix of vertices. Each row in the matrix defines a point in 3-D space.
MeshFaces	Mesh faces of actor, specified as an m -by-3 matrix of integers. Each row of <code>MeshFaces</code> represents a triangle defined by the vertex IDs, which are the row numbers of vertices.
RCSPattern	Radar cross-section (RCS) pattern of actor, specified as a <code>numel(RCSElevationAngles)</code> -by- <code>numel(RCSAzimuthAngles)</code> real-valued matrix. Units are in decibels per square meter.
RCSAzimuthAngles	Azimuth angles corresponding to rows of <code>RCSPattern</code> , specified as a vector of values in the range $[-180, 180]$. Units are in degrees.

Field	Description
RCSElevationAngles	Elevation angles corresponding to rows of RCSPattern, specified as a vector of values in the range [-90, 90]. Units are in degrees.

For complete definitions of the structure fields, see the `actor` and `vehicle` functions.

Dependencies

To enable this parameter, set the **Source of actor profiles** parameter to `From workspace`.

Measurements

Settings

Maximum detection range (m) — Maximum detection range

120 (default) | positive scalar

Maximum detection range of the lidar sensor, specified as a positive scalar. The sensor cannot detect actors beyond this range. This parameter also determines the extent of the road mesh. Units are in meters.

Range accuracy (m) — Accuracy of range measurements

0.002 (default) | positive scalar

Accuracy of range measurements, specified as a positive scalar. Units are in meters.

Azimuthal resolution of lidar (deg) — Azimuthal resolution of lidar sensor

0.16 (default) | positive scalar

Azimuthal resolution of the lidar sensor, specified as a positive scalar. The azimuthal resolution defines the minimum separation in azimuth angle at which the lidar can distinguish between two targets. Units are in degrees.

Elevation resolution of lidar (deg) — Elevation resolution of lidar sensor

1.25 (default) | positive scalar

Elevation resolution of the lidar sensor, specified as a positive scalar. The elevation resolution defines the minimum separation in elevation angle at which the lidar can distinguish between two targets. Units are in degrees.

Azimuthal limits of lidar (deg) — Azimuthal limits of lidar sensor

[-180 180] (default) | 1-by-2 real-valued vector of form [*min*, *max*]

Azimuthal limits of the lidar sensor, specified as a 1-by-2 real-valued vector of the form [*min*, *max*]. Units are in degrees.

Elevation limits of lidar (deg) — Elevation limits of lidar sensor

[-20 20] (default) | 1-by-2 real-valued vector of form [*min*, *max*]

Elevation limits of the lidar sensor, specified as a 1-by-2 real-valued vector of the form [*min*, *max*]. Units are in degrees.

Add noise to measurements — Add noise to measurements

on (default) | off

Select this parameter to add noise to lidar sensor measurements. When you clear this parameter, the measurements have no noise.

Version History

Introduced in R2020b

See Also

Apps

Bird's-Eye Scope

Blocks

Scenario Reader | Simulation 3D Lidar | Driving Radar Data Generator | Vision Detection Generator

Objects

lidarPointCloudGenerator

Longitudinal Controller Stanley

Control longitudinal velocity of vehicle by using Stanley method

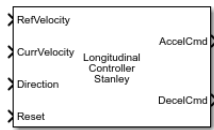

Libraries:
Automated Driving Toolbox / Vehicle Control

Description

The Longitudinal Controller Stanley block computes the acceleration and deceleration commands, in meters per second, that control the velocity of the vehicle. Specify the reference velocity, current velocity, and current driving direction. The controller computes these commands using the Stanley method [1], which the block implements as a discrete proportional-integral (PI) controller with integral anti-windup. For more details, see “Algorithms” on page 2-70.

You can also compute the steering angle command of a vehicle using the Stanley method. See the Lateral Controller Stanley block.

Ports

Input

RefVelocity — Reference velocity
real scalar

Reference velocity, in meters per second, specified as a real scalar.

CurrVelocity — Current velocity
real scalar

Current velocity of the vehicle, in meters per second, specified as a real scalar.

Direction — Driving direction
1 (forward motion) | -1 (reverse motion)

Driving direction of vehicle, specified as 1 for forward motion and -1 for reverse motion.

Reset — Trigger to reset integral of velocity error
0 (hold steady) | nonzero scalar (reset)

Trigger to reset the integral of velocity error, $e(k)$, to zero. A value of 0 holds $e(k)$ steady. A nonzero value resets $e(k)$.

Output

AccelCmd — Acceleration command
real scalar in the range $[0, M_A]$

Acceleration command, returned as a real scalar in the range $[0, M_A]$, where M_A is the value of the **Maximum longitudinal acceleration (m/s²)** parameter.

DecelCmd — Deceleration command
real scalar in the range $[0, M_D]$

Deceleration command, returned as a real scalar in the range $[0, M_D]$, where M_D is the value of the **Maximum longitudinal deceleration (m/s²)** parameter.

Parameters

Proportional gain, Kp — Proportional gain

2.5 (default) | positive real scalar

Proportional gain of controller, K_p , specified as a positive real scalar.

Integral gain, Ki — Integral gain

1 (default) | positive real scalar

Integral gain of controller, K_i , specified as a positive real scalar.

Sample time (s) — Sample time

0.05 (default) | positive real scalar

Sample time of controller, in seconds, specified as a positive real scalar.

Maximum longitudinal acceleration (m/s²) — Maximum longitudinal acceleration

3 (default) | positive real scalar

Maximum longitudinal acceleration, in meters per second squared, specified as a positive real scalar.

The block saturates the output from the **AccelCmd** to the range $[0, M_A]$, where M_A is the value of this parameter. Values above M_A are set to M_A .

Maximum longitudinal deceleration (m/s²) — Maximum longitudinal deceleration

6 (default) | positive real scalar

Maximum longitudinal deceleration, in meters per second squared, specified as a positive real scalar.

The block saturates the output from the **DecelCmd** port to the range $[0, M_D]$, where M_D is the value of this parameter. Values above M_D are set to M_D .

Algorithms

The Longitudinal Controller Stanley block implements a discrete proportional-integral (PI) controller with integral anti-windup, as described by the “Anti-windup method” (Simulink) parameter of the PID Controller block. The block uses this equation:

$$u(k) = (K_p + K_i \frac{T_s z}{z-1}) e(k)$$

- $u(k)$ is the control signal at the k th time step.
- K_p is the proportional gain, as set by the **Proportional gain, Kp** parameter.
- K_i is the integral gain, as set by the **Integral gain, Ki** parameter.
- T_s is the sample time of the block in seconds, as set by the **Sample time (s)** parameter.
- $e(k)$ is the velocity error (**CurrVelocity - RefVelocity**) at the k th time step. For each k , this error is equal to the difference between the current velocity and reference velocity inputs (**CurrVelocity - RefVelocity**).

The control signal, u , determines the value of acceleration command **AccelCmd** and deceleration command **DecelCmd**. The block saturates the acceleration and deceleration commands to respective ranges of $[0, M_A]$ and $[0, M_D]$, where:

- M_A is value of the **Maximum longitudinal acceleration (m/s²)** parameter.
- M_D is the value of the **Maximum longitudinal deceleration (m/s²)** parameter.

At each time step, only one of the **AccelCmd** and **DecelCmd** port values is positive, and the other port value is \emptyset . In other words, the vehicle can either accelerate or decelerate in one time step, but it cannot do both at one time.

The direction of motion, as specified in the **Direction** input port, determines which command is positive at the given time step.

Direction Port Value	Control Signal Value $u(k)$	AccelCmd Port Value	DecelCmd Port Value	Description
1 (forward motion)	$u(k) > 0$	positive real scalar	\emptyset	Vehicle speeds up as it travels forward
	$u(k) < 0$	\emptyset	positive real scalar	Vehicle slows down as it travels forward
-1 (reverse motion)	$u(k) > 0$	\emptyset	positive real scalar	Vehicle slows down as it travels in reverse
	$u(k) < 0$	positive real scalar	\emptyset	Vehicle speeds up as it travels in reverse

Version History

Introduced in R2019a

References

- [1] Hoffmann, Gabriel M., Claire J. Tomlin, Michael Montemerlo, and Sebastian Thrun. "Autonomous Automobile Trajectory Tracking for Off-Road Driving: Controller Design, Experimental Validation and Racing." *American Control Conference*. August 2007, pp. 2296-2301. doi:10.1109/ACC.2007.4282788.

Extended Capabilities

C/C++ Code Generation

Generate C and C++ code using Simulink® Coder™.

See Also

Blocks

Lateral Controller Stanley | Path Smoother Spline | PID Controller | Velocity Profiler

Multi-Object Tracker

Create and manage tracks of multiple objects

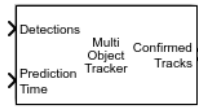

Libraries:
Automated Driving Toolbox

Description

The Multi-Object Tracker block initializes, confirms, predicts, corrects, and deletes the tracks of moving objects. Inputs to the multi-object tracker are detection reports generated by Driving Radar Data Generator and Vision Detection Generator blocks. The multi-object tracker accepts detections from multiple sensors and assigns them to tracks using a global nearest neighbor (GNN) criterion. Each detection is assigned to a separate track. If the detection cannot be assigned to any track, the multi-object tracker creates a new track.

A new track starts in a *tentative* state. If enough detections are assigned to a tentative track, its status changes to *confirmed*. When a track is confirmed, the multi-object tracker considers that track to represent a physical object. If detections are not added to the track within a specifiable number of updates, the track is deleted.

The multi-object tracker also estimates the state vector and state vector covariance matrix for each track using a Kalman filter. These state vectors are used to predict a track's location in each frame and determine the likelihood of each detection being assigned to each track.

Ports

Input

Detections — Detection list

Simulink bus containing MATLAB structure

Detection list, specified as a Simulink bus containing a MATLAB structure. See “Group Signals or Messages into Virtual Buses” (Simulink). The structure has the form:

Field	Description	Type
NumDetections	Number of detections	integer
IsValidTime	False when updates are requested at times that are between block invocation intervals	Boolean
Detections	Object detections	Array of object detection structures. The first NumDetections of these detections are actual detections.

The definitions of the object detection structures are found in the **Detections** output port descriptions of the Driving Radar Data Generator and Vision Detection Generator blocks.

Note The object detection structure contains a `Time` field. The time tag of each object detection must be less than or equal to the time of the current invocation of the block. The time tag must also be greater than the update time specified in the previous invocation of the block.

Prediction Time — Track update time
real scalar

Track update time, specified as a real scalar. The multi-object tracker updates all tracks to this time. Update time must always increase with each invocation of the block. Units are in seconds.

Note The object detection structure contains a `Time` field. The time tag of each object detection must be less than or equal to the time of the current invocation of the block. The time tag must also be greater than the update time in the previous invocation of the block.

Dependencies

To enable this port, set **Prediction time source** to `Input` port.

Cost Matrix — Cost matrix
real-valued N_t -by- N_d matrix

Cost matrix, specified as a real-valued N_t -by- N_d matrix, where N_t is the number of existing tracks and N_d is the number of current detections.

The rows of the cost matrix correspond to the existing tracks. The columns correspond to the detections. Tracks are ordered as they appear in the list of tracks in the **All Tracks** output port of the previous invocation of the block.

In the first update to the multi-object tracker, or if the track has no previous tracks, assign the cost matrix a size of $[0, N_d]$. The cost must be calculated so that lower costs indicate a higher likelihood that the multi-object tracker assigns a detection to a track. To prevent certain detections from being assigned to certain tracks, use `Inf`.

Dependencies

To enable this port, select **Enable cost matrix input**.

Detectable Track IDs — Detectable track IDs
real-valued M -by-1 vector | real-valued M -by-2 matrix

Detectable track IDs, specified as a real-valued M -by-1 vector or M -by-2 matrix. Detectable tracks are tracks that the sensors expect to detect. The first column of the matrix contains a list of track IDs that the sensors report as detectable. The optional second column contains the detection probability for the track.

Tracks whose identifiers are not included in **Detectable Track IDs** are considered undetectable. The track deletion logic does not count the lack of detection as a "missed detection" for track deletion purposes.

If this port is not enabled, the tracker assumes all tracks to be detectable at each invocation of the block.

Dependencies

To enable this port, in the **Port Setting** tab, select **Enable detectable track IDs Input**.

State Parameters — Track state parameters

Simulink bus containing MATLAB structure

Track state parameters, specified as a Simulink bus containing a MATLAB structure. The structure has the form:

Field	Description
NumParameters	Number of non-default state parameters, specified as a nonnegative integer
Parameters	Array of state parameter structures

The block uses the value of the `Parameters` field for the `StateParameters` field of the generated tracks. You can use these parameters to define the reference frame in which the track is reported or other desirable attributes of the generated tracks.

For example, you can use the following structure to define a rectangular reference frame whose origin position is at $[10 \ 10 \ 0]$ meters and whose origin velocity is $[2 \ -2 \ 0]$ meters per second with respect to the scenario frame.

Field Name	Value
Frame	"Rectangular"
Position	$[10 \ 10 \ 0]$
Velocity	$[2 \ -2 \ 0]$

Dependencies

To enable this port, in the **Tracker Configuration** tab, select the **Update track state parameters with time** parameter.

Output

Confirmed Tracks — Confirmed tracks

Simulink bus containing MATLAB structure

Confirmed tracks, returned as a Simulink bus containing a MATLAB structure. See “Create Nonvirtual Buses” (Simulink).

This table shows the structure fields.

Field	Description
NumTracks	Number of tracks
Tracks	Array of track structures of a length set by the Maximum number of tracks parameter. Only the first NumTracks of these are actual tracks.

This table shows the fields of each track structure.

Field	Definition
TrackID	Unique track identifier used to distinguish multiple tracks.
BranchID	Unique track branch identifier used to distinguish multiple track branches.
SourceIndex	Unique source index used to distinguish tracking sources in a multiple tracker environment.
UpdateTime	Time at which the track is updated. Units are in seconds.
Age	Number of times the track was updated.
State	Value of state vector at the update time.
StateCovariance	Uncertainty covariance matrix.
ObjectClassID	Integer value representing the object classification. The value 0 represents an unknown classification. Nonzero classifications apply only to confirmed tracks.
TrackLogic	Confirmation and deletion logic type. This value is always 'History' for radar sensors, to indicate history-based logic.
TrackLogicState	Current state of the track logic type, returned as a 1-by-K logical array. K is the number of latest track logical states recorded. In the array, 1 denotes a hit and 0 denotes a miss.
IsConfirmed	Confirmation status. This field is true if the track is confirmed to be a real target.
IsCoasted	Coasting status. This field is true if the track is updated without a new detection.
IsSelfReported	Indicate if the track is reported by the tracker. This field is used in a track fusion environment. It is returned as true by default.
ObjectAttributes	Additional information about the track.

For more details about these fields, see `objectTrack`.

A track is confirmed if:

- At least M detections are assigned to the track during the first N updates after track initialization. To specify the values M and N , use the **M and N for the M-out-of-N confirmation** parameter.
- The detection initiating the track has an `ObjectClassID` greater than zero.

Tentative Tracks — Tentative tracks

Simulink bus containing MATLAB structure

Tentative tracks, returned as a Simulink bus containing a MATLAB structure. See “Create Nonvirtual Buses” (Simulink). A track is tentative before it is confirmed.

This table shows the structure fields.

Field	Description
NumTracks	Number of tracks
Tracks	Array of track structures of a length set by the Maximum number of tracks parameter. Only the first NumTracks of these are actual tracks.

This table shows the fields of each track structure.

Field	Definition
TrackID	Unique track identifier used to distinguish multiple tracks.
BranchID	Unique track branch identifier used to distinguish multiple track branches.
SourceIndex	Unique source index used to distinguish tracking sources in a multiple tracker environment.
UpdateTime	Time at which the track is updated. Units are in seconds.
Age	Number of times the track was updated.
State	Value of state vector at the update time.
StateCovariance	Uncertainty covariance matrix.
ObjectClassID	Integer value representing the object classification. The value 0 represents an unknown classification. Nonzero classifications apply only to confirmed tracks.
TrackLogic	Confirmation and deletion logic type. This value is always 'History' for radar sensors, to indicate history-based logic.
TrackLogicState	Current state of the track logic type, returned as a 1-by-K logical array. K is the number of latest track logical states recorded. In the array, 1 denotes a hit and 0 denotes a miss.
IsConfirmed	Confirmation status. This field is true if the track is confirmed to be a real target.
IsCoasted	Coasting status. This field is true if the track is updated without a new detection.
IsSelfReported	Indicate if the track is reported by the tracker. This field is used in a track fusion environment. It is returned as true by default.
ObjectAttributes	Additional information about the track.

For more details about these fields, see `objectTrack`.

Dependencies

To enable this port, select **Enable tentative tracks output**.

All Tracks — All tracks

Simulink bus containing MATLAB structure

Combined list of confirmed and tentative tracks, returned as a Simulink bus containing a MATLAB structure. See “Create Nonvirtual Buses” (Simulink).

This table shows the structure fields.

Field	Description
NumTracks	Number of tracks
Tracks	Array of track structures of a length set by the Maximum number of tracks parameter. Only the first NumTracks of these are actual tracks.

This table shows the fields of each track structure.

Field	Definition
TrackID	Unique track identifier used to distinguish multiple tracks.
BranchID	Unique track branch identifier used to distinguish multiple track branches.
SourceIndex	Unique source index used to distinguish tracking sources in a multiple tracker environment.
UpdateTime	Time at which the track is updated. Units are in seconds.
Age	Number of times the track was updated.
State	Value of state vector at the update time.
StateCovariance	Uncertainty covariance matrix.
ObjectClassID	Integer value representing the object classification. The value 0 represents an unknown classification. Nonzero classifications apply only to confirmed tracks.
TrackLogic	Confirmation and deletion logic type. This value is always 'History' for radar sensors, to indicate history-based logic.
TrackLogicState	Current state of the track logic type, returned as a 1-by-K logical array. K is the number of latest track logical states recorded. In the array, 1 denotes a hit and 0 denotes a miss.
IsConfirmed	Confirmation status. This field is true if the track is confirmed to be a real target.
IsCoasted	Coasting status. This field is true if the track is updated without a new detection.
IsSelfReported	Indicate if the track is reported by the tracker. This field is used in a track fusion environment. It is returned as true by default.

Field	Definition
ObjectAttributes	Additional information about the track.

For more details about these fields, see `objectTrack`.

Dependencies

To enable this port, select **Enable all tracks output**.

Parameters

Tracker Management

Tracker identifier — Unique tracker identifier

0 (default) | nonnegative integer

Unique tracker identifier, specified as a nonnegative integer. This parameter is used as the `SourceIndex` in the outputs, and distinguishes tracks that come from different trackers in a multiple-tracker system. You must specify this property as a positive integer to use the track outputs as inputs to a track fuser.

Example: 1

Filter initialization function name — Kalman filter initialization function

`initcvkf` (default) | function name

Kalman filter initialization function, specified as a function name. The toolbox provides several initialization functions. For an example of an initialization function, see `initcvkf`.

Threshold for assigning detections to tracks — Detection assignment threshold

30.0 (default) | positive real scalar

Detection assignment threshold, specified as a positive real scalar. To assign a detection to a track, the detection's normalized distance from the track must be less than the assignment threshold. If some detections remain unassigned to tracks that you want them assigned to, then increase the threshold. If some detections are assigned to incorrect tracks, decrease the threshold.

M and N for the M-out-of-N confirmation — Confirmation parameters for track creation

[2, 3] (default) | two-element vector of positive integers

Confirmation parameters for track creation, specified as a two-element vector of positive integers, [M, N]. A track is confirmed when at least M detections are assigned to the track during the first N updates after track initialization. M must be less than or equal to N.

- When setting N, consider the number of times you want the tracker to update before it confirms a track. For example, if a tracker updates every 0.05 seconds, and you allow 0.5 seconds to make a confirmation decision, set N = 10.
- When setting M, take into account the probability of object detection for the sensors. The probability of detection depends on factors such as occlusion or clutter. You can reduce M when tracks fail to be confirmed or increase M when too many false detections are assigned to tracks.

Example: [3, 5]

P and R for the P-out-of-R deletion — Track deletion threshold

[5 5] (default) | real-valued 1-by-2 vector of positive integers

Track deletion threshold for history logic, specified as a real-valued 1-by-2 vector of positive integers [P R]. If a confirmed track is not assigned to any detection P times in the last R tracker updates, then the track is deleted.

Maximum number of tracks — Maximum number of tracks

200 (default) | positive integer

Maximum number of tracks that the block can process, specified as a positive integer.

Maximum number of sensors — Maximum number of sensors

20 (default) | positive integer

Maximum number of sensors that the block can process, specified as a positive integer. This value should be greater than or equal to the highest `SensorIndex` value used in the **Detections** input port.

Out-of-sequence measurements handling — Out-of-sequence measurements handling

Terminate (default) | neglect

Out-of-sequence measurements handling, specified as `Terminate` or `neglect`. Each detection has a timestamp associated with it, t_d , and the tracker block has its own timestamp, t_t , which is updated in each invocation. The tracker block considers a measurement as an OOSM if $t_d < t_t$.

When the parameter is specified as:

- `Terminate` — The block stops running when it encounters any out-of-sequence measurements.
- `Neglect` — The block neglects any out-of-sequence measurements and continues to run.

Track state parameters — Parameters of track state reference frame

structure | structure array

Specify the parameters of the track state reference frame as a structure or a structure array. The block passes the value of this parameter to the `StateParameters` field of the generated tracks. You can use these parameters to define the reference frame in which the track is reported or other desirable attributes of the generated tracks.

For example, you can use the following structure to define a rectangular reference frame whose origin position is at [10 10 0] meters and whose origin velocity is [2 -2 0] meters per second with respect to the scenario frame.

Field Name	Value
Frame	"Rectangular"
Position	[10 10 0]

Field Name	Value
Velocity	[2 -2 0]

You can update the track state parameters through the **State Parameters** input port by selecting the **Update track state parameters with time** parameter.

Data Types: struct

Update track state parameters with time — Update track state parameters with time

off (default) | on

Select this parameter to enable the input port for track state parameters through the **State Parameters** input port.

Inputs and Outputs

Prediction time source — Source for prediction time

Input port (default) | Auto

Source for prediction time, specified as `Input port` or `Auto`. Select `Input port` to input an update time by using the **Prediction Time** input port. Otherwise, the simulation clock managed by Simulink determines the update time.

Example: Auto

Enable cost matrix input — Enable input port for cost matrix

off (default) | on

Select this check box to enable the input of a cost matrix by using the **Cost Matrix** input port.

Enable detectable track IDs input — Enable detectable track IDs input

off (default) | on

Select this check box to enable the **Detectable Track IDs** input port.

Source of output bus name — Source of output bus name

Auto (default) | Property

Source of output bus name, specified as `Auto` or `Property`.

- If you select `Auto`, the block automatically creates a bus name.
- If you select `Property`, specify the bus name using the **Specify an output bus name** parameter.

Specify an output bus name — Name of output bus

no default

Dependencies

To enable this parameter, set the **Source of output bus name** parameter to `Property`.

Enable tentative tracks output — Enable output port for tentative tracks

off (default) | on

Select this check box to enable the output of tentative tracks by using the **Tentative Tracks** output port.

Enable all tracks output — Enable output port for all tracks

off (default) | on

Select this check box to enable the output of all the tracks by using the **All Tracks** output port.

Simulate using — Type of simulation to run

Interpreted execution (default) | Code generation

- **Interpreted execution** — Simulate the model using the MATLAB interpreter. This option shortens startup time. In **Interpreted execution** mode, you can debug the source code of the block.
- **Code generation** — Simulate the model using generated C/C++ code. The first time you run a simulation, Simulink generates C/C++ code for the block. The C code is reused for subsequent simulations as long as the model does not change. This option requires additional startup time.

Version History

Introduced in R2017b

Extended Capabilities

C/C++ Code Generation

Generate C and C++ code using Simulink® Coder™.

- When the filter initialization function specified in the block returns a `trackingEKF` or `trackingUKF` object, the block supports static memory allocation code generation.
- In code generation, if the detection inputs are specified in `double` precision, then the `NumTracks` field of the track outputs is returned as a `double` variable. If the detection inputs are specified in `single` precision, then the `NumTracks` field of the track outputs is returned as a `uint32` variable.

See Also

Apps

Bird's-Eye Scope

Blocks

Scenario Reader | Driving Radar Data Generator | Detection Concatenation | Vision Detection Generator

Objects

`multiObjectTracker`

Path Smoother Spline

Smooth vehicle path using cubic spline interpolation

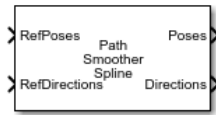

Libraries:
Automated Driving Toolbox

Description

The Path Smoother Spline block generates a smooth vehicle path, consisting of a sequence of discretized poses, by fitting the input reference path poses to a cubic spline. Given the input reference path directions, the block also returns the directions that correspond to each pose.

Use this block to convert a C^1 -continuous path to a C^2 -continuous path. C^1 -continuous paths include Dubins or Reeds-Shepp paths that are returned by path planners. For more details on these path types, see “ C^1 -Continuous and C^2 -Continuous Paths” on page 2-85.

You can use the returned poses and directions with a vehicle controller, such as the Lateral Controller Stanley block.

Ports

Input

RefPoses — Reference poses
 M -by-3 matrix of $[x, y, \theta]$ vectors

Reference poses of the vehicle along the path, specified as an M -by-3 matrix of $[x, y, \theta]$ vectors, where M is the number of poses.

x and y specify the location of the vehicle in meters. θ specifies the orientation angle of the vehicle in degrees.

Data Types: `single` | `double`

RefDirections — Reference directions
 M -by-1 column vector of 1s (forward motion) and -1s (reverse motion)

Reference directions of the vehicle along the path, specified as an M -by-1 column vector of 1s (forward motion) and -1s (reverse motion). M is the number of reference directions. Each element of **RefDirections** corresponds to a pose in the **RefPoses** input port.

Data Types: `single` | `double`

Output

Poses — Discretized poses of smoothed path
 N -by-3 matrix of $[x, y, \theta]$ vectors

Discretized poses of the smoothed path, returned as an N -by-3 matrix of $[x, y, \theta]$ vectors. N is the number of poses specified in the **Number of output poses** parameter.

x and y specify the location of the vehicle in meters. θ specifies the orientation angle of the vehicle in degrees.

The values in **Poses** are of the same data type as the values in the **RefPoses** input port.

Directions — Driving directions at each output pose

N -by-1 column vector of 1s (forward motion) and -1s (reverse motion)

Driving directions of the vehicle at each output pose in **Poses**, returned as an N -by-1 column vector of 1s (forward motion) and -1s (reverse motion). N is the number of poses specified in the **Number of output poses** parameter.

The values in **Directions** are of the same data type as the values in the **RefDirections** input port.

You can use **Directions** to specify the reference path of a vehicle. You can also use **Directions**, along with **CumLengths** and **Curvatures**, to generate a reference velocity profile for the vehicle. See the Velocity Profiler block and the “Automated Parking Valet in Simulink” example.

CumLengths — Cumulative path lengths

N -by-1 real-valued column vector

Cumulative path lengths at each output pose in **Poses**, returned as an N -by-1 real-valued column vector. N is the number of poses specified in the **Number of output poses** parameter. Units are in meters.

You can use **CumLengths**, along with **Directions** and **Curvatures**, to generate a reference velocity profile for the vehicle. See the Velocity Profiler block and the “Automated Parking Valet in Simulink” example.

Dependencies

To enable this port, select the **Show CumLengths and Curvatures output ports** parameter.

Curvatures — Signed path curvatures

N -by-1 real-valued column vector

Signed path curvatures at each output pose in **Poses**, returned as an N -by-1 real-valued column vector. N is the number of poses specified in the **Number of output poses** parameter. Units are in radians per meter.

You can use **Curvatures**, along with **Directions** and **CumLengths**, to generate a reference velocity profile for the vehicle. See the Velocity Profiler block and the “Automated Parking Valet in Simulink” example.

Dependencies

To enable this port, select the **Show CumLengths and Curvatures output ports** parameter.

Parameters

Number of output poses — Number of smooth poses to return

100 (default) | positive integer

Number of smooth poses to return in the **Poses** output port, specified as a positive integer. To increase the granularity of the returned poses, increase this parameter value.

Minimum separation of input poses — Minimum separation between poses

1e-3 (default) | positive real scalar

Minimum separation between poses, in meters, specified as a positive real scalar. If the Euclidean (x , y) distance between two poses is less than this value, then the block uses only one of these poses for interpolation.

Sample time — Sample time

-1 (default) | positive real scalar

Sample time of the block, in seconds, specified as -1 or as a positive real scalar. The default of -1 means that the block inherits its sample time from upstream blocks.

Show CumLengths and Curvatures output ports — Output cumulative path lengths and curvatures

off (default) | on

Select this parameter to enable the **CumLengths** and **Curvatures** output ports.

Simulate using — Type of simulation to run

Code Generation (default) | Interpreted Execution

- **Code generation** — Simulate the model using generated C/C++ code. The first time you run a simulation, Simulink generates C/C++ code for the block. The C code is reused for subsequent simulations as long as the model does not change. This option requires additional startup time.
- **Interpreted execution** — Simulate the model using the MATLAB interpreter. This option shortens startup time. In **Interpreted execution** mode, you can debug the source code of the block.

More About

C¹-Continuous and C²-Continuous Paths

A path is C¹-continuous if its derivative exists and is continuous. Paths that are only C¹-continuous have discontinuities in their curvature. For example, a path composed of Dubins or Reeds-Shepp path segments has discontinuities in curvature at the points where the segments join. These discontinuities result in changes in direction that are not smooth enough for driving with passengers.

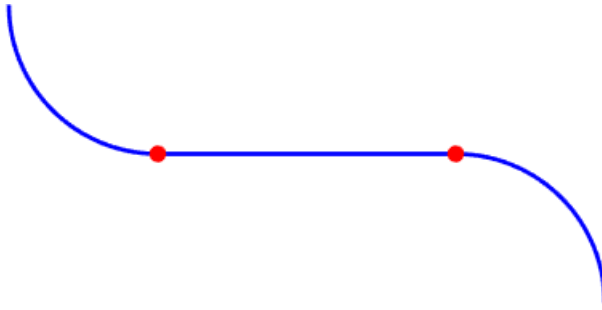

A path is also C^2 -continuous if its second derivative exists and is continuous. C^2 -continuous paths have continuous curvature and are smooth enough for driving with passengers.

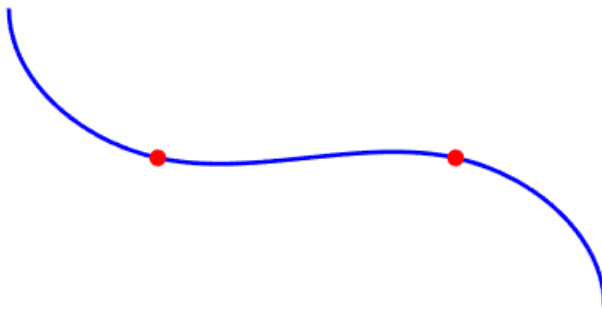

Algorithms

- The path-smoothing algorithm interpolates a parametric cubic spline that passes through all input reference pose points. The parameter of the spline is the cumulative chord length at these points. [1]
- The tangent direction of the smoothed output path approximately matches the orientation angle of the vehicle at the starting and goal poses.

Version History

Introduced in R2019a

References

- [1] Floater, Michael S. "On the Deviation of a Parametric Cubic Spline Interpolant from Its Data Polygon." *Computer Aided Geometric Design*. Vol. 25, Number 3, 2008, pp. 148-156.
- [2] Lepetic, Marko, Gregor Klančar, Igor Skrjanc, Drago Matko, and Bostjan Potocnik. "Time Optimal Path Planning Considering Acceleration Limits." *Robotics and Autonomous Systems*. Vol. 45, Numbers 3-4, 2003, pp. 199-210.

Extended Capabilities

C/C++ Code Generation

Generate C and C++ code using Simulink® Coder™.

See Also

Functions

`smoothPathSpline`

Blocks

Longitudinal Controller Stanley | Lateral Controller Stanley | Velocity Profiler

Radar Detection Generator

Create detection objects from radar measurements

Note Radar Detection Generator is not recommended unless you require C/C++ code generation. Use Driving Radar Data Generator instead. For more information, see “Compatibility Considerations”.

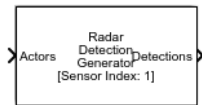

Libraries:

Automated Driving Toolbox / Driving Scenario and Sensor Modeling

Description

The Radar Detection Generator block generates detections from radar measurements taken by a radar sensor mounted on an ego vehicle. Detections are derived from simulated actor poses and are generated at intervals equal to the sensor update interval. By default, detections are referenced to the coordinate system of the ego vehicle. The generator can simulate real detections with added random noise and also generate false alarm detections. A statistical model generates the measurement noise, true detections, and false positives. The random numbers generated by the statistical model are controlled by random number generator settings on the **Measurements** tab. You can use the Radar Detection Generator to create input to a Multi-Object Tracker block. When building scenarios and sensor models using the **Driving Scenario Designer** app, the radar sensors exported to Simulink are output as Radar Detection Generator blocks.

Ports

Input

Actors — Scenario actor poses
Simulink bus containing MATLAB structure

Scenario actor poses in ego vehicle coordinates, specified as a Simulink bus containing a MATLAB structure.

The structure must contain these fields.

Field	Description	Type
NumActors	Number of actors	Nonnegative integer
Time	Current simulation time	Real-valued scalar
Actors	Actor poses	NumActors-length array of actor pose structures

Each actor pose structure in **Actors** must contain these fields.

Field	Description
ActorID	Scenario-defined actor identifier, specified as a positive integer.
Position	Position of actor, specified as a real-valued vector of the form $[x \ y \ z]$. Units are in meters.
Velocity	Velocity (v) of actor in the x - y -, and z -directions, specified as a real-valued vector of the form $[v_x \ v_y \ v_z]$. Units are in meters per second.
Roll	Roll angle of actor, specified as a real-valued scalar. Units are in degrees.
Pitch	Pitch angle of actor, specified as a real-valued scalar. Units are in degrees.
Yaw	Yaw angle of actor, specified as a real-valued scalar. Units are in degrees.
AngularVelocity	Angular velocity (ω) of actor in the x -, y -, and z -directions, specified as a real-valued vector of the form $[\omega_x \ \omega_y \ \omega_z]$. Units are in degrees per second.

Output

Detections — Detections

Simulink bus containing MATLAB structure

Object detections, returned as a Simulink bus containing a MATLAB structure. For more details about buses, see “Create Nonvirtual Buses” (Simulink).

You can pass object detections from these sensors and other sensors to a tracker, such as a Multi-Object Tracker block, and generate tracks.

Field	Description	Type
NumDetections	Number of detections	integer
IsValidTime	False when updates are requested at times that are between block invocation intervals	Boolean
Detections	Object detections	Array of object detection structures of length set by the Maximum number of reported detections parameter. Only NumDetections of these are actual detections.

Each object detection structure contains these properties.

Property	Definition
Time	Measurement time

Property	Definition
Measurement	Object measurements
MeasurementNoise	Measurement noise covariance matrix
SensorIndex	Unique ID of the sensor
ObjectClassID	Object classification
MeasurementParameters	Parameters used by initialization functions of nonlinear Kalman tracking filters
ObjectAttributes	Additional information passed to tracker

- For Cartesian coordinates, Measurement and MeasurementNoise are reported in the coordinate system specified by the **Coordinate system used to report detections** parameter.
- For spherical coordinates, Measurement and MeasurementNoise are reported in the spherical coordinate system based on the sensor Cartesian coordinate system.

Measurement and Measurement Noise

Coordinate System Used to Report Detections	Measurement and Measurement Noise Coordinates		
'Ego Cartesian'	Coordinate dependence on Enable range rate measurements		
'Sensor Cartesian'	Enable range rate measurements	Coordinates	
	true	[x;y;z;vx;vy;vz]	
	false	[x;y;z]	
'Sensor spherical'	Coordinate dependence on Enable elevation angle measurements and Enable range rate measurements		
	Enable range rate measurements	Enable elevation angle measurements	Coordinates
	true	true	[az;el;rng;rr]
	true	false	[az;rng;rr]
	false	true	[az;el;rng]
false	false	[az;rng]	

MeasurementParameters

Parameter	Definition
Frame	Enumerated type indicating the frame used to report measurements. When Frame is set to 'rectangular', detections are reported in Cartesian coordinates. When Frame is set 'spherical', detections are reported in spherical coordinates.
OriginPosition	3-D vector offset of the sensor origin from the ego vehicle origin. The vector is derived from the SensorLocation and Height properties specified in the radarDetectionGenerator.
Orientation	Orientation of the radar sensor coordinate system with respect to the ego vehicle coordinate system. The orientation is derived from the Yaw, Pitch, and Roll properties of the radarDetectionGenerator.
HasVelocity	Indicates whether measurements contain velocity or range rate components.
HasElevation	Indicates whether measurements contain elevation components.

The ObjectAttributes property of each detection is a structure with these fields.

Field	Definition
TargetIndex	Identifier of the actor, ActorID, that generated the detection. For false alarms, this value is negative.
SNR	Signal-to-noise ratio of the detection. Units are in dB.

Parameters

Parameters

Sensor Identification

Unique identifier of sensor — Unique sensor identifier

1 (default) | positive integer

Unique sensor identifier, specified as a positive integer. The sensor identifier distinguishes detections that come from different sensors in a multisensor system. If a model contains multiple sensor blocks with the same sensor identifier, the **Bird's-Eye Scope** displays an error.

Example: 5

Required interval between sensor updates (s) — Required time interval

0.1 (default) | positive real scalar

Required time interval between sensor updates, specified as a positive real scalar. The value of this parameter must be an integer multiple of the **Actors** input port data interval. Updates requested from the sensor between update intervals contain no detections. Units are in seconds.

Sensor Extrinsic

Sensor's (x,y) position (m) — Location of the radar sensor center

[3.4 0] (default) | real-valued 1-by-2 vector

Location of the radar sensor center, specified as a real-valued 1-by-2 vector. The **Sensor's (x,y) position (m)** and **Sensor's height (m)** parameters define the coordinates of the radar sensor with respect to the ego vehicle coordinate system. The default value corresponds to a radar mounted at the center of the front grill of a sedan. Units are in meters.

Sensor's height (m) — Radar sensor height above the ground plane

0.2 (default) | positive real scalar

Radar sensor height above the ground plane, specified as a positive real scalar. The height is defined with respect to the vehicle ground plane. The **Sensor's (x,y) position (m)** and **Sensor's height (m)** parameters define the coordinates of the radar sensor with respect to the ego vehicle coordinate system. The default value corresponds to a radar mounted at the center of the front grill of a sedan. Units are in meters.

Example: 0.25

Yaw angle of sensor mounted on ego vehicle (deg) — Yaw angle of sensor

0 (default) | real scalar

Yaw angle of radar sensor, specified as a real scalar. Yaw angle is the angle between the center line of the ego vehicle and the downrange axis of the radar sensor. A positive yaw angle corresponds to a clockwise rotation when looking in the positive direction of the z-axis of the ego vehicle coordinate system. Units are in degrees.

Example: -4.0

Pitch angle of sensor mounted on ego vehicle (deg) — Pitch angle of sensor

0 (default) | real scalar

Pitch angle of sensor, specified as a real scalar. The pitch angle is the angle between the downrange axis of the radar sensor and the x-y plane of the ego vehicle coordinate system. A positive pitch angle corresponds to a clockwise rotation when looking in the positive direction of the y-axis of the ego vehicle coordinate system. Units are in degrees.

Example: 3.0

Roll angle of sensor mounted on ego vehicle (deg) — Roll angle of sensor

0 (default) | real scalar

Roll angle of the radar sensor, specified as a real scalar. The roll angle is the angle of rotation of the downrange axis of the radar around the x-axis of the ego vehicle coordinate system. A positive roll

angle corresponds to a clockwise rotation when looking in the positive direction of the x-axis of the coordinate system. Units are in degrees.

Port Settings

Source of output bus name — Source of output bus name

Auto (default) | Property

Source of output bus name, specified as Auto or Property. If you choose Auto, the block will automatically create a bus name. If you choose Property, specify the bus name using the **Specify an output bus name** parameter.

Example: Property

Specify an output bus name — Name of output bus

no default

Name of output bus.

Dependencies

To enable this parameter, set the **Source of output bus name** parameter to Property.

Detection Reporting

Maximum number of reported detections — Maximum number of reported detections

50 (default) | positive integer

Maximum number of detections reported by the sensor, specified as a positive integer. Detections are reported in order of increasing distance from the sensor until the maximum number is reached.

Example: 100

Coordinate system used to report detections — Coordinate system of reported detections

Ego Cartesian (default) | Sensor Cartesian | Sensor Spherical

Coordinate system of reported detections, specified as one of these values:

- **Ego Cartesian** — Detections are reported in the ego vehicle Cartesian coordinate system.
- **Sensor Cartesian**— Detections are reported in the sensor Cartesian coordinate system.
- **Sensor spherical** — Detections are reported in a spherical coordinate system. This coordinate system is centered at the radar and aligned with the orientation of the radar on the ego vehicle.

Simulate using — Type of simulation to run

Interpreted execution (default) | Code generation

- **Interpreted execution** — Simulate the model using the MATLAB interpreter. This option shortens startup time. In Interpreted execution mode, you can debug the source code of the block.

- **Code generation** — Simulate the model using generated C/C++ code. The first time you run a simulation, Simulink generates C/C++ code for the block. The C code is reused for subsequent simulations as long as the model does not change. This option requires additional startup time.

Measurements

Accuracy Settings

Azimuthal resolution of radar (deg) — Azimuth resolution of radar

4.0 (default) | positive real scalar

Azimuth resolution of the radar, specified as a positive real scalar. The azimuth resolution defines the minimum separation in azimuth angle at which the radar can distinguish two targets. The azimuth resolution is typically the 3dB-downpoint in azimuth angle beamwidth of the radar. Units are in degrees.

Example: 6.5

Elevation resolution of radar (deg) — Elevation resolution of radar

10.0 (default) | positive real scalar

Elevation resolution of the radar, specified as a positive real scalar. The elevation resolution defines the minimum separation in elevation angle at which the radar can distinguish two targets. The elevation resolution is typically the 3dB-downpoint in elevation angle beamwidth of the radar. Units are in degrees.

Example: 3.5

Dependencies

To enable this parameter, select the **Enable elevation angle measurements** check box.

Range resolution of radar (m) — Range resolution of radar

2.5 (default) | positive real scalar

Range resolution of the radar, specified as a positive real scalar. The range resolution defines the minimum separation in range at which the radar can distinguish between two targets. Units are in meters.

Example: 5.0

Range rate resolution of radar (m/s) — Range rate resolution of the radar

0.5 (default) | positive real scalar

Range rate resolution of the radar, specified as a positive real scalar. The range rate resolution defines the minimum separation in range rate at which the radar can distinguish between two targets. Units are in meters per second.

Example: 0.75

Dependencies

To enable this parameter, select the **Enable range rate measurements** check box.

Bias Settings**Fractional azimuthal bias component of radar** — Azimuth bias fraction

0.1 (default) | nonnegative real scalar

Azimuth bias fraction of the radar, specified as a nonnegative real scalar. The azimuth bias is expressed as a fraction of the azimuth resolution specified in the **Azimuthal resolution of radar (deg)** parameter. Units are dimensionless.

Example: 0.3

Fractional elevation bias component of radar — Elevation bias fraction

0.1 (default) | nonnegative real scalar

Elevation bias fraction of the radar, specified as a nonnegative real scalar. The elevation bias is expressed as a fraction of the elevation resolution specified in the **Elevation resolution of radar (deg)** parameter. Units are dimensionless.

Example: 0.2

Dependencies

To enable this parameter, select the **Enable elevation angle measurements** check box.

Fractional range bias component of radar — Range bias fraction

0.05 (default) | nonnegative real scalar

Range bias fraction of the radar, specified as a nonnegative real scalar. Range bias is expressed as a fraction of the range resolution specified in the **Range resolution of radar (m)** parameter. Units are dimensionless.

Example: 0.15

Fractional range rate bias component of radar — Range rate bias fraction of the radar

0.05 (default) | nonnegative real scalar

Range rate bias fraction of the radar, specified as a nonnegative real scalar. Range rate bias is expressed as a fraction of the range rate resolution specified in **Range rate resolution of radar (m)** parameter. Units are dimensionless.

Example: 0.2

Dependencies

To enable this parameter, select the **Enable range rate measurements** check box.

Detector Settings**Total angular field of view for radar (deg)** — Field of view of radar sensor

[20 5] (default) | real-valued 1-by-2 vector of positive values

Field of view of radar sensor, specified as a real-valued 1-by-2 vector of positive values, [azfov elfov]. The field of view defines the angular extent spanned by the sensor. Each component must lie

in the interval (0,180]. Targets outside of the field of view of the radar are not detected. Units are in degrees.

Example: [14 7]

Maximum detection range (m) — Maximum detection range

150 (default) | positive real scalar

Maximum detection range, specified as a positive real scalar. The radar cannot detect a target beyond this range. Units are in meters.

Example: 250

Minimum and maximum range rates that can be reported — Minimum and maximum detection range rates

[-100 100] (default) | real-valued 1-by-2 vector

Minimum and maximum detection range rates, specified as a real-valued 1-by-2 vector. The radar cannot detect a target outside of this range rate interval. Units are in meters per second.

Example: [-200 200]

Dependencies

To enable this parameter, select the **Enable range rate measurements** check box.

Detection probability — Probability of detecting a target

0.9 (default) | positive real scalar less than or equal to 1

Probability of detecting a target, specified as a positive real scalar less than or equal to one. This quantity defines the probability of detecting target that has a radar cross-section specified by the **Radar cross section at which detection probability is achieved (dBsm)** parameter at the reference detection range specified by the **Range where detection probability is achieved (m)** parameter.

Example: 0.95

Rate at which false alarms are reported — False alarm rate

1e-6 (default) | positive real scalar

False alarm rate within a radar resolution cell, specified as a positive real scalar in the range $[10^{-7}, 10^{-3}]$. Units are dimensionless.

Example: 1e-5

Range where detection probability is achieved (m): — Reference range for given probability of detection

100 (default) | positive real scalar

Reference range for a given probability of detection, specified as a positive real scalar. The reference range is the range when a target having a radar cross-section specified by **Radar cross section at which detection probability is achieved (dBsm)** is detected with a probability of specified by **Detection probability**. Units are in meters.

Example: 150

Radar cross section at which detection probability is achieved (dBsm) — Reference radar cross-section for given probability of detection

0.0 (default) | nonnegative real scalar

Reference radar cross-section (RCS) for given probability of detection, specified as a nonnegative real scalar. The reference RCS is the value at which a target is detected with probability specified by **Detection probability**. Units are in dBsm.

Example: 2.0

Measurement Settings

Enable elevation angle measurements — Enable radar to measure elevation

off (default) | on

Select this check box to model a radar that can measure target elevation angles.

Enable range rate measurements — Enable radar to measure range rate

on (default) | off | on

Select this check box to model a radar that can measure target range rate.

Add noise to measurements — Enable adding noise to radar sensor measurements

on (default) | off

Select this check box to add noise to radar sensor measurements. Otherwise, the measurements are noise-free. The `MeasurementNoise` property of each detection is always computed and is not affected by the value you specify for the **Add noise to measurements** parameter. By leaving this check box off, you can pass the sensor's ground truth measurements into a Multi-Object Tracker block.

Enable false detections — Enable creating false alarm radar detections

on (default) | off

Select this check box to enable reporting false alarm radar measurements. Otherwise, only actual detections are reported.

Random Number Generator Settings

Select method to specify initial seed — Method to specify random number generator seed

Repeatable (default) | Specify seed | Not repeatable

Method to set the random number generator seed, specified as one of the options in the table.

Option	Description
Repeatable	The block generates a random initial seed for the first simulation and reuses this seed for all subsequent simulations. Select this parameter to generate repeatable results from the statistical sensor model. To change this initial seed, at the MATLAB command prompt, enter: <code>clear all</code> .
Specify seed	Specify your own random initial seed for reproducible results by using the Specify seed parameter.
Not repeatable	The block generates a new random initial seed after each simulation run. Select this parameter to generate nonrepeatable results from the statistical sensor model.

Initial seed — Random number generator seed

0 (default) | nonnegative integer less than 2^{32}

Random number generator seed, specified as a nonnegative integer less than 2^{32} .

Example: 2001

Dependencies

To enable this parameter, set the Random Number Generator Settings parameter to Specify seed.

Actor Profiles

Select method to specify actor profiles — Method to specify actor profiles

From Scenario Reader block (default) | Parameters | MATLAB expression

Method to specify actor profiles, which are the physical and radar characteristics of all actors in the driving scenario, specified as one of these options:

- From Scenario Reader block — The block obtains the actor profiles from the scenario specified by the Scenario Reader block.
- Parameters — The block obtains the actor profiles from the parameters that become enabled on the **Actor Profiles** tab.
- From workspace — The block obtains the actor profiles from the MATLAB expression specified by the **MATLAB expression for actor profiles** parameter.

MATLAB expression for actor profiles — MATLAB expression for actor profiles

`struct('ClassID',0,'Length',4.7,'Width',1.8,'Height',1.4,'OriginOffset', [-1.35,0,0])` (default) | MATLAB structure | MATLAB structure array | valid MATLAB expression

MATLAB expression for actor profiles, specified as a MATLAB structure, a MATLAB structure array, or a valid MATLAB expression that produces such a structure or structure array.

If your Scenario Reader block reads data from a `drivingScenario` object, to obtain the actor profiles directly from this object, set this expression to call the `actorProfiles` function on the object. For example: `actorProfiles(scenario)`.

Example: `struct('ClassID',5,'Length',5.0,'Width',2,'Height',2,'OriginOffset',[-1.55,0,0])`

Dependencies

To enable this parameter, set the **Select method to specify actor profiles** parameter to MATLAB expression.

Unique identifier for actors — Scenario-defined actor identifier

`[]` (default) | positive integer | length-*L* vector of unique positive integers

Scenario-defined actor identifier, specified as a positive integer or length-*L* vector of unique positive integers. *L* must equal the number of actors input into the **Actor** input port. The vector elements must match `ActorID` values of the actors. You can specify **Unique identifier for actors** as `[]`. In this case, the same actor profile parameters apply to all actors.

Example: `[1,2]`

Dependencies

To enable this parameter, set the **Select method to specify actor profiles** parameter to Parameters.

User-defined integer to classify actors — User-defined classification identifier

`0` (default) | integer | length-*L* vector of integers

User-defined classification identifier, specified as an integer or length-*L* vector of integers. When **Unique identifier for actors** is a vector, this parameter is a vector of the same length with elements in one-to-one correspondence to the actors in **Unique identifier for actors**. When **Unique identifier for actors** is empty, `[]`, you must specify this parameter as a single integer whose value applies to all actors.

Example: `2`

Dependencies

To enable this parameter, set the **Select method to specify actor profiles** parameter to Parameters.

Length of actors cuboids (m) — Length of cuboid

`4.7` (default) | positive real scalar | length-*L* vector of positive values

Length of cuboid, specified as a positive real scalar or length-*L* vector of positive values. When **Unique identifier for actors** is a vector, this parameter is a vector of the same length with elements in one-to-one correspondence to the actors in **Unique identifier for actors**. When **Unique identifier for actors** is empty, `[]`, you must specify this parameter as a positive real scalar whose value applies to all actors. Units are in meters.

Example: `6.3`

Dependencies

To enable this parameter, set the **Select method to specify actor profiles** parameter to Parameters.

Width of actors cuboids (m) — Width of cuboid

4.7 (default) | positive real scalar | length-*L* vector of positive values

Width of cuboid, specified as a positive real scalar or length-*L* vector of positive values. When **Unique identifier for actors** is a vector, this parameter is a vector of the same length with elements in one-to-one correspondence to the actors in **Unique identifier for actors**. When **Unique identifier for actors** is empty, [], you must specify this parameter as a positive real scalar whose value applies to all actors. Units are in meters.

Example: 4.7

Dependencies

To enable this parameter, set the **Select method to specify actor profiles** parameter to Parameters.

Height of actors cuboids (m) — Height of cuboid

4.7 (default) | positive real scalar | length-*L* vector of positive values

Height of cuboid, specified as a positive real scalar or length-*L* vector of positive values. When **Unique identifier for actors** is a vector, this parameter is a vector of the same length with elements in one-to-one correspondence to the actors in **Unique identifier for actors**. When **Unique identifier for actors** is empty, [], you must specify this parameter as a positive real scalar whose value applies to all actors. Units are in meters.

Example: 2.0

Dependencies

To enable this parameter, set the **Select method to specify actor profiles** parameter to Parameters.

Rotational center of actors from bottom center (m) — Rotational center of the actor

{ [-1.35, 0, 0] } (default) | length-*L* cell array of real-valued 1-by-3 vectors

Rotational center of the actor, specified as a length-*L* cell array of real-valued 1-by-3 vectors. Each vector represents the offset of the rotational center of the actor from the bottom-center of the actor. For vehicles, the offset corresponds to the point on the ground beneath the center of the rear axle. When **Unique identifier for actors** is a vector, this parameter is a cell array of vectors with cells in one-to-one correspondence to the actors in **Unique identifier for actors**. When **Unique identifier for actors** is empty, [], you must specify this parameter as a cell array of one element containing the offset vector whose values apply to all actors. Units are in meters.

Example: [-1.35, .2, .3]

Dependencies

To enable this parameter, set the **Select method to specify actor profiles** parameter to Parameters.

Radar cross section pattern (dBsm) — Radar cross-section

{ [10, 10; 10, 10] } (default) | real-valued Q -by- P matrix | length- L cell array of real-valued Q -by- P matrices

Radar cross-section (RCS) of actor, specified as a real-valued Q -by- P matrix or length- L cell array of real-valued Q -by- P matrices. Q is the number of elevation angles specified by the corresponding cell in the **Elevation angles defining RCSPattern (deg)** parameter. P is the number of azimuth angles specified by the corresponding cell in **Azimuth angles defining RCSPattern (deg)** property. When **Unique identifier for actors** is a vector, this parameter is a cell array of matrices with cells in one-to-one correspondence to the actors in **Unique identifier for actors**. Q and P can vary in the cell array. When **Unique identifier for actors** is empty, [], you must specify this parameter as a cell array with one element containing a matrix whose values apply to all actors. Units are in dBsm.

Example: [10 14 10; 9 13 9]

Dependencies

To enable this parameter, set the **Select method to specify actor profiles** parameter to Parameters.

Azimuth angles defining RCSPattern (deg) — Azimuth angles of radar cross-section pattern

{ [-180 180] } (default) | length- L cell array of real-valued P -length vectors

Azimuth angles of radar cross-section pattern, specified as a length- L cell array of real-valued P -length vectors. Each vector represents the azimuth angles of the P -columns of the radar cross section specified in **Radar cross section pattern (dBsm)**. When **Unique identifier for actors** is a vector, this parameter is a cell array of vectors with cells in one-to-one correspondence to the actors in **Unique identifier for actors**. P can vary in the cell array. When **Unique identifier for actors** is empty, [], you must specify this parameter as a cell array with one element containing a vector whose values apply to all actors. Units are in degrees. Azimuth angles lie in the range -180° to 180° and must be in strictly increasing order.

When the radar cross sections specified in the cells of **Radar cross section pattern (dBsm)** all have the same dimensions, you need only specify a cell array with one element containing the azimuth angle vector.

Example: [-90:90]

Dependencies

To enable this parameter, set the **Select method to specify actor profiles** parameter to Parameters.

Elevation angles defining RCSPattern (deg) — Elevation angles of radar cross-section pattern

{ [-90 90] } (default) | length- L cell array of real-valued Q -length vectors

Elevation angles of radar cross-section pattern, specified as a length- L cell array of real-valued Q -length vectors. Each vector represent the elevation angles of the Q -columns of the radar cross section specified in **Radar cross section pattern (dBsm)**. When **Unique identifier for actors** is a vector, this parameter is a cell array of vectors with cells in one-to-one correspondence to the actors in **Unique identifier for actors**. Q can vary in the cell array. When **Unique identifier for actors** is empty, [], you must specify this parameter as a cell array with one element containing a vector

whose values apply to all actors. Units are in degrees. Elevation angles lie in the range -90° to 90° and must be in strictly increasing order.

When the radar cross sections that are specified in the cells of **Radar cross section pattern (dBsm)** all have the same dimensions, you need only specify a cell array with one element containing an elevation angle vector.

Example: [-25:25]

Dependencies

To enable this parameter, set the **Select method to specify actor profiles** parameter to Parameters.

Version History

Introduced in R2017b

R2021a: radarDetectionGenerator System object and Radar Detection Generator block are not recommended

Not recommended starting in R2021a

The `radarDetectionGenerator` System object and Radar Detection Generator block are not recommended unless you require C/C++ code generation. Instead, use the `drivingRadarDataGenerator` System object and Driving Radar Data Generator, respectively. These new radar sensors provide additional properties for modeling radar sensors, including the ability to generate tracks and clustered detections.

There are no current plans to remove the `radarDetectionGenerator` System object or Radar Detection Generator block. MATLAB code and Simulink models that use these features will continue to run. You can still import `radarDetectionGenerator` objects into the **Driving Scenario Designer** app. However, the app updates the parameters of the imported sensor to reflect the parameters of a `drivingRadarDataGenerator` object. In addition, when you export a scenario containing a `radarDetectionGenerator` sensor to MATLAB code or to a Simulink model, the app exports the sensor as a `drivingRadarDataGenerator` object or Driving Radar Data Generator block, respectively.

Update Code

In MATLAB code, replace all instances of `radarDetectionGenerator` with `drivingRadarDataGenerator`. In addition, update all `radarDetectionGenerator` properties with their equivalent `drivingRadarDataGenerator` properties, as shown in the table. The properties not listed in the table are either specific only to `drivingRadarDataGenerator` or identical in both objects.

radarDetectionGenerator Properties	Equivalent drivingRadarDataGenerator Properties
UpdateInterval	UpdateRate
SensorLocation	MountingLocation
Height	

radarDetectionGenerator Properties	Equivalent drivingRadarDataGenerator Properties
Yaw	MountingAccuracy
Pitch	
Roll	
MaxRange	RangeLimits
MaxNumDetectionsSource	MaxNumReportsSource
MaxNumDetections	MaxNumReports
ActorProfiles	Profiles

This table shows sample code for creating a drivingRadarDataGenerator object instead of a radarDetectionGenerator object.

Discouraged Usage	Recommended Replacement
<pre>radar = radarDetectionGenerator(... 'SensorLocation',[-1 0], ... 'Height',0.2, ... 'Yaw',180, ... 'Pitch',0, ... 'Roll',0, ... 'MaxRange',50);</pre>	<pre>radar = drivingRadarDataGenerator(... 'MountingLocation',[-1 0 0.2], ... 'MountingAngles',[180 0 0], ... 'RangeLimits',[0 50]);</pre>

To generate detections from target poses at each simulation time step, replace the `dets = radarDetectionGenerator(targets,time)` syntax with `dets = drivingRadarDataGenerator(targets,time)`.

Update Models

In Simulink models, replace all Radar Detection Generator blocks with Driving Radar Data Generator blocks. In the Driving Radar Data Generator blocks, update the parameter values in the same way you would update the drivingRadarDataGenerator property values described in the “Update Code” on page 2-102 section.

If your model contains a separate block that clusters detections, you can remove it because the Driving Radar Data Generator block clusters detections by default.

For example, in this model, the Sensor Simulation subsystem outputs concatenated detections from Radar Detection Generator blocks into a separate block that clusters the detections.

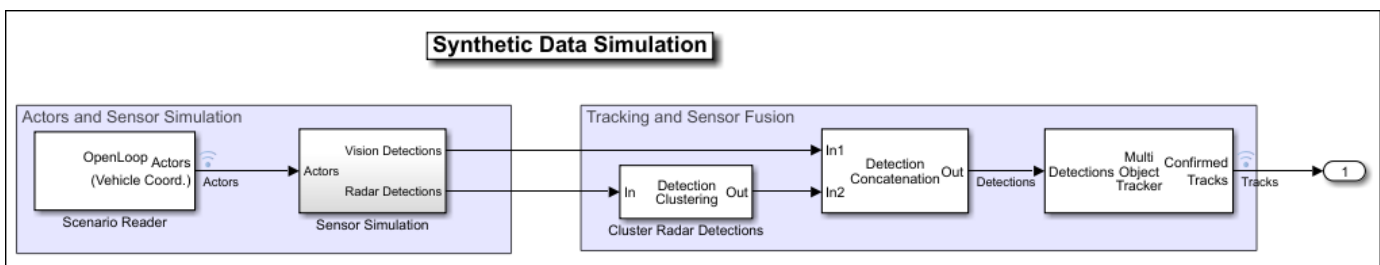

In this model, the Sensor Simulation subsystem outputs concatenated, clustered detections from Driving Radar Data Generator blocks directly into the next part of the model pipeline.

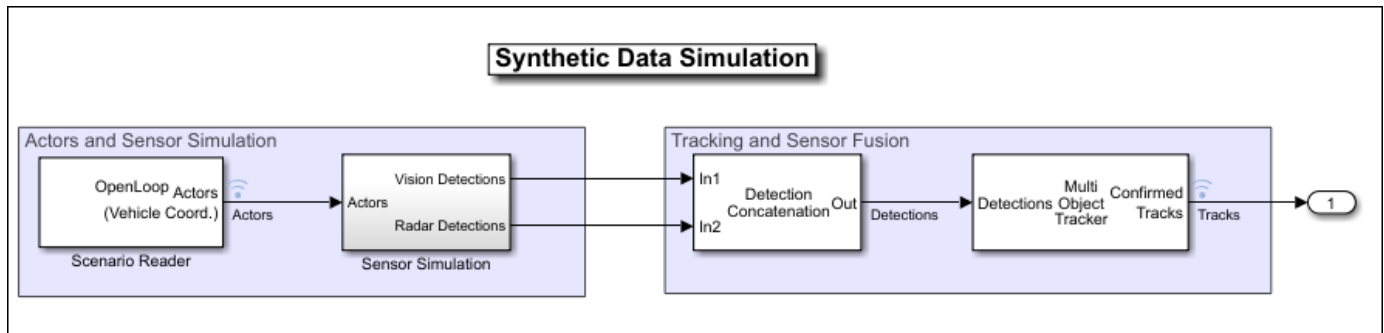

Extended Capabilities

C/C++ Code Generation

Generate C and C++ code using Simulink® Coder™.

See Also

Driving Radar Data Generator

Ultrasonic Detection Generator

Generate ultrasonic sensor detections from driving scenario

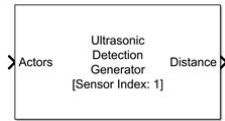

Libraries:

Automated Driving Toolbox / Driving Scenario and Sensor Modeling

Description

The Ultrasonic Detection Generator block generates detection of targets from an ultrasonic sensor mounted on the ego vehicle. Use this block to generate sensor data from a driving scenario containing actors and trajectories, which you can read from a Scenario Reader block.

At intervals equal to the sensor update interval, the block outputs distance from the sensor to the closest point of the detected target. This block also provides parameters to specify dimensions and properties of the objects in the scenario. For visualization of ultrasonic detections using the **Bird's-Eye Scope** app, this block also outputs the 3-D coordinate of the closest point on the detected object.

You can use the Ultrasonic Detection Generator to create input to a Multi-Object Tracker block. When building scenarios and sensor models using the **Driving Scenario Designer** app, the ultrasonic sensors exported to Simulink are output as Ultrasonic Detection Generator blocks.

Ports

Input

Actors — Scenario actor poses

Simulink bus containing MATLAB structure

Scenario actor poses in ego vehicle coordinates, specified as a Simulink bus containing a MATLAB structure.

The structure must contain these fields.

Field	Description	Type
NumActors	Number of actors	Nonnegative integer
Time	Current simulation time	Real-valued scalar
Actors	Actor poses	NumActors-length array of actor pose structures

Each actor pose structure in `Actors` must contain these fields.

Field	Description
ActorID	Scenario-defined actor identifier, specified as a positive integer.

Field	Description
Position	Position of actor, specified as a real-valued vector of the form $[x \ y \ z]$. Units are in meters.
Velocity	Velocity (v) of actor in the x - y -, and z -directions, specified as a real-valued vector of the form $[v_x \ v_y \ v_z]$. Units are in meters per second.
Roll	Roll angle of actor, specified as a real-valued scalar. Units are in degrees.
Pitch	Pitch angle of actor, specified as a real-valued scalar. Units are in degrees.
Yaw	Yaw angle of actor, specified as a real-valued scalar. Units are in degrees.
AngularVelocity	Angular velocity (ω) of actor in the x -, y -, and z -directions, specified as a real-valued vector of the form $[\omega_x \ \omega_y \ \omega_z]$. Units are in degrees per second.

Output

Detections — Object detections

Simulink bus containing MATLAB structure

Object detections, returned as a Simulink bus containing a MATLAB structure. For more details about buses, see “Create Nonvirtual Buses” (Simulink).

You can pass object detections from these sensors and other sensors to a tracker, such as a Multi-Object Tracker block, and generate tracks.

The structure must contain these fields.

Property	Description
Time	Measurement time
Measurement	Distance measurement to the closest object
MeasurementNoise	Measurement noise covariance matrix
SensorIndex	Unique ID of the sensor
ObjectClassID	Object classification
ObjectAttributes	Additional information passed to tracker
MeasurementParameters	Parameters used by initialization functions of nonlinear Kalman tracking filters

This table describes the additional information in the `ObjectAttributes` property.

ObjectAttributes

Attribute	Definition
TargetIndex	Identifier of the actor, ActorID, that generated the detection. For false alarms, this value is negative.
PointOnTarget	Coordinate of the point on the detected object that the sensor used to compute the distance measurement. It is in the vehicle coordinate system. Use this for visualizing detections in the Bird's-Eye Scope app.

For MeasurementParameters, the measurements are relative to the parent frame. The parent frame is the ego vehicle body.

MeasurementParameters

Parameter	Definition
Frame	Enumerated type indicating the frame used to report measurements. The Frame is always set to 'spherical' and the detections are reported in spherical coordinates for Ultrasonic Detection Generator.
OriginPosition	3-D vector offset of the sensor origin from the parent frame origin.
OriginVelocity	Velocity of the sensor coordinate system with respect to the parent frame.
IsParentToChild	Logical scalar indicating if Orientation performs a frame rotation from the parent coordinate frame to the child coordinate frame. When IsParentToChild is false, then Orientation performs a frame rotation from the child coordinate frame to the parent coordinate frame.
HasAzimuth	Indicates whether measurements contain azimuth components.
HasRange	Indicates whether measurements contain range components. Always true for Ultrasonic Detection Generator.
HasElevation	Indicates whether measurements contain elevation components. Always false for Ultrasonic Detection Generator.
HasVelocity	Indicates whether measurements contain velocity or range rate components. Always false for Ultrasonic Detection Generator.
FieldOfView	2-D vector containing the azimuth and elevation field of view values of the sensor.

Parameters

Parameters

Sensor Identification

Unique identifier of sensor — Unique sensor identifier

0 (default) | positive integer

Specify the unique sensor identifier as a positive integer. Use this parameter to distinguish between detections or tracks that come from different sensors in a multisensor system. Specify a unique value for each sensor. If you do not update **Unique identifier of sensor** from the default value of 0, then the radar returns an error at the start of simulation.

Sensor Mounting

Translation [X, Y, Z] relative to ego origin (m) — Sensor location on ego vehicle (m)

[3.4, 0, 0.2] (default) | 1-by-3 real-valued vector of form [x y z]

Specify the sensor location on the ego vehicle body frame in meters as a 1-by-3 real-valued vector of the form [x y z]. This parameter defines the coordinates of the sensor along the x-axis, y-axis, and z-axis relative to the ego vehicle origin, where:

- The x-axis points forward from the vehicle.
- The y-axis points to the left of the vehicle.
- The z-axis points up from the ground.

The default value corresponds to a radar that is mounted at the center of the front grill of a sedan.

For more details on the ego vehicle coordinate system, see “Coordinate Systems in Automated Driving Toolbox”.

Rotation [Yaw, Pitch, Roll] relative to ego's frame (deg) — Mounting rotation angles of radar

[0 0 0] (default) | 1-by-3 real-valued vector of form [z_{yaw} y_{pitch} x_{roll}]

Specify the mounting rotation angles of the radar in degrees as a 1-by-3 real-valued vector of form [z_{yaw} y_{pitch} x_{roll}]. This parameter defines the intrinsic Euler angle rotation of the sensor around the z-axis, y-axis, and x-axis with respect to the ego vehicle body frame, where:

- z_{yaw} , or yaw angle, rotates the sensor around the z-axis of the ego vehicle.
- y_{pitch} , or pitch angle, rotates the sensor around the y-axis of the ego vehicle. This rotation is relative to the sensor position that results from the z_{yaw} rotation.
- x_{roll} , or roll angle, rotates the sensor about the x-axis of the ego vehicle. This rotation is relative to the sensor position that results from the z_{yaw} and y_{pitch} rotations.

These angles are clockwise-positive when looking in the forward direction of the z-axis, y-axis, and x-axis, respectively. If you visualize sensor data from a bird's-eye view perspective, then the yaw angle is counterclockwise-positive because you are viewing the data in the negative direction of the z-axis, which points up from the ground.

For more details on this coordinate system, see “Coordinate Systems in Automated Driving Toolbox”.

Sensor Configuration

Field of view [horizontalFOV, verticalFOV] (deg) — Angular field of view of ultrasonic sensor [70 35] (default) | 1-by-2 positive real-valued vector of form [horizontalFOV verticalFOV]

Angular field of view of the ultrasonic sensor, specified as a 1-by-2 positive real-valued vector of the form [horizontalFOV verticalFOV]. The field of view defines the total angular extent spanned by the sensor. You must specify the horizontal field of view horizontalFOV in the range (0, 360], and the elevation field of view verticalFOV in the range (0, 180]. The range of vertical field of view is narrow to avoid detections from the ground. Units are in degrees.

Detection ranges [minDetOnlyRange, minDistRange, maxDistRange] (m) — Detection range vector of ultrasonic sensor (m) [0.03 0.15 5.5] (default) | 1-by-3 nonnegative real-valued vector of form [minDetOnlyRange minDistRange maxDistRange]

Detection range vector of the ultrasonic sensor, specified as a 1-by-3 nonnegative real-valued vector of the form [minDetOnlyRange minDistRange maxDistRange], where minDetOnlyRange < minDistRange < maxDistRange. Units are in meters. These values determine the detections and distance values returned by the ultrasonic sensor.

- When the detected object is at a distance between minDistRange and maxDistRange, the sensor returns a positive distance value.
- When the detected object is at a distance between minDetOnlyRange and minDistRange, the sensor detects the object, but cannot determine the distance and returns a value of 0.
- When the object is at a distance below minDetOnlyRange or above maxDistRange, the sensor returns an empty cell array.

Update rate (Hz) — Sensor update rate 10 (default) | positive real scalar

Specify the sensor update rate in hertz as a positive real scalar. The reciprocal of the update rate must be an integer multiple of the simulation time interval. The radar generates new reports at intervals defined by this reciprocal value. Any sensor update requested between update intervals contains no detections or tracks.

Port Settings

Source of output bus name — Source of output bus name Auto (default) | Property

Source of output bus name, specified as one of these options:

- Auto — The block automatically creates a bus name.
- Property — Specify the bus name by using the **Specify an output bus name** parameter.

Specify an output bus name — Name of output bus BusDrivingRadarDataGenerator (default) | valid bus name

Specify the name of the actor poses bus returned in the **Actors** output port.

To enable this parameter, set the **Source of output bus name** parameter to Property.

Actor Profiles

Target profiles definition — Method to specify target profiles

Parameters (default) | MATLAB expression | From Scenario Reader block

Specify the method to specify target profiles, which are the physical and radar characteristics of all targets in the driving scenario, as one of these options:

- **Parameters** — The block obtains the target profiles from the parameters enabled on the **Target Profiles** tab when you select this option.
- **MATLAB expression** — The block obtains the actor profiles from the MATLAB expression specified by the **MATLAB expression for target profiles** parameter.
- **From Scenario Reader block** — The block obtains the actor profiles from the scenario specified by the Scenario Reader block.

MATLAB expression for target profiles — MATLAB expression for target profiles

MATLAB structure | MATLAB structure array | valid MATLAB expression

Specify the MATLAB expression for actor profiles, as a MATLAB structure, a MATLAB structure array, or a valid MATLAB expression that produces such a structure or structure array.

If your Scenario Reader block reads data from a `drivingScenario` object, to obtain the actor profiles directly from this object, set this expression to call the `actorProfiles` function on the object. For example: `actorProfiles(scenario)`.

The default target profile expression produces a MATLAB structure and has this form:

```
struct('ClassID',0,'Length',4.7,'Width',1.8,'Height',1.4, ...
'OriginOffset',[-1.35 0 0],'RCSPattern',[10 10;10 10], ...
'RCSAzimuthAngles',[-180 180],'RCSElevationAngles',[-90 90])
```

Dependencies

To enable this parameter, set the **Target profiles definition** parameter to **MATLAB expression**.

Unique identifier for actors — Scenario-defined actor identifier

[] (default) | positive integer | length-*L* vector of unique positive integers

Specify the scenario-defined actor identifier as a positive integer or length-*L* vector of unique positive integers. *L* must equal the number of actors input into the **Actors** input port. The vector elements must match `ActorID` values of the actors. You can specify **Unique identifier for actors** as []. In this case, the same actor profile parameters apply to all actors.

Example: [1 2]

Dependencies

To enable this parameter, set the **Target profiles definition** parameter to **Parameters**.

User-defined integer to classify actors — User-defined classification identifier

0 (default) | integer | length-*L* vector of integers

Specify the user-defined classification identifier as an integer or length-*L* vector of integers. When **Unique identifier for actors** is a vector, this parameter is a vector of the same length with elements in one-to-one correspondence to the actors in **Unique identifier for actors**. When **Unique**

identifier for actors is empty, [], you must specify this parameter as a single integer whose value applies to all actors.

Example: 2

Dependencies

To enable this parameter, set the **Target profiles definition** parameter to Parameters.

Length of actors' cuboids (m) — Length of actor cuboids

4.7 (default) | positive real scalar | length-*L* vector of positive values

Specify the length of actor cuboids as a positive real scalar or length-*L* vector of positive values. When **Unique identifier for actors** is a vector, this parameter is a vector of the same length with elements in one-to-one correspondence to the actors in **Unique identifier for actors**. When **Unique identifier for actors** is empty, [], you must specify this parameter as a positive real scalar whose value applies to all actors. Units are in meters.

Example: 6.3

Dependencies

To enable this parameter, set the **Target profiles definition** parameter to Parameters.

Width of actors' cuboids (m) — Width of actor cuboids

1.8 (default) | positive real scalar | length-*L* vector of positive values

Specify the width of actor cuboids as a positive real scalar or length-*L* vector of positive values. When **Unique identifier for actors** is a vector, this parameter is a vector of the same length with elements in one-to-one correspondence to the actors in **Unique identifier for actors**. When **Unique identifier for actors** is empty, [], you must specify this parameter as a positive real scalar whose value applies to all actors. Units are in meters.

Example: 4.7

Dependencies

To enable this parameter, set the **Target profiles definition** parameter to Parameters.

Height of actors' cuboids (m) — Height of actor cuboids

1.4 (default) | positive real scalar | length-*L* vector of positive values

Specify the height of actor cuboids as a positive real scalar or length-*L* vector of positive values. When **Unique identifier for actors** is a vector, this parameter is a vector of the same length with elements in one-to-one correspondence to the actors in **Unique identifier for actors**. When **Unique identifier for actors** is empty, [], you must specify this parameter as a positive real scalar whose value applies to all actors. Units are in meters.

Example: 2.0

Dependencies

To enable this parameter, set the **Target profiles definition** parameter to Parameters.

Rotational center of actors from bottom center (m) — Rotational center of actors

{[-1.35, 0, 0]} (default) | length-*L* cell array of real-valued 1-by-3 vectors

Specify the rotational center of actors as a length-*L* cell array of real-valued 1-by-3 vectors. Each vector represents the offset of the rotational center of an actor from the bottom-center of the actor.

For vehicles, the offset corresponds to the point on the ground beneath the center of the rear axle. When **Unique identifier for actors** is a vector, this parameter is a cell array of vectors with cells in one-to-one correspondence to the actors in **Unique identifier for actors**. When **Unique identifier for actors** is empty, [], you must specify this parameter as a cell array of one element containing an offset vector whose values apply to all actors. Units are in meters.

Example: `{[-1.35, 0.2, 0.3]}`

Dependencies

To enable this parameter, set the **Target profiles definition** parameter to `Parameters`.

Version History

Introduced in R2022b

See Also

Apps

Bird's-Eye Scope | **Driving Scenario Designer**

Blocks

Scenario Reader | **Lidar Point Cloud Generator** | **Driving Radar Data Generator** | **Vision Detection Generator**

Objects

`ultrasonicDetectionGenerator`

Topics

“Create Nonvirtual Buses” (Simulink)

“Coordinate Systems in Automated Driving Toolbox”

Scenario Reader

Read driving scenario into model

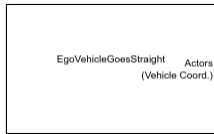

Libraries:

Automated Driving Toolbox / Driving Scenario and Sensor Modeling

Description

The Scenario Reader block reads the roads and actors from a scenario file created using the **Driving Scenario Designer** app or from a `drivingScenario` object. The block outputs the poses of actors in either the coordinate system of the ego vehicle or the world coordinates of the scenario. You can also output the lane boundaries or output the ego vehicle pose for use in the 3D simulation environment. The block also allows output of the ego vehicle state, which includes acceleration measurements, for use with sensor models.

To generate object and lane boundary detections from output actor poses and lane boundaries, pass the pose and boundary outputs to sensor blocks. Use the synthetic detections generated from these sensors to test the performance of sensor fusion algorithms, tracking algorithms, and other automated driving assistance system (ADAS) algorithms. To visualize the performance of these algorithms, use the **Bird's-Eye Scope**.

You can read the ego vehicle from the scenario or specify an ego vehicle defined in your model as an input to the Scenario Reader block. Use this option to test closed-loop vehicle controller algorithms, such as autonomous emergency braking (AEB), lane keeping assist (LKA), or adaptive cruise control (ACC).

Limitations

- The Scenario Reader block does not read sensor data from scenario files saved from the **Driving Scenario Designer** app. To reproduce sensors in Simulink, in the app, open the scenario file that contains the sensors. Then, from the app toolstrip, select **Export > Export Sensor Simulink Model**. Copy the generated sensor blocks into an existing model. Alternatively, select **Export > Export Simulink Model** and start a new model from the generated Scenario Reader block and sensor blocks.
- Large road networks, including ASAM OpenDRIVE road networks, can take up to several minutes to read into models.

Ports

Input

Ego Vehicle — Ego vehicle pose

Simulink bus containing MATLAB structure

Ego vehicle pose, specified as a Simulink bus containing a MATLAB structure.

The structure must have these fields.

Field	Description
ActorID	Scenario-defined actor identifier, specified as a positive integer.
Position	Position of actor, specified as a real-valued vector of the form $[x \ y \ z]$. Units are in meters.
Velocity	Velocity (v) of actor in the x - y -, and z -directions, specified as a real-valued vector of the form $[v_x \ v_y \ v_z]$. Units are in meters per second.
Roll	Roll angle of actor, specified as a real-valued scalar. Units are in degrees.
Pitch	Pitch angle of actor, specified as a real-valued scalar. Units are in degrees.
Yaw	Yaw angle of actor, specified as a real-valued scalar. Units are in degrees.
AngularVelocity	Angular velocity (ω) of actor in the x -, y -, and z -directions, specified as a real-valued vector of the form $[\omega_x \ \omega_y \ \omega_z]$. Units are in degrees per second.

Output the ego vehicle pose when you are converting actors from ego vehicle coordinates to world coordinates for use in the 3D simulation environment. For example, see “Visualize Sensor Data from Unreal Engine Simulation Environment”.

Dependencies

To enable this port, set these parameters in this order:

- 1 Set the **Coordinate system of actors output** parameter to `Vehicle` coordinates.
- 2 Set the **Source of ego vehicle** parameter to `Input` port.

Output

Actors — Scenario actor poses

Simulink bus containing MATLAB structure

Scenario actor poses, returned as a Simulink bus containing a MATLAB structure.

The structure has these fields.

Field	Description	Type
NumActors	Number of actors	Nonnegative integer
Time	Current simulation time	Real-valued scalar
Actors	Actor poses	NumActors-length array of actor pose structures

Each actor pose structure in `Actors` has these fields.

Field	Description
ActorID	Scenario-defined actor identifier, specified as a positive integer.
Position	Position of actor, specified as a real-valued vector of the form $[x \ y \ z]$. Units are in meters.
Velocity	Velocity (v) of actor in the x - y -, and z -directions, specified as a real-valued vector of the form $[v_x \ v_y \ v_z]$. Units are in meters per second.
Roll	Roll angle of actor, specified as a real-valued scalar. Units are in degrees.
Pitch	Pitch angle of actor, specified as a real-valued scalar. Units are in degrees.
Yaw	Yaw angle of actor, specified as a real-valued scalar. Units are in degrees.
AngularVelocity	Angular velocity (ω) of actor in the x -, y -, and z -directions, specified as a real-valued vector of the form $[\omega_x \ \omega_y \ \omega_z]$. Units are in degrees per second.

The pose of the ego vehicle is excluded from the `Actors` array.

To return actor poses from the block, you must run the entire driving scenario simulation to completion.

Lane Boundaries — Scenario lane boundaries

Simulink bus containing MATLAB structure

Scenario lane boundaries, returned as a Simulink bus containing a MATLAB structure.

The structure has these fields.

Field	Description	Type
NumLaneBoundaries	Number of lane boundaries	Nonnegative integer
Time	Current simulation time	Real scalar
LaneBoundaries	Lane boundaries starting from the leftmost lane with respect to the ego vehicle.	NumLaneBoundaries-length array of lane boundary structures

Each lane boundary structure in `LaneBoundaries` has these fields.

Field	Description
-------	-------------

Coordinates	<p>Lane boundary coordinates, specified as a real-valued N-by-3 matrix, where N is the number of lane boundary coordinates. Lane boundary coordinates define the position of points on the boundary at specified longitudinal distances away from the ego vehicle, along the center of the road.</p> <ul style="list-style-type: none"> • In MATLAB, specify these distances by using the 'XDistance' name-value pair argument of the laneBoundaries function. • In Simulink, specify these distances by using the Distances from ego vehicle for computing boundaries (m) parameter of the Scenario Reader block or the Distance from parent for computing lane boundaries parameter of the Simulation 3D Vision Detection Generator block. <p>This matrix also includes the boundary coordinates at zero distance from the ego vehicle. These coordinates are to the left and right of the ego-vehicle origin, which is located under the center of the rear axle. Units are in meters.</p>
Curvature	<p>Lane boundary curvature at each row of the Coordinates matrix, specified as a real-valued N-by-1 vector. N is the number of lane boundary coordinates. Units are in radians per meter.</p>
CurvatureDerivative	<p>Derivative of lane boundary curvature at each row of the Coordinates matrix, specified as a real-valued N-by-1 vector. N is the number of lane boundary coordinates. Units are in radians per square meter.</p>
HeadingAngle	<p>Initial lane boundary heading angle, specified as a real scalar. The heading angle of the lane boundary is relative to the ego vehicle heading. Units are in degrees.</p>

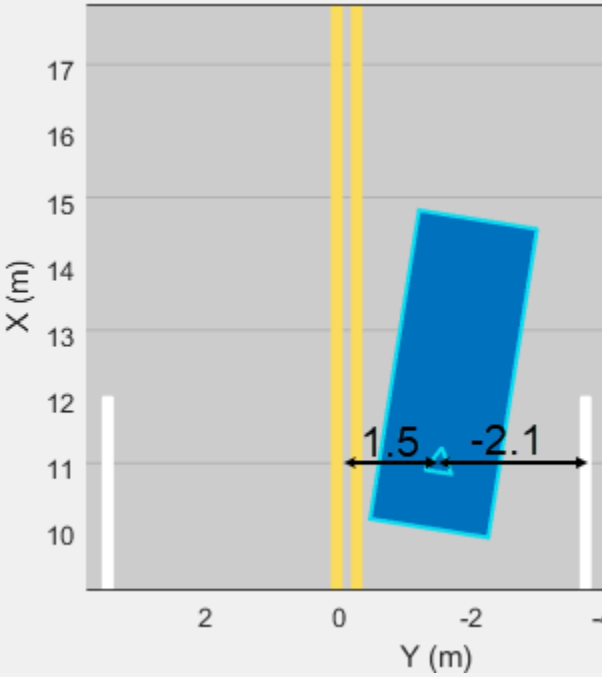
LateralOffset	<p>Lateral offset of the ego vehicle position from the lane boundary, specified as a real scalar. An offset to a lane boundary to the left of the ego vehicle is positive. An offset to the right of the ego vehicle is negative. Units are in meters. In this image, the ego vehicle is offset 1.5 meters from the left lane and 2.1 meters from the right lane.</p> 
BoundaryType	<p>Type of lane boundary marking, specified as one of these values:</p> <ul style="list-style-type: none"> • 'Unmarked' — No physical lane marker exists • 'Solid' — Single unbroken line • 'Dashed' — Single line of dashed lane markers • 'DoubleSolid' — Two unbroken lines • 'DoubleDashed' — Two dashed lines • 'SolidDashed' — Solid line on the left and a dashed line on the right • 'DashedSolid' — Dashed line on the left and a solid line on the right

Strength	Saturation strength of the lane boundary marking, specified as a real scalar from 0 to 1. A value of 0 corresponds to a marking whose color is fully unsaturated. The marking is gray. A value of 1 corresponds to a marking whose color is fully saturated.
Width	Lane boundary width, specified as a positive real scalar. In a double-line lane marker, the same width is used for both lines and for the space between lines. Units are in meters.
Length	Length of dash in dashed lines, specified as a positive real scalar. In a double-line lane marker, the same length is used for both lines.
Space	Length of space between dashes in dashed lines, specified as a positive real scalar. In a dashed double-line lane marker, the same space is used for both lines.

The number of returned lane boundary structures depends on the **Lane boundaries to output** parameter value.

Dependencies

To enable this port, set these parameters in this order:

- 1 Set the **Coordinate system of actors output** parameter to `Vehicle` coordinates.
- 2 Set the **Lane boundaries to output** parameter to `Ego lane boundaries` or `All lane boundaries`.

Ego Vehicle Pose — Ego vehicle pose

Simulink bus containing MATLAB structure

Ego vehicle pose, returned as a Simulink bus containing a MATLAB structure.

The structure must contain these fields.

Field	Description
ActorID	Scenario-defined actor identifier, specified as a positive integer.
Position	Position of actor, specified as a real-valued vector of the form $[x \ y \ z]$. Units are in meters.
Velocity	Velocity (v) of actor in the x - y -, and z -directions, specified as a real-valued vector of the form $[v_x \ v_y \ v_z]$. Units are in meters per second.
Roll	Roll angle of actor, specified as a real-valued scalar. Units are in degrees.
Pitch	Pitch angle of actor, specified as a real-valued scalar. Units are in degrees.

Field	Description
Yaw	Yaw angle of actor, specified as a real-valued scalar. Units are in degrees.
AngularVelocity	Angular velocity (ω) of actor in the x-, y-, and z-directions, specified as a real-valued vector of the form $[\omega_x \ \omega_y \ \omega_z]$. Units are in degrees per second.

Dependencies

To enable this port, set these parameters in this order:

- 1 Set the **Coordinate system of actors output** parameter to `Vehicle` coordinates.
- 2 Set the **Source of ego vehicle** parameter to `Scenario`.
- 3 Select the **Output ego vehicle pose** parameter.

Ego Vehicle State — Ego vehicle state
Simulink bus containing MATLAB structure

Ego vehicle state, returned as a Simulink bus containing a MATLAB structure.

The structure must contain these fields.

Field	Description
Position	Position of actor, specified as a real-valued vector of the form $[x \ y \ z]$. Units are in meters.
Velocity	Velocity (v) of actor in the x- y-, and z-directions, specified as a real-valued vector of the form $[v_x \ v_y \ v_z]$. Units are in meters per second.
Orientation	Orientation of actor, specified as a real-valued vector of <code>[roll pitch yaw]</code> angles. Units are in degrees.
AngularVelocity	Angular velocity (ω) of actor in the x-, y-, and z-directions, specified as a real-valued vector of the form $[\omega_x \ \omega_y \ \omega_z]$. Units are in degrees per second.
Acceleration	Acceleration (a) of actor in the x- y-, and z-directions, specified as a real-valued vector of the form $[a_x \ a_y \ a_z]$. Units are in meters per second squared.

Dependencies

To enable this port, set these parameters in this order:

- 1 Set the **Coordinate system of actors output** parameter to `Vehicle` coordinates.
- 2 Set the **Source of ego vehicle** parameter to `Scenario`.
- 3 Select the **Output ego vehicle state** parameter.

Parameters

Scenario

Source of driving scenario — Source of driving scenario

From file (default) | From workspace

Source of driving scenario, specified as one of these options:

- **From file** — In the **Driving Scenario Designer file name** parameter, specify the name of a scenario file that was saved from the **Driving Scenario Designer** app.
- **From workspace** — In the **MATLAB or model workspace variable name** parameter, specify the name of a MATLAB or model workspace variable that contains a `drivingScenario` object.

Driving Scenario Designer file name — Scenario file name

EgoVehicleGoesStraight.mat (default) | scenario file on MATLAB search path | path to scenario file

Scenario file name, specified as a scenario file on the MATLAB search path or as the full path to a scenario file. A scenario file must be a MAT-file saved from the **Driving Scenario Designer** app. If the **Source of ego vehicle** parameter is set to `Scenario`, then the scenario must contain an ego vehicle. Otherwise, the block returns an error during simulation.

If the specified scenario file contains sensors, the block ignores them. To include sensors from the scenario in your model, see “Tips” on page 2-128.

The default scenario file shows an ego vehicle traveling north on a straight, two-lane road, with another vehicle traveling south in the opposite lane.

To add a scenario file to the MATLAB search path, use the `addpath` function. For example, this code adds the set of folders containing prebuilt Euro NCAP scenarios to the MATLAB search path.

```
path = fullfile(matlabroot, 'toolbox', 'shared', 'drivingscenario', ...
    'PrebuiltScenarios', 'EuroNCAP');
addpath(genpath(path))
```

In the **Driving Scenario Designer file name** parameter, you can then specify the name of any scenario located in these folders, without having to specify the full file path. For example: `AEB_PedestrianChild_Nearside_50width.mat`.

When you are done using the scenario in your models, you can remove any added folders from the MATLAB search path by using the `rmpath` function.

```
rmpath(genpath(path))
```

Dependencies

To enable this parameter, set the **Source of driving scenario** parameter to `From file`.

MATLAB or model workspace variable name — Scenario variable name

scenario (default) | `drivingScenario` object variable name

Scenario variable name, specified as the name of a MATLAB or model workspace variable that contains a valid `drivingScenario` object. If a scenario variable with the same name appears in both the MATLAB and model workspace, the block uses the variable defined in the model workspace.

If the **Source of ego vehicle** parameter is set to `Scenario`, then the `drivingScenario` object must contain an ego vehicle. To designate which actor in the object is the ego vehicle, in the **Ego vehicle ActorID** parameter, specify the `ActorID` property value of that actor.

The default variable name, `scenario`, is the default name of `drivingScenario` objects produced by the MATLAB functions that are exported from the **Driving Scenario Designer** app. By default, this variable is not included in the MATLAB or model workspace.

Dependencies

To enable this parameter, set the **Source of driving scenario** parameter to `From workspace`.

Coordinate system of actors output — Coordinate system of actors output

`Vehicle coordinates (default) | World coordinates`

Coordinate system of the output actors, specified as one of these values:

- `Vehicle coordinates` — Coordinates are defined with respect to the ego vehicle. Select this value when your scenario has only one ego vehicle.
- `World coordinates` — Coordinates are defined with respect to the driving scenario. Select this value in multi-agent scenarios that contain more than one ego vehicle. If you select this value, model visualization using the **Bird's-Eye Scope** is not supported.

For more details on the vehicle and world coordinate systems, see “Coordinate Systems in Automated Driving Toolbox”.

Source of ego vehicle — Source of ego vehicle

`Scenario (default) | Input port`

Source of ego vehicle, specified as one of these options:

- `Scenario` — Use the ego vehicle defined in the scenario that is specified by the **Driving Scenario Designer file name** or **MATLAB or model workspace variable name** parameter. The pose of the ego vehicle is excluded from the **Actors** output port. Actor positions are in vehicle coordinates, meaning that they are relative to the world coordinate position of the ego vehicle in the scenario.

Select this option to test open-loop ADAS algorithms, where the ego vehicle behavior is predefined and does not change as the scenario advances. For an example, see “Test Open-Loop ADAS Algorithm Using Driving Scenario”.

- `Input port` — Specify the ego vehicle by using the **Ego Vehicle** input port. The pose of the ego vehicle is not included in the **Actors** output port.

With this option, the ego vehicle in your model must include a starting position that is in world coordinates. All other actor poses are in vehicle coordinates and are positioned relative to the ego vehicle. For an example of an ego vehicle with defined position information, see “Lane Keeping Assist with Lane Detection”. When defining the starting position of the ego vehicle, consider using the position that is already defined in the scenario. By using this position, if you set **Source of**

ego vehicle to Scenario and then back to Input port, you do not have to manually change the starting position.

Select this option to test closed-loop ADAS algorithms, where the ego vehicle reacts to changes as the scenario advances. For an example, see “Test Closed-Loop ADAS Algorithm Using Driving Scenario”.

Dependencies

To enable this parameter, set the **Coordinate system of actors output** parameter to Vehicle coordinates.

Ego vehicle ActorID — Actor ID of ego vehicle

1 (default) | positive integer

Actor ID of ego vehicle, specified as a positive integer. Use this parameter to simulate using the ego vehicle that is read from a `drivingScenario` object.

- When **Source of ego vehicle** is set to Scenario, set this parameter to an ActorID value that is stored in the Actors property of the specified `drivingScenario` object. To check valid ActorID values, use this syntax, where `scenario` is the name of the `drivingScenario` variable name.

```
actorIDs = [scenario.actors.ActorID]
```

- When **Source of ego vehicle** is set to Input Port, you must set this parameter to the ActorID value at the **Ego Vehicle** input port of the block.

Dependencies

To enable this parameter, set these parameters in this order:

- 1 Set the **Source of driving scenario** parameter to From workspace.
- 2 Set the **Coordinate system of actors output** parameter to Vehicle coordinates.

Output ego vehicle pose — Output pose of ego vehicle

off (default) | on

Select this parameter to output the pose of the ego vehicle at the **Ego Vehicle Pose** port.

Dependencies

To enable this parameter, set the **Coordinate system of actors output** parameter to Vehicle coordinates and the **Source of ego vehicle** parameter to Scenario.

Output ego vehicle state — Output state of ego vehicle

off (default) | on

Select this parameter to output the state of the ego vehicle at the **Ego Vehicle State** port.

Dependencies

To enable this parameter, set the **Coordinate system of actors output** parameter to Vehicle coordinates and the **Source of ego vehicle** parameter to Scenario.

To output ego vehicle state, you must create the trajectory of the ego vehicle using the `smoothTrajectory` function in the driving scenario API or by selecting **Use smooth, jerk-limited trajectory** parameter in the **Driving Scenario Designer** app.

Ego vehicle follows ground — Orient ego vehicle to follow road surface

off (default) | on

Select this parameter to orient the ego vehicle to follow the elevation of the road surface. The block updates the elevation, roll, pitch, and yaw of the ego vehicle and outputs actors and lane boundaries relative to the updated ego vehicle coordinates. The block does not update the velocity or angular velocity of the ego vehicle.

Use this parameter in closed-loop simulations where the elevation of the road network varies.

Note At the junctions of roads that have different elevations and banking angles, the updated ego vehicle values might not be accurate.

In open-loop simulations, where **Source of ego vehicle** is set to `Scenario`, the ego vehicle follows the elevation specified in the driving scenario.

Dependencies

To enable this parameter, set **Coordinate system of actors output** to `Vehicle coordinates` and **Source of ego vehicle** to `Input port`.

Sample time (s) — Sample time of simulation

0.1 (default) | positive real scalar

Sample time of simulation, in seconds, specified as a positive real scalar. Inherited and continuous sample times are not supported. This sample time is separate from the sample times that the **Driving Scenario Designer** app and `drivingScenario` object use during simulation.

Lanes

Lane boundaries to output — Lane boundaries to output

None (default) | Ego vehicle lane boundaries | All lane boundaries

Lane boundaries to output, specified as one of these options:

- `None` — Do not output any lane boundaries.
- `Ego vehicle lane boundaries` — Output the left and right lane boundaries of the ego vehicle.
- `All lane boundaries` — Output all lane boundaries of the road on which the ego vehicle is traveling.

If you select `Ego vehicle lane boundaries` or `All lane boundaries`, then the block returns the lane boundaries in the **Lane Boundaries** output port.

Dependencies

To enable this parameter, set the **Coordinate system of actors output** parameter to `Vehicle coordinates`.

Distances from ego vehicle for computing boundaries (m) — Distances from ego vehicle at which to compute lane boundaries

`linspace(-150,150,101)` (default) | N -element real-valued vector

Distances from the ego vehicle at which to compute the lane boundaries, specified as an N -element real-valued vector. N is the number of distance values. When detecting lanes from rear-facing cameras, specify negative distances. When detecting lanes from front-facing cameras, specify positive distances. Units are in meters.

By default, the block computes 101 lane boundaries over the range from 150 meters behind the ego vehicle to 150 meters ahead of the ego vehicle. These distances are linearly spaced 3 meters apart.

Example: `1:0.1:10` computes a lane boundary every 0.1 meters over the range from 1 to 10 meters ahead of the ego vehicle.

Dependencies

To enable this parameter, set the **Lane boundaries to output** parameter to `Ego vehicle lane boundaries` or `All lane boundaries`.

Location of boundaries on lane markings — Lane boundary location

`Center of lane markings` (default) | `Inner edge of lane markings`

Lane boundary location on the lane markings, specified as one of the options in this table.

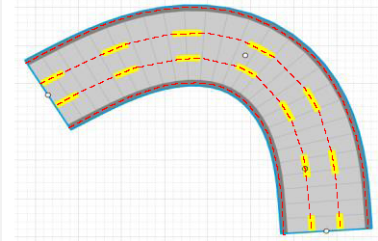
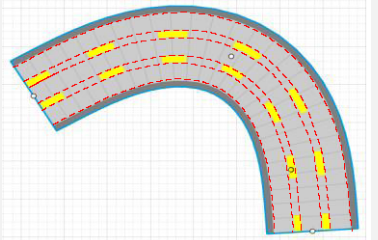
Lane Boundary Location	Description	Example
Center of lane markings	Lane boundaries are centered on the lane markings.	A three-lane road has four lane boundaries: one per lane marking. 
Inner edge of lane markings	Lane boundaries are placed at the inner edges of the lane markings.	A three-lane road has six lane boundaries: two per lane. 

Dependencies

To enable this parameter, set the **Lane boundaries to output** parameter to `Ego vehicle lane boundaries` or `All lane boundaries`.

Port Settings

Source of actors bus name — Source of name for actor poses bus

Auto (default) | Property

Source of the name for the actor poses bus returned in the **Actors** output port, specified as one of these options:

- **Auto** — The block automatically creates an actor poses bus name.
- **Property** — Specify the actor poses bus name by using the **Actors bus name** parameter.

Actors bus name — Name of actor poses bus

valid bus name

Name of the actor poses bus returned in the **Actors** output port, specified as a valid bus name.

Dependencies

To enable this parameter, set **Source of actors bus name** to `Property`.

Source of maximum number of actors — Source of maximum number of actors

Scenario (default) | Property

Source of the maximum number of actors that you can have in the driving scenario, specified as one of these options:

- **Scenario** — The block sets the maximum number of actors to the number of actors in the driving scenario. This value is equal to the `NumActors` field of the bus returned by the **Actors** output port. When you change the input scenario, the maximum number of actors updates to match the new `NumActors` value.
- **Property** — Specify the maximum number of actors by using the **Maximum number of actors** parameter. Select this option when you want to reuse the same actor bus across scenarios that have varying numbers of actors, such as when outputting actors from a referenced model.

Maximum number of actors — Maximum number of actors

100 (default) | positive integer

Maximum number of actors that you can have in the scenario, specified as a positive integer.

Dependencies

To enable this parameter, set the **Source of maximum number of actors** parameter to `Property`.

Source of lane boundaries bus name — Source of name for lane boundaries bus

Auto (default) | Property

Source of the name for the lane boundaries bus returned in the **Lane Boundaries** output port, specified as one of these options:

- **Auto** — The block automatically creates a lane boundaries bus name.
- **Property** — Specify the lane boundaries bus name by using the **Lane boundaries bus name** parameter.

Dependencies

To enable this parameter:

- 1 Set the **Coordinate system of actors output** parameter to `Vehicle` coordinates.
- 2 Set the **Lane boundaries to output** parameter to `Ego vehicle lane boundaries` or `All lane boundaries`.

Lane boundaries bus name — Name of lane boundaries bus

`valid bus name`

Name of the lane boundaries bus returned in the **Lane Boundaries** output port, specified as a valid bus name.

Dependencies

To enable this parameter:

- 1 Set the **Coordinate system of actors output** parameter to `Vehicle` coordinates.
- 2 Set the **Lane boundaries to output** parameter to `Ego vehicle lane boundaries` or `All lane boundaries`.
- 3 Set the **Source of lane boundaries bus name** parameter to `Property`.

Source of maximum number of lane boundaries — Source of maximum number of lane boundaries

`Scenario (default) | Property`

Source of the maximum number of lane boundaries that you can have in the driving scenario, specified as one of these options:

- **Scenario** — The block sets the maximum number of lane boundaries to the number of lane boundaries in the driving scenario. This value is equal to the `NumLaneBoundaries` field of the bus returned by the **Lane Boundaries** output port. When you change the input scenario, the maximum number of lane boundaries updates to match the new `NumLaneBoundaries` value.
- **Property** — Specify the maximum number of lane boundaries by using the **Maximum number of lane boundaries** parameter. Select this option when you want to reuse the same lane boundaries bus across scenarios that have varying numbers of lane boundaries, such as when outputting lane boundaries from a referenced model.

Dependencies

To enable this parameter:

- 1 Set the **Coordinate system of actors output** parameter to `Vehicle` coordinates.

2 Set the **Lane boundaries to output** parameter to All lane boundaries.

Maximum number of lane boundaries — Maximum number of lane boundaries

10 (default) | positive integer

Maximum number of lane boundaries that you can have in the scenario, specified as a positive integer.

Dependencies

To enable this parameter:

- 1 Set the **Coordinate system of actors output** parameter to Vehicle coordinates.
- 2 Set the **Lane boundaries to output** parameter to All lane boundaries.
- 3 Set the **Source of maximum number of lane boundaries** parameter to Property.

Source of ego vehicle pose bus name — Source of name for ego vehicle pose bus

Auto (default) | Property

Source of the name for the ego vehicle pose bus returned in the **Ego Vehicle Pose** output port, specified as one of these options:

- Auto — The block automatically creates an ego vehicle pose bus name.
- Property — Specify the ego vehicle pose bus name by using the **Ego vehicle pose bus name** parameter.

Dependencies

To enable this parameter, select the **Output ego vehicle pose** parameter.

Ego vehicle pose bus name — Name of ego vehicle pose bus

valid bus name

Name of the ego vehicle pose bus returned in the **Ego Vehicle Pose** output port, specified as a valid bus name.

Dependencies

To enable this parameter, select the **Output ego vehicle pose** parameter and set the **Source of ego vehicle pose bus name** parameter to Property.

Source of ego vehicle state bus name — Source of name for ego vehicle state bus

Auto (default) | Property

Source of the name for the ego vehicle state bus returned in the **Ego Vehicle State** output port, specified as one of these options:

- Auto — The block automatically creates an ego vehicle state bus name.
- Property — Specify the ego vehicle state bus name by using the **Ego vehicle state bus name** parameter.

Dependencies

To enable this parameter, select the **Output ego vehicle state** parameter.

Ego vehicle state bus name — Name of ego vehicle state bus

valid bus name

Name of the ego vehicle state bus returned in the **Ego Vehicle State** output port, specified as a valid bus name.

Dependencies

To enable this parameter, select the **Output ego vehicle state** parameter and set the **Source of ego vehicle state bus name** parameter to Property.

Show coordinate labels — Display coordinate system of inputs and outputs

on (default) | off

Select this parameter to display the coordinate system of block inputs and outputs on the Scenario Reader block in the block diagram.

- The **Ego Vehicle** input and output are always in world coordinates.
- The **Lane Boundaries** output is always in vehicle coordinates.
- You can return the **Actors** output in either vehicle or world coordinates, depending on the **Coordinate system of actors output** parameter selection.

Simulation

Simulate using — Type of simulation to run

Interpreted execution (default) | Code generation

- **Interpreted execution** — Simulate the model using the MATLAB interpreter. This option shortens startup time. In **Interpreted execution** mode, you can debug the source code of the block.
- **Code generation** — Simulate the model using generated C/C++ code. The first time you run a simulation, Simulink generates C/C++ code for the block. The C code is reused for subsequent simulations as long as the model does not change. This option requires additional startup time.

Tips

- For best results, use only one active Scenario Reader block per model. To use multiple Scenario Reader blocks in one model, switch between the blocks by specifying them in a variant subsystem.
- To test your algorithm on variations of a driving scenario, you can update the scenario between simulations.
 - If the source of the scenario is a scenario file, open the scenario file in the **Driving Scenario Designer** app, update the parameters, and resave the file.
 - If the source of the scenario is a `drivingScenario` object, update the object in the MATLAB or model workspace. Alternatively, import the object into the app, modify the scenario in the app, and then generate a new object from the app. For more details, see “Create Driving Scenario Variations Programmatically”.

- To switch between scenarios with different parameter settings, you can use Simulink Test™ software. For an example, see “Automate Testing for Highway Lane Following”.

Version History

Introduced in R2019a

Extended Capabilities

C/C++ Code Generation

Generate C and C++ code using Simulink® Coder™.

Usage notes and limitations:

- When a model is in rapid accelerator mode, the Scenario Reader block does not automatically regenerate code based on changes made to the driving scenario between simulations. To regenerate these changes, manually delete the Simulink project folder, `s\prj`, that was generated from the previous simulation. Then, rerun the simulation. Alternatively, either change modes or disable code generation by setting the **Simulate using** parameter to Interpreted execution.
- The **Driving Scenario Designer file name** and **MATLAB or model workspace variable name** parameters are character vectors. The limitations described in “Encoding of Characters in Code Generation” (Simulink) apply to these parameters.

See Also

Apps

Bird's-Eye Scope | **Driving Scenario Designer**

Blocks

Driving Radar Data Generator | Vision Detection Generator | Lidar Point Cloud Generator | Multi-Object Tracker | Detection Concatenation | Vehicle To World | World To Vehicle | Cuboid To 3D Simulation

Topics

“Coordinate Systems in Automated Driving Toolbox”

“Create Nonvirtual Buses” (Simulink)

Simulation 3D Scene Configuration

Scene configuration for 3D simulation environment

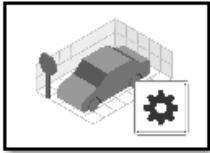

Libraries:

Vehicle Dynamics Blockset / Vehicle Scenarios / Sim3D / Sim3D Core
 Aerospace Blockset / Animation / Simulation 3D
 Automated Driving Toolbox / Simulation 3D
 UAV Toolbox / Simulation 3D
 Simulink 3D Animation / Simulation 3D

Description

The Simulation 3D Scene Configuration block implements a 3D simulation environment that is rendered by using the Unreal Engine from Epic Games. Automated Driving Toolbox integrates the 3D simulation environment with Simulink so that you can query the world around the vehicle and virtually test perception, control, and planning algorithms. Using this block, you can also control the position of the sun and the weather conditions of a scene. For more details, see Sun Position and Weather on page 2-142.

You can simulate from a set of prebuilt scenes or from your own custom scenes. Scene customization requires the Automated Driving Toolbox Interface for Unreal Engine 4 Projects support package. For more details, see “Customize Unreal Engine Scenes for Automated Driving”.

Note The Simulation 3D Scene Configuration block must execute after blocks that send data to the 3D environment and before blocks that receive data from the 3D environment. To verify the execution order of such blocks, right-click the blocks and select **Properties**. Then, on the **General** tab, confirm these **Priority** settings:

- For blocks that send data to the 3D environment, such as Simulation 3D Vehicle with Ground Following blocks, **Priority** must be set to -1. That way, these blocks prepare their data before the 3D environment receives it.
- For the Simulation 3D Scene Configuration block in your model, **Priority** must be set to 0.
- For blocks that receive data from the 3D environment, such as Simulation 3D Camera blocks, **Priority** must be set to 1. That way, the 3D environment can prepare the data before these blocks receive it.

For more information about execution order, see “How Unreal Engine Simulation for Automated Driving Works”.

Parameters

Scene

Scene Selection

Scene source — Source of scene

Default Scenes (default) | Unreal Executable | Unreal Editor

Source of the scene in which to simulate, specified as one of the options in the table.

Option	Description
Default Scenes	Simulate in one of the default, prebuilt scenes specified in the Scene name parameter.
Unreal Executable	<p>Simulate in a scene that is part of an Unreal Engine executable file. Specify the executable file in the Project name parameter. Specify the scene in the Scene parameter.</p> <p>Select this option to simulate in custom scenes that have been packaged into an executable for faster simulation.</p>
Unreal Editor	<p>Simulate in a scene that is part of an Unreal Engine project (.uproject) file and is open in the Unreal® Editor. Specify the project file in the Project parameter.</p> <p>Select this option when developing custom scenes. By clicking Open Unreal Editor, you can co-simulate within Simulink and the Unreal Editor and modify your scenes based on the simulation results.</p>

Scene name — Name of prebuilt 3D scene

Straight road (default) | Curved road | Parking lot | Double lane change | Open surface | US city block | US highway | Virtual Mcity | Large parking lot

Name of the prebuilt 3D scene in which to simulate, specified as one of these options. For details about a scene, see its listed corresponding reference page.

- Straight road — Straight Road
- Curved road — Curved Road
- Parking lot — Parking Lot
- Double lane change — Double Lane Change
- Open surface — Open Surface
- US city block — US City Block
- US highway — US Highway
- Virtual Mcity — Virtual Mcity
- Large parking lot — Large Parking Lot

The Automated Driving Toolbox Interface for Unreal Engine 4 Projects contains customizable versions of these scenes. For details about customizing scenes, see “Customize Unreal Engine Scenes for Automated Driving”.

Dependencies

To enable this parameter, set **Scene source** to Default Scenes.

Project name — Name of Unreal Engine executable file

VehicleSimulation.exe (default) | valid executable file name

Name of the Unreal Engine executable file, specified as a valid executable project file name. You can either browse for the file or specify the full path to the project file, using backslashes. To specify a scene from this file to simulate in, use the **Scene** parameter.

By default, **Project name** is set to VehicleSimulation.exe, which is on the MATLAB search path.

Example: C:\Local\WindowsNoEditor\AutoVrtlEnv.exe

Dependencies

To enable this parameter, set **Scene source** to Unreal Executable.

Select ASAM OpenDRIVE file — Specify an ASAM OpenDRIVE file

off (default) | on

Specify an ASAM OpenDRIVE file. Select the block parameter **Select ASAM OpenDRIVE file** to specify an ASAM OpenDRIVE file. You will need an ASAM OpenDRIVE file if you want to perform any lane detection applications with custom scenes using the Simulation 3D Vision Detection Generator block.

Dependencies

This parameter is available when you set Scene Source is set to either Unreal Executable or Unreal Engine.

Data Types: Boolean

Scene — Name of scene from executable file

/Game/Maps/HwStrght (default) | path to valid scene name

Name of a scene from the executable file specified by the **Project name** parameter, specified as a path to a valid scene name.

When you package scenes from an Unreal Engine project into an executable file, the Unreal Editor saves the scenes to an internal folder within the executable file. This folder is located at the path /Game/Maps. Therefore, you must prepend /Game/Maps to the scene name. You must specify this path using forward slashes. For the file name, do not specify the .umap extension. For example, if the scene from the executable in which you want to simulate is named myScene.umap, specify **Scene** as /Game/Maps/myScene.

Alternatively, you can browse for the scene in the corresponding Unreal Engine project. These scenes are typically saved to the Content/Maps subfolder of the project. This subfolder contains all the scenes in your project. The scenes have the extension .umap. Select one of the scenes that you packaged into the executable file specified by the **Project name** parameter. Use backward slashes and specify the .umap extension for the scene.

By default, **Scene** is set to /Game/Maps/HwStrght, which is a scene from the default VehicleSimulation.exe executable file specified by the **Project name** parameter. This scene corresponds to the prebuilt **Straight Road** scene.

Example: /Game/Maps/scene1

Example: C:\Local\myProject\Content\Maps\scene1.umap

Dependencies

To enable this parameter, set **Scene source** to Unreal Executable.

Project — Name of Unreal Engine project file

valid project file name

Name of the Unreal Engine project file, specified as a valid project file name. You can either browse for the file or specify the full path to the file, using backslashes. The file must contain no spaces. To simulate scenes from this project in the Unreal Editor, click **Open Unreal Editor**. If you have an Unreal Editor session open already, then this button is disabled.

To run the simulation, in Simulink, click **Run**. Before you click **Play** in the Unreal Editor, wait until the Diagnostic Viewer window displays this confirmation message:

In the Simulation 3D Scene Configuration block, you set the scene source to 'Unreal Editor'.
In Unreal Editor, select 'Play' to view the scene.

This message confirms that Simulink has instantiated the scene actors, including the vehicles and cameras, in the Unreal Engine 3D environment. If you click **Play** before the Diagnostic Viewer window displays this confirmation message, Simulink might not instantiate the actors in the Unreal Editor.

Dependencies

To enable this parameter, set **Scene source** to Unreal Editor.

Scene Parameters

Scene view — Configure placement of virtual camera that displays scene

Scene Origin | vehicle name

Configure the placement of the virtual camera that displays the scene during simulation.

- If your model contains no Simulation 3D Vehicle with Ground Following blocks, then during simulation, you view the scene from a camera positioned at the scene origin.
- If your model contains at least one vehicle block, then by default, you view the scene from behind the first vehicle that was placed in your model. To change the view to a different vehicle, set **Scene view** to the name of that vehicle. The **Scene view** parameter list is populated with all the **Name** parameter values of the vehicle blocks contained in your model.

If you add a Simulation 3D Scene Configuration block to your model before adding any vehicle blocks, the virtual camera remains positioned at the scene. To reposition the camera to follow a vehicle, update this parameter.

When **Scene view** is set to a vehicle name, during simulation, you can change the location of the camera around the vehicle.

To smoothly change the camera views, use these key commands.

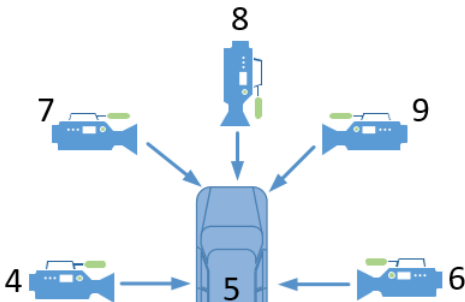
Key	Camera View	
1	Back left	

Key	Camera View	
2	Back	<p>View Animated GIF</p> 
3	Back right	
4	Left	
5	Internal	
6	Right	
7	Front left	
8	Front	
9	Front right	
0	Overhead	

For additional camera controls, use these key commands.

Key	Camera Control
Tab	<p>Cycle the view between all vehicles in the scene.</p> <p>View Animated GIF</p> 

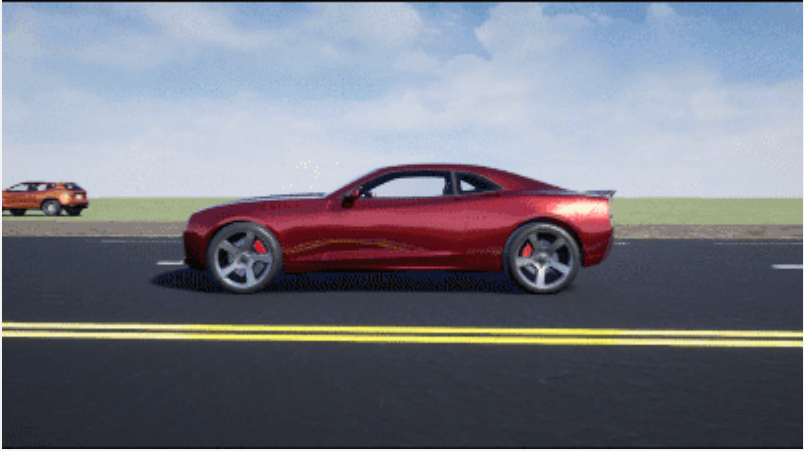
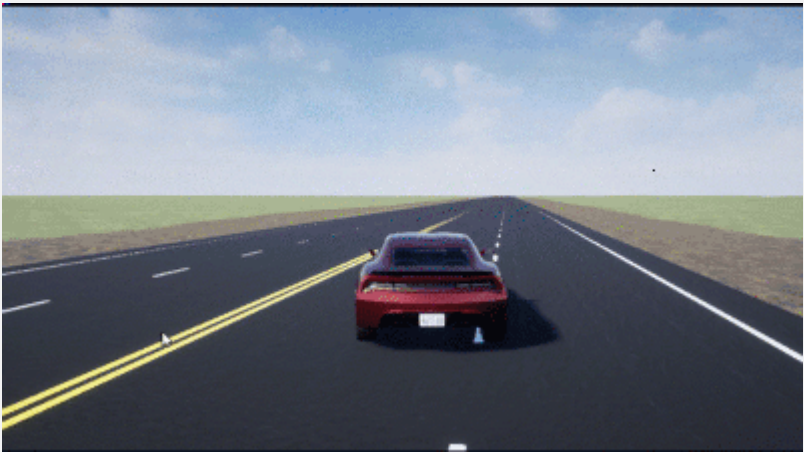
Key	Camera Control
Mouse scroll wheel	<p>Control the camera distance from the vehicle.</p> <p>View Animated GIF</p> 
L	<p>Toggle a camera lag effect on or off. When you enable the lag effect, the camera view includes:</p> <ul style="list-style-type: none">• Position lag, based on the vehicle translational acceleration• Rotation lag, based on the vehicle rotational velocity <p>This lag enables improved visualization of overall vehicle acceleration and rotation.</p> <p>View Animated GIF</p> 

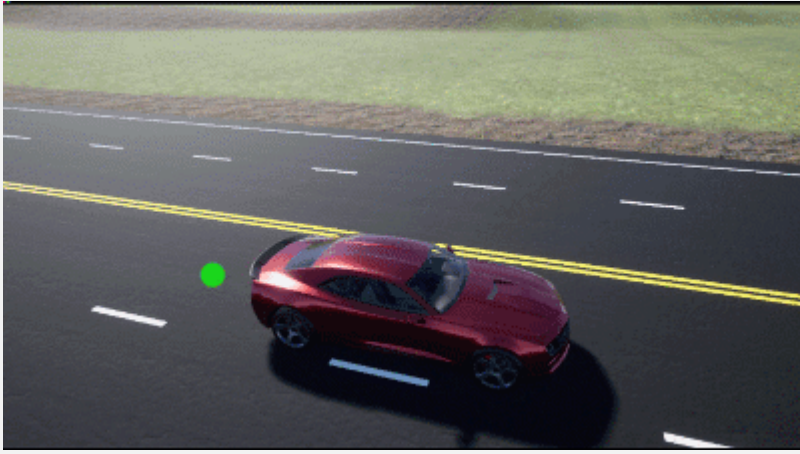
Key	Camera Control
F	<p>Toggle the free camera mode on or off. When you enable the free camera mode, you can use the mouse to change the pitch and yaw of the camera. This mode enables you to orbit the camera around the vehicle.</p> <p>View Animated GIF</p> 

Sample time — Sample time of visualization engine

1/60 (default) | scalar greater than or equal to 0.01

Sample time, T_s , of the visualization engine, specified as a scalar greater than or equal to 0.01. Units are in seconds.

The graphics frame rate of the visualization engine is the inverse of the sample time. For example, if **Sample time** is 1/60, then the visualization engine solver tries to achieve a frame rate of 60 frames per second. However, the real-time graphics frame rate is often lower due to factors such as graphics card performance and model complexity.

By default, blocks that receive data from the visualization engine, such as Simulation 3D Camera blocks, inherit this sample rate.

Display 3D simulation window — Unreal Engine visualization

on (default) | off

Select whether to run simulations in the 3D visualization environment without visualizing the results, that is, in headless mode.

Consider running in headless mode in these cases:

- You want to run multiple 3D simulations in parallel to test models in different Unreal Engine scenarios.
- You want to capture sensor data to analyze in MATLAB but do not need to watch the visualization.

Dependencies

To enable this parameter, set **Scene source** to Default Scenes or Unreal Executable.



Weather

Override scene weather — Control the scene weather and sun position



off (default) | on

Select whether to control the scene weather and sun position during simulation. Use the enabled parameters to change the sun position, clouds, fog, and rain.

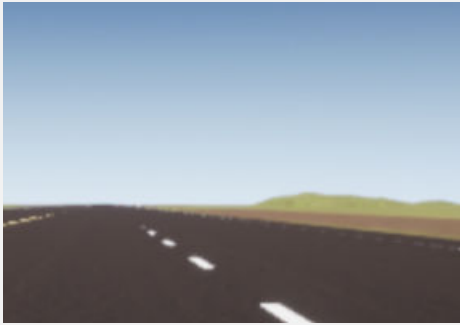

This table summarizes sun position settings for specific times of day.

Time of Day	Settings	Unreal Editor Environment
Midnight	Sun altitude: -90 Sun azimuth: 180	
Sunrise in the north	Sun altitude: 0 Sun azimuth: 180	
Noon	Sun altitude: 90 Sun azimuth: 180	

This table summarizes settings for specific cloud conditions.

Cloud Condition	Settings	Unreal Editor Environment
Clear	Cloud opacity: 0	
Heavy	Cloud opacity: 85	

This table summarizes settings for specific fog conditions.

Fog Condition	Settings	Unreal Editor Environment
None	Fog density: 0	
Heavy	Fog density: 100	

This table summarizes settings for specific rain conditions.

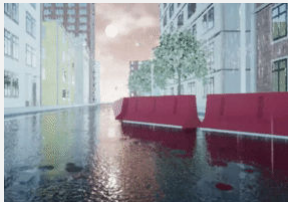
Rain Condition	Settings	Unreal Editor Environment
Light	Cloud opacity: 10 Rain density: 25	
Heavy	Cloud opacity: 10 Rain density: 80	

Sun altitude — Altitude angle between sun and horizon

40 (default) | any value between -90 and 90

Altitude angle in a vertical plane between the sun's rays and the horizontal projection of the rays, in deg.

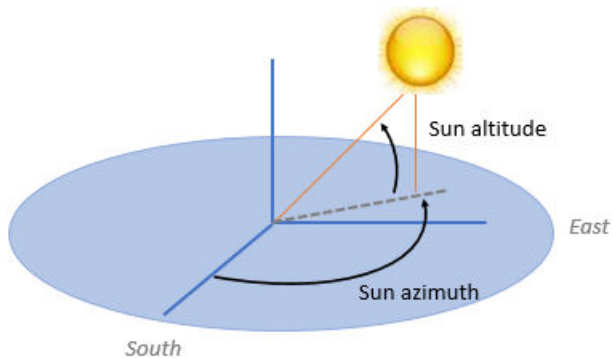

Use the **Sun altitude** and **Sun azimuth** parameters to control the time of day in the scene. For example, to specify sunrise in the north, set **Sun altitude** to 0 deg and **Sun azimuth** to 180 deg.

Dependencies

To enable this parameter, select **Override scene weather**.

Sun azimuth — Azimuth angle from south to horizontal projection of the sun ray

90 (default) | any value between 0 and 360

Azimuth angle in the horizontal plane measured from the south to the horizontal projection of the sun rays, in deg.

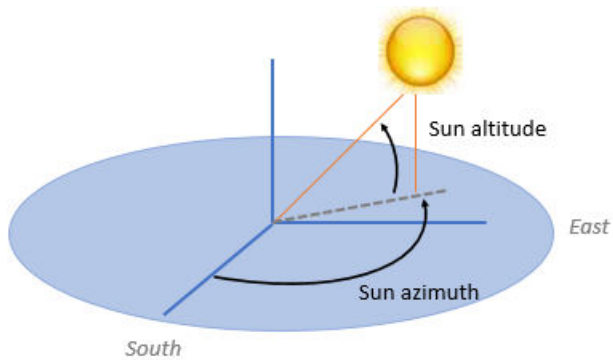

Use the **Sun altitude** and **Sun azimuth** parameters to control the time of day in the scene. For example, to specify sunrise in the north, set **Sun altitude** to 0 deg and **Sun azimuth** to 180 deg.

Dependencies

To enable this parameter, select **Override scene weather**.

Cloud opacity — Unreal Editor Cloud Opacity global actor target value

10 (default) | any value between 0 and 100

Parameter that corresponds to the Unreal Editor **Cloud Opacity** global actor target value, in percent. Zero is a cloudless scene.

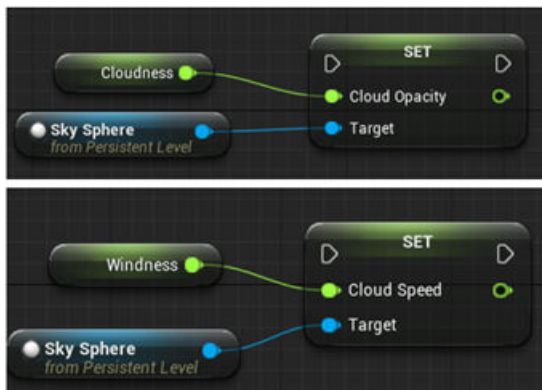

Use the **Cloud opacity** and **Cloud speed** parameters to control clouds in the scene.

Dependencies

To enable this parameter, select **Override scene weather**.

Cloud speed — Unreal Editor Cloud Speed global actor target value

1 (default) | any value between -100 and 100

Parameter that corresponds to the Unreal Editor **Cloud Speed** global actor target value. The clouds move from west to east for positive values and east to west for negative values.



Use the **Cloud opacity** and **Cloud speed** parameters to control clouds in the scene.

Dependencies

To enable this parameter, select **Override scene weather**.

Fog density — Unreal Editor Set Fog Density and Set Start Distance target values

0 (default) | any value between 0 and 100

Parameter that corresponds to the Unreal Editor **Set Fog Density** and **Set Start Distance** target values, in percent.



Dependencies

To enable this parameter, select **Override scene weather**.

Rain density — Unreal Editor local actor controlling rain density, wetness, rain puddles, and ripples

0 (default) | any value between 0 and 100

Parameter corresponding to the Unreal Editor local actor that controls rain density, wetness, rain puddles, and ripples, in percent.

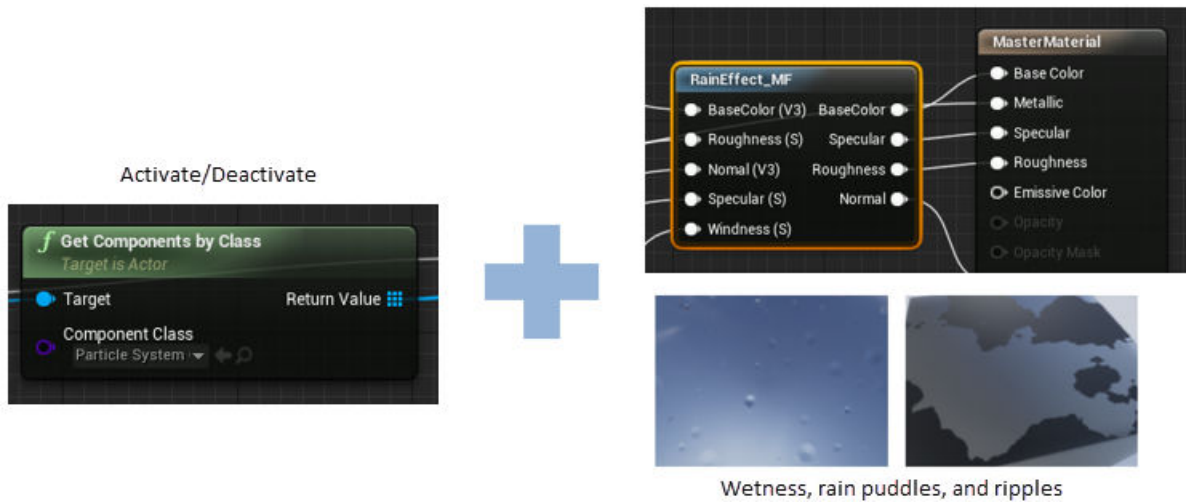

Use the **Cloud opacity** and **Rain density** parameters to control rain in the scene.

Dependencies

To enable this parameter, select **Override scene weather**.

More About

Sun Position and Weather

To control the scene weather and sun position, on the **Weather** tab, select **Override scene weather**. Use the enabled parameters to change the sun position, clouds, fog, and rain during the simulation.



Sun Position

Use **Sun altitude** and **Sun azimuth** to control the sun position.

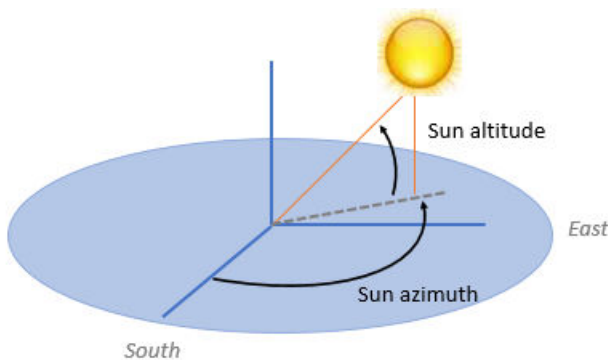
- **Sun altitude** — Altitude angle in a vertical plane between the sun rays and the horizontal projection of the rays.
- **Sun azimuth** — Azimuth angle in the horizontal plane measured from the south to the horizontal projection of the sun rays.



This table summarizes sun position settings for specific times of day.

Time of Day	Settings	Unreal Editor Environment
Midnight	Sun altitude: -90 Sun azimuth: 180	
Sunrise in the north	Sun altitude: 0 Sun azimuth: 180	
Noon	Sun altitude: 90 Sun azimuth: 180	



Clouds

Use **Cloud opacity** and **Cloud speed** to control clouds in the scene.

- **Cloud opacity** — Unreal Editor **Cloud Opacity** global actor target value. Zero is a cloudless scene.
- **Cloud speed** — Unreal Editor **Cloud Speed** global actor target value. The clouds move from west to east for positive values and east to west for negative values.



This table summarizes settings for specific cloud conditions.



Cloud Condition	Settings	Unreal Editor Environment
Clear	Cloud opacity: 0	
Heavy	Cloud opacity: 85	

Fog

Use **Fog density** to control fog in the scene. **Fog density** corresponds to the Unreal Editor **Set Fog Density**.

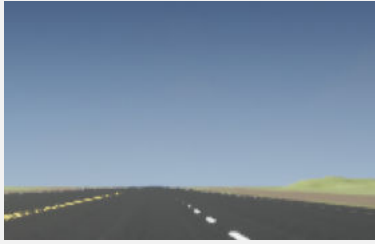

This table summarizes settings for specific fog conditions.

Fog Condition	Settings	Unreal Editor Environment
None	Fog density: 0	
Heavy	Fog density: 100	

Rain

Use **Cloud opacity** and **Rain density** to control rain in the scene.

- **Cloud opacity** — Unreal Editor **Cloud Opacity** global actor target value.
- **Rain density** — Unreal Editor local actor that controls rain density, wetness, rain puddles, and ripples.

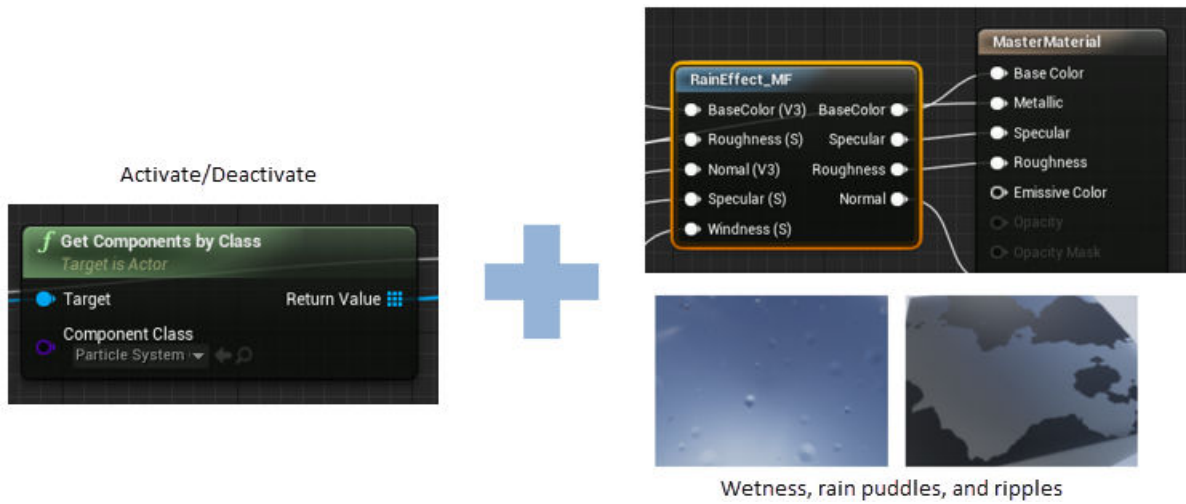

This table summarizes settings for specific rain conditions.

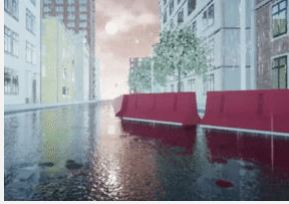
Rain Condition	Settings	Unreal Editor Environment
Light	<p>Cloud opacity: 10</p> <p>Rain density: 25</p>	
Heavy	<p>Cloud opacity: 10</p> <p>Rain density: 80</p>	

Version History

Introduced in R2019b

See Also

Simulation 3D Vehicle with Ground Following | Simulation 3D Camera | Simulation 3D Fisheye Camera | Simulation 3D Lidar | Simulation 3D Probabilistic Radar | Simulation 3D Vision Detection Generator

Topics

- “Unreal Engine Simulation for Automated Driving”
- “Unreal Engine Simulation Environment Requirements and Limitations”
- “How Unreal Engine Simulation for Automated Driving Works”
- “Customize Unreal Engine Scenes for Automated Driving”
- “Prepare Custom Vehicle Mesh for the Unreal Editor”

Simulation 3D Vehicle with Ground Following

Implement vehicle that follows ground in 3D environment

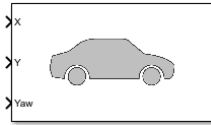

Libraries:

Automated Driving Toolbox / Simulation 3D
Vehicle Dynamics Blockset / Vehicle Scenarios / Sim3D / Sim3D Vehicle /
Components

Description

The Simulation 3D Vehicle with Ground Following block implements a vehicle with four wheels in a 3D simulation environment. This environment is rendered using the Unreal Engine from Epic Games. The block uses the input (X , Y) position and yaw angle of the vehicle to adjust the elevation, roll angle, and pitch angle of the vehicle so that it follows the ground terrain. The block determines the vehicle velocity and heading and adjusts the steering angle and rotation for each wheel. Use this block for automated driving applications.

To use this block, ensure that the Simulation 3D Scene Configuration block is in your model. If you set the **Sample time** parameter of the Simulation 3D Vehicle with Ground Following block to -1 , the block inherits the sample time specified in the Simulation 3D Scene Configuration block.

The block input uses the vehicle Z-up right-handed (RH) Cartesian coordinate system defined in SAE J670 [1] and ISO 8855 [2]. The coordinate system is inertial and initially aligned with the vehicle geometric center:

- The X -axis is along the longitudinal axis of the vehicle and points forward.
- The Y -axis is along the lateral axis of the vehicle and points to the left.
- The Z -axis points upward.

The yaw, pitch, and roll angles of the Z -axis, Y -axis, and X -axis, respectively, are positive in the clockwise directions, when looking in the positive directions of these axes. Vehicles are placed in the world coordinate system of the scenes. For more details, see “Coordinate Systems for Unreal Engine Simulation in Automated Driving Toolbox”.

Note The Simulation 3D Vehicle with Ground Following block must execute before the Simulation 3D Scene Configuration block. That way, the Simulation 3D Vehicle with Ground Following block prepares the signal data before the Unreal Engine 3D visualization environment receives it. To check the block execution order, right-click the blocks and select **Properties**. On the **General** tab, confirm these **Priority** settings:

- Simulation 3D Scene Configuration — 0
- Simulation 3D Vehicle with Ground Following — -1

For more information about execution order, see “How Unreal Engine Simulation for Automated Driving Works”.

You can configure the Simulation 3D Vehicle with Ground Following block to import custom meshes on page 2-155 and control vehicle lights on page 2-155.

Limitations

- The **Bird's-Eye Scope** is unable to find ground truth signals, such as roads, lanes, and actors, from the Simulation 3D Scene Configuration block.

Ports

Input

X — Longitudinal position of vehicle
scalar

Longitudinal position of the vehicle along the *X*-axis of the scene. **X** is in the inertial *Z*-up coordinate system. Units are in meters.

The *X* value of the **Initial position [X, Y, Z] (m)** parameter must match the value of this port at the start of simulation.

To specify multiple positions at port **X** along an entire vehicle path, first define a time series of *X* waypoints in MATLAB. Then, feed these waypoints to **X** by using a From Workspace block. To learn how to select and specify waypoints, see the “Select Waypoints for Unreal Engine Simulation” example.

Y — Lateral position of vehicle
scalar

Lateral position of the vehicle along the *Y*-axis of the scene. **Y** is in the inertial *Z*-up coordinate system. Units are in meters.

The *Y* value of the **Initial position [X, Y, Z] (m)** parameter must match the value of this port at the start of simulation.

To specify multiple positions at port **Y** along an entire vehicle path, first define a time series of *Y* waypoints in MATLAB. Then, feed these waypoints to **Y** by using a From Workspace block. To learn how to select and specify waypoints, see the “Select Waypoints for Unreal Engine Simulation” example.

Yaw — Yaw orientation angle of vehicle
scalar

Yaw orientation angle of the vehicle along the *Z*-axis of the scene. **Yaw** is in the *Z*-up coordinate system. Units are in degrees.

The yaw value of the **Initial rotation [Roll, Pitch, Yaw] (deg)** parameter must match the value of this port at the start of simulation.

To specify multiple orientation angles at port **Yaw** along an entire vehicle path, first define a time series of yaw waypoints in MATLAB. Then, feed these waypoints to **Yaw** by using a From Workspace block. To learn how to select and specify waypoints, see the “Select Waypoints for Unreal Engine Simulation” example.

Light controls — Vehicle lights on or off
1-by-6 vector

Light controls input signal, specified as a 1-by-6 Boolean vector. Each element of the vector turns a specific vehicle light on or off, as indicated in this table. A value of 1 turns the light on; a value of 0 turns the light off

Vector Element	Vehicle Light
(1,1)	Headlight high beam
(1,2)	Headlight low beam
(1,3)	Brake
(1,4)	Reverse
(1,5)	Left signal
(1,6)	Right signal

Dependencies

To create this port, on the **Light Controls** tab, select **Enable light controls**.

Data Types: Boolean

Output

Location — Location of vehicle

real-valued 1-by-3 vector

(*X*, *Y*, *Z*) location of the vehicle in the scene, returned as a real-valued 1-by-3 vector. This location is based on the vehicle origin, which is on the ground, at the geometric center of the vehicle. **Location** values are in the inertial Z-up world coordinate system. Units are in meters.

Dependencies

To enable this port, on the **Ground Truth** tab, select **Output location (m) and orientation (rad)**.

Data Types: double

Orientation — Orientation of vehicle

real-valued 1-by-3 vector

Yaw, pitch, and roll orientation angles of the vehicle about the Z-axis, Y-axis, and X-axes of the scene, respectively, returned as a real-valued 1-by-3 vector. This orientation is based on the vehicle origin, which is on the ground, at the geometric center of the vehicle. **Orientation** values are in the inertial Z-up coordinate system. Units are in radians.

Dependencies

To enable this port, on the **Ground Truth** tab, select **Output location (m) and orientation (rad)**.

Data Types: double

Parameters

Vehicle Parameters

Type — Type of vehicle

Muscle car (default) | Sedan | Sport utility vehicle | Small pickup truck | Hatchback | Box truck | Custom

Select the type of vehicle. To obtain the dimensions of each vehicle type, see these reference pages:

- Muscle car — **Muscle Car**
- Sedan — **Sedan**
- Sport utility vehicle — **Sport Utility Vehicle**
- Small pickup truck — **Small Pickup Truck**
- Hatchback — **Hatchback**
- Box truck — **Box Truck**

Dependencies

Selecting Custom enables parameters that allow you to import a custom mesh for your vehicle.

Path to custom mesh — Path to custom mesh

/MathWorksSimulation/Vehicles/Muscle/Meshes/SK_MuscleCar.SK_MuscleCar (default) | valid path

Path to custom mesh.

To create a custom vehicle mesh, see “Prepare Custom Vehicle Mesh for the Unreal Editor”.

Example: /MathWorksSimulation/Vehicles/Muscle/Meshes/SK_Sedan.SK_Sedan

Dependencies

To enable this parameter, set **Type** to Custom.

Track width in custom mesh (m) — Track width

1.9 (default) | scalar

Track width in custom mesh, in m.

Dependencies

To enable this parameter, set **Type** to Custom.

Wheel base in custom mesh (m) — Wheel base

3 (default) | scalar

Wheel base in custom mesh, in m.

Dependencies

To enable this parameter, set **Type** to Custom.

Wheel radius in custom mesh (m) — Wheel radius

0.35 (default) | scalar

Wheel radius in custom mesh, in m.

Dependencies

To enable this parameter, set **Type** to Custom.

Color — Color of vehicle

Red (default) | Orange | Yellow | Green | Blue | Black | White | Silver

Select the color of the vehicle.

Initial position [X, Y, Z] (m) — Initial vehicle position

[0, 0, 0] (default) | real-valued 1-by-3 vector

Initial vehicle position along the X-axis, Y-axis, and Z-axis of the scene. This position is in the inertial Z-up coordinate system. Units are in meters.

Set the X and Y values of this parameter to match the **X** and **Y** input port values at the start of simulation.

Initial rotation [Roll, Pitch, Yaw] (deg) — Initial angle of vehicle rotation

[0, 0, 0] (default) | real-valued 1-by-3 vector

Initial angle of vehicle rotation. The angle of rotation is defined by the roll, pitch, and yaw of the vehicle. Units are in degrees.

Set the yaw value of this parameter to match the **Yaw** input port value at the start of simulation.

Name — Name of vehicle

SimulinkVehicle1 (default) | vehicle name

Name of vehicle. By default, when you use the block in your model, the block sets the **Name** parameter to `SimulinkVehicleX`. The value of X depends on the number of Simulation 3D Vehicle with Ground Following blocks that you have in your model.

The vehicle name appears as a selection in the **Parent name** parameter of any Automated Driving Toolbox Simulation 3D sensor blocks within the same model as the vehicle. With the **Parent name** parameter, you can select the vehicle on which to mount the sensor.

Sample time — Sample time

-1 (default) | positive scalar

Sample time, T_s , in seconds. The graphics frame rate is the inverse of the sample time.

If you set the sample time to -1, the block uses the sample time specified in the Simulation 3D Scene Configuration block.

Light Controls**Enable light controls** — Control vehicle lights

off (default) | on

Select whether to control the vehicle headlights. Use the enabled parameters to set the light parameters, including headlight intensity.

Dependencies

Selecting this parameter:

- Creates the input port `Light controls`
- Enables these light parameters.

Lights	Light Parameters
Headlights	<ul style="list-style-type: none"> • Headlight color • High beam intensity • Low beam intensity • High beam cone half angle • Low beam cone half angle • Left headlight beam orientation • Right headlight beam orientation
Brake lights	Brake light intensity
Reverse lights	Reverse light intensity
Turn signal lights	<ul style="list-style-type: none"> • Turn signal light intensity • Period • Pulse width

Headlights

Headlight color [R,G,B] — Headlight color

[1, 1, 1] (default) | 1-by-3 array of RGB triplet values

Headlight color, specified as a normalized 1-by-3 array of RGB triplet values.

Dependencies

To enable this parameter, select **Enable light controls**.

Data Types: `int8` | `uint8`

High beam intensity (cd) — High beam intensity

100000 (default) | positive scalar

High beam intensity, in cd.

Dependencies

To enable this parameter, select **Enable light controls**.

Data Types: `double`

Low beam intensity (cd) — Low beam intensity

60000 (default) | positive scalar

Low beam intensity, in cd.

Dependencies

To enable this parameter, select **Enable light controls**.

Data Types: double

High beam cone half angle (deg) — High beam cone half angle

70 (default) | positive scalar less than or equal to 90

High beam cone half angle, in deg.

Dependencies

To enable this parameter, select **Enable light controls**.

Data Types: double

Low beam cone half angle (deg) — Low beam cone half angle

70 (default) | positive scalar less than or equal to 90

Low beam cone half angle, in deg.

Dependencies

To enable this parameter, select **Enable light controls**.

Data Types: double

Left headlight beam orientation [Pitch, Yaw] (deg) — Left headlight beam orientation [Pitch, Yaw] (deg)

[0, 0] (default) | 1-by-2 array with values between -180 and 180

Pitch and yaw orientation of the left headlight beam orientation in the Z-up coordinate system, specified as a 1-by-2 array, in deg. The first element of the array, [1, 1], is the pitch angle. The second element of the array, [1, 2] is the yaw angle.

Dependencies

To enable this parameter, select **Enable light controls**.

Data Types: double

Right headlight beam orientation [Pitch, Yaw] (deg) — Right headlight beam orientation

[0, 0] (default) | 1-by-2 array with values between -180 and 180

Pitch and yaw orientation of the right headlight beam orientation in the Z-up coordinate system, specified as a 1-by-2 array, in deg. The first element of the array, [1, 1], is the pitch angle. The second element of the array, [1, 2] is the yaw angle.

Dependencies

To enable this parameter, select **Enable light controls**.

Brake Lights

Brake light intensity (cd/m²) — Intensity

500 (default) | positive scalar

Brake light intensity, in cd/m².

Dependencies

To enable this parameter, select **Enable light controls**.

Data Types: double

Reverse Lights

Reverse light intensity (cd/m²) — Intensity

500 (default) | positive scalar

Reverse light intensity, in cd/m².

Dependencies

To enable this parameter, select **Enable light controls**.

Data Types: double

Turn Signal Lights

Turn signal light intensity (cd/m²) — Intensity

500 (default) | positive scalar

Turn signal light intensity, in cd/m².

Dependencies

To enable this parameter, select **Enable light controls**.

Data Types: double

Period (s) — Turn signal light period

1 (default) | positive scalar

Turn signal light period, in s.

Dependencies

To enable this parameter, select **Enable light controls**.

Data Types: double

Pulse width (% of period) — Pulse width

50 (default) | positive scalar less than 100

Turn signal light pulse width, as a percent of the period.

Dependencies

To enable this parameter, select **Enable light controls**.

Data Types: double

Ground Truth

Output location (m) and orientation (rad) — Output location and orientation of vehicle

off (default) | on

Select this parameter to output the location and orientation of the vehicle at the **Location** and **Orientation** ports, respectively.

More About

Import Custom Meshes

To import custom meshes for defining custom vehicles, follow these steps:

- 1 Install the Automated Driving Toolbox Interface for Unreal Engine 4 Projects support package. See “Install Support Package for Customizing Scenes”.
- 2 On the block **Parameters** tab, set **Type** to Custom.
- 3 In the **Path to custom mesh** field, enter the path to the vehicle mesh in the Unreal Engine project. For example, enter `/MathWorksSimulation/Vehicles/Muscle/Meshes/SK_MuscleCar.SK_MuscleCar`.

To create a custom vehicle mesh, see “Prepare Custom Vehicle Mesh for the Unreal Editor”.

- 4 Use the vehicle dimensions in the custom mesh to enter the dimensions in the corresponding block parameter fields.

Control Vehicle Lights

To control the lights of vehicles in a scene, follow these steps:

- 1 Install the Automated Driving Toolbox Interface for Unreal Engine 4 Projects support package. See “Install Support Package for Customizing Scenes”.
- 2 On the block **Light Controls** tab, select **Enable light controls**.
- 3 Use the enabled parameters to specify the vehicle light for:
 - Headlights
 - Brake lights
 - Reverse lights
 - Turn signal lights
- 4 Connect Boolean light control signals to the `Signal` lights input port.

Version History

Introduced in R2019b

References

- [1] Vehicle Dynamics Standards Committee. *Vehicle Dynamics Terminology*. SAE J670. Warrendale, PA: Society of Automotive Engineers, 2008.
- [2] Technical Committee. *Road vehicles — Vehicle dynamics and road-holding ability — Vocabulary*. ISO 8855:2011. Geneva, Switzerland: International Organization for Standardization, 2011.

See Also

Simulation 3D Scene Configuration | Simulation 3D Probabilistic Radar | Simulation 3D Vision Detection Generator | Simulation 3D Lidar | Simulation 3D Fisheye Camera | Simulation 3D Camera

Topics

“How Unreal Engine Simulation for Automated Driving Works”
“Coordinate Systems for Unreal Engine Simulation in Automated Driving Toolbox”
“Perception-Based Parking Spot Detection Using Unreal Engine Simulation”

Simulation 3D Camera

Camera sensor model with lens in 3D simulation environment

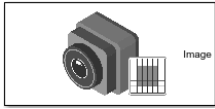

Libraries:

UAV Toolbox / Simulation 3D

Automated Driving Toolbox / Simulation 3D

Description



The Simulation 3D Camera block provides an interface to a camera with a lens in a 3D simulation environment. This environment is rendered using the Unreal Engine from Epic Games. The sensor is based on the ideal pinhole camera model, with a lens added to represent a full camera model, including lens distortion. This camera model supports a field of view of up to 150 degrees. For more details, see “Algorithms” on page 2-173.

If you set **Sample time** to -1, the block uses the sample time specified in the Simulation 3D Scene Configuration block. To use this sensor, you must include a Simulation 3D Scene Configuration block in your model.

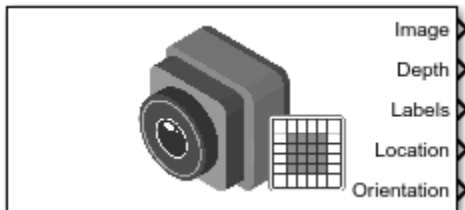
The block outputs images captured by the camera during simulation. You can use these images to visualize and verify your driving algorithms. In addition, on the **Ground Truth** tab, you can select options to output the ground truth data for developing depth estimation and semantic segmentation algorithms. You can also output the location and orientation of the camera in the world coordinate system of the scene. The image shows the block with all ports enabled.

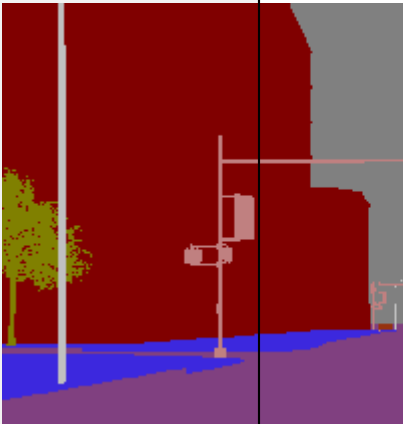

The table summarizes the ports and how to enable them.

Port	Description	Parameter for Enabling Port	Sample Visualization
Image	Outputs an RGB image captured by the camera	n/a	
Depth	Outputs a depth map with values from 0 m to 1000 meters	Output depth	
Labels	Outputs a semantic segmentation map of label IDs that correspond to objects in the scene	Output semantic segmentation	
Location	Outputs the location of the camera in the world coordinate system	Output location (m) and orientation (rad)	n/a
Orientation	Outputs the orientation of the camera in the world coordinate system	Output location (m) and orientation (rad)	n/a

Note The Simulation 3D Scene Configuration block must execute before the Simulation 3D Camera block. That way, the Unreal Engine 3D visualization environment prepares the data before the Simulation 3D Camera block receives it. To check the block execution order, right-click the blocks and select **Properties**. On the **General** tab, confirm these **Priority** settings:

- Simulation 3D Scene Configuration — 0
- Simulation 3D Camera — 1

For more information about execution order, see “How Unreal Engine Simulation for Automated Driving Works”.

Ports

Input

Translation — Relative translation of sensor from mounting point (m)

[0 0 0] (default) | real-valued 1-by-3 vector of form [X Y Z]

Relative translation of the sensor from its mounting point on the vehicle, in meters, specified as a real-valued 1-by-3 vector of the form [X Y Z].

Dependencies

To enable this port, select the **Input** parameter next to the **Relative translation [X, Y, Z] (m)** parameter. When you select **Input**, the **Relative translation [X, Y, Z] (m)** parameter specifies the initial relative translation and the **Translation** port specifies the relative translation during simulation. For more details, see “Sensor Position Transformation” on page 2-173.

Data Types: single | double | int8 | int16 | int32 | int64 | uint8 | uint16 | uint32 | uint64

Rotation — Relative rotation of sensor from mounting point (deg)

[0 0 0] (default) | real-valued 1-by-3 vector of form [Roll Pitch Yaw]

Relative rotation of the sensor from its mounting point on the vehicle, in degrees, specified as a real-valued 1-by-3 vector of the form [Roll Pitch Yaw].

Dependencies

To enable this port, select the **Input** parameter next to the **Relative rotation [Roll, Pitch, Yaw] (deg)** parameter. When you select **Input**, the **Relative rotation [Roll, Pitch, Yaw] (deg)** parameter specifies the initial relative rotation and the **Rotation** port specifies the relative rotation during simulation. For more details, see “Sensor Position Transformation” on page 2-173.

Data Types: single | double | int8 | int16 | int32 | int64 | uint8 | uint16 | uint32 | uint64

Output

Image — 3D output camera image

m-by-*n*-by-3 array of RGB triplet values

3D output camera image, returned as an *m*-by-*n*-by-3 array of RGB triplet values. *m* is the vertical resolution of the image, and *n* is the horizontal resolution of the image.

Data Types: int8 | uint8

Depth — Object depth from 0 m to 1000 m

m-by-n array of object depths

Object depth for each pixel in the image, output as an *m-by-n* array. *m* is the vertical resolution of the image, and *n* is the horizontal resolution of the image. Depth is in the range from 0 to 1000 meters.

Dependencies

To enable this port, on the **Ground Truth** tab, select **Output depth**.

Data Types: double

Labels — Label identifiers

m-by-n array of label identifiers

Label identifier for each pixel in the image, output as an *m-by-n* array. *m* is the vertical resolution of the image, and *n* is the horizontal resolution of the image.

The table shows the object IDs used in the default scenes that are selectable from the Simulation 3D Scene Configuration block. If you are using a custom scene, in the Unreal Editor, you can assign new object types to unused IDs. For more details, see “Apply Labels to Unreal Scene Elements for Semantic Segmentation and Object Detection”. If a scene contains an object that does not have an assigned ID, that object is assigned an ID of 0. The detection of lane markings is not supported.

ID	Type
0	None/default
1	Building
2	<i>Not used</i>
3	Other
4	Pedestrians
5	Pole
6	Lane Markings
7	Road
8	Sidewalk
9	Vegetation
10	Vehicle
11	<i>Not used</i>
12	Generic traffic sign
13	Stop sign
14	Yield sign
15	Speed limit sign
16	Weight limit sign
17 - 18	<i>Not used</i>
19	Left and right arrow warning sign
20	Left chevron warning sign
21	Right chevron warning sign

ID	Type
22	<i>Not used</i>
23	Right one-way sign
24	<i>Not used</i>
25	School bus only sign
26-38	<i>Not used</i>
39	Crosswalk sign
40	<i>Not used</i>
41	Traffic signal
42	Curve right warning sign
43	Curve left warning sign
44	Up right arrow warning sign
45-47	<i>Not used</i>
48	Railroad crossing sign
49	Street sign
50	Roundabout warning sign
51	Fire hydrant
52	Exit sign
53	Bike lane sign
54-56	<i>Not used</i>
57	Sky
58	Curb
59	Flyover ramp
60	Road guard rail
61	Bicyclist
62-66	<i>Not used</i>
67	Deer
68-70	<i>Not used</i>
71	Barricade
72	Motorcycle
73-255	<i>Not used</i>

Dependencies

To enable this port, on the **Ground Truth** tab, select **Output semantic segmentation**.

Data Types: uint8

Note Enabling Labels requires Sim 3D Semantic actor with the tag SemanticSegmentationSensor<N> to be placed at the same position. N is the sensor identifier.

The Simulation 3D Camera block instantiates the Sim 3D Camera and Sim 3d Semantic when the Labels output is enabled.

Location — Sensor location

real-valued 1-by-3 vector

Sensor location along the *X*-axis, *Y*-axis, and *Z*-axis of the scene. The **Location** values are in the world coordinates of the scene. In this coordinate system, the *Z*-axis points up from the ground. Units are in meters.

Dependencies

To enable this port, on the **Ground Truth** tab, select **Output location (m) and orientation (rad)**.

Data Types: double

Orientation — Sensor orientation

real-valued 1-by-3 vector

Roll, pitch, and yaw sensor orientation about the *X*-axis, *Y*-axis, and *Z*-axis of the scene. The **Orientation** values are in the world coordinates of the scene. These values are positive in the clockwise direction when looking in the positive directions of these axes. Units are in radians.

Dependencies

To enable this port, on the **Ground Truth** tab, select **Output location (m) and orientation (rad)**.

Data Types: double

Parameters

Mounting**Sensor identifier** — Unique sensor identifier

1 (default) | positive integer

Specify the unique identifier of the sensor. In a multisensor system, the sensor identifier enables you to distinguish between sensors. When you add a new sensor block to your model, the **Sensor identifier** of that block is $N + 1$, where N is the highest **Sensor identifier** value among the existing sensor blocks in the model.

Example: 2

Parent name — Name of parent vehicle

Scene Origin (default) | vehicle name

Name of the parent to which the sensor is mounted, specified as `Scene Origin` or as the name of a vehicle in your model. The vehicle names that you can select correspond to the **Name** parameters of the simulation 3D vehicle blocks in your model. If you select `Scene Origin`, the block places a sensor at the scene origin.

Example: `SimulinkVehicle1`

Mounting location — Sensor mounting location



Origin (default) | Front bumper | Rear bumper | Right mirror | Left mirror | Rearview mirror | Hood center | Roof center

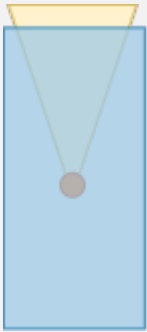

Sensor mounting location.

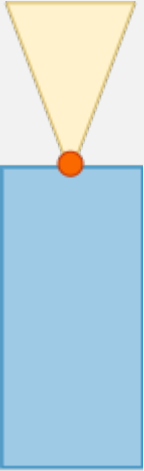
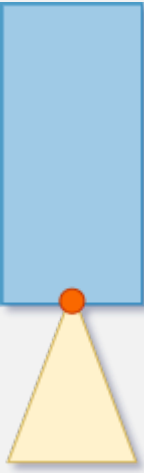
- When **Parent name** is Scene Origin, the block mounts the sensor to the origin of the scene. You can set the **Mounting location** to Origin only. During simulation, the sensor remains stationary.
- When **Parent name** is the name of a vehicle, the block mounts the sensor to one of the predefined mounting locations described in the table. During simulation, the sensor travels with the vehicle.

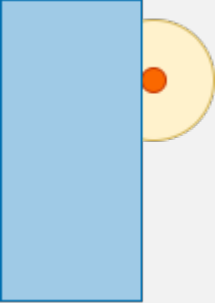
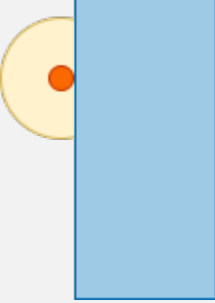
Vehicle Mounting Location	Description	Orientation Relative to Vehicle Origin [Roll, Pitch, Yaw] (deg)
Origin	<p>Forward-facing sensor mounted to the vehicle origin, which is on the ground and at the geometric center of the vehicle (see “Coordinate Systems for Unreal Engine Simulation in Automated Driving Toolbox”)</p> 	[0, 0, 0]

Vehicle Mounting Location	Description	Orientation Relative to Vehicle Origin [Roll, Pitch, Yaw] (deg)
Front bumper	Forward-facing sensor mounted to the front bumper 	[0, 0, 0]
Rear bumper	Backward-facing sensor mounted to the rear bumper 	[0, 0, 180]

Vehicle Mounting Location	Description	Orientation Relative to Vehicle Origin [Roll, Pitch, Yaw] (deg)
Right mirror	Downward-facing sensor mounted to the right side-view mirror 	[0, -90, 0]
Left mirror	Downward-facing sensor mounted to the left side-view mirror 	[0, -90, 0]
Rearview mirror	Forward-facing sensor mounted to the rearview mirror, inside the vehicle 	[0, 0, 0]

Vehicle Mounting Location	Description	Orientation Relative to Vehicle Origin [Roll, Pitch, Yaw] (deg)
Hood center	Forward-facing sensor mounted to the center of the hood 	[0, 0, 0]
Roof center	Forward-facing sensor mounted to the center of the roof 	[0, 0, 0]

Roll, pitch, and yaw are clockwise-positive when looking in the positive direction of the X-axis, Y-axis, and Z-axis, respectively. When looking at a vehicle from above, the yaw angle (the orientation angle) is counterclockwise-positive because you are looking in the negative direction of the axis.

The X-Y-Z mounting location of the sensor relative to the vehicle depends on the vehicle type. To specify the vehicle type, use the **Type** parameter of the Simulation 3D Vehicle with Ground Following block to which you mount the sensor. To obtain the X-Y-Z mounting locations for a vehicle type, see the reference page for that vehicle.

To determine the location of the sensor in world coordinates, open the sensor block. Then, on the **Ground Truth** tab, select the **Output location (m) and orientation (rad)** parameter and inspect the data from the **Location** output port.

Specify offset — Specify offset from mounting location

off (default) | on

Select this parameter to specify an offset from the mounting location by using the **Relative translation [X, Y, Z] (m)** and **Relative rotation [Roll, Pitch, Yaw] (deg)** parameters.

Relative translation [X, Y, Z] (m) — Translation offset relative to mounting location

[0, 0, 0] (default) | real-valued 1-by-3 vector

Translation offset relative to the mounting location of the sensor, specified as a real-valued 1-by-3 vector of the form [X, Y, Z]. Units are in meters.

If you mount the sensor to a vehicle by setting **Parent name** to the name of that vehicle, then X, Y, and Z are in the vehicle coordinate system, where:

- The X-axis points forward from the vehicle.
- The Y-axis points to the left of the vehicle, as viewed when looking in the forward direction of the vehicle.
- The Z-axis points up.

The origin is the mounting location specified in the **Mounting location** parameter. This origin is different from the vehicle origin, which is the geometric center of the vehicle.

If you mount the sensor to the scene origin by setting **Parent name** to Scene Origin, then X, Y, and Z are in the world coordinates of the scene.

For more details about the vehicle and world coordinate systems, see “Coordinate Systems for Unreal Engine Simulation in Automated Driving Toolbox”.

Example: [0, 0, 0.01]

Adjust Relative Translation During Simulation

To adjust the relative translation of the sensor during simulation, enable the **Translation** input port by selecting the **Input** parameter next to the **Relative translation [X, Y, Z] (m)** parameter. When you enable the **Translation** port, the **Relative translation [X, Y, Z] (m)** parameter specifies the initial relative translation of the sensor and the **Translation** port specifies the relative translation of the sensor during simulation. For more details about the relative translation and rotation of this sensor, see “Sensor Position Transformation” on page 2-173.

Dependencies

To enable this parameter, select **Specify offset**.

Relative rotation [Roll, Pitch, Yaw] (deg) — Rotational offset relative to mounting location

[0, 0, 0] (default) | real-valued 1-by-3 vector

Rotational offset relative to the mounting location of the sensor, specified as a real-valued 1-by-3 vector of the form [Roll, Pitch, Yaw]. Roll, pitch, and yaw are the angles of rotation about the X-, Y-, and Z-axes, respectively. Units are in degrees.

If you mount the sensor to a vehicle by setting **Parent name** to the name of that vehicle, then X, Y, and Z are in the vehicle coordinate system, where:

- The X-axis points forward from the vehicle.
- The Y-axis points to the left of the vehicle, as viewed when looking in the forward direction of the vehicle.

- The Z-axis points up.
- Roll, pitch, and yaw are clockwise-positive when looking in the forward direction of the X-axis, Y-axis, and Z-axis, respectively. If you view a scene from a 2D top-down perspective, then the yaw angle (also called the orientation angle) is counterclockwise-positive because you are viewing the scene in the negative direction of the Z-axis.

The origin is the mounting location specified in the **Mounting location** parameter. This origin is different from the vehicle origin, which is the geometric center of the vehicle.

If you mount the sensor to the scene origin by setting **Parent name** to `Scene Origin`, then X, Y, and Z are in the world coordinates of the scene.

For more details about the vehicle and world coordinate systems, see “Coordinate Systems for Unreal Engine Simulation in Automated Driving Toolbox”.

Example: `[0, 0, 10]`

Adjust Relative Rotation During Simulation

To adjust the relative rotation of the sensor during simulation, enable the **Rotation** input port by selecting the **Input** parameter next to the **Relative rotation [Roll, Pitch, Yaw] (deg)** parameter. When you enable the **Rotation** port, the **Relative rotation [Roll, Pitch, Yaw] (deg)** parameter specifies the initial relative rotation of the sensor and the **Rotation** port specifies the relative rotation of the sensor during simulation. For more details about the relative translation and rotation of this sensor, see “Sensor Position Transformation” on page 2-173.

Dependencies

To enable this parameter, select **Specify offset**.

Sample time — Sample time

-1 (default) | positive scalar

Sample time of the block, in seconds, specified as a positive scalar. The 3D simulation environment frame rate is the inverse of the sample time.

If you set the sample time to -1, the block inherits its sample time from the Simulation 3D Scene Configuration block.

Parameters

These intrinsic camera parameters are equivalent to the properties of a `cameraIntrinsics` object. To obtain the intrinsic parameters for your camera, use the **Camera Calibrator** app.

For details about the camera calibration process, see “Using the Single Camera Calibrator App” and “What Is Camera Calibration?”.

Focal length (pixels) — Focal length of camera

`[1109, 1109]` (default) | 1-by-2 positive integer vector

Specify the focal length of the camera as a 1-by-2 positive integer vector of the form $[f_x, f_y]$. Units are in pixels.

$$f_x = F \times s_x$$

$$f_y = F \times s_y$$

where:

- F is the focal length in world units, typically millimeters.
- $[sx, sy]$ are the number of pixels per world unit in the x and y direction, respectively.

This parameter is equivalent to the `FocalLength` property of a `cameraIntrinsics` object.

Optical center (pixels) — Optical center of camera

`[640, 360]` (default) | 1-by-2 positive integer vector

Specify the optical center of the camera as a 1-by-2 positive integer vector of the form $[cx, cy]$. Units are in pixels.

This parameter is equivalent to the `PrincipalPoint` property of a `cameraIntrinsics` object.

Image size (pixels) — Image size produced by camera

`[720, 1280]` (default) | 1-by-2 positive integer vector

Specify the image size produced by the camera as a 1-by-2 positive integer vector of the form $[mrows, ncols]$. Units are in pixels.

This parameter is equivalent to the `ImageSize` property of a `cameraIntrinsics` object.

Radial distortion coefficients — Radial distortion coefficients

`[0, 0]` (default) | real-valued 2-element vector | real-valued 3-element vector | real-valued 6-element vector

Specify the radial distortion coefficients as a real-valued 2-element, 3-element, or 6-element vector. Radial distortion is the displacement of image points along radial lines extending from the principal point.

- As image points move away from the principal point (positive radial displacement), image magnification decreases and a pincushion-shaped distortion occurs on the image.
- As image points move toward the principal point (negative radial displacement), image magnification increases and a barrel-shaped distortion occurs on the image.

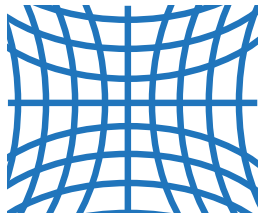

Pincushion distortion
Positive radial displacement

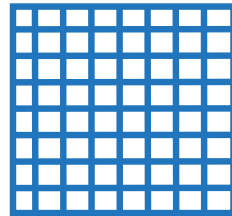

No distortion

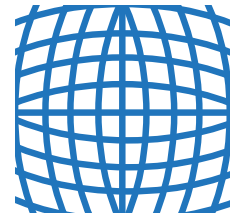

Barrel distortion
Negative radial displacement

The camera sensor calculates the (x_d, y_d) radial-distorted location of a point using a two-coefficient, three-coefficient, or six-coefficient formula. This table shows the various formulas, where:

- (x, y) = undistorted pixel locations
- $k_1, k_2, k_3, k_4, k_5, k_6$ = radial distortion coefficients of the lens
- $r^2 = x^2 + y^2$

Coefficients	Formula	Description
[k1, k2]	$x_d = x(1 + k_1r^2 + k_2r^4)$ $y_d = y(1 + k_1r^2 + k_2r^4)$	This model is equivalent to the two-coefficient model used by the RadialDistortion property of a cameraIntrinsics object.
[k1, k2, k3]	$x_d = x(1 + k_1r^2 + k_2r^4 + k_3r^6)$ $y_d = y(1 + k_1r^2 + k_2r^4 + k_3r^6)$	This model is equivalent to the three-coefficient model used by the RadialDistortion property of a cameraIntrinsics object.
[k1, k2, k3, k4, k5, k6]	$x_d = x \times \frac{1 + k_1r^2 + k_2r^4 + k_3r^6}{1 + k_4r^2 + k_5r^4 + k_6r^6}$ $y_d = y \times \frac{1 + k_1r^2 + k_2r^4 + k_3r^6}{1 + k_4r^2 + k_5r^4 + k_6r^6}$	<p>The six-coefficient model is based on the OpenCV radial distortion model.</p> <p>Note The Camera Calibrator app does not support this model. To calibrate a camera using this model, see Camera Calibration and 3D Reconstruction in the OpenCV documentation.</p>

Tangential distortion coefficients — Tangential distortion coefficients

[0, 0] (default) | real-valued 2-element vector

Specify the tangential distortion coefficients as a real-valued 2-element vector. Tangential distortion occurs when the lens and the image plane are not parallel.

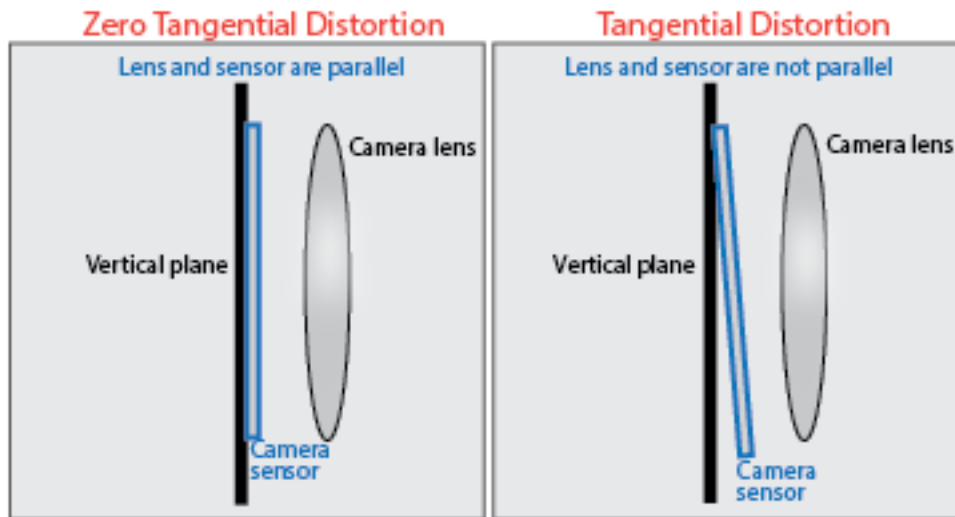

The camera sensor calculates the tangential distorted location of a point, (x_d, y_d) , using this formula:

$$\begin{aligned} x_d &= x + [2p_1xy + p_2 \times (r^2 + 2x^2)] \\ y_d &= y + [p_1 \times (r^2 + 2y^2) + 2p_2xy] \end{aligned}$$

where:

- x, y = undistorted pixel locations
- p_1, p_2 = tangential distortion coefficients of the lens
- $r^2 = x^2 + y^2$

The undistorted pixel locations appear in normalized image coordinates, with the origin at the optical center. The coordinates are expressed in world units.

This parameter is equivalent to the `TangentialDistortion` property of a `cameraIntrinsics` object.

Axis skew — Skew angle of camera axes

θ (default) | nonnegative real-valued scalar

Specify the skew angle of the camera axes as a nonnegative real-valued scalar. If the X-axis and Y-axis are exactly perpendicular, then the skew must be θ . Units are dimensionless.

This parameter is equivalent to the `Skew` property of a `cameraIntrinsics` object.

Ground Truth

Output depth — Output depth map

off (default) | on

Select this parameter to output a depth map at the **Depth** port.

Output semantic segmentation — Output semantic segmentation map of label IDs

off (default) | on

Select this parameter to output a semantic segmentation map of label IDs at the **Labels** port.

Output location (m) and orientation (rad) — Output location and orientation of sensor

off (default) | on

Select this parameter to output the location and orientation of the sensor at the **Location** and **Orientation** ports, respectively.

Tips

- To visualize the camera images that are output by the **Image** port, use a Video Viewer or To Video Display block.

To learn how to visualize the depth and semantic segmentation maps that are output by the **Depth** and **Labels** ports, see the “Depth and Semantic Segmentation Visualization Using Unreal Engine Simulation” example.

- To understand how to set tag of **Sim 3d Scene Cap** and how it the tag is related to the block, see “Place Cameras on Actors in the Unreal Editor” (Vehicle Dynamics Blockset).
- Because the Unreal Engine can take a long time to start between simulations, consider logging the signals that the sensors output. You can then use this data to develop perception algorithms in MATLAB. See “Mark Signals for Logging” (Simulink).

You can also save image data as a video by using a To Multimedia File block. For an example of this setup, see “Design Lane Marker Detector Using Unreal Engine Simulation Environment”.

Algorithms

Camera Model

The block uses the camera model proposed by Jean-Yves Bouquet [1]. The model includes:

- The pinhole camera model [2]
- Lens distortion [3]

The pinhole camera model does not account for lens distortion because an ideal pinhole camera does not have a lens. To accurately represent a real camera, the full camera model used by the block includes radial and tangential lens distortion.

For more details, see “What Is Camera Calibration?”

Sensor Position Transformation

At each simulation time step, the sensor block transforms the position (translation and rotation) of the sensor by using this equation:

$$T_{\text{Vehicle}} + T_{\text{Mount}} + T_{\text{Offset}} + T_{\text{Port}}$$

This equation contains these steps:

- 1 Take the world coordinate position of the vehicle to which the sensor is mounted. (T_{Vehicle})
- 2 Transform the sensor to the mounting position specified by the **Mounting location** parameter. (T_{Mount})

- 3 Transform the sensor to the position specified by the **Relative translation [X, Y, Z] (m)** and **Relative rotation [Roll, Pitch, Yaw] (deg)** parameters, if enabled. (T_{Offset})

To enable these parameters, select the **Specify offset** parameter

- 4 Transform the sensor from the offset position to the position specified by the **Translation** and **Rotation** ports. (T_{Port})

To enable these ports, select the **Input** parameters corresponding to the relative translation and rotation parameters.

Version History

Introduced in R2019b

References

- [1] Bouguet, J. Y. *Camera Calibration Toolbox for Matlab*. http://www.vision.caltech.edu/bouguetj/calib_doc
- [2] Zhang, Z. "A Flexible New Technique for Camera Calibration." *IEEE Transactions on Pattern Analysis and Machine Intelligence*. Vol. 22, No. 11, 2000, pp. 1330-1334.
- [3] Heikkila, J., and O. Silven. "A Four-step Camera Calibration Procedure with Implicit Image Correction." *IEEE International Conference on Computer Vision and Pattern Recognition*. 1997.

See Also

Blocks

Simulation 3D Scene Configuration | Simulation 3D Vehicle with Ground Following | Simulation 3D Fisheye Camera | Simulation 3D Lidar | Simulation 3D Probabilistic Radar | Simulation 3D Vision Detection Generator

Apps

Camera Calibrator

Objects

cameraIntrinsics

Topics

"Unreal Engine Simulation for Automated Driving"
"Coordinate Systems for Unreal Engine Simulation in Automated Driving Toolbox"
"Choose a Sensor for Unreal Engine Simulation"
"What Is Camera Calibration?"
"Depth Estimation From Stereo Video"
"Semantic Segmentation Using Deep Learning"

Simulation 3D Fisheye Camera

Fisheye camera sensor model in 3D simulation environment

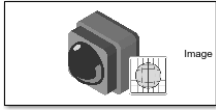

Libraries:

UAV Toolbox / Simulation 3D

Automated Driving Toolbox / Simulation 3D

Description

The Simulation 3D Fisheye Camera block provides an interface to a camera with a fisheye lens in a 3D simulation environment. This environment is rendered using the Unreal Engine from Epic Games. The sensor is based on the fisheye camera model proposed by Scaramuzza [1] on page 2-184. This model supports a field of view of up to 195 degrees. The block outputs an image with the specified camera distortion and size. You can also output the location and orientation of the camera in the world coordinate system of the scene.

If you set **Sample time** to -1, the block uses the sample time specified in the Simulation 3D Scene Configuration block. To use this sensor, you must include a Simulation 3D Scene Configuration block in your model.

Note The Simulation 3D Scene Configuration block must execute before the Simulation 3D Fisheye Camera block. That way, the Unreal Engine 3D visualization environment prepares the data before the Simulation 3D Fisheye Camera block receives it. To check the block execution order, right-click the blocks and select **Properties**. On the **General** tab, confirm these **Priority** settings:

- Simulation 3D Scene Configuration — 0
- Simulation 3D Fisheye Camera — 1

For more information about execution order, see “How Unreal Engine Simulation for Automated Driving Works”.

Ports

Input

Translation — Relative translation of sensor from mounting point (m)

[0 0 0] (default) | real-valued 1-by-3 vector of form [X Y Z]

Relative translation of the sensor from its mounting point on the vehicle, in meters, specified as a real-valued 1-by-3 vector of the form [X Y Z].

Dependencies

To enable this port, select the **Input** parameter next to the **Relative translation [X, Y, Z] (m)** parameter. When you select **Input**, the **Relative translation [X, Y, Z] (m)** parameter specifies the initial relative translation and the **Translation** port specifies the relative translation during simulation. For more details, see “Sensor Position Transformation” on page 2-184.

Data Types: `single` | `double` | `int8` | `int16` | `int32` | `int64` | `uint8` | `uint16` | `uint32` | `uint64`

Rotation — Relative rotation of sensor from mounting point (deg)

[0 0 0] (default) | real-valued 1-by-3 vector of form [Roll Pitch Yaw]

Relative rotation of the sensor from its mounting point on the vehicle, in degrees, specified as a real-valued 1-by-3 vector of the form [Roll Pitch Yaw].

Dependencies

To enable this port, select the **Input** parameter next to the **Relative rotation [Roll, Pitch, Yaw] (deg)** parameter. When you select **Input**, the **Relative translation [Roll, Pitch, Yaw] (deg)** parameter specifies the initial relative rotation and the **Rotation** port specifies the relative rotation during simulation. For more details, see “Sensor Position Transformation” on page 2-184.

Data Types: `single` | `double` | `int8` | `int16` | `int32` | `int64` | `uint8` | `uint16` | `uint32` | `uint64`

Output

Image — 3D output camera image

m-by-*n*-by-3 array of RGB triplet values

3D output camera image, returned as an *m*-by-*n*-by-3 array of RGB triplet values. *m* is the vertical resolution of the image, and *n* is the horizontal resolution of the image.

Data Types: `int8` | `uint8`

Location — Sensor location

real-valued 1-by-3 vector

Sensor location along the *X*-axis, *Y*-axis, and *Z*-axis of the scene. The **Location** values are in the world coordinates of the scene. In this coordinate system, the *Z*-axis points up from the ground. Units are in meters.

Dependencies

To enable this port, on the **Ground Truth** tab, select **Output location (m) and orientation (rad)**.

Data Types: `double`

Orientation — Sensor orientation

real-valued 1-by-3 vector

Roll, pitch, and yaw sensor orientation about the *X*-axis, *Y*-axis, and *Z*-axis of the scene. The **Orientation** values are in the world coordinates of the scene. These values are positive in the clockwise direction when looking in the positive directions of these axes. Units are in radians.

Dependencies

To enable this port, on the **Ground Truth** tab, select **Output location (m) and orientation (rad)**.

Data Types: `double`

Parameters

Mounting

Sensor identifier — Unique sensor identifier

1 (default) | positive integer

Specify the unique identifier of the sensor. In a multisensor system, the sensor identifier enables you to distinguish between sensors. When you add a new sensor block to your model, the **Sensor identifier** of that block is $N + 1$, where N is the highest **Sensor identifier** value among the existing sensor blocks in the model.

Example: 2

Parent name — Name of parent vehicle

Scene Origin (default) | vehicle name

Name of the parent to which the sensor is mounted, specified as `Scene Origin` or as the name of a vehicle in your model. The vehicle names that you can select correspond to the **Name** parameters of the simulation 3D vehicle blocks in your model. If you select `Scene Origin`, the block places a sensor at the scene origin.

Example: `SimulinkVehicle1`

Mounting location — Sensor mounting location



Origin (default) | Front bumper | Rear bumper | Right mirror | Left mirror | Rearview mirror | Hood center | Roof center

Sensor mounting location.

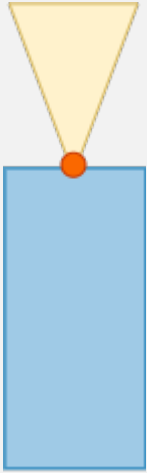
- When **Parent name** is `Scene Origin`, the block mounts the sensor to the origin of the scene. You can set the **Mounting location** to `Origin` only. During simulation, the sensor remains stationary.
- When **Parent name** is the name of a vehicle, the block mounts the sensor to one of the predefined mounting locations described in the table. During simulation, the sensor travels with the vehicle.

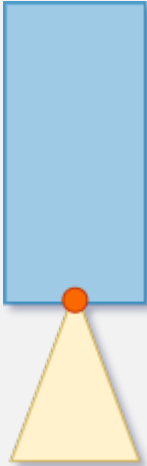
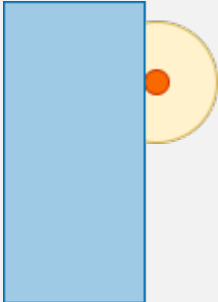
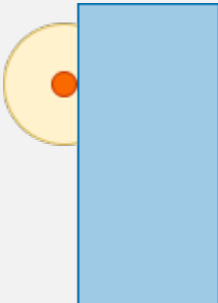
Vehicle Mounting Location	Description	Orientation Relative to Vehicle Origin [Roll, Pitch, Yaw] (deg)
Origin	<p>Forward-facing sensor mounted to the vehicle origin, which is on the ground and at the geometric center of the vehicle (see “Coordinate Systems for Unreal Engine Simulation in Automated Driving Toolbox”)</p> 	[0, 0, 0]
Front bumper	<p>Forward-facing sensor mounted to the front bumper</p> 	[0, 0, 0]

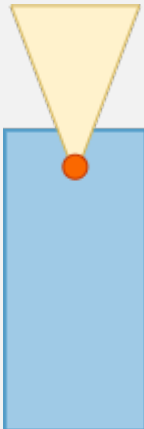
Vehicle Mounting Location	Description	Orientation Relative to Vehicle Origin [Roll, Pitch, Yaw] (deg)
Rear bumper	Backward-facing sensor mounted to the rear bumper 	[0, 0, 180]
Right mirror	Downward-facing sensor mounted to the right side-view mirror 	[0, -90, 0]
Left mirror	Downward-facing sensor mounted to the left side-view mirror 	[0, -90, 0]

Vehicle Mounting Location	Description	Orientation Relative to Vehicle Origin [Roll, Pitch, Yaw] (deg)
Rearview mirror	<p>Forward-facing sensor mounted to the rearview mirror, inside the vehicle</p> 	[0, 0, 0]
Hood center	<p>Forward-facing sensor mounted to the center of the hood</p> 	[0, 0, 0]
Roof center	<p>Forward-facing sensor mounted to the center of the roof</p> 	[0, 0, 0]

Roll, pitch, and yaw are clockwise-positive when looking in the positive direction of the X-axis, Y-axis, and Z-axis, respectively. When looking at a vehicle from above, the yaw angle (the orientation angle) is counterclockwise-positive because you are looking in the negative direction of the axis.

The X-Y-Z mounting location of the sensor relative to the vehicle depends on the vehicle type. To specify the vehicle type, use the **Type** parameter of the Simulation 3D Vehicle with Ground Following block to which you mount the sensor. To obtain the X-Y-Z mounting locations for a vehicle type, see the reference page for that vehicle.

To determine the location of the sensor in world coordinates, open the sensor block. Then, on the **Ground Truth** tab, select the **Output location (m) and orientation (rad)** parameter and inspect the data from the **Location** output port.

Specify offset — Specify offset from mounting location

off (default) | on

Select this parameter to specify an offset from the mounting location by using the **Relative translation [X, Y, Z] (m)** and **Relative rotation [Roll, Pitch, Yaw] (deg)** parameters.

Relative translation [X, Y, Z] (m) — Translation offset relative to mounting location

[0, 0, 0] (default) | real-valued 1-by-3 vector

Translation offset relative to the mounting location of the sensor, specified as a real-valued 1-by-3 vector of the form [X, Y, Z]. Units are in meters.

If you mount the sensor to a vehicle by setting **Parent name** to the name of that vehicle, then X, Y, and Z are in the vehicle coordinate system, where:

- The X-axis points forward from the vehicle.
- The Y-axis points to the left of the vehicle, as viewed when looking in the forward direction of the vehicle.
- The Z-axis points up.

The origin is the mounting location specified in the **Mounting location** parameter. This origin is different from the vehicle origin, which is the geometric center of the vehicle.

If you mount the sensor to the scene origin by setting **Parent name** to Scene Origin, then X, Y, and Z are in the world coordinates of the scene.

For more details about the vehicle and world coordinate systems, see “Coordinate Systems for Unreal Engine Simulation in Automated Driving Toolbox”.

Example: [0,0,0.01]

Adjust Relative Translation During Simulation

To adjust the relative translation of the sensor during simulation, enable the **Translation** input port by selecting the **Input** parameter next to the **Relative translation [X, Y, Z] (m)** parameter. When you enable the **Translation** port, the **Relative translation [X, Y, Z] (m)** parameter specifies the initial relative translation of the sensor and the **Translation** port specifies the relative translation of the sensor during simulation. For more details about the relative translation and rotation of this sensor, see “Sensor Position Transformation” on page 2-184.

Dependencies

To enable this parameter, select **Specify offset**.

Relative rotation [Roll, Pitch, Yaw] (deg) — Rotational offset relative to mounting location

[0, 0, 0] (default) | real-valued 1-by-3 vector

Rotational offset relative to the mounting location of the sensor, specified as a real-valued 1-by-3 vector of the form [Roll, Pitch, Yaw]. Roll, pitch, and yaw are the angles of rotation about the X-, Y-, and Z-axes, respectively. Units are in degrees.

If you mount the sensor to a vehicle by setting **Parent name** to the name of that vehicle, then X, Y, and Z are in the vehicle coordinate system, where:

- The X-axis points forward from the vehicle.
- The Y-axis points to the left of the vehicle, as viewed when looking in the forward direction of the vehicle.
- The Z-axis points up.
- Roll, pitch, and yaw are clockwise-positive when looking in the forward direction of the X-axis, Y-axis, and Z-axis, respectively. If you view a scene from a 2D top-down perspective, then the yaw angle (also called the orientation angle) is counterclockwise-positive because you are viewing the scene in the negative direction of the Z-axis.

The origin is the mounting location specified in the **Mounting location** parameter. This origin is different from the vehicle origin, which is the geometric center of the vehicle.

If you mount the sensor to the scene origin by setting **Parent name** to Scene Origin, then X, Y, and Z are in the world coordinates of the scene.

For more details about the vehicle and world coordinate systems, see “Coordinate Systems for Unreal Engine Simulation in Automated Driving Toolbox”.

Example: [0, 0, 10]

Adjust Relative Rotation During Simulation

To adjust the relative rotation of the sensor during simulation, enable the **Rotation** input port by selecting the **Input** parameter next to the **Relative rotation [Roll, Pitch, Yaw] (deg)** parameter. When you enable the **Rotation** port, the **Relative rotation [Roll, Pitch, Yaw] (deg)** parameter specifies the initial relative rotation of the sensor and the **Rotation** port specifies the relative rotation of the sensor during simulation. For more details about the relative translation and rotation of this sensor, see “Sensor Position Transformation” on page 2-184.

Dependencies

To enable this parameter, select **Specify offset**.

Sample time — Sample time

-1 (default) | positive scalar

Sample time of the block, in seconds, specified as a positive scalar. The 3D simulation environment frame rate is the inverse of the sample time.

If you set the sample time to -1, the block inherits its sample time from the Simulation 3D Scene Configuration block.

Parameters

These intrinsic camera parameters are equivalent to the properties of a `fisheyeIntrinsics` object. To obtain the intrinsic parameters for your camera, use the **Camera Calibrator** app.

For details about the fisheye camera calibration process, see “Using the Single Camera Calibrator App” and “Fisheye Calibration Basics”.

Distortion center (pixels) — Center of distortion

[640, 360] (default) | real-valued 1-by-2 vector

Center of distortion, specified as real-valued 2-element vector. Units are in pixels.

Image size (pixels) — Image size produced by camera

[720, 1280] (default) | real-valued 1-by-2 vector of positive integers

Image size produced by the camera, specified as a real-valued 1-by-2 vector of positive integers of the form $[mrows, ncols]$. Units are in pixels.

Mapping coefficients — Polynomial coefficients for projection function

[320, 0, 0, 0] (default) | real-valued 1-by-4 vector

Polynomial coefficients for the projection function described by Scaramuzza's Taylor model [1], specified as a real-valued 1-by-4 vector of the form $[a_0 \ a_2 \ a_3 \ a_4]$.

Example: [320, -0.001, 0, 0]

Stretch matrix — Transforms point from sensor plane to camera plane

[1, 0; 0, 1] (default) | real-valued 2-by-2 matrix

Transforms a point from the sensor plane to a pixel in the camera image plane. The misalignment occurs during the digitization process when the lens is not parallel to sensor.

Example: [0, 1; 0, 1]

Ground Truth

Output location (m) and orientation (rad) — Output location and orientation of sensor

off (default) | on

Select this parameter to output the location and orientation of the sensor at the **Location** and **Orientation** ports, respectively.

Tips

- To visualize the camera images that are output by the **Image** port, use a Video Viewer or To Video Display block.

- Because the Unreal Engine can take a long time to start up between simulations, consider logging the signals that the sensors output. You can then use this data to develop perception algorithms in MATLAB. See “Mark Signals for Logging” (Simulink).

You can also save image data as a video by using a To Multimedia File block. For an example of this setup, see “Design Lane Marker Detector Using Unreal Engine Simulation Environment”.

Algorithms

Sensor Position Transformation

At each simulation time step, the sensor block transforms the position (translation and rotation) of the sensor by using this equation:

$$T_{\text{Vehicle}} + T_{\text{Mount}} + T_{\text{Offset}} + T_{\text{Port}}$$

This equation contains these steps:

- 1 Take the world coordinate position of the vehicle to which the sensor is mounted. (T_{Vehicle})
- 2 Transform the sensor to the mounting position specified by the **Mounting location** parameter. (T_{Mount})
- 3 Transform the sensor to the position specified by the **Relative translation [X, Y, Z] (m)** and **Relative rotation [Roll, Pitch, Yaw] (deg)** parameters, if enabled. (T_{Offset})

To enable these parameters, select the **Specify offset** parameter

- 4 Transform the sensor from the offset position to the position specified by the **Translation** and **Rotation** ports. (T_{Port})

To enable these ports, select the **Input** parameters corresponding to the relative translation and rotation parameters.

Version History

Introduced in R2019b

References

- [1] Scaramuzza, D., A. Martinelli, and R. Siegwart. "A Toolbox for Easy Calibrating Omnidirectional Cameras." *Proceedings to IEEE International Conference on Intelligent Robots and Systems (IROS 2006)*. Beijing, China, October 7–15, 2006.

See Also

Blocks

Simulation 3D Scene Configuration | Simulation 3D Vehicle with Ground Following | Simulation 3D Camera | Simulation 3D Lidar | Simulation 3D Vision Detection Generator | Simulation 3D Probabilistic Radar

Apps

Camera Calibrator

Objects

fisheyeIntrinsics

Topics

“Unreal Engine Simulation for Automated Driving”

“Coordinate Systems for Unreal Engine Simulation in Automated Driving Toolbox”

“Choose a Sensor for Unreal Engine Simulation”

“Fisheye Calibration Basics”

Simulation 3D Lidar

Lidar sensor model in 3D simulation environment



Libraries:

UAV Toolbox / Simulation 3D

Automated Driving Toolbox / Simulation 3D

Description

The Simulation 3D Lidar block provides an interface to the lidar sensor in a 3D simulation environment. This environment is rendered using the Unreal Engine from Epic Games. The block returns a point cloud with the specified field of view and angular resolution. You can also output the distances from the sensor to object points and the reflectivity of surface materials. In addition, you can output the location and orientation of the sensor in the world coordinate system of the scene.

If you set **Sample time** to -1, the block uses the sample time specified in the Simulation 3D Scene Configuration block. To use this sensor, ensure that the Simulation 3D Scene Configuration block is in your model.

Note The Simulation 3D Scene Configuration block must execute before the Simulation 3D Lidar block. That way, the Unreal Engine 3D visualization environment prepares the data before the Simulation 3D Lidar block receives it. To check the block execution order, right-click the blocks and select **Properties**. On the **General** tab, confirm these **Priority** settings:

- Simulation 3D Scene Configuration — 0
- Simulation 3D Lidar — 1

For more information about execution order, see “How Unreal Engine Simulation for Automated Driving Works”.

Ports

Output

Point cloud — Point cloud data

m-by-*n*-by-3 array of positive real-valued [*x*, *y*, *z*] points

Point cloud data, returned as an *m*-by-*n*-by 3 array of positive, real-valued [*x*, *y*, *z*] points. *m* and *n* define the number of points in the point cloud, as shown in this equation:

$$m \times n = \frac{V_{FOV}}{V_{RES}} \times \frac{H_{FOV}}{H_{RES}}$$

where:

- V_{FOV} is the vertical field of view of the lidar, in degrees, as specified by the **Vertical field of view (deg)** parameter.

- V_{RES} is the vertical angular resolution of the lidar, in degrees, as specified by the **Vertical resolution (deg)** parameter.
- H_{FOV} is the horizontal field of view of the lidar, in degrees, as specified by the **Horizontal field of view (deg)** parameter.
- H_{RES} is the horizontal angular resolution of the lidar, in degrees, as specified by the **Horizontal resolution (deg)** parameter.

Each m -by- n entry in the array specifies the x , y , and z coordinates of a detected point in the sensor coordinate system. If the lidar does not detect a point at a given coordinate, then x , y , and z are returned as NaN.

You can create a point cloud from these returned points by using point cloud functions in a MATLAB Function block. For a list of point cloud processing functions, see “Lidar Processing”. For an example that uses these functions, see “Design Lidar SLAM Algorithm Using Unreal Engine Simulation Environment”.

Data Types: `single`

Distance — Distance to object points
 m -by- n positive real-valued matrix

Distance to object points measured by the lidar sensor, returned as an m -by- n positive real-valued matrix. Each m -by- n value in the matrix corresponds to an $[x, y, z]$ coordinate point returned by the **Point cloud** output port.

Dependencies

To enable this port, on the **Parameters** tab, select **Distance output**.

Data Types: `single`

Reflectivity — Reflectivity of surface materials
 m -by- n matrix of intensity values in range $[0, 1]$

Reflectivity of surface materials, returned as an m -by- n matrix of intensity values in the range $[0, 1]$, where m is the number of rows in the point cloud and n is the number of columns. Each point in the **Reflectivity** output corresponds to a point in the **Point cloud** output. The block returns points that are not part of a surface material as NaN.

To calculate reflectivity, the lidar sensor uses the Phong reflection model. This model describes surface reflectivity as a combination of diffuse reflections (scattered reflections, such as from rough surfaces) and specular reflections (mirror-like reflections, such as from smooth surfaces). For more details on this model, see the Phong reflection model page on Wikipedia.

Dependencies

To enable this port, select the **Reflectivity output** parameter.

Data Types: `single`

Labels — Label identifiers
 m -by- n array of label identifiers

Label identifier for each point in the point cloud, output as an m -by- n array. Each m -by- n value in the matrix corresponds to an $[x, y, z]$ coordinate point returned by the **Point cloud** output port.

The table shows the object IDs used in the default scenes that are selectable from the Simulation 3D Scene Configuration block. If you are using a custom scene, in the Unreal Editor, you can assign new object types to unused IDs. For more details, see “Apply Labels to Unreal Scene Elements for Semantic Segmentation and Object Detection”. If a scene contains an object that does not have an assigned ID, that object is assigned an ID of 0. The detection of lane markings is not supported.

ID	Type
0	None/default
1	Building
2	<i>Not used</i>
3	Other
4	Pedestrians
5	Pole
6	Lane Markings
7	Road
8	Sidewalk
9	Vegetation
10	Vehicle
11	<i>Not used</i>
12	Generic traffic sign
13	Stop sign
14	Yield sign
15	Speed limit sign
16	Weight limit sign
17 - 18	<i>Not used</i>
19	Left and right arrow warning sign
20	Left chevron warning sign
21	Right chevron warning sign
22	<i>Not used</i>
23	Right one-way sign
24	<i>Not used</i>
25	School bus only sign
26 - 38	<i>Not used</i>
39	Crosswalk sign
40	<i>Not used</i>
41	Traffic signal
42	Curve right warning sign
43	Curve left warning sign
44	Up right arrow warning sign

ID	Type
45-47	<i>Not used</i>
48	Railroad crossing sign
49	Street sign
50	Roundabout warning sign
51	Fire hydrant
52	Exit sign
53	Bike lane sign
54-56	<i>Not used</i>
57	Sky
58	Curb
59	Flyover ramp
60	Road guard rail
61	Bicyclist
62-66	<i>Not used</i>
67	Deer
68-70	<i>Not used</i>
71	Barricade
72	Motorcycle
73-255	<i>Not used</i>

Dependencies

To enable this port, on the **Ground Truth** tab, select **Output semantic segmentation**.

Data Types: `uint8`

Location — Sensor location

real-valued 1-by-3 vector

Sensor location along the X-axis, Y-axis, and Z-axis of the scene. The **Location** values are in the world coordinates of the scene. In this coordinate system, the Z-axis points up from the ground. Units are in meters.

Dependencies

To enable this port, on the **Ground Truth** tab, select **Output location (m) and orientation (rad)**.

Data Types: `double`

Orientation — Sensor orientation

real-valued 1-by-3 vector

Roll, pitch, and yaw sensor orientation about the X-axis, Y-axis, and Z-axis of the scene. The **Orientation** values are in the world coordinates of the scene. These values are positive in the clockwise direction when looking in the positive directions of these axes. Units are in radians.

Dependencies

To enable this port, on the **Ground Truth** tab, select **Output location (m) and orientation (rad)**.

Data Types: double

Parameters

Mounting

Sensor identifier — Unique sensor identifier

1 (default) | positive integer

Specify the unique identifier of the sensor. In a multisensor system, the sensor identifier enables you to distinguish between sensors. When you add a new sensor block to your model, the **Sensor identifier** of that block is $N + 1$, where N is the highest **Sensor identifier** value among the existing sensor blocks in the model.

Example: 2

Parent name — Name of parent vehicle

Scene Origin (default) | vehicle name

Name of the parent to which the sensor is mounted, specified as `Scene Origin` or as the name of a vehicle in your model. The vehicle names that you can select correspond to the **Name** parameters of the simulation 3D vehicle blocks in your model. If you select `Scene Origin`, the block places a sensor at the scene origin.

Example: `SimulinkVehicle1`

Mounting location — Sensor mounting location



Origin (default) | Front bumper | Rear bumper | Right mirror | Left mirror | Rearview mirror | Hood center | Roof center

Sensor mounting location.

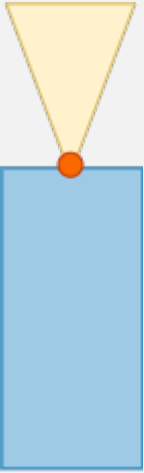
- When **Parent name** is `Scene Origin`, the block mounts the sensor to the origin of the scene. You can set the **Mounting location** to `Origin` only. During simulation, the sensor remains stationary.
- When **Parent name** is the name of a vehicle, the block mounts the sensor to one of the predefined mounting locations described in the table. During simulation, the sensor travels with the vehicle.

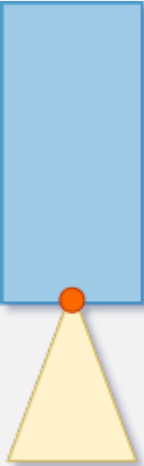
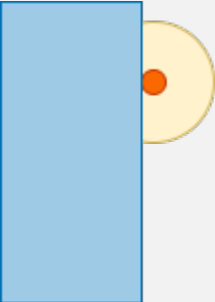
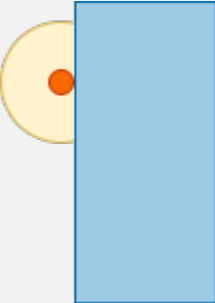
Vehicle Mounting Location	Description	Orientation Relative to Vehicle Origin [Roll, Pitch, Yaw] (deg)
Origin	<p>Forward-facing sensor mounted to the vehicle origin, which is on the ground and at the geometric center of the vehicle (see “Coordinate Systems for Unreal Engine Simulation in Automated Driving Toolbox”)</p> 	[0, 0, 0]
Front bumper	<p>Forward-facing sensor mounted to the front bumper</p> 	[0, 0, 0]

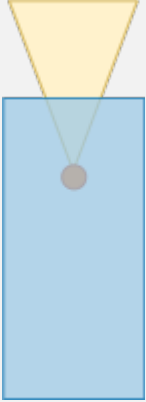
Vehicle Mounting Location	Description	Orientation Relative to Vehicle Origin [Roll, Pitch, Yaw] (deg)
Rear bumper	Backward-facing sensor mounted to the rear bumper 	[0, 0, 180]
Right mirror	Downward-facing sensor mounted to the right side-view mirror 	[0, -90, 0]
Left mirror	Downward-facing sensor mounted to the left side-view mirror 	[0, -90, 0]

Vehicle Mounting Location	Description	Orientation Relative to Vehicle Origin [Roll, Pitch, Yaw] (deg)
Rearview mirror	Forward-facing sensor mounted to the rearview mirror, inside the vehicle 	[0, 0, 0]
Hood center	Forward-facing sensor mounted to the center of the hood 	[0, 0, 0]
Roof center	Forward-facing sensor mounted to the center of the roof 	[0, 0, 0]

Roll, pitch, and yaw are clockwise-positive when looking in the positive direction of the X-axis, Y-axis, and Z-axis, respectively. When looking at a vehicle from above, the yaw angle (the orientation angle) is counterclockwise-positive because you are looking in the negative direction of the axis.

The X-Y-Z mounting location of the sensor relative to the vehicle depends on the vehicle type. To specify the vehicle type, use the **Type** parameter of the Simulation 3D Vehicle with Ground Following block to which you mount the sensor. To obtain the X-Y-Z mounting locations for a vehicle type, see the reference page for that vehicle.

To determine the location of the sensor in world coordinates, open the sensor block. Then, on the **Ground Truth** tab, select the **Output location (m) and orientation (rad)** parameter and inspect the data from the **Location** output port.

Specify offset — Specify offset from mounting location

off (default) | on

Select this parameter to specify an offset from the mounting location by using the **Relative translation [X, Y, Z] (m)** and **Relative rotation [Roll, Pitch, Yaw] (deg)** parameters.

Relative translation [X, Y, Z] (m) — Translation offset relative to mounting location

[0, 0, 0] (default) | real-valued 1-by-3 vector

Translation offset relative to the mounting location of the sensor, specified as a real-valued 1-by-3 vector of the form [X, Y, Z]. Units are in meters.

If you mount the sensor to a vehicle by setting **Parent name** to the name of that vehicle, then X, Y, and Z are in the vehicle coordinate system, where:

- The X-axis points forward from the vehicle.
- The Y-axis points to the left of the vehicle, as viewed when looking in the forward direction of the vehicle.
- The Z-axis points up.

The origin is the mounting location specified in the **Mounting location** parameter. This origin is different from the vehicle origin, which is the geometric center of the vehicle.

If you mount the sensor to the scene origin by setting **Parent name** to Scene Origin, then X, Y, and Z are in the world coordinates of the scene.

For more details about the vehicle and world coordinate systems, see “Coordinate Systems for Unreal Engine Simulation in Automated Driving Toolbox”.

Example: [0, 0, 0.01]

Dependencies

To enable this parameter, select **Specify offset**.

Relative rotation [Roll, Pitch, Yaw] (deg) — Rotational offset relative to mounting location

[0, 0, 0] (default) | real-valued 1-by-3 vector

Rotational offset relative to the mounting location of the sensor, specified as a real-valued 1-by-3 vector of the form $[Roll, Pitch, Yaw]$. Roll, pitch, and yaw are the angles of rotation about the X-, Y-, and Z-axes, respectively. Units are in degrees.

If you mount the sensor to a vehicle by setting **Parent name** to the name of that vehicle, then X, Y, and Z are in the vehicle coordinate system, where:

- The X-axis points forward from the vehicle.
- The Y-axis points to the left of the vehicle, as viewed when looking in the forward direction of the vehicle.
- The Z-axis points up.
- Roll, pitch, and yaw are clockwise-positive when looking in the forward direction of the X-axis, Y-axis, and Z-axis, respectively. If you view a scene from a 2D top-down perspective, then the yaw angle (also called the orientation angle) is counterclockwise-positive because you are viewing the scene in the negative direction of the Z-axis.

The origin is the mounting location specified in the **Mounting location** parameter. This origin is different from the vehicle origin, which is the geometric center of the vehicle.

If you mount the sensor to the scene origin by setting **Parent name** to Scene Origin, then X, Y, and Z are in the world coordinates of the scene.

For more details about the vehicle and world coordinate systems, see “Coordinate Systems for Unreal Engine Simulation in Automated Driving Toolbox”.

Example: $[0, 0, 10]$

Dependencies

To enable this parameter, select **Specify offset**.

Sample time — Sample time

-1 (default) | positive scalar

Sample time of the block, in seconds, specified as a positive scalar. The 3D simulation environment frame rate is the inverse of the sample time.

If you set the sample time to -1, the block inherits its sample time from the Simulation 3D Scene Configuration block.

Parameters

Detection range (m) — Maximum distance measured by lidar sensor

120 (default) | positive scalar

Maximum distance measured by the lidar sensor, specified as a positive scalar. Points outside this range are ignored. Units are in meters.

Range resolution (m) — Resolution of lidar sensor range

0.002 (default) | positive real scalar

Resolution of the lidar sensor range, in meters, specified as a positive real scalar. The range resolution is also known as the quantization factor. The minimal value of this factor is $D_{\text{range}} / 2^{24}$,

where D_{range} is the maximum distance measured by the lidar sensor, as specified in the **Detection range (m)** parameter.

Vertical field of view (deg) — Vertical field of view

40 (default) | positive scalar

Vertical field of view of the lidar sensor, specified as a positive scalar. Units are in degrees.

Vertical resolution (deg) — Vertical angular resolution

1.25 (default) | positive scalar

Vertical angular resolution of the lidar sensor, specified as a positive scalar. Units are in degrees.

Horizontal field of view (deg) — Horizontal field of view

360 (default) | positive scalar

Horizontal field of view of the lidar sensor, specified as a positive scalar. Units are in degrees.

Horizontal resolution (deg) — Horizontal angular (azimuth) resolution

0.16 (default) | positive scalar

Horizontal angular (azimuth) resolution of the lidar sensor, specified as a positive scalar. Units are in degrees.

Distance output — Output distance to measured object points

off (default) | on

Select this parameter to output the distance to measured object points at the **Distance** port.

Reflectivity output — Output reflectivity of surface materials

off (default) | on

Select this parameter to output the reflectivity of surface materials at the **Reflectivity** port.

Ground Truth

Output location (m) and orientation (rad) — Output location and orientation of sensor

off (default) | on

Select this parameter to output the location and orientation of the sensor at the **Location** and **Orientation** ports, respectively.

Tips

- To visualize point clouds that are output by the **Point cloud** port, you can either:
 - Use a `pcplayer` object in a MATLAB Function block. For an example of this visualization setup, see “Design Lidar SLAM Algorithm Using Unreal Engine Simulation Environment”.

- Use the **Bird's-Eye Scope**. For more details, see “Visualize Sensor Data from Unreal Engine Simulation Environment”.
- The Unreal Engine can take a long time to start up between simulations, consider logging the signals that the sensors output. You can then use this data to develop perception algorithms in MATLAB. See “Mark Signals for Logging” (Simulink).

Version History

Introduced in R2019b

See Also

Apps

Bird's-Eye Scope

Objects

pointCloud | pcplayer

Topics

“Unreal Engine Simulation for Automated Driving”

“Coordinate Systems for Unreal Engine Simulation in Automated Driving Toolbox”

“Choose a Sensor for Unreal Engine Simulation”

“Lidar Processing”

Simulation 3D Probabilistic Radar

Probabilistic radar sensor model in 3D simulation environment

Description

The Simulation 3D Probabilistic Radar block provides an interface to the probabilistic radar sensor in a 3D simulation environment. This environment is rendered using the Unreal Engine from Epic Games. You can specify the radar model and accuracy, bias, and detection parameters. The block uses the sample time to capture the radar detections and outputs a list of object detection reports. To configure the probabilistic radar signatures of actors in the 3D environment across all radars in your model, use a Simulation 3D Probabilistic Radar Configuration block.

If you set **Sample time** to -1, the block uses the sample time specified in the Simulation 3D Scene Configuration block. To use this sensor, you must include a Simulation 3D Scene Configuration block in your model.

Note The Simulation 3D Scene Configuration block must execute before the Simulation 3D Probabilistic Radar block. That way, the Unreal Engine 3D visualization environment prepares the data before the Simulation 3D Probabilistic Radar block receives it. To check the block execution order, right-click the blocks and select **Properties**. On the **General** tab, confirm these **Priority** settings:

- Simulation 3D Scene Configuration — 0
- Simulation 3D Probabilistic Radar — 1

For more information about execution order, see “How Unreal Engine Simulation for Automated Driving Works”.

Ports

Output

Detections — Object detections

Simulink bus containing MATLAB structure

Object detections, returned as a Simulink bus containing a MATLAB structure. For more details about buses, “Create Nonvirtual Buses” (Simulink). The structure has this form.

Field	Description	Type
NumDetections	Number of detections	integer
IsValidTime	False when updates are requested at times that are between block invocation intervals	Boolean

Field	Description	Type
Detections	Object detections	Array of object detection structures of length set by the Maximum reported parameter. Only NumDetections of these detections are actual detections.

Each object detection structure contains these properties.

Property	Definition
Time	Measurement time
Measurement	Object measurements
MeasurementNoise	Measurement noise covariance matrix
SensorIndex	Unique ID of the sensor
ObjectClassID	Object classification
MeasurementParameters	Parameters used by initialization functions of nonlinear Kalman tracking filters
ObjectAttributes	Additional information passed to tracker

- For Cartesian coordinates, **Measurement** and **MeasurementNoise** are reported in the coordinate system specified by the **Coordinate system** parameter.
- For spherical coordinates, **Measurement** and **MeasurementNoise** are reported in the spherical coordinate system based on the sensor Cartesian coordinate system. **MeasurementParameters** is reported in sensor Cartesian coordinates.

Measurement and MeasurementNoise

Coordinate System Used to Report Detections	Measurement and MeasurementNoise Coordinates																
'Ego Cartesian' 'Sensor Cartesian'	This table shows the coordinate dependence when you enable or disable range rate measurements using the Enable range rate measurements parameter. <table border="1" data-bbox="863 529 1474 695"> <thead> <tr> <th data-bbox="863 529 1170 598">Range rate measurements</th> <th data-bbox="1177 529 1474 598">Coordinates</th> </tr> </thead> <tbody> <tr> <td data-bbox="863 606 1170 646">Enabled</td> <td data-bbox="1177 606 1474 646">[x;y;z;vx;vy;vz]</td> </tr> <tr> <td data-bbox="863 655 1170 695">Disabled</td> <td data-bbox="1177 655 1474 695">[x;y;z]</td> </tr> </tbody> </table>		Range rate measurements	Coordinates	Enabled	[x;y;z;vx;vy;vz]	Disabled	[x;y;z]									
Range rate measurements	Coordinates																
Enabled	[x;y;z;vx;vy;vz]																
Disabled	[x;y;z]																
'Sensor spherical'	This table shows the coordinate dependence when you enable or disable the range rate and elevation angle measurements, by using the Enable range rate measurements and Enable elevation angle measurements parameters, respectively. <table border="1" data-bbox="863 919 1474 1268"> <thead> <tr> <th data-bbox="863 919 1065 1058">Range rate measurements</th> <th data-bbox="1071 919 1263 1058">Elevation angle measurements</th> <th data-bbox="1269 919 1474 1058">Coordinates</th> </tr> </thead> <tbody> <tr> <td data-bbox="863 1066 1065 1129">Enabled</td> <td data-bbox="1071 1066 1263 1129">Enabled</td> <td data-bbox="1269 1066 1474 1129">[az;el;rng;rr]</td> </tr> <tr> <td data-bbox="863 1138 1065 1180">Enabled</td> <td data-bbox="1071 1138 1263 1180">Disabled</td> <td data-bbox="1269 1138 1474 1180">[az;rng;rr]</td> </tr> <tr> <td data-bbox="863 1188 1065 1230">Disabled</td> <td data-bbox="1071 1188 1263 1230">Enabled</td> <td data-bbox="1269 1188 1474 1230">[az;el;rng]</td> </tr> <tr> <td data-bbox="863 1239 1065 1268">Disabled</td> <td data-bbox="1071 1239 1263 1268">Disabled</td> <td data-bbox="1269 1239 1474 1268">[az;rng]</td> </tr> </tbody> </table>		Range rate measurements	Elevation angle measurements	Coordinates	Enabled	Enabled	[az;el;rng;rr]	Enabled	Disabled	[az;rng;rr]	Disabled	Enabled	[az;el;rng]	Disabled	Disabled	[az;rng]
Range rate measurements	Elevation angle measurements	Coordinates															
Enabled	Enabled	[az;el;rng;rr]															
Enabled	Disabled	[az;rng;rr]															
Disabled	Enabled	[az;el;rng]															
Disabled	Disabled	[az;rng]															

Measurement Parameters

Parameter	Definition
Frame	Enumerated type that indicates the frame used to report measurements. When Frame is set to 'rectangular', detections are reported in Cartesian coordinates. When Frame is set to 'spherical', detections are reported in spherical coordinates.
OriginPosition	3D vector offset of the sensor origin from the ego vehicle origin. The vector is derived from the location and height of the sensor, as specified by the Mounting location parameter and the Z value of the Relative translation [X, Y, Z] (m) parameter, respectively.
Orientation	Orientation of the radar sensor coordinate system with respect to the ego vehicle coordinate system. The orientation is derived from the roll, pitch, and yaw values specified in the Relative rotation [Roll, Pitch, Yaw] (deg) parameter.
HasVelocity	Indicates whether measurements contain velocity or range rate components.
HasElevation	Indicates whether measurements contain elevation components.

The `ObjectAttributes` property of each detection is a structure with these fields.

Field	Definition
TargetIndex	Identifier of the actor, <code>ActorID</code> , that generated the detection. For false alarms, this value is negative.
SNR	Signal-to-noise ratio of the detection. Units are in decibels.

The `ObjectClassID` property of each detection has a value that corresponds to an object ID. The table shows the object IDs used in the default scenes that are selectable from the Simulation 3D Scene Configuration block. If you are using a custom scene, in the Unreal Editor, you can assign new object types to unused IDs. For more details, see “Apply Labels to Unreal Scene Elements for Semantic Segmentation and Object Detection”. If a scene contains an object that does not have an assigned ID, that object is assigned an ID of 0. The detection of lane markings is not supported.

ID	Type
0	None/default
1	Building
2	<i>Not used</i>
3	Other
4	Pedestrians

ID	Type
5	Pole
6	Lane Markings
7	Road
8	Sidewalk
9	Vegetation
10	Vehicle
11	<i>Not used</i>
12	Generic traffic sign
13	Stop sign
14	Yield sign
15	Speed limit sign
16	Weight limit sign
17 - 18	<i>Not used</i>
19	Left and right arrow warning sign
20	Left chevron warning sign
21	Right chevron warning sign
22	<i>Not used</i>
23	Right one-way sign
24	<i>Not used</i>
25	School bus only sign
26 - 38	<i>Not used</i>
39	Crosswalk sign
40	<i>Not used</i>
41	Traffic signal
42	Curve right warning sign
43	Curve left warning sign
44	Up right arrow warning sign
45 - 47	<i>Not used</i>
48	Railroad crossing sign
49	Street sign
50	Roundabout warning sign
51	Fire hydrant
52	Exit sign
53	Bike lane sign
54 - 56	<i>Not used</i>
57	Sky

ID	Type
58	Curb
59	Flyover ramp
60	Road guard rail
61	Bicyclist
62-66	<i>Not used</i>
67	Deer
68-70	<i>Not used</i>
71	Barricade
72	Motorcycle
73-255	<i>Not used</i>

Parameters

Mounting

Sensor identifier — Unique sensor identifier

1 (default) | positive integer

Specify the unique identifier of the sensor. In a multisensor system, the sensor identifier enables you to distinguish between sensors. When you add a new sensor block to your model, the **Sensor identifier** of that block is $N + 1$, where N is the highest **Sensor identifier** value among the existing sensor blocks in the model.

Example: 2

Parent name — Name of parent vehicle

Scene Origin (default) | vehicle name

Name of the parent to which the sensor is mounted, specified as `Scene Origin` or as the name of a vehicle in your model. The vehicle names that you can select correspond to the **Name** parameters of the simulation 3D vehicle blocks in your model. If you select `Scene Origin`, the block places a sensor at the scene origin.

Example: `SimulinkVehicle1`

Mounting location — Sensor mounting location



Origin (default) | Front bumper | Rear bumper | Right mirror | Left mirror | Rearview mirror | Hood center | Roof center

Sensor mounting location.

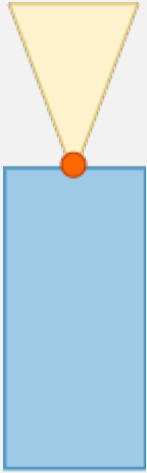
- When **Parent name** is `Scene Origin`, the block mounts the sensor to the origin of the scene. You can set the **Mounting location** to `Origin` only. During simulation, the sensor remains stationary.
- When **Parent name** is the name of a vehicle, the block mounts the sensor to one of the predefined mounting locations described in the table. During simulation, the sensor travels with the vehicle.

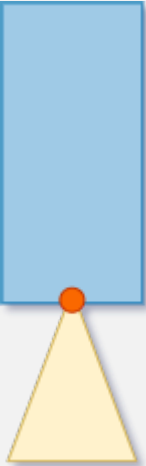
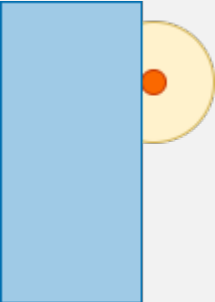
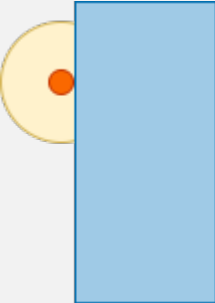
Vehicle Mounting Location	Description	Orientation Relative to Vehicle Origin [Roll, Pitch, Yaw] (deg)
Origin	<p>Forward-facing sensor mounted to the vehicle origin, which is on the ground and at the geometric center of the vehicle (see “Coordinate Systems for Unreal Engine Simulation in Automated Driving Toolbox”)</p> 	[0, 0, 0]
Front bumper	<p>Forward-facing sensor mounted to the front bumper</p> 	[0, 0, 0]

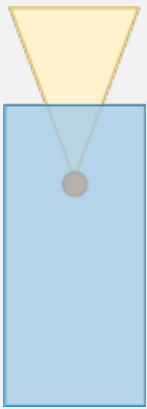
Vehicle Mounting Location	Description	Orientation Relative to Vehicle Origin [Roll, Pitch, Yaw] (deg)
Rear bumper	Backward-facing sensor mounted to the rear bumper 	[0, 0, 180]
Right mirror	Downward-facing sensor mounted to the right side-view mirror 	[0, -90, 0]
Left mirror	Downward-facing sensor mounted to the left side-view mirror 	[0, -90, 0]

Vehicle Mounting Location	Description	Orientation Relative to Vehicle Origin [Roll, Pitch, Yaw] (deg)
Rearview mirror	<p>Forward-facing sensor mounted to the rearview mirror, inside the vehicle</p> 	[0, 0, 0]
Hood center	<p>Forward-facing sensor mounted to the center of the hood</p> 	[0, 0, 0]
Roof center	<p>Forward-facing sensor mounted to the center of the roof</p> 	[0, 0, 0]

Roll, pitch, and yaw are clockwise-positive when looking in the positive direction of the X-axis, Y-axis, and Z-axis, respectively. When looking at a vehicle from above, the yaw angle (the orientation angle) is counterclockwise-positive because you are looking in the negative direction of the axis.

The X-Y-Z mounting location of the sensor relative to the vehicle depends on the vehicle type. To specify the vehicle type, use the **Type** parameter of the Simulation 3D Vehicle with Ground Following block to which you mount the sensor. To obtain the X-Y-Z mounting locations for a vehicle type, see the reference page for that vehicle.

To determine the location of the sensor in world coordinates, open the sensor block. Then, on the **Ground Truth** tab, select the **Output location (m) and orientation (rad)** parameter and inspect the data from the **Location** output port.

Specify offset — Specify offset from mounting location

off (default) | on

Select this parameter to specify an offset from the mounting location by using the **Relative translation [X, Y, Z] (m)** and **Relative rotation [Roll, Pitch, Yaw] (deg)** parameters.

Relative translation [X, Y, Z] (m) — Translation offset relative to mounting location

[0, 0, 0] (default) | real-valued 1-by-3 vector

Translation offset relative to the mounting location of the sensor, specified as a real-valued 1-by-3 vector of the form [X, Y, Z]. Units are in meters.

If you mount the sensor to a vehicle by setting **Parent name** to the name of that vehicle, then X, Y, and Z are in the vehicle coordinate system, where:

- The X-axis points forward from the vehicle.
- The Y-axis points to the left of the vehicle, as viewed when looking in the forward direction of the vehicle.
- The Z-axis points up.

The origin is the mounting location specified in the **Mounting location** parameter. This origin is different from the vehicle origin, which is the geometric center of the vehicle.

If you mount the sensor to the scene origin by setting **Parent name** to Scene Origin, then X, Y, and Z are in the world coordinates of the scene.

For more details about the vehicle and world coordinate systems, see “Coordinate Systems for Unreal Engine Simulation in Automated Driving Toolbox”.

Example: [0, 0, 0.01]

Dependencies

To enable this parameter, select **Specify offset**.

Relative rotation [Roll, Pitch, Yaw] (deg) — Rotational offset relative to mounting location

[0, 0, 0] (default) | real-valued 1-by-3 vector

Rotational offset relative to the mounting location of the sensor, specified as a real-valued 1-by-3 vector of the form $[Roll, Pitch, Yaw]$. Roll, pitch, and yaw are the angles of rotation about the X-, Y-, and Z-axes, respectively. Units are in degrees.

If you mount the sensor to a vehicle by setting **Parent name** to the name of that vehicle, then X, Y, and Z are in the vehicle coordinate system, where:

- The X-axis points forward from the vehicle.
- The Y-axis points to the left of the vehicle, as viewed when looking in the forward direction of the vehicle.
- The Z-axis points up.
- Roll, pitch, and yaw are clockwise-positive when looking in the forward direction of the X-axis, Y-axis, and Z-axis, respectively. If you view a scene from a 2D top-down perspective, then the yaw angle (also called the orientation angle) is counterclockwise-positive because you are viewing the scene in the negative direction of the Z-axis.

The origin is the mounting location specified in the **Mounting location** parameter. This origin is different from the vehicle origin, which is the geometric center of the vehicle.

If you mount the sensor to the scene origin by setting **Parent name** to `Scene Origin`, then X, Y, and Z are in the world coordinates of the scene.

For more details about the vehicle and world coordinate systems, see “Coordinate Systems for Unreal Engine Simulation in Automated Driving Toolbox”.

Example: $[0, 0, 10]$

Dependencies

To enable this parameter, select **Specify offset**.

Sample time — Sample time

-1 (default) | positive scalar

Sample time of the block, in seconds, specified as a positive scalar. The 3D simulation environment frame rate is the inverse of the sample time.

If you set the sample time to -1, the block inherits its sample time from the Simulation 3D Scene Configuration block.

Parameters

Accuracy Settings

Azimuthal resolution of radar (deg) — Azimuth resolution of radar

4 (default) | positive real scalar

Azimuth resolution of the radar, specified as a positive real scalar. The azimuth resolution defines the minimum separation in azimuth angle at which the radar can distinguish between two targets. The azimuth resolution is typically the 3dB-downpoint in azimuth angle beamwidth of the radar. Units are in degrees.

Example: 6.5

Elevation resolution of radar (deg) — Elevation resolution of radar

10 (default) | positive real scalar

Elevation resolution of the radar, specified as a positive real scalar. The elevation resolution defines the minimum separation in elevation angle at which the radar can distinguish between two targets. The elevation resolution is typically the 3dB-downpoint in elevation angle beamwidth of the radar. Units are in degrees.

Example: 3.5

Dependencies

To enable this parameter, on the **Parameters** tab, in the **Radar model** section, select **Enable elevation angle measurements**.

Range resolution of radar (m) — Range resolution of radar

2.5 (default) | positive real scalar

Range resolution of the radar, specified as a positive real scalar. The range resolution defines the minimum separation in range at which the radar can distinguish between two targets. Units are in meters.

Example: 5.0

Range rate resolution of radar (m/s) — Range rate resolution of the radar

0.5 (default) | positive real scalar

Range rate resolution of the radar, specified as a positive real scalar. The range rate resolution defines the minimum separation in range rate at which the radar can distinguish between two targets. Units are in meters per second.

Example: 0.75

Dependencies

To enable this parameter, on the **Parameters** tab, in the **Radar model** section, select **Enable range rate measurements**.

Bias Settings**Fractional azimuthal bias component** — Azimuth bias fraction

0.1 (default) | nonnegative real scalar

Azimuth bias fraction of the radar, specified as a nonnegative real scalar. The azimuth bias is expressed as a fraction of the azimuth resolution specified in the **Azimuthal resolution of radar (deg)** parameter. Units are dimensionless.

Example: 0.3

Fractional elevation bias component — Elevation bias fraction

0.1 (default) | nonnegative real scalar

Elevation bias fraction of the radar, specified as a nonnegative real scalar. The elevation bias is expressed as a fraction of the elevation resolution specified in the **Elevation resolution of radar (deg)** parameter. Units are dimensionless.

Example: 0.2

Dependencies

To enable this parameter, on the **Parameters** tab, in the **Radar model** section, select **Enable elevation angle measurements**.

Fractional range bias component — Range bias fraction

0.05 (default) | nonnegative real scalar

Range bias fraction of the radar, specified as a nonnegative real scalar. Range bias is expressed as a fraction of the range resolution specified in the **Range resolution of radar (m)** parameter. Units are dimensionless.

Example: 0.15

Fractional range rate bias component — Range rate bias fraction

0.05 (default) | nonnegative real scalar

Range rate bias fraction of the radar, specified as a nonnegative real scalar. Range rate bias is expressed as a fraction of the range rate resolution specified in the **Range rate resolution of radar (m/s)** parameter. Units are dimensionless.

Example: 0.2

Dependencies

To enable this parameter, on the **Parameters** tab, in the **Radar model** section, select **Enable range rate measurements**.

Detector Settings

Field of view (deg) — Field of view

[20, 5] (default) | positive real-valued 1-by-2 vector

Field of view of the radar, specified as a positive real-valued 1-by-2 vector of the form [*azfov*, *elfov*]. *azfov* is the azimuth angle field of view. *elfov* is the elevation angle field of view. The field of view defines the angular extent spanned by the sensor. Each component must lie in the interval (0,180]. Targets outside of the field of view of the radar are not detected. Units are in degrees.

Example: [14 7]

Detection ranges (m) — Detection range

[1, 150] (default) | positive real-valued 1-by-2 vector

Detection range, in meters, at which the radar can detect a target.

- To set only a maximum detection range, specify this parameter as a positive real scalar. By default, the minimum detection range is 0.

- To set both a minimum and maximum detection range, specify this parameter as a positive real-valued 1-by-2 vector of the form $[\min, \max]$.

Example: 250

Range rates (m/s) — Minimum and maximum detection range rates

$[-100, 100]$ (default) | real-valued 1-by-2 vector

Minimum and maximum detection range rates, specified as a real-valued 1-by-2 vector. The radar can detect targets only within this range rate interval. Units are in meters per second.

Example: $[-200 \ 200]$

Dependencies

To enable this parameter, on the **Parameters** tab, in the **Radar model** section, select **Enable range rate measurements**.

Detection probability — Probability that radar detects a target

0.9 (default) | real scalar in the range (0, 1]

Probability that the radar detects a target, specified as a real scalar in the range (0, 1]. This quantity defines the probability of detecting a target that has a radar cross section specified by the **Reference radar cross section (dBsm)** parameter, at the reference detection range specified by the **Detection ranges (m)** parameter.

Example: 0.95

False alarm rate — False alarm rate

$1e-6$ (default) | positive real scalar in range $[10^{-7}, 10^{-3}]$

False alarm rate within a radar resolution cell, specified as a positive real scalar in the range $[10^{-7}, 10^{-3}]$. Units are dimensionless.

Example: $1e-5$

Detection probability range (m): — Reference range for given probability of detection

100 (default) | positive real scalar

Reference range for a given probability of detection, specified as a positive real scalar. The reference range is the range at which the radar detects targets that have a radar cross section specified by **Reference radar cross section (dBsm)**, given a detection probability specified by **Detection probability**. Units are in meters.

Example: 150

Reference radar cross section (dBsm) — Reference radar cross section for given probability of detection

0 (default) | real scalar

Reference radar cross section (RCS) for a given probability of detection, specified as a real scalar. A radar with the detection probability specified by **Detection probability** detects targets at this reference RCS value. Units are in decibels per square meter.

Example: 2.0

Radar Model

Enable elevation angle measurements — Enable radar to measure elevation

on (default) | off

Select this parameter to model a radar that can measure target elevation angles. This parameter enables the **Elevation resolution of radar (deg)** and **Fractional elevation bias component** parameters.

Enable range rate measurements — Enable radar to measure range rate

on (default) | off

Select this parameter to model a radar that can measure target range rates. This parameter enables the **Range rate resolution of radar (m/s)**, **Fractional range bias component**, and **Range rates (m/s)** parameters.

Enable measurement noise — Enable adding noise to radar sensor measurements

on (default) | off

Select this parameter to add noise to radar sensor measurements. Otherwise, the measurements are noise-free. The `MeasurementNoise` property of each detection is always computed and is not affected by the value you specify for the **Enable measurement noise** parameter. By not selecting this parameter, you can pass the sensor ground truth measurements into a Multi-Object Tracker block.

Enable false detections — Enable reporting false alarm radar detections

on (default) | off

Select this parameter to enable reporting false alarm radar measurements. Otherwise, only actual detections are reported.

Random number generator method — Method to set random number generator seed

Repeatable (default) | Specify seed | Not repeatable

Method to set the random number generator seed, specified as one of the options in the table.

Option	Description
Repeatable	The block generates a random initial seed for the first simulation and reuses this seed for all subsequent simulations. Select this parameter to generate repeatable results from the statistical sensor model. To change this initial seed, at the MATLAB command prompt, enter <code>clear all</code> .

Option	Description
Specify seed	Specify your own random initial seed for reproducible results by using the Specify seed parameter.
Not repeatable	The block generates a new random initial seed after each simulation run. Select this parameter to generate nonrepeatable results from the statistical sensor model.

Initial seed — Random number generator seed

0 (default) | scalar in range [0, 2³²)

Random number generator seed, specified as a scalar in the range [0, 2³²)

Example: 2001

Dependencies

To enable this parameter, set the **Random number generator method** parameter to `Specify seed`.

Detection Reporting

Maximum reported — Maximum number of reported detections

50 (default) | positive integer

Maximum number of reported detections, specified as a positive integer. Units are dimensionless.

Example: 35

Coordinate system — Coordinate system of reported detections

`Ego Cartesian` (default) | `Sensor Cartesian` | `Sensor spherical`

Coordinate system of reported detections, specified as one of these values:

- `Ego Cartesian` — The radar reports detections in the ego vehicle Cartesian coordinate system.
- `Sensor Cartesian` — The radar reports detections in the sensor Cartesian coordinate system.
- `Sensor spherical` — The radar reports detections in the spherical coordinate system. This coordinate system is centered at the radar and aligned with the orientation of the radar on the ego vehicle.

Specify output bus name — Specify name of output bus

`off` (default) | `on`

Select this parameter to specify the name of the bus that the block outputs to the base workspace. Specify this name in the **Output bus name** parameter.

Output bus name — Name of output bus

`BusSimulation3DRadarTruthSensor` (default) | valid bus name

Name of the bus that the block outputs to the base workspace.

Dependencies

To enable this parameter, select the **Specify output bus name** parameter.

Tips

- To visualize detections and sensor coverage areas, use the **Bird's-Eye Scope**. For more details, see “Visualize Sensor Data from Unreal Engine Simulation Environment”.
- Because the Unreal Engine can take a long time to start between simulations, consider logging the signals that the sensors output. For more details, see “Mark Signals for Logging” (Simulink).

Version History

Introduced in R2019b

References

- [1] Blacksmith, P, R. E. Hiatt, and R. B. Mack. "Introduction to radar cross-section measurements." *Proceedings of the IEEE*. Volume 53, No. 8, August 1965, pp. 901-920. doi: 10.1109/PROC.1965.4069.

See Also

Apps

Bird's-Eye Scope

Blocks

Simulation 3D Scene Configuration | Simulation 3D Vehicle with Ground Following | Simulation 3D Probabilistic Radar Configuration | Multi-Object Tracker | Detection Concatenation | Simulation 3D Vision Detection Generator

Topics

“Unreal Engine Simulation for Automated Driving”

“Coordinate Systems for Unreal Engine Simulation in Automated Driving Toolbox”

“Choose a Sensor for Unreal Engine Simulation”

“Visualize Sensor Data and Tracks in Bird's-Eye Scope”

Simulation 3D Probabilistic Radar Configuration

Configure probabilistic radar signatures in 3D simulation environment



Libraries:

Automated Driving Toolbox / Simulation 3D

Description

The Simulation 3D Probabilistic Radar Configuration block configures the probabilistic radar signatures for actors in a 3D simulation environment. This environment is rendered using the Unreal Engine from Epic Games. To model the probabilistic radars, use Simulation 3D Probabilistic Radar blocks. The configured radar signatures apply to all Simulation 3D Probabilistic Radar blocks in your model.

Parameters

Radar targets — Identifiers corresponding to radar targets

[] (default) | positive integer | L -length vector of unique positive integers

Identifiers that correspond to radar targets, specified as a positive integer or L -length vector of unique positive integers. L equals the number of radar targets for which you want to specify a nondefault radar cross section (RCS).

This table provides the identifiers and corresponding object types that radars can detect in the default scenes that you can select from the Simulation 3D Scene Configuration block. For example, to specify a nondefault RCS for a building and a road, set **Radar targets** to [1, 7]. If you are using a custom scene, in the Unreal Editor, you can assign new object types to unused IDs. For more details, see “Apply Labels to Unreal Scene Elements for Semantic Segmentation and Object Detection”. If a scene contains an object that does not have an assigned ID, that object is assigned an ID of 0. The detection of lane markings is not supported.

ID	Type
0	None/default
1	Building
2	<i>Not used</i>
3	Other
4	Pedestrians
5	Pole
6	Lane Markings
7	Road
8	Sidewalk

ID	Type
9	Vegetation
10	Vehicle
11	<i>Not used</i>
12	Generic traffic sign
13	Stop sign
14	Yield sign
15	Speed limit sign
16	Weight limit sign
17 - 18	<i>Not used</i>
19	Left and right arrow warning sign
20	Left chevron warning sign
21	Right chevron warning sign
22	<i>Not used</i>
23	Right one-way sign
24	<i>Not used</i>
25	School bus only sign
26 - 38	<i>Not used</i>
39	Crosswalk sign
40	<i>Not used</i>
41	Traffic signal
42	Curve right warning sign
43	Curve left warning sign
44	Up right arrow warning sign
45 - 47	<i>Not used</i>
48	Railroad crossing sign
49	Street sign
50	Roundabout warning sign
51	Fire hydrant
52	Exit sign
53	Bike lane sign
54 - 56	<i>Not used</i>
57	Sky
58	Curb
59	Flyover ramp
60	Road guard rail
61	Bicyclist

ID	Type
62-66	<i>Not used</i>
67	Deer
68-70	<i>Not used</i>
71	Barricade
72	Motorcycle
73-255	<i>Not used</i>

Radar cross sections (dBsm) — Radar cross sections

{ } (default) | real-valued Q -by- P matrix | L -length cell array of real-valued Q_1 -by- P_1 , ..., Q_L -by- P_L matrices

Radar cross sections of target actors, in decibels per square meter, specified as a matrix or cell array of matrices. Each matrix defines the RCS for the corresponding target actor specified by **Radar targets**.

If **Radar targets** is a scalar (that is, a single target actor), then specify **Radar cross sections (dBsm)** as a real-valued Q -by- P matrix, where:

- Q is the number of elevation angle samples for the actor.
- P is the number of azimuth angle samples for the actor.

If **Radar targets** is a vector (that is, multiple target actors), then specify **Radar cross sections (dBsm)** as a L -length cell array of real-valued Q_1 -by- P_1 , ..., Q_L -by- P_L matrices, where:

- L is the number of actors.
- Q_1, \dots, Q_L are the number of elevation angle samples per actor.
- P_1, \dots, P_L are the number of azimuth angle samples per actor.

Q and P can vary for each actor. For each RCS matrix:

- The rows correspond to uniformly sampled elevation angles over the interval $[0, 180]$.
- The columns correspond to uniformly sampled azimuth angles over the interval $[0, 360]$.

For example, the number of elevation and azimuth samples for RCS matrix RCS are as follows:

```
e1 = linspace(0,180,size(RCS,1));
az = linspace(0,360,size(RCS,2));
```

Default radar cross section (dBsm) — Default radar cross section

-20 (default) | real scalar

Default radar cross section, in decibels per square meter, specified as a real scalar. The block uses this RCS value for actors whose RCS is not specified by **Radar cross sections (dBsm)**. If the model does not contain a Simulation 3D Scene Configuration block, then the default RCS assigned to actors in an Unreal Engine scenario is -20 dBsm.

Example: -10

Version History

Introduced in R2019b

See Also

Simulation 3D Probabilistic Radar

Simulation 3D Vision Detection Generator

Detect objects and lanes from measurements in 3D simulation environment

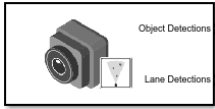

Libraries:

Automated Driving Toolbox / Simulation 3D

Description

The Simulation 3D Vision Detection Generator block generates detections from camera measurements taken by a vision sensor mounted on an ego vehicle in a 3D simulation environment. This environment is rendered using the Unreal Engine from Epic Games. The block derives detections from simulated actor poses that are based on cuboid (box-shaped) representations of the actors in the scenario. For more details, see “Algorithms” on page 2-238.

The block generates detections at intervals equal to the sensor update interval. Detections are referenced to the coordinate system of the sensor. The block can simulate real detections that have added random noise and also generate false positive detections. A statistical model generates the measurement noise, true detections, and false positives. To control the random numbers that the statistical model generates, use the random number generator settings on the **Measurements** tab of the block.

If you set **Sample time** to -1, the block uses the sample time specified in the Simulation 3D Scene Configuration block. To use this sensor, you must include a Simulation 3D Scene Configuration block in your model.

Note The Simulation 3D Scene Configuration block must execute before the Simulation 3D Vision Detection Generator block. That way, the Unreal Engine 3D visualization environment prepares the data before the Simulation 3D Vision Detection Generator block receives it. To check the block execution order, right-click the blocks and select **Properties**. On the **General** tab, confirm these **Priority** settings:

- Simulation 3D Scene Configuration — 0
- Simulation 3D Vision Detection Generator — 1

For more information about execution order, see “How Unreal Engine Simulation for Automated Driving Works”.

Limitations

The Simulation 3D Vision Detection Generator block does not detect lanes in the **Virtual Mcity** scene.

Ports

Output

Object Detections — Object detections
Simulink bus containing MATLAB structure

Object detections, returned as a Simulink bus containing a MATLAB structure. For more details about buses, see “Create Nonvirtual Buses” (Simulink). The structure has the form shown in this table.

Field	Description	Type
NumDetections	Number of detections	Integer
IsValidTime	False when updates are requested at times that are between block invocation intervals	Boolean
Detections	Object detections	Array of object detection structures of length set by the Maximum number of reported detections parameter. Only NumDetections of these detections are actual detections.

The object detection structure contains these properties.

Property	Definition
Time	Measurement time
Measurement	Object measurements
MeasurementNoise	Measurement noise covariance matrix
SensorIndex	Unique ID of the sensor
ObjectClassID	Object classification
MeasurementParameters	Parameters used by initialization functions of nonlinear Kalman tracking filters
ObjectAttributes	Additional information passed to tracker

The Measurement field reports the position and velocity of a measurement in the coordinate system of the sensor. This field is a real-valued column vector of the form $[x; y; z; vx; vy; vz]$. The MeasurementNoise field is a 6-by-6 matrix that reports the measurement noise covariance for each coordinate in the Measurement field.

The MeasurementParameters field is a structure that has these fields.

Parameter	Definition
Frame	Enumerated type indicating the frame used to report measurements. The Simulation 3D Vision Detection Generator block reports detections in sensor Cartesian coordinates, which is a rectangular coordinate frame. Therefore, for this block, Frame is always set to 'rectangular'.
OriginPosition	Offset of the sensor origin from the ego vehicle origin, returned as a vector of the form $[x, y, z]$. The block derives these values from the x , y , and z mounting position of the sensor. For more details, see the Mounting parameters of this block.
Orientation	Orientation of the sensor coordinate frame with respect to the ego vehicle coordinate frame, returned as a 3-by-3 real-valued orthonormal matrix. The block derives these values from the <i>yaw</i> , <i>pitch</i> , and <i>roll</i> mounting orientation of the sensor. For more details, see the Mounting parameters of this block.
HasVelocity	Indicates whether measurements contain velocity.

The `ObjectClassID` property of each detection has a value that corresponds to an object ID. The table shows the object IDs used in the default scenes that you can select from the Simulation 3D Scene Configuration block. If you are using a custom scene, in the Unreal Editor, you can assign new object types to unused IDs. For more details, see “Apply Labels to Unreal Scene Elements for Semantic Segmentation and Object Detection”. If a scene contains an object that does not have an assigned ID, that object is assigned an ID of 0. The block detects objects only of class `Vehicle`, such as vehicles created by using Simulation 3D Vehicle with Ground Following blocks, or of class `Road`.

ID	Type
0	None/default
1	Building
2	<i>Not used</i>
3	Other
4	Pedestrians
5	Pole
6	Lane Markings
7	Road
8	Sidewalk
9	Vegetation
10	Vehicle
11	<i>Not used</i>
12	Generic traffic sign
13	Stop sign

ID	Type
14	Yield sign
15	Speed limit sign
16	Weight limit sign
17 - 18	<i>Not used</i>
19	Left and right arrow warning sign
20	Left chevron warning sign
21	Right chevron warning sign
22	<i>Not used</i>
23	Right one-way sign
24	<i>Not used</i>
25	School bus only sign
26 - 38	<i>Not used</i>
39	Crosswalk sign
40	<i>Not used</i>
41	Traffic signal
42	Curve right warning sign
43	Curve left warning sign
44	Up right arrow warning sign
45 - 47	<i>Not used</i>
48	Railroad crossing sign
49	Street sign
50	Roundabout warning sign
51	Fire hydrant
52	Exit sign
53	Bike lane sign
54 - 56	<i>Not used</i>
57	Sky
58	Curb
59	Flyover ramp
60	Road guard rail
61	Bicyclist
62 - 66	<i>Not used</i>
67	Deer
68 - 70	<i>Not used</i>
71	Barricade
72	Motorcycle

ID	Type
73-255	<i>Not used</i>

The `ObjectAttributes` property of each detection is a structure that has these fields.

Field	Definition
TargetIndex	Identifier of the actor, <code>ActorID</code> , that generated the detection. For false alarms, this value is negative.

Dependencies

To enable this output port, on the **Parameters** tab, set the **Types of detections generated by sensor** parameter to `Lanes and objects`, `Objects only`, or `Lanes with occlusion`.

Lane Detections — Lane boundary detections

Simulink bus containing MATLAB structure

Lane boundary detections, returned as a Simulink bus containing a MATLAB structure. The structure has these fields.

Field	Description	Type
Time	Lane detection time	Real scalar
IsValidTime	False when updates are requested at times that are between block invocation intervals	Boolean
SensorIndex	Unique identifier of sensor	Positive integer
NumLaneBoundaries	Number of lane boundary detections	Nonnegative integer
LaneBoundaries	Lane boundary detections starting from the leftmost lane with respect to the ego vehicle.	Array of <code>clothoidLaneBoundary</code> objects

Dependencies

To enable this output port, on the **Parameters** tab, set the **Types of detections generated by sensor** parameter to `Lanes and objects`, `Lanes only`, or `Lanes with occlusion`.

Actor Truth — Ground truth of actor poses

Simulink bus containing MATLAB structure

Ground truth of actor poses in the simulation environment, returned as a Simulink bus containing a MATLAB structure.

The structure has these fields.

Field	Description	Type
NumActors	Number of actors	Nonnegative integer
Time	Current simulation time	Real-valued scalar

Field	Description	Type
Actors	Actor poses	NumActors-length array of actor pose structures

Each actor pose structure in `Actors` has these fields.

Field	Description
ActorID	Scenario-defined actor identifier, specified as a positive integer.
Position	Position of actor, specified as a real-valued vector of the form $[x \ y \ z]$. Units are in meters.
Velocity	Velocity (v) of actor in the x - y -, and z -directions, specified as a real-valued vector of the form $[v_x \ v_y \ v_z]$. Units are in meters per second.
Roll	Roll angle of actor, specified as a real-valued scalar. Units are in degrees.
Pitch	Pitch angle of actor, specified as a real-valued scalar. Units are in degrees.
Yaw	Yaw angle of actor, specified as a real-valued scalar. Units are in degrees.
AngularVelocity	Angular velocity (ω) of actor in the x -, y -, and z -directions, specified as a real-valued vector of the form $[\omega_x \ \omega_y \ \omega_z]$. Units are in degrees per second.

The pose of the ego vehicle is excluded from the `Actors` array.

Dependencies

To enable this output port, on the **Ground Truth** tab, select the **Output actor truth** parameter.

Lane Truth — Ground truth of lane boundaries

Simulink bus containing MATLAB structure

Ground truth of lane boundaries in the simulation environment, returned as a Simulink bus containing a MATLAB structure.

The structure has these fields.

Field	Description	Type
NumLaneBoundaries	Number of lane boundaries	Nonnegative integer
Time	Current simulation time	Real scalar
LaneBoundaries	Lane boundaries starting from the leftmost lane with respect to the ego vehicle.	NumLaneBoundaries-length array of lane boundary structures

Each lane boundary structure in `LaneBoundaries` has these fields.

Field	Description
-------	-------------

Coordinates	<p>Lane boundary coordinates, specified as a real-valued N-by-3 matrix, where N is the number of lane boundary coordinates. Lane boundary coordinates define the position of points on the boundary at specified longitudinal distances away from the ego vehicle, along the center of the road.</p> <ul style="list-style-type: none"> • In MATLAB, specify these distances by using the 'XDistance' name-value pair argument of the laneBoundaries function. • In Simulink, specify these distances by using the Distances from ego vehicle for computing boundaries (m) parameter of the Scenario Reader block or the Distance from parent for computing lane boundaries parameter of the Simulation 3D Vision Detection Generator block. <p>This matrix also includes the boundary coordinates at zero distance from the ego vehicle. These coordinates are to the left and right of the ego-vehicle origin, which is located under the center of the rear axle. Units are in meters.</p>
Curvature	<p>Lane boundary curvature at each row of the <code>Coordinates</code> matrix, specified as a real-valued N-by-1 vector. N is the number of lane boundary coordinates. Units are in radians per meter.</p>
CurvatureDerivative	<p>Derivative of lane boundary curvature at each row of the <code>Coordinates</code> matrix, specified as a real-valued N-by-1 vector. N is the number of lane boundary coordinates. Units are in radians per square meter.</p>
HeadingAngle	<p>Initial lane boundary heading angle, specified as a real scalar. The heading angle of the lane boundary is relative to the ego vehicle heading. Units are in degrees.</p>

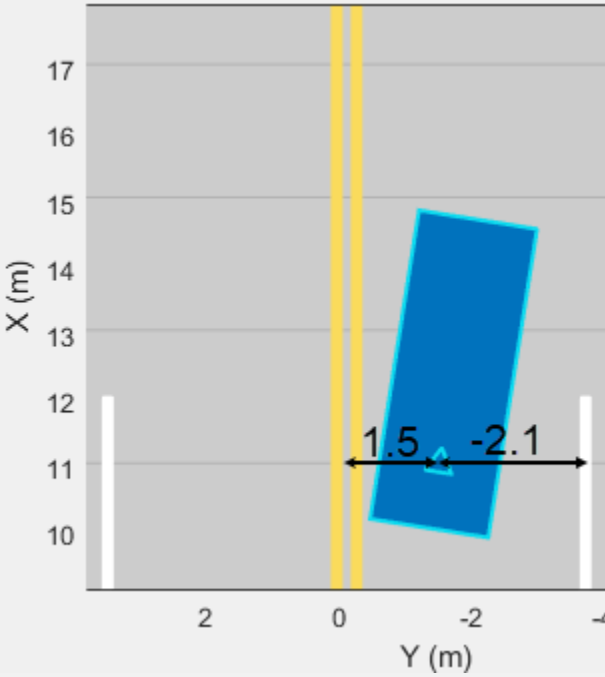
LateralOffset	<p>Lateral offset of the ego vehicle position from the lane boundary, specified as a real scalar. An offset to a lane boundary to the left of the ego vehicle is positive. An offset to the right of the ego vehicle is negative. Units are in meters. In this image, the ego vehicle is offset 1.5 meters from the left lane and 2.1 meters from the right lane.</p> 
BoundaryType	<p>Type of lane boundary marking, specified as one of these values:</p> <ul style="list-style-type: none"> • 'Unmarked' — No physical lane marker exists • 'Solid' — Single unbroken line • 'Dashed' — Single line of dashed lane markers • 'DoubleSolid' — Two unbroken lines • 'DoubleDashed' — Two dashed lines • 'SolidDashed' — Solid line on the left and a dashed line on the right • 'DashedSolid' — Dashed line on the left and a solid line on the right

Strength	Saturation strength of the lane boundary marking, specified as a real scalar from 0 to 1. A value of 0 corresponds to a marking whose color is fully unsaturated. The marking is gray. A value of 1 corresponds to a marking whose color is fully saturated.
Width	Lane boundary width, specified as a positive real scalar. In a double-line lane marker, the same width is used for both lines and for the space between lines. Units are in meters.
Length	Length of dash in dashed lines, specified as a positive real scalar. In a double-line lane marker, the same length is used for both lines.
Space	Length of space between dashes in dashed lines, specified as a positive real scalar. In a dashed double-line lane marker, the same space is used for both lines.

The number of returned lane boundary structures depends on the **Maximum number of reported lanes** parameter value.

Dependencies

To enable this output port, on the **Ground Truth** tab, select the **Output lane truth** parameter.

Parameters

Mounting

Sensor identifier — Unique sensor identifier

1 (default) | positive integer

Specify the unique identifier of the sensor. In a multisensor system, the sensor identifier enables you to distinguish between sensors. When you add a new sensor block to your model, the **Sensor identifier** of that block is $N + 1$, where N is the highest **Sensor identifier** value among the existing sensor blocks in the model.

Example: 2

Parent name — Name of parent vehicle

Scene Origin (default) | vehicle name

Name of the parent to which the sensor is mounted, specified as `Scene Origin` or as the name of a vehicle in your model. The vehicle names that you can select correspond to the **Name** parameters of the simulation 3D vehicle blocks in your model. If you select `Scene Origin`, the block places a sensor at the scene origin.

Example: `SimulinkVehicle1`

Mounting location — Sensor mounting location



Origin (default) | Front bumper | Rear bumper | Right mirror | Left mirror | Rearview mirror | Hood center | Roof center

Sensor mounting location.

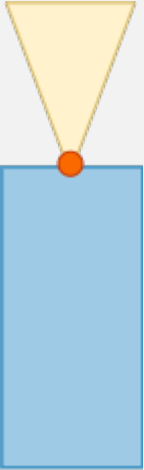
- When **Parent name** is Scene Origin, the block mounts the sensor to the origin of the scene. You can set the **Mounting location** to Origin only. During simulation, the sensor remains stationary.
- When **Parent name** is the name of a vehicle, the block mounts the sensor to one of the predefined mounting locations described in the table. During simulation, the sensor travels with the vehicle.

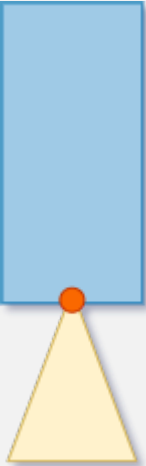
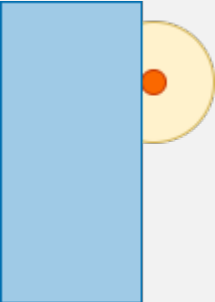
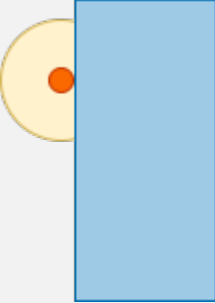
Vehicle Mounting Location	Description	Orientation Relative to Vehicle Origin [Roll, Pitch, Yaw] (deg)
Origin	<p>Forward-facing sensor mounted to the vehicle origin, which is on the ground and at the geometric center of the vehicle (see “Coordinate Systems for Unreal Engine Simulation in Automated Driving Toolbox”)</p> 	[0, 0, 0]
Front bumper	<p>Forward-facing sensor mounted to the front bumper</p> 	[0, 0, 0]

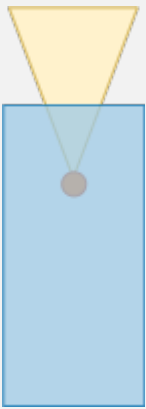
Vehicle Mounting Location	Description	Orientation Relative to Vehicle Origin [Roll, Pitch, Yaw] (deg)
Rear bumper	Backward-facing sensor mounted to the rear bumper 	[0, 0, 180]
Right mirror	Downward-facing sensor mounted to the right side-view mirror 	[0, -90, 0]
Left mirror	Downward-facing sensor mounted to the left side-view mirror 	[0, -90, 0]

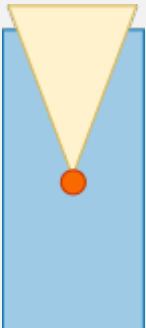
Vehicle Mounting Location	Description	Orientation Relative to Vehicle Origin [Roll, Pitch, Yaw] (deg)
Rearview mirror	<p>Forward-facing sensor mounted to the rearview mirror, inside the vehicle</p> 	[0, 0, 0]
Hood center	<p>Forward-facing sensor mounted to the center of the hood</p> 	[0, 0, 0]
Roof center	<p>Forward-facing sensor mounted to the center of the roof</p> 	[0, 0, 0]

Roll, pitch, and yaw are clockwise-positive when looking in the positive direction of the X-axis, Y-axis, and Z-axis, respectively. When looking at a vehicle from above, the yaw angle (the orientation angle) is counterclockwise-positive because you are looking in the negative direction of the axis.

The X-Y-Z mounting location of the sensor relative to the vehicle depends on the vehicle type. To specify the vehicle type, use the **Type** parameter of the Simulation 3D Vehicle with Ground Following block to which you mount the sensor. To obtain the X-Y-Z mounting locations for a vehicle type, see the reference page for that vehicle.

To determine the location of the sensor in world coordinates, open the sensor block. Then, on the **Ground Truth** tab, select the **Output location (m) and orientation (rad)** parameter and inspect the data from the **Location** output port.

Specify offset — Specify offset from mounting location

off (default) | on

Select this parameter to specify an offset from the mounting location by using the **Relative translation [X, Y, Z] (m)** and **Relative rotation [Roll, Pitch, Yaw] (deg)** parameters.

Relative translation [X, Y, Z] (m) — Translation offset relative to mounting location

[0, 0, 0] (default) | real-valued 1-by-3 vector

Translation offset relative to the mounting location of the sensor, specified as a real-valued 1-by-3 vector of the form [X, Y, Z]. Units are in meters.

If you mount the sensor to a vehicle by setting **Parent name** to the name of that vehicle, then X, Y, and Z are in the vehicle coordinate system, where:

- The X-axis points forward from the vehicle.
- The Y-axis points to the left of the vehicle, as viewed when looking in the forward direction of the vehicle.
- The Z-axis points up.

The origin is the mounting location specified in the **Mounting location** parameter. This origin is different from the vehicle origin, which is the geometric center of the vehicle.

If you mount the sensor to the scene origin by setting **Parent name** to Scene Origin, then X, Y, and Z are in the world coordinates of the scene.

For more details about the vehicle and world coordinate systems, see “Coordinate Systems for Unreal Engine Simulation in Automated Driving Toolbox”.

Example: [0,0,0.01]

Dependencies

To enable this parameter, select **Specify offset**.

Relative rotation [Roll, Pitch, Yaw] (deg) — Rotational offset relative to mounting location

[0, 0, 0] (default) | real-valued 1-by-3 vector

Rotational offset relative to the mounting location of the sensor, specified as a real-valued 1-by-3 vector of the form $[Roll, Pitch, Yaw]$. Roll, pitch, and yaw are the angles of rotation about the X-, Y-, and Z-axes, respectively. Units are in degrees.

If you mount the sensor to a vehicle by setting **Parent name** to the name of that vehicle, then X, Y, and Z are in the vehicle coordinate system, where:

- The X-axis points forward from the vehicle.
- The Y-axis points to the left of the vehicle, as viewed when looking in the forward direction of the vehicle.
- The Z-axis points up.
- Roll, pitch, and yaw are clockwise-positive when looking in the forward direction of the X-axis, Y-axis, and Z-axis, respectively. If you view a scene from a 2D top-down perspective, then the yaw angle (also called the orientation angle) is counterclockwise-positive because you are viewing the scene in the negative direction of the Z-axis.

The origin is the mounting location specified in the **Mounting location** parameter. This origin is different from the vehicle origin, which is the geometric center of the vehicle.

If you mount the sensor to the scene origin by setting **Parent name** to `Scene Origin`, then X, Y, and Z are in the world coordinates of the scene.

For more details about the vehicle and world coordinate systems, see “Coordinate Systems for Unreal Engine Simulation in Automated Driving Toolbox”.

Example: $[0, 0, 10]$

Dependencies

To enable this parameter, select **Specify offset**.

Sample time — Sample time

-1 (default) | positive scalar

Sample time of the block, in seconds, specified as a positive scalar. The 3D simulation environment frame rate is the inverse of the sample time.

If you set the sample time to -1, the block inherits its sample time from the Simulation 3D Scene Configuration block.

Parameters

Detection Reporting

Types of detections generated by sensor — Types of detections generated by sensor

Lanes and objects (default) | Objects only | Lanes only | Lanes with occlusion

Types of detections generated by the sensor, specified as one of these options:

- `Lanes and objects` — Detect lanes and objects. No road information is used to occlude actors.
- `Objects only` — Detect objects only.
- `Lanes only` — Detection lanes only.

- **Lanes with occlusion** — Detect lane and objects. Objects in the camera field of view can impair the ability of the sensor to detect lanes.

Maximum number of reported detections — Maximum number of reported detections

50 (default) | positive integer

Maximum number of detections reported by the sensor, specified as a positive integer. Detections are reported in order of increasing distance from the sensor until the maximum number is reached.

Example: 100

Maximum number of reported lanes — Maximum number of reported lanes

30 (default) | positive integer

Maximum number of reported lanes, specified as a positive integer.

Example: 100

Distance from parent for computing lane boundaries — Distances from parent frame at which to compute lane boundaries

0:0.5:9.5 (default) | N -element real-valued vector

Distances from the parent frame at which to compute the lane boundaries, specified as an N -element real-valued vector. N is the number of distance values. N should not exceed 100. Units are in meters.

The parent is the frame to which the sensor is mounted, such as the ego vehicle. The **Parent name** parameter determines the parent frame. Distances are relative to the origin of the parent frame.

When detecting lanes from rear-facing cameras, specify negative distances. When detecting lanes from front-facing cameras, specify positive distances.

By default, the block computes a lane boundary every 0.5 meters over the range from 0 to 9.5 meters ahead of the parent.

Example: 1:0.1:10 computes a lane boundary every 0.1 meters over the range from 1 to 10 meters ahead of the parent.

Output Port Settings

Source of object bus name — Source of object bus name

Auto (default) | Property

Source of object bus name, specified as Auto or Property. If you select Auto, the block creates a bus name. If you select Property, specify the bus name by using the **Object bus name** parameter.

Object bus name — Object bus name

BusObjectDetections | valid bus name

Object bus name, specified as a valid bus name.

Dependencies

To enable this parameter, set the **Source of object bus name** parameter to Property.

Source of output lane bus name — Source of output lane bus name

Auto (default) | Property

Source of output lane bus name, specified as Auto or Property. If you select Auto, the block creates a bus name. If you select Property, specify the bus name by using the **Specify an output lane bus name** parameter.

Specify an output lane bus name — Lane bus name

BusLaneDetections (default) | valid bus name

Lane bus name, specified as a valid bus name.

Dependencies

To enable this parameter, set the **Source of output lane bus name** parameter to Property.

Measurements

Maximum detection range (m) — Maximum detection range

150 (default) | positive real scalar

Maximum detection range, specified as a positive real scalar. The vision sensor cannot detect objects beyond this range. Units are in meters.

Example: 250

Object Detector Settings

Bounding box accuracy (pixels) — Bounding box accuracy

5 (default) | positive real scalar

Bounding box accuracy, specified as a positive real scalar. This quantity defines the accuracy with which the detector can match a bounding box to a target. Units are in pixels.

Example: 9

Smoothing filter noise intensity (m/s²) — Noise intensity used for filtering position and velocity measurements

5 (default) | positive real scalar

Noise intensity used for filtering position and velocity measurements, specified as a positive real scalar. Noise intensity defines the standard deviation of the process noise of the internal constant-velocity Kalman filter used in a vision sensor. The filter models the process noise by using a piecewise-constant white noise acceleration model. Noise intensity is typically of the order of the maximum acceleration magnitude expected for a target. Units are in meters per second squared.

Example: 2

Maximum detectable object speed (m/s) — Maximum detectable object speed

50 (default) | nonnegative real scalar

Maximum detectable object speed, specified as a nonnegative real scalar. Units are in meters per second.

Example: 20

Maximum allowed occlusion for detector — Maximum allowed occlusion of an object

0.5 (default) | real scalar in the range [0 1)

Maximum allowed occlusion of an object, specified as a real scalar in the range [0 1). Occlusion is the fraction of the total surface area of an object that is not visible to the sensor. A value of 1 indicates that the object is fully occluded. Units are dimensionless.

Example: 0.2

Minimum detectable image size of an object (pixels) — Minimum height and width of an object

[15, 15] (default) | 1-by-2 vector of positive values

Minimum height and width of an object that the vision sensor detects within an image, specified as a [minHeight, minWidth] vector of positive values. The 2-D projected height of an object must be greater than or equal to minHeight. The projected width of an object must be greater than or equal to minWidth. Units are in pixels.

Example: [25 20]

Probability of detecting a target — Probability of detection

0.9 (default) | positive real scalar less than or equal to 1

Probability of detecting a target, specified as a positive real scalar less than or equal to 1. This quantity defines the probability that the sensor detects a detectable object. A detectable object is an object that satisfies the minimum detectable size, maximum range, maximum speed, and maximum allowed occlusion constraints.

Example: 0.95

Number of false positives per image — Number of false detections generated by vision sensor per image

0.1 (default) | nonnegative real scalar

Number of false detections generated by the vision sensor per image, specified as a nonnegative real scalar.

Example: 1.0

Lane Detector Settings**Minimum lane size in image (pixels)** — Maximum size of lane

[20, 3] (default) | 1-by-2 real-valued vector

Minimum size of a projected lane marking in the camera image that the sensor can detect after accounting for curvature, specified as a 1-by-2 real-valued vector of the form [minHeight, minWidth]. Lane markings must exceed both of these values to be detected. Units are in pixels.

Accuracy of lane boundary (pixels) — Accuracy of lane boundary

3 (default) | positive real scalar

Accuracy of lane boundaries, specified as a positive real scalar. This parameter defines the accuracy with which the lane sensor can place a lane boundary. Units are in pixels.

Example: 2.5

Random Number Generator Settings

Add noise to measurements — Enable adding noise to vision sensor measurements

on (default) | off

Select this parameter to add noise to vision sensor measurements. Otherwise, the measurements are noise-free. The MeasurementNoise property of each detection is always computed and is not affected by the value you specify for the **Add noise to measurements** parameter.

Select method to specify initial seed — Method to specify random number generator seed

Repeatable (default) | Specify seed | Not repeatable

Method to set the random number generator seed, specified as one of the options in the table.

Option	Description
Repeatable	The block generates a random initial seed for the first simulation and reuses this seed for all subsequent simulations. Select this parameter to generate repeatable results from the statistical sensor model. To change this initial seed, at the MATLAB command prompt, enter: <code>clear all</code> .
Specify seed	Specify your own random initial seed for reproducible results by using the Initial seed parameter.
Not repeatable	The block generates a new random initial seed after each simulation run. Select this parameter to generate nonrepeatable results from the statistical sensor model.

Initial seed — Random number generator seed

1 (default) | nonnegative integer less than 2^{32}

Random number generator seed, specified as a nonnegative integer less than 2^{32} .

Example: 2001

Dependencies

To enable this parameter, set the **Select method to specify initial seed** parameter to Specify seed.

Camera Intrinsic**Focal length (pixels)** — Camera focal length

[800, 800] (default) | two-element real-valued vector

Camera focal length, in pixels, specified as a two-element real-valued vector. See also the FocalLength property of cameraIntrinsic.

Example: [480, 320]

Optical center (pixels) — Optical center of camera

[320, 240] (default) | two-element real-valued vector

Optical center of the camera, in pixels, specified as a two-element real-valued vector. See also the PrincipalPoint property of cameraIntrinsic.

Example: [480, 320]

Image size (pixels) — Image size produced by camera

[480, 640] (default) | two-element vector of positive integers

Image size produced by the camera, in pixels, specified as a two-element vector of positive integers. See also the ImageSize property of cameraIntrinsic.

Example: [240, 320]

Radial distortion coefficients — Radial distortion coefficients

[0, 0] (default) | two-element real-valued vector | three-element real-valued vector

Radial distortion coefficients, specified as a two-element or three-element real-valued vector. For details on setting these coefficients, see the RadialDistortion property of cameraIntrinsic.

Example: [1, 1]

Tangential distortion coefficients — Tangential distortion coefficients

[0, 0] (default) | two-element real-valued vector

Tangential distortion coefficients, specified as a two-element real-valued vector. For details on setting these coefficients, see the TangentialDistortion property of cameraIntrinsic.

Example: [1, 1]

Skew of the camera axes — Skew angle of camera axes

0 (default) | real scalar

Skew angle of the camera axes, specified as a real scalar. See also the Skew property of cameraIntrinsic.

Example: 0.1

Ground Truth

Output actor truth — Output ground truth of actors

off (default) | on

Select this parameter to output the ground truth of actors on the **Actor Truth** output port.

Output lane truth — Output ground truth of lane boundaries

off (default) | on

Select this parameter to output the ground truth of lane boundaries on the **Lane Truth** output port.

Tips

- The sensor is unable to detect lanes and objects from vantage points too close to the ground. After mounting the sensor block to a vehicle by using the **Parent name** parameter, set the **Mounting location** parameter to one of the predefined mounting locations on the vehicle.

If you leave **Mounting location** set to **Origin**, which mounts the sensor on the ground below the vehicle center, then specify an offset that is at least 0.1 meter above the ground. Select **Specify offset**, and in the **Relative translation [X, Y, Z] (m)** parameter, set a Z value of at least 0.1.

- To visualize detections and sensor coverage areas, use the **Bird's-Eye Scope**. See “Visualize Sensor Data from Unreal Engine Simulation Environment”.
- Because the Unreal Engine can take a long time to start between simulations, consider logging the signals that the sensors output. See “Mark Signals for Logging” (Simulink).

Algorithms

To generate detections, the Simulation 3D Vision Detection Generator block feeds the actor and lane ground truth data that is read from the Unreal Engine simulation environment to a Vision Detection Generator block. This block returns detections that are based on cuboid, or box-shaped, representations of the actors. The physical dimensions of detected actors are not based on their dimensions in the Unreal Engine environment. Instead, they are based on the default values set in the **Actor Profiles** parameter tab of the Vision Detection Generator block, as seen when the **Select method to specify actor profiles** parameter is set to **Parameters**. With these defaults, all actors are approximately the size of a sedan. If you return detections that have occlusions, then the occlusions are based on all actors being of this one size.

Version History

Introduced in R2020b

See Also

Apps

Bird's-Eye Scope

Blocks

Detection Concatenation | Multi-Object Tracker | Scenario Reader | Vision Detection Generator | Simulation 3D Probabilistic Radar | Simulation 3D Scene Configuration | Simulation 3D Vehicle with Ground Following

Objects

visionDetectionGenerator | cameraIntrinsics

Topics

“Unreal Engine Simulation for Automated Driving”

“Coordinate Systems for Unreal Engine Simulation in Automated Driving Toolbox”

“Choose a Sensor for Unreal Engine Simulation”

“Visualize Sensor Data and Tracks in Bird's-Eye Scope”

Simulation 3D Ultrasonic Sensor

Ultrasonic sensor model in 3D simulation environment



Libraries:

Automated Driving Toolbox / Simulation 3D
UAV Toolbox / Simulation 3D

Description

The Simulation 3D Ultrasonic Sensor block generates detections from range measurements taken by an ultrasonic sensor mounted on an ego vehicle in a 3D simulation environment rendered using the Unreal Engine from Epic Games. The block calculates range measurements based on the distance between the sensor and the closest point on the detected object.

If you set **Sample time** to -1, the block uses the sample time specified in the Simulation 3D Scene Configuration block. To use this sensor, you must include a Simulation 3D Scene Configuration block in your model.

Note The Simulation 3D Scene Configuration block must execute before the Simulation 3D Ultrasonic Sensor block. That way, the Unreal Engine 3D visualization environment prepares the data before the Simulation 3D Vision Detection Generator block receives it. To check the block execution order, right-click the blocks and select **Properties**. On the **General** tab, confirm these **Priority** settings:

- Simulation 3D Scene Configuration — 0
- Simulation 3D Ultrasonic Sensor — 1

For more information about execution order, see “How Unreal Engine Simulation for Automated Driving Works”.

Ports

Output

Detections — Object detections

scalar

Object detections, returned as a Simulink bus containing a MATLAB structure. For more details about buses, see “Create Nonvirtual Buses” (Simulink).

You can pass object detections from these sensors and other sensors to a tracker, such as a Multi-Object Tracker block, and generate tracks.

The structure contains these fields.

Field	Description
Time	Measurement time
Measurement	Distance measurement to the closest object
MeasurementNoise	Measurement noise covariance matrix
SensorIndex	Unique ID of the sensor
ObjectClassID	Object classification
ObjectAttributes	Additional information passed to tracker
MeasurementParameters	Parameters used by initialization functions of nonlinear Kalman tracking filters

This table describes the additional information in the `ObjectAttributes` field.

ObjectAttributes

Attribute	Definition
TargetIndex	Identifier of the actor that generated the detection, returned as the value of the <code>ActorID</code> property of the actor. For false alarms, this value is negative.
PointOnTarget	Coordinate of the point on the detected object that the sensor used to compute the distance measurement, in the vehicle coordinate system. Use this for visualizing detections in the Bird's-Eye Scope app.

For `MeasurementParameters`, the measurements are relative to the parent frame. The parent frame is the ego vehicle body.

MeasurementParameters

Parameter	Definition
Frame	Enumerated type indicating the frame used to report measurements. If the detections come from an Ultrasonic Detection Generator block, Simulation 3D Ultrasonic Sensor reports them in spherical coordinates, and the value of Frame is 'spherical'.
OriginPosition	3-D vector offset of the sensor origin from the parent frame origin.
OriginVelocity	Velocity of the sensor coordinate system with respect to the parent frame.
IsParentToChild	Logical scalar indicating if Orientation performs a frame rotation from the parent coordinate frame to the child coordinate frame. When IsParentToChild is false, then Orientation performs a frame rotation from the child coordinate frame to the parent coordinate frame.
HasAzimuth	Indicates whether measurements contain azimuth components.
HasRange	Indicates whether measurements contain range components. Always true for Ultrasonic Detection Generator.
HasElevation	Indicates whether measurements contain elevation components. Always false for Ultrasonic Detection Generator.
HasVelocity	Indicates whether measurements contain velocity or range rate components. Always false for Ultrasonic Detection Generator.
FieldOfView	2-D vector containing the azimuth and elevation field-of-view values of the sensor.

Dependencies

To enable this port, select the **Use bus output** parameter.

Has object — Detectable object present in sensor field-of-view
scalar

Detectable object present in the sensor field-of-view, returned as a Boolean scalar. An object is considered detectable if its closest distance to the sensor is greater than the minimum detection-only range specified in the **Detection Ranges (m)** parameter.

Dependencies

To enable this port, clear the **Use bus output** parameter.

Has range — Range measurement possible for object present in sensor field-of-view
scalar

Range measurement is possible for an object present in the sensor field-of-view, returned as a Boolean scalar. For any object in the field-of-view, range measurement is possible if its closest distance to the sensor is greater than the minimum-distance range specified in the **Detection Ranges (m)** parameter.

Dependencies

To enable this output port, clear the **Use bus output** parameter.

Range — Distance measurement to closest object scalar

Distance measurement to the closest object, returned as a nonnegative scalar, in meters.

Dependencies

To enable this port, clear the **Use bus output** parameter.

Parameters

Mounting

Sensor identifier — Unique sensor identifier

1 (default) | positive integer

Specify the unique identifier of the sensor. In a multisensor system, the sensor identifier enables you to distinguish between sensors. When you add a new sensor block to your model, the **Sensor identifier** of that block is $N + 1$, where N is the highest **Sensor identifier** value among the existing sensor blocks in the model.

Example: 2

Parent name — Name of parent vehicle

Scene Origin (default) | vehicle name

Name of the parent to which the sensor is mounted, specified as `Scene Origin` or as the name of a vehicle in your model. The vehicle names that you can select correspond to the **Name** parameters of the simulation 3D vehicle blocks in your model. If you select `Scene Origin`, the block places a sensor at the scene origin.

Example: `SimulinkVehicle1`

Mounting location — Sensor mounting location



Origin (default) | Front bumper | Rear bumper | Right mirror | Left mirror | Rearview mirror | Hood center | Roof center

Sensor mounting location.

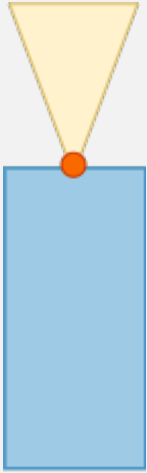
- When **Parent name** is `Scene Origin`, the block mounts the sensor to the origin of the scene. You can set the **Mounting location** to `Origin` only. During simulation, the sensor remains stationary.
- When **Parent name** is the name of a vehicle, the block mounts the sensor to one of the predefined mounting locations described in the table. During simulation, the sensor travels with the vehicle.

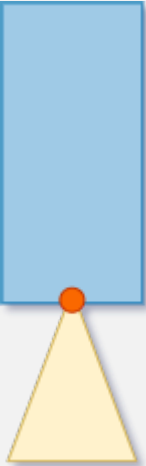
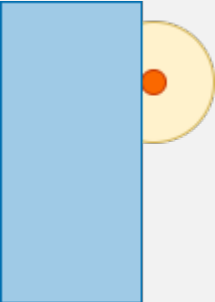
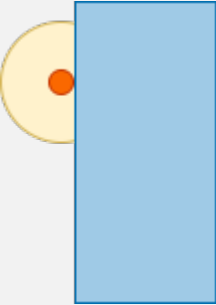
Vehicle Mounting Location	Description	Orientation Relative to Vehicle Origin [Roll, Pitch, Yaw] (deg)
Origin	<p>Forward-facing sensor mounted to the vehicle origin, which is on the ground and at the geometric center of the vehicle (see “Coordinate Systems for Unreal Engine Simulation in Automated Driving Toolbox”)</p> 	[0, 0, 0]
Front bumper	<p>Forward-facing sensor mounted to the front bumper</p> 	[0, 0, 0]

Vehicle Mounting Location	Description	Orientation Relative to Vehicle Origin [Roll, Pitch, Yaw] (deg)
Rear bumper	Backward-facing sensor mounted to the rear bumper 	[0, 0, 180]
Right mirror	Downward-facing sensor mounted to the right side-view mirror 	[0, -90, 0]
Left mirror	Downward-facing sensor mounted to the left side-view mirror 	[0, -90, 0]

Vehicle Mounting Location	Description	Orientation Relative to Vehicle Origin [Roll, Pitch, Yaw] (deg)
Rearview mirror	<p>Forward-facing sensor mounted to the rearview mirror, inside the vehicle</p> 	[0, 0, 0]
Hood center	<p>Forward-facing sensor mounted to the center of the hood</p> 	[0, 0, 0]
Roof center	<p>Forward-facing sensor mounted to the center of the roof</p> 	[0, 0, 0]

Roll, pitch, and yaw are clockwise-positive when looking in the positive direction of the X-axis, Y-axis, and Z-axis, respectively. When looking at a vehicle from above, the yaw angle (the orientation angle) is counterclockwise-positive because you are looking in the negative direction of the axis.

The X-Y-Z mounting location of the sensor relative to the vehicle depends on the vehicle type. To specify the vehicle type, use the **Type** parameter of the Simulation 3D Vehicle with Ground Following block to which you mount the sensor. To obtain the X-Y-Z mounting locations for a vehicle type, see the reference page for that vehicle.

To determine the location of the sensor in world coordinates, open the sensor block. Then, on the **Ground Truth** tab, select the **Output location (m) and orientation (rad)** parameter and inspect the data from the **Location** output port.

Specify offset — Specify offset from mounting location

off (default) | on

Select this parameter to specify an offset from the mounting location by using the **Relative translation [X, Y, Z] (m)** and **Relative rotation [Roll, Pitch, Yaw] (deg)** parameters.

Relative translation [X, Y, Z] (m) — Translation offset relative to mounting location

[0, 0, 0] (default) | real-valued 1-by-3 vector

Translation offset relative to the mounting location of the sensor, specified as a real-valued 1-by-3 vector of the form [X, Y, Z]. Units are in meters.

If you mount the sensor to a vehicle by setting **Parent name** to the name of that vehicle, then X, Y, and Z are in the vehicle coordinate system, where:

- The X-axis points forward from the vehicle.
- The Y-axis points to the left of the vehicle, as viewed when looking in the forward direction of the vehicle.
- The Z-axis points up.

The origin is the mounting location specified in the **Mounting location** parameter. This origin is different from the vehicle origin, which is the geometric center of the vehicle.

If you mount the sensor to the scene origin by setting **Parent name** to Scene Origin, then X, Y, and Z are in the world coordinates of the scene.

For more details about the vehicle and world coordinate systems, see “Coordinate Systems for Unreal Engine Simulation in Automated Driving Toolbox”.

Example: [0, 0, 0.01]

Dependencies

To enable this parameter, select **Specify offset**.

Relative rotation [Roll, Pitch, Yaw] (deg) — Rotational offset relative to mounting location

[0, 0, 0] (default) | real-valued 1-by-3 vector

Rotational offset relative to the mounting location of the sensor, specified as a real-valued 1-by-3 vector of the form $[Roll, Pitch, Yaw]$. Roll, pitch, and yaw are the angles of rotation about the X-, Y-, and Z-axes, respectively. Units are in degrees.

If you mount the sensor to a vehicle by setting **Parent name** to the name of that vehicle, then X, Y, and Z are in the vehicle coordinate system, where:

- The X-axis points forward from the vehicle.
- The Y-axis points to the left of the vehicle, as viewed when looking in the forward direction of the vehicle.
- The Z-axis points up.
- Roll, pitch, and yaw are clockwise-positive when looking in the forward direction of the X-axis, Y-axis, and Z-axis, respectively. If you view a scene from a 2D top-down perspective, then the yaw angle (also called the orientation angle) is counterclockwise-positive because you are viewing the scene in the negative direction of the Z-axis.

The origin is the mounting location specified in the **Mounting location** parameter. This origin is different from the vehicle origin, which is the geometric center of the vehicle.

If you mount the sensor to the scene origin by setting **Parent name** to Scene Origin, then X, Y, and Z are in the world coordinates of the scene.

For more details about the vehicle and world coordinate systems, see “Coordinate Systems for Unreal Engine Simulation in Automated Driving Toolbox”.

Example: $[0, 0, 10]$

Dependencies

To enable this parameter, select **Specify offset**.

Sample time — Sample time

-1 (default) | positive scalar

Sample time of the block, in seconds, specified as a positive scalar. The 3D simulation environment frame rate is the inverse of the sample time.

If you set the sample time to -1, the block inherits its sample time from the Simulation 3D Scene Configuration block.

Sensor Parameters

Detection ranges (m) — Detection range vector of ultrasonic sensor (m)

$[0.03 \ 0.15 \ 5.5]$ (default) | 1-by-3 nonnegative real-valued vector of form $[\text{minDetOnlyRange} \ \text{minDistRange} \ \text{maxDistRange}]$

Detection range vector of the ultrasonic sensor, specified as a 1-by-3 nonnegative real-valued vector of the form $[\text{minDetOnlyRange} \ \text{minDistRange} \ \text{maxDistRange}]$, where $\text{minDetOnlyRange} < \text{minDistRange} < \text{maxDistRange}$. Units are in meters. These values determine the detections and distance values returned by the ultrasonic sensor.

- When the detected object is at a distance between `minDistRange` and `maxDistRange`, the sensor returns a positive distance value.

- When the detected object is at a distance between `minDetOnlyRange` and `minDistRange`, the sensor detects the object, but cannot determine the distance and returns a value of 0.
- When the object is at a distance below `minDetOnlyRange` or above `maxDistRange`, the sensor returns an empty cell array.

Horizontal Field of view (deg) — Horizontal field of view of ultrasonic sensor

70 (default) | positive real scalar

Horizontal field of view of ultrasonic sensor, specified as a positive real scalar. This field of view defines the total angular extent spanned by the sensor in the horizontal direction. You must specify the horizontal field of view `horizontalFOV` in the range (0, 360]. Units are in degrees.

Vertical Field of view (deg) — Vertical field of view of ultrasonic sensor

70 (default) | positive real scalar

Vertical field of view of ultrasonic sensor, specified as a positive real scalar. This field of view defines the total angular extent spanned by the sensor in the vertical direction. You must specify the vertical field of view in the range (0, 180]. Units are in degrees.

Use bus output — Output signals together as bus

on (default) | off

Select to output detections as a bus signal using the **Detections** port. Clear **Use bus output** to instead enable the **Has object**, **Has range**, and **Range** output ports.

Version History

Introduced in R2022b

See Also

Simulation 3D Scene Configuration | Simulation 3D Vehicle with Ground Following | Simulation 3D Lidar | Simulation 3D Camera

Simulation 3D Pedestrian

Implement pedestrian in 3D environment



Libraries:

Automated Driving Toolbox / Simulation 3D

Description

The Simulation 3D Pedestrian block implements a pedestrian in a 3D simulation environment. The block uses the input (X , Y) position and yaw angle of the pedestrian to adjust the elevation, roll angle, and pitch angle so that the pedestrian follows the ground terrain. The block determines the pedestrian velocity and heading and adjusts the movement to be idle, walk, or run, appropriately. Use this block for automated driving applications.

To use this block, ensure that the Simulation 3D Scene Configuration block is in your model. If you set the **Sample time** parameter of the Simulation 3D Pedestrian block to -1 , the block inherits the sample time specified in the Simulation 3D Scene Configuration block.

The block input uses the pedestrian Z -up right-handed (RH) Cartesian coordinate system defined in SAE J670 [1] and ISO 8855 [2]. The coordinate system is inertial and initially aligned with the pedestrian feet:

- The X -axis is along the longitudinal axis of the pedestrian and points forward.
- The Y -axis is along the lateral axis of the pedestrian and points to the left.
- The Z -axis points upward.

The yaw, pitch, and roll angles of the Z -axis, Y -axis, and X -axis, respectively, are positive in the clockwise directions, when looking in the positive directions of these axes. Pedestrians are placed in the world coordinate system of the scenes. For more details, see “Coordinate Systems for Unreal Engine Simulation in Automated Driving Toolbox”.

Ports

Input

Y — Lateral position of pedestrian
scalar

Lateral position of the pedestrian along the Y -axis of the scene. **Y** is in the inertial Z -up coordinate system. Units are in meters.

The Y value of the **Initial position [X, Y, Z] (m)** parameter must match the value of this port at the start of simulation.

To specify multiple positions at port **Y** along an entire pedestrian path, first define a time series of Y waypoints in MATLAB. Then, feed these waypoints to **Y** by using a From Workspace block. To learn

how to select and specify waypoints, see the “Select Waypoints for Unreal Engine Simulation” example.

X — Longitudinal position of pedestrian
scalar

Longitudinal position of the pedestrian along the *X*-axis of the scene. **X** is in the inertial Z-up coordinate system. Units are in meters.

The *X* value of the **Initial position [X, Y, Z] (m)** parameter must match the value of this port at the start of simulation.

To specify multiple positions at port **X** along an entire pedestrian path, first define a time series of *X* waypoints in MATLAB. Then, feed these waypoints to **X** by using a From Workspace block. To learn how to select and specify waypoints, see the “Select Waypoints for Unreal Engine Simulation” example.

Yaw — Yaw orientation angle of pedestrian
scalar

Yaw orientation angle of the pedestrian along the *Z*-axis of the scene. **Yaw** is in the Z-up coordinate system. Units are in degrees.

The yaw value of the **Initial rotation [Roll, Pitch, Yaw] (deg)** parameter must match the value of this port at the start of simulation.

To specify multiple orientation angles at port **Yaw** along an entire pedestrian path, first define a time series of yaw waypoints in MATLAB. Then, feed these waypoints to **Yaw** by using a From Workspace block. To learn how to select and specify waypoints, see the “Select Waypoints for Unreal Engine Simulation” example.

Output

Location — Location of pedestrian
real-valued 1-by-3 vector

(*X*, *Y*, *Z*) location of the pedestrian in the scene, returned as a real-valued 1-by-3 vector. This location is based on the pedestrian origin, which is on the ground, at the geometric center of the pedestrian. **Location** values are in the inertial Z-up world coordinate system. Units are in meters.

Dependencies

To enable this port, on the **Ground Truth** tab, select **Output location (m) and orientation (rad)**.

Data Types: double

Orientation — Orientation of pedestrian
real-valued 1-by-3 vector

Yaw, pitch, and roll orientation angles of the pedestrian about the *Z*-axis, *Y*-axis, and *X*-axes of the scene, respectively, returned as a real-valued 1-by-3 vector. This orientation is based on the pedestrian origin, which is on the ground, at the geometric center of the pedestrian. **Orientation** values are in the inertial Z-up coordinate system. Units are in radians.

Dependencies

To enable this port, on the **Ground Truth** tab, select **Output location (m) and orientation (rad)**.

Data Types: double

Parameters

Pedestrian Parameters

Type — Type of pedestrian

Male 1 (default) | Male 2 | Male 3 | Female 1 | Female 2 | Female 3 | Child

Type of pedestrian, specified as one of the following options:

- Male 1
- Male 2
- Male 3
- Female 1
- Female 2
- Female 3
- Child

Scale — Scale factor for pedestrian

[1, 1, 1] (default) | real-valued 1-by-3 vector

Scale factor for the pedestrian along the X-axis, Y-axis, and Z-axis.

Initial position [X, Y, Z] (m) — Initial pedestrian position

[0, 0, 0] (default) | real-valued 1-by-3 vector

Initial pedestrian position along the X-axis, Y-axis, and Z-axis of the scene. This position is in the inertial Z-up coordinate system. Units are in meters.

Set the X and Y values of this parameter to match the **X** and **Y** input port values at the start of simulation.

Initial rotation [Roll, Pitch, Yaw] (deg) — Initial angle of pedestrian rotation

[0, 0, 0] (default) | real-valued 1-by-3 vector

Initial angle of pedestrian rotation. The angle of rotation is defined by the roll, pitch, and yaw of the pedestrian. Units are in degrees.

Set the yaw value of this parameter to match the **Yaw** input port value at the start of simulation.

Name — Name of pedestrian

SimulinkPedestrian1 (default) | pedestrian name

Name of pedestrian. By default, when you use the block in your model, the block sets the **Name** parameter to `SimulinkPedestrianX`. The value of X depends on the number of Simulation 3D Pedestrian blocks that you have in your model.

The pedestrian name appears as a selection in the **Parent name** parameter of any Automated Driving Toolbox Simulation 3D sensor blocks within the same model as the pedestrian. With the **Parent name** parameter, you can select the pedestrian on which to mount the sensor.

Sample time — Sample time
-1 (default) | positive scalar

Sample time, T_s , in seconds. The graphics frame rate is the inverse of the sample time.

If you set the sample time to -1, the block uses the sample time specified in the Simulation 3D Scene Configuration block.

Ground Truth

Output location (m) and orientation (rad) — Output location and orientation of pedestrian
off (default) | on

Select this parameter to output the location and orientation of the pedestrian at the **Location** and **Orientation** ports, respectively.

Version History

Introduced in R2022b

References

- [1] Vehicle Dynamics Standards Committee. *Vehicle Dynamics Terminology*. SAE J670. Warrendale, PA: Society of Automotive Engineers, 2008.
- [2] Technical Committee. *Road vehicles — Vehicle dynamics and road-holding ability — Vocabulary*. ISO 8855:2011. Geneva, Switzerland: International Organization for Standardization, 2011.

See Also

Simulation 3D Scene Configuration | Simulation 3D Vehicle with Ground Following

Simulation 3D Bicyclist

Implement bicyclist in 3D environment



Libraries:

Automated Driving Toolbox / Simulation 3D

Description

The Simulation 3D Pedestrian block implements a bicyclist in a 3D simulation environment. The block uses the input (X , Y) position and yaw angle of the bicyclist to adjust the elevation, roll angle, and pitch angle so that the bicyclist follows the ground terrain. The block determines the bicyclist velocity and heading and adjusts the movement to be idle, pedaling, or braking, appropriately. Use this block for automated driving applications.

To use this block, ensure that the Simulation 3D Scene Configuration block is in your model. If you set the **Sample time** parameter of the Simulation 3D Pedestrian block to -1 , the block inherits the sample time specified in the Simulation 3D Scene Configuration block.

The block input uses the bicyclist Z-up right-handed (RH) Cartesian coordinate system defined in SAE J670 [1] and ISO 8855 [2]. The coordinate system is inertial and initially aligned with the bicyclist-ground contact line between the two wheels:

- The X -axis is along the longitudinal axis of the bicyclist and points forward.
- The Y -axis is along the lateral axis of the bicyclist and points to the left.
- The Z -axis points upward.

The yaw, pitch, and roll angles of the Z -axis, Y -axis, and X -axis, respectively, are positive in the clockwise directions, when looking in the positive directions of these axes. Bicyclists are placed in the world coordinate system of the scenes. For more details, see “Coordinate Systems for Unreal Engine Simulation in Automated Driving Toolbox”.

Ports

Input

Y — Lateral position of bicyclist
scalar

Lateral position of the bicyclist along the Y -axis of the scene. **Y** is in the inertial Z-up coordinate system. Units are in meters.

The Y value of the **Initial position [X, Y, Z] (m)** parameter must match the value of this port at the start of simulation.

To specify multiple positions at port **Y** along an entire bicyclist path, first define a time series of Y waypoints in MATLAB. Then, feed these waypoints to **Y** by using a From Workspace block. To learn

how to select and specify waypoints, see the “Select Waypoints for Unreal Engine Simulation” example.

X — Longitudinal position of bicyclist
scalar

Longitudinal position of the bicyclist along the X -axis of the scene. **X** is in the inertial Z -up coordinate system. Units are in meters.

The X value of the **Initial position [X, Y, Z] (m)** parameter must match the value of this port at the start of simulation.

To specify multiple positions at port **X** along an entire bicyclist path, first define a time series of X waypoints in MATLAB. Then, feed these waypoints to **X** by using a From Workspace block. To learn how to select and specify waypoints, see the “Select Waypoints for Unreal Engine Simulation” example.

Yaw — Yaw orientation angle of bicyclist
scalar

Yaw orientation angle of the bicyclist along the Z -axis of the scene. **Yaw** is in the Z -up coordinate system. Units are in degrees.

The yaw value of the **Initial rotation [Roll, Pitch, Yaw] (deg)** parameter must match the value of this port at the start of simulation.

To specify multiple orientation angles at port **Yaw** along an entire bicyclist path, first define a time series of yaw waypoints in MATLAB. Then, feed these waypoints to **Yaw** by using a From Workspace block. To learn how to select and specify waypoints, see the “Select Waypoints for Unreal Engine Simulation” example.

Output

Location — Location of bicyclist
real-valued 1-by-3 vector

(X , Y , Z) location of the bicyclist in the scene, returned as a real-valued 1-by-3 vector. This location is based on the bicyclist origin, which is on the ground, at the geometric center of the bicyclist.

Location values are in the inertial Z -up world coordinate system. Units are in meters.

Dependencies

To enable this port, on the **Ground Truth** tab, select **Output location (m) and orientation (rad)**.

Data Types: double

Orientation — Orientation of bicyclist
real-valued 1-by-3 vector

Yaw, pitch, and roll orientation angles of the bicyclist about the Z -axis, Y -axis, and X -axes of the scene, respectively, returned as a real-valued 1-by-3 vector. This orientation is based on the bicyclist origin, which is on the ground, at the geometric center of the bicyclist. **Orientation** values are in the inertial Z -up coordinate system. Units are in radians.

Dependencies

To enable this port, on the **Ground Truth** tab, select **Output location (m) and orientation (rad)**.

Data Types: double

Parameters

Bicyclist Parameters

Scale — Scale factor for bicyclist

[1, 1, 1] (default) | real-valued 1-by-3 vector

Scale factor for the bicyclist along the *X*-axis, *Y*-axis, and *Z*-axis.

Initial position [X, Y, Z] (m) — Initial bicyclist position

[0, 0, 0] (default) | real-valued 1-by-3 vector

Initial bicyclist position along the *X*-axis, *Y*-axis, and *Z*-axis of the scene. This position is in the inertial *Z*-up coordinate system. Units are in meters.

Set the *X* and *Y* values of this parameter to match the **X** and **Y** input port values at the start of simulation.

Initial rotation [Roll, Pitch, Yaw] (deg) — Initial angle of bicyclist rotation

[0, 0, 0] (default) | real-valued 1-by-3 vector

Initial angle of bicyclist rotation. The angle of rotation is defined by the roll, pitch, and yaw of the bicyclist. Units are in degrees.

Set the yaw value of this parameter to match the **Yaw** input port value at the start of simulation.

Name — Name of bicyclist

SimulinkBicyclist1 (default) | bicyclist name

Name of bicyclist. By default, when you use the block in your model, the block sets the **Name** parameter to `SimulinkBicyclistX`. The value of *X* depends on the number of Simulation 3D Bicyclist blocks that you have in your model.

The bicyclist name appears as a selection in the **Parent name** parameter of any Automated Driving Toolbox Simulation 3D sensor blocks within the same model as the bicyclist. With the **Parent name** parameter, you can select the bicyclist on which to mount the sensor.

Sample time — Sample time

-1 (default) | positive scalar

Sample time, T_s , in seconds. The graphics frame rate is the inverse of the sample time.

If you set the sample time to -1, the block uses the sample time specified in the Simulation 3D Scene Configuration block.

Ground Truth

Output location (m) and orientation (rad) — Output location and orientation of pedestrian

off (default) | on

Select this parameter to output the location and orientation of the pedestrian at the **Location** and **Orientation** ports, respectively.

Version History

Introduced in R2022b

References

- [1] Vehicle Dynamics Standards Committee. *Vehicle Dynamics Terminology*. SAE J670. Warrendale, PA: Society of Automotive Engineers, 2008.
- [2] Technical Committee. *Road vehicles — Vehicle dynamics and road-holding ability — Vocabulary*. ISO 8855:2011. Geneva, Switzerland: International Organization for Standardization, 2011.

See Also

[Simulation 3D Scene Configuration](#) | [Simulation 3D Vehicle with Ground Following](#)

Simulation 3D Ultrasonic Array

Ultrasonic sensor model with tunable acoustic parameters in 3D simulation environment



Libraries:

Automated Driving Toolbox / Simulation 3D
UAV Toolbox / Simulation 3D

Description

The Simulation 3D Ultrasonic Array block generates detections from range measurements taken by an array of ultrasonic sensors with tunable acoustic parameters, mounted on an ego vehicle in a 3D simulation environment. This environment is rendered using the Unreal Engine from Epic Games. The block calculates range measurements based on the distance between the sensor and the closest point on the detected object. The block also provides parameters to control the waveform of the ultrasonic signal used by the sensor to calculate range measurements.

If you set **Sample time** to -1, the block uses the sample time specified in the Simulation 3D Scene Configuration block. To use this sensor, you must include a Simulation 3D Scene Configuration block in your model.

Note The Simulation 3D Scene Configuration block must execute before the Simulation 3D Ultrasonic Array block. That way, the Unreal Engine 3D visualization environment prepares the data before the Simulation 3D Ultrasonic Array block receives it. To check the block execution order, right-click the blocks and select **Properties**. On the **General** tab, confirm these **Priority** settings:

- Simulation 3D Scene Configuration — 0
- Simulation 3D Ultrasonic Array — 1

For more information about execution order, see “How Unreal Engine Simulation for Automated Driving Works”.

Ports

Output

Detections — Object detections

Simulink bus containing MATLAB structure

Object detections, returned as a Simulink bus containing a MATLAB structure. For more details about buses, see “Create Nonvirtual Buses” (Simulink).

You can pass object detections from these sensors and other sensors to a tracker, such as a Multi-Object Tracker block, and generate tracks.

The structure must contain these fields.

Property	Description
Time	Measurement time
Measurement	Distance measurement to the closest object
MeasurementNoise	Measurement noise covariance matrix
SensorIndex	Unique ID of the sensor
ObjectClassID	Object classification
ObjectAttributes	Additional information passed to tracker
MeasurementParameters	Parameters used by initialization functions of nonlinear Kalman tracking filters

This table describes the additional information in the `ObjectAttributes` property.

ObjectAttributes

Attribute	Definition
TargetIndex	Identifier of the actor, <code>ActorID</code> , that generated the detection. For false alarms, this value is negative.
PointOnTarget	Coordinate of the point on the detected object that the sensor used to compute the distance measurement. It is in the vehicle coordinate system. Use this for visualizing detections in the Bird's-Eye Scope app.

For `MeasurementParameters`, the measurements are relative to the parent frame. The parent frame is the ego vehicle body.

MeasurementParameters

Parameter	Definition
Frame	Enumerated type indicating the frame used to report measurements. The Frame is always set to 'spherical' and the detections are reported in spherical coordinates for Ultrasonic Detection Generator.
OriginPosition	3-D vector offset of the sensor origin from the parent frame origin.
OriginVelocity	Velocity of the sensor coordinate system with respect to the parent frame.
IsParentToChild	Logical scalar indicating if Orientation performs a frame rotation from the parent coordinate frame to the child coordinate frame. When IsParentToChild is false, then Orientation performs a frame rotation from the child coordinate frame to the parent coordinate frame.
HasAzimuth	Indicates whether measurements contain azimuth components.
HasRange	Indicates whether measurements contain range components. Always true for Ultrasonic Detection Generator.
HasElevation	Indicates whether measurements contain elevation components. Always false for Ultrasonic Detection Generator.
HasVelocity	Indicates whether measurements contain velocity or range rate components. Always false for Ultrasonic Detection Generator.
FieldOfView	2-D vector containing the azimuth and elevation field of view values of the sensor.

Dependencies

To enable this output port, check the **Use bus output** parameter.

Has object — Flag indicating whether any detectable object is present in the sensor field-of-view
true | false

Flag indicating whether any detectable object is present in the sensor field-of-view, returned as a logical scalar. An object is considered detectable if its closest distance to the sensor is greater than the minimum detection-only range specified in the **Detection Ranges (m)** parameter.

Dependencies

To enable this output port, clear the **Use bus output** parameter.

Has range — Flag indicating whether range measurement is possible for any object present in the sensor field-of-view
true | false

Flag indicating whether range measurement is possible for any object present in the sensor field-of-view, returned as a logical scalar. For any object in the field-of-view, range measurement is possible if its closest distance to the sensor is greater than the minimum-distance range specified in the **Detection Ranges (m)** parameter.

Dependencies

To enable this output port, clear the **Use bus output** parameter.

Range — Distance measurement to the closest object
nonnegative scalar

Distance measurement to the closest object, returned as a nonnegative scalar.

Dependencies

To enable this output port, clear the **Use bus output** parameter.

Parameters

Mounting

Sensor identifier — Unique sensor identifier

1 (default) | positive integer

Specify the unique identifier of the sensor. In a multisensor system, the sensor identifier enables you to distinguish between sensors. When you add a new sensor block to your model, the **Sensor identifier** of that block is $N + 1$, where N is the highest **Sensor identifier** value among the existing sensor blocks in the model.

Example: 2

Parent name — Name of parent vehicle

Scene Origin (default) | vehicle name

Name of the parent to which the sensor is mounted, specified as **Scene Origin** or as the name of a vehicle in your model. The vehicle names that you can select correspond to the **Name** parameters of the simulation 3D vehicle blocks in your model. If you select **Scene Origin**, the block places a sensor at the scene origin.

Example: SimulinkVehicle1

Mounting location — Sensor mounting location



Origin (default) | Front bumper | Rear bumper | Right mirror | Left mirror | Rearview mirror | Hood center | Roof center

Sensor mounting location.

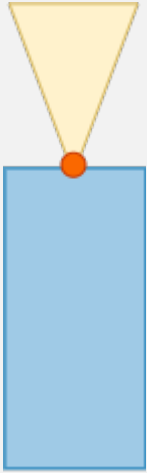
- When **Parent name** is **Scene Origin**, the block mounts the sensor to the origin of the scene. You can set the **Mounting location** to **Origin** only. During simulation, the sensor remains stationary.
- When **Parent name** is the name of a vehicle, the block mounts the sensor to one of the predefined mounting locations described in the table. During simulation, the sensor travels with the vehicle.

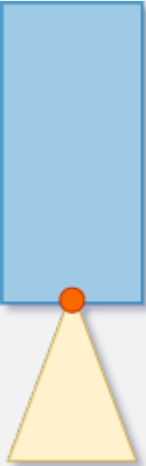
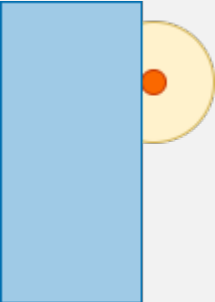
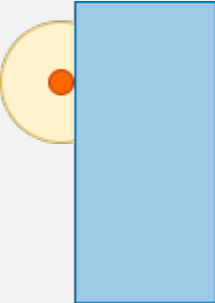
Vehicle Mounting Location	Description	Orientation Relative to Vehicle Origin [Roll, Pitch, Yaw] (deg)
Origin	<p>Forward-facing sensor mounted to the vehicle origin, which is on the ground and at the geometric center of the vehicle (see “Coordinate Systems for Unreal Engine Simulation in Automated Driving Toolbox”)</p> 	[0, 0, 0]
Front bumper	<p>Forward-facing sensor mounted to the front bumper</p> 	[0, 0, 0]

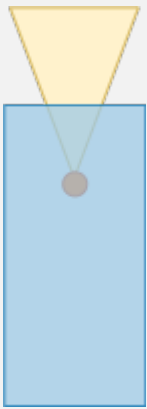
Vehicle Mounting Location	Description	Orientation Relative to Vehicle Origin [Roll, Pitch, Yaw] (deg)
Rear bumper	Backward-facing sensor mounted to the rear bumper 	[0, 0, 180]
Right mirror	Downward-facing sensor mounted to the right side-view mirror 	[0, -90, 0]
Left mirror	Downward-facing sensor mounted to the left side-view mirror 	[0, -90, 0]

Vehicle Mounting Location	Description	Orientation Relative to Vehicle Origin [Roll, Pitch, Yaw] (deg)
Rearview mirror	<p>Forward-facing sensor mounted to the rearview mirror, inside the vehicle</p> 	[0, 0, 0]
Hood center	<p>Forward-facing sensor mounted to the center of the hood</p> 	[0, 0, 0]
Roof center	<p>Forward-facing sensor mounted to the center of the roof</p> 	[0, 0, 0]

Roll, pitch, and yaw are clockwise-positive when looking in the positive direction of the X-axis, Y-axis, and Z-axis, respectively. When looking at a vehicle from above, the yaw angle (the orientation angle) is counterclockwise-positive because you are looking in the negative direction of the axis.

The X-Y-Z mounting location of the sensor relative to the vehicle depends on the vehicle type. To specify the vehicle type, use the **Type** parameter of the Simulation 3D Vehicle with Ground Following block to which you mount the sensor. To obtain the X-Y-Z mounting locations for a vehicle type, see the reference page for that vehicle.

To determine the location of the sensor in world coordinates, open the sensor block. Then, on the **Ground Truth** tab, select the **Output location (m) and orientation (rad)** parameter and inspect the data from the **Location** output port.

Specify offset — Specify offset from mounting location
off (default) | on

Select this parameter to specify an offset from the mounting location by using the **Relative translation [X, Y, Z] (m)** and **Relative rotation [Roll, Pitch, Yaw] (deg)** parameters.

Relative translation [X, Y, Z] (m) — Translation offset relative to mounting location

[0, 0, 0] (default) | real-valued 1-by-3 vector

Translation offset relative to the mounting location of the sensor, specified as a real-valued 1-by-3 vector of the form [X, Y, Z]. Units are in meters.

If you mount the sensor to a vehicle by setting **Parent name** to the name of that vehicle, then X, Y, and Z are in the vehicle coordinate system, where:

- The X-axis points forward from the vehicle.
- The Y-axis points to the left of the vehicle, as viewed when looking in the forward direction of the vehicle.
- The Z-axis points up.

The origin is the mounting location specified in the **Mounting location** parameter. This origin is different from the vehicle origin, which is the geometric center of the vehicle.

If you mount the sensor to the scene origin by setting **Parent name** to Scene Origin, then X, Y, and Z are in the world coordinates of the scene.

For more details about the vehicle and world coordinate systems, see “Coordinate Systems for Unreal Engine Simulation in Automated Driving Toolbox”.

Example: [0, 0, 0.01]

Dependencies

To enable this parameter, select **Specify offset**.

Relative rotation [Roll, Pitch, Yaw] (deg) — Rotational offset relative to mounting location
[0, 0, 0] (default) | real-valued 1-by-3 vector

Rotational offset relative to the mounting location of the sensor, specified as a real-valued 1-by-3 vector of the form [Roll, Pitch, Yaw]. Roll, pitch, and yaw are the angles of rotation about the X-, Y-, and Z-axes, respectively. Units are in degrees.

If you mount the sensor to a vehicle by setting **Parent name** to the name of that vehicle, then *X*, *Y*, and *Z* are in the vehicle coordinate system, where:

- The *X*-axis points forward from the vehicle.
- The *Y*-axis points to the left of the vehicle, as viewed when looking in the forward direction of the vehicle.
- The *Z*-axis points up.
- Roll, pitch, and yaw are clockwise-positive when looking in the forward direction of the *X*-axis, *Y*-axis, and *Z*-axis, respectively. If you view a scene from a 2D top-down perspective, then the yaw angle (also called the orientation angle) is counterclockwise-positive because you are viewing the scene in the negative direction of the *Z*-axis.

The origin is the mounting location specified in the **Mounting location** parameter. This origin is different from the vehicle origin, which is the geometric center of the vehicle.

If you mount the sensor to the scene origin by setting **Parent name** to `Scene Origin`, then *X*, *Y*, and *Z* are in the world coordinates of the scene.

For more details about the vehicle and world coordinate systems, see “Coordinate Systems for Unreal Engine Simulation in Automated Driving Toolbox”.

Example: `[0, 0, 10]`

Dependencies

To enable this parameter, select **Specify offset**.

Sample time — Sample time

-1 (default) | positive scalar

Sample time of the block, in seconds, specified as a positive scalar. The 3D simulation environment frame rate is the inverse of the sample time.

If you set the sample time to -1, the block inherits its sample time from the Simulation 3D Scene Configuration block.

Sensor Parameters

Intrinsic parameters

Relative mounting locations (m) — Relative mounting locations of individual sensors in the ultrasonic array

`[[0, -0.67, 0]; [0, -0.22, 0]; [0, 0.22, 0]; [0, 0.67, 0]]` (default) | real-valued *N*-by-3 array

Relative mounting locations of individual sensors in the ultrasonic array, specified as a real-valued *N*-by-3 array. *N* is the number of sensors in the ultrasonic array and the locations are relative to the sensor mounting position specified by the **Mounting Location** parameter. Each row of the array must be a 1-by-3 vector of the form `[X, Y, Z]`. Units are in meters.

Relative mounting rotations (deg) — Relative mounting rotations of individual sensors in the ultrasonic array

`zeros(4, 3)` (default) | real-valued *N*-by-3 array

Relative mounting rotations of individual sensors in the ultrasonic array, specified as a real-valued N -by-3 array. N is the number of sensors in the ultrasonic array and the rotations are relative to the sensor mounting orientation specified by the `Mounting Location` parameter. Each row of the array must be a 1-by-3 vector of the form $[roll, pitch, yaw]$. Units are in degrees.

Horizontal Field of view (deg) — Horizontal field of view of ultrasonic array
70 (default) | positive real scalar

Horizontal field of view of ultrasonic array, specified as a positive real scalar. This field of view defines the total angular extent spanned by all sensors of the ultrasonic array in the horizontal direction relative to their orientations. You must specify the horizontal field of view `horizontalFOV` in the range (0, 360]. Units are in degrees.

Vertical Field of view (deg) — Vertical field of view of ultrasonic array
35 (default) | positive real scalar

Vertical field of view of ultrasonic array, specified as a positive real scalar. This field of view defines the total angular extent spanned by all sensors of the ultrasonic array in the vertical direction relative to their orientations. You must specify the vertical field of view in the range (0, 180]. Units are in degrees.

Detection ranges (m) — Detection range vector of ultrasonic array (m)
[0.03 0.15 5.5] (default) | 1-by-3 nonnegative real-valued vector of form $[\text{minDetOnlyRange} \text{minDistRange} \text{maxDistRange}]$

Detection range vector of the ultrasonic array, specified as a 1-by-3 nonnegative real-valued vector of the form $[\text{minDetOnlyRange} \text{minDistRange} \text{maxDistRange}]$, where $\text{minDetOnlyRange} < \text{minDistRange} < \text{maxDistRange}$. Units are in meters. These values determine the detections and distance values returned by the ultrasonic array.

- When the detected object is at a distance between `minDistRange` and `maxDistRange`, the sensor returns a positive distance value.
- When the detected object is at a distance between `minDetOnlyRange` and `minDistRange`, the sensor detects the object, but cannot determine the distance and returns a value of 0.
- When the object is at a distance below `minDetOnlyRange` or above `maxDistRange`, the sensor returns an empty cell array.

Signal parameters

Acoustic frequency (kHz) — Frequency of sound waves used by all sensor emitters in ultrasonic array
50 (default) | positive real scalar

Frequency of sound waves used by all sensor emitters in the ultrasonic array, specified as a positive real scalar. Units are in kHz.

Sampling frequency (kHz) — Sampling frequency of all sensor receivers in ultrasonic array
500 (default) | positive real scalar

Sampling frequency of all sensor receivers in the ultrasonic array, specified as a positive real scalar. To sample a signal of a given frequency, the sampling frequency of the receiver must be at least two times that frequency. Units are in kHz.

Pulse width (s) — Pulse width of ultrasonic waves used by all sensors in ultrasonic array
1e-6 (default) | positive real scalar

Pulse width of the ultrasonic waves used by all sensors in the ultrasonic array, specified as a positive real scalar.

Gain — Vector gain for sound signal used by sensors in ultrasonic array
[1, 0] (default) | real-valued scalar | real-valued 1-by-2 vector

Vector gain for the sound signal used by the sensors in ultrasonic array, real-valued scalar or a 1-by-2 vector of the form [a, b]. The blocks multiplies the scalar gain as a constant, and the vector gain as a time signal of the form $a + b*t$ with the ultrasonic signal.

Sound speed (m/s) — Speed of sound in environment
330 (default) | positive real scalar

Speed of sound in the environment, specified as a positive real scalar. Units are in m/s.

Use bus output — Select to output signals together as bus signal
on (default) | off

Select to output detections as a bus signal using the **Detections** port. Clear **Use bus output** to instead enable the **Has object**, **Has range**, and **Range** output ports.

Version History

Introduced in R2023a

See Also

Simulation 3D Scene Configuration | Simulation 3D Vehicle with Ground Following | Simulation 3D Ultrasonic Sensor | Simulation 3D Camera | Simulation 3D Probabilistic Radar | Simulation 3D Vision Detection Generator

Vehicle To World

Convert actors from ego vehicle coordinates to world coordinates

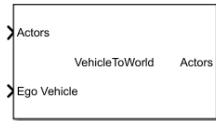

Libraries:

Automated Driving Toolbox / Driving Scenario and Sensor Modeling

Description

The Vehicle To World block converts actor poses from the vehicle coordinates of the input ego vehicle to world coordinates. Use this block to convert non-ego actor poses output by the Scenario Reader block into world coordinates for use with the 3D simulation environment. Before using these output poses to specify vehicle positions in the 3D environment, first convert them from the cuboid to the 3D simulation world coordinate system by using a Cuboid To 3D Simulation block. For an example of this workflow, see the “Visualize Sensor Data from Unreal Engine Simulation Environment” example.

Ports

Input

Actors — Actor poses in vehicle coordinates

Simulink bus containing MATLAB structure

Actor poses in vehicle coordinates, specified as a Simulink bus containing a MATLAB structure.

The structure must contain these fields.

Field	Description	Type
NumActors	Number of actors	Nonnegative integer
Time	Current simulation time	Real-valued scalar
Actors	Actor poses	NumActors-length array of actor pose structures

Each actor pose structure in **Actors** must contain these fields.

Field	Description
ActorID	Scenario-defined actor identifier, specified as a positive integer.
Position	Position of actor, specified as a real-valued vector of the form $[x \ y \ z]$. Units are in meters.
Velocity	Velocity (v) of actor in the x - y -, and z -directions, specified as a real-valued vector of the form $[v_x \ v_y \ v_z]$. Units are in meters per second.

Field	Description
Roll	Roll angle of actor, specified as a real-valued scalar. Units are in degrees.
Pitch	Pitch angle of actor, specified as a real-valued scalar. Units are in degrees.
Yaw	Yaw angle of actor, specified as a real-valued scalar. Units are in degrees.
AngularVelocity	Angular velocity (ω) of actor in the x-, y-, and z-directions, specified as a real-valued vector of the form $[\omega_x \ \omega_y \ \omega_z]$. Units are in degrees per second.

Ego Vehicle — Ego vehicle pose

Simulink bus containing MATLAB structure

Ego vehicle pose, specified as a Simulink bus containing a MATLAB structure.

The structure must contain these fields.

Field	Description
ActorID	Scenario-defined actor identifier, specified as a positive integer.
Position	Position of actor, specified as a real-valued vector of the form $[x \ y \ z]$. Units are in meters.
Velocity	Velocity (v) of actor in the x- y-, and z-directions, specified as a real-valued vector of the form $[v_x \ v_y \ v_z]$. Units are in meters per second.
Roll	Roll angle of actor, specified as a real-valued scalar. Units are in degrees.
Pitch	Pitch angle of actor, specified as a real-valued scalar. Units are in degrees.
Yaw	Yaw angle of actor, specified as a real-valued scalar. Units are in degrees.
AngularVelocity	Angular velocity (ω) of actor in the x-, y-, and z-directions, specified as a real-valued vector of the form $[\omega_x \ \omega_y \ \omega_z]$. Units are in degrees per second.

Output

Actors — Actor poses in world coordinates

Simulink bus containing MATLAB structure

Actor poses in world coordinates, returned as a Simulink bus containing a MATLAB structure.

The structure has these fields.

Field	Description	Type
NumActors	Number of actors	Nonnegative integer

Field	Description	Type
Time	Current simulation time	Real-valued scalar
Actors	Actor poses	NumActors-length array of actor pose structures

Each actor pose structure in **Actors** has these fields.

Field	Description
ActorID	Scenario-defined actor identifier, specified as a positive integer.
Position	Position of actor, specified as a real-valued vector of the form $[x \ y \ z]$. Units are in meters.
Velocity	Velocity (v) of actor in the x - y -, and z -directions, specified as a real-valued vector of the form $[v_x \ v_y \ v_z]$. Units are in meters per second.
Roll	Roll angle of actor, specified as a real-valued scalar. Units are in degrees.
Pitch	Pitch angle of actor, specified as a real-valued scalar. Units are in degrees.
Yaw	Yaw angle of actor, specified as a real-valued scalar. Units are in degrees.
AngularVelocity	Angular velocity (ω) of actor in the x -, y -, and z -directions, specified as a real-valued vector of the form $[\omega_x \ \omega_y \ \omega_z]$. Units are in degrees per second.

Parameters

Source of actors bus name — Source of name for actor poses bus

Auto (default) | Property

Source of the name for the actor poses bus returned in the **Actors** output port, specified as one of these options:

- Auto — The block automatically creates an actor poses bus name.
- Property — Specify the actor poses bus name by using the **Actors bus name** parameter.

Actors bus name — Name of actor poses bus

valid bus name

Name of the actor poses bus returned in the **Actors** output port, specified as a valid bus name.

Dependencies

To enable this parameter, set **Source of actors bus name** to Property.

Simulate using — Type of simulation to run

Interpreted execution (default) | Code generation

- **Interpreted execution** — Simulate the model using the MATLAB interpreter. This option shortens startup time. In **Interpreted execution** mode, you can debug the source code of the block.
- **Code generation** — Simulate the model using generated C/C++ code. The first time you run a simulation, Simulink generates C/C++ code for the block. The C code is reused for subsequent simulations as long as the model does not change. This option requires additional startup time.

Version History

Introduced in R2020a

Extended Capabilities

C/C++ Code Generation

Generate C and C++ code using Simulink® Coder™.

See Also

Scenario Reader | World To Vehicle | Cuboid To 3D Simulation

Topics

“Coordinate Systems in Automated Driving Toolbox”

“Coordinate Systems for Unreal Engine Simulation in Automated Driving Toolbox”

Velocity Profiler

Generate velocity profile of vehicle path given kinematic constraints

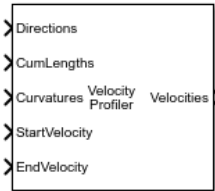

Libraries:
Automated Driving Toolbox

Description

The Velocity Profiler block generates a velocity profile of a driving path that satisfies this set of specified kinematic constraints:

- The maximum allowable speed of the vehicle
- The maximum longitudinal acceleration and deceleration of the vehicle
- The maximum longitudinal jerk on page 2-276 of the vehicle
- The maximum lateral acceleration on page 2-276 of the vehicle

Specify the cumulative lengths along the path and the driving directions and curvatures at each point along the path. You can obtain these values from the output of a Path Smoother Spline block. Also specify the longitudinal velocity of the vehicle at the start and end of the path.

Use the generated velocity profile as the input reference velocities of a longitudinal controller, as shown in the “Automated Parking Valet in Simulink” example.

Ports

Input

Directions — Driving directions along path

M -by-1 vector of 1s (forward motion) and -1s (reverse motion)

Driving directions of the vehicle along the length of the path, specified as an M -by-1 vector of 1s (forward motion) and -1s (reverse motion). Each vector element represents the driving direction of the vehicle at the corresponding cumulative path length specified by the **CumLengths** input port. M is the number of driving directions and must be equal to the lengths of the **CumLengths** and **Curvatures** inputs.

You can obtain **Directions** from the output of a Path Smoother Spline block.

CumLengths — Cumulative path lengths

M -by-1 vector of monotonically increasing real-valued elements

Cumulative path lengths, in meters, specified as an M -by-1 vector of monotonically increasing real-valued elements. Each vector element represents a point along the path. M is the number of cumulative path lengths and must be equal to the lengths of the **Directions** and **Curvatures** inputs.

You can obtain **CumLengths** from the output of a Path Smoother Spline block.

Curvatures — Signed path curvatures along path

M-by-1 real-valued vector

Signed path curvatures along the length of the path, in radians per meter, specified as an *M*-by-1 real-valued vector. Each vector element represents the curvature of the path at the corresponding cumulative path length specified by the **CumLengths** input port. *M* is the number of curvatures and must be equal to the lengths of the **Directions** and **CumLengths** inputs.

You can obtain **Curvatures** from the output of a Path Smoother Spline block.

StartVelocity — Longitudinal velocity of vehicle at start of path

real scalar

Longitudinal velocity of the vehicle at the start of the path, in meters per second, specified as a real scalar.

EndVelocity — Longitudinal velocity of vehicle at end of path

real scalar

Longitudinal velocity of the vehicle at the end of the path, in meters per second, specified as a real scalar.

Output

Velocities — Velocity profile along path

M-by-1 real-valued vector

Velocity profile along the length of the path, in meters per second, returned as an *M*-by-1 real-valued column vector. Each vector element represents a reference longitudinal velocity for the vehicle at the corresponding cumulative path length specified by the **CumLengths** input port. *M* is the number of velocities and is equal to the length of **CumLengths**.

The output velocity values satisfy the speed, acceleration, and jerk constraints specified in the parameters of the Velocity Profiler block. You can use this output as the reference velocity for a vehicle controller.

Velocities is a variable-size output with the limitations described in “Variable-Size Signal Limitations” (Simulink).

Times — Vehicle times of arrival for velocity profile

M-by-1 real-valued vector

Vehicle times of arrival for the velocity profile specified in **Velocities**, returned as an *M*-by-1 real-valued vector. *M* is the number of vehicle times of arrival and is equal to the length of **Velocities**. Units are in seconds.

Each vector element represents the time that a vehicle traveling at velocity *v* arrives at cumulative path length *p*, where:

- *v* is the corresponding velocity returned by the **Velocities** output port.
- *p* is the corresponding cumulative path length specified by the **CumLengths** input port.

Use **Times** to visualize the velocity profile over time, as shown in the “Velocity Profile of Straight Path” and “Velocity Profile of Path with Curve and Direction Change” examples.

Times is a variable-size output with the limitations described in “Variable-Size Signal Limitations” (Simulink).

Dependencies

To enable this port, select the **Show Times output port** parameter.

Parameters

Maximum longitudinal acceleration (m/s²) — Maximum longitudinal acceleration of vehicle

3 (default) | positive real scalar

Maximum longitudinal acceleration of the vehicle, in meters per second squared, specified as a positive real scalar.

When developing a longitudinal controller, this parameter must be equal to the corresponding parameter in the Longitudinal Controller Stanley block. Otherwise, the vehicle is unable to run the generated velocity profile.

Maximum longitudinal deceleration (m/s²) — Maximum longitudinal deceleration of vehicle

6 (default) | positive real scalar

Maximum longitudinal deceleration of the vehicle, in meters per second squared, specified as a positive real scalar.

When developing a longitudinal controller, this parameter must be equal to the corresponding parameter in the Longitudinal Controller Stanley block. Otherwise, the vehicle is unable to run the generated velocity profile.

Maximum allowable speed (m/s) — Maximum allowable speed along path

10 (default) | positive real scalar

Maximum allowable speed of the vehicle along the path, in meters per second, specified as a positive real scalar. Use this parameter to constrain the speed of the vehicle based on passenger comfort or speed limit requirements.

When the path length is too short for the vehicle to reach this maximum speed, the block calculates a smaller maximum speed that satisfies the path length constraint.

In the output velocity profile, the speed of the vehicle is constrained to $[-V_{\max}, V_{\max}]$, where V_{\max} is the value of this parameter.

Maximum longitudinal jerk (m/s³) — Maximum longitudinal jerk

1 (default) | positive real scalar

Maximum longitudinal jerk of the vehicle along the path, in meters per second cubed, specified as a positive real scalar.

In the output velocity profile, the longitudinal jerk of the vehicle is constrained to $[-J_{\max}, J_{\max}]$, where J_{\max} is the value of this parameter.

Maximum lateral acceleration (m/s²) — Maximum lateral acceleration

1 (default) | positive real scalar

Maximum lateral acceleration of the vehicle along the path, in meters per second squared, specified as a positive real scalar.

In the output velocity profile, the lateral acceleration of the vehicle is constrained to $[-A_{\max}, A_{\max}]$, where A_{\max} is the value of this parameter.

Show Times output port — Output times of arrival for velocity profile

off (default) | on

Select this parameter to enable the **Times** output port.

Sample time — Sample time of block

-1 (default) | positive real scalar

Sample time of the block, in seconds, specified as -1 or as a positive real scalar. The default of -1 means that the block inherits its sample time from upstream blocks.

Because the Velocity Profiler block outputs variable-size signals, the sample time of the block must be discrete (nonzero). If the block inherits its sample time from upstream blocks, those blocks must also have discrete sample times.

Simulate using — Type of simulation to run

Code Generation (default) | Interpreted Execution

- **Code generation** — Simulate the model using generated C/C++ code. The first time you run a simulation, Simulink generates C/C++ code for the block. The C code is reused for subsequent simulations as long as the model does not change. This option requires additional startup time.
- **Interpreted execution** — Simulate the model using the MATLAB interpreter. This option shortens startup time. In **Interpreted execution** mode, you can debug the source code of the block.

More About

Jerk

Jerk is the rate of change of acceleration in a vehicle. Jerk minimization is a key comfort requirement for vehicle passengers. Rapid changes in acceleration or deceleration result in a "jerky" ride for passengers. Jerk is measured in units of meters per second cubed.

Lateral Acceleration

Lateral acceleration is defined as $a_{\text{lat}} = v^2\kappa$, where:

- v is the longitudinal velocity of the vehicle.
- κ is the curvature of the path. Units are in radians per meter.

Lateral acceleration is measured in units of meters per second squared.

Algorithms

To generate the velocity profile for a reference path, the Velocity Profiler block performs these steps:

- 1 Generate a continuous velocity profile that satisfies all kinematic constraints (speed, acceleration, and jerk) specified by the block parameters.
- 2 Discretize the velocity profile by mapping poses in the reference path to velocity values, based on how far away the poses are from the starting pose. The cumulative path lengths specified in the **CumLengths** input port contain these distances. The Path Smoother Spline block returns these cumulative path lengths, along with the smooth path.

The generated velocity profile is a seven-interval curve. At each time interval within the curve, the jerk, acceleration, and velocity of the vehicle change to satisfy the specified constraints. The figure and table show how these values change for a vehicle traveling in forward motion along a path. For simplicity, the starting and ending velocity of the vehicle, as specified by the **StartVelocity** and **EndVelocity** input ports, are both 0 .

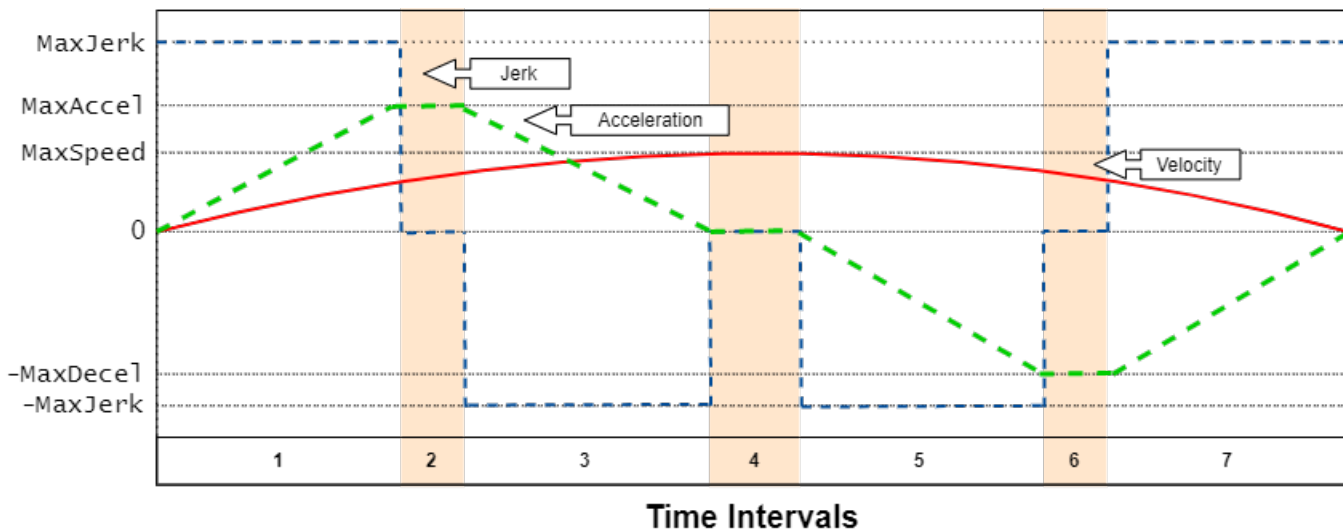

Time Interval	Jerk	Acceleration	Velocity	Notes
1	Set to MaxJerk	Increases from 0 to MaxAccel	Increases from starting velocity	-

Time Interval	Jerk	Acceleration	Velocity	Notes
2	Set to 0	Held constant at MaxAccel	Keeps increasing	During the previous interval, if the vehicle cannot reach MaxAccel given the MaxSpeed constraint, then interval 2 does not occur.
3	Set to -MaxJerk	Decreases from MaxAccel to 0	Increases to MaxSpeed	-
4	Set to 0	Held constant at 0	Held constant at MaxSpeed	-
5	Set to -MaxJerk	Decreases from 0 to -MaxDecel	Starts decreasing	-
6	Set to 0	Held constant at -MaxDecel	Keeps decreasing	During the previous interval, if the vehicle cannot reach -MaxDecel given the MaxSpeed constraint, then interval 6 does not occur.
7	Set to MaxJerk	Increases from -MaxDecel to 0	Decreases to ending velocity	-

In the figure and table:

- MaxJerk and -MaxJerk are set by the **Maximum longitudinal jerk (m/s³)** parameter.
- MaxAccel and -MaxDecel are set by the **Maximum longitudinal acceleration (m/s²)** and **Maximum longitudinal deceleration (m/s²)** parameters, respectively. You can specify asymmetric values for these parameters.
- MaxSpeed is set by the **Maximum allowable speed (m/s)** parameter.

For a vehicle in reverse motion, the curves in the figure are reversed. The signs of the parameter values shown in the figure and table are also reversed.

If the vehicle includes multiple changes in direction, the block generates separate velocity profiles for each driving direction. Then the block concatenates these profiles in the final **Velocities** output. For an example, see “Velocity Profile of Path with Curve and Direction Change”.

Version History

Introduced in R2019b

References

- [1] Villagra, Jorge, Vicente Milanés, Joshué Pérez, and Jorge Godoy. "Smooth path and speed planning for an automated public transport vehicle." *Robotics and Autonomous Systems*. Vol. 60, Number 2, February 2012, pp. 252-265.

Extended Capabilities

C/C++ Code Generation

Generate C and C++ code using Simulink® Coder™.

See Also

Path Smoother Spline | Lateral Controller Stanley | Longitudinal Controller Stanley

Vision Detection Generator

Detect objects and lanes from visual measurements

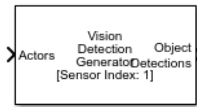

Libraries:

Automated Driving Toolbox / Driving Scenario and Sensor Modeling

Description

The Vision Detection Generator block generates detections from camera measurements taken by a vision sensor mounted on an ego vehicle.

The block derives detections from simulated actor poses and generates these detections at intervals equal to the sensor update interval. By default, detections are referenced to the coordinate system of the ego vehicle. The block can simulate real detections with added random noise and also generate false positive detections. A statistical model generates the measurement noise, true detections, and false positives. To control the random numbers that the statistical model generates, use the random number generator settings on the **Measurements** tab of the block.

You can use the Vision Detection Generator to create input to a Multi-Object Tracker block. When building scenarios and sensor models using the **Driving Scenario Designer** app, the camera sensors exported to Simulink are output as Vision Detection Generator blocks.

Ports

Input

Actors — Scenario actor poses

Simulink bus containing MATLAB structure

Scenario actor poses in ego vehicle coordinates, specified as a Simulink bus containing a MATLAB structure.

The structure must contain these fields.

Field	Description	Type
NumActors	Number of actors	Nonnegative integer
Time	Current simulation time	Real-valued scalar
Actors	Actor poses	NumActors-length array of actor pose structures

Each actor pose structure in `Actors` must have these fields.

Field	Description
ActorID	Scenario-defined actor identifier, specified as a positive integer.

Field	Description
Position	Position of actor, specified as a real-valued vector of the form $[x \ y \ z]$. Units are in meters.
Velocity	Velocity (v) of actor in the x - y -, and z -directions, specified as a real-valued vector of the form $[v_x \ v_y \ v_z]$. Units are in meters per second.
Roll	Roll angle of actor, specified as a real-valued scalar. Units are in degrees.
Pitch	Pitch angle of actor, specified as a real-valued scalar. Units are in degrees.
Yaw	Yaw angle of actor, specified as a real-valued scalar. Units are in degrees.
AngularVelocity	Angular velocity (ω) of actor in the x -, y -, and z -directions, specified as a real-valued vector of the form $[\omega_x \ \omega_y \ \omega_z]$. Units are in degrees per second.

Dependencies

To enable this input port, set the **Types of detections generated by sensor** parameter to Objects only, Lanes with occlusion, or Lanes and objects.

Lane Boundaries — Lane boundaries

Simulink bus containing MATLAB structure

Lane boundaries in ego vehicle coordinates, specified as a Simulink bus containing a MATLAB structure.

The structure must contain these fields.

Field	Description	Type
NumLaneBoundaries	Number of lane boundaries	Nonnegative integer
Time	Current simulation time	Real scalar
LaneBoundaries	Lane boundaries starting from the leftmost lane with respect to the ego vehicle.	NumLaneBoundaries-length array of lane boundary structures

Each lane boundary structure in `LaneBoundaries` must have these fields.

Field	Description
-------	-------------

Coordinates	<p>Lane boundary coordinates, specified as a real-valued N-by-3 matrix, where N is the number of lane boundary coordinates. Lane boundary coordinates define the position of points on the boundary at specified longitudinal distances away from the ego vehicle, along the center of the road.</p> <ul style="list-style-type: none"> • In MATLAB, specify these distances by using the 'XDistance' name-value pair argument of the laneBoundaries function. • In Simulink, specify these distances by using the Distances from ego vehicle for computing boundaries (m) parameter of the Scenario Reader block or the Distance from parent for computing lane boundaries parameter of the Simulation 3D Vision Detection Generator block. <p>This matrix also includes the boundary coordinates at zero distance from the ego vehicle. These coordinates are to the left and right of the ego-vehicle origin, which is located under the center of the rear axle. Units are in meters.</p>
Curvature	<p>Lane boundary curvature at each row of the Coordinates matrix, specified as a real-valued N-by-1 vector. N is the number of lane boundary coordinates. Units are in radians per meter.</p>
CurvatureDerivative	<p>Derivative of lane boundary curvature at each row of the Coordinates matrix, specified as a real-valued N-by-1 vector. N is the number of lane boundary coordinates. Units are in radians per square meter.</p>
HeadingAngle	<p>Initial lane boundary heading angle, specified as a real scalar. The heading angle of the lane boundary is relative to the ego vehicle heading. Units are in degrees.</p>

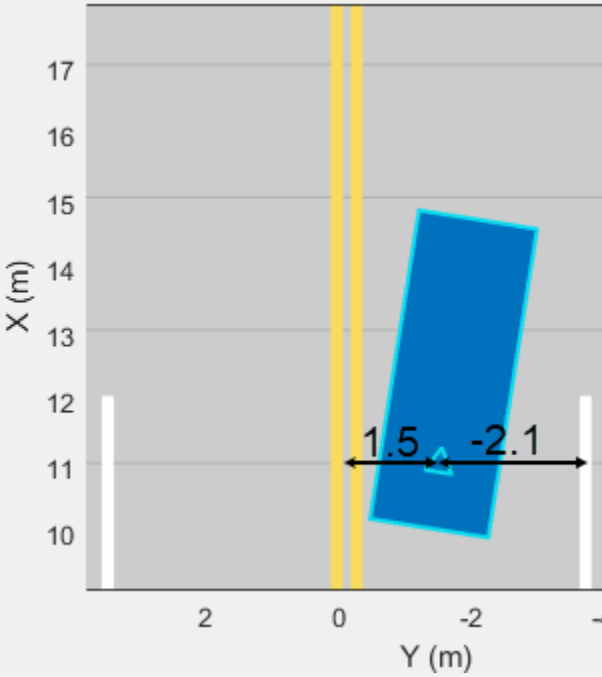
LateralOffset	<p>Lateral offset of the ego vehicle position from the lane boundary, specified as a real scalar. An offset to a lane boundary to the left of the ego vehicle is positive. An offset to the right of the ego vehicle is negative. Units are in meters. In this image, the ego vehicle is offset 1.5 meters from the left lane and 2.1 meters from the right lane.</p> 
BoundaryType	<p>Type of lane boundary marking, specified as one of these values:</p> <ul style="list-style-type: none"> • 'Unmarked' — No physical lane marker exists • 'Solid' — Single unbroken line • 'Dashed' — Single line of dashed lane markers • 'DoubleSolid' — Two unbroken lines • 'DoubleDashed' — Two dashed lines • 'SolidDashed' — Solid line on the left and a dashed line on the right • 'DashedSolid' — Dashed line on the left and a solid line on the right

Strength	Saturation strength of the lane boundary marking, specified as a real scalar from 0 to 1. A value of 0 corresponds to a marking whose color is fully unsaturated. The marking is gray. A value of 1 corresponds to a marking whose color is fully saturated.
Width	Lane boundary width, specified as a positive real scalar. In a double-line lane marker, the same width is used for both lines and for the space between lines. Units are in meters.
Length	Length of dash in dashed lines, specified as a positive real scalar. In a double-line lane marker, the same length is used for both lines.
Space	Length of space between dashes in dashed lines, specified as a positive real scalar. In a dashed double-line lane marker, the same space is used for both lines.

Dependencies

To enable this input port, set the **Types of detections generated by sensor** parameter to Lanes only, Lanes only, Lanes with occlusion, or Lanes and objects.

Output

Object Detections — Object detections

Simulink bus containing MATLAB structure

Object detections, returned as a Simulink bus containing a MATLAB structure. For more details about buses, see “Create Nonvirtual Buses” (Simulink).

You can pass object detections from these sensors and other sensors to a tracker, such as a Multi-Object Tracker block, and generate tracks.

The detections structure has this form:

Field	Description	Type
NumDetections	Number of detections	Integer
IsValidTime	False when updates are requested at times that are between block invocation intervals	Boolean
Detections	Object detections	Array of object detection structures of length set by the Maximum number of reported detections parameter. Only NumDetections of these detections are actual detections.

The object detection structure contains these properties.

Property	Definition
Time	Measurement time
Measurement	Object measurements
MeasurementNoise	Measurement noise covariance matrix
SensorIndex	Unique ID of the sensor
ObjectClassID	Object classification
MeasurementParameters	Parameters used by initialization functions of nonlinear Kalman tracking filters
ObjectAttributes	Additional information passed to tracker

The **Measurement** field reports the position and velocity of a measurement in the coordinate system specified by **Coordinate system used to report detections**. This field is a real-valued column vector of the form $[x; y; z; vx; vy; vz]$. Units are in meters per second.

The **MeasurementNoise** field is a 6-by-6 matrix that reports the measurement noise covariance for each coordinate in the **Measurement** field.

The **MeasurementParameters** field is a structure with these fields.

Parameter	Definition
Frame	Enumerated type indicating the frame used to report measurements. The Vision Detection Generator block reports detections in either ego and sensor Cartesian coordinates, which are both rectangular coordinate frames. Therefore, for this block, Frame is always set to 'rectangular'.
OriginPosition	3-D vector offset of the sensor origin from the ego vehicle origin. The vector is derived from the Sensor's (x,y) position (m) and Sensor's height (m) parameters of the block.
Orientation	Orientation of the vision sensor coordinate system with respect to the ego vehicle coordinate system. The orientation is derived from the Yaw angle of sensor mounted on ego vehicle (deg) , Pitch angle of sensor mounted on ego vehicle (deg) , and Roll angle of sensor mounted on ego vehicle (deg) parameters of the block.
HasVelocity	Indicates whether measurements contain velocity.

The **ObjectAttributes** property of each detection is a structure with these fields.

Field	Definition
TargetIndex	Identifier of the actor, ActorID, that generated the detection. For false alarms, this value is negative.

Dependencies

To enable this output port, set the **Types of detections generated by sensor** parameter to `Objects only`, `Lanes with occlusion`, or `Lanes and objects`.

Lane Detections — Lane boundary detections

Simulink bus containing MATLAB structure

Lane boundary detections, returned as a Simulink bus containing a MATLAB structure. The structure had these fields:

Field	Description	Type
Time	Lane detection time	Real scalar
IsValidTime	False when updates are requested at times that are between block invocation intervals	Boolean
SensorIndex	Unique identifier of sensor	Positive integer
NumLaneBoundaries	Number of lane boundary detections	Nonnegative integer
LaneBoundaries	Lane boundary detections	Array of <code>clothoidLaneBoundary</code> objects

Dependencies

To enable this output port, set the **Types of detections generated by sensor** parameter to `Lanes only`, `Lanes with occlusion`, or `Lanes and objects`.

Parameters

Parameters

Sensor Identification

Unique identifier of sensor — Unique sensor identifier

1 (default) | positive integer

Unique sensor identifier, specified as a positive integer. The sensor identifier distinguishes detections that come from different sensors in a multisensor system. If a model contains multiple sensor blocks with the same sensor identifier, the **Bird's-Eye Scope** displays an error.

Example: 5

Types of detections generated by sensor — Select the types of detections

`Objects only` (default) | `Lanes only` | `Lanes with occlusion` | `Lanes and objects`

Types of detections generated by the sensor, specified as `Objects only`, `Lanes only`, `Lanes with occlusion`, or `Lanes and objects`.

- When set to **Objects only**, no road information is used to occlude actors.
- When set to **Lanes only**, no actor information is used to detect lanes.
- When set to **Lanes with occlusion**, actors in the camera field of view can impair the sensor ability to detect lanes.
- When set to **Lanes and objects**, the sensor generates object both object detections and occluded lane detections.

Required interval between sensor updates (s) — Required time interval

0.1 (default) | positive real scalar

Required time interval between sensor updates, specified as a positive real scalar. The value of this parameter must be an integer multiple of the **Actors** input port data interval. Updates requested from the sensor between update intervals contain no detections. Units are in seconds.

Required interval between lane detections updates (s) — Time interval between lane detection updates

0.1 (default) | positive real scalar

Required time interval between lane detection updates, specified as a positive real scalar. The vision detection generator is called at regular time intervals. The vision detector generates new lane detections at intervals defined by this parameter which must be an integer multiple of the simulation time interval. Updates requested from the sensor between update intervals contain no lane detections. Units are in seconds.

Sensor Extrinsic

Sensor's (x,y) position (m) — Location of the vision sensor center

[3.4 0] (default) | real-valued 1-by-2 vector

Location of the vision sensor center, specified as a real-valued 1-by-2 vector. The **Sensor's (x,y) position (m)** and **Sensor's height (m)** parameters define the coordinates of the vision sensor with respect to the ego vehicle coordinate system. The default value corresponds to a forward-facing vision sensor mounted to a sedan dashboard. Units are in meters.

Sensor's height (m) — Vision sensor height above the ground plane

0.2 (default) | positive real scalar

Vision sensor height above the ground plane, specified as a positive real scalar. The height is defined with respect to the vehicle ground plane. The **Sensor's (x,y) position (m)** and **Sensor's height (m)** parameters define the coordinates of the vision sensor with respect to the ego vehicle coordinate system. The default value corresponds to a forward-facing vision sensor mounted a sedan dashboard. Units are in meters.

Example: 0.25

Yaw angle of sensor mounted on ego vehicle (deg) — Yaw angle of sensor

0 (default) | real scalar

Yaw angle of vision sensor, specified as a real scalar. Yaw angle is the angle between the center line of the ego vehicle and the optical axis of the camera. A positive yaw angle corresponds to a clockwise

rotation when looking in the positive direction of the z-axis of the ego vehicle coordinate system. Units are in degrees.

Example: -4.0

Pitch angle of sensor mounted on ego vehicle (deg) — Pitch angle of sensor

0 (default) | real scalar

Pitch angle of sensor, specified as a real scalar. The pitch angle is the angle between the optical axis of the camera and the x-y plane of the ego vehicle coordinate system. A positive pitch angle corresponds to a clockwise rotation when looking in the positive direction of the y-axis of the ego vehicle coordinate system. Units are in degrees.

Example: 3.0

Roll angle of sensor mounted on ego vehicle (deg) — Roll angle of sensor

0 (default) | real scalar

Roll angle of the vision sensor, specified as a real scalar. The roll angle is the angle of rotation of the optical axis of the camera around the x-axis of the ego vehicle coordinate system. A positive roll angle corresponds to a clockwise rotation when looking in the positive direction of the x-axis of the coordinate system. Units are in degrees.

Output Port Settings

Source of object bus name — Source of object bus name

Auto (default) | Property

Source of object bus name, specified as Auto or Property. If you select Auto, the block automatically creates a bus name. If you select Property, specify the bus name using the **Specify an object bus name** parameter.

Example: Property

Source of output lane bus name — Source of lane bus name

Auto (default) | Property

Source of output lane bus name, specified as Auto or Property. If you choose Auto, the block will automatically create a bus name. If you choose Property, specify the bus name using the **Specify an object bus name** parameter.

Example: Property

Object bus name — Name of object bus

valid bus name

Name of object bus, specified as a valid bus name.

Example: objectbus

Dependencies

To enable this parameter, set the **Source of object bus name** parameter to Property.

Specify an output lane bus name — Name of output lane bus

valid bus name

Name of output lane bus, specified as a valid bus name.

Example: lanebus

Dependencies

To enable this parameter, set the **Source of output lane bus name** parameter to Property.

Detection Reporting**Maximum number of reported detections** — Maximum number of reported detections

50 (default) | positive integer

Maximum number of detections reported by the sensor, specified as a positive integer. Detections are reported in order of increasing distance from the sensor until the maximum number is reached.

Example: 100

Dependencies

To enable this parameter, set the **Types of detections generated by sensor** parameter to Objects only or Lanes and objects.

Maximum number of reported lanes — Maximum number of reported lanes

30 (default) | positive integer

Maximum number of reported lanes, specified as a positive integer.

Example: 100

Dependencies

To enable this parameter, set the **Types of detections generated by sensor** parameter to Lanes only, Lanes with occlusion, or Lanes and objects.

Coordinate system used to report detections — Coordinate system of reported detections

Ego Cartesian (default) | Sensor Cartesian

Coordinate system of reported detections, specified as one of these values:

- Ego Cartesian — Detections are reported in the ego vehicle Cartesian coordinate system.
- Sensor Cartesian— Detections are reported in the sensor Cartesian coordinate system.

Simulation**Simulate using** — Type of simulation to run

Interpreted execution (default) | Code generation

- **Interpreted execution** — Simulate the model using the MATLAB interpreter. This option shortens startup time. In **Interpreted execution** mode, you can debug the source code of the block.
- **Code generation** — Simulate the model using generated C/C++ code. The first time you run a simulation, Simulink generates C/C++ code for the block. The C code is reused for subsequent simulations as long as the model does not change. This option requires additional startup time.

Measurements

Settings

Maximum detection range (m) — Maximum detection range

150 (default) | positive real scalar

Maximum detection range, specified as a positive real scalar. The vision sensor cannot detect objects beyond this range. Units are in meters.

Example: 250

Object Detector Settings

Bounding box accuracy (pixels) — Bounding box accuracy

5 (default) | positive real scalar

Bounding box accuracy, specified as a positive real scalar. This quantity defines the accuracy with which the detector can match a bounding box to a target. Units are in pixels.

Example: 9

Smoothing filter noise intensity (m/s²) — Noise intensity used for filtering position and velocity measurements

5 (default) | positive real scalar

Noise intensity used for filtering position and velocity measurements, specified as a positive real scalar. Noise intensity defines the standard deviation of the process noise of the internal constant-velocity Kalman filter used in a vision sensor. The filter models the process noise using a piecewise-constant white noise acceleration model. Noise intensity is typically of the order of the maximum acceleration magnitude expected for a target. Units are in meters per second squared.

Example: 2

Maximum detectable object speed (m/s) — Maximum detectable object speed

100 (default) | nonnegative real scalar

Maximum detectable object speed, specified as a nonnegative real scalar. Units are in meters per second.

Example: 20

Maximum allowed occlusion for detector — Maximum allowed occlusion for detector

0.5 (default) | real scalar in the range [0 1)

Maximum allowed occlusion of an object, specified as a real scalar in the range [0 1). Occlusion is the fraction of the total surface area of an object that is not visible to the sensor. A value of 1 indicates that the object is fully occluded. Units are dimensionless.

Example: 0.2

Minimum detectable image size of an object — Minimum height and width of an object

[15, 15] (default) | 1-by-2 vector of positive values

Minimum height and width of an object that the vision sensor detects within an image, specified as a [minHeight, minWidth] vector of positive values. The 2-D projected height of an object must be greater than or equal to minHeight. The projected width of an object must be greater than or equal to minWidth. Units are in pixels.

Example: [25 20]

Probability of detecting a target — Probability of detection

0.9 (default) | positive real scalar less than or equal to 1

Probability of detecting a target, specified as a positive real scalar less than or equal to 1. This quantity defines the probability that the sensor detects a detectable object. A detectable object is an object that satisfies the minimum detectable size, maximum range, maximum speed, and maximum allowed occlusion constraints.

Example: 0.95

Number of false positives per image — Number of false detections generated by vision sensor per image

0.1 (default) | nonnegative real scalar

Number of false detections generated by the vision sensor per image, specified as a nonnegative real scalar.

Example: 1.0

Lane Detector Settings

Minimum lane size in image (pixels) — Maximum size of lane

[20, 3] (default) | 1-by-2 real-valued vector

Minimum size of a projected lane marking in the camera image that can be detected by the sensor after accounting for curvature, specified as a 1-by-2 real-valued vector, [minHeight minWidth]. Lane markings must exceed both of these values to be detected. Units are in pixels.

Dependencies

To enable this parameter, set the **Types of detections generated by sensor** parameter to Lanes only, Lanes only, or Lanes and objects.

Accuracy of lane boundary (pixels) — Accuracy of lane boundary

3 (default) | positive real scalar

Accuracy of lane boundaries, specified as a positive real scalar. This parameter defines the accuracy with which the lane sensor can place a lane boundary. Units are in pixels.

Example: 2.5

Dependencies

To enable this parameter, set the **Types of detections generated by sensor** parameter to Lanes only, Lanes only, or Lanes and objects.

Random Number Generator Settings

Add noise to measurements — Enable adding noise to vision sensor measurements

on (default) | off

Select this parameter to add noise to vision sensor measurements. Otherwise, the measurements are noise-free. The MeasurementNoise property of each detection is always computed and is not affected by the value you specify for the **Add noise to measurements** parameter.

Select method to specify initial seed — Method to specify random number generator seed

Repeatable (default) | Specify seed | Not repeatable

Method to set the random number generator seed, specified as one of the options in the table.

Option	Description
Repeatable	The block generates a random initial seed for the first simulation and reuses this seed for all subsequent simulations. Select this parameter to generate repeatable results from the statistical sensor model. To change this initial seed, at the MATLAB command prompt, enter: <code>clear all</code> .
Specify seed	Specify your own random initial seed for reproducible results by using the Specify seed parameter.
Not repeatable	The block generates a new random initial seed after each simulation run. Select this parameter to generate nonrepeatable results from the statistical sensor model.

Initial seed — Random number generator seed

0 (default) | nonnegative integer less than 2^{32}

Random number generator seed, specified as a nonnegative integer less than 2^{32} .

Example: 2001

Dependencies

To enable this parameter, set the **Random Number Generator Settings** parameter to Specify seed.

Actor Profiles

Select method to specify actor profiles — Method to specify actor profiles

From Scenario Reader block (default) | Parameters | MATLAB expression

Method to specify actor profiles, which are the physical and radar characteristics of all actors in the driving scenario, specified as one of these options:

- From Scenario Reader block — The block obtains the actor profiles from the scenario specified by the Scenario Reader block.
- Parameters — The block obtains the actor profiles from the parameters that become enabled on the **Actor Profiles** tab.
- From workspace — The block obtains the actor profiles from the MATLAB expression specified by the **MATLAB expression for actor profiles** parameter.

MATLAB expression for actor profiles — MATLAB expression for actor profiles

`struct('ClassID',0,'Length',4.7,'Width',1.8,'Height',1.4,'OriginOffset', [-1.35,0,0])` (default) | MATLAB structure | MATLAB structure array | valid MATLAB expression

MATLAB expression for actor profiles, specified as a MATLAB structure, a MATLAB structure array, or a valid MATLAB expression that produces such a structure or structure array.

If your Scenario Reader block reads data from a `drivingScenario` object, to obtain the actor profiles directly from this object, set this expression to call the `actorProfiles` function on the object. For example: `actorProfiles(scenario)`.

Example: `struct('ClassID',5,'Length',5.0,'Width',2,'Height',2,'OriginOffset', [-1.55,0,0])`

Dependencies

To enable this parameter, set the **Select method to specify actor profiles** parameter to MATLAB expression.

Unique identifier for actors — Scenario-defined actor identifier

`[]` (default) | positive integer | length-*L* vector of unique positive integers

Scenario-defined actor identifier, specified as a positive integer or length-*L* vector of unique positive integers. *L* must equal the number of actors input into the **Actors** input port. The vector elements must match `ActorID` values of the actors. You can specify **Unique identifier for actors** as `[]`. In this case, the same actor profile parameters apply to all actors.

Example: `[1,2]`

Dependencies

To enable this parameter, set the **Select method to specify actor profiles** parameter to Parameters.

User-defined integer to classify actors — User-defined classification identifier

`0` (default) | integer | length-*L* vector of integers

User-defined classification identifier, specified as an integer or length- L vector of integers. When **Unique identifier for actors** is a vector, this parameter is a vector of the same length with elements in one-to-one correspondence to the actors in **Unique identifier for actors**. When **Unique identifier for actors** is empty, [], you must specify this parameter as a single integer whose value applies to all actors.

Example: 2

Dependencies

To enable this parameter, set the **Select method to specify actor profiles** parameter to Parameters.

Length of actors cuboids (m) — Length of cuboid

4.7 (default) | positive real scalar | length- L vector of positive values

Length of cuboid, specified as a positive real scalar or length- L vector of positive values. When **Unique identifier for actors** is a vector, this parameter is a vector of the same length with elements in one-to-one correspondence to the actors in **Unique identifier for actors**. When **Unique identifier for actors** is empty, [], you must specify this parameter as a positive real scalar whose value applies to all actors. Units are in meters.

Example: 6.3

Dependencies

To enable this parameter, set the **Select method to specify actor profiles** parameter to Parameters.

Width of actors cuboids (m) — Width of cuboid

4.7 (default) | positive real scalar | length- L vector of positive values

Width of cuboid, specified as a positive real scalar or length- L vector of positive values. When **Unique identifier for actors** is a vector, this parameter is a vector of the same length with elements in one-to-one correspondence to the actors in **Unique identifier for actors**. When **Unique identifier for actors** is empty, [], you must specify this parameter as a positive real scalar whose value applies to all actors. Units are in meters.

Example: 4.7

Dependencies

To enable this parameter, set the **Select method to specify actor profiles** parameter to Parameters.

Height of actors cuboids (m) — Height of cuboid

4.7 (default) | positive real scalar | length- L vector of positive values

Height of cuboid, specified as a positive real scalar or length- L vector of positive values. When **Unique identifier for actors** is a vector, this parameter is a vector of the same length with elements in one-to-one correspondence to the actors in **Unique identifier for actors**. When **Unique identifier for actors** is empty, [], you must specify this parameter as a positive real scalar whose value applies to all actors. Units are in meters.

Example: 2.0

Dependencies

To enable this parameter, set the **Select method to specify actor profiles** parameter to Parameters.

Rotational center of actors from bottom center (m) — Rotational center of the actor

{ [-1.35, 0, 0] } (default) | length-*L* cell array of real-valued 1-by-3 vectors

Rotational center of the actor, specified as a length-*L* cell array of real-valued 1-by-3 vectors. Each vector represents the offset of the rotational center of the actor from the bottom-center of the actor. For vehicles, the offset corresponds to the point on the ground beneath the center of the rear axle. When **Unique identifier for actors** is a vector, this parameter is a cell array of vectors with cells in one-to-one correspondence to the actors in **Unique identifier for actors**. When **Unique identifier for actors** is empty, [], you must specify this parameter as a cell array of one element containing the offset vector whose values apply to all actors. Units are in meters.

Example: [-1.35, .2, .3]

Dependencies

To enable this parameter, set the **Select method to specify actor profiles** parameter to Parameters.

Camera Intrinsic

Focal length (pixels) — Camera focal length

[800, 800] (default) | two-element real-valued vector

Camera focal length, in pixels, specified as a two-element real-valued vector. See also the FocalLength property of cameraIntrinsic.

Example: [480, 320]

Optical center of the camera (pixels) — Optical center of camera

[320, 240] (default) | two-element real-valued vector

Optical center of the camera, in pixels, specified as a two-element real-valued vector. See also the PrincipalPoint property of cameraIntrinsic.

Example: [480, 320]

Image size produced by the camera (pixels) — Image size produced by camera

[480, 640] (default) | two-element vector of positive integers

Image size produced by the camera, in pixels, specified as a two-element vector of positive integers. See also the ImageSize property of cameraIntrinsic.

Example: [240, 320]

Radial distortion coefficients — Radial distortion coefficients

[0, 0] (default) | two-element real-valued vector | three-element real-valued vector

Radial distortion coefficients, specified as a two-element or three-element real-valued vector. For details on setting these coefficients, see the `RadialDistortion` property of `cameraIntrinsics`.

Example: [1, 1]

Tangential distortion coefficients — Tangential distortion coefficients

[0, 0] (default) | two-element real-valued vector

Tangential distortion coefficients, specified as a two-element real-valued vector. For details on setting these coefficients, see the `TangentialDistortion` property of `cameraIntrinsics`.

Example: [1, 1]

Skew of the camera axes — Skew angle of camera axes

0 (default) | real scalar

Skew angle of the camera axes, specified as a real scalar. See also the `Skew` property of `cameraIntrinsics`.

Example: 0.1

Algorithms

The vision sensor models a monocular camera that produces 2-D camera images. To project the coordinates of these 2-D images into the 3-D world coordinates used in driving scenarios, the sensor algorithm assumes that the z-position (height) of all image points of the bottom edge of the target's image bounding box lie on the ground. The plane defining the ground is defined by the height property of the vision detection generator, which defines the offset of the monocular camera above the ground plane. With this projection, the vertical locations of objects in the produced images are strongly correlated to their heights above the road. However, if the road is not flat and the heights of objects differ from the height of the sensor, then the sensor reports inaccurate detections. For an example that shows this behavior, see "Model Vision Sensor Detections".

Version History

Introduced in R2017b

R2023a: Simulink buses do not show in workspace

Behavior change in future release

As of R2023a, the Simulink buses created by this block no longer show in MATLAB workspace.

Extended Capabilities

C/C++ Code Generation

Generate C and C++ code using Simulink® Coder™.

For standalone deployment, the Vision Detection Generator block supports only Simulink Real-Time™ targets.

See Also

Apps

[Bird's-Eye Scope](#)

Blocks

[Driving Radar Data Generator](#) | [Detection Concatenation](#) | [Multi-Object Tracker](#) | [Scenario Reader](#) | [Lidar Point Cloud Generator](#) | [Simulation 3D Vision Detection Generator](#)

Objects

[cameraIntrinsics](#) | [visionDetectionGenerator](#)

Topics

["Create Nonvirtual Buses" \(Simulink\)](#)

World To Vehicle

Convert actors from world coordinates to ego vehicle coordinates



Libraries:

Automated Driving Toolbox / Driving Scenario and Sensor Modeling

Description

The World To Vehicle block converts actor poses from world coordinates to the vehicle coordinates of the input ego vehicle.

Ports

Input

Actors — Actor poses in world coordinates

Simulink bus containing MATLAB structure

Actor poses in world coordinates, specified as a Simulink bus containing a MATLAB structure.

The structure must contain these fields.

Field	Description	Type
NumActors	Number of actors	Nonnegative integer
Time	Current simulation time	Real-valued scalar
Actors	Actor poses	NumActors-length array of actor pose structures

Each actor pose structure in **Actors** must contain these fields.

Field	Description
ActorID	Scenario-defined actor identifier, specified as a positive integer.
Position	Position of actor, specified as a real-valued vector of the form $[x \ y \ z]$. Units are in meters.
Velocity	Velocity (v) of actor in the x - y -, and z -directions, specified as a real-valued vector of the form $[v_x \ v_y \ v_z]$. Units are in meters per second.
Roll	Roll angle of actor, specified as a real-valued scalar. Units are in degrees.
Pitch	Pitch angle of actor, specified as a real-valued scalar. Units are in degrees.

Field	Description
Yaw	Yaw angle of actor, specified as a real-valued scalar. Units are in degrees.
AngularVelocity	Angular velocity (ω) of actor in the x-, y-, and z-directions, specified as a real-valued vector of the form $[\omega_x \ \omega_y \ \omega_z]$. Units are in degrees per second.

Ego Vehicle — Ego vehicle pose

Simulink bus containing MATLAB structure

Ego vehicle pose, specified as a Simulink bus containing a MATLAB structure.

The structure must contain these fields.

Field	Description
ActorID	Scenario-defined actor identifier, specified as a positive integer.
Position	Position of actor, specified as a real-valued vector of the form $[x \ y \ z]$. Units are in meters.
Velocity	Velocity (v) of actor in the x-, y-, and z-directions, specified as a real-valued vector of the form $[v_x \ v_y \ v_z]$. Units are in meters per second.
Roll	Roll angle of actor, specified as a real-valued scalar. Units are in degrees.
Pitch	Pitch angle of actor, specified as a real-valued scalar. Units are in degrees.
Yaw	Yaw angle of actor, specified as a real-valued scalar. Units are in degrees.
AngularVelocity	Angular velocity (ω) of actor in the x-, y-, and z-directions, specified as a real-valued vector of the form $[\omega_x \ \omega_y \ \omega_z]$. Units are in degrees per second.

Output

Actors — Actor poses in vehicle coordinates

Simulink bus containing MATLAB structure

Actor poses in vehicle coordinates, returned as a Simulink bus containing a MATLAB structure.

The structure has these fields.

Field	Description	Type
NumActors	Number of actors	Nonnegative integer
Time	Current simulation time	Real-valued scalar
Actors	Actor poses	NumActors-length array of actor pose structures

Each actor pose structure in Actors has these fields.

Field	Description
ActorID	Scenario-defined actor identifier, specified as a positive integer.
Position	Position of actor, specified as a real-valued vector of the form $[x \ y \ z]$. Units are in meters.
Velocity	Velocity (v) of actor in the x - y -, and z -directions, specified as a real-valued vector of the form $[v_x \ v_y \ v_z]$. Units are in meters per second.
Roll	Roll angle of actor, specified as a real-valued scalar. Units are in degrees.
Pitch	Pitch angle of actor, specified as a real-valued scalar. Units are in degrees.
Yaw	Yaw angle of actor, specified as a real-valued scalar. Units are in degrees.
AngularVelocity	Angular velocity (ω) of actor in the x -, y -, and z -directions, specified as a real-valued vector of the form $[\omega_x \ \omega_y \ \omega_z]$. Units are in degrees per second.

Parameters

Source of actors bus name — Source of name for actor poses bus

Auto (default) | Property

Source of the name for the actor poses bus returned in the **Actors** output port, specified as one of these options:

- Auto — The block automatically creates an actor poses bus name.
- Property — Specify the actor poses bus name by using the **Actors bus name** parameter.

Actors bus name — Name of actor poses bus

valid bus name

Name of the actor poses bus returned in the **Actors** output port, specified as a valid bus name.

Dependencies

To enable this parameter, set **Source of actors bus name** to Property.

Simulate using — Type of simulation to run

Interpreted execution (default) | Code generation

- Interpreted execution — Simulate the model using the MATLAB interpreter. This option shortens startup time. In Interpreted execution mode, you can debug the source code of the block.
- Code generation — Simulate the model using generated C/C++ code. The first time you run a simulation, Simulink generates C/C++ code for the block. The C code is reused for subsequent simulations as long as the model does not change. This option requires additional startup time.

Version History

Introduced in R2020a

Extended Capabilities

C/C++ Code Generation

Generate C and C++ code using Simulink® Coder™.

See Also

Scenario Reader | Vehicle To World | Cuboid To 3D Simulation

Topics

“Coordinate Systems in Automated Driving Toolbox”

“Coordinate Systems for Unreal Engine Simulation in Automated Driving Toolbox”

Functions

addCustomBasemap

Add custom basemap

Syntax

```
addCustomBasemap(basemapName,URL)
addCustomBasemap( ____,Name,Value)
```

Description

`addCustomBasemap(basemapName,URL)` adds the custom basemap specified by URL to the list of basemaps available for use with mapping functions. `basemapName` is the name you choose to call the custom basemap. Added basemaps remain available for use in future MATLAB sessions.

You can use the custom basemap with the `geoplayer` object and with MATLAB geographic axes and charts.

`addCustomBasemap(____,Name,Value)` specifies name-value arguments that set additional parameters of the basemap.

Examples

Display Data on OpenStreetMap Basemap

This example shows how to display a driving route and vehicle positions on an OpenStreetMap® basemap.

Add the OpenStreetMap basemap to the list of basemaps available for use with the `geoplayer` object. After you add the basemap, you do not need to add it again in future sessions.

```
name = 'openstreetmap';
url = 'https://a.tile.openstreetmap.org/{z}/{x}/{y}.png';
copyright = char(uint8(169));
attribution = copyright + "OpenStreetMap contributors";
addCustomBasemap(name,url,'Attribution',attribution)
```

Load a sequence of latitude and longitude coordinates.

```
data = load('geoRoute.mat');
```

Create a geographic player. Center the geographic player on the first position of the driving route and set the zoom level to 12.

```
zoomLevel = 12;
player = geoplayer(data.latitude(1),data.longitude(1),zoomLevel);
```

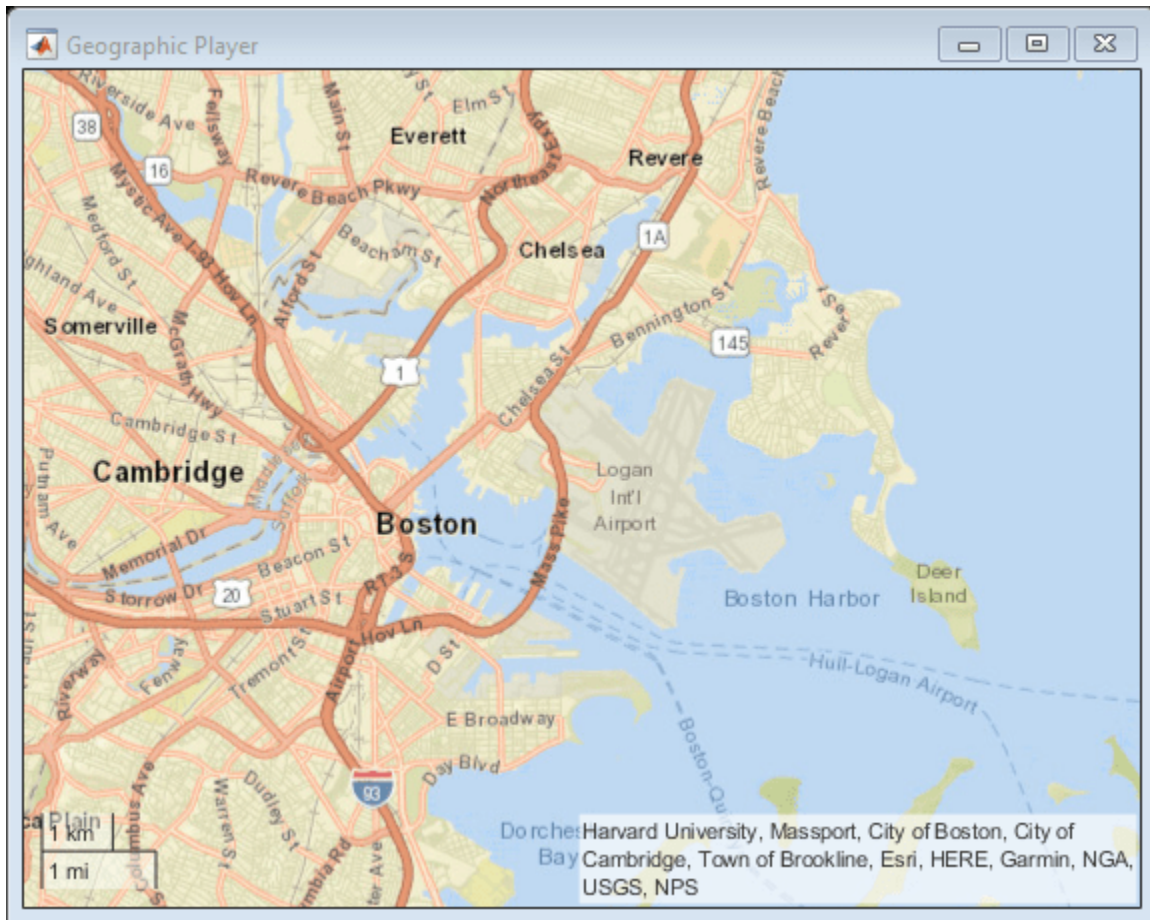
Display the full route.

```
plotRoute(player,data.latitude,data.longitude);
```

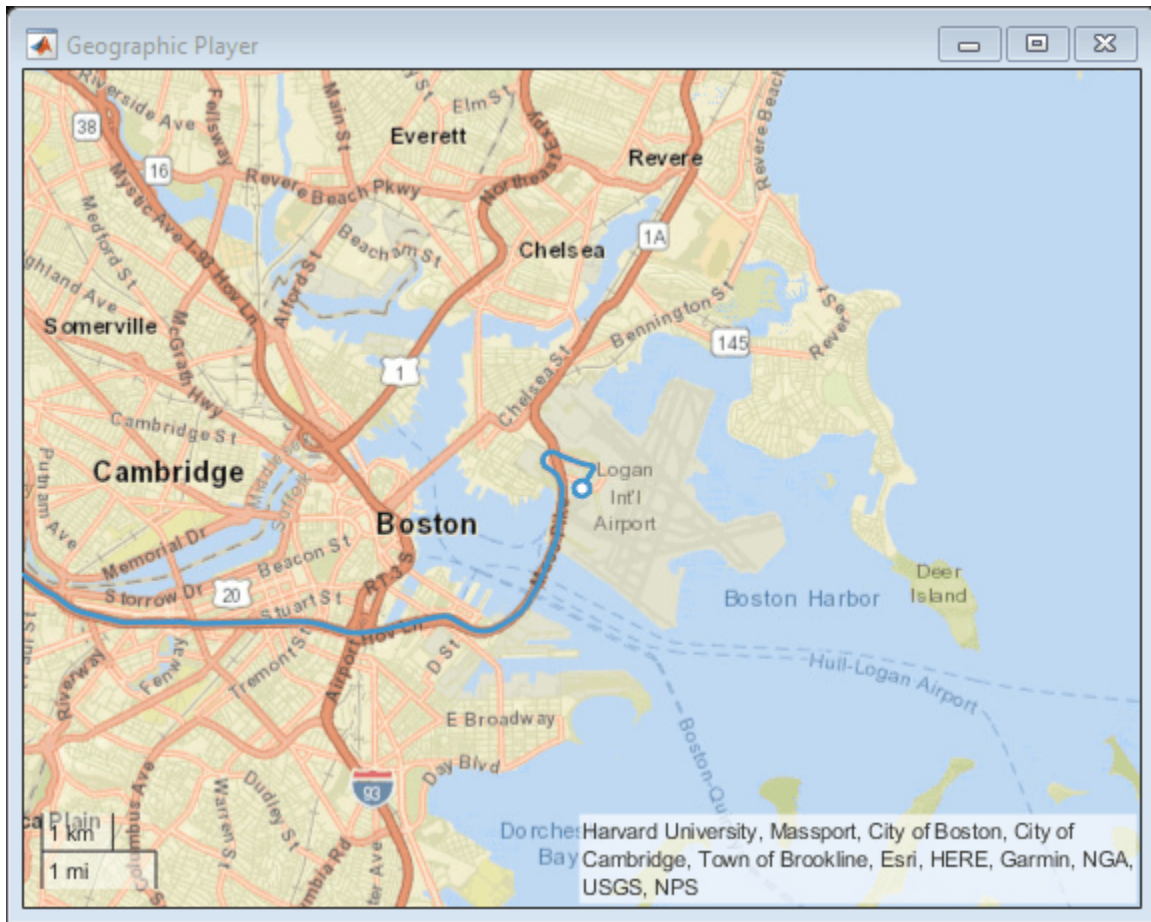

By default, the geographic player uses the World Street Map basemap ('streets') provided by Esri®. Update the geographic player to use the added OpenStreetMap basemap instead.

```
player.Basemap = 'openstreetmap';
```

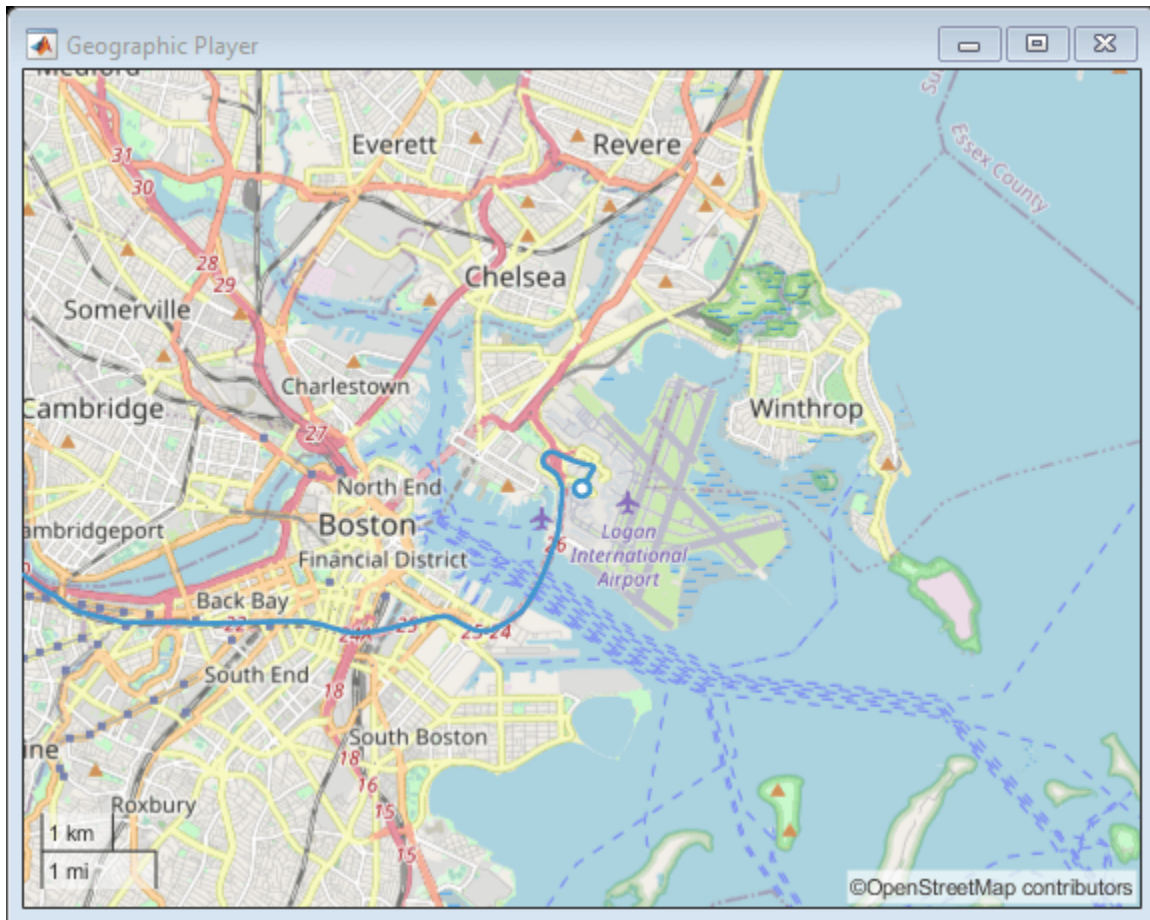

Display the route again.

```
plotRoute(player,data.latitude,data.longitude);
```

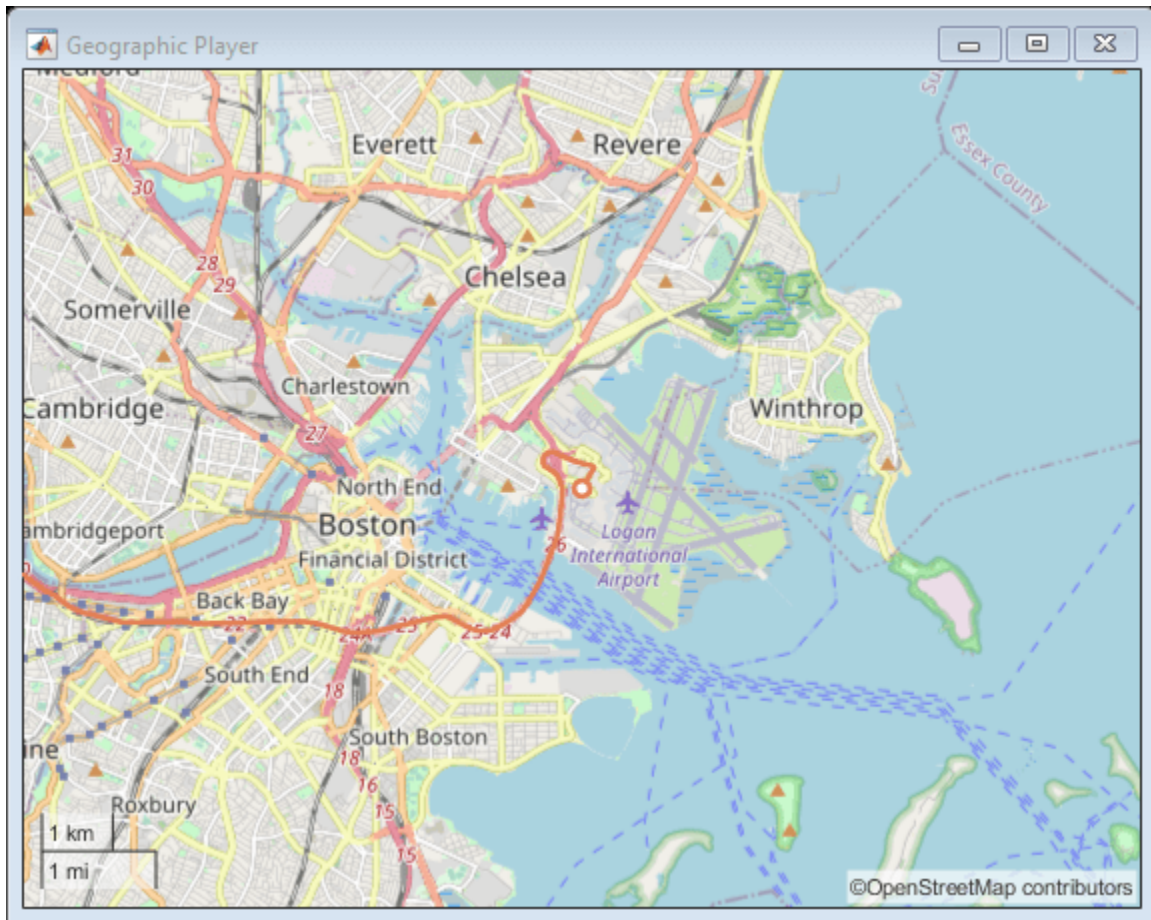

Display the positions of the vehicle in a sequence.

```
for i = 1:length(data.latitude)
    plotPosition(player,data.latitude(i),data.longitude(i))
end
```

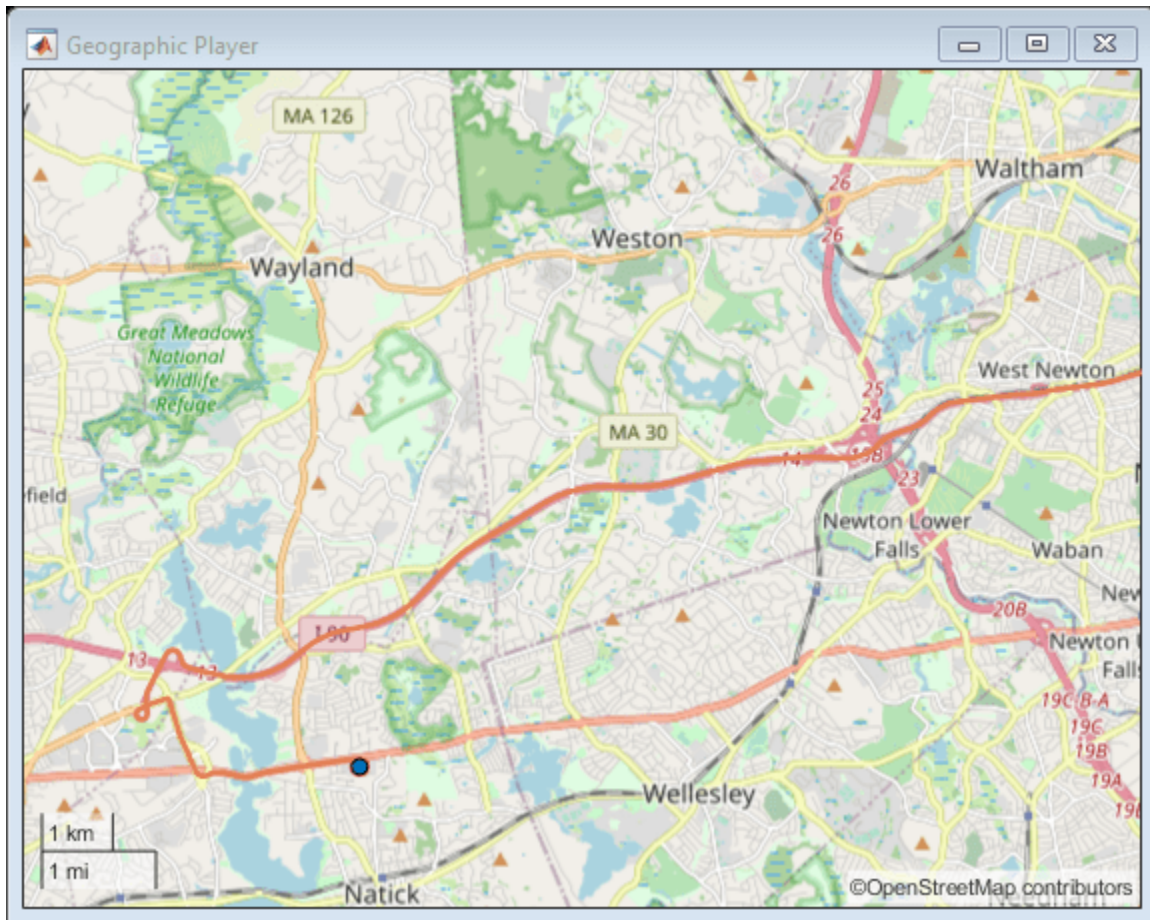
Display Data on HERE Basemap

Display a driving route on a basemap provided by HERE Technologies. To use this example, you must have a valid license from HERE Technologies.

Specify the basemap name and map URL.

```
name = 'herestreets';
url = ['https://1.base.maps.ls.hereapi.com/maptile/2.1/maptile/', ...
      'newest/normal.day/{z}/{x}/{y}/256/png?apikey=%s'];
```

Maps from HERE Technologies require a valid license. Create a dialog box. In the dialog box, enter the Access Key ID corresponding to your HERE license.

```
prompt = {'HERE Access Key ID:'};
title = 'HERE Tokens';
dims = [1 40]; % Text edit field height and width
hereTokens = inputdlg(prompt,title,dims);
```

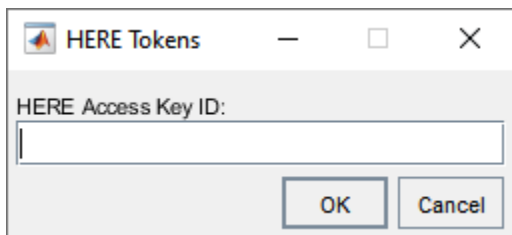

If the license is valid, specify the HERE credentials and a custom attribution, load coordinate data, and display the coordinates on the HERE basemap using a `geoplayer` object. If the license is not valid, display an error message.

```

if ~isempty(hereTokens)

    % Add HERE basemap with custom attribution.
    url = sprintf(url,hereTokens{1});
    copyrightSymbol = char(169); % Alt code
    attribution = [copyrightSymbol, ' ',datestr(now,'yyyy'),' HERE'];
    addCustomBasemap(name,url,'Attribution',attribution);

    % Load sample lat,lon coordinates.
    data = load('geoSequence.mat');

    % Create geoplayer with HERE basemap.
    player = geoplayer(data.latitude(1),data.longitude(1), ...
        'Basemap','herestreets','HistoryDepth',Inf);

    % Display the coordinates in a sequence.
    for i = 1:length(data.latitude)
        plotPosition(player,data.latitude(i),data.longitude(i));
    end

else
    error('You must enter valid credentials to access maps from HERE Technologies');
end

```

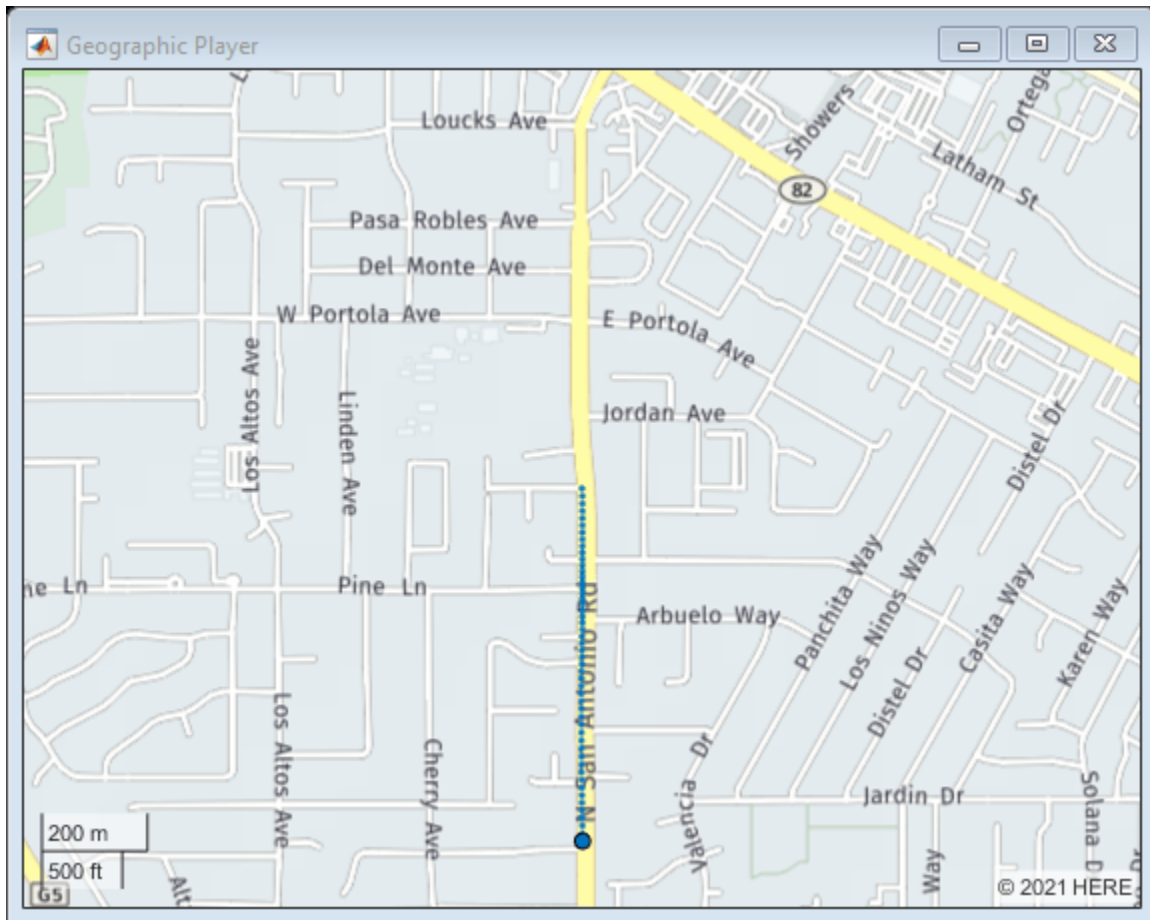

Input Arguments

basemapName — Name used to identify basemap programmatically

string scalar | character vector

Name used to identify basemap programmatically, specified as a string scalar or character vector.

Example: 'openstreetmap'

Data Types: string | char

URL — Parameterized map URL

string scalar | character vector

Parameterized map URL, specified as a string scalar or character vector.

The parameterized map URL typically includes:

- The URL of the basemap tiles.
- An index of the map tiles, formatted as $\{z\}/\{x\}/\{y\}$ or $\{z\}/\{y\}/\{z\}$, where z is the tile zoom level, x is the tile column index, and y is the tile row index.
- The file format of the map tiles. The `addCustomBasemap` function can read tiles in image formats supported by the `imread` function and tiles in PBF format (requires Mapping Toolbox™) when the

map tiles are hosted by Esri®. Depending on the data provider, map tiles are available in different file formats.

The way you structure this argument can depend on the data provider. For more information about how to structure a URL, see “Examples” (Mapping Toolbox) or ask your data provider.

Example: "https://hostname/{z}/{y}/{x}.png"

Example: "https://hostname/{z}/{x}/{y}/png"

Data Types: string | char

Name-Value Arguments

Specify optional pairs of arguments as Name1=Value1, . . . , NameN=ValueN, where Name is the argument name and Value is the corresponding value. Name-value arguments must appear after other arguments, but the order of the pairs does not matter.

Example: `addCustomBasemap(basemapName,URL,Attribution="My attribution")` specifies the attribution for the custom basemap.

Before R2021a, use commas to separate each name and value, and enclose Name in quotes.

Example: `addCustomBasemap(basemapName,URL,"Attribution","My attribution")` specifies the attribution for the custom basemap.

Attribution — Attribution of custom basemap

string scalar | string array | character vector | cell array of character vectors

Attribution of the custom basemap, specified as a string scalar, string array, character vector, or cell array of character vectors. To create a multiline attribution, specify a string array or a nonscalar cell array of character vectors.

When you create a custom basemap from a URL, the default attribution is 'Tiles courtesy of *DOMAIN_NAME_OF_URL*', where *DOMAIN_NAME_OF_URL* is the domain name from the URL input argument. If the host is 'localhost', or if URL contains only IP numbers, specify the attribution as an empty string ("").

Example: "Credit: U.S. Geological Survey"

Data Types: string | char | cell

DisplayName — Display name of custom basemap

string scalar | character vector

Display name of the custom basemap, specified as a string scalar or character vector.

Example: "OpenStreetMap"

Data Types: string | char

MaxZoomLevel — Maximum zoom level of basemap

18 (default) | integer in range [0, 25]

Maximum zoom level of the basemap, specified as an integer in the range [0, 25].

Data Types: single | double | int8 | int16 | int32 | int64 | uint8 | uint16 | uint32 | uint64

IsDeployable — Map is deployable using MATLAB Compiler™

false or 0 (default) | true or 1

Map is deployable using MATLAB Compiler, specified as a numeric or logical 0 (false) or 1 (true).

To deploy a map application that uses a custom basemap, set `IsDeployable` to `true`. Maps in the `geoplayer` object are not deployable. If you are using a `geoplayer` object, leave `IsDeployable` set to `false`.

Data Types: `logical`

Tips

- You can find tiled web maps from various vendors, such as OpenStreetMap, the USGS National Map, Mapbox, DigitalGlobe, Esri ArcGIS Online, the Geospatial Information Authority of Japan (GSI), and HERE Technologies. Abide by the map vendors terms-of-service agreement and include accurate attribution with the maps you use.
- If you have Mapping Toolbox, you can create custom basemaps from MBTiles files and from vector basemaps hosted by Esri. For more information, see `addCustomBasemap`.
- To access a list of available basemaps, press **Tab** before specifying the basemap in your plotting function. This image shows a sample list of available basemaps, including several custom basemaps from the USGS National Map.

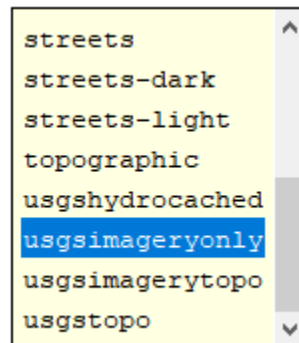

```
geobubble(lat,lon,"Basemap","
```

Version History

Introduced in R2019a

See Also

`geobasemap` | `geobubble` | `removeCustomBasemap` | `geoplayer` | `readBasemapImage`

Topics

“Use Basemaps in Offline Environments” (Mapping Toolbox)

cameas

Measurement function for constant-acceleration motion

Syntax

```
measurement = cameas(state)
measurement = cameas(state, frame)
measurement = cameas(state, frame, sensorpos)
measurement = cameas(state, frame, sensorpos, sensorvel)
measurement = cameas(state, frame, sensorpos, sensorvel, laxes)
measurement = cameas(state, measurementParameters)
[measurement, bounds] = cameas( ___ )
```

Description

`measurement = cameas(state)` returns the measurement, for the constant-acceleration Kalman filter motion model in rectangular coordinates. The `state` argument specifies the current state of the filter.

`measurement = cameas(state, frame)` also specifies the measurement coordinate system, `frame`.

`measurement = cameas(state, frame, sensorpos)` also specifies the sensor position, `sensorpos`.

`measurement = cameas(state, frame, sensorpos, sensorvel)` also specifies the sensor velocity, `sensorvel`.

`measurement = cameas(state, frame, sensorpos, sensorvel, laxes)` also specifies the local sensor axes orientation, `laxes`.

`measurement = cameas(state, measurementParameters)` specifies the measurement parameters, `measurementParameters`.

`[measurement, bounds] = cameas(___)` returns the measurement bounds, used by a tracking filter (`trackingEKF` or `trackingUKF`) in residual calculations. See the `HasMeasurementWrapping` of the filter object for more details.

Examples

Create Measurement from Accelerating Object in Rectangular Frame

Define the state of an object in 2-D constant-acceleration motion. The state is the position, velocity, and acceleration in both dimensions. The measurements are in rectangular coordinates.

```
state = [1,10,3,2,20,0.5].';
measurement = cameas(state)
```

```
measurement = 3×1
```

```
1
2
0
```

The measurement is returned in three-dimensions with the z-component set to zero.

Create Measurement from Accelerating Object in Spherical Frame

Define the state of an object in 2-D constant-acceleration motion. The state is the position, velocity, and acceleration in both dimensions. The measurements are in spherical coordinates.

```
state = [1,10,3,2,20,5].';
measurement = cameas(state, 'spherical')
```

```
measurement = 4×1
```

```
63.4349
      0
  2.2361
 22.3607
```

The elevation of the measurement is zero and the range rate is positive. These results indicate that the object is moving away from the sensor.

Create Measurement from Accelerating Object in Translated Spherical Frame

Define the state of an object moving in 2-D constant-acceleration motion. The state consists of position, velocity, and acceleration in each dimension. The measurements are in spherical coordinates with respect to a frame located at (20;40;0) meters from the origin.

```
state = [1,10,3,2,20,5].';
measurement = cameas(state, 'spherical', [20;40;0])
```

```
measurement = 4×1
```

```
-116.5651
      0
  42.4853
 -22.3607
```

The elevation of the measurement is zero and the range rate is negative indicating that the object is moving toward the sensor.

Create Measurement from Constant-Accelerating Object Using Measurement Parameters

Define the state of an object moving in 2-D constant-acceleration motion. The state consists of position, velocity, and acceleration in each dimension. The measurements are in spherical coordinates with respect to a frame located at (20;40;0) meters from the origin.

```
state2d = [1,10,3,2,20,5].';
```

The elevation of the measurement is zero and the range rate is negative indicating that the object is moving toward the sensor.

```
frame = 'spherical';
sensorpos = [20;40;0];
sensorvel = [0;5;0];
laxes = eye(3);
measurement = cameas(state2d,'spherical',sensorpos,sensorvel,laxes)
```

```
measurement = 4×1
```

```
-116.5651
         0
  42.4853
 -17.8885
```

The elevation of the measurement is zero and the range rate is negative. These results indicate that the object is moving toward the sensor.

Put the measurement parameters in a structure and use the alternative syntax.

```
measparm = struct('Frame',frame,'OriginPosition',sensorpos,'OriginVelocity',sensorvel, ...
    'Orientation',laxes);
measurement = cameas(state2d,measparm)
```

```
measurement = 4×1
```

```
-116.5651
         0
  42.4853
 -17.8885
```

Display Residual Wrapping Bounds for cameas

Specify a 2-D state and specify a measurement structure such that the function outputs azimuth, range, and range-rate measurements.

```
state = [10 1 0.1 10 1 0.1]'; % [x vx ax y vy ay]'
mp = struct("Frame","Spherical", ...
    "HasAzimuth",true, ...
    "HasElevation",false, ...
    "HasRange",true, ...
    "HasVelocity",false);
```

Output the measurement and wrapping bounds using the cameas function.

```
[measure,bounds] = cameas(state,mp)
```

```
measure = 2×1
```

```
45.0000
14.1421
```

```
bounds = 2×2
```

```
-180 180
-Inf Inf
```

Input Arguments

state — Kalman filter state

real-valued $3D$ -by N matrix

Kalman filter state for constant-acceleration motion, specified as a real-valued $3D$ -by N matrix. D is the number of spatial degrees of freedom of motion and N is the number states. For each spatial degree of motion, the state vector, as a column of the `state` matrix, takes the form shown in this table.

Spatial Dimensions	State Vector Structure
1-D	[x;vx;ax]
2-D	[x;vx;ax;y;vy;ay]
3-D	[x;vx;ax;y;vy;ay;z;vz;az]

For example, x represents the x -coordinate, v_x represents the velocity in the x -direction, and a_x represents the acceleration in the x -direction. If the motion model is in one-dimensional space, the y - and z -axes are assumed to be zero. If the motion model is in two-dimensional space, values along the z -axis are assumed to be zero. Position coordinates are in meters. Velocity coordinates are in meters/second. Acceleration coordinates are in meters/second².

Example: [5;0.1;0.01;0;-0.2;-0.01;-3;0.05;0]

Data Types: double

frame — Measurement output frame

'rectangular' (default) | 'spherical'

Measurement output frame, specified as 'rectangular' or 'spherical'. When the frame is 'rectangular', a measurement consists of x , y , and z Cartesian coordinates. When specified as 'spherical', a measurement consists of azimuth, elevation, range, and range rate.

Data Types: char

sensorpos — Sensor position

[0;0;0] (default) | real-valued 3-by-1 column vector

Sensor position with respect to the navigation frame, specified as a real-valued 3-by-1 column vector. Units are in meters.

Data Types: double

sensorvel — Sensor velocity

[0;0;0] (default) | real-valued 3-by-1 column vector

Sensor velocity with respect to the navigation frame, specified as a real-valued 3-by-1 column vector. Units are in m/s.

Data Types: double

laxes — Local sensor coordinate axes

[1,0,0;0,1,0;0,0,1] (default) | 3-by-3 orthogonal matrix

Local sensor coordinate axes, specified as a 3-by-3 orthogonal matrix. Each column specifies the direction of the local x-, y-, and z-axes, respectively, with respect to the navigation frame. That is, the matrix is the rotation matrix from the global frame to the sensor frame.

Data Types: double

measurementParameters — Measurement parameters

structure | array of structure

Measurement parameters, specified as a structure or an array of structures. The fields of the structure are:

Field	Description	Example
Frame	Frame used to report measurements, specified as one of these values: <ul style="list-style-type: none"> 'Rectangular' — Detections are reported in rectangular coordinates. 'Spherical' — Detections are reported in spherical coordinates. 	'spherical'
OriginPosition	Position offset of the origin of the frame relative to the parent frame, specified as an [x y z] real-valued vector.	[0 0 0]
OriginVelocity	Velocity offset of the origin of the frame relative to the parent frame, specified as a [vx vy vz] real-valued vector.	[0 0 0]
Orientation	Frame rotation matrix, specified as a 3-by-3 real-valued orthonormal matrix.	[1 0 0; 0 1 0; 0 0 1]
HasAzimuth	Logical scalar indicating if azimuth is included in the measurement. This field is not relevant when the Frame field is 'Spherical'.	1

Field	Description	Example
HasElevation	Logical scalar indicating if elevation information is included in the measurement. For measurements reported in a rectangular frame, and if HasElevation is false, the reported measurements assume 0 degrees of elevation.	1
HasRange	Logical scalar indicating if range is included in the measurement. This field is not relevant when the Frame is 'Spherical'.	1
HasVelocity	Logical scalar indicating if the reported detections include velocity measurements. For a measurement reported in the rectangular frame, if HasVelocity is false, the measurements are reported as [x y z]. If HasVelocity is true, the measurement is reported as [x y z vx vy vz]. For a measurement reported in the spherical frame, if HasVelocity is true, the measurement contains range-rate information.	1
IsParentToChild	Logical scalar indicating if Orientation performs a frame rotation from the parent coordinate frame to the child coordinate frame. When IsParentToChild is false, then Orientation performs a frame rotation from the child coordinate frame to the parent coordinate frame.	0

If you only want to perform one coordinate transformation, such as a transformation from the body frame to the sensor frame, you only need to specify a measurement parameter structure. If you want to perform multiple coordinate transformations, you need to specify an array of measurement parameter structures. To learn how to perform multiple transformations, see the “Convert Detections to objectDetection Format” (Sensor Fusion and Tracking Toolbox) example.

Data Types: struct

Output Arguments

measurement — Measurement vector

real-valued M -by- N matrix

Measurement vector, returned as an M -by- N matrix. M is the dimension of the measurement and N , the number of measurement, is the same as the number of states. The form of each measurement depends upon which syntax you use.

- When the syntax does not use the `measurementParameters` argument, the measurement vector is $[x, y, z]$ when the `frame` input argument is set to 'rectangular' and $[az; el; r; rr]$ when the frame is set to 'spherical'.
- When the syntax uses the `measurementParameters` argument, the size of the measurement vector depends on the values of the `frame`, `HasVelocity`, and `HasElevation` fields in the `measurementParameters` structure.

frame	measurement															
'spherical'	<p>Specifies the azimuth angle, az, elevation angle, el, range, r, and range rate, rr, of the object with respect to the local ego vehicle coordinate system. Positive values for range rate indicate that an object is moving away from the sensor.</p> <p>Spherical measurements</p> <table border="1"> <thead> <tr> <th></th> <th></th> <th colspan="2">HasElevation</th> </tr> <tr> <th></th> <th></th> <th>false</th> <th>true</th> </tr> </thead> <tbody> <tr> <td rowspan="2">HasVelocity</td> <td>false</td> <td>$[az; r]$</td> <td>$[az; el; r]$</td> </tr> <tr> <td>true</td> <td>$[az; r; rr]$</td> <td>$[az; el; r; rr]$</td> </tr> </tbody> </table> <p>Angle units are in degrees, range units are in meters, and range rate units are in m/s.</p>			HasElevation				false	true	HasVelocity	false	$[az; r]$	$[az; el; r]$	true	$[az; r; rr]$	$[az; el; r; rr]$
		HasElevation														
		false	true													
HasVelocity	false	$[az; r]$	$[az; el; r]$													
	true	$[az; r; rr]$	$[az; el; r; rr]$													
'rectangular'	<p>Specifies the Cartesian position and velocity coordinates of the tracked object with respect to the ego vehicle coordinate system.</p> <p>Rectangular measurements</p> <table border="1"> <thead> <tr> <th>HasVelocity</th> <th></th> <th></th> </tr> </thead> <tbody> <tr> <td>false</td> <td></td> <td>$[x; y; y]$</td> </tr> <tr> <td>true</td> <td></td> <td>$[x; y; z; vx; vy; vz]$</td> </tr> </tbody> </table> <p>Position units are in meters and velocity units are in m/s.</p>	HasVelocity			false		$[x; y; y]$	true		$[x; y; z; vx; vy; vz]$						
HasVelocity																
false		$[x; y; y]$														
true		$[x; y; z; vx; vy; vz]$														

Data Types: double

bounds — Measurement residual wrapping bounds

M -by-2 real-valued matrix

Measurement residual wrapping bounds, returned as an M -by-2 real-valued matrix, where M is the dimension of the measurement. Each row of the matrix corresponds to the lower and upper bounds for the specific dimension in the measurement output.

The function returns different bound values based on the frame input.

- If the frame input is specified as 'Rectangular', each row of the matrix is [-Inf Inf], indicating the filter does not wrap the measurement residual in the filter.
- If the frame input is specified as 'Spherical', the returned bounds contains the bounds for specific measurement dimension based on the following:
 - When HasAzimuth = true, the matrix includes a row of [-180 180], indicating the filter wraps the azimuth residual in the range of [-180 180] in degrees.
 - When HasElevation = true, the matrix includes a row of [-90 90], indicating the filter wraps the elevation residual in the range of [-90 90] in degrees.
 - When HasRange = true, the matrix includes a row of [-Inf Inf], indicating the filter does not wrap the range residual.
 - When HasVelocity = true, the matrix includes a row of [-Inf Inf], indicating the filter does not wrap the range rate residual.

If you specify any of the options as false, the returned bounds does not contain the corresponding row. For example, if HasAzimuth = true, HasElevation = false, HasRange = true, HasVelocity = true, then bounds is returned as

```
-180  180
-Inf  Inf
-Inf  Inf
```

The filter wraps the measuring residuals based on this equation:

$$x_{wrap} = \text{mod}\left(x - \frac{a-b}{2}, b-a\right) + \frac{a-b}{2}$$

where x is the residual to wrap, a is the lower bound, b is the upper bound, mod is the modules after division function, and x_{wrap} is the wrapped residual.

Data Types: single | double

More About

Azimuth and Elevation Angle Definitions

Define the azimuth and elevation angles used in the toolbox.

The azimuth angle of a vector is the angle between the x -axis and its orthogonal projection onto the xy plane. The angle is positive in going from the x axis toward the y axis. Azimuth angles lie between -180 and 180 degrees. The elevation angle is the angle between the vector and its orthogonal projection onto the xy -plane. The angle is positive when going toward the positive z -axis from the xy plane.

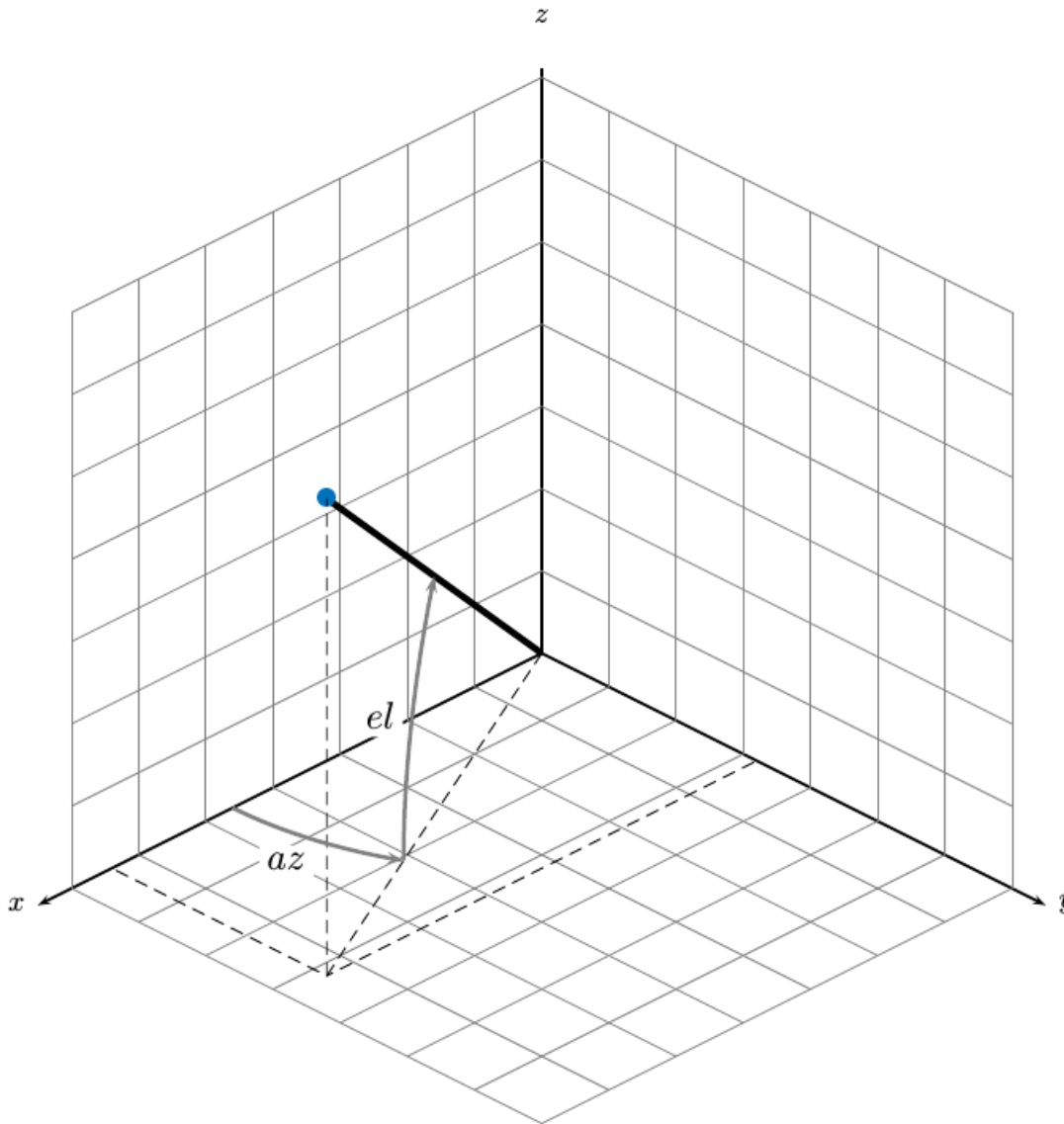

Version History

Introduced in R2017a

Extended Capabilities

C/C++ Code Generation

Generate C and C++ code using MATLAB® Coder™.

See Also

Functions

constacc | constaccjac | cameasjac | constturn | constturnjac | ctmeas | ctmeasjac | constvel | constveljac | cvmeas | cvmeasjac

Objects

trackingKF | trackingEKF | trackingUKF

cameasjac

Jacobian of measurement function for constant-acceleration motion

Syntax

```
measurementjac = cameasjac(state)
measurementjac = cameasjac(state, frame)
measurementjac = cameasjac(state, frame, sensorpos)
measurementjac = cameasjac(state, frame, sensorpos, sensorvel)
measurementjac = cameasjac(state, frame, sensorpos, sensorvel, laxes)
measurementjac = cameasjac(state, measurementParameters)
```

Description

`measurementjac = cameasjac(state)` returns the measurement Jacobian, for constant-acceleration Kalman filter motion model in rectangular coordinates. The `state` argument specifies the current state of the filter.

`measurementjac = cameasjac(state, frame)` also specifies the measurement coordinate system, `frame`.

`measurementjac = cameasjac(state, frame, sensorpos)` also specifies the sensor position, `sensorpos`.

`measurementjac = cameasjac(state, frame, sensorpos, sensorvel)` also specifies the sensor velocity, `sensorvel`.

`measurementjac = cameasjac(state, frame, sensorpos, sensorvel, laxes)` also specifies the local sensor axes orientation, `laxes`.

`measurementjac = cameasjac(state, measurementParameters)` specifies the measurement parameters, `measurementParameters`.

Examples

Measurement Jacobian of Accelerating Object in Rectangular Frame

Define the state of an object in 2-D constant-acceleration motion. The state is the position, velocity, and acceleration in both dimensions. Construct the measurement Jacobian in rectangular coordinates.

```
state = [1,10,3,2,20,5].';
jacobian = cameasjac(state)
```

```
jacobian = 3×6
```

```

     1     0     0     0     0     0
     0     0     0     1     0     0
     0     0     0     0     0     0
```

Measurement Jacobian of Accelerating Object in Spherical Frame

Define the state of an object in 2-D constant-acceleration motion. The state is the position, velocity, and acceleration in both dimensions. Compute the measurement Jacobian in spherical coordinates.

```
state = [1;10;3;2;20;5];
measurementjac = cameasjac(state, 'spherical')
```

```
measurementjac = 4×6
```

```
-22.9183      0      0      11.4592      0      0
      0      0      0      0      0      0
      0.4472      0      0      0.8944      0      0
      0.0000      0.4472      0      0.0000      0.8944      0
```

Measurement Jacobian of Accelerating Object in Translated Spherical Frame

Define the state of an object in 2-D constant-acceleration motion. The state is the position, velocity, and acceleration in both dimensions. Compute the measurement Jacobian in spherical coordinates with respect to an origin at (5;-20;0) meters.

```
state = [1,10,3,2,20,5].';
sensorpos = [5, -20, 0].';
measurementjac = cameasjac(state, 'spherical', sensorpos)
```

```
measurementjac = 4×6
```

```
-2.5210      0      0     -0.4584      0      0
      0      0      0      0      0      0
-0.1789      0      0      0.9839      0      0
      0.5903     -0.1789      0      0.1073      0.9839      0
```

Create Measurement Jacobian of Accelerating Object Using Measurement Parameters

Define the state of an object in 2-D constant-acceleration motion. The state is the position, velocity, and acceleration in both dimensions. Compute the measurement Jacobian in spherical coordinates with respect to an origin at (5;-20;0) meters.

```
state2d = [1,10,3,2,20,5].';
sensorpos = [5, -20, 0].';
frame = 'spherical';
sensorvel = [0;8;0];
laxes = eye(3);
measurementjac = cameasjac(state2d, frame, sensorpos, sensorvel, laxes)
```

```
measurementjac = 4×6
```

```
-2.5210      0      0     -0.4584      0      0
```

```

      0      0      0      0      0      0
-0.1789    0      0      0.9839    0      0
 0.5274  -0.1789    0      0.0959    0.9839    0

```

Put the measurement parameters in a structure and use the alternative syntax.

```

measparm = struct('Frame',frame,'OriginPosition',sensorpos,'OriginVelocity',sensorvel, ...
    'Orientation',laxes);
measurementjac = cameasjac(state2d,measparm)

```

```

measurementjac = 4x6

```

```

-2.5210    0      0      -0.4584    0      0
      0      0      0      0      0      0
-0.1789    0      0      0.9839    0      0
 0.5274  -0.1789    0      0.0959    0.9839    0

```

Input Arguments

state — Kalman filter state vector

real-valued $3N$ -element vector

Kalman filter state vector for constant-acceleration motion, specified as a real-valued $3N$ -element vector. N is the number of spatial degrees of freedom of motion. For each spatial degree of motion, the state vector takes the form shown in this table.

Spatial Dimensions	State Vector Structure
1-D	[x;vx;ax]
2-D	[x;vx;ax;y;vy;ay]
3-D	[x;vx;ax;y;vy;ay;z;vz;az]

For example, x represents the x -coordinate, v_x represents the velocity in the x -direction, and a_x represents the acceleration in the x -direction. If the motion model is in one-dimensional space, the y - and z -axes are assumed to be zero. If the motion model is in two-dimensional space, values along the z -axis are assumed to be zero. Position coordinates are in meters. Velocity coordinates are in meters/second. Acceleration coordinates are in meters/second².

Example: [5;0.1;0.01;0;-0.2;-0.01;-3;0.05;0]

Data Types: double

frame — Measurement output frame

'rectangular' (default) | 'spherical'

Measurement output frame, specified as 'rectangular' or 'spherical'. When the frame is 'rectangular', a measurement consists of x , y , and z Cartesian coordinates. When specified as 'spherical', a measurement consists of azimuth, elevation, range, and range rate.

Data Types: char

sensorpos — Sensor position

[0;0;0] (default) | real-valued 3-by-1 column vector

Sensor position with respect to the navigation frame, specified as a real-valued 3-by-1 column vector. Units are in meters.

Data Types: double

sensorvel — Sensor velocity

[0;0;0] (default) | real-valued 3-by-1 column vector

Sensor velocity with respect to the navigation frame, specified as a real-valued 3-by-1 column vector. Units are in m/s.

Data Types: double

laxes — Local sensor coordinate axes

[1,0,0;0,1,0;0,0,1] (default) | 3-by-3 orthogonal matrix

Local sensor coordinate axes, specified as a 3-by-3 orthogonal matrix. Each column specifies the direction of the local x -, y -, and z -axes, respectively, with respect to the navigation frame. That is, the matrix is the rotation matrix from the global frame to the sensor frame.

Data Types: double

measurementParameters — Measurement parameters

structure | array of structure

Measurement parameters, specified as a structure or an array of structures. The fields of the structure are:

Field	Description	Example
Frame	Frame used to report measurements, specified as one of these values: <ul style="list-style-type: none"> 'Rectangular' — Detections are reported in rectangular coordinates. 'Spherical' — Detections are reported in spherical coordinates. 	'spherical'
OriginPosition	Position offset of the origin of the frame relative to the parent frame, specified as an [x y z] real-valued vector.	[0 0 0]
OriginVelocity	Velocity offset of the origin of the frame relative to the parent frame, specified as a [vx vy vz] real-valued vector.	[0 0 0]
Orientation	Frame rotation matrix, specified as a 3-by-3 real-valued orthonormal matrix.	[1 0 0; 0 1 0; 0 0 1]

Field	Description	Example
HasAzimuth	Logical scalar indicating if azimuth is included in the measurement. This field is not relevant when the Frame field is 'Spherical'.	1
HasElevation	Logical scalar indicating if elevation information is included in the measurement. For measurements reported in a rectangular frame, and if HasElevation is false, the reported measurements assume 0 degrees of elevation.	1
HasRange	Logical scalar indicating if range is included in the measurement. This field is not relevant when the Frame is 'Spherical'.	1
HasVelocity	Logical scalar indicating if the reported detections include velocity measurements. For a measurement reported in the rectangular frame, if HasVelocity is false, the measurements are reported as [x y z]. If HasVelocity is true, the measurement is reported as [x y z vx vy vz]. For a measurement reported in the spherical frame, if HasVelocity is true, the measurement contains range-rate information.	1
IsParentToChild	Logical scalar indicating if Orientation performs a frame rotation from the parent coordinate frame to the child coordinate frame. When IsParentToChild is false, then Orientation performs a frame rotation from the child coordinate frame to the parent coordinate frame.	0

If you only want to perform one coordinate transformation, such as a transformation from the body frame to the sensor frame, you only need to specify a measurement parameter structure. If you want

to perform multiple coordinate transformations, you need to specify an array of measurement parameter structures. To learn how to perform multiple transformations, see the “Convert Detections to objectDetection Format” (Sensor Fusion and Tracking Toolbox) example.

Data Types: `struct`

Output Arguments

measurement_jac — Measurement Jacobian

real-valued 3-by- N matrix | real-valued 4-by- N matrix

Measurement Jacobian, specified as a real-valued 3-by- N or 4-by- N matrix. N is the dimension of the state vector. The interpretation of the rows and columns depends on the `frame` argument, as described in this table.

Frame	Measurement Jacobian
'rectangular'	Jacobian of the measurements $[x; y; z]$ with respect to the state vector. The measurement vector is with respect to the local coordinate system. Coordinates are in meters.
'spherical'	Jacobian of the measurement vector $[az; el; r; rr]$ with respect to the state vector. Measurement vector components specify the azimuth angle, elevation angle, range, and range rate of the object with respect to the local sensor coordinate system. Angle units are in degrees. Range units are in meters and range rate units are in meters/second.

More About

Azimuth and Elevation Angle Definitions

Define the azimuth and elevation angles used in the toolbox.

The azimuth angle of a vector is the angle between the x -axis and its orthogonal projection onto the xy plane. The angle is positive in going from the x axis toward the y axis. Azimuth angles lie between -180 and 180 degrees. The elevation angle is the angle between the vector and its orthogonal projection onto the xy -plane. The angle is positive when going toward the positive z -axis from the xy plane.

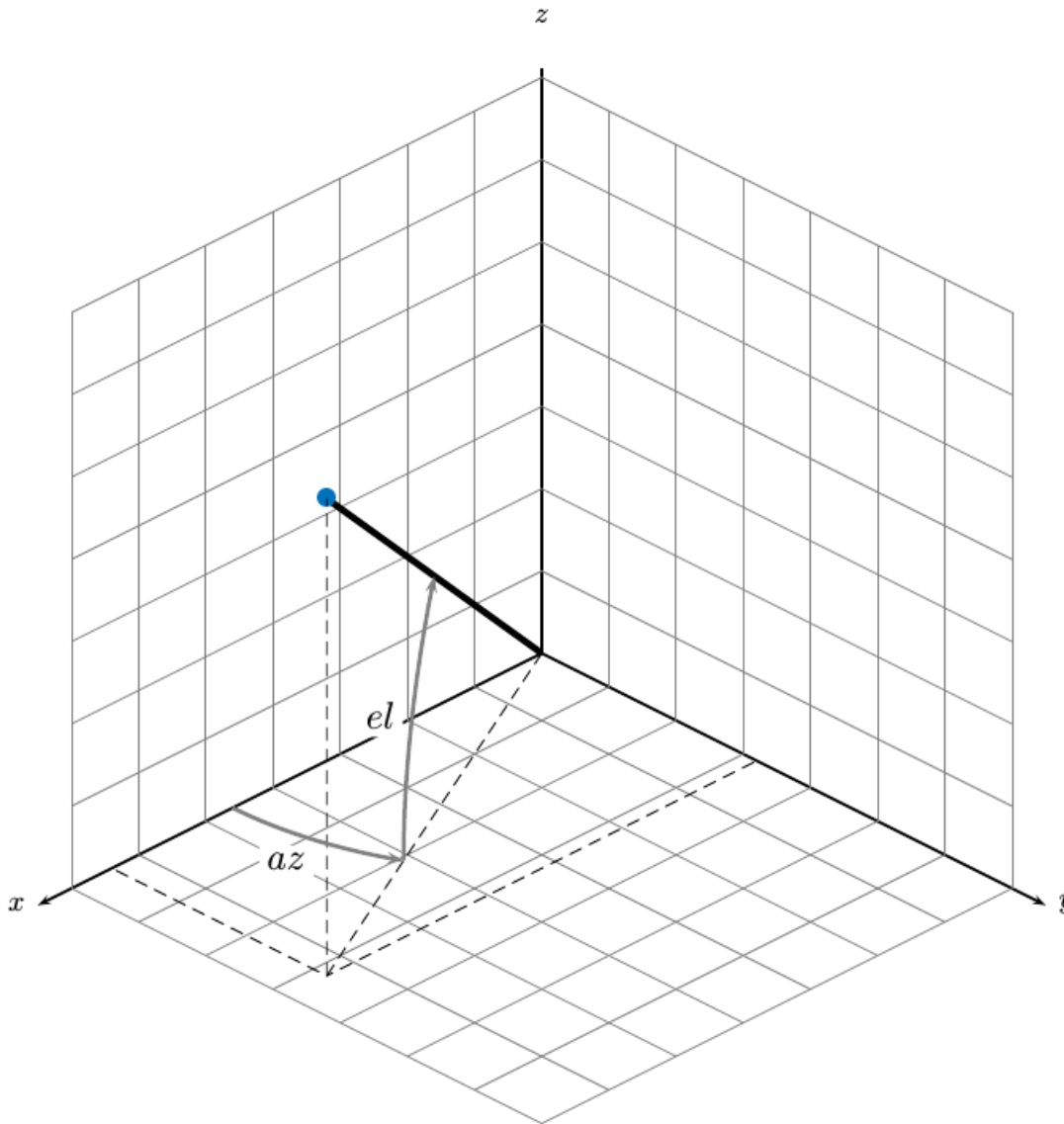

Version History

Introduced in R2017a

Extended Capabilities

C/C++ Code Generation

Generate C and C++ code using MATLAB® Coder™.

See Also

Functions

constacc | constaccjac | cameas | constturn | constturnjac | ctmeas | ctmeasjac | constvel | constveljac | cvmeas | cvmeasjac

Objects

trackingKF | trackingEKF | trackingUKF

projectedCuboidTo3D

Compute 3-D cuboid from 2-D projected cuboid

Syntax

```
cuboid = projectedCuboidTo3D(projectedCuboid,worldHeight,monoCam)
cuboid = projectedCuboidTo3D( ____,FrontFace=face)
```

Description

`cuboid = projectedCuboidTo3D(projectedCuboid,worldHeight,monoCam)` computes the 3-D cuboid from the 2-D projected cuboid `projectedCuboid`, the height data of the objects contained in the projected cuboids `worldHeight`, and the camera parameters for the sensor that collected the images `monoCam`.

`cuboid = projectedCuboidTo3D(____,FrontFace=face)` specifies which side of each 2-D projected cuboid to align with the front of the object, in addition to the input arguments from the previous syntax.

Examples

Compute 3-D Cuboids from 2-D Projected Cuboids

Specify the intrinsic parameter for a forward-facing, monocular camera sensor mounted on an ego vehicle. First, specify the focal length, the principal point of the image plane, and the output image size, in pixels.

```
focalLength = [309.4362 344.2161];
principalPoint = [318.9034 257.5352];
imageSize = [480 640];
```

Then specify the position of the camera. Position the camera 1.5 meters above the ground.

```
height = 1.5;
```

Save the intrinsic parameters as a `cameraIntrinsics` object. Define a monocular camera sensor using the intrinsic camera parameters and the position of the camera.

```
camIntrinsics = cameraIntrinsics(focalLength,principalPoint,imageSize);
sensor = monoCamera(camIntrinsics,height);
```

Define a pair of 2-D projected cuboids, specified as a 2-by-8 matrix.

```
projectedCuboidLabel = [302 573 255 202 376 533 255 202;
                       192 542 86 77 247 530 86 77];
```

Define the height of the objects contained within them in world units (m).

```
objectHeight = 1.5;
```

Estimate 3-D cuboids from the 2-D projected cuboids using the heights of the objects contained within them and the previously defined parameters of the monocular camera sensor.

```
cuboid = projectedCuboidTo3D(projectedCuboidLabel,objectHeight,sensor)
```

```
cuboid = 2×9
```

```
    2.3209   -1.1070    0.7500    0.5550    1.9126    1.5000         0         0   -90.0000
    2.3209    0.4231    0.7500    0.4125    0.6450    1.5000         0         0   -90.0000
```

Input Arguments

projectedCuboid — 2-D projected cuboids

M-by-8 matrix

2-D projected cuboids, specified as an *M*-by-8 matrix. *M* is the number of cuboids. Each row of the matrix defines the front and rear rectangular faces of a 2-D projected cuboid in the form $[x1\ y1\ w1\ h1\ x2\ y2, w2\ h2]$, where $[x1\ y1]$ and $[x2\ y2]$ specify the upper-left coordinates of the front and rear rectangular faces, and $[w1\ h1]$ and $[w2\ h2]$ specify the width and height of the corresponding faces respectively.

worldHeight — Heights of objects

real scalar | *M*-by-1 vector

Heights of objects in meters, specified as an *M*-by-1 vector or a real scalar. *M* is the number of objects.

monoCam — Camera parameters

monoCamera object

Camera parameters, specified as a monoCamera object. The object contains the intrinsic and extrinsic parameters of the camera used to capture the images.

face — Front face of the projected cuboids

"rear" (default) | "front"|"left"|"right" | *M*-by-1 string array

Front face of the projected cuboids, specified as "rear", "front", "left", "right", or an *M*-by-1 string array in which each element is "rear", "front", "left", or "right". *M* is the number of cuboids. This argument specifies which side of each projected 2-D cuboid is aligned with the front of the object contained within it.

- "rear" — Face of the 2-D projected cuboid furthest from the observer.
- "front" — Face of the 2-D projected cuboid closest to the observer.
- "left" — Face of the 2-D projected cuboid to the left from the perspective of the observer.
- "right" — Face of the 2-D projected cuboid to the right from the perspective of the observer.

If you specify this argument as a scalar value, the function applies that value to all input projected cuboids. If you specify this argument as an *M*-by-1 string array, the function applies the value of each element to the corresponding cuboid in `projectedCuboid`. Use this argument if the front of one or more detected objects is aligned with the left, right, or front of the cuboid that contains it. For example, if a detected vehicle is facing the sensor, specify the face value for that cuboid as "front".

Data Types: char | string

Output Arguments

cuboid — 3-D cuboids

M-by-9 matrix

3-D cuboids, returned as an *M*-by-9 matrix. *M* is the number of 3-D cuboids. Each row of the matrix defines the position, size, and orientation of a 3-D cuboid in the form [*xctr yctr zctr xlen ylen zlen xrot yrot zrot*]. The function assumes 0 degrees of roll and pitch, and only returns the yaw angle.

- Position — The center of the cuboid, in the vehicle coordinate system, is represented by *xctr*, *yctr*, *zctr*
- Size — The length of the cuboid in the *x*-, *y*- and *z*- directions is represented by *xlen*, *ylen*, and *zlen*, respectively.
- Orientation — The pitch, roll, and yaw angles, in degrees, are represented by *xrot*, *yrot*, *zrot*, respectively.

This diagram shows how the function determines the yaw angle (*zrot*) based on the angle between the face of the sensor that detected the cuboid and the selected front face of the cuboid. In this case, the value of *face* is "front".

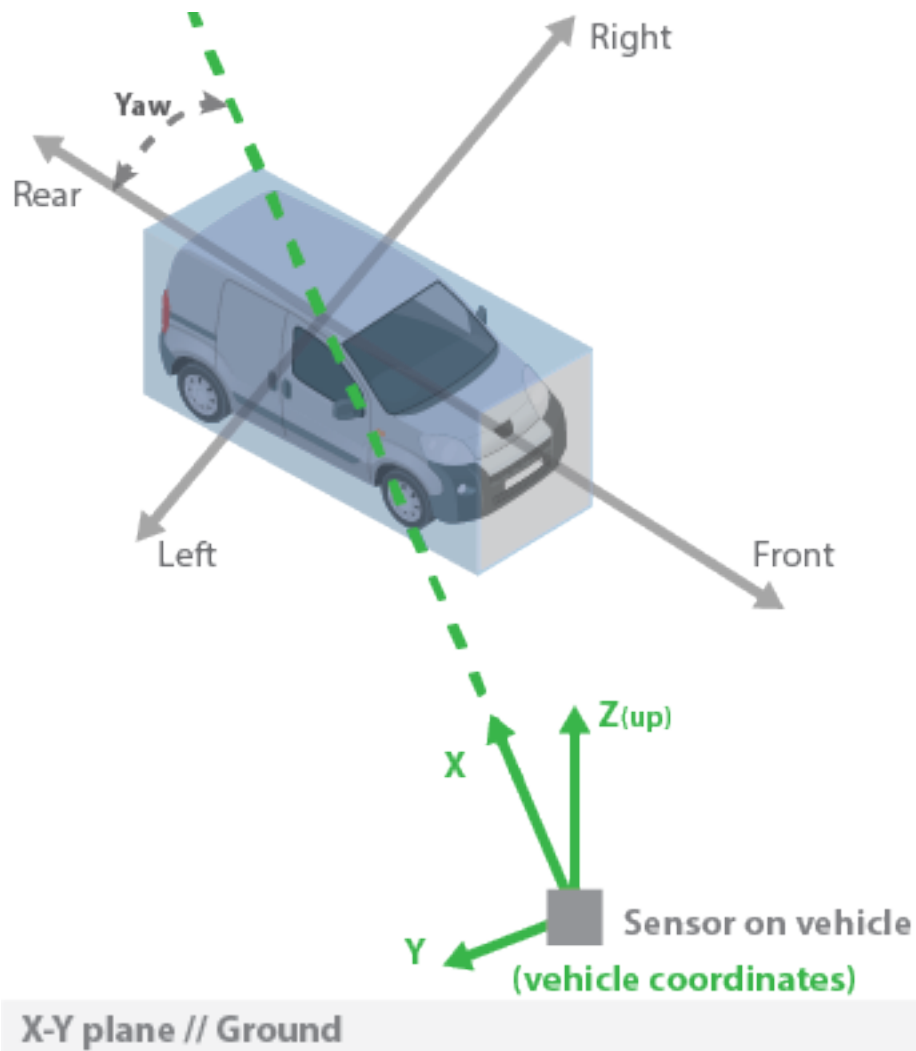

Version History

Introduced in R2022b

See Also

Apps

Camera Calibrator

Functions

`cuboid2img` | `estimateCameraParameters` | `estimateMonoCameraParameters`

Objects

`monoCamera` | `cameraIntrinsics` | `cameraParameters`

Topics

“Coordinate Systems in Automated Driving Toolbox”

checkPathValidity

Check validity of planned vehicle path

Syntax

```
isValid = checkPathValidity(refPath, costmap)  
isValid = checkPathValidity(refPoses, costmap)
```

Description

`isValid = checkPathValidity(refPath, costmap)` checks the validity of a planned vehicle path, `refPath`, against the vehicle costmap. Use this function to test if a path is valid within a changing environment.

A path is valid if the following conditions are true:

- The path has at least one pose.
- The path is collision-free and within the limits of costmap.

`isValid = checkPathValidity(refPoses, costmap)` checks the validity of a sequence of vehicle poses, `refPoses`, against the vehicle costmap.

Examples

Plan Path and Check Its Validity

Plan a vehicle path through a parking lot by using the optimal rapidly exploring random tree (RRT*) algorithm. Check that the path is valid, and then plot the transition poses along the path.

Load a costmap of a parking lot. Plot the costmap to see the parking lot and inflated areas for the vehicle to avoid.

```
data = load('parkingLotCostmap.mat');  
costmap = data.parkingLotCostmap;  
plot(costmap)
```

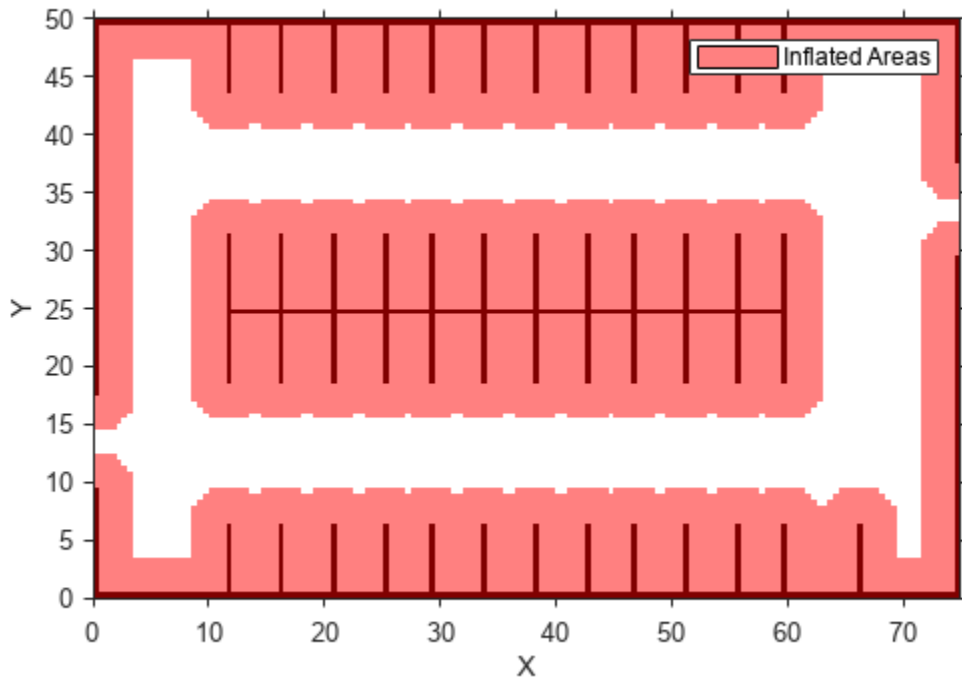
Define start and goal poses for the vehicle as $[x, y, \theta]$ vectors. World units for the (x,y) locations are in meters. World units for the θ orientation angles are in degrees.

```
startPose = [4, 4, 90]; % [meters, meters, degrees]
goalPose = [30, 13, 0];
```

Use a `pathPlannerRRT` object to plan a path from the start pose to the goal pose.

```
planner = pathPlannerRRT(costmap);
refPath = plan(planner,startPose,goalPose);
```

Check that the path is valid.

```
isPathValid = checkPathValidity(refPath,costmap)
isPathValid = logical
    1
```

Interpolate the transition poses along the path.

```
transitionPoses = interpolate(refPath);
```

Plot the planned path and the transition poses on the costmap.

```
hold on
plot(refPath,'DisplayName','Planned Path')
scatter(transitionPoses(:,1),transitionPoses(:,2),[],'filled', ...
```

```
'DisplayName','Transition Poses')
hold off
```

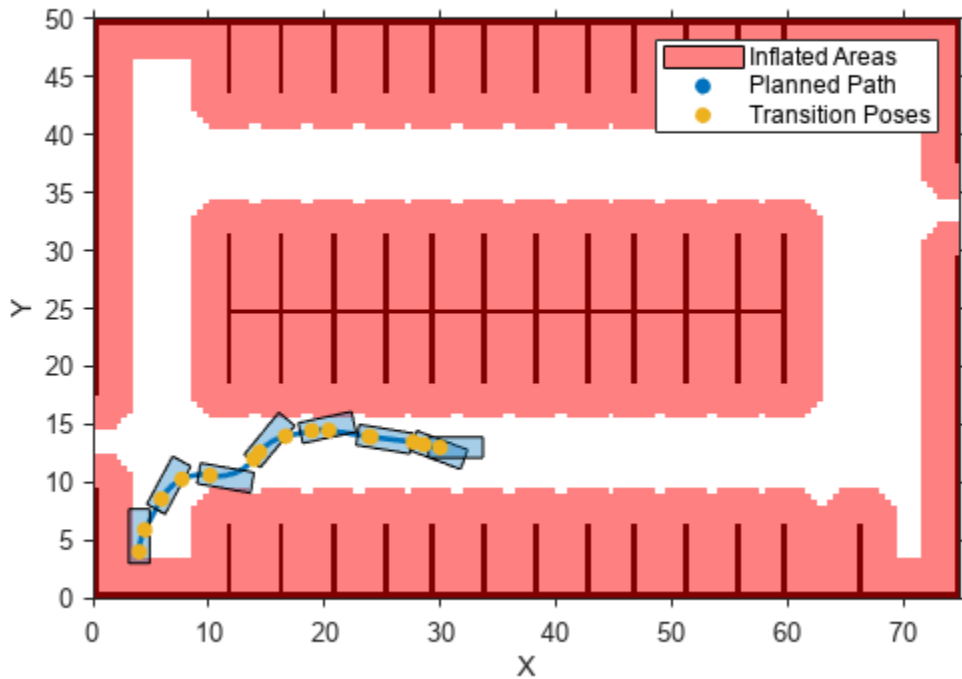

Input Arguments

refPath — Planned vehicle path

`driving.Path` object

Planned vehicle path, specified as a `driving.Path` object.

costmap — Costmap used for collision checking

`vehicleCostmap` object

Costmap used for collision checking, specified as a `vehicleCostmap` object.

refPoses — Sequence of vehicle poses

m -by-3 matrix of $[x, y, \theta]$ vectors

Sequence of vehicle poses, specified as an m -by-3 matrix of $[x, y, \theta]$ vectors. m is the number of specified poses.

x and y specify the location of the vehicle. These values must be in the same world units used by `costmap`.

θ specifies the orientation angle of the vehicle in degrees.

Output Arguments

isValid — Indicates validity of path or poses

1 | 0

Indicates validity of the planned vehicle path, `refPath`, or the sequence of vehicle poses, `refPoses`, returned as a logical value of 1 or 0.

A path or sequence of poses is valid (1) if the following conditions are true:

- The path or pose sequence has at least one pose.
- The path or pose sequence is collision-free and within the limits of `costmap`.

Algorithms

To check if a vehicle path is valid, the `checkPathValidity` function discretizes the path. Then, the function checks that the poses at the discretized points are collision-free. The threshold for a collision-free pose depends on the resolution at which `checkPathValidity` discretizes.

Version History

Introduced in R2018a

Extended Capabilities

C/C++ Code Generation

Generate C and C++ code using MATLAB® Coder™.

See Also

Functions

`plan` | `plot`

Objects

`driving.Path` | `vehicleCostmap` | `pathPlannerRRT`

Topics

“Automated Parking Valet”

configureDetectorMonoCamera

Configure object detector for using calibrated monocular camera

Syntax

```
configuredDetector = configureDetectorMonoCamera(detector, sensor, objectSize)
```

Description

`configuredDetector = configureDetectorMonoCamera(detector, sensor, objectSize)` configures any of these object detectors

- ACF (aggregate channel features)
- Faster R-CNN (regions with convolutional neural networks)
- Fast R-CNN
- YOLO v2 (you only look once v2)
- YOLO v3 (you only look once v3)
- YOLO v4 (you only look once v4)
- SSD (single shot detector),

to detect objects of a known size on a ground plane. Specify your trained object detector, `detector`, a camera configuration for transforming image coordinates to world coordinates, `sensor`, and the range of the object widths and lengths, `objectSize`.

Examples

Detect Vehicles Using Monocular Camera and ACF

Configure an ACF object detector for use with a monocular camera mounted on an ego vehicle. Use this detector to detect vehicles within video frames captured by the camera.

Load an `acfObjectDetector` object pretrained to detect vehicles.

```
detector = vehicleDetectorACF;
```

Model a monocular camera sensor by creating a `monoCamera` object. This object contains the camera intrinsics and the location of the camera on the ego vehicle.

```
focalLength = [309.4362 344.2161]; % [fx fy]
principalPoint = [318.9034 257.5352]; % [cx cy]
imageSize = [480 640]; % [mrows ncols]
height = 2.1798; % height of camera above ground, in meters
pitch = 14; % pitch of camera, in degrees
intrinsics = cameraIntrinsics(focalLength, principalPoint, imageSize);

monCam = monoCamera(intrinsics, height, 'Pitch', pitch);
```

Configure the detector for use with the camera. Limit the width of detected objects to a typical range for vehicle widths: 1.5-2.5 meters. The configured detector is an `acfObjectDetectorMonoCamera` object.

```
vehicleWidth = [1.5 2.5];  
detectorMonoCam = configureDetectorMonoCamera(detector, monCam, vehicleWidth);
```

Load a video captured from the camera, and create a video reader and player.

```
videoFile = fullfile(toolboxdir('driving'),'drivingdata','caltech_washington1.avi');  
reader = VideoReader(videoFile);  
videoPlayer = vision.VideoPlayer('Position',[29 597 643 386]);
```

Run the detector in a loop over the video. Annotate the video with the bounding boxes for the detections and the detection confidence scores.

```
cont = hasFrame(reader);  
while cont  
    I = readFrame(reader);  
  
    % Run the detector.  
    [bboxes,scores] = detect(detectorMonoCam,I);  
    if ~isempty(bboxes)  
        I = insertObjectAnnotation(I, ...  
                                   'rectangle',bboxes, ...  
                                   scores, ...  
                                   'Color','g');  
    end  
    videoPlayer(I)  
    % Exit the loop if the video player figure is closed.  
    cont = hasFrame(reader) && isOpen(videoPlayer);  
end  
  
release(videoPlayer);
```

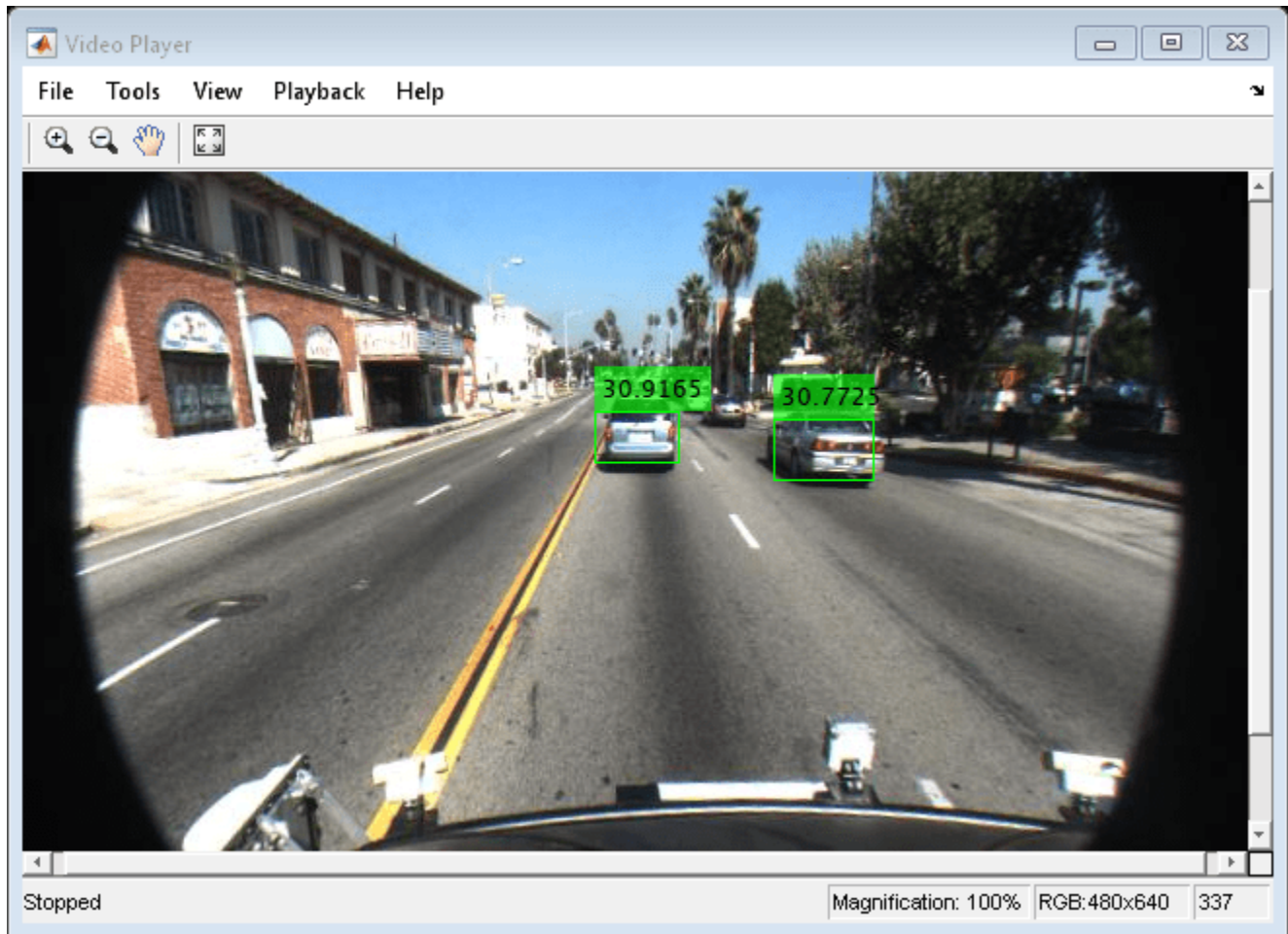

Input Arguments

detector – Object detector to configure

acfObjectDetector object | fastRCNNObjectDetector object | fasterRCNNObjectDetector object | yolov2ObjectDetector object | yolov3ObjectDetector object | yolov4ObjectDetector object | ssdObjectDetector object

Object detector to configure, specified as one of these object detector objects:

- acfObjectDetector
- fastRCNNObjectDetector
- fasterRCNNObjectDetector
- yolov2ObjectDetector
- yolov3ObjectDetector
- yolov4ObjectDetector
- ssdObjectDetector

Train the object detector before configuring them by using:

- `trainACFObjectDetector`
- `trainFastRCNNObjectDetector`
- `trainFasterRCNNObjectDetector`
- `trainYOLOv2ObjectDetector`
- `trainYOLOv4ObjectDetector`
- `trainSSDObjectDetector`

sensor — Camera configuration

`monoCamera` object

Camera configuration, specified as a `monoCamera` object. The object contains the camera intrinsics, the location, the pitch, yaw, and roll placement, and the world units for the parameters. Use the intrinsics to transform the object points in the image to world coordinates, which you can then compare to the `WorldObjectSize` property for detector.

objectSize — Range of object widths and lengths

`[minWidth maxWidth]` vector | `[minWidth maxWidth; minLength maxLength]` vector

Range of object widths and lengths in world units, specified as a `[minWidth maxWidth]` vector or `[minWidth maxWidth; minLength maxLength]` vector. Specifying the range of object lengths is optional.

Output Arguments

configuredDetector — Configured object detector

`acfObjectDetectorMonoCamera` object | `fastRCNNObjectDetectorMonoCamera` object | `fasterRCNNObjectDetectorMonoCamera` object | `yoloV2ObjectDetectorMonoCamera` | `yoloV3ObjectDetectorMonoCamera` | `yoloV4ObjectDetectorMonoCamera` | `ssdObjectDetectorMonoCamera`

Configured object detector, returned as one of these object detector objects:

- `acfObjectDetectorMonoCamera`
- `fastRCNNObjectDetectorMonoCamera`
- `fasterRCNNObjectDetectorMonoCamera`
- `yoloV2ObjectDetectorMonoCamera`
- `yoloV3ObjectDetectorMonoCamera`
- `yoloV4ObjectDetectorMonoCamera`
- `ssdObjectDetectorMonoCamera`

Version History

Introduced in R2017a

See Also

`acfObjectDetector` | `fastRCNNObjectDetector` | `fasterRCNNObjectDetector` | `acfObjectDetectorMonoCamera` | `fastRCNNObjectDetectorMonoCamera` | `fasterRCNNObjectDetectorMonoCamera` | `monoCamera` | `yoloV2ObjectDetectorMonoCamera`

| yolov3objectDetectorMonoCamera | yolov4objectDetectorMonoCamera |
ssdobjectDetectorMonoCamera

constacc

Constant-acceleration motion model

Syntax

```
updatedstate = constacc(state)
updatedstate = constacc(state,dt)
updatedstate = constacc(state,w,dt)
```

Description

`updatedstate = constacc(state)` returns the updated state, `state`, of a constant acceleration Kalman filter motion model for a step time of one second.

`updatedstate = constacc(state,dt)` specifies the time step, `dt`.

`updatedstate = constacc(state,w,dt)` also specifies the state noise, `w`.

Examples

Predict State for Constant-Acceleration Motion

Define an initial state for 2-D constant-acceleration motion.

```
state = [1;1;1;2;1;0];
```

Predict the state 1 second later.

```
state = constacc(state)
```

```
state = 6×1
```

```
 2.5000
 2.0000
 1.0000
 3.0000
 1.0000
 0
```

Predict State for Constant-Acceleration Motion With Specified Time Step

Define an initial state for 2-D constant-acceleration motion.

```
state = [1;1;1;2;1;0];
```

Predict the state 0.5 s later.

```
state = constacc(state,0.5)
```

```
state = 6×1
    1.6250
    1.5000
    1.0000
    2.5000
    1.0000
    0
```

Input Arguments

state — Kalman filter state

real-valued $3D$ -by- N matrix

Kalman filter state for constant-acceleration motion, specified as a real-valued $3D$ -by- N matrix. D is the number of spatial degrees of freedom of motion and N is the number states. For each spatial degree of motion, the state vector, as a column of the `state` matrix, takes the form shown in this table.

Spatial Dimensions	State Vector Structure
1-D	[x; vx; ax]
2-D	[x; vx; ax; y; vy; ay]
3-D	[x; vx; ax; y; vy; ay; z; vz; az]

For example, x represents the x -coordinate, vx represents the velocity in the x -direction, and ax represents the acceleration in the x -direction. If the motion model is in one-dimensional space, the y - and z -axes are assumed to be zero. If the motion model is in two-dimensional space, values along the z -axis are assumed to be zero. Position coordinates are in meters. Velocity coordinates are in meters/second. Acceleration coordinates are in meters/second².

Example: [5;0.1;0.01;0;-0.2;-0.01;-3;0.05;0]

Data Types: double

dt — Time step interval of filter

1.0 (default) | positive scalar

Time step interval of filter, specified as a positive scalar. Time units are in seconds.

Example: 0.5

Data Types: single | double

w — State noise

scalar | real-valued D -by- N matrix

State noise, specified as a scalar or real-valued D -by- N matrix. D is the number of spatial degrees of freedom of motion and N is the number of state vectors. If specified as a scalar, the scalar value is expanded to a D -by- N matrix.

Data Types: single | double

Output Arguments

updatedstate — Updated state vector

real-valued column or row vector | real-valued matrix

Updated state vector, returned as a real-valued vector or real-valued matrix with same number of elements and dimensions as the input state vector.

Algorithms

For a two-dimensional constant-acceleration process, the state transition matrix after a time step, T , is block diagonal:

$$\begin{bmatrix} x_{k+1} \\ vx_{k+1} \\ ax_{k+1} \\ y_{k+1} \\ vy_{k+1} \\ ay_{k+1} \end{bmatrix} = \begin{bmatrix} 1 & T & \frac{1}{2}T^2 & 0 & 0 & 0 \\ 0 & 1 & T & 0 & 0 & 0 \\ 0 & 0 & 1 & 0 & 0 & 0 \\ 0 & 0 & 0 & 1 & T & \frac{1}{2}T^2 \\ 0 & 0 & 0 & 0 & 1 & T \\ 0 & 0 & 0 & 0 & 0 & 1 \end{bmatrix} \begin{bmatrix} x_k \\ vx_k \\ ax_k \\ y_k \\ vy_k \\ ay_k \end{bmatrix}$$

The block for each spatial dimension has this form:

$$\begin{bmatrix} 1 & T & \frac{1}{2}T^2 \\ 0 & 1 & T \\ 0 & 0 & 1 \end{bmatrix}$$

For each additional spatial dimension, add an identical block.

Version History

Introduced in R2017a

Extended Capabilities

C/C++ Code Generation

Generate C and C++ code using MATLAB® Coder™.

See Also

Functions

constaccjac | cameas | cameasjac | constturn | constturnjac | ctmeas | ctmeasjac | constvel | constveljac | cvmeas | cvmeasjac

Objects

trackingKF | trackingEKF | trackingUKF

constaccjac

Jacobian for constant-acceleration motion

Syntax

```
jacobian = constaccjac(state)
jacobian = constaccjac(state,dt)
[jacobian,noisejacobian] = constaccjac(state,w,dt)
```

Description

`jacobian = constaccjac(state)` returns the updated Jacobian, `jacobian`, for a constant-acceleration Kalman filter motion model. The step time is one second. The `state` argument specifies the current state of the filter.

`jacobian = constaccjac(state,dt)` also specifies the time step, `dt`.

`[jacobian,noisejacobian] = constaccjac(state,w,dt)` specifies the state noise, `w`, and returns the Jacobian, `noisejacobian`, of the state with respect to the noise.

Examples

Compute State Jacobian for Constant-Acceleration Motion

Compute the state Jacobian for two-dimensional constant-acceleration motion.

Define an initial state and compute the state Jacobian for a one second update time.

```
state = [1,1,1,2,1,0];
jacobian = constaccjac(state)
```

```
jacobian = 6×6
```

```

    1.0000    1.0000    0.5000         0         0         0
         0    1.0000    1.0000         0         0         0
         0         0    1.0000         0         0         0
         0         0         0    1.0000    1.0000    0.5000
         0         0         0         0    1.0000    1.0000
         0         0         0         0         0    1.0000
```

Compute State Jacobian for Constant-Acceleration Motion with Specified Time Step

Compute the state Jacobian for two-dimensional constant-acceleration motion. Set the step time to 0.5 seconds.

```
state = [1,1,1,2,1,0].';
jacobian = constaccjac(state,0.5)
```

jacobian = 6×6

```

1.0000    0.5000    0.1250         0         0         0
    0    1.0000    0.5000         0         0         0
    0         0    1.0000         0         0         0
    0         0         0    1.0000    0.5000    0.1250
    0         0         0         0    1.0000    0.5000
    0         0         0         0         0    1.0000

```

Input Arguments

state — Kalman filter state vector

real-valued $3N$ -element vector

Kalman filter state vector for constant-acceleration motion, specified as a real-valued $3N$ -element vector. N is the number of spatial degrees of freedom of motion. For each spatial degree of motion, the state vector takes the form shown in this table.

Spatial Dimensions	State Vector Structure
1-D	[x; vx; ax]
2-D	[x; vx; ax; y; vy; ay]
3-D	[x; vx; ax; y; vy; ay; z; vz; az]

For example, x represents the x -coordinate, vx represents the velocity in the x -direction, and ax represents the acceleration in the x -direction. If the motion model is in one-dimensional space, the y - and z -axes are assumed to be zero. If the motion model is in two-dimensional space, values along the z -axis are assumed to be zero. Position coordinates are in meters. Velocity coordinates are in meters/second. Acceleration coordinates are in meters/second².

Example: [5;0.1;0.01;0;-0.2;-0.01;-3;0.05;0]

Data Types: double

dt — Time step interval of filter

1.0 (default) | positive scalar

Time step interval of filter, specified as a positive scalar. Time units are in seconds.

Example: 0.5

Data Types: single | double

w — State noise

scalar | real-valued N -by-1 vector

State noise, specified as a scalar or real-valued real valued N -by-1 vector. N is the number of motion dimensions. For example, $N = 2$ for the 2-D motion. If specified as a scalar, the scalar value is expanded to a N -by-1 vector.

Data Types: single | double

Output Arguments

jacobian — Constant-acceleration motion Jacobian

real-valued $3N$ -by- $3N$ matrix

Constant-acceleration motion Jacobian, returned as a real-valued $3N$ -by- $3N$ matrix.

noisejacobian — Constant acceleration motion noise Jacobian

real-valued $3N$ -by- N matrix

Constant acceleration motion noise Jacobian, returned as a real-valued $3N$ -by- N matrix. N is the number of spatial degrees of motion. For example, $N = 2$ for the 2-D motion. The Jacobian is constructed from the partial derivatives of the state at the updated time step with respect to the noise components.

Algorithms

For a two-dimensional constant-acceleration process, the Jacobian matrix after a time step, T , is block diagonal:

$$\begin{bmatrix} 1 & T & \frac{1}{2}T^2 & 0 & 0 & 0 \\ 0 & 1 & T & 0 & 0 & 0 \\ 0 & 0 & 1 & 0 & 0 & 0 \\ 0 & 0 & 0 & 1 & T & \frac{1}{2}T^2 \\ 0 & 0 & 0 & 0 & 1 & T \\ 0 & 0 & 0 & 0 & 0 & 1 \end{bmatrix}$$

The block for each spatial dimension has this form:

$$\begin{bmatrix} 1 & T & \frac{1}{2}T^2 \\ 0 & 1 & T \\ 0 & 0 & 1 \end{bmatrix}$$

For each additional spatial dimension, add an identical block.

Version History

Introduced in R2017a

Extended Capabilities

C/C++ Code Generation

Generate C and C++ code using MATLAB® Coder™.

See Also

Functions

constacc | cameas | cameasjac | constturn | constturnjac | ctmeas | ctmeasjac | constvel
| constveljac | cvmeas | cvmeasjac

Objects

trackingKF | trackingEKF | trackingUKF

constturn

Constant turn-rate motion model

Syntax

```
updatedstate = constturn(state)
updatedstate = constturn(state,dt)
updatedstate = constturn(state,w,dt)
```

Description

`updatedstate = constturn(state)` returns the updated state, `updatedstate`, obtained from the previous state, `state`, after a one-second step time for motion modelled as constant turn rate. Constant turn rate means that motion in the x-y plane follows a constant angular velocity and motion in the vertical z directions follows a constant velocity model.

`updatedstate = constturn(state,dt)` also specifies the time step, `dt`.

`updatedstate = constturn(state,w,dt)` also specifies noise, `w`.

Examples

Update State for Constant Turn-Rate Motion

Define an initial state for 2-D constant turn-rate motion. The turn rate is 12 degrees per second. Update the state to one second later.

```
state = [500,0,0,100,12].';
state = constturn(state)
```

```
state = 5×1
```

```
489.5662
-20.7912
99.2705
97.8148
12.0000
```

Update State for Constant Turn-Rate Motion with Specified Time Step

Define an initial state for 2-D constant turn-rate motion. The turn rate is 12 degrees per second. Update the state to 0.1 seconds later.

```
state = [500,0,0,100,12].';
state = constturn(state,0.1)
```

```
state = 5×1
```



```

499.8953
-2.0942
 9.9993
99.9781
12.0000

```

Input Arguments

state — State vector

real-valued 5-element vector | real-valued 7-element vector | 5-by- N real-valued matrix | 7-by- N real-valued matrix

State vector for a constant turn-rate motion model in two or three spatial dimensions, specified as a real-valued vector or matrix.

- When specified as a 5-element vector, the state vector describes 2-D motion in the x - y plane. You can specify the state vector as a row or column vector. The components of the state vector are $[x; vx; y; vy; \omega]$ where x represents the x -coordinate and vx represents the velocity in the x -direction. y represents the y -coordinate and vy represents the velocity in the y -direction. ω represents the turn rate.

When specified as a 5-by- N matrix, each column represents a different state vector. N represents the number of states.

- When specified as a 7-element vector, the state vector describes 3-D motion. You can specify the state vector as a row or column vector. The components of the state vector are $[x; vx; y; vy; \omega; z; vz]$ where x represents the x -coordinate and vx represents the velocity in the x -direction. y represents the y -coordinate and vy represents the velocity in the y -direction. ω represents the turn rate. z represents the z -coordinate and vz represents the velocity in the z -direction.

When specified as a 7-by- N matrix, each column represents a different state vector. N represents the number of states.

Position coordinates are in meters. Velocity coordinates are in meters/second. Turn rate is in degrees/second.

Example: `[5;0.1;4;-0.2;0.01]`

Data Types: `double`

dt — Time step interval of filter

1.0 (default) | positive scalar

Time step interval of filter, specified as a positive scalar. Time units are in seconds.

Example: `0.5`

Data Types: `single` | `double`

w — State noise

scalar | real-valued $(D+1)$ -by- N matrix

State noise, specified as a scalar or real-valued $(D+1)$ -length -by- N matrix. D is the number of motion dimensions and N is the number of state vectors. The components are each columns are

[ax;ay;alpha] for 2-D motion or [ax;ay;alpha;az] for 3-D motion. ax, ay, and az are the linear acceleration noise values in the x-, y-, and z-axes, respectively, and alpha is the angular acceleration noise value. If specified as a scalar, the value expands to a $(D+1)$ -by- N matrix.

Data Types: `single` | `double`

Output Arguments

updatedstate — Updated state vector

real-valued column or row vector | real-valued matrix

Updated state vector, returned as a real-valued vector or real-valued matrix with same number of elements and dimensions as the input state vector.

Version History

Introduced in R2017a

Extended Capabilities

C/C++ Code Generation

Generate C and C++ code using MATLAB® Coder™.

See Also

Functions

`constacc` | `constaccjac` | `cameas` | `cameasjac` | `constturnjac` | `ctmeas` | `ctmeasjac` | `constvel` | `constveljac` | `cvmeas` | `cvmeasjac` | `initctekf` | `initctukf`

Objects

`trackingEKF` | `trackingUKF`

constturnjac

Jacobian for constant turn-rate motion

Syntax

```
jacobian = constturnjac(state)
jacobian = constturnjac(state,dt)
[jacobian,noisejacobian] = constturnjac(state,w,dt)
```

Description

`jacobian = constturnjac(state)` returns the updated Jacobian, `jacobian`, for constant turn-rate Kalman filter motion model for a one-second step time. The `state` argument specifies the current state of the filter. Constant turn rate means that motion in the x-y plane follows a constant angular velocity and motion in the vertical z directions follows a constant velocity model.

`jacobian = constturnjac(state,dt)` specifies the time step, `dt`.

`[jacobian,noisejacobian] = constturnjac(state,w,dt)` also specifies noise, `w`, and returns the Jacobian, `noisejacobian`, of the state with respect to the noise.

Examples

Compute State Jacobian for Constant Turn-Rate Motion

Compute the Jacobian for a constant turn-rate motion state. Assume the turn rate is 12 degrees/second. The time step is one second.

```
state = [500,0,0,100,12];
jacobian = constturnjac(state)
```

`jacobian = 5×5`

```
1.0000    0.9927         0   -0.1043   -0.8631
         0    0.9781         0   -0.2079   -1.7072
         0    0.1043    1.0000    0.9927   -0.1213
         0    0.2079         0    0.9781   -0.3629
         0         0         0         0    1.0000
```

Compute State Jacobian for Constant Turn-Rate Motion with Specified Time Step

Compute the Jacobian for a constant turn-rate motion state. Assume the turn rate is 12 degrees/second. The time step is 0.1 second.

```
state = [500,0,0,100,12];
jacobian = constturnjac(state,0.1)
```

```

jacobian = 5x5
    1.0000    0.1000         0   -0.0010   -0.0087
         0    0.9998         0   -0.0209   -0.1745
         0    0.0010    1.0000    0.1000   -0.0001
         0    0.0209         0    0.9998   -0.0037
         0         0         0         0    1.0000

```

Input Arguments

state — State vector

real-valued 5-element vector | real-valued 7-element vector

State vector for a constant turn-rate motion model in two or three spatial dimensions, specified as a real-valued vector.

- When specified as a 5-element vector, the state vector describes 2-D motion in the x-y plane. You can specify the state vector as a row or column vector. The components of the state vector are `[x; vx; y; vy; omega]` where `x` represents the x-coordinate and `vx` represents the velocity in the x-direction. `y` represents the y-coordinate and `vy` represents the velocity in the y-direction. `omega` represents the turn rate.
- When specified as a 7-element vector, the state vector describes 3-D motion. You can specify the state vector as a row or column vector. The components of the state vector are `[x; vx; y; vy; omega; z; vz]` where `x` represents the x-coordinate and `vx` represents the velocity in the x-direction. `y` represents the y-coordinate and `vy` represents the velocity in the y-direction. `omega` represents the turn rate. `z` represents the z-coordinate and `vz` represents the velocity in the z-direction.

Position coordinates are in meters. Velocity coordinates are in meters/second. Turn rate is in degrees/second.

Example: `[5;0.1;4;-0.2;0.01]`

Data Types: `double`

dt — Time step interval of filter

1.0 (default) | positive scalar

Time step interval of filter, specified as a positive scalar. Time units are in seconds.

Example: `0.5`

Data Types: `single` | `double`

w — State noise

scalar | real-valued $(D+1)$ vector

State noise, specified as a scalar or real-valued M -by- $(D+1)$ -length vector. D is the number of motion dimensions. D is two for 2-D motion and D is three for 3-D motion. The vector components are `[ax; ay; alpha]` for 2-D motion or `[ax; ay; alpha; az]` for 3-D motion. `ax`, `ay`, and `az` are the linear acceleration noise values in the x-, y-, and z-axes, respectively, and `alpha` is the angular acceleration noise value. If specified as a scalar, the value expands to a $(D+1)$ vector.

Data Types: `single` | `double`

Output Arguments

jacobian — Constant turn-rate motion Jacobian

real-valued 5-by-5 matrix | real-valued 7-by-7 matrix

Constant turn-rate motion Jacobian, returned as a real-valued 5-by-5 matrix or 7-by-7 matrix depending on the size of the `state` vector. The Jacobian is constructed from the partial derivatives of the state at the updated time step with respect to the state at the previous time step.

noisejacobian — Constant turn-rate motion noise Jacobian

real-valued 5-by-5 matrix | real-valued 7-by-7 matrix

Constant turn-rate motion noise Jacobian, returned as a real-valued 5-by- $(D+1)$ matrix where D is two for 2-D motion or a real-valued 7-by- $(D+1)$ matrix where D is three for 3-D motion. The Jacobian is constructed from the partial derivatives of the state at the updated time step with respect to the noise components.

Version History

Introduced in R2017a

Extended Capabilities

C/C++ Code Generation

Generate C and C++ code using MATLAB® Coder™.

See Also

Functions

`constacc` | `constaccjac` | `cameas` | `cameasjac` | `constturn` | `ctmeas` | `ctmeasjac` | `constvel` | `constveljac` | `cvmeas` | `cvmeasjac` | `initctekf`

Objects

`trackingEKF`

constvel

Constant velocity state update

Syntax

```
updatedstate = constvel(state)
updatedstate = constvel(state,dt)
updatedstate = constvel(state,w,dt)
```

Description

`updatedstate = constvel(state)` returns the updated state, `state`, of a constant-velocity Kalman filter motion model after a one-second time step.

`updatedstate = constvel(state,dt)` specifies the time step, `dt`.

`updatedstate = constvel(state,w,dt)` also specifies state noise, `w`.

Examples

Update State for Constant-Velocity Motion

Update the state of two-dimensional constant-velocity motion for a time interval of one second.

```
state = [1;1;2;1];
state = constvel(state)
```

```
state = 4×1
```

```
    2
    1
    3
    1
```

Update State for Constant-Velocity Motion with Specified Time Step

Update the state of two-dimensional constant-velocity motion for a time interval of 1.5 seconds.

```
state = [1;1;2;1];
state = constvel(state,1.5)
```

```
state = 4×1
```

```
    2.5000
    1.0000
    3.5000
    1.0000
```

Input Arguments

state — Kalman filter state

real-valued $2D$ -by- N matrix

Kalman filter state for constant-velocity motion, specified as a real-valued $2D$ -by- N matrix. D is the number of spatial degrees of freedom of motion and N is the number states. The `state` is expected to be Cartesian state. For each spatial degree of motion, the state vector, as a column of the `state` matrix, takes the form shown in this table.

Spatial Dimensions	State Vector Structure
1-D	[x; vx]
2-D	[x; vx; y; vy]
3-D	[x; vx; y; vy; z; vz]

For example, x represents the x -coordinate and vx represents the velocity in the x -direction. If the motion model is 1-D, values along the y and z axes are assumed to be zero. If the motion model is 2-D, values along the z axis are assumed to be zero. Position coordinates are in meters and velocity coordinates are in meters/sec.

Example: [5; .1; 0; -.2; -3; .05]

Data Types: `single` | `double`

dt — Time step interval of filter

1.0 (default) | positive scalar

Time step interval of filter, specified as a positive scalar. Time units are in seconds.

Example: 0.5

Data Types: `single` | `double`

w — State noise

scalar | real-valued D -by- N matrix

State noise, specified as a scalar or real-valued D -by- N matrix. D is the number of spatial degrees of freedom of motion and N is the number of state vectors. For example, $D = 2$ for the 2-D motion. If specified as a scalar, the scalar value is expanded to a D -by- N matrix.

Data Types: `single` | `double`

Output Arguments

updatedstate — Updated state vector

real-valued column or row vector | real-valued matrix

Updated state vector, returned as a real-valued vector or real-valued matrix with same number of elements and dimensions as the input state vector.

Algorithms

For a two-dimensional constant-velocity process, the state transition matrix after a time step, T , is block diagonal as shown here.

$$\begin{bmatrix} x_{k+1} \\ v_{x,k+1} \\ y_{k+1} \\ v_{y,k+1} \end{bmatrix} = \begin{bmatrix} 1 & T & 0 & 0 \\ 0 & 1 & 0 & 0 \\ 0 & 0 & 1 & T \\ 0 & 0 & 0 & 1 \end{bmatrix} \begin{bmatrix} x_k \\ vx_k \\ y_k \\ vy_k \end{bmatrix}$$

The block for each spatial dimension is:

$$\begin{bmatrix} 1 & T \\ 0 & 1 \end{bmatrix}$$

For each additional spatial dimension, add an identical block.

Version History

Introduced in R2017a

Extended Capabilities

C/C++ Code Generation

Generate C and C++ code using MATLAB® Coder™.

See Also

Functions

constacc | constaccjac | cameas | cameasjac | constturn | constturnjac | ctmeas | ctmeasjac | constveljac | cvmeas | cvmeasjac

Objects

trackingKF | trackingEKF | trackingUKF

constveljac

Jacobian for constant-velocity motion

Syntax

```
jacobian = constveljac(state)
jacobian = constveljac(state,dt)
[jacobian,noisejacobian] = constveljac(state,w,dt)
```

Description

`jacobian = constveljac(state)` returns the updated Jacobian , `jacobian`, for a constant-velocity Kalman filter motion model for a step time of one second. The `state` argument specifies the current state of the filter.

`jacobian = constveljac(state,dt)` specifies the time step, `dt`.

`[jacobian,noisejacobian] = constveljac(state,w,dt)` specifies the state noise, `w`, and returns the Jacobian, `noisejacobian`, of the state with respect to the noise.

Examples

Compute State Jacobian for Constant-Velocity Motion

Compute the state Jacobian for a two-dimensional constant-velocity motion model for a one second update time.

```
state = [1,1,2,1].';
jacobian = constveljac(state)
```

```
jacobian = 4×4
```

```
    1    1    0    0
    0    1    0    0
    0    0    1    1
    0    0    0    1
```

Compute State Jacobian for Constant-Velocity Motion with Specified Time Step

Compute the state Jacobian for a two-dimensional constant-velocity motion model for a half-second update time.

```
state = [1;1;2;1];
```

Compute the state update Jacobian for 0.5 second.

```
jacobian = constveljac(state,0.5)
```

```
jacobian = 4x4
```

```

1.0000    0.5000         0         0
    0    1.0000         0         0
    0         0    1.0000    0.5000
    0         0         0    1.0000

```

Input Arguments

state — Kalman filter state vector

real-valued $2N$ -element vector

Kalman filter state vector for constant-velocity motion, specified as a real-valued $2N$ -element column vector where N is the number of spatial degrees of freedom of motion. The `state` is expected to be Cartesian state. For each spatial degree of motion, the state vector takes the form shown in this table.

Spatial Dimensions	State Vector Structure
1-D	[x; vx]
2-D	[x; vx; y; vy]
3-D	[x; vx; y; vy; z; vz]

For example, `x` represents the x -coordinate and `vx` represents the velocity in the x -direction. If the motion model is 1-D, values along the y and z axes are assumed to be zero. If the motion model is 2-D, values along the z axis are assumed to be zero. Position coordinates are in meters and velocity coordinates are in meters/sec.

Example: [5; .1; 0; - .2; -3; .05]

Data Types: `single` | `double`

dt — Time step interval of filter

1.0 (default) | positive scalar

Time step interval of filter, specified as a positive scalar. Time units are in seconds.

Example: 0.5

Data Types: `single` | `double`

w — State noise

scalar | real-valued N -by-1 vector

State noise, specified as a scalar or real-valued real valued N -by-1 vector. N is the number of motion dimensions. For example, $N = 2$ for the 2-D motion. If specified as a scalar, the scalar value is expanded to an N -by-1 vector.

Data Types: `single` | `double`

Output Arguments

jacobian — Constant-velocity motion Jacobian

real-valued $2N$ -by- $2N$ matrix

Constant-velocity motion Jacobian, returned as a real-valued $2N$ -by- $2N$ matrix. N is the number of spatial degrees of motion.

noisejacobian — Constant velocity motion noise Jacobian

real-valued $2N$ -by- N matrix

Constant velocity motion noise Jacobian, returned as a real-valued $2N$ -by- N matrix. N is the number of spatial degrees of motion. The Jacobian is constructed from the partial derivatives of the state at the updated time step with respect to the noise components.

Algorithms

For a two-dimensional constant-velocity motion, the Jacobian matrix for a time step, T , is block diagonal:

$$\begin{bmatrix} 1 & T & 0 & 0 \\ 0 & 1 & 0 & 0 \\ 0 & 0 & 1 & T \\ 0 & 0 & 0 & 1 \end{bmatrix}$$

The block for each spatial dimension has this form:

$$\begin{bmatrix} 1 & T \\ 0 & 1 \end{bmatrix}$$

For each additional spatial dimension, add an identical block.

Version History

Introduced in R2017a

Extended Capabilities

C/C++ Code Generation

Generate C and C++ code using MATLAB® Coder™.

See Also

Functions

constacc | constaccjac | cameas | cameasjac | constturn | constturnjac | ctmeas | ctmeasjac | constvel | cvmeas | cvmeasjac

Objects

trackingKF | trackingEKF | trackingUKF

ctmeas

Measurement function for constant turn-rate motion

Syntax

```
measurement = ctmeas(state)
measurement = ctmeas(state, frame)
measurement = ctmeas(state, frame, sensorpos)
measurement = ctmeas(state, frame, sensorpos, sensorvel)
measurement = ctmeas(state, frame, sensorpos, sensorvel, laxes)
measurement = ctmeas(state, measurementParameters)
[measurement, bounds] = ctmeas( ___ )
```

Description

`measurement = ctmeas(state)` returns the measurement for a constant turn-rate Kalman filter motion model in rectangular coordinates. The `state` argument specifies the current state of the filter.

`measurement = ctmeas(state, frame)` also specifies the measurement coordinate system, `frame`.

`measurement = ctmeas(state, frame, sensorpos)` also specifies the sensor position, `sensorpos`.

`measurement = ctmeas(state, frame, sensorpos, sensorvel)` also specifies the sensor velocity, `sensorvel`.

`measurement = ctmeas(state, frame, sensorpos, sensorvel, laxes)` also specifies the local sensor axes orientation, `laxes`.

`measurement = ctmeas(state, measurementParameters)` specifies the measurement parameters, `measurementParameters`.

`[measurement, bounds] = ctmeas(___)` returns the measurement bounds, used by a tracking filter (`trackingEKF` or `trackingUKF`) in residual calculations. See the `HasMeasurementWrapping` of the filter object for more details.

Examples

Create Measurement from Constant Turn-Rate Motion in Rectangular Frame

Create a measurement from an object undergoing constant turn-rate motion. The state is the position and velocity in each dimension and the turn-rate. The measurements are in rectangular coordinates.

```
state = [1;10;2;20;5];
measurement = ctmeas(state)
```

```
measurement = 3×1
```

```
1
2
0
```

The z-component of the measurement is zero.

Create Measurement from Constant Turn-Rate Motion in Spherical Frame

Define the state of an object in 2-D constant turn-rate motion. The state is the position and velocity in each dimension, and the turn rate. The measurements are in spherical coordinates.

```
state = [1;10;2;20;5];
measurement = ctmeas(state, 'spherical')
```

```
measurement = 4×1
```

```
63.4349
    0
  2.2361
 22.3607
```

The elevation of the measurement is zero and the range rate is positive indicating that the object is moving away from the sensor.

Create Measurement from Constant Turn-Rate Motion in Translated Spherical Frame

Define the state of an object moving in 2-D constant turn-rate motion. The state consists of position and velocity, and the turn rate. The measurements are in spherical coordinates with respect to a frame located at [20;40;0].

```
state = [1;10;2;20;5];
measurement = ctmeas(state, 'spherical', [20;40;0])
```

```
measurement = 4×1
```

```
-116.5651
    0
  42.4853
 -22.3607
```

The elevation of the measurement is zero and the range rate is negative indicating that the object is moving toward the sensor.

Create Measurement from Constant Turn-Rate Motion using Measurement Parameters

Define the state of an object moving in 2-D constant turn-rate motion. The state consists of position and velocity, and the turn rate. The measurements are in spherical coordinates with respect to a frame located at [20;40;0].

```
state2d = [1;10;2;20;5];
frame = 'spherical';
sensorpos = [20;40;0];
sensorvel = [0;5;0];
laxes = eye(3);
measurement = ctmeas(state2d,frame,sensorpos,sensorvel,laxes)
```

```
measurement = 4×1
```

```
-116.5651
         0
  42.4853
 -17.8885
```

The elevation of the measurement is zero and the range rate is negative indicating that the object is moving toward the sensor.

Put the measurement parameters in a structure and use the alternative syntax.

```
measparm = struct('Frame',frame,'OriginPosition',sensorpos, ...
    'OriginVelocity',sensorvel,'Orientation',laxes);
measurement = ctmeas(state2d,measparm)
```

```
measurement = 4×1
```

```
-116.5651
         0
  42.4853
 -17.8885
```

Display Residual Wrapping Bounds for ctmeas

Specify a 2-D state and specify a measurement structure such that the function outputs azimuth, range, and range-rate measurements.

```
state = [10 1 10 1 0.5]'; % [x vx y vy omega]'
mp = struct("Frame","Spherical", ...
    "HasAzimuth",true, ...
    "HasElevation",false, ...
    "HasRange",true, ...
    "HasVelocity",false);
```

Output the measurement and wrapping bounds using the ctmeas function.

```
[measure,bounds] = ctmeas(state,mp)
```

```
measure = 2×1
```

```
45.0000
14.1421
```

```
bounds = 2x2
```

```
-180    180
-Inf    Inf
```

Input Arguments

state — State vector

real-valued 5-element vector | real-valued 7-element vector | 5-by- N real-valued matrix | 7-by- N real-valued matrix

State vector for a constant turn-rate motion model in two or three spatial dimensions, specified as a real-valued vector or matrix.

- When specified as a 5-element vector, the state vector describes 2-D motion in the x - y plane. You can specify the state vector as a row or column vector. The components of the state vector are $[x; vx; y; vy; \omega]$ where x represents the x -coordinate and vx represents the velocity in the x -direction. y represents the y -coordinate and vy represents the velocity in the y -direction. ω represents the turn rate.

When specified as a 5-by- N matrix, each column represents a different state vector. N represents the number of states.

- When specified as a 7-element vector, the state vector describes 3-D motion. You can specify the state vector as a row or column vector. The components of the state vector are $[x; vx; y; vy; \omega; z; vz]$ where x represents the x -coordinate and vx represents the velocity in the x -direction. y represents the y -coordinate and vy represents the velocity in the y -direction. ω represents the turn rate. z represents the z -coordinate and vz represents the velocity in the z -direction.

When specified as a 7-by- N matrix, each column represents a different state vector. N represents the number of states.

Position coordinates are in meters. Velocity coordinates are in meters/second. Turn rate is in degrees/second.

Example: `[5;0.1;4;-0.2;0.01]`

Data Types: double

frame — Measurement output frame

'rectangular' (default) | 'spherical'

Measurement output frame, specified as 'rectangular' or 'spherical'. When the frame is 'rectangular', a measurement consists of x , y , and z Cartesian coordinates. When specified as 'spherical', a measurement consists of azimuth, elevation, range, and range rate.

Data Types: char

sensorpos — Sensor position

`[0;0;0]` (default) | real-valued 3-by-1 column vector

Sensor position with respect to the navigation frame, specified as a real-valued 3-by-1 column vector. Units are in meters.

Data Types: double

sensorvel – Sensor velocity

[0;0;0] (default) | real-valued 3-by-1 column vector

Sensor velocity with respect to the navigation frame, specified as a real-valued 3-by-1 column vector. Units are in m/s.

Data Types: double

laxes – Local sensor coordinate axes

[1,0,0;0,1,0;0,0,1] (default) | 3-by-3 orthogonal matrix

Local sensor coordinate axes, specified as a 3-by-3 orthogonal matrix. Each column specifies the direction of the local x-, y-, and z-axes, respectively, with respect to the navigation frame. That is, the matrix is the rotation matrix from the global frame to the sensor frame.

Data Types: double

measurementParameters – Measurement parameters

structure | array of structure

Measurement parameters, specified as a structure or an array of structures. The fields of the structure are:

Field	Description	Example
Frame	Frame used to report measurements, specified as one of these values: <ul style="list-style-type: none"> 'Rectangular' — Detections are reported in rectangular coordinates. 'Spherical' — Detections are reported in spherical coordinates. 	'spherical'
OriginPosition	Position offset of the origin of the frame relative to the parent frame, specified as an [x y z] real-valued vector.	[0 0 0]
OriginVelocity	Velocity offset of the origin of the frame relative to the parent frame, specified as a [vx vy vz] real-valued vector.	[0 0 0]
Orientation	Frame rotation matrix, specified as a 3-by-3 real-valued orthonormal matrix.	[1 0 0; 0 1 0; 0 0 1]

Field	Description	Example
HasAzimuth	Logical scalar indicating if azimuth is included in the measurement. This field is not relevant when the Frame field is 'Spherical'.	1
HasElevation	Logical scalar indicating if elevation information is included in the measurement. For measurements reported in a rectangular frame, and if HasElevation is false, the reported measurements assume 0 degrees of elevation.	1
HasRange	Logical scalar indicating if range is included in the measurement. This field is not relevant when the Frame is 'Spherical'.	1
HasVelocity	Logical scalar indicating if the reported detections include velocity measurements. For a measurement reported in the rectangular frame, if HasVelocity is false, the measurements are reported as [x y z]. If HasVelocity is true, the measurement is reported as [x y z vx vy vz]. For a measurement reported in the spherical frame, if HasVelocity is true, the measurement contains range-rate information.	1
IsParentToChild	Logical scalar indicating if Orientation performs a frame rotation from the parent coordinate frame to the child coordinate frame. When IsParentToChild is false, then Orientation performs a frame rotation from the child coordinate frame to the parent coordinate frame.	0

If you only want to perform one coordinate transformation, such as a transformation from the body frame to the sensor frame, you only need to specify a measurement parameter structure. If you want

to perform multiple coordinate transformations, you need to specify an array of measurement parameter structures. To learn how to perform multiple transformations, see the “Convert Detections to objectDetection Format” (Sensor Fusion and Tracking Toolbox) example.

Data Types: `struct`

Output Arguments

measurement — Measurement vector

real-valued M -by- N matrix

Measurement vector, returned as an M -by- N matrix. M is the dimension of the measurement and N , the number of measurement, is the same as the number of states. The form of each measurement depends upon which syntax you use.

- When the syntax does not use the `measurementParameters` argument, the measurement vector is $[x, y, z]$ when the `frame` input argument is set to 'rectangular' and $[az; el; r; rr]$ when the `frame` is set to 'spherical'.
- When the syntax uses the `measurementParameters` argument, the size of the measurement vector depends on the values of the `frame`, `HasVelocity`, and `HasElevation` fields in the `measurementParameters` structure.

frame	measurement			
'spherical'	Specifies the azimuth angle, az , elevation angle, el , range, r , and range rate, rr , of the object with respect to the local ego vehicle coordinate system. Positive values for range rate indicate that an object is moving away from the sensor.			
	Spherical measurements			
		HasElevation		
		false	true	
HasVelocity	false	$[az; r]$	$[az; el; r]$	
	true	$[az; r; rr]$	$[az; el; r; rr]$	
	Angle units are in degrees, range units are in meters, and range rate units are in m/s.			

frame	measurement									
'rectangular'	<p>Specifies the Cartesian position and velocity coordinates of the tracked object with respect to the ego vehicle coordinate system.</p> <p>Rectangular measurements</p> <table border="1"> <thead> <tr> <th>HasVelocity</th> <th></th> <th></th> </tr> </thead> <tbody> <tr> <td>false</td> <td></td> <td>[x;y;y]</td> </tr> <tr> <td>true</td> <td></td> <td>[x;y;z;vx;v y;vz]</td> </tr> </tbody> </table> <p>Position units are in meters and velocity units are in m/s.</p>	HasVelocity			false		[x;y;y]	true		[x;y;z;vx;v y;vz]
HasVelocity										
false		[x;y;y]								
true		[x;y;z;vx;v y;vz]								

Data Types: double

bounds — Measurement residual wrapping bounds

M-by-2 real-valued matrix

Measurement residual wrapping bounds, returned as an *M*-by-2 real-valued matrix, where *M* is the dimension of the measurement. Each row of the matrix corresponds to the lower and upper bounds for the specific dimension in the `measurement` output.

The function returns different bound values based on the `frame` input.

- If the `frame` input is specified as 'Rectangular', each row of the matrix is [-Inf Inf], indicating the filter does not wrap the measurement residual in the filter.
- If the `frame` input is specified as 'Spherical', the returned `bounds` contains the bounds for specific measurement dimension based on the following:
 - When `HasAzimuth = true`, the matrix includes a row of [-180 180], indicating the filter wraps the azimuth residual in the range of [-180 180] in degrees.
 - When `HasElevation = true`, the matrix includes a row of [-90 90], indicating the filter wraps the elevation residual in the range of [-90 90] in degrees.
 - When `HasRange = true`, the matrix includes a row of [-Inf Inf], indicating the filter does not wrap the range residual.
 - When `HasVelocity = true`, the matrix includes a row of [-Inf Inf], indicating the filter does not wrap the range rate residual.

If you specify any of the options as `false`, the returned `bounds` does not contain the corresponding row. For example, if `HasAzimuth = true`, `HasElevation = false`, `HasRange = true`, `HasVelocity = true`, then `bounds` is returned as

```
-180  180
-Inf  Inf
-Inf  Inf
```

The filter wraps the measuring residuals based on this equation:

$$x_{wrap} = \text{mod}\left(x - \frac{a-b}{2}, b-a\right) + \frac{a-b}{2}$$

where x is the residual to wrap, a is the lower bound, b is the upper bound, mod is the modules after division function, and x_{wrap} is the wrapped residual.

Data Types: `single` | `double`

More About

Azimuth and Elevation Angle Definitions

Define the azimuth and elevation angles used in the toolbox.

The azimuth angle of a vector is the angle between the x -axis and its orthogonal projection onto the xy plane. The angle is positive in going from the x axis toward the y axis. Azimuth angles lie between -180 and 180 degrees. The elevation angle is the angle between the vector and its orthogonal projection onto the xy -plane. The angle is positive when going toward the positive z -axis from the xy plane.

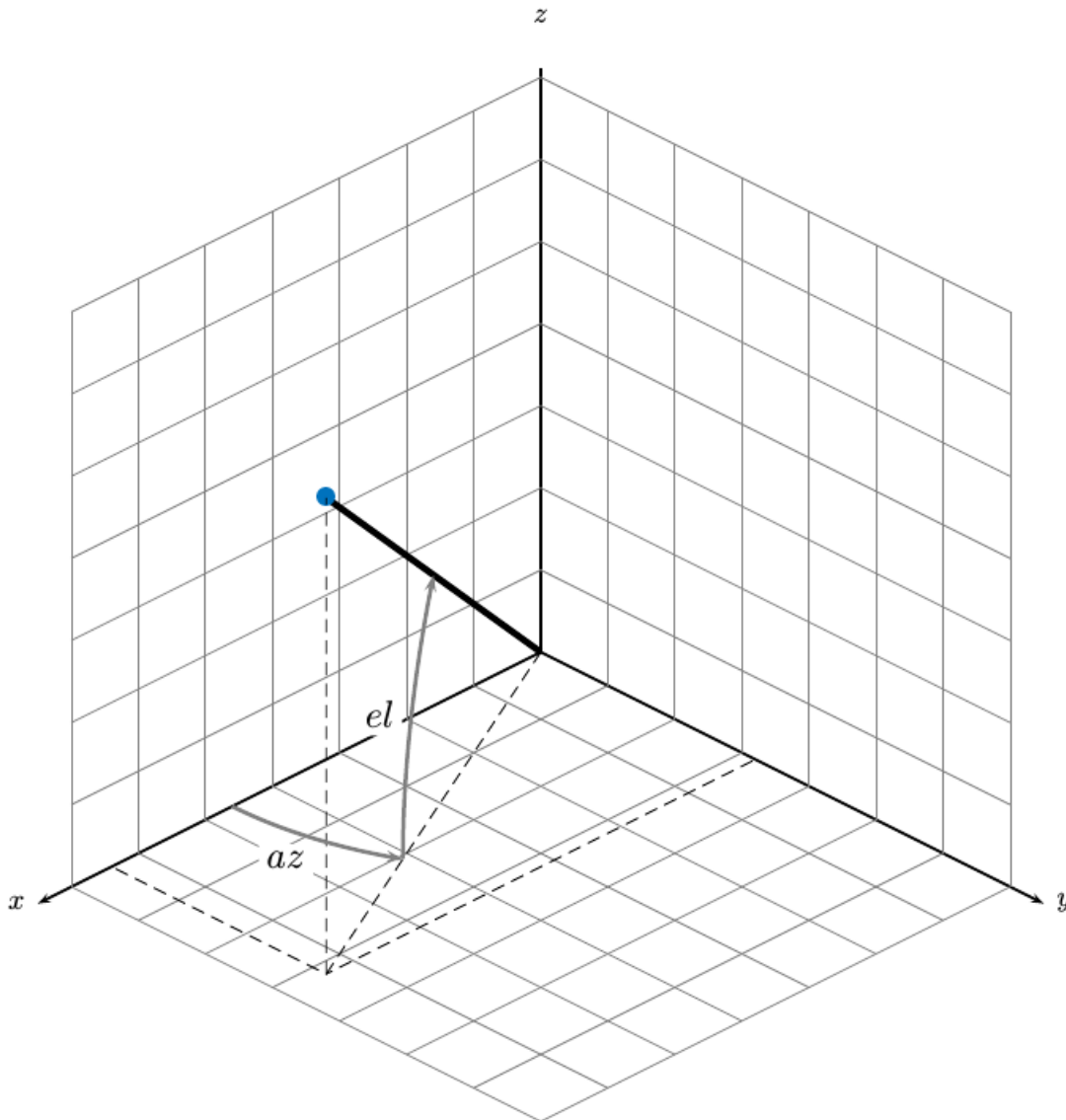

Version History

Introduced in R2017a

Extended Capabilities

C/C++ Code Generation

Generate C and C++ code using MATLAB® Coder™.

See Also

Functions

constacc | constaccjac | cameas | cameasjac | constturn | constturnjac | ctmeasjac | constvel | constveljac | cvmeas | cvmeasjac

Objects

trackingKF | trackingEKF | trackingUKF

ctmeasjac

Jacobian of measurement function for constant turn-rate motion

Syntax

```
measurementjac = ctmeasjac(state)
measurementjac = ctmeasjac(state, frame)
measurementjac = ctmeasjac(state, frame, sensorpos)
measurementjac = ctmeasjac(state, frame, sensorpos, sensorvel)
measurementjac = ctmeasjac(state, frame, sensorpos, sensorvel, laxes)
measurementjac = ctmeasjac(state, measurementParameters)
```

Description

`measurementjac = ctmeasjac(state)` returns the measurement Jacobian, `measurementjac`, for a constant turn-rate Kalman filter motion model in rectangular coordinates. `state` specifies the current state of the track.

`measurementjac = ctmeasjac(state, frame)` also specifies the measurement coordinate system, `frame`.

`measurementjac = ctmeasjac(state, frame, sensorpos)` also specifies the sensor position, `sensorpos`.

`measurementjac = ctmeasjac(state, frame, sensorpos, sensorvel)` also specifies the sensor velocity, `sensorvel`.

`measurementjac = ctmeasjac(state, frame, sensorpos, sensorvel, laxes)` also specifies the local sensor axes orientation, `laxes`.

`measurementjac = ctmeasjac(state, measurementParameters)` specifies the measurement parameters, `measurementParameters`.

Examples

Measurement Jacobian of Constant Turn-Rate Motion in Rectangular Frame

Define the state of an object in 2-D constant turn-rate motion. The state is the position and velocity in each dimension, and the turn rate. Construct the measurement Jacobian in rectangular coordinates.

```
state = [1;10;2;20;5];
jacobian = ctmeasjac(state)
```

```
jacobian = 3×5
```

```
    1    0    0    0    0
    0    0    1    0    0
    0    0    0    0    0
```

Measurement Jacobian of Constant Turn-Rate Motion in Spherical Frame

Define the state of an object in 2-D constant turn-rate motion. The state is the position and velocity in each dimension, and the turn rate. Compute the measurement Jacobian with respect to spherical coordinates.

```
state = [1;10;2;20;5];
measurementjac = ctmeasjac(state, 'spherical')
```

```
measurementjac = 4x5
```

```
-22.9183      0    11.4592      0      0
      0      0      0      0      0
  0.4472      0    0.8944      0      0
  0.0000    0.4472    0.0000    0.8944      0
```

Measurement Jacobian of Constant Turn-Rate Object in Translated Spherical Frame

Define the state of an object in 2-D constant turn-rate motion. The state is the position and velocity in each dimension, and the turn rate. Compute the measurement Jacobian with respect to spherical coordinates centered at [5; -20; 0].

```
state = [1;10;2;20;5];
sensorpos = [5;-20;0];
measurementjac = ctmeasjac(state, 'spherical', sensorpos)
```

```
measurementjac = 4x5
```

```
-2.5210      0   -0.4584      0      0
      0      0      0      0      0
-0.1789      0    0.9839      0      0
 0.5903   -0.1789    0.1073    0.9839      0
```

Measurement Jacobian of Constant Turn-Rate Object Using Measurement Parameters

Define the state of an object in 2-D constant turn-rate motion. The state is the position and velocity in each dimension, and the turn rate. Compute the measurement Jacobian with respect to spherical coordinates centered at [25; -40; 0].

```
state2d = [1;10;2;20;5];
sensorpos = [25,-40,0].';
frame = 'spherical';
sensorvel = [0;5;0];
laxes = eye(3);
measurementjac = ctmeasjac(state2d, frame, sensorpos, sensorvel, laxes)
```

```
measurementjac = 4x5
```



```

-1.0284      0   -0.5876      0      0
      0      0      0      0      0
-0.4961      0   0.8682      0      0
0.2894   -0.4961   0.1654   0.8682   0

```

Put the measurement parameters in a structure and use the alternative syntax.

```

measparm = struct('Frame',frame,'OriginPosition',sensorpos,'OriginVelocity',sensorvel, ...
    'Orientation',laxes);
measurementjac = ctmeasjac(state2d,measparm)

```

```
measurementjac = 4x5
```

```

-1.0284      0   -0.5876      0      0
      0      0      0      0      0
-0.4961      0   0.8682      0      0
0.2894   -0.4961   0.1654   0.8682   0

```

Input Arguments

state — State vector

real-valued 5-element vector | real-valued 7-element vector | 5-by- N real-valued matrix | 7-by- N real-valued matrix

State vector for a constant turn-rate motion model in two or three spatial dimensions, specified as a real-valued vector or matrix.

- When specified as a 5-element vector, the state vector describes 2-D motion in the x - y plane. You can specify the state vector as a row or column vector. The components of the state vector are $[x; vx; y; vy; \omega]$ where x represents the x -coordinate and vx represents the velocity in the x -direction. y represents the y -coordinate and vy represents the velocity in the y -direction. ω represents the turn rate.

When specified as a 5-by- N matrix, each column represents a different state vector N represents the number of states.

- When specified as a 7-element vector, the state vector describes 3-D motion. You can specify the state vector as a row or column vector. The components of the state vector are $[x; vx; y; vy; \omega; z; vz]$ where x represents the x -coordinate and vx represents the velocity in the x -direction. y represents the y -coordinate and vy represents the velocity in the y -direction. ω represents the turn rate. z represents the z -coordinate and vz represents the velocity in the z -direction.

When specified as a 7-by- N matrix, each column represents a different state vector. N represents the number of states.

Position coordinates are in meters. Velocity coordinates are in meters/second. Turn rate is in degrees/second.

Example: `[5;0.1;4;-0.2;0.01]`

Data Types: double

frame — Measurement output frame

'rectangular' (default) | 'spherical'

Measurement output frame, specified as 'rectangular' or 'spherical'. When the frame is 'rectangular', a measurement consists of x, y, and z Cartesian coordinates. When specified as 'spherical', a measurement consists of azimuth, elevation, range, and range rate.

Data Types: char

sensorpos — Sensor position

[0;0;0] (default) | real-valued 3-by-1 column vector

Sensor position with respect to the navigation frame, specified as a real-valued 3-by-1 column vector. Units are in meters.

Data Types: double

sensorvel — Sensor velocity

[0;0;0] (default) | real-valued 3-by-1 column vector

Sensor velocity with respect to the navigation frame, specified as a real-valued 3-by-1 column vector. Units are in m/s.

Data Types: double

laxes — Local sensor coordinate axes

[1,0,0;0,1,0;0,0,1] (default) | 3-by-3 orthogonal matrix

Local sensor coordinate axes, specified as a 3-by-3 orthogonal matrix. Each column specifies the direction of the local x-, y-, and z-axes, respectively, with respect to the navigation frame. That is, the matrix is the rotation matrix from the global frame to the sensor frame.

Data Types: double

measurementParameters — Measurement parameters

structure | array of structure

Measurement parameters, specified as a structure or an array of structures. The fields of the structure are:

Field	Description	Example
Frame	<p>Frame used to report measurements, specified as one of these values:</p> <ul style="list-style-type: none"> 'Rectangular' — Detections are reported in rectangular coordinates. 'Spherical' — Detections are reported in spherical coordinates. 	'spherical'

Field	Description	Example
OriginPosition	Position offset of the origin of the frame relative to the parent frame, specified as an [x y z] real-valued vector.	[0 0 0]
OriginVelocity	Velocity offset of the origin of the frame relative to the parent frame, specified as a [vx vy vz] real-valued vector.	[0 0 0]
Orientation	Frame rotation matrix, specified as a 3-by-3 real-valued orthonormal matrix.	[1 0 0; 0 1 0; 0 0 1]
HasAzimuth	Logical scalar indicating if azimuth is included in the measurement. This field is not relevant when the Frame field is 'Spherical'.	1
HasElevation	Logical scalar indicating if elevation information is included in the measurement. For measurements reported in a rectangular frame, and if HasElevation is false, the reported measurements assume 0 degrees of elevation.	1
HasRange	Logical scalar indicating if range is included in the measurement. This field is not relevant when the Frame is 'Spherical'.	1
HasVelocity	Logical scalar indicating if the reported detections include velocity measurements. For a measurement reported in the rectangular frame, if HasVelocity is false, the measurements are reported as [x y z]. If HasVelocity is true, the measurement is reported as [x y z vx vy vz]. For a measurement reported in the spherical frame, if HasVelocity is true, the measurement contains range-rate information.	1

Field	Description	Example
IsParentToChild	Logical scalar indicating if <code>Orientation</code> performs a frame rotation from the parent coordinate frame to the child coordinate frame. When <code>IsParentToChild</code> is false, then <code>Orientation</code> performs a frame rotation from the child coordinate frame to the parent coordinate frame.	0

If you only want to perform one coordinate transformation, such as a transformation from the body frame to the sensor frame, you only need to specify a measurement parameter structure. If you want to perform multiple coordinate transformations, you need to specify an array of measurement parameter structures. To learn how to perform multiple transformations, see the “Convert Detections to objectDetection Format” (Sensor Fusion and Tracking Toolbox) example.

Data Types: struct

Output Arguments

measurement_jac — Measurement Jacobian

real-valued 3-by-5 matrix | real-valued 4-by-5 matrix

Measurement Jacobian, returned as a real-valued 3-by-5 or 4-by-5 matrix. The row dimension and interpretation depend on value of the `frame` argument.

Frame	Measurement Jacobian
'rectangular'	Jacobian of the measurements $[x; y; z]$ with respect to the state vector. The measurement vector is with respect to the local coordinate system. Coordinates are in meters.
'spherical'	Jacobian of the measurement vector $[az; el; r; rr]$ with respect to the state vector. Measurement vector components specify the azimuth angle, elevation angle, range, and range rate of the object with respect to the local sensor coordinate system. Angle units are in degrees. Range units are in meters and range rate units are in meters/second.

More About

Azimuth and Elevation Angle Definitions

Define the azimuth and elevation angles used in the toolbox.

The azimuth angle of a vector is the angle between the x -axis and its orthogonal projection onto the xy plane. The angle is positive in going from the x axis toward the y axis. Azimuth angles lie between -180 and 180 degrees. The elevation angle is the angle between the vector and its orthogonal

projection onto the xy -plane. The angle is positive when going toward the positive z -axis from the xy plane.

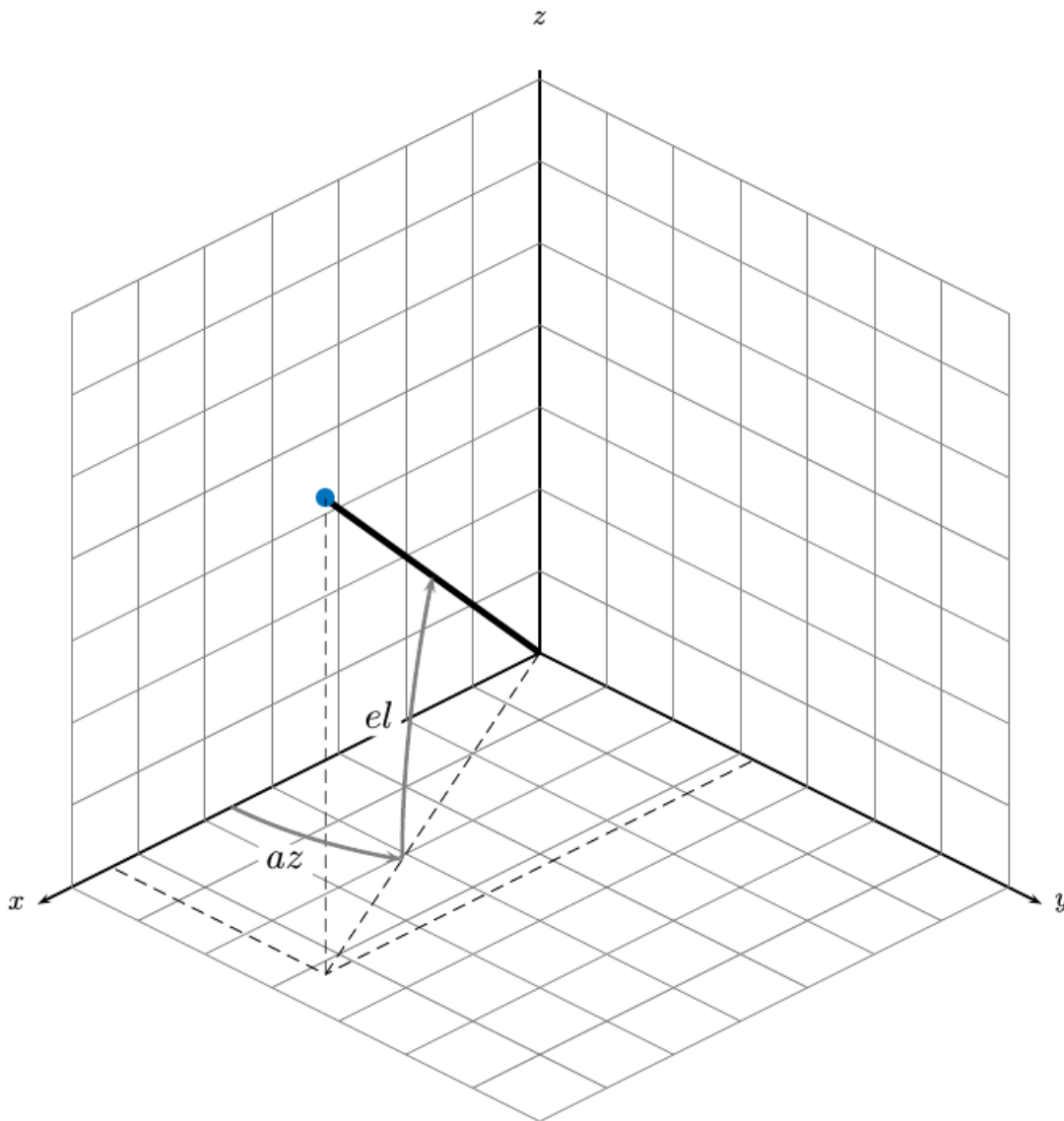

Version History

Introduced in R2017a

Extended Capabilities

C/C++ Code Generation

Generate C and C++ code using MATLAB® Coder™.

See Also

Functions

constacc | constaccjac | cameas | cameasjac | constturn | constturnjac | ctmeas | constvel | constveljac | cvmeas | cvmeasjac

Objects

trackingKF | trackingEKF | trackingUKF

cvmeas

Measurement function for constant velocity motion

Syntax

```
measurement = cvmeas(state)
measurement = cvmeas(state, frame)
measurement = cvmeas(state, frame, sensorpos)
measurement = cvmeas(state, frame, sensorpos, sensorvel)
measurement = cvmeas(state, frame, sensorpos, sensorvel, laxes)
measurement = cvmeas(state, measurementParameters)
[measurement, bounds] = cvmeas( ___ )
```

Description

`measurement = cvmeas(state)` returns the measurement for a constant-velocity Kalman filter motion model in rectangular coordinates. The `state` argument specifies the current state of the tracking filter.

`measurement = cvmeas(state, frame)` also specifies the measurement coordinate system, `frame`.

`measurement = cvmeas(state, frame, sensorpos)` also specifies the sensor position, `sensorpos`.

`measurement = cvmeas(state, frame, sensorpos, sensorvel)` also specifies the sensor velocity, `sensorvel`.

`measurement = cvmeas(state, frame, sensorpos, sensorvel, laxes)` specifies the local sensor axes orientation, `laxes`.

`measurement = cvmeas(state, measurementParameters)` specifies the measurement parameters, `measurementParameters`.

`[measurement, bounds] = cvmeas(___)` returns the measurement bounds, used by a tracking filter (`trackingEKF` or `trackingUKF`) in residual calculations. See the `HasMeasurementWrapping` of the filter object for more details.

Examples

Create Measurement from Constant-Velocity Object in Rectangular Frame

Define the state of an object in 2-D constant-velocity motion. The state is the position and velocity in both dimensions. The measurements are in rectangular coordinates.

```
state = [1;10;2;20];
measurement = cvmeas(state)
```

```
measurement = 3×1
```

```
1  
2  
0
```

The z-component of the measurement is zero.

Create Measurement from Constant Velocity Object in Spherical Frame

Define the state of an object in 2-D constant-velocity motion. The state is the position and velocity in each spatial dimension. The measurements are in spherical coordinates.

```
state = [1;10;2;20];  
measurement = cvmeas(state, 'spherical')
```

```
measurement = 4x1
```

```
63.4349  
0  
2.2361  
22.3607
```

The elevation of the measurement is zero and the range rate is positive. These results indicate that the object is moving away from the sensor.

Create Measurement from Constant-Velocity Object in Translated Spherical Frame

Define the state of an object in 2-D constant-velocity motion. The state consists of position and velocity in each spatial dimension. The measurements are in spherical coordinates with respect to a frame located at (20;40;0) meters.

```
state = [1;10;2;20];  
measurement = cvmeas(state, 'spherical', [20;40;0])
```

```
measurement = 4x1
```

```
-116.5651  
0  
42.4853  
-22.3607
```

The elevation of the measurement is zero and the range rate is negative. These results indicate that the object is moving toward the sensor.

Create Measurement from Constant-Velocity Object Using Measurement Parameters

Define the state of an object in 2-D constant-velocity motion. The state consists of position and velocity in each spatial dimension. The measurements are in spherical coordinates with respect to a frame located at (20;40;0) meters.

```
state2d = [1;10;2;20];
frame = 'spherical';
sensorpos = [20;40;0];
sensorvel = [0;5;0];
laxes = eye(3);
measurement = cvmeas(state2d,frame,sensorpos,sensorvel,laxes)
```

```
measurement = 4×1
```

```
-116.5651
      0
  42.4853
 -17.8885
```

The elevation of the measurement is zero and the range rate is negative. These results indicate that the object is moving toward the sensor.

Put the measurement parameters in a structure and use the alternative syntax.

```
measparm = struct('Frame',frame,'OriginPosition',sensorpos,'OriginVelocity',sensorvel, ...
    'Orientation',laxes);
measurement = cvmeas(state2d,measparm)
```

```
measurement = 4×1
```

```
-116.5651
      0
  42.4853
 -17.8885
```

Display Residual Wrapping Bounds for cvmeas

Specify a 2-D state and specify a measurement structure such that the function outputs azimuth, range, and range-rate measurements.

```
state = [10 1 10 1]'; % [x vx y vy]'
mp = struct("Frame","Spherical", ...
    "HasAzimuth",true, ...
    "HasElevation",false, ...
    "HasRange",true, ...
    "HasVelocity",false);
```

Output the measurement and wrapping bounds using the cvmeas function.

```
[measure,bounds] = cvmeas(state,mp)
```

```
measure = 2×1
```

```
45.0000
14.1421
```

```
bounds = 2x2
```

```
-180  180
-Inf  Inf
```

Input Arguments

state — Kalman filter state vector

real-valued $2D$ -by- N matrix

Kalman filter state vector for constant-velocity motion, specified as a real-valued $2D$ -by- N matrix. D is the number of spatial degrees of freedom of motion and N is the number states. The state is expected to be Cartesian state. For each spatial degree of motion, the state vector, as a column of the state matrix, takes the form shown in this table.

Spatial Dimensions	State Vector Structure
1-D	$[x; vx]$
2-D	$[x; vx; y; vy]$
3-D	$[x; vx; y; vy; z; vz]$

For example, x represents the x -coordinate and vx represents the velocity in the x -direction. If the motion model is 1-D, values along the y and z axes are assumed to be zero. If the motion model is 2-D, values along the z axis are assumed to be zero. Position coordinates are in meters and velocity coordinates are in meters/sec.

Example: $[5; .1; 0; -.2; -3; .05]$

Data Types: `single` | `double`

frame — Measurement output frame

'rectangular' (default) | 'spherical'

Measurement output frame, specified as 'rectangular' or 'spherical'. When the frame is 'rectangular', a measurement consists of x , y , and z Cartesian coordinates. When specified as 'spherical', a measurement consists of azimuth, elevation, range, and range rate.

Data Types: `char`

sensorpos — Sensor position

$[0; 0; 0]$ (default) | real-valued 3-by-1 column vector

Sensor position with respect to the navigation frame, specified as a real-valued 3-by-1 column vector. Units are in meters.

Data Types: `double`

sensorvel — Sensor velocity

$[0; 0; 0]$ (default) | real-valued 3-by-1 column vector

Sensor velocity with respect to the navigation frame, specified as a real-valued 3-by-1 column vector. Units are in m/s.

Data Types: `double`

laxes — Local sensor coordinate axes

`[1,0,0;0,1,0;0,0,1]` (default) | 3-by-3 orthogonal matrix

Local sensor coordinate axes, specified as a 3-by-3 orthogonal matrix. Each column specifies the direction of the local x-, y-, and z-axes, respectively, with respect to the navigation frame. That is, the matrix is the rotation matrix from the global frame to the sensor frame.

Data Types: `double`

measurementParameters — Measurement parameters

structure | array of structure

Measurement parameters, specified as a structure or an array of structures. The fields of the structure are:

Field	Description	Example
Frame	Frame used to report measurements, specified as one of these values: <ul style="list-style-type: none"> 'Rectangular' — Detections are reported in rectangular coordinates. 'Spherical' — Detections are reported in spherical coordinates. 	'spherical'
OriginPosition	Position offset of the origin of the frame relative to the parent frame, specified as an [x y z] real-valued vector.	[0 0 0]
OriginVelocity	Velocity offset of the origin of the frame relative to the parent frame, specified as a [vx vy vz] real-valued vector.	[0 0 0]
Orientation	Frame rotation matrix, specified as a 3-by-3 real-valued orthonormal matrix.	[1 0 0; 0 1 0; 0 0 1]
HasAzimuth	Logical scalar indicating if azimuth is included in the measurement. This field is not relevant when the Frame field is 'Spherical'.	1

Field	Description	Example
HasElevation	Logical scalar indicating if elevation information is included in the measurement. For measurements reported in a rectangular frame, and if HasElevation is false, the reported measurements assume 0 degrees of elevation.	1
HasRange	Logical scalar indicating if range is included in the measurement. This field is not relevant when the Frame is 'Spherical'.	1
HasVelocity	Logical scalar indicating if the reported detections include velocity measurements. For a measurement reported in the rectangular frame, if HasVelocity is false, the measurements are reported as [x y z]. If HasVelocity is true, the measurement is reported as [x y z vx vy vz]. For a measurement reported in the spherical frame, if HasVelocity is true, the measurement contains range-rate information.	1
IsParentToChild	Logical scalar indicating if Orientation performs a frame rotation from the parent coordinate frame to the child coordinate frame. When IsParentToChild is false, then Orientation performs a frame rotation from the child coordinate frame to the parent coordinate frame.	0

If you only want to perform one coordinate transformation, such as a transformation from the body frame to the sensor frame, you only need to specify a measurement parameter structure. If you want to perform multiple coordinate transformations, you need to specify an array of measurement parameter structures. To learn how to perform multiple transformations, see the “Convert Detections to objectDetection Format” (Sensor Fusion and Tracking Toolbox) example.

Data Types: struct

Output Arguments

measurement — Measurement vector

real-valued M -by- N matrix

Measurement vector, returned as an M -by- N matrix. M is the dimension of the measurement and N , the number of measurement, is the same as the number of states. The form of each measurement depends upon which syntax you use.

- When the syntax does not use the `measurementParameters` argument, the measurement vector is $[x, y, z]$ when the `frame` input argument is set to 'rectangular' and $[az; el; r; rr]$ when the frame is set to 'spherical'.
- When the syntax uses the `measurementParameters` argument, the size of the measurement vector depends on the values of the `frame`, `HasVelocity`, and `HasElevation` fields in the `measurementParameters` structure.

frame	measurement															
'spherical'	<p>Specifies the azimuth angle, az, elevation angle, el, range, r, and range rate, rr, of the object with respect to the local ego vehicle coordinate system. Positive values for range rate indicate that an object is moving away from the sensor.</p> <p>Spherical measurements</p> <table border="1"> <thead> <tr> <th></th> <th></th> <th colspan="2">HasElevation</th> </tr> <tr> <th></th> <th></th> <th>false</th> <th>true</th> </tr> </thead> <tbody> <tr> <td rowspan="2">HasVelocity</td> <td>false</td> <td>$[az; r]$</td> <td>$[az; el; r]$</td> </tr> <tr> <td>true</td> <td>$[az; r; rr]$</td> <td>$[az; el; r; rr]$</td> </tr> </tbody> </table> <p>Angle units are in degrees, range units are in meters, and range rate units are in m/s.</p>			HasElevation				false	true	HasVelocity	false	$[az; r]$	$[az; el; r]$	true	$[az; r; rr]$	$[az; el; r; rr]$
		HasElevation														
		false	true													
HasVelocity	false	$[az; r]$	$[az; el; r]$													
	true	$[az; r; rr]$	$[az; el; r; rr]$													
'rectangular'	<p>Specifies the Cartesian position and velocity coordinates of the tracked object with respect to the ego vehicle coordinate system.</p> <p>Rectangular measurements</p> <table border="1"> <thead> <tr> <th>HasVelocity</th> <th></th> <th></th> </tr> </thead> <tbody> <tr> <td>false</td> <td></td> <td>$[x; y; y]$</td> </tr> <tr> <td>true</td> <td></td> <td>$[x; y; z; vx; vy; vz]$</td> </tr> </tbody> </table> <p>Position units are in meters and velocity units are in m/s.</p>	HasVelocity			false		$[x; y; y]$	true		$[x; y; z; vx; vy; vz]$						
HasVelocity																
false		$[x; y; y]$														
true		$[x; y; z; vx; vy; vz]$														

Data Types: double

bounds — Measurement residual wrapping bounds

M -by-2 real-valued matrix

Measurement residual wrapping bounds, returned as an M -by-2 real-valued matrix, where M is the dimension of the measurement. Each row of the matrix corresponds to the lower and upper bounds for the specific dimension in the measurement output.

The function returns different bound values based on the `frame` input.

- If the `frame` input is specified as `'Rectangular'`, each row of the matrix is `[-Inf Inf]`, indicating the filter does not wrap the measurement residual in the filter.
- If the `frame` input is specified as `'Spherical'`, the returned `bounds` contains the bounds for specific measurement dimension based on the following:
 - When `HasAzimuth = true`, the matrix includes a row of `[-180 180]`, indicating the filter wraps the azimuth residual in the range of `[-180 180]` in degrees.
 - When `HasElevation = true`, the matrix includes a row of `[-90 90]`, indicating the filter wraps the elevation residual in the range of `[-90 90]` in degrees.
 - When `HasRange = true`, the matrix includes a row of `[-Inf Inf]`, indicating the filter does not wrap the range residual.
 - When `HasVelocity = true`, the matrix includes a row of `[-Inf Inf]`, indicating the filter does not wrap the range rate residual.

If you specify any of the options as `false`, the returned `bounds` does not contain the corresponding row. For example, if `HasAzimuth = true`, `HasElevation = false`, `HasRange = true`, `HasVelocity = true`, then `bounds` is returned as

```
-180  180
-Inf  Inf
-Inf  Inf
```

The filter wraps the measuring residuals based on this equation:

$$x_{wrap} = \text{mod}\left(x - \frac{a-b}{2}, b-a\right) + \frac{a-b}{2}$$

where x is the residual to wrap, a is the lower bound, b is the upper bound, mod is the modules after division function, and x_{wrap} is the wrapped residual.

Data Types: `single` | `double`

More About

Azimuth and Elevation Angle Definitions

Define the azimuth and elevation angles used in the toolbox.

The azimuth angle of a vector is the angle between the x -axis and its orthogonal projection onto the xy plane. The angle is positive in going from the x axis toward the y axis. Azimuth angles lie between -180 and 180 degrees. The elevation angle is the angle between the vector and its orthogonal projection onto the xy -plane. The angle is positive when going toward the positive z -axis from the xy plane.

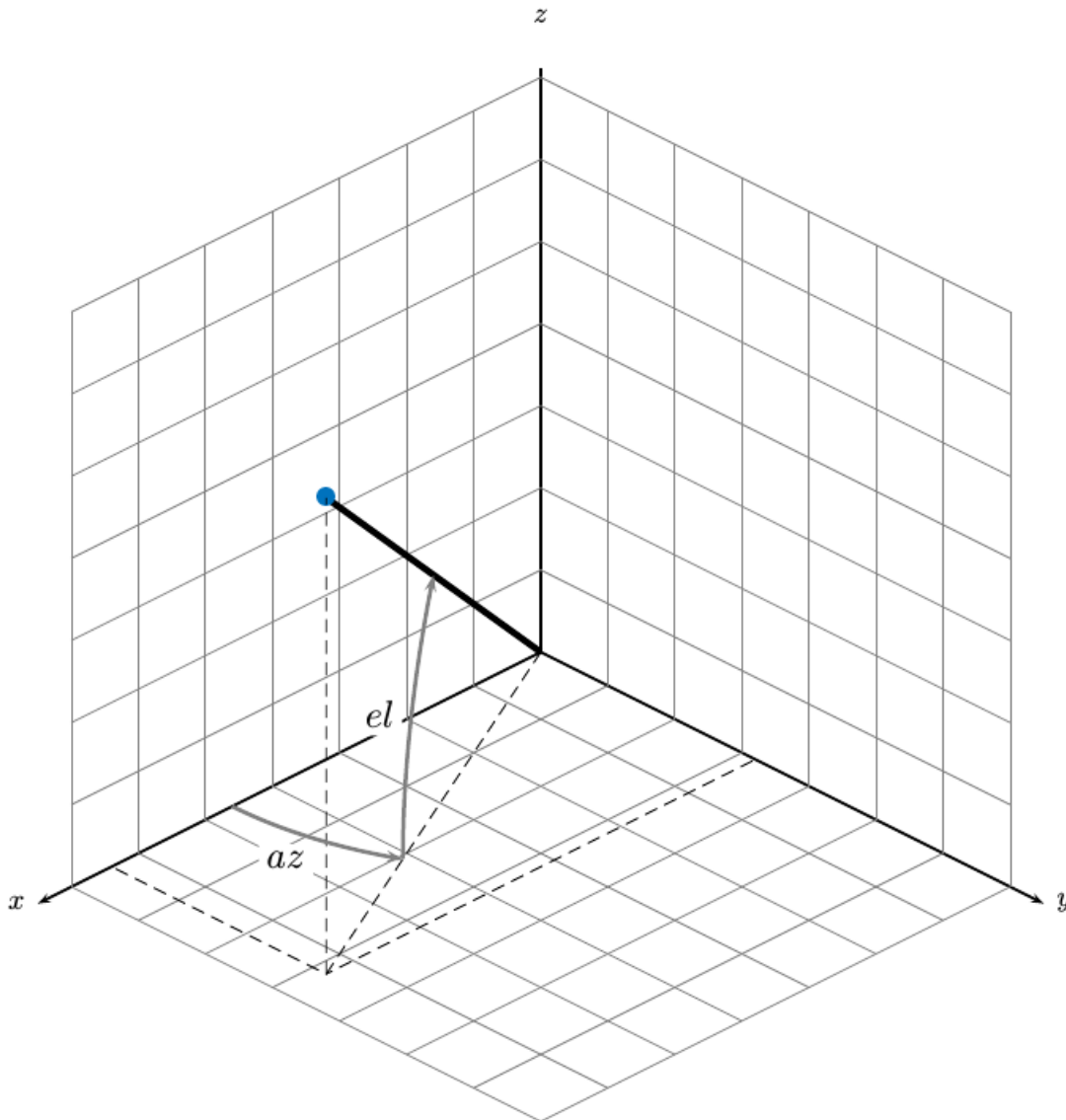

Version History

Introduced in R2017a

Extended Capabilities

C/C++ Code Generation

Generate C and C++ code using MATLAB® Coder™.

See Also

Functions

constacc | constaccjac | cameas | cameasjac | constturn | constturnjac | ctmeas |
ctmeasjac | constvel | constveljac | cvmeasjac

Objects

trackingKF | trackingEKF | trackingUKF

cvmeasjac

Jacobian of measurement function for constant velocity motion

Syntax

```
measurementjac = cvmeasjac(state)
measurementjac = cvmeasjac(state, frame)
measurementjac = cvmeasjac(state, frame, sensorpos)
measurementjac = cvmeasjac(state, frame, sensorpos, sensorvel)
measurementjac = cvmeasjac(state, frame, sensorpos, sensorvel, laxes)
measurementjac = cvmeasjac(state, measurementParameters)
```

Description

`measurementjac = cvmeasjac(state)` returns the measurement Jacobian for constant-velocity Kalman filter motion model in rectangular coordinates. `state` specifies the current state of the tracking filter.

`measurementjac = cvmeasjac(state, frame)` also specifies the measurement coordinate system, `frame`.

`measurementjac = cvmeasjac(state, frame, sensorpos)` also specifies the sensor position, `sensorpos`.

`measurementjac = cvmeasjac(state, frame, sensorpos, sensorvel)` also specifies the sensor velocity, `sensorvel`.

`measurementjac = cvmeasjac(state, frame, sensorpos, sensorvel, laxes)` also specifies the local sensor axes orientation, `laxes`.

`measurementjac = cvmeasjac(state, measurementParameters)` specifies the measurement parameters, `measurementParameters`.

Examples

Measurement Jacobian of Constant-Velocity Object in Rectangular Frame

Define the state of an object in 2-D constant-velocity motion. The state is the position and velocity in each spatial dimension. Construct the measurement Jacobian in rectangular coordinates.

```
state = [1;10;2;20];
jacobian = cvmeasjac(state)
```

```
jacobian = 3×4
```

```
    1    0    0    0
    0    0    1    0
    0    0    0    0
```

Measurement Jacobian of Constant-Velocity Motion in Spherical Frame

Define the state of an object in 2-D constant-velocity motion. The state is the position and velocity in each dimension. Compute the measurement Jacobian with respect to spherical coordinates.

```
state = [1;10;2;20];
measurementjac = cvmeasjac(state, 'spherical')
```

```
measurementjac = 4×4
```

```
-22.9183      0    11.4592      0
      0      0      0      0
  0.4472      0    0.8944      0
  0.0000    0.4472    0.0000    0.8944
```

Measurement Jacobian of Constant-Velocity Object in Translated Spherical Frame

Define the state of an object in 2-D constant-velocity motion. The state is the position and velocity in each spatial dimension. Compute the measurement Jacobian with respect to spherical coordinates centered at (5;-20;0) meters.

```
state = [1;10;2;20];
sensorpos = [5;-20;0];
measurementjac = cvmeasjac(state, 'spherical', sensorpos)
```

```
measurementjac = 4×4
```

```
-2.5210      0   -0.4584      0
      0      0      0      0
-0.1789      0    0.9839      0
  0.5903   -0.1789    0.1073    0.9839
```

Create Measurement Jacobian for Constant-Velocity Object Using Measurement Parameters

Define the state of an object in 2-D constant-velocity motion. The state consists of position and velocity in each spatial dimension. The measurements are in spherical coordinates with respect to a frame located at (20;40;0) meters.

```
state2d = [1;10;2;20];
frame = 'spherical';
sensorpos = [20;40;0];
sensorvel = [0;5;0];
laxes = eye(3);
measurementjac = cvmeasjac(state2d, frame, sensorpos, sensorvel, laxes)
```

```
measurementjac = 4×4
```

```
 1.2062      0   -0.6031      0
      0      0      0      0
```

```
-0.4472      0    -0.8944      0
 0.0471    -0.4472    -0.0235    -0.8944
```

Put the measurement parameters in a structure and use the alternative syntax.

```
measparm = struct('Frame',frame,'OriginPosition',sensorpos,'OriginVelocity',sensorvel, ...
    'Orientation',laxes);
measurementjac = cvmeasjac(state2d,measparm)
```

```
measurementjac = 4x4
```

```
 1.2062      0    -0.6031      0
      0      0      0      0
 -0.4472      0    -0.8944      0
 0.0471    -0.4472    -0.0235    -0.8944
```

Input Arguments

state — Kalman filter state vector

real-valued $2N$ -element vector

Kalman filter state vector for constant-velocity motion, specified as a real-valued $2N$ -element column vector where N is the number of spatial degrees of freedom of motion. The `state` is expected to be Cartesian state. For each spatial degree of motion, the state vector takes the form shown in this table.

Spatial Dimensions	State Vector Structure
1-D	[x;vx]
2-D	[x;vx;y;vy]
3-D	[x;vx;y;vy;z;vz]

For example, x represents the x -coordinate and vx represents the velocity in the x -direction. If the motion model is 1-D, values along the y and z axes are assumed to be zero. If the motion model is 2-D, values along the z axis are assumed to be zero. Position coordinates are in meters and velocity coordinates are in meters/sec.

Example: [5;.1;0;-.2;-3;.05]

Data Types: single | double

frame — Measurement output frame

'rectangular' (default) | 'spherical'

Measurement output frame, specified as 'rectangular' or 'spherical'. When the frame is 'rectangular', a measurement consists of x , y , and z Cartesian coordinates. When specified as 'spherical', a measurement consists of azimuth, elevation, range, and range rate.

Data Types: char

sensorpos — Sensor position

[0;0;0] (default) | real-valued 3-by-1 column vector

Sensor position with respect to the navigation frame, specified as a real-valued 3-by-1 column vector. Units are in meters.

Data Types: double

sensorvel — Sensor velocity

[0;0;0] (default) | real-valued 3-by-1 column vector

Sensor velocity with respect to the navigation frame, specified as a real-valued 3-by-1 column vector. Units are in m/s.

Data Types: double

laxes — Local sensor coordinate axes

[1,0,0;0,1,0;0,0,1] (default) | 3-by-3 orthogonal matrix

Local sensor coordinate axes, specified as a 3-by-3 orthogonal matrix. Each column specifies the direction of the local x-, y-, and z-axes, respectively, with respect to the navigation frame. That is, the matrix is the rotation matrix from the global frame to the sensor frame.

Data Types: double

measurementParameters — Measurement parameters

structure | array of structure

Measurement parameters, specified as a structure or an array of structures. The fields of the structure are:

Field	Description	Example
Frame	Frame used to report measurements, specified as one of these values: <ul style="list-style-type: none"> 'Rectangular' — Detections are reported in rectangular coordinates. 'Spherical' — Detections are reported in spherical coordinates. 	'spherical'
OriginPosition	Position offset of the origin of the frame relative to the parent frame, specified as an [x y z] real-valued vector.	[0 0 0]
OriginVelocity	Velocity offset of the origin of the frame relative to the parent frame, specified as a [vx vy vz] real-valued vector.	[0 0 0]
Orientation	Frame rotation matrix, specified as a 3-by-3 real-valued orthonormal matrix.	[1 0 0; 0 1 0; 0 0 1]

Field	Description	Example
HasAzimuth	Logical scalar indicating if azimuth is included in the measurement. This field is not relevant when the Frame field is 'Spherical'.	1
HasElevation	Logical scalar indicating if elevation information is included in the measurement. For measurements reported in a rectangular frame, and if HasElevation is false, the reported measurements assume 0 degrees of elevation.	1
HasRange	Logical scalar indicating if range is included in the measurement. This field is not relevant when the Frame is 'Spherical'.	1
HasVelocity	Logical scalar indicating if the reported detections include velocity measurements. For a measurement reported in the rectangular frame, if HasVelocity is false, the measurements are reported as [x y z]. If HasVelocity is true, the measurement is reported as [x y z vx vy vz]. For a measurement reported in the spherical frame, if HasVelocity is true, the measurement contains range-rate information.	1
IsParentToChild	Logical scalar indicating if Orientation performs a frame rotation from the parent coordinate frame to the child coordinate frame. When IsParentToChild is false, then Orientation performs a frame rotation from the child coordinate frame to the parent coordinate frame.	0

If you only want to perform one coordinate transformation, such as a transformation from the body frame to the sensor frame, you only need to specify a measurement parameter structure. If you want

to perform multiple coordinate transformations, you need to specify an array of measurement parameter structures. To learn how to perform multiple transformations, see the “Convert Detections to objectDetection Format” (Sensor Fusion and Tracking Toolbox) example.

Data Types: `struct`

Output Arguments

`measurement_jac` — Measurement Jacobian

real-valued 3-by- N matrix | real-valued 4-by- N matrix

Measurement Jacobian, specified as a real-valued 3-by- N or 4-by- N matrix. N is the dimension of the state vector. The first dimension and meaning depend on value of the `frame` argument.

Frame	Measurement Jacobian
'rectangular'	Jacobian of the measurements $[x; y; z]$ with respect to the state vector. The measurement vector is with respect to the local coordinate system. Coordinates are in meters.
'spherical'	Jacobian of the measurement vector $[az; el; r; rr]$ with respect to the state vector. Measurement vector components specify the azimuth angle, elevation angle, range, and range rate of the object with respect to the local sensor coordinate system. Angle units are in degrees. Range units are in meters and range rate units are in meters/second.

More About

Azimuth and Elevation Angle Definitions

Define the azimuth and elevation angles used in the toolbox.

The azimuth angle of a vector is the angle between the x -axis and its orthogonal projection onto the xy plane. The angle is positive in going from the x axis toward the y axis. Azimuth angles lie between -180 and 180 degrees. The elevation angle is the angle between the vector and its orthogonal projection onto the xy -plane. The angle is positive when going toward the positive z -axis from the xy plane.

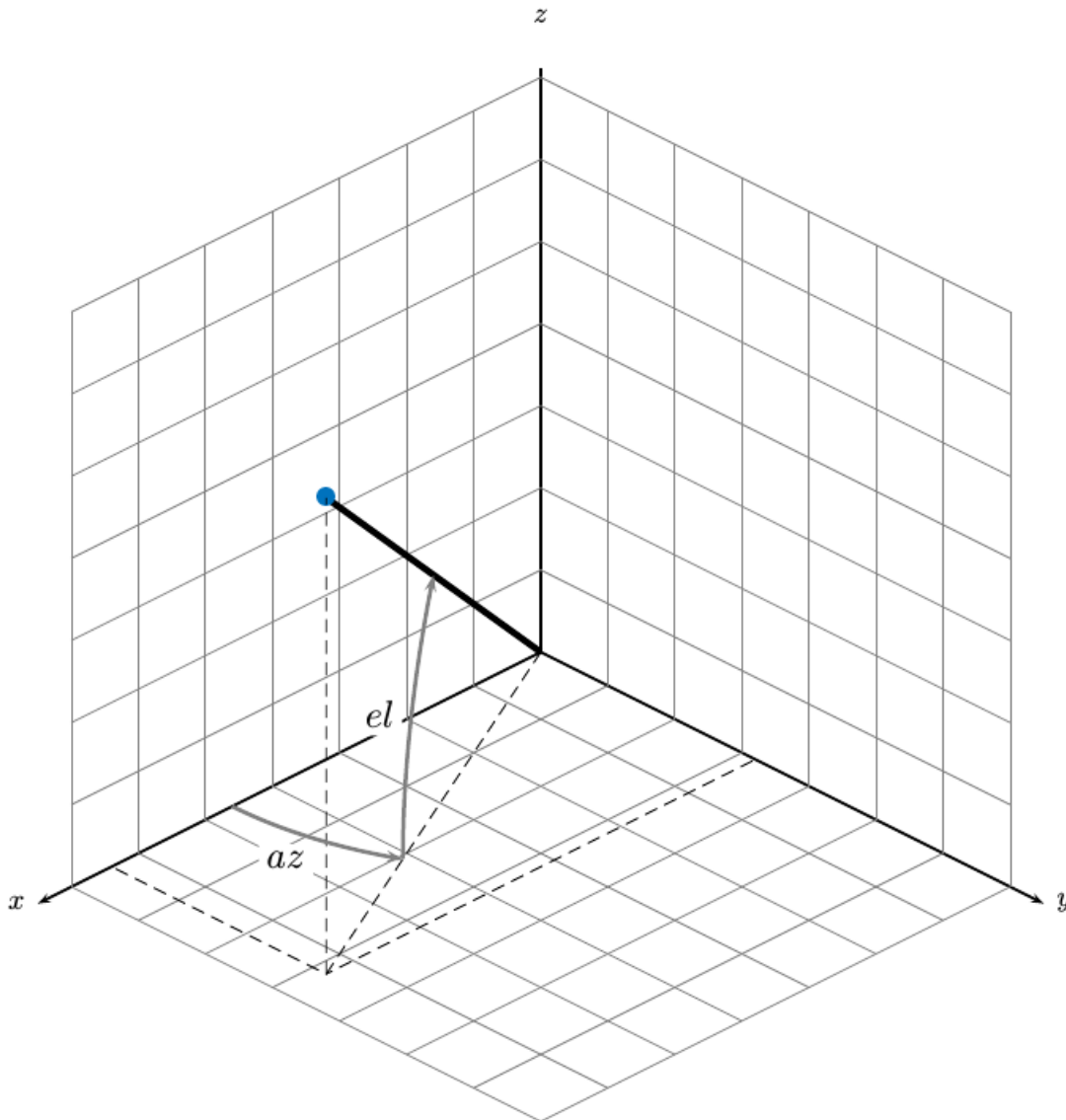

Version History

Introduced in R2017a

Extended Capabilities

C/C++ Code Generation

Generate C and C++ code using MATLAB® Coder™.

See Also

Functions

constacc | constaccjac | cameas | cameasjac | constturn | constturnjac | ctmeas |
ctmeasjac | constvel | constveljac | cvmeas

Objects

trackingKF | trackingEKF | trackingUKF

estimateMonoCameraParameters

Estimate extrinsic monocular camera parameters using checkerboard

Syntax

```
[pitch,yaw,roll,height] = estimateMonoCameraParameters(intrinsics,
imagePoints,worldPoints,patternOriginHeight)
[pitch,yaw,roll,height] = estimateMonoCameraParameters( ____,Name,Value)
```

Description

`[pitch,yaw,roll,height] = estimateMonoCameraParameters(intrinsics, imagePoints,worldPoints,patternOriginHeight)` estimates the extrinsic parameters of a monocular camera by using the intrinsic parameters of the camera and a checkerboard calibration pattern. The returned extrinsic parameters define the yaw, pitch, and roll rotation angles between the camera coordinate system and vehicle coordinate system on page 3-108 axes. The function also returns the height of the camera above the ground. Specify the intrinsic parameters, the image and world coordinates of the checkerboard corner points, and the height of the checkerboard pattern's origin above the ground.

By default, the function assumes that the camera is facing forward and that the checkerboard pattern is parallel with the ground. For all possible camera and checkerboard placements, see “Calibrate a Monocular Camera”.

`[pitch,yaw,roll,height] = estimateMonoCameraParameters(____,Name,Value)` specifies options using one or more name-value pairs, in addition to the inputs and outputs from the previous syntax. For example, you can specify the orientation or position of the checkerboard pattern.

Examples

Configure Monocular Camera Using Checkerboard Pattern

Configure a monocular fisheye camera by removing lens distortion and then estimating the camera's extrinsic parameters. Use an image of a checkerboard as the calibration pattern. For a more detailed look at how to configure a monocular camera that has a fisheye lens, see the “Configure Monocular Fisheye Camera” example.

Load the intrinsic parameters of a monocular camera that has a fisheye lens. `intrinsics` is a `fishEyeIntrinsics` object.

```
ld = load('fisheyeCameraIntrinsics');
intrinsics = ld.intrinsics;
```

Load an image of a checkerboard pattern that is placed flat on the ground. This image is for illustrative purposes and was not taken from a camera mounted to the vehicle. In a camera mounted to the vehicle, the *X*-axis of the pattern points to the right of the vehicle, and the *Y*-axis of the pattern points to the camera. Display the image.

```
imageFileName = fullfile(toolboxdir('driving'),'drivingdata','checkerboard.png');  
I = imread(imageFileName);  
imshow(I)
```



Detect the coordinates of the checkerboard corners in the image.

```
[imagePoints,boardSize] = detectCheckerboardPoints(I);
```

Generate the corresponding world coordinates of the corners.

```
squareSize = 0.029; % Square size in meters  
worldPoints = generateCheckerboardPoints(boardSize,squareSize);
```

Estimate the extrinsic parameters required to configure the `monoCamera` object. Because the checkerboard pattern is directly on the ground, set the height of the pattern's origin to 0.

```
patternOriginHeight = 0;  
[pitch,yaw,roll,height] = estimateMonoCameraParameters(intrinsics, ...  
                                                       imagePoints,worldPoints,patternOriginHeight);
```

Because `monoCamera` does not accept `fishEyeIntrinsics` objects, remove distortion from the image and compute new intrinsic parameters from the undistorted image. `camIntrinsics` is an `cameraIntrinsics` object. Display the image to confirm distortion is removed.

```
[undistortedI,camIntrinsics] = undistortFisheyeImage(I,intrinsics,'Output','full');  
imshow(undistortedI)
```

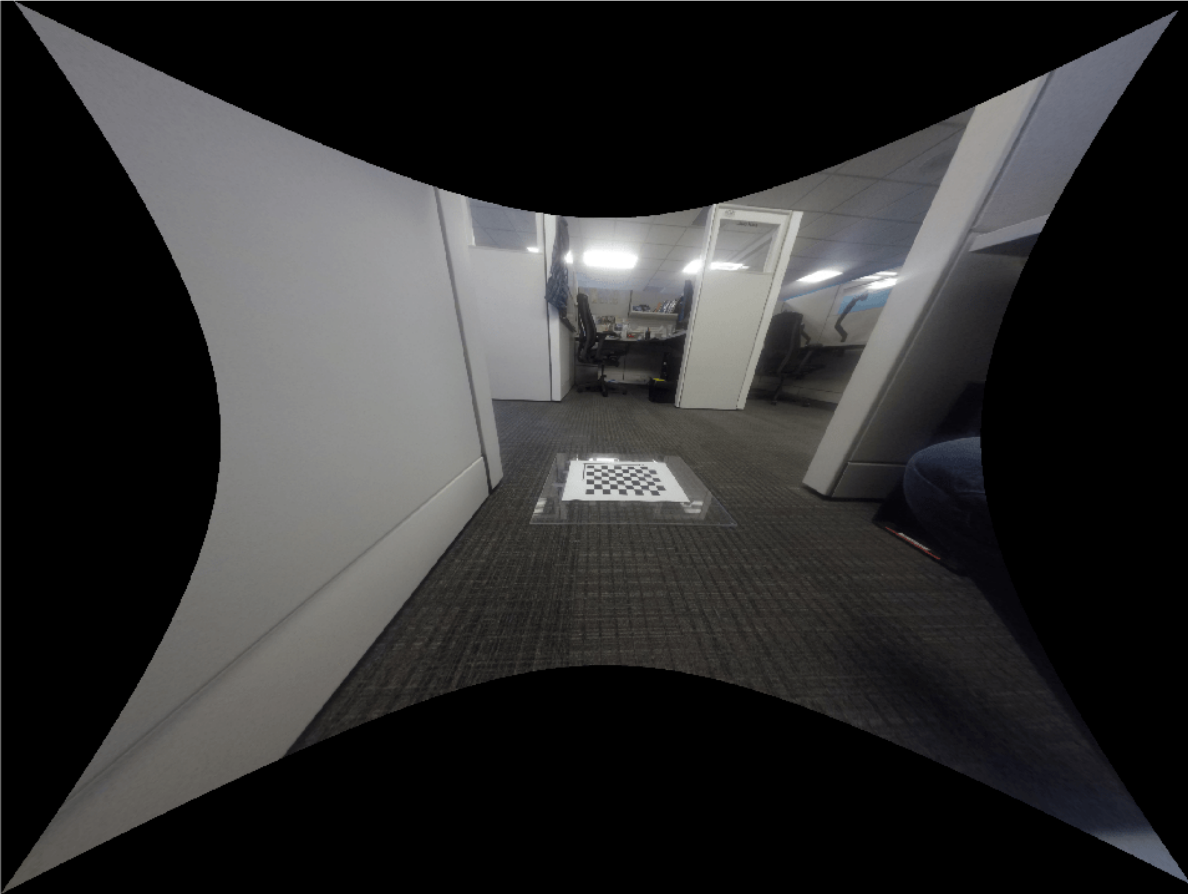

Configure the monocular camera using the estimated parameters.

```
monoCam = monoCamera(camIntrinsics,height,'Pitch',pitch,'Yaw',yaw,'Roll',roll)
```

```
monoCam =  
  monoCamera with properties:  
    Intrinsic: [1x1 cameraIntrinsics]  
  WorldUnits: 'meters'  
    Height: 0.4447  
    Pitch: 21.8459  
    Yaw: -3.6130  
    Roll: -3.1707  
  SensorLocation: [0 0]
```

Configure Monocular Camera Using Circle Grid Pattern and Generate Bird's-Eye View

Configure a monocular camera using a circle grid pattern and then estimate the camera's extrinsic parameters. Use an image of an asymmetric circle grid as the calibration pattern.

Load the intrinsic parameters of a monocular camera. `intrinsics` is a `cameraIntrinsics` object.

```
ld = load('IRCameraIntrinsics');
intrinsics = ld.intrinsics;
```

Load an image of an asymmetric circle grid pattern that is placed parallel to the ground placed at a height. This image is for illustrative purposes and was not taken from a camera mounted to the vehicle. In a camera mounted to the vehicle, the X-axis of the pattern points to the right of the vehicle, and the Y-axis of the pattern points to the camera. Display the image.

```
imageFileName = fullfile(toolboxdir('vision'),'visiondata', ...
    'calibration','circleGrid','stereo','left','left07.jpg');
I = imread(imageFileName);
imshow(I)
```

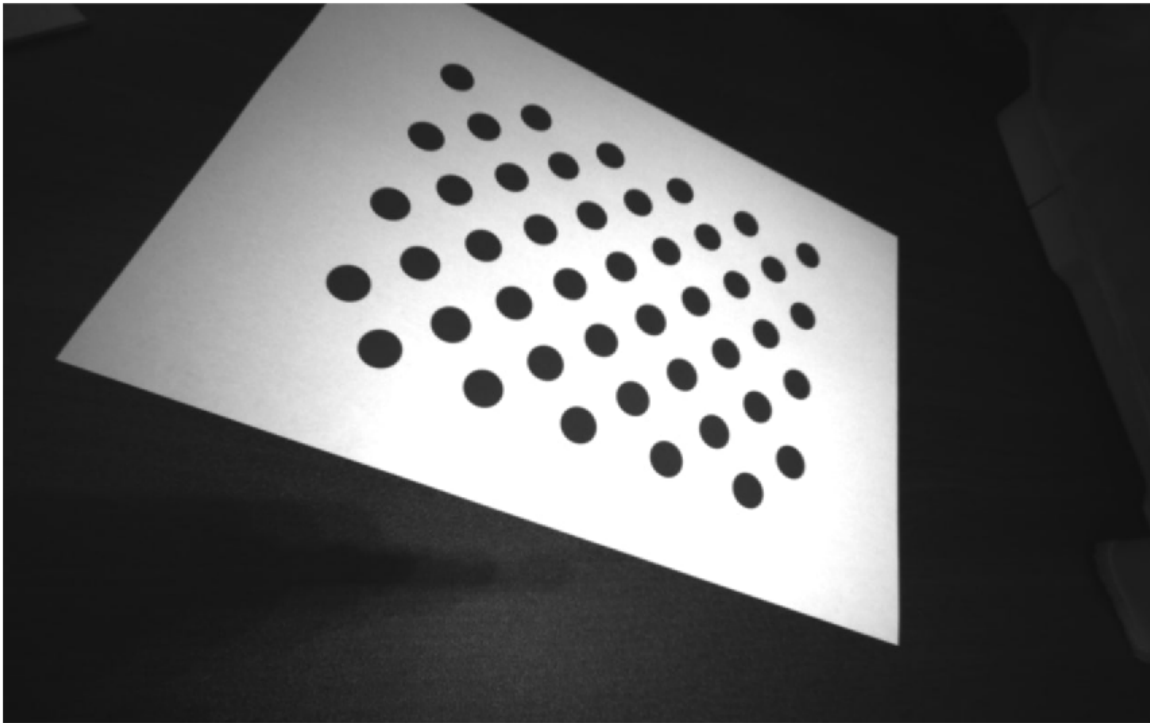

Define the circle grid pattern dimensions and detect the centers of the circles in the image.

```
patternDims = [4 11];
imagePoints = detectCircleGridPoints(I,patternDims);
```

Generate the corresponding world coordinates of the corners.

```
centerDistance = 0.0365; % Center-to-center distance in meters
worldPoints = generateCircleGridPoints(patternDims,centerDistance);
```

Estimate the extrinsic parameters required to configure the `monoCamera` object. Because the checkerboard pattern is placed at a height of 1.2 m from the ground, set the height of the pattern's origin to 1.2 m.

```
patternOriginHeight = 1.2;
[pitch,yaw,roll,height] = estimateMonoCameraParameters(intrinsics, ...
    imagePoints,worldPoints,patternOriginHeight);
```

Configure the monocular camera using the estimated parameters.

```
monoCam = monoCamera(intrinsics,height,'Pitch',pitch,'Yaw',yaw,'Roll',roll)
```

```
monoCam =
  monoCamera with properties:

    Intrinsics: [1x1 cameraIntrinsics]
  WorldUnits: 'meters'
    Height: 1.3869
    Pitch: 60.2886
    Yaw: -26.5963
    Roll: -45.7440
  SensorLocation: [0 0]
```

Define the area in front of the camera that you want to transform into a bird's-eye view. Set an area from 0 to 2.5 meters in front of the camera, with 1.75 meters to either side of the camera.

```
bottomOffset = 0;
distAhead = 2.5;
spaceToOneSide = 1.75;

outView = [bottomOffset,distAhead,-spaceToOneSide,spaceToOneSide];
```

Set the output image width to 250 pixels. Compute the output length automatically from the width by setting the length to `NaN`.

```
outImageSize = [NaN,250];
```

Create an object for performing bird's-eye-view transforms, using the previously defined parameters.

```
birdsEye = birdsEyeView(monoCam,outView,outImageSize);
```

Transform the input image into a bird's-eye-view image and display the result.

```
BEV = transformImage(birdsEye,I);
imshow(BEV)
```

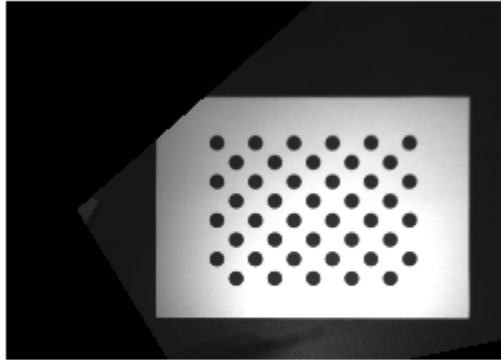

Input Arguments

intrinsic — Intrinsic camera parameters

`cameraIntrinsic` object | `fishEyeIntrinsic` object

Intrinsic camera parameters, specified as a `cameraIntrinsic` or `fishEyeIntrinsic` object.

Checkerboard pattern images produced by these cameras can include lens distortion, which can affect the accuracy of corner point detections. To remove lens distortion and compute new intrinsic parameters, use these functions:

- For `cameraIntrinsic` objects, use `undistortImage`.
- For `fishEyeIntrinsic` objects, use `undistortFishEyeImage`.

imagePoints — Image coordinates of checkerboard corner points

M-by-2 matrix

Image coordinates of checkerboard corner points, specified as an *M*-by-2 matrix of *M* number of [*x y*] vectors. These points must come from an image captured by a monocular camera. To detect these points in an image, use the `detectCheckerboardPoints` function.

`estimateMonoCameraParameters` assumes that all points in `worldPoints` are in the (X_p, Y_p) plane and that *M* is greater than or equal to 4. To specify the height of the (X_p, Y_p) plane above the ground, use `patternOriginHeight`.

Data Types: `single` | `double`

worldPoints — World coordinates of corner points in checkerboard

M-by-2 matrix

World coordinates of the corner points in the checkerboard, specified as an *M*-by-2 matrix of *M* number of [*x y*] vectors.

`estimateMonoCameraParameters` assumes that all points in `worldPoints` are in the (X_p, Y_p) plane and that *M* is greater than or equal to 4. To specify the height of the (X_p, Y_p) plane above the ground, use `patternOriginHeight`.

Point (0,0) corresponds to the bottom-right corner of the top-left square of the checkerboard.

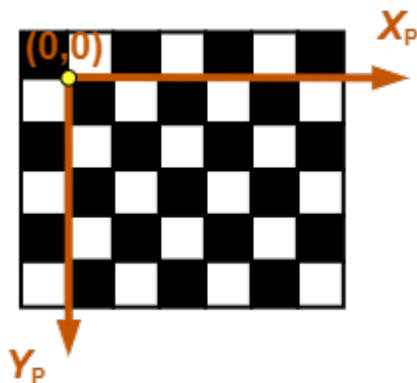

Data Types: single | double

patternOriginHeight — Height of checkerboard pattern's origin

nonnegative real scalar

Height of the checkerboard pattern's origin above the ground, specified as a nonnegative real scalar. The origin is the bottom-right corner of the top-left square of the checkerboard.

The measurement of `patternOriginHeight` depends on the orientation of the checkerboard pattern, as shown in these diagrams.

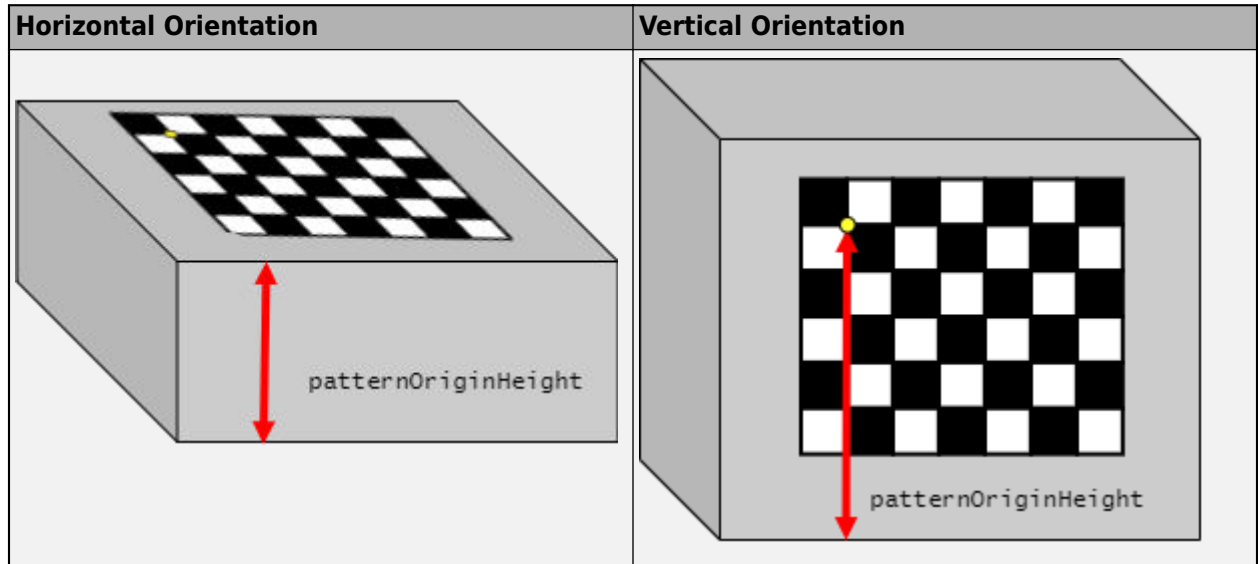

To specify the pattern orientation, use the 'PatternOrientation' name-value pair. If you set 'PatternOrientation' to 'horizontal' (default), and the pattern is on the ground, then set `patternOriginHeight` to 0.

Data Types: single | double

Name-Value Pair Arguments

Specify optional pairs of arguments as `Name1=Value1, ..., NameN=ValueN`, where `Name` is the argument name and `Value` is the corresponding value. Name-value arguments must appear after other arguments, but the order of the pairs does not matter.

Before R2021a, use commas to separate each name and value, and enclose Name in quotes.

Example: `'PatternOrientation','vertical','PatternPosition','right'`

PatternOrientation — Orientation of checkerboard pattern

`'horizontal'` (default) | `'vertical'`

Orientation of the checkerboard pattern relative to the ground, specified as the comma-separated pair consisting of `'PatternOrientation'` and one of the following:

- `'horizontal'` — Checkerboard pattern is parallel to the ground.
- `'vertical'` — Checkerboard pattern is perpendicular to the ground.

PatternPosition — Position of checkerboard pattern

`'front'` (default) | `'back'` | `'left'` | `'right'`

Position of the checkerboard pattern relative to the ground, specified as the comma-separated pair consisting of `'PatternPosition'` and one of the following:

- `'front'` — Checkerboard pattern is in front of the vehicle.
- `'back'` — Checkerboard pattern is behind the vehicle.
- `'left'` — Checkerboard pattern is to the left of the vehicle.
- `'right'` — Checkerboard pattern is to the right of the vehicle.

Output Arguments

pitch — Pitch angle

real scalar

Pitch angle between the horizontal plane of the vehicle and the optical axis of the camera, returned as a real scalar in degrees. `pitch` uses the ISO convention for rotation, with a clockwise positive angle direction when looking in the positive direction of the vehicle's Y_V -axis.

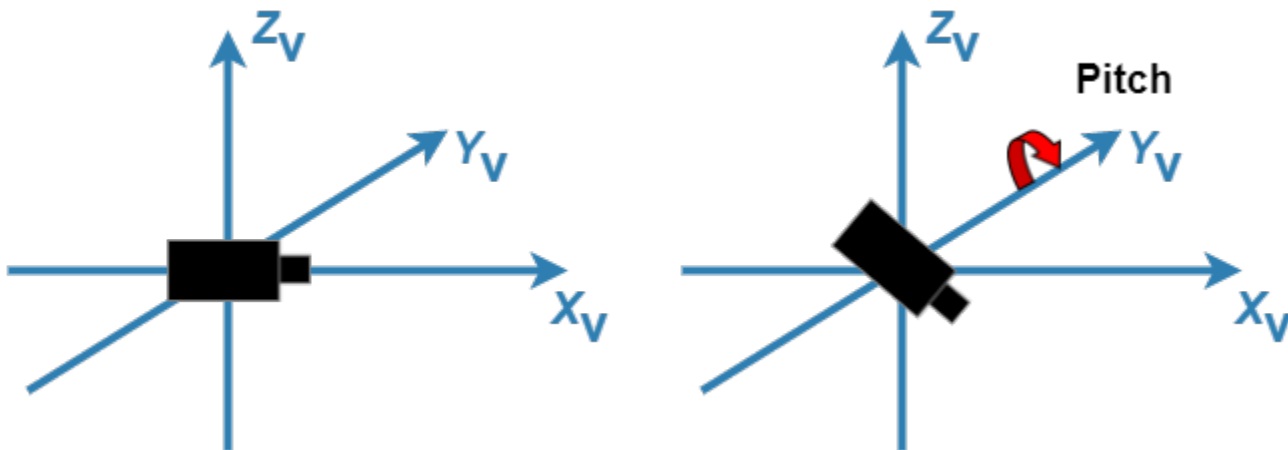

For more details, see “Angle Directions” on page 3-109.

yaw – Yaw angle

real scalar

Yaw angle between the X_V -axis of the vehicle and the optical axis of the camera, returned as a real scalar in degrees. `yaw` uses the ISO convention for rotation, with a clockwise positive angle direction when looking in the positive direction of the vehicle's Z_V -axis.

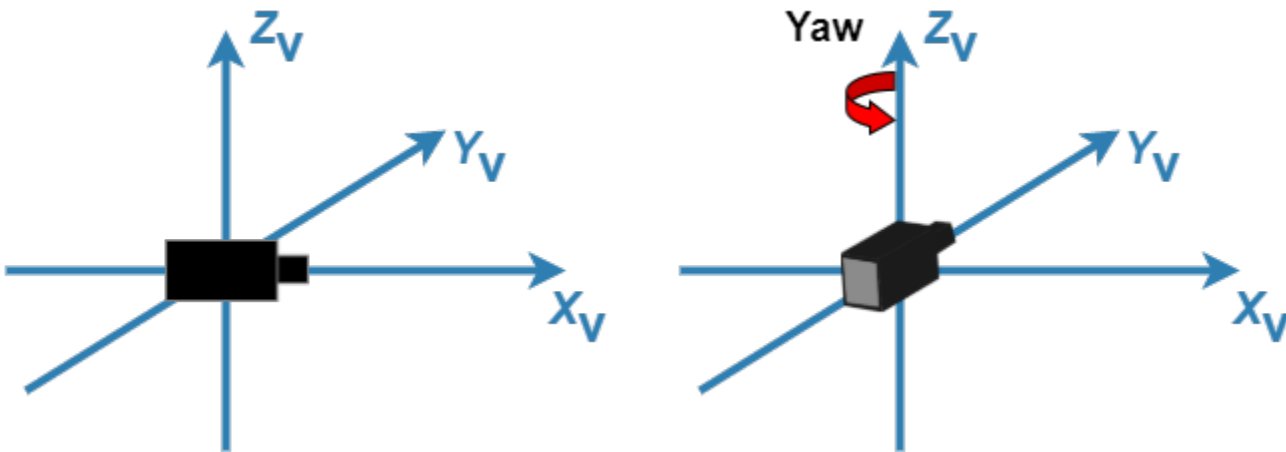

For more details, see “Angle Directions” on page 3-109.

roll – Roll angle

real scalar

Roll angle of the camera around its optical axis, returned as a real scalar in degrees. `roll` uses the ISO convention for rotation, with a clockwise positive angle direction when looking in the positive direction of the vehicle's X_V -axis.

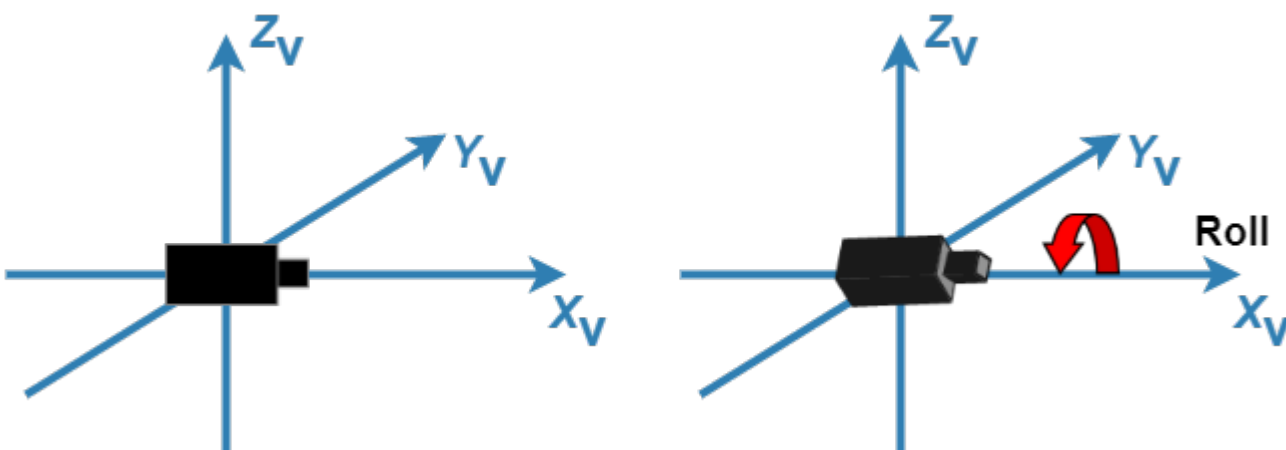

For more details, see “Angle Directions” on page 3-109.

height – Perpendicular height from ground to camera

nonnegative real scalar

Perpendicular height from the ground to the focal point of the camera, returned as a nonnegative real scalar in world units, such as meters.



More About

Vehicle Coordinate System

In the vehicle coordinate system (X_V, Y_V, Z_V) defined by a `monoCamera` object:

- The X_V -axis points forward from the vehicle.
- The Y_V -axis points to the left, as viewed when facing forward.
- The Z_V -axis points up from the ground to maintain the right-handed coordinate system.

By default, the origin of this coordinate system is on the road surface, directly below the camera center (focal point of camera).

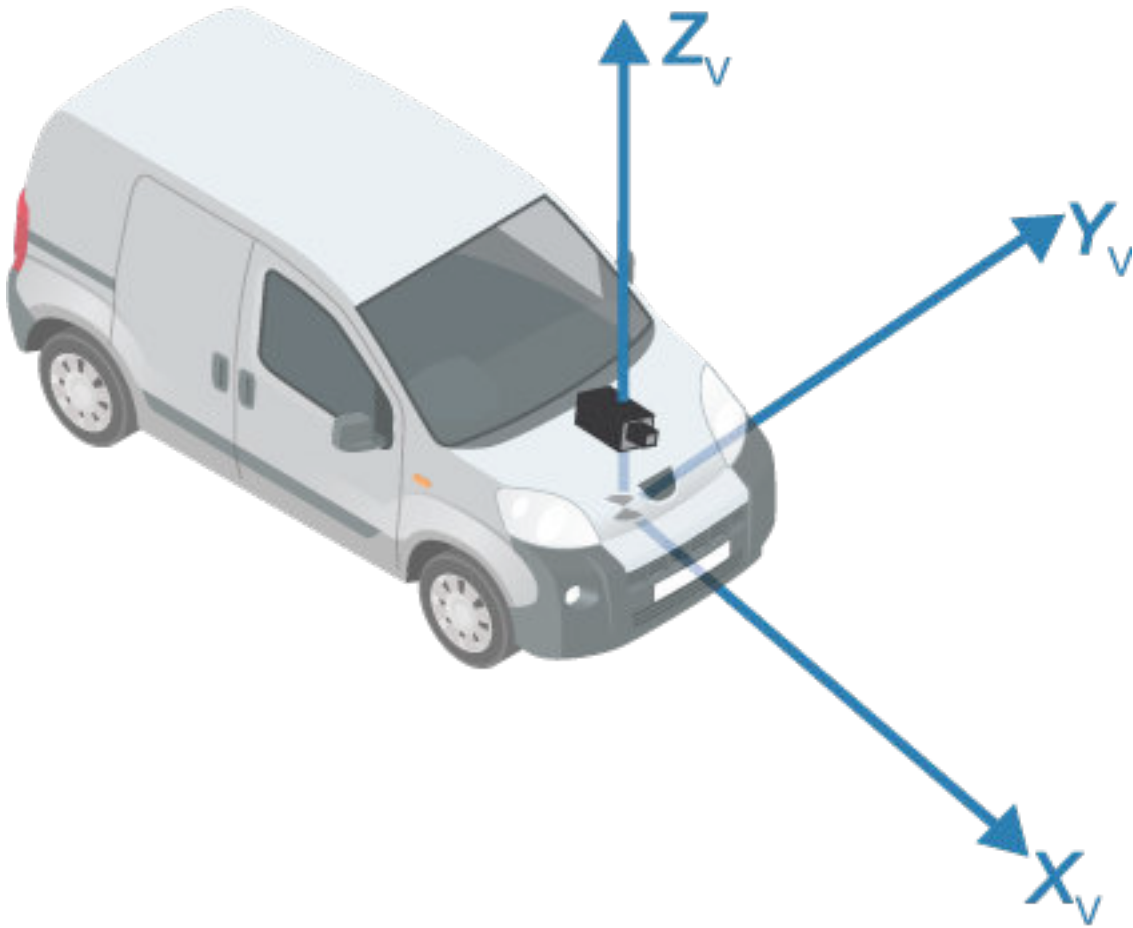

To obtain more reliable results from `estimateMonoCameraParameters`, the checkerboard pattern must be placed in precise locations relative to this coordinate system. For more details, see “Calibrate a Monocular Camera”.

Angle Directions

The monocular camera sensor uses clockwise positive angle directions when looking in the positive direction of the Z-, Y-, and X-axes, respectively.

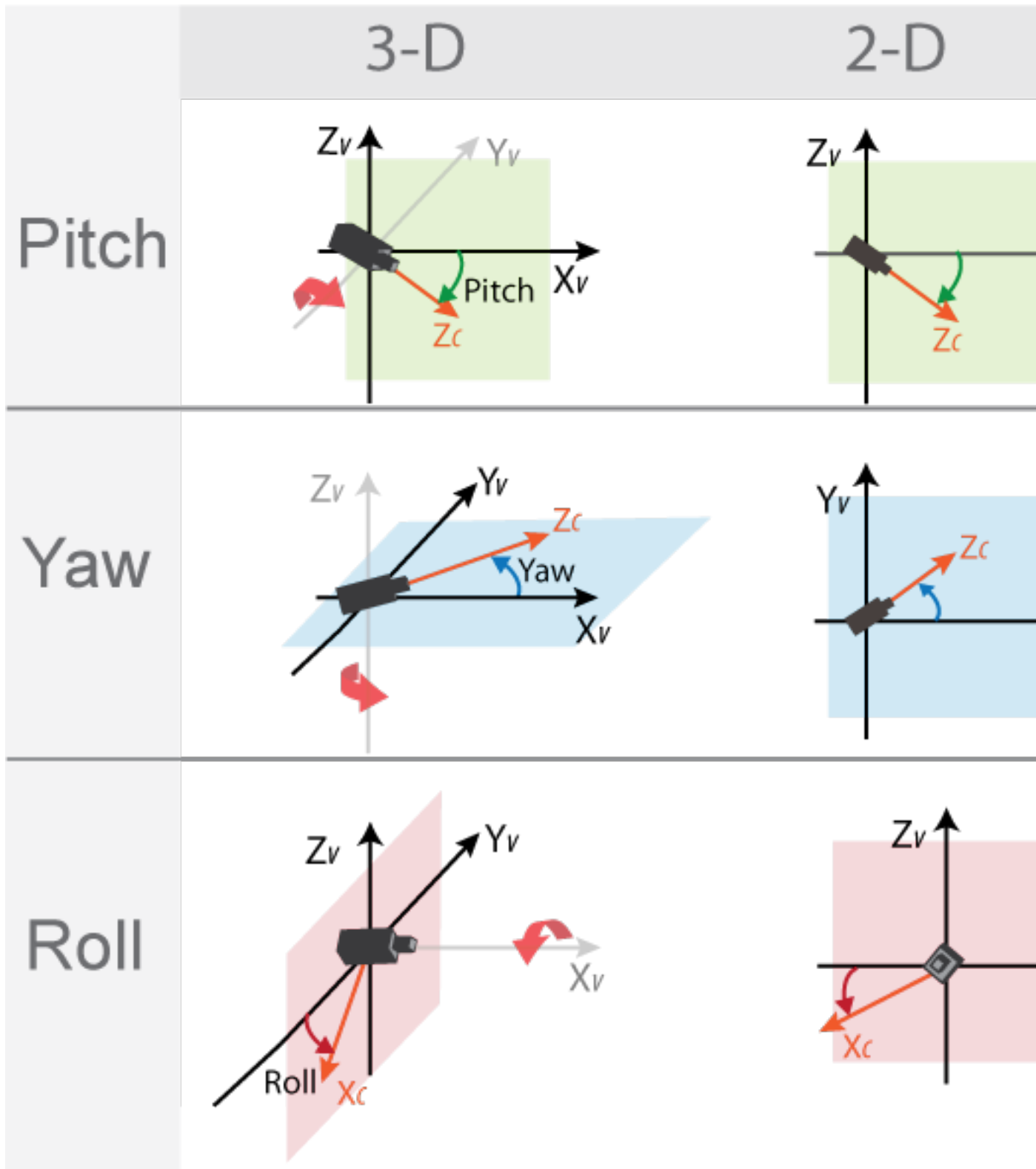

Version History

Introduced in R2018b

See Also

Apps

Camera Calibrator

Functions

estimateCameraParameters | estimateFisheyeParameters | detectCheckerboardPoints | generateCheckerboardPoints | extrinsics

Objects

monoCamera | cameraIntrinsics | fisheyeIntrinsics

Topics

“Create 360° Bird's-Eye-View Image Around a Vehicle”

“Calibrate a Monocular Camera”

“Configure Monocular Fisheye Camera”

“Coordinate Systems in Automated Driving Toolbox”

estimateMonoCameraFromScene

Estimate monocular camera parameters from scene geometry

Syntax

```
[pitch,yaw,roll,height,intrinsicsOut] = estimateMonoCameraFromScene(
trapezoid,rectangleWidth,rectangleLength,imageSize)
[pitch,yaw,roll,height,intrinsicsOut] = estimateMonoCameraFromScene(
trapezoid,rectangleWidth,intrinsicsIn)
```

Description

`[pitch,yaw,roll,height,intrinsicsOut] = estimateMonoCameraFromScene(trapezoid,rectangleWidth,rectangleLength,imageSize)` estimates the extrinsic and intrinsic parameters of a monocular camera from scene geometry. Specify the pixel coordinates for a trapezoid on the scene image, along with the width and length of the real-world rectangle that corresponds to that trapezoid. The returned extrinsic parameters define the pitch, yaw, and roll rotation angles between the camera coordinate system and vehicle coordinate system axes. The function also returns the height of the camera above the ground, and the intrinsic parameters of the camera `intrinsicsOut`. Use these estimates to configure a `monoCamera` object when a formal calibration with a calibration pattern is not possible. For more information on coordinate systems see, camera coordinate system and vehicle coordinate system on page 3-108.



Trapezoid vertices in pixel coordinates

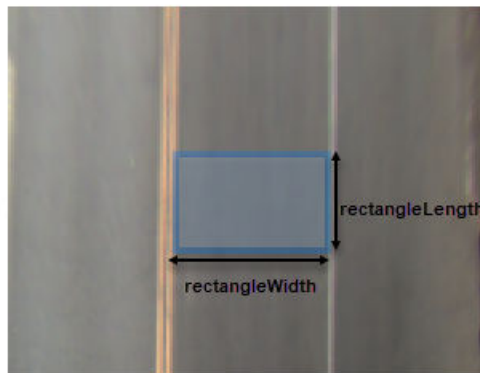

Corresponding real-world rectangle length and width

`[pitch,yaw,roll,height,intrinsicsOut] = estimateMonoCameraFromScene(trapezoid,rectangleWidth,intrinsicsIn)` specifies the intrinsic parameters of the camera `intrinsicsIn` instead of the rectangle length and image size. When the camera intrinsic parameters are available, use this syntax to improve the estimates of the extrinsic parameters.

Examples

Estimate Camera Intrinsic and Extrinsic from Scene Image Without Camera Calibration

Load a MAT file containing a scene image into the workspace.

```
load("doubleLaneImageData.mat");
```

Specify the pixel coordinates of trapezoid vertices on the scene image that spans the width of two lanes. You must specify the vertices, in the clockwise or counterclockwise order, starting from the upper-left trapezoid vertex.

```
trapezoid = [208 456; 170 465; 699 467; 693 456];
```

Visualize the trapezoid vertices as annotations on the scene image. Note that the vertices in counterclockwise order.

```
doubleLaneImg = insertMarker(doubleLaneImg, trapezoid);
text_str = {'UL', 'LL', 'LR', 'UR'};
doubleLaneImg = insertText(doubleLaneImg, trapezoid+[5 5; 5 5; 5 5; 5 -25], text_str);
figure
imshow(doubleLaneImg)
```



Specify the dimensions of the real-world rectangle that corresponds to the trapezoid on the scene image.

```
rectangleWidth = 8;
rectangleLength = 1.5;
```

Specify the size of the image.

```
imageSize = size(doubleLaneImg, [1 2]);
```

Estimate the extrinsic and intrinsic camera parameters by using the `estimateMonoCameraFromScene` function. Display the estimated camera extrinsic and intrinsic parameters.

```
[pitch,yaw,roll,height,intrinsics] = estimateMonoCameraFromScene(trapezoid,rectangleWidth,rectangleHeight);
pitch = 0.3032
yaw = -0.1190
roll = 2.0457
height = 1.4508
intrinsics =
    cameraIntrinsics with properties:
        FocalLength: [1.0981e+03 1.0981e+03]
        PrincipalPoint: [640 360]
        ImageSize: [720 1280]
        RadialDistortion: [0 0]
        TangentialDistortion: [0 0]
        Skew: 0
        K: [3x3 double]
```

Obtain Camera Extrinsic and Bird's-Eye-View by Specifying Scene Geometry Interactively on Image

Obtain camera extrinsic parameters by specifying the scene geometry interactively on an image when camera intrinsic parameters are available. Then, use the estimated camera parameters to create a `monoCamera` object, and obtain a bird's-eye-view of the scene by using a `birdsEyeView` object.

Obtain Camera Parameters

Load the scene image. Use the known camera intrinsic parameters to create a `cameraIntrinsics` object.

```
Im = imread(fullfile(matlabroot, "toolbox", "driving", "drivingdata", "roadSequence", "f00014.png"));
focalLength = [309.4362 344.2161];
principalPoint = [318.9034 257.5352];
imageSize = [480 640];
intrinsics = cameraIntrinsics(focalLength,principalPoint,imageSize);
```

Display the scene image. Move the four vertices of the trapezoid region of interest (ROI) interactively to specify the desired scene geometry. Then press **Enter**.

```
figure
imshow(Im);
title("Adjust the trapezoid ROI to select rectangular lane region, press Enter to continue");
vertices = [size(Im,2)/2 size(Im,1)/2;...
            size(Im,2)/2 size(Im,1)*3/4;...
            size(Im,2)*3/4 size(Im,1)*3/4;...
            size(Im,2)*3/4 size(Im,1)/2];
roi = drawpolygon(Position=vertices,FaceAlpha=0.2,LineWidth=1);
```



```

% Wait until Enter is pressed
wasButtonPressed = false;
while ~wasButtonPressed
    wasButtonPressed = waitforbuttonpress;
    if double(get(gcf,"currentcharacter")) ~= 13
        wasButtonPressed = false;
    end
end
end

```

Adjust the trapezoid ROI to select rectangular lane region, press Enter to continue



Specify the dimensions of the real-world rectangle that corresponds to the trapezoid you specified on the scene image. Because you know the camera intrinsic parameters, you can estimate the extrinsic parameters by specifying only the width of the rectangle.

```
rectangleWidth = 3.6;
```

Estimate the camera extrinsic parameters to obtain the pitch, roll, yaw, and height of the camera mounted on the vehicle.

```
[pitchCal,yawCal,rollCal,heightCal] = estimateMonoCameraFromScene(roi.Position,rectangleWidth,intrinsics);
```

Transform Road Image to Bird's-Eye-View Image

Create a `monoCamera` object using the estimated camera extrinsic parameters and the known intrinsic parameters.

```
sensor = monoCamera(intrinsics,heightCal,Pitch=pitchCal,Roll=rollCal,Yaw=yawCal);
```

Define the area in front of the camera that you want to transform into a bird's-eye view. Specify an area from 3 to 30 meters in front of the camera, with 6 meters to either side of the camera.

```
distAhead = 40;
spaceToOneSide = 6;
```

```
bottomOffset = 3;  
outView = [bottomOffset distAhead -spaceToOneSide spaceToOneSide];
```

Set the output image width to 250 pixels. Compute the output height automatically from the width by specifying the length as NaN.

```
outImageSize = [NaN 250];
```

Create a `birdsEyeView` object using the previously defined parameters, and transform the road image. Visualize the bird's-eye-view image.

```
birdsEye = birdsEyeView(sensor,outView,outImageSize);  
BEV = transformImage(birdsEye,Im);  
imshow(BEV)
```



Input Arguments

frustum — Vertices of a frustum on the scene image

Vertices of a trapezoid on the scene image, in pixel coordinates, specified as a 4-by-2 array. Each row specifies the position of a vertex, and you start with the upper-left vertex of the trapezoid and must follow either clockwise or counterclockwise order.

Data Types: `single` | `double`

rectangleWidth — Width of real-world rectangle

positive scalar

Width of the real-world rectangle that corresponds to the trapezoid on the scene image, in meters, specified as a positive scalar.

Data Types: `single` | `double`

rectangleLength — Length of real-world rectangle

positive scalar

Length of the real-world rectangle that corresponds to the trapezoid on the scene image, in meters, specified as a positive scalar.

Data Types: `single` | `double`

imageSize — Size of image

two-element vector

Size of the image, in pixels, specified as a two-element vector of the form $[m\ n]$, where m and n specify the number of rows and columns of pixels, respectively.

Data Types: `single` | `double`

intrinsicIn — Intrinsic camera parameters

`cameraIntrinsic` object

Intrinsic camera parameters, specified as a `cameraIntrinsic` object.

Output Arguments**pitch — Pitch angle**

real scalar

Pitch angle between the horizontal plane of the vehicle and the optical axis of the camera, returned as a real scalar in degrees. `pitch` uses the ISO convention for rotation, with a clockwise-positive angle direction when looking in the positive direction of the vehicle's Y_V -axis.

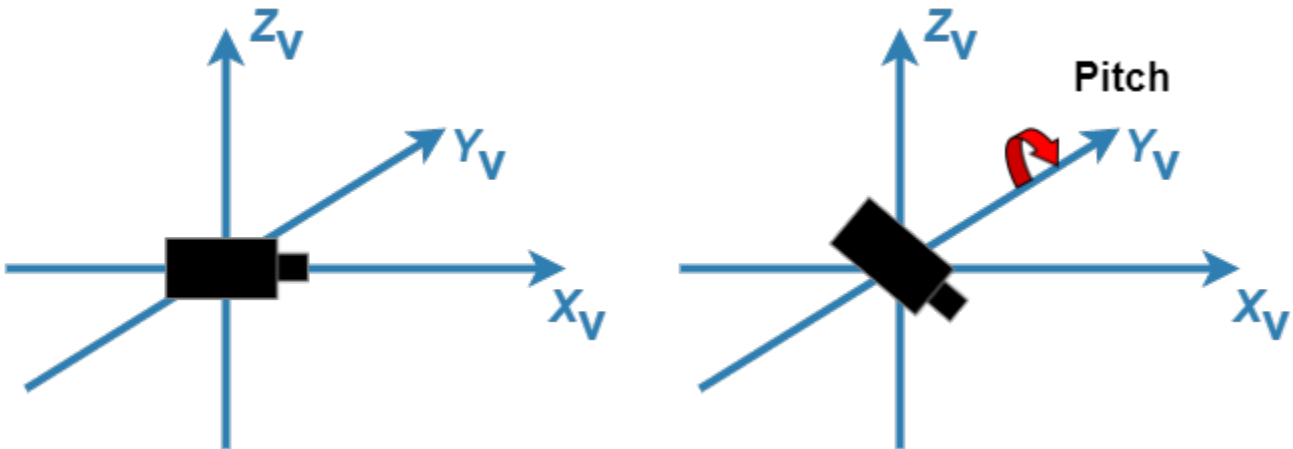

For more details, see “Angle Directions” on page 3-109.

yaw – Yaw angle

real scalar

Yaw angle between the X_V -axis of the vehicle and the optical axis of the camera, returned as a real scalar in degrees. `yaw` uses the ISO convention for rotation, with a clockwise-positive angle direction when looking in the positive direction of the vehicle's Z_V -axis.

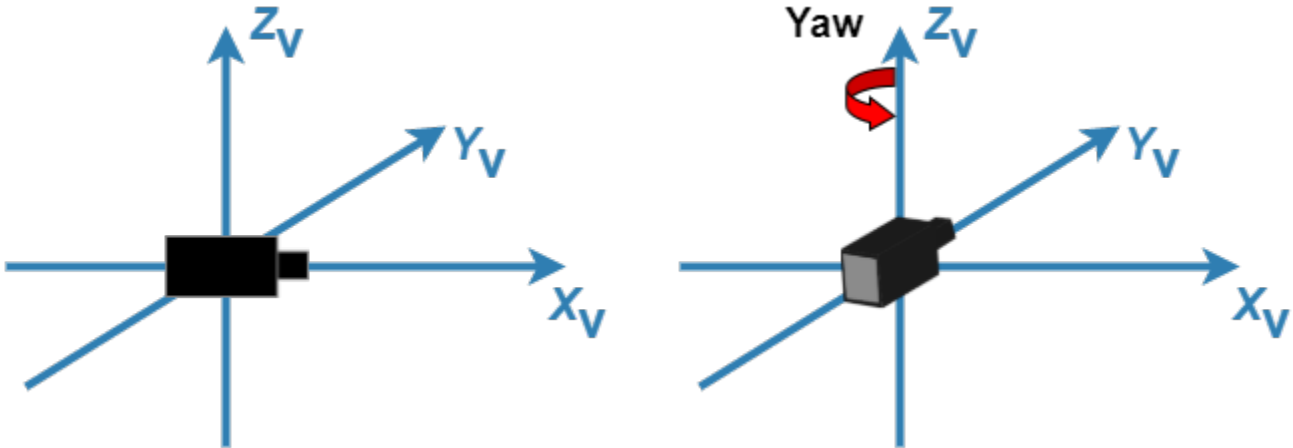

For more details, see “Angle Directions” on page 3-109.

roll – Roll angle

real scalar

Roll angle of the camera around its optical axis, returned as a real scalar in degrees. `roll` uses the ISO convention for rotation, with a clockwise-positive angle direction when looking in the positive direction of the vehicle's X_V -axis.

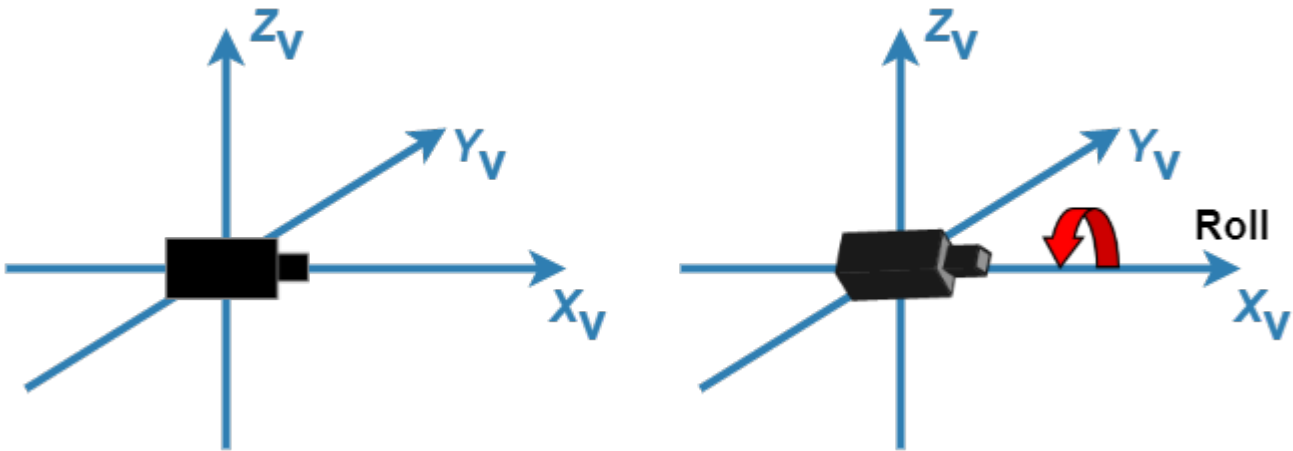

For more details, see “Angle Directions” on page 3-109.

height — Perpendicular height from ground to camera

nonnegative real scalar

Perpendicular height from the ground to the focal point of the camera, returned as a nonnegative real scalar in meters.



intrinsicOut — Intrinsic camera parameters

cameraIntrinsic object

Intrinsic camera parameters, returned as a cameraIntrinsic object.

Limitations

- The cameraIntrinsic object returned has the same estimated focal length values in x and y .
- The function does not estimate skew, radial distortion, and tangential distortion. These values are θ in the returned cameraIntrinsic object.

Version History

Introduced in R2022b

See Also

Apps

Camera Calibrator

Functions

estimateMonoCameraParameters | estimateCameraParameters | extrinsics

Objects

monoCamera | cameraIntrinsics | fisheyeIntrinsics

Topics

“Calibrate a Monocular Camera”

“Configure Monocular Fisheye Camera”

“Coordinate Systems in Automated Driving Toolbox”

evaluateLaneBoundaries

Evaluate lane boundary models against ground truth

Syntax

```
numMatches = evaluateLaneBoundaries(boundaries,worldGroundTruthPoints,
threshold)
[numMatches,numMissed,numFalsePositives] = evaluateLaneBoundaries( ___ )
[ ___ ] = evaluateLaneBoundaries( ___ ,xWorld)

[ ___ ] = evaluateLaneBoundaries(boundaries,groundTruthBoundaries,threshold)
[ ___ ,assignments] = evaluateLaneBoundaries( ___ )
```

Description

`numMatches = evaluateLaneBoundaries(boundaries,worldGroundTruthPoints, threshold)` evaluates candidate lane boundary models, `boundaries`, against lane boundaries formed by world coordinate ground truth points, `worldGroundTruthPoints`, and returns the total number of matching lane boundaries, `numMatches`. If all points within a candidate boundary are within the lateral distance `threshold` of the ground truth lane boundary, then that boundary is considered a valid match (true positive).

`[numMatches,numMissed,numFalsePositives] = evaluateLaneBoundaries(___)` also returns the total number of misses (false negatives) and false positives, using the previous inputs.

`[___] = evaluateLaneBoundaries(___ ,xWorld)` specifies the x-axis points at which to perform the comparisons. Points specified in `worldGroundTruthPoints` are linearly interpolated at the given x-axis locations.

`[___] = evaluateLaneBoundaries(boundaries,groundTruthBoundaries,threshold)` compares the boundaries against ground truth models that are specified in an array of lane boundary objects or a cell array of arrays.

`[___ ,assignments] = evaluateLaneBoundaries(___)` also returns the assignment indices that are specified in `groundTruthBoundaries`. Each boundary is matched to the corresponding class assignment in `groundTruthBoundaries`. The `k`th boundary in `boundaries` is matched to the `assignments(k)` element of `worldGroundTruthPoints`. Zero indicates a false positive (no match found).

Examples

Compare Lane Boundary Models

Create a set of ground truth points, add noise to simulate actual lane boundary points, and compare the simulated data to the model.

Create a set of points representing ground truth by using parabolic parameters.

```
parabolaParams1 = [-0.001 0.01 0.5];
parabolaParams2 = [0.001 0.02 0.52];
```



```
x = (0:0.1:20)';
y1 = polyval(parabolaParams1,x);
y2 = polyval(parabolaParams1,x);
```

Add noise relative to the offset parameter.

```
y1 = y1 + 0.10*parabolaParams1(3)*(rand(length(y1),1)-0.5);
y2 = y2 + 0.10*parabolaParams2(3)*(rand(length(y2),1)-0.5);
```

Create a set of test boundary models.

```
testlbs = parabolicLaneBoundary([-0.002 0.01 0.5;
                                -0.001 0.02 0.45;
                                -0.001 0.01 0.5;
                                0.000 0.02 0.52;
                                -0.001 0.01 0.51]);
```

Compare the boundary models to the ground truth points. Calculate the precision and sensitivity of the models based on the number of matches, misses, and false positives.

```
threshold = 0.1;
[numMatches,numMisses,numFalsePositives,~] = ...
    evaluateLaneBoundaries(testlbs,{[x y1],[x y2]},threshold);
```

```
disp('Precision:');
```

Precision:

```
disp(numMatches/(numMatches+numFalsePositives));
```

```
0.4000
```

```
disp('Sensitivity/Recall:');
```

Sensitivity/Recall:

```
disp(numMatches/(numMatches+numMisses));
```

```
1
```

Input Arguments

worldGroundTruthPoints — Ground truth points of lane boundaries

[x y] array | cell array of [x y] arrays

Ground truth points of lane boundaries, specified as an [x y] array or cell array of [x y] arrays. The x-axis points must be unique and in the same coordinate system as the boundary models. A lane boundary must contain at least two points, but for a robust comparison, four or more points are recommended. Each element of the cell array represents a separate lane boundary.

threshold — Maximum lateral distance from ground truth

real scalar

Maximum lateral distance between a model and ground truth point in order for that point to be considered a valid match (true positive), specified as a real scalar.

boundaries — Lane boundary modelsarray of `parabolicLaneBoundary` objects | array of `cubicLaneBoundary` objects

Lane boundary models, specified as an array of `parabolicLaneBoundary` objects or `cubicLaneBoundary` objects. Lane boundary models contain the following properties:

- **Parameters** — A vector corresponding to the coefficients of the boundary model. The size of the vector depends on the degree of polynomial for the model.

Lane Boundary Object	Parameters
<code>parabolicLaneBoundary</code>	[A B C], corresponding to coefficients of a second-degree polynomial equation of the form $y = Ax^2 + Bx + C$
<code>cubicLaneBoundary</code>	[A B C D], corresponding to coefficients of a third-degree polynomial equation of the form $y = Ax^3 + Bx^2 + Cx + D$

- **BoundaryType** — A `LaneBoundaryType` enumeration of supported lane boundaries:
 - `Unmarked`
 - `Solid`
 - `Dashed`
 - `BottsDots`
 - `DoubleSolid`

Specify a lane boundary type as `LaneBoundaryType.BoundaryType`. For example:

```
LaneBoundaryType.BottsDots
```

- **Strength** — The ratio of the number of unique x-axis locations on the boundary to the total number of points along the line based on the `XExtent` property.
- **XExtent** — A two-element vector describing the minimum and maximum x-axis locations for the boundary points.

xWorld — x-axis locations of boundary

real-valued vector

x-axis locations of boundary, specified as a real-valued vector. Points in `worldGroundTruthPoints` are linearly interpolated at the given x-axis locations. Boundaries outside of these locations are excluded and count as false negatives.

groundTruthBoundaries — Ground truth boundary modelsarray of `parabolicLaneBoundary` or `cubicLaneBoundary` objects | cell array of `parabolicLaneBoundary` or `cubicLaneBoundary` arrays

Ground truth boundary models, specified as an array of `parabolicLaneBoundary` or `cubicLaneBoundary` objects or cell array of `parabolicLaneBoundary` or `cubicLaneBoundary` arrays.

Output Arguments**numMatches — Number of matches (true positives)**

real scalar

Number of matches (true positives), returned as a real scalar.

numMissed – Number of misses (false negatives)

real scalar

Number of misses (false negatives), returned as a real scalar.

numFalsePositives – Number of false positives

real scalar

Number of false positives, returned as a real scalar.

assignments – Assignment indices for ground truth boundaries

cell array of real-valued arrays

Assignment indices for ground truth boundaries, returned as a cell array of real-valued arrays. Each boundary is matched to the corresponding assignment in `groundTruthBoundaries`. The *k*th boundary in `boundaries` is matched to the `assignments(k)` element of `worldGroundTruthPoints`. Zero indicates a false positive (no match found).

Version History

Introduced in R2017a

See Also

Functions

`findParabolicLaneBoundaries` | `findCubicLaneBoundaries`

Objects

`parabolicLaneBoundary` | `cubicLaneBoundary`

Apps

`Ground Truth Labeler`

findCubicLaneBoundaries

Find boundaries using cubic model

Syntax

```
boundaries = findCubicLaneBoundaries(xyBoundaryPoints,approxBoundaryWidth)
[boundaries,boundaryPoints] = findCubicLaneBoundaries(xyBoundaryPoints,
approxBoundaryWidth)
[ ___ ] = findCubicLaneBoundaries( ___ ,Name,Value)
```

Description

`boundaries = findCubicLaneBoundaries(xyBoundaryPoints,approxBoundaryWidth)` uses the random sample consensus (RANSAC) algorithm to find cubic lane boundary models that fit a set of boundary points and an approximate width. Each model in the returned array of `cubicLaneBoundary` objects contains the [A B C D] coefficients of its third-degree polynomial equation and the strength of the boundary estimate.

`[boundaries,boundaryPoints] = findCubicLaneBoundaries(xyBoundaryPoints,approxBoundaryWidth)` also returns a cell array of inlier boundary points for each boundary model found, using the previous input arguments.

`[___] = findCubicLaneBoundaries(___ ,Name,Value)` uses options specified by one or more `Name,Value` pair arguments, with any of the preceding syntaxes.

Examples

Find Cubic Lane Boundaries in Bird's-Eye-View Image

Find lanes in an image by using cubic lane boundary models. Overlay the identified lanes on the original image and on a bird's-eye-view transformation of the image.

Load an image of a road with lanes. The image was obtained from a camera sensor mounted on the front of a vehicle.

```
I = imread('road.png');
```

Transform the image into a bird's-eye-view image by using a preconfigured sensor object. This object models the sensor that captured the original image.

```
bevSensor = load('birdsEyeConfig');
birdsEyeImage = transformImage(bevSensor.birdsEyeConfig,I);
imshow(birdsEyeImage)
```



Set the approximate lane marker width in world units (meters).

```
approxBoundaryWidth = 0.25;
```

Detect lane features and display them as a black-and-white image.

```
birdsEyeBW = segmentLaneMarkerRidge(im2gray(birdsEyeImage), ...  
    bevSensor.birdsEyeConfig,approxBoundaryWidth);  
imshow(birdsEyeBW)
```

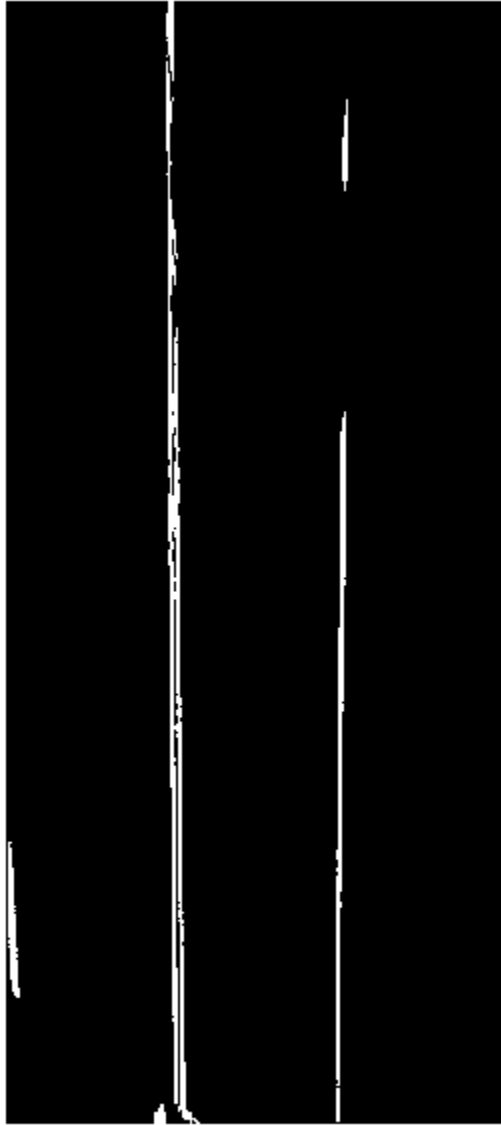

Obtain the image coordinates corresponding to the lane candidate positions. The `find` function returns pixel indices that correspond to the candidate lane positions. By convention, the order of the image coordinates is always reversed relative to the pixel indices. For more information about image coordinates, see “Coordinate Systems”.

Obtain the corresponding lane boundary points in vehicle coordinates by using the `imageToVehicle` function.

```
[imgaeY,imageX] = find(birdsEyeBW);  
xyBoundaryPoints = imageToVehicle(bevSensor.birdsEyeConfig,[imageX,imgaeY]);
```

Find lane boundaries in the image by using the `findCubicLaneBoundaries` function. By default, the function returns a maximum of two lane boundaries. The boundaries are stored in an array of `cubicLaneBoundary` objects.

```
boundaries = findCubicLaneBoundaries(xyBoundaryPoints,approxBoundaryWidth);
```

Use `insertLaneBoundary` to overlay the lanes on the original image. The `XPoints` vector represents the lane points, in meters, that are within range of the ego vehicle's sensor. Specify the lanes in different colors. By default, lanes are yellow.

```
XPoints = 3:30;
```

```
figure
sensor = bevSensor.birdsEyeConfig.Sensor;
lanesI = insertLaneBoundary(I,boundaries(1),sensor,XPoints);
lanesI = insertLaneBoundary(lanesI,boundaries(2),sensor,XPoints,'Color','green');
imshow(lanesI)
```



View the lanes in the bird's-eye-view image.

```
figure
BEconfig = bevSensor.birdsEyeConfig;
lanesBEI = insertLaneBoundary(birdsEyeImage,boundaries(1),BEconfig,XPoints);
```

```
lanesBEI = insertLaneBoundary(lanesBEI, boundaries(2), BEconfig, XPoints, 'Color', 'green');  
imshow(lanesBEI)
```

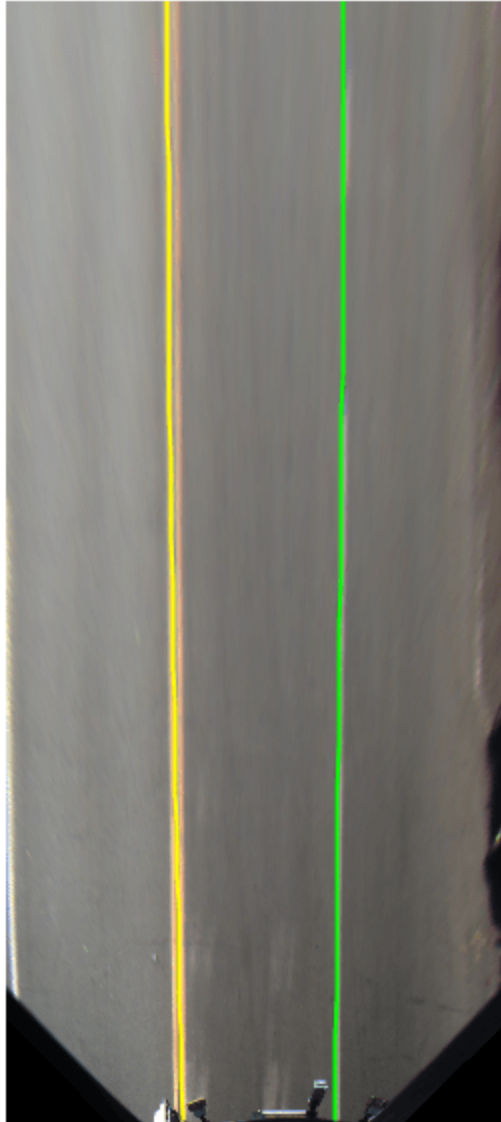

Input Arguments

xyBoundaryPoints — Candidate boundary points
[x y] vector

Candidate boundary points, specified as an $[x \ y]$ vector in vehicle coordinates. To obtain the vehicle coordinates for points in a `birdsEyeView` image, use the `imageToVehicle` function to convert the bird's-eye-view image coordinates to vehicle coordinates.

approxBoundaryWidth — Approximate boundary width

real scalar

Approximate boundary width, specified as a real scalar in world units. The width is a horizontal y-axis measurement.

Name-Value Pair Arguments

Specify optional pairs of arguments as `Name1=Value1, ..., NameN=ValueN`, where `Name` is the argument name and `Value` is the corresponding value. Name-value arguments must appear after other arguments, but the order of the pairs does not matter.

Before R2021a, use commas to separate each name and value, and enclose Name in quotes.

Example: `'MaxSamplingAttempts',200`

MaxNumBoundaries — Maximum number of lane boundaries

2 (default) | positive integer

Maximum number of lane boundaries that the function attempts to find, specified as the comma-separated pair consisting of `'MaxNumBoundaries'` and a positive integer.

ValidateBoundaryFcn — Function to validate boundary model

function handle

Function to validate the boundary model, specified as the comma-separated pair consisting of `'ValidateBoundaryFcn'` and a function handle. The specified function returns logical 1 (true) if the boundary model is accepted and logical 0 (false) otherwise. Use this function to reject invalid boundaries. The function must be of the form:

```
isValid = validateBoundaryFcn(parameters)
```

`parameters` is a vector corresponding to the three parabolic parameters.

The default validation function always returns 1 (true).

MaxSamplingAttempts — Maximum number of sampling attempts

100 (default) | positive integer

Maximum number of attempts to find a sample of points that yields a valid cubic boundary, specified as the comma-separated pair consisting of `'MaxSamplingAttempts'` and a function handle. `findCubicLaneBoundaries` uses the `fitPolynomialRANSAC` function to sample from the set of boundary points and fit a cubic boundary line.

Output Arguments

boundaries — Lane boundary models

array of `cubicLaneBoundary` objects

Lane boundary models, returned as an array of `cubicLaneBoundary` objects. This table shows the properties of the each output boundary object.

Property	Description
Parameters	Coefficients for a cubic model of the form $y = Ax^3 + Bx^2 + Cx + D$, specified as a real-valued vector of the form [A B C D].
BoundaryType	Type of lane boundary, specified as a LaneBoundaryType enumeration. Supported lane boundary types are: <ul style="list-style-type: none"> • Unmarked • Solid • Dashed • BottsDots • DoubleSolid <p>Lane boundary objects always return BoundaryType as type Solid. Update these types to match the types of the lanes that are being fitted. To update a lane boundary type, use the LaneBoundaryType.BoundaryType syntax. For example, this code sample shows how to update the first output lane boundary to type BottsDots:</p> <pre>boundaries(1) = LaneBoundaryType.BottsDots;</pre>
Strength	Strength of the boundary model, specified as a real scalar. Strength is the ratio of the number of unique x-axis locations on the boundary to the length of the boundary specified by the XExtent property. A solid line without any breaks has a higher strength than a dotted line that has breaks along the full length of the boundary.
XExtent	Length of the boundary along the x-axis, specified as a real-valued vector of the form [minX maxX] that describes the minimum and maximum x-axis locations.

boundaryPoints — Inlier boundary points

cell array of [x y] values

Inlier boundary points, returned as a cell array of [x y] values. Each element of the cell array corresponds to the same element in the array of cubicLaneBoundary objects.

Tips

- To fit a single boundary model to a double lane marker, set the approxBoundaryWidth argument to be large enough to include the width spanning both lane markers.

Algorithms

- This function uses `fitPolynomialRANSAC` to find cubic models. Because this algorithm uses random sampling, the output can vary between runs.
- The `maxDistance` parameter of `fitPolynomialRANSAC` is set to half the width specified in the `approxBoundaryWidth` argument. Points are considered inliers if they are within the boundary width. The function obtains the final boundary model using a least-squares fit on the inlier points.

Version History

Introduced in R2018a

Extended Capabilities

C/C++ Code Generation

Generate C and C++ code using MATLAB® Coder™.

See Also

`cubicLaneBoundary` | `birdsEyeView` | `monoCamera` | `segmentLaneMarkerRidge` | `fitPolynomialRANSAC` | `birdsEyePlot`

findParabolicLaneBoundaries

Find boundaries using parabolic model

Syntax

```
boundaries = findParabolicLaneBoundaries(xyBoundaryPoints,  
approxBoundaryWidth)  
[boundaries,boundaryPoints] = findParabolicLaneBoundaries(xyBoundaryPoints,  
approxBoundaryWidth)  
[ ___ ] = findParabolicLaneBoundaries( ___ ,Name,Value)
```

Description

`boundaries = findParabolicLaneBoundaries(xyBoundaryPoints, approxBoundaryWidth)` uses the random sample consensus (RANSAC) algorithm to find parabolic lane boundary models that fit a set of boundary points and an approximate width. Each model in the returned array of `parabolicLaneBoundary` objects contains the [A B C] coefficients of its second-degree polynomial equation and the strength of the boundary estimate.

`[boundaries,boundaryPoints] = findParabolicLaneBoundaries(xyBoundaryPoints, approxBoundaryWidth)` also returns a cell array of inlier boundary points for each boundary model found.

`[___] = findParabolicLaneBoundaries(___ ,Name,Value)` uses options specified by one or more Name,Value pair arguments, with any of the preceding syntaxes.

Examples

Find Parabolic Lane Boundaries in Bird's-Eye-View Image

Find lanes in an image by using parabolic lane boundary models. Overlay the identified lanes on the original image and on a bird's-eye-view transformation of the image.

Load an image of a road with lanes. The image was obtained from a camera sensor mounted on the front of a vehicle.

```
I = imread('road.png');
```

Transform the image into a bird's-eye-view image by using a preconfigured sensor object. This object models the sensor that captured the original image.

```
bevSensor = load('birdsEyeConfig');  
birdsEyeImage = transformImage(bevSensor.birdsEyeConfig,I);  
imshow(birdsEyeImage)
```



Set the approximate lane marker width in world units (meters).

```
approxBoundaryWidth = 0.25;
```

Detect lane features and display them as a black-and-white image.

```
birdsEyeBW = segmentLaneMarkerRidge(im2gray(birdsEyeImage), ...  
    bevSensor.birdsEyeConfig,approxBoundaryWidth);  
imshow(birdsEyeBW)
```

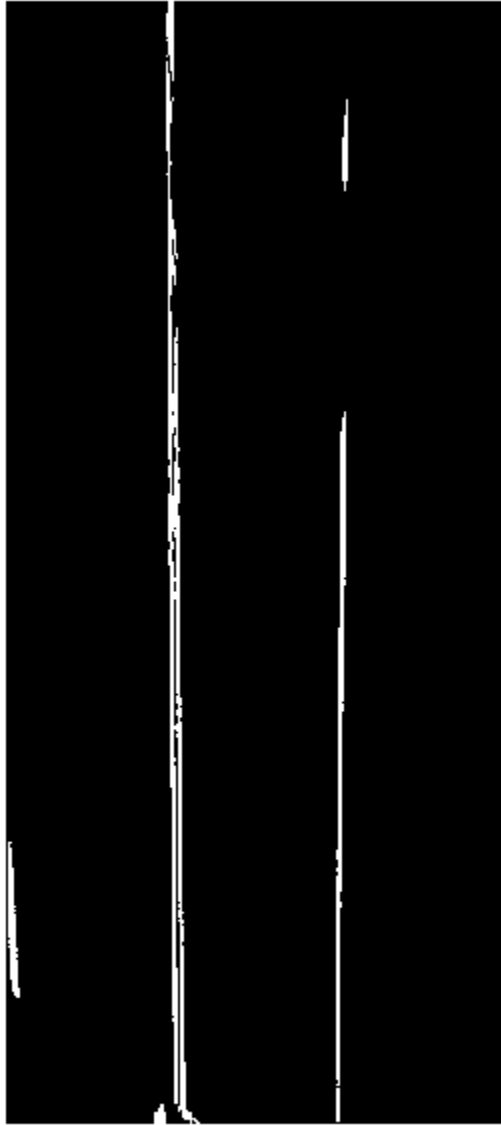

Obtain the image coordinates corresponding to the lane candidate positions. The `find` function returns pixel indices that correspond to the candidate lane positions. By convention, the order of the image coordinates is always reversed relative to the pixel indices. For more information about image coordinates, see “Coordinate Systems”.

Obtain the corresponding lane boundary points in vehicle coordinates by using the `imageToVehicle` function.

```
[imageY,imageX] = find(birdsEyeBW);  
xyBoundaryPoints = imageToVehicle(bevSensor.birdsEyeConfig,[imageX,imageY]);
```

Find lane boundaries in the image by using the `findParabolicLaneBoundaries` function. By default, the function returns a maximum of two lane boundaries. The boundaries are stored in an array of `parabolicLaneBoundary` objects.

```
boundaries = findParabolicLaneBoundaries(xyBoundaryPoints, approxBoundaryWidth);
```

Use `insertLaneBoundary` to overlay the lanes on the original image. The `XPoints` vector represents the lane points, in meters, that are within range of the ego vehicle's sensor. Specify the lanes in different colors. By default, lanes are yellow.

```
XPoints = 3:30;
```

```
figure
sensor = bevSensor.birdsEyeConfig.Sensor;
lanesI = insertLaneBoundary(I, boundaries(1), sensor, XPoints);
lanesI = insertLaneBoundary(lanesI, boundaries(2), sensor, XPoints, 'Color', 'green');
imshow(lanesI)
```



View the lanes in the bird's-eye-view image.

```
figure
BEconfig = bevSensor.birdsEyeConfig;
lanesBEI = insertLaneBoundary(birdsEyeImage, boundaries(1), BEconfig, XPoints);
```

```
lanesBEI = insertLaneBoundary(lanesBEI, boundaries(2), BEconfig, XPoints, 'Color', 'green');  
imshow(lanesBEI)
```

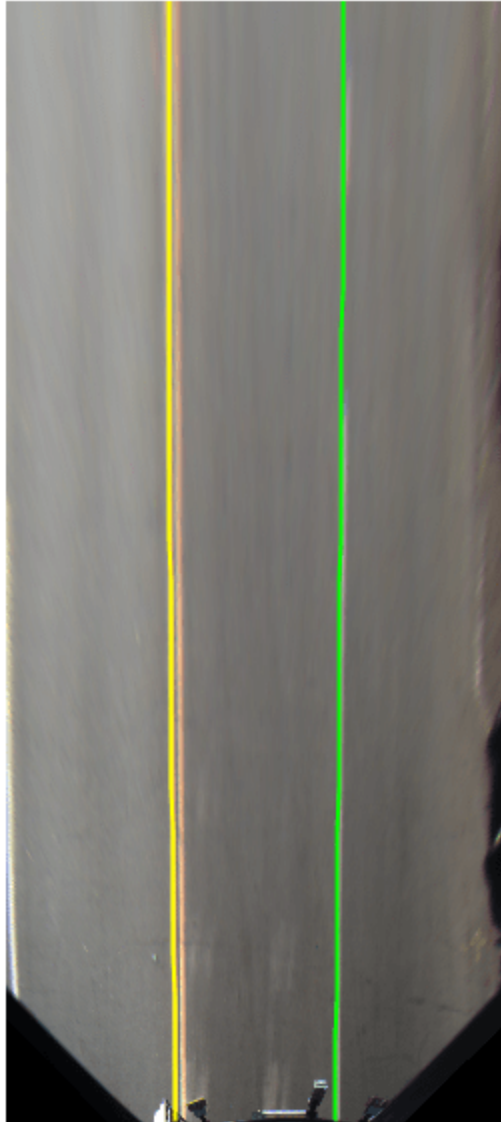

Input Arguments

xyBoundaryPoints — Candidate boundary points
[x y] vector

Candidate boundary points, specified as an $[x \ y]$ vector in vehicle coordinates. To obtain the vehicle coordinates for points in a `birdsEyeView` image, use the `imageToVehicle` function to convert the bird's-eye-view image coordinates to vehicle coordinates.

approxBoundaryWidth — Approximate boundary width

real scalar

Approximate boundary width, specified as a real scalar in world units. The width is a horizontal y-axis measurement.

Name-Value Pair Arguments

Specify optional pairs of arguments as `Name1=Value1, ..., NameN=ValueN`, where `Name` is the argument name and `Value` is the corresponding value. Name-value arguments must appear after other arguments, but the order of the pairs does not matter.

Before R2021a, use commas to separate each name and value, and enclose Name in quotes.

Example: `'MaxSamplingAttempts',200`

MaxNumBoundaries — Maximum number of lane boundaries

2 (default) | positive integer

Maximum number of lane boundaries that the function attempts to find, specified as the comma-separated pair consisting of `'MaxNumBoundaries'` and a positive integer.

ValidateBoundaryFcn — Function to validate boundary model

function handle

Function to validate the boundary model, specified as the comma-separated pair consisting of `'ValidateBoundaryFcn'` and a function handle. The specified function returns logical 1 (true) if the boundary model is accepted and logical 0 (false) otherwise. Use this function to reject invalid boundaries. The function must be of the form:

```
isValid = validateBoundaryFcn(parameters)
```

`parameters` is a vector corresponding to the three parabolic parameters.

The default validation function always returns 1 (true).

MaxSamplingAttempts — Maximum number of sampling attempts

100 (default) | positive integer

Maximum number of attempts to find a sample of points that yields a valid parabolic boundary, specified as the comma-separated pair consisting of `'MaxSamplingAttempts'` and a function handle. `findParabolicLaneBoundaries` uses the `fitPolynomialRANSAC` function to sample from the set of boundary points and fit a parabolic boundary line.

Output Arguments

boundaries — Lane boundary models

array of `parabolicLaneBoundary` objects

Lane boundary models, returned as an array of `parabolicLaneBoundary` objects. This table shows the properties of the each output boundary object.

Property	Description
Parameters	Coefficients for a parabolic model of the form $y = Ax^2 + Bx + C$, specified as a real-valued vector of the form [A B C].
BoundaryType	Type of lane boundary, specified as a LaneBoundaryType enumeration. Supported lane boundary types are: <ul style="list-style-type: none"> • Unmarked • Solid • Dashed • BottsDots • DoubleSolid <p>Lane boundary objects always return BoundaryType as type Solid. Update these types to match the types of the lanes that are being fitted. To update a lane boundary type, use the LaneBoundaryType.BoundaryType syntax. For example, this code sample shows how to update the first output lane boundary to type BottsDots:</p> <pre>boundaries(1) = LaneBoundaryType.BottsDots;</pre>
Strength	Strength of the boundary model, specified as a real scalar. Strength is the ratio of the number of unique x-axis locations on the boundary to the length of the boundary specified by the XExtent property. A solid line without any breaks has a higher strength than a dotted line that has breaks along the full length of the boundary.
XExtent	Length of the boundary along the x-axis, specified as a real-valued vector of the form [minX maxX] that describes the minimum and maximum x-axis locations.

boundaryPoints — Inlier boundary points

cell array of [x y] values

Inlier boundary points, returned as a cell array of [x y] values. Each element of the cell array corresponds to the same element in the array of parabolicLaneBoundary objects.

Tips

- To fit a single boundary model to a double lane marker, set the approxBoundaryWidth argument to be large enough to include the width spanning both lane markers.

Algorithms

- This function uses `fitPolynomialRANSAC` to find parabolic models. Because this algorithm uses random sampling, the output can vary between runs.
- The `maxDistance` parameter of `fitPolynomialRANSAC` is set to half the width specified in the `approxBoundaryWidth` argument. Points are considered inliers if they are within the boundary width. The function obtains the final boundary model using a least-squares fit on the inlier points.

Version History

Introduced in R2017a

Extended Capabilities

C/C++ Code Generation

Generate C and C++ code using MATLAB® Coder™.

To select a set of parabolic lane boundary models from the output array `boundaries`, use either indexing by position or linear indexing. Logical indexing is not supported. For example,

```
boundaries = findParabolicLaneBoundaries(xyBoundaryPoints,...
                                         approxBoundaryWidth);
index = [1 2];
selectedBoundaries = boundaries(index);
```

See Also

[parabolicLaneBoundary](#) | [birdsEyeView](#) | [monoCamera](#) | [segmentLaneMarkerRidge](#) | [fitPolynomialRANSAC](#) | [birdsEyePlot](#)

getTrackPositions

Returns updated track positions and position covariance matrix

Syntax

```
positions = getTrackPositions(tracks,modelName)
positions = getTrackPositions(tracks,positionSelector)
[positions,positionCovariances] = getTrackPositions( ___ )
```

Description

`positions = getTrackPositions(tracks,modelName)` returns a matrix of track positions based on tracks and the model name.

`positions = getTrackPositions(tracks,positionSelector)` returns a matrix of track positions based on tracks and the position selector.

`[positions,positionCovariances] = getTrackPositions(___)` also returns the track position covariance matrices.

Examples

Find Position of 3-D Constant-Acceleration Object

Create an extended Kalman filter tracker for 3-D constant-acceleration motion.

```
tracker = multiObjectTracker('FilterInitializationFcn',@initcaekf);
```

Update the tracker with a single detection and get the tracks output.

```
detection = objectDetection(0,[10;-20;4],'ObjectClassID',3);
tracks = tracker(detection,0)
```

```
tracks =
  objectTrack with properties:
        TrackID: 1
        BranchID: 0
    SourceIndex: 0
        UpdateTime: 0
            Age: 1
        State: [9x1 double]
    StateCovariance: [9x9 double]
    StateParameters: [1x1 struct]
        ObjectClassID: 3
    ObjectClassProbabilities: 1
        TrackLogic: 'History'
    TrackLogicState: [1 0 0 0 0]
        IsConfirmed: 1
        IsCoasted: 0
        IsSelfReported: 1
```

```
ObjectAttributes: [1x1 struct]
```

Obtain the position vector from the track state using the model name.

```
position1 = getTrackPositions(tracks, "constacc")
```

```
position1 = 1x3
```

```
    10    -20     4
```

Obtain the position vector from the track state using a position selector.

```
positionSelector = [1 0 0 0 0 0 0 0 0; 0 0 0 1 0 0 0 0 0; 0 0 0 0 0 0 1 0 0];
position2 = getTrackPositions(tracks, positionSelector)
```

```
position2 = 1x3
```

```
    10    -20     4
```

Find Position and Covariance of 3-D Constant-Velocity Object

Create an extended Kalman filter tracker for 3-D constant-velocity motion.

```
tracker = multiObjectTracker("FilterInitializationFcn", @initcvekf);
```

Update the tracker with a single detection and get the tracks output.

```
detection = objectDetection(0, [10; 3; -7], "ObjectClassID", 3);
tracks = tracker(detection, 0)
```

```
tracks =
```

```
  objectTrack with properties:
```

```

        TrackID: 1
        BranchID: 0
        SourceIndex: 0
        UpdateTime: 0
        Age: 1
        State: [6x1 double]
        StateCovariance: [6x6 double]
        StateParameters: [1x1 struct]
        ObjectClassID: 3
ObjectClassProbabilities: 1
        TrackLogic: 'History'
        TrackLogicState: [1 0 0 0 0]
        IsConfirmed: 1
        IsCoasted: 0
        IsSelfReported: 1
        ObjectAttributes: [1x1 struct]
```

Obtain the position vector and position covariance for that track using the model name.

```
[position1, positionCovariance1] = getTrackPositions(tracks, "constvel")
```

```
position1 = 1×3
```

```
10    3    -7
```

```
positionCovariance1 = 3×3
```

```
1    0    0
0    1    0
0    0    1
```

Obtain the position vector and position covariance for that track using the position selector.

```
positionSelector = [1 0 0 0 0 0; 0 0 1 0 0 0; 0 0 0 0 1 0];
[position2,positionCovariance3] = getTrackPositions(tracks,positionSelector)
```

```
position2 = 1×3
```

```
10    3    -7
```

```
positionCovariance3 = 3×3
```

```
1    0    0
0    1    0
0    0    1
```

Input Arguments

tracks — Object tracks

array of `objectTrack` objects | array of structures

Object tracks, specified as an array of `objectTrack` objects or an array of structures containing sufficient information to obtain the track position information. At a minimum, these structures must contain a `State` column vector field and a positive-definite `StateCovariance` matrix field. For a sample track structure, see `toStruct`.

Note If you specify `tracks` as an empty `objectTrack` object, an empty cell, or an empty track structure, `positions` and `positionCovariances` are returned based on the second argument (`positionSelector` or `modelName`) as follows.

Second input argument	positions	positionCovariances
<code>positionSelector</code>	<code>positions</code> is returned as a <code>zeros(0,D)</code> vector, where <code>D</code> is the row-dimension of the position selector. In this case, if the <code>positionSelector</code> is specified in single-precision, the <code>positions</code> output is in single-precision.	<code>positionCovariances</code> is returned as a <code>zeros(D,D,0)</code> matrix, where <code>D</code> is the row-dimension of the position selector. In this case, if the <code>positionSelector</code> is specified in single-precision, the <code>positionCovariances</code> output is in single-precision.

Second input argument	positions	positionCovariances
modelName	positions is returned as a zeros(0,3) vector.	positionCovariances is returned as a zeros(3,3,0) matrix.

modelName — Motion model name

"constvel" | "constacc" | "singer" | "constturn"

Motion model name, specified as one of these options:

- "constvel" — The function obtains the position states based on the state definition in the constvel function.
- "constacc" — The function obtains the position states based on the state definition in the constacc function.
- "constturn" — The function obtains the position states based on the state definition in the constturn function.
- "singer" — The function obtains the position states based on the state definition in the singer function. The use of singer model requires the Sensor Fusion and Tracking Toolbox.

positionSelector — Position selection matrix

D-by-*N* real-valued matrix.

Position selector, specified as a *D*-by-*N* real-valued matrix of ones and zeros. *D* is the number of dimensions of the tracker. *N* is the size of the state vector. Using this matrix, the function extracts track positions from the state vector. Multiply the state vector by position selector matrix returns positions. The same selector is applied to all object tracks.

Output Arguments

positions — Positions of tracked objects

real-valued *M*-by-*D* matrix

Positions of tracked objects at last update time, returned as a real-valued *M*-by-*D* matrix. *D* represents the number of position elements. *M* represents the number of tracks.

positionCovariances — Position covariance matrices of tracked objects

real-valued *D*-by-*D*-*M* array

Position covariance matrices of tracked objects, returned as a real-valued *D*-by-*D*-*M* array. *D* represents the number of position elements. *M* represents the number of tracks. Each *D*-by-*D* submatrix is a position covariance matrix for a track.

More About

Position Selector for 2-Dimensional Motion

Show the position selection matrix for two-dimensional motion when the state consists of the position and velocity.

$$\begin{bmatrix} 1 & 0 & 0 & 0 \\ 0 & 0 & 1 & 0 \end{bmatrix}$$

Position Selector for 3-Dimensional Motion

Show the position selection matrix for three-dimensional motion when the state consists of the position and velocity.

$$\begin{bmatrix} 1 & 0 & 0 & 0 & 0 & 0 \\ 0 & 0 & 1 & 0 & 0 & 0 \\ 0 & 0 & 0 & 0 & 1 & 0 \end{bmatrix}$$

Position Selector for 3-Dimensional Motion with Acceleration

Show the position selection matrix for three-dimensional motion when the state consists of the position, velocity, and acceleration.

$$\begin{bmatrix} 1 & 0 & 0 & 0 & 0 & 0 & 0 & 0 & 0 \\ 0 & 0 & 0 & 1 & 0 & 0 & 0 & 0 & 0 \\ 0 & 0 & 0 & 0 & 0 & 0 & 1 & 0 & 0 \end{bmatrix}$$

Version History

Introduced in R2017a

R2022b: Obtain position and covariance from tracks using motion model name input

You can now obtain positions and associated covariances of tracks by specifying the motion model name as an input. For example,

```
[positions,covariances] = getTrackPositions(tracks,"constvel")
```

returns positions and position covariances in tracks based on the constant-velocity model in the `constvel` function.

Extended Capabilities

C/C++ Code Generation

Generate C and C++ code using MATLAB® Coder™.

- In code generation, if you use the `modelName` input, the `tracks` input must be specified as non-empty structures. Use the following if empty structures are unavoidable:

```
if isempty(tracks)
    % Return the sizes and data types you desire
    positions = zeros(0,3,"single");
    positionCovariances = zeros(3,3,0,"single");
else
    [positions,positionCovariances] = getTrackPositons(tracks,"constvel");
end
```

See Also

Functions

`getTrackVelocities` | `initcaekf` | `initcakf` | `initcaukf` | `initctekf` | `initctukf` | `initcvkf` | `initcvukf`

Objects

objectDetection | multiObjectTracker

getTrackVelocities

Obtain updated track velocities and velocity covariance matrix

Syntax

```
positions = getTrackVelocities(tracks,modelName)
velocities = getTrackVelocities(tracks,velocitySelector)
[velocities,velocityCovariances] = getTrackVelocities(tracks,
velocitySelector)
```

Description

`positions = getTrackVelocities(tracks,modelName)` returns a matrix of track velocities based on tracks and the model name.

`velocities = getTrackVelocities(tracks,velocitySelector)` returns a matrix of track velocities based on tracks and the velocity selector.

`[velocities,velocityCovariances] = getTrackVelocities(tracks,velocitySelector)` also returns the track velocity covariance matrices.

Examples

Find Velocity of 3-D Constant-Acceleration Object

Create an extended Kalman filter tracker for 3-D constant-acceleration motion.

```
tracker = multiObjectTracker('FilterInitializationFcn',@initcaekf);
```

Initialize the tracker with one detection.

```
detection = objectDetection(0,[10;-20;4],'ObjectClassID',3);
tracks = tracker(detection,0);
```

Add a second detection at a later time and at a different position.

```
detection = objectDetection(0.1,[10.3;-20.2;4],'ObjectClassID',3);
tracks = tracker(detection,0.2);
```

Obtain the velocity vector from the track state using the model name.

```
velocity1 = getTrackVelocities(tracks,"constacc")
```

```
velocity1 = 1×3
```

```
    1.0093    -0.6728         0
```

Obtain the velocity vector from the track state using the position selector.

```
velocitySelector = [0 1 0 0 0 0 0 0 0; 0 0 0 0 1 0 0 0 0; 0 0 0 0 0 0 0 0 1 0];
velocity2 = getTrackVelocities(tracks,velocitySelector)
```

```
velocity2 = 1x3
    1.0093   -0.6728    0
```

Velocity and Covariance of 3-D Constant-Acceleration Object

Create an extended Kalman filter tracker for 3-D constant-acceleration motion.

```
tracker = multiObjectTracker("FilterInitializationFcn",@initcaekf);
```

Initialize the tracker with one detection.

```
detection = objectDetection(0,[10;-20;4],"ObjectClassID",3);
tracks = tracker(detection,0);
```

Add a second detection at a later time and at a different position.

```
detection = objectDetection(0.1,[10.3;-20.2;4.3],"ObjectClassID",3);
tracks = tracker(detection,0.2);
```

Obtain the velocity vector from the track state using the model name.

```
[velocity1,velocityCovariance1] = getTrackVelocities(tracks,"constacc")
```

```
velocity1 = 1x3
    1.0093   -0.6728    1.0093
```

```
velocityCovariance1 = 3x3
    70.0685    0    0
     0    70.0685    0
     0    0    70.0685
```

Obtain the velocity vector from the track state using the velocity selector.

```
velocitySelector = [0 1 0 0 0 0 0 0 0; 0 0 0 0 1 0 0 0 0; 0 0 0 0 0 0 0 0 1];
[velocity2,velocityCovariance2] = getTrackVelocities(tracks,velocitySelector)
```

```
velocity2 = 1x3
    1.0093   -0.6728    1.0093
```

```
velocityCovariance2 = 3x3
    70.0685    0    0
     0    70.0685    0
     0    0    70.0685
```

Input Arguments

tracks — Object tracks

array of `objectTrack` objects | array of structures

Object tracks, specified as an array of `objectTrack` objects or an array of structures containing sufficient information to obtain the track velocity information. At a minimum, these structures must contain a `State` column vector field and a positive-definite `StateCovariance` matrix field. For a sample track structure, see `toStruct`.

Note If you specify `tracks` as an empty `objectTrack` object, an empty cell, or an empty track structure, `velocities` and `velocityCovariances` are returned based on the second argument (`velocitySelector` or `modelName`) as follows.

Second input argument	velocities	velocityCovariances
<code>velocitySelector</code>	<code>velocities</code> is returned as a <code>zeros(0,D)</code> vector, where D is the row-dimension of the velocity selector. In this case, if the <code>velocitySelector</code> is specified in single-precision, the <code>positions</code> output is in single-precision.	<code>velocityCovariances</code> is returned as a <code>zeros(D,D,0)</code> matrix, where D is the row-dimension of the velocity selector. In this case, if the <code>velocitySelector</code> is specified in single-precision, the <code>velocityCovariances</code> output is in single-precision.
<code>modelName</code>	<code>velocities</code> is returned as a <code>zeros(0,3)</code> vector.	<code>velocityCovariances</code> is returned as a <code>zeros(3,3,0)</code> matrix.

modelName — Motion model name

"constvel" | "constacc" | "singer" | "constturn"

Motion model name, specified as one of these options:

- "constvel" — The function obtains the velocity states based on the state definition in the `constvel` function.
- "constacc" — The function obtains the velocity states based on the state definition in the `constacc` function.
- "constturn" — The function obtains the velocity states based on the state definition in the `constturn` function.
- "singer" — The function obtains the velocity states based on the state definition in the `singer` function. The use of `singer` model requires the Sensor Fusion and Tracking Toolbox.

velocitySelector — Velocity selection matrix

D -by- N real-valued matrix.

Velocity selector, specified as a D -by- N real-valued matrix of ones and zeros. D is the number of dimensions of the tracker. N is the size of the state vector. Using this matrix, the function extracts track velocities from the state vector. Multiply the state vector by velocity selector matrix returns velocities. The same selector is applied to all object tracks.

Output Arguments

velocities — Velocities of tracked objects

real-valued 1 -by- D vector | real-valued M -by- D matrix

Velocities of tracked objects at last update time, returned as a 1 -by- D vector or a real-valued M -by- D matrix. D represents the number of velocity elements. M represents the number of tracks.

velocityCovariances — Velocity covariance matrices of tracked objects

real-valued D -by- D -matrix | real-valued D -by- D -by- M array

Velocity covariance matrices of tracked objects, returned as a real-valued D -by- D -matrix or a real-valued D -by- D -by- M array. D represents the number of velocity elements. M represents the number of tracks. Each D -by- D submatrix is a velocity covariance matrix for a track.

More About

Velocity Selector for 2-Dimensional Motion

Show the velocity selection matrix for two-dimensional motion when the state consists of the position and velocity.

$$\begin{bmatrix} 0 & 1 & 0 & 0 \\ 0 & 0 & 0 & 1 \end{bmatrix}$$

Velocity Selector for 3-Dimensional Motion

Show the velocity selection matrix for three-dimensional motion when the state consists of the position and velocity.

$$\begin{bmatrix} 0 & 1 & 0 & 0 & 0 & 0 \\ 0 & 0 & 0 & 1 & 0 & 0 \\ 0 & 0 & 0 & 0 & 0 & 1 \end{bmatrix}$$

Velocity Selector for 3-Dimensional Motion with Acceleration

Show the velocity selection matrix for three-dimensional motion when the state consists of the position, velocity, and acceleration.

$$\begin{bmatrix} 0 & 1 & 0 & 0 & 0 & 0 & 0 & 0 \\ 0 & 0 & 0 & 0 & 1 & 0 & 0 & 0 \\ 0 & 0 & 0 & 0 & 0 & 0 & 0 & 1 \end{bmatrix}$$

Version History

Introduced in R2017a

R2022b: Obtain velocity and covariance from tracks using motion model name input

You can now obtain velocities and associated covariances of tracks by specifying the motion model name as an input. For example,

```
[positions,covariances] = getTrackVelocities(tracks,"constvel")
```

returns velocities and velocity covariances in tracks based on the constant-velocity model in the `constvel` function.

Extended Capabilities

C/C++ Code Generation

Generate C and C++ code using MATLAB® Coder™.

- In code generation, if you use the `modelName` input, the `tracks` input must be specified as non-empty structures. Use the following if empty structures are unavoidable:

```
if isempty(tracks)
    % Return the sizes and data types you desire
    velocities = zeros(0,3,"single");
    velocitiesCovariances = zeros(3,3,0,"single");
else
    [velocities,velocityCovariances] = getTrackVelocities(tracks,"constvel");
end
```

See Also

Functions

`getTrackPositions` | `initcaekf` | `initcakf` | `initcaukf` | `initctekf` | `initctukf` | `initcvkf` | `initcvukf`

Objects

`objectDetection` | `multiObjectTracker`

hereHDLMCredentials

Set up or delete HERE HD Live Map credentials

Syntax

```
hereHDLMCredentials('setup')  
hereHDLMCredentials('delete')
```

Description

`hereHDLMCredentials('setup')` opens a dialog box for specifying the credentials required to access the HERE HD Live Map ³ (HERE HDLM) web service. By default, credentials last for the duration of a MATLAB session. To save credentials between sessions, in the HERE HD Live Map Credentials dialog box, select the **Save my credentials between MATLAB sessions** check box .

Simplified form: `hereHDLMCredentials setup`

`hereHDLMCredentials('delete')` deletes saved HERE HDLM credentials. Any subsequent use of HERE HDLM functions and objects, such as the `hereHDLMConfiguration` or `hereHDLMReader` object, requires entering new credentials.

Simplified form: `hereHDLMCredentials delete`

Examples

Manage HERE HD Live Map Credentials

Set up HERE HD Live Map (HERE HDLM) credentials.

```
hereHDLMCredentials setup
```

³ You need to enter into a separate agreement with HERE in order to gain access to the HDLM services and to get the required credentials (`access_key_id` and `access_key_secret`) for using the HERE Service.

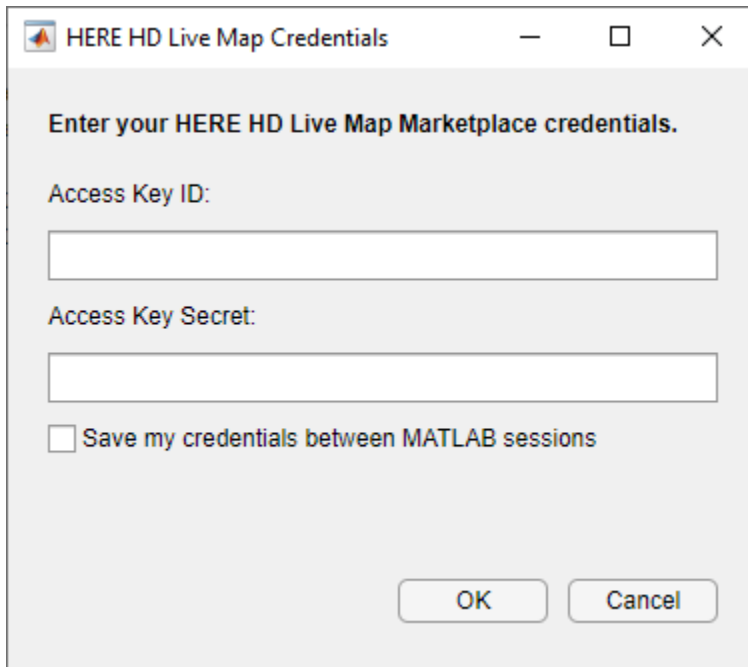

Enter a valid **Access Key ID** and **Access Key Secret**. You can obtain these credentials by entering into a separate agreement with HERE Technologies. Optionally, select **Save my credentials between MATLAB sessions** to save your HERE HDLM credentials between MATLAB sessions. Click **OK**.

Load a driving route, and create a HERE HDLM reader using the route coordinates. The HERE HD Live Map Credentials dialog box does not open because the credentials have already been set up.

```
data = load('geoSequence.mat');
reader = hereHDLMReader(data.latitude,data.longitude);
```

Delete the HERE HDLM credentials you previously entered. The next time you use `hereHDLMReader`, you must enter your credentials again.

```
hereHDLMCredentials delete
```

Version History

Introduced in R2019a

See Also

`hereHDLMConfiguration` | `hereHDLMReader`

Topics

“Read and Visualize HERE HD Live Map Data”

initcaabf

Create constant acceleration alpha-beta tracking filter from detection report

Syntax

```
abf = initcaabf(detection)
```

Description

`abf = initcaabf(detection)` initializes a constant acceleration alpha-beta tracking filter for object tracking based on information provided in `detection`.

The function initializes a constant acceleration state with the same convention as `constacc` and `cameas`, $[x \ v_x \ a_x \ y \ v_y \ a_y \ z \ v_z \ a_z]$.

Examples

Creating Constant Acceleration trackingABF Object from Detection

Create an `objectDetection` with a position measurement at $x=1$, $y=3$ and a measurement noise of $[1 \ 0.2; 0.2 \ 2]$;

```
detection = objectDetection(0,[1;3], 'MeasurementNoise', [1 0.2;0.2 2]);
```

Use `initccabf` to create a `trackingABF` filter initialized at the provided position and using the measurement noise defined above.

```
ABF = initcaabf(detection);
```

Check the values of the state and measurement noise. Verify that the filter state, `ABF.State`, has the same position components as the `Detection.Measurement`. Verify that the filter measurement noise, `ABF.MeasurementNoise`, is the same as the `Detection.MeasurementNoise` values.

`ABF.State`

```
ans = 6×1
```

```
1
0
0
3
0
0
```

`ABF.MeasurementNoise`

```
ans = 2×2
```

```
1.0000    0.2000
0.2000    2.0000
```

Input Arguments

detection — Detection report

`objectDetection` object

Detection report, specified as an `objectDetection` object.

Example: `detection = objectDetection(0,[1;4.5;3],'MeasurementNoise', [1.0 0 0; 0 2.0 0; 0 0 1.5])`

Output Arguments

abf — Constant velocity alpha-beta filter

`trackingABF` object

Constant acceleration alpha-beta tracking filter for object tracking, returned as a `trackingABF` object.

Algorithms

- The function computes the process noise matrix assuming a unit standard deviation for the acceleration change rate.
- You can use this function as the `FilterInitializationFcn` property of trackers.

Version History

Introduced in R2020a

Extended Capabilities

C/C++ Code Generation

Generate C and C++ code using MATLAB® Coder™.

See Also

`trackingABF` | `objectDetection` | `trackingKF` | `trackingEKF` | `trackingUKF`

initcvabf

Create constant velocity tracking alpha-beta filter from detection report

Syntax

```
abf = initcvabf(detection)
```

Description

`abf = initcvabf(detection)` initializes a constant velocity alpha-beta filter for object tracking based on information provided in `detection`.

The function initializes a constant velocity state with the same convention as `constvel` and `cvmeas`, $[x \ v_x \ y \ v_y \ z \ v_z]$.

Examples

Creating trackingABF Object from Detection

Create an `objectDetection` with a position measurement at $x=1$, $y=3$ and a measurement noise of $[1 \ 0.2; 0.2 \ 2]$;

```
detection = objectDetection(0, [1;3], 'MeasurementNoise', [1 0.2;0.2 2]);
```

Use `initcvabf` to create a `trackingABF` filter initialized at the provided position and using the measurement noise defined above.

```
ABF = initcvabf(detection);
```

Check the values of the state and measurement noise. Verify that the filter state, `ABF.State`, has the same position components as the `Detection.Measurement`. Verify that the filter measurement noise, `ABF.MeasurementNoise`, is the same as the `Detection.MeasurementNoise` values.

`ABF.State`

```
ans = 4×1
```

```

1
0
3
0
```

`ABF.MeasurementNoise`

```
ans = 2×2
```

```

1.0000    0.2000
0.2000    2.0000
```

Input Arguments

detection — Detection report

`objectDetection` object

Detection report, specified as an `objectDetection` object.

Example: `detection = objectDetection(0,[1;4.5;3],'MeasurementNoise', [1.0 0 0; 0 2.0 0; 0 0 1.5])`

Output Arguments

abf — Constant velocity alpha-beta filter

`trackingABF` object

Constant velocity alpha-beta tracking filter for object tracking, returned as a `trackingABF` object.

Algorithms

- The function computes the process noise matrix assuming a unit acceleration standard deviation.
- You can use this function as the `FilterInitializationFcn` property of trackers.

Version History

Introduced in R2020a

Extended Capabilities

C/C++ Code Generation

Generate C and C++ code using MATLAB® Coder™.

See Also

`trackingABF` | `objectDetection` | `trackingKF` | `trackingEKF` | `trackingUKF`

initcaekf

Create constant-acceleration extended Kalman filter from detection report

Syntax

```
filter = initcaekf(detection)
```

Description

`filter = initcaekf(detection)` creates and initializes a constant-acceleration extended Kalman filter from information contained in a `detection` report. For more information about the extended Kalman filter, see `trackingEKF`.

The function initializes a constant acceleration state with the same convention as `constacc` and `cameas`, $[x \ v_x \ a_x \ y \ v_y \ a_y \ z \ v_z \ a_z]$.

Examples

Initialize 3-D Constant-Acceleration Extended Kalman Filter

Create and initialize a 3-D constant-acceleration extended Kalman filter object from an initial detection report.

Create the detection report from an initial 3-D measurement, $(-200;30;0)$, of the object position. Assume uncorrelated measurement noise.

```
detection = objectDetection(0,[-200;-30;0], 'MeasurementNoise', 2.1*eye(3), ...
    'SensorIndex', 1, 'ObjectClassID', 1, 'ObjectAttributes', {'Car', 2});
```

Create the new filter from the detection report and display its properties.

```
filter = initcaekf(detection)

filter =
    trackingEKF with properties:

        State: [9x1 double]
        StateCovariance: [9x9 double]

        StateTransitionFcn: @constacc
        StateTransitionJacobianFcn: @constaccjac
        ProcessNoise: [3x3 double]
        HasAdditiveProcessNoise: 0

        MeasurementFcn: @cameas
        MeasurementJacobianFcn: @cameasjac
        HasMeasurementWrapping: 1
        MeasurementNoise: [3x3 double]
        HasAdditiveMeasurementNoise: 1

        MaxNumOOSMSteps: 0
```

```
EnableSmoothing: 0
```

Show the filter state.

```
filter.State
```

```
ans = 9×1
```

```
-200
  0
  0
 -30
  0
  0
  0
  0
  0
```

Show the state covariance matrix.

```
filter.StateCovariance
```

```
ans = 9×9
```

```
 2.1000    0    0    0    0    0    0    0    0
    0 100.0000    0    0    0    0    0    0    0
    0    0 100.0000    0    0    0    0    0    0
    0    0    0  2.1000    0    0    0    0    0
    0    0    0    0 100.0000    0    0    0    0
    0    0    0    0    0 100.0000    0    0    0
    0    0    0    0    0    0  2.1000    0    0
    0    0    0    0    0    0    0 100.0000    0
    0    0    0    0    0    0    0    0 100.0000
```

Create 3D Constant Acceleration EKF from Spherical Measurement

Initialize a 3D constant-acceleration extended Kalman filter from an initial detection report made from an initial measurement in spherical coordinates. If you want to use spherical coordinates, then you must supply a measurement parameter structure as part of the detection report with the `Frame` field set to `'spherical'`. Set the azimuth angle of the target to 45° , the elevation to 22° , the range to 1000 meters, and the range rate to -4.0 m/s.

```
frame = 'spherical';
sensorpos = [25,-40,-10].';
sensorvel = [0;5;0];
laxes = eye(3);
```

Create the measurement parameters structure. Set `'HasVelocity'` and `'HasElevation'` to true. Then, the measurement vector consists of azimuth, elevation, range, and range rate.

```
measparms = struct('Frame',frame,'OriginPosition',sensorpos, ...
    'OriginVelocity',sensorvel,'Orientation',laxes,'HasVelocity',true, ...
```

```

    'HasElevation',true);
meas = [45;22;1000;-4];
measnoise = diag([3.0,2.5,2,1.0].^2);
detection = objectDetection(0,meas,'MeasurementNoise', ...
    measnoise,'MeasurementParameters',measparms)

```

```

detection =
    objectDetection with properties:
        Time: 0
        Measurement: [4x1 double]
        MeasurementNoise: [4x4 double]
        SensorIndex: 1
        ObjectClassID: 0
        ObjectClassParameters: []
        MeasurementParameters: [1x1 struct]
        ObjectAttributes: {}

```

```
filter = initcaekf(detection);
```

Display the state vector.

```
disp(filter.State)
```

```

680.6180
-2.6225
0
615.6180
2.3775
0
364.6066
-1.4984
0

```

Input Arguments

detection — Detection report

objectDetection object

Detection report, specified as an objectDetection object.

Example: `detection = objectDetection(0,[1;4.5;3],'MeasurementNoise', [1.0 0 0; 0 2.0 0; 0 0 1.5])`

Output Arguments

filter — Extended Kalman filter

trackingEKF object

Extended Kalman filter, returned as a trackingEKF object.

Algorithms

- The function computes the process noise matrix assuming a one-second time step and an acceleration-rate standard deviation of 1 m/s³.

- You can use this function as the `FilterInitializationFcn` property of a `multiObjectTracker` object.

Version History

Introduced in R2017a

Extended Capabilities

C/C++ Code Generation

Generate C and C++ code using MATLAB® Coder™.

See Also

Functions

`initctekf` | `initctukf` | `initcvkf` | `initcvekf` | `initcvukf` | `initcakf` | `initcaukf`

Objects

`objectDetection` | `trackingKF` | `trackingEKF` | `trackingUKF` | `multiObjectTracker`

initcakf

Create constant-acceleration linear Kalman filter from detection report

Syntax

```
filter = initcakf(detection)
```

Description

`filter = initcakf(detection)` creates and initializes a constant-acceleration linear Kalman filter from information contained in a `detection` report. For more information about the linear Kalman filter, see `trackingKF`.

The function initializes a constant acceleration state with the same convention as `constacc` and `cameas`, $[x \ v_x \ a_x \ y \ v_y \ a_y \ z \ v_z \ a_z]$.

Examples

Initialize 2-D Constant-Acceleration Linear Kalman Filter

Create and initialize a 2-D constant-acceleration linear Kalman filter object from an initial detection report.

Create the detection report from an initial 2-D measurement, (10,-5), of the object position. Assume uncorrelated measurement noise.

```
detection = objectDetection(0,[10;-5],'MeasurementNoise',eye(2), ...
    'SensorIndex',1,'ObjectClassID',1,'ObjectAttributes',{'Car',5});
```

Create the new filter from the detection report.

```
filter = initcakf(detection);
```

Show the filter state.

```
filter.State
```

```
ans = 6×1
```

```
    10
     0
     0
    -5
     0
     0
```

Show the state transition model.

```
filter.StateTransitionModel
```

```
ans = 6×6
    1.0000    1.0000    0.5000         0         0         0
         0    1.0000    1.0000         0         0         0
         0         0    1.0000         0         0         0
         0         0         0    1.0000    1.0000    0.5000
         0         0         0         0    1.0000    1.0000
         0         0         0         0         0    1.0000
```

Input Arguments

detection — Detection report

objectDetection object

Detection report, specified as an objectDetection object.

Example: `detection = objectDetection(0,[1;4.5;3],'MeasurementNoise', [1.0 0 0; 0 2.0 0; 0 0 1.5])`

Output Arguments

filter — Linear Kalman filter

trackingKF object

Linear Kalman filter, returned as a trackingKF object.

Algorithms

- The function computes the process noise matrix assuming a one-second time step and an acceleration rate standard deviation of 1 m/s³.
- You can use this function as the `FilterInitializationFcn` property of a `multiObjectTracker` object.

Version History

Introduced in R2017a

Extended Capabilities

C/C++ Code Generation

Generate C and C++ code using MATLAB® Coder™.

See Also

Functions

`initcaekf` | `initcaukf` | `initctekf` | `initctukf` | `initcvkf` | `initcvekf` | `initcvukf`

Objects

`objectDetection` | `trackingKF` | `trackingEKF` | `trackingUKF` | `multiObjectTracker`

initcaukf

Create constant-acceleration unscented Kalman filter from detection report

Syntax

```
filter = initcaukf(detection)
```

Description

`filter = initcaukf(detection)` creates and initializes a constant-acceleration unscented Kalman filter from information contained in a `detection` report. For more information about the unscented Kalman filter, see `trackingUKF`.

The function initializes a constant acceleration state with the same convention as `constacc` and `cameas`, $[x \ v_x \ a_x \ y \ v_y \ a_y \ z \ v_z \ a_z]$.

Examples

Initialize 3-D Constant-Acceleration Unscented Kalman Filter

Create and initialize a 3-D constant-acceleration unscented Kalman filter object from an initial detection report.

Create the detection report from an initial 3-D measurement, (-200,-30,5), of the object position. Assume uncorrelated measurement noise.

```
detection = objectDetection(0,[-200;-30;5], 'MeasurementNoise', 2.0*eye(3), ...
    'SensorIndex', 1, 'ObjectClassID', 1, 'ObjectAttributes', {'Car', 2});
```

Create the new filter from the detection report and display the filter properties.

```
filter = initcaukf(detection)

filter =
    trackingUKF with properties:

        State: [9x1 double]
        StateCovariance: [9x9 double]

        StateTransitionFcn: @constacc
        ProcessNoise: [3x3 double]
        HasAdditiveProcessNoise: 0

        MeasurementFcn: @cameas
        HasMeasurementWrapping: 1
        MeasurementNoise: [3x3 double]
        HasAdditiveMeasurementNoise: 1

        Alpha: 1.0000e-03
        Beta: 2
        Kappa: 0
```

```
EnableSmoothing: 0
```

Show the state.

```
filter.State
```

```
ans = 9×1
```

```
-200
  0
  0
-30
  0
  0
  5
  0
  0
```

Show the state covariance matrix.

```
filter.StateCovariance
```

```
ans = 9×9
```

```
 2.0000    0    0    0    0    0    0    0    0
  0 100.0000    0    0    0    0    0    0    0
  0    0 100.0000    0    0    0    0    0    0
  0    0    0 2.0000    0    0    0    0    0
  0    0    0    0 100.0000    0    0    0    0
  0    0    0    0    0 100.0000    0    0    0
  0    0    0    0    0    0 2.0000    0    0
  0    0    0    0    0    0    0 100.0000    0
  0    0    0    0    0    0    0    0 100.0000
```

Create 3D Constant Acceleration UKF from Spherical Measurement

Initialize a 3D constant-acceleration unscented Kalman filter from an initial detection report made from a measurement in spherical coordinates. If you want to use spherical coordinates, then you must supply a measurement parameter structure as part of the detection report with the `Frame` field set to `'spherical'`. Set the azimuth angle of the target to 45° , and the range to 1000 meters.

```
frame = 'spherical';
sensorpos = [25,-40,-10].';
sensorvel = [0;5;0];
laxes = eye(3);
```

Create the measurement structure. Set `'HasVelocity'` and `'HasElevation'` to false. Then, the measurement vector consists of azimuth angle and range.

```
measparms = struct('Frame',frame,'OriginPosition',sensorpos, ...
    'OriginVelocity',sensorvel,'Orientation',laxes,'HasVelocity',false, ...
```

```

    'HasElevation',false);
meas = [45;1000];
measnoise = diag([3.0,2.0].^2);
detection = objectDetection(0,meas,'MeasurementNoise', ...
    measnoise,'MeasurementParameters',measparms)

```

```

detection =
    objectDetection with properties:

        Time: 0
        Measurement: [2x1 double]
        MeasurementNoise: [2x2 double]
        SensorIndex: 1
        ObjectClassID: 0
        ObjectClassParameters: []
        MeasurementParameters: [1x1 struct]
        ObjectAttributes: {}

```

```
filter = initcaukf(detection);
```

Display the state vector.

```
disp(filter.State)
```

```

732.1068
      0
      0
667.1068
      0
      0
-10.0000
      0
      0

```

Input Arguments

detection — Detection report

objectDetection object

Detection report, specified as an objectDetection object.

Example: `detection = objectDetection(0,[1;4.5;3],'MeasurementNoise', [1.0 0 0; 0 2.0 0; 0 0 1.5])`

Output Arguments

filter — Unscented Kalman filter

trackingUKF object

Unscented Kalman filter, returned as a trackingUKF object.

Algorithms

- The function computes the process noise matrix assuming a one-second time step and an acceleration rate standard deviation of 1 m/s³.

- You can use this function as the `FilterInitializationFcn` property of a `multiObjectTracker` object.

Version History

Introduced in R2017a

Extended Capabilities

C/C++ Code Generation

Generate C and C++ code using MATLAB® Coder™.

See Also

Functions

`initcakf` | `initcaekf` | `initctekf` | `initctukf` | `initcvkf` | `initcvekf` | `initcvukf`

Objects

`objectDetection` | `trackingKF` | `trackingEKF` | `trackingUKF` | `multiObjectTracker`

initctekf

Create constant turn-rate extended Kalman filter from detection report

Syntax

```
filter = initctekf(detection)
```

Description

`filter = initctekf(detection)` creates and initializes a constant-turn-rate extended Kalman filter from information contained in a `detection` report. For more information about the extended Kalman filter, see `trackingEKF`.

The function initializes a constant turn-rate state with the same convention as `constturn` and `ctmeas`, $[x \ v_x \ y \ v_y \ \omega \ z \ v_z]$, where ω is the turn-rate.

Examples

Initialize 2-D Constant Turn-Rate Extended Kalman Filter

Create and initialize a 2-D constant turn-rate extended Kalman filter object from an initial detection report.

Create the detection report from an initial 2-D measurement, (-250,-40), of the object position. Assume uncorrelated measurement noise.

Extend the measurement to three dimensions by adding a z-component of zero.

```
detection = objectDetection(0, [-250; -40; 0], 'MeasurementNoise', 2.0*eye(3), ...
    'SensorIndex', 1, 'ObjectClassID', 1, 'ObjectAttributes', {'Car', 2});
```

Create the new filter from the detection report and display the filter properties.

```
filter = initctekf(detection)

filter =
    trackingEKF with properties:

        State: [7x1 double]
        StateCovariance: [7x7 double]

        StateTransitionFcn: @constturn
        StateTransitionJacobianFcn: @constturnjac
        ProcessNoise: [4x4 double]
        HasAdditiveProcessNoise: 0

        MeasurementFcn: @ctmeas
        MeasurementJacobianFcn: @ctmeasjac
        HasMeasurementWrapping: 1
        MeasurementNoise: [3x3 double]
        HasAdditiveMeasurementNoise: 1
```

```
MaxNum00SMSteps: 0
```

```
EnableSmoothing: 0
```

Show the state.

```
filter.State
```

```
ans = 7×1
```

```
-250
  0
 -40
  0
  0
  0
  0
```

Show the state covariance matrix.

```
filter.StateCovariance
```

```
ans = 7×7
```

```
 2.0000    0    0    0    0    0    0
    0 100.0000    0    0    0    0    0
    0    0  2.0000    0    0    0    0
    0    0    0 100.0000    0    0    0
    0    0    0    0 100.0000    0    0
    0    0    0    0    0  2.0000    0
    0    0    0    0    0    0 100.0000
```

Create 2-D Constant Turnrate EKF from Spherical Measurement

Initialize a 2-D constant-turnrate extended Kalman filter from an initial detection report made from an initial measurement in spherical coordinates. If you want to use spherical coordinates, then you must supply a measurement parameter structure as part of the detection report with the `Frame` field set to `'spherical'`. Set the azimuth angle of the target to 45 degrees, the range to 1000 meters, and the range rate to -4.0 m/s.

```
frame = 'spherical';
sensorpos = [25,-40,-10].';
sensorvel = [0;5;0];
laxes = eye(3);
```

Create the measurement parameters structure. Set `'HasElevation'` to `false`. Then, the measurement consists of azimuth, range, and range rate.

```
measparms = struct('Frame',frame,'OriginPosition',sensorpos, ...
    'OriginVelocity',sensorvel,'Orientation',laxes,'HasVelocity',true, ...
    'HasElevation',false);
```



```
meas = [45;1000;-4];
measnoise = diag([3.0,2,1.0].^2);
detection = objectDetection(0,meas,'MeasurementNoise', ...
    measnoise,'MeasurementParameters',measparms)
```

```
detection =
    objectDetection with properties:
        Time: 0
        Measurement: [3x1 double]
        MeasurementNoise: [3x3 double]
        SensorIndex: 1
        ObjectClassID: 0
        ObjectClassParameters: []
        MeasurementParameters: [1x1 struct]
        ObjectAttributes: {}
```

```
filter = initctekf(detection);
```

Filter state vector.

```
disp(filter.State)
```

```
732.1068
-2.8284
667.1068
2.1716
0
-10.0000
0
```

Input Arguments

detection — Detection report

objectDetection object

Detection report, specified as an objectDetection object.

Example: `detection = objectDetection(0,[1;4.5;3],'MeasurementNoise', [1.0 0 0; 0 2.0 0; 0 0 1.5])`

Output Arguments

filter — Extended Kalman filter

trackingEKF object

Extended Kalman filter, returned as a trackingEKF object.

Algorithms

- The function computes the process noise matrix assuming a one-second time step. The function assumes an acceleration standard deviation of 1 m/s², and a turn-rate acceleration standard deviation of 1°/s².

- You can use this function as the `FilterInitializationFcn` property of a `multiObjectTracker` object.

Version History

Introduced in R2017a

Extended Capabilities

C/C++ Code Generation

Generate C and C++ code using MATLAB® Coder™.

See Also

Functions

`initcaukf` | `initctukf` | `initcvkf` | `initcvekf` | `initcvukf` | `initcakf` | `initcaekf`

Objects

`objectDetection` | `trackingKF` | `trackingEKF` | `trackingUKF` | `multiObjectTracker`

initctukf

Create constant turn-rate unscented Kalman filter from detection report

Syntax

```
filter = initctukf(detection)
```

Description

`filter = initctukf(detection)` creates and initializes a constant-turn-rate unscented Kalman filter from information contained in a `detection` report. For more information about the unscented Kalman filter, see `trackingUKF`.

The function initializes a constant turn-rate state with the same convention as `constturn` and `ctmeas`, $[x \ v_x \ y \ v_y \ \omega \ z \ v_z]$, where ω is the turn-rate.

Examples

Initialize 2-D Constant Turn-Rate Unscented Kalman Filter

Create and initialize a 2-D constant turn-rate unscented Kalman filter object from an initial detection report.

Create the detection report from an initial 2D measurement, (-250,-40), of the object position. Assume uncorrelated measurement noise.

Extend the measurement to three dimensions by adding a z-component of zero.

```
detection = objectDetection(0, [-250; -40; 0], 'MeasurementNoise', 2.0*eye(3), ...
    'SensorIndex', 1, 'ObjectClassID', 1, 'ObjectAttributes', {'Car', 2});
```

Create the new filter from the detection report and display the filter properties.

```
filter = initctukf(detection)

filter =
    trackingUKF with properties:

        State: [7x1 double]
        StateCovariance: [7x7 double]

        StateTransitionFcn: @constturn
        ProcessNoise: [4x4 double]
        HasAdditiveProcessNoise: 0

        MeasurementFcn: @ctmeas
        HasMeasurementWrapping: 1
        MeasurementNoise: [3x3 double]
        HasAdditiveMeasurementNoise: 1

        Alpha: 1.0000e-03
```

```

Beta: 2
Kappa: 0

EnableSmoothing: 0

```

Show the filter state.

```
filter.State
```

```
ans = 7×1
```

```

-250
  0
 -40
  0
  0
  0
  0

```

Show the state covariance matrix.

```
filter.StateCovariance
```

```
ans = 7×7
```

```

2.0000    0    0    0    0    0    0
  0 100.0000    0    0    0    0    0
  0    0 2.0000    0    0    0    0
  0    0    0 100.0000    0    0    0
  0    0    0    0 100.0000    0    0
  0    0    0    0    0 2.0000    0
  0    0    0    0    0    0 100.0000

```

Create 2-D Constant Turn-rate UKF from Spherical Measurement

Initialize a 2-D constant turn-rate extended Kalman filter from an initial detection report made from an initial measurement in spherical coordinates. If you want to use spherical coordinates, then you must supply a measurement parameter structure as part of the detection report with the `Frame` field set to `'spherical'`. Set the azimuth angle of the target to 45 degrees and the range to 1000 meters.

```

frame = 'spherical';
sensorpos = [25,-40,-10].';
sensorvel = [0;5;0];
laxes = eye(3);

```

Create the measurement parameters structure. Set `'HasVelocity'` and `'HasElevation'` to `false`. Then, the measurement consists of azimuth and range.

```

measparms = struct('Frame',frame,'OriginPosition',sensorpos, ...
    'OriginVelocity',sensorvel,'Orientation',laxes,'HasVelocity',false, ...
    'HasElevation',false);
meas = [45;1000];
measnoise = diag([3.0,2].^2);

```

```
detection = objectDetection(0,meas,'MeasurementNoise', ...
    measnoise,'MeasurementParameters',measparms)
```

```
detection =
    objectDetection with properties:
        Time: 0
        Measurement: [2x1 double]
        MeasurementNoise: [2x2 double]
        SensorIndex: 1
        ObjectClassID: 0
        ObjectClassParameters: []
        MeasurementParameters: [1x1 struct]
        ObjectAttributes: {}
```

```
filter = initctukf(detection);
```

Filter state vector.

```
disp(filter.State)
```

```
732.1068
      0
667.1068
      0
      0
-10.0000
      0
```

Input Arguments

detection — Detection report

objectDetection object

Detection report, specified as an objectDetection object.

Example: `detection = objectDetection(0,[1;4.5;3],'MeasurementNoise', [1.0 0 0; 0 2.0 0; 0 0 1.5])`

Output Arguments

filter — Unscented Kalman filter

trackingUKF object

Unscented Kalman filter, returned as a trackingUKF object.

Algorithms

- The function computes the process noise matrix assuming a one-second time step. The function assumes an acceleration standard deviation of 1 m/s², and a turn-rate acceleration standard deviation of 1°/s².
- You can use this function as the FilterInitializationFcn property of a multiObjectTracker object.

Version History

Introduced in R2017a

Extended Capabilities

C/C++ Code Generation

Generate C and C++ code using MATLAB® Coder™.

See Also

Functions

[initcaukf](#) | [initcvkf](#) | [initcvekf](#) | [initcvukf](#) | [initcakf](#) | [initcaekf](#)

Objects

[objectDetection](#) | [trackingKF](#) | [trackingEKF](#) | [trackingUKF](#) | [multiObjectTracker](#)

initcvekf

Create constant-velocity extended Kalman filter from detection report

Syntax

```
filter = initcvekf(detection)
```

Description

`filter = initcvekf(detection)` creates and initializes a constant-velocity extended Kalman filter from information contained in a `detection` report. For more information about the extended Kalman filter, see `trackingEKF`.

The function initializes a constant velocity state with the same convention as `constvel` and `cvmeas`, $[x \ v_x \ y \ v_y \ z \ v_z]$.

Examples

Initialize 3-D Constant-Velocity Extended Kalman Filter

Create and initialize a 3-D constant-velocity extended Kalman filter object from an initial detection report.

Create the detection report from an initial 3-D measurement, (10,20,-5), of the object position.

```
detection = objectDetection(0,[10;20;-5], 'MeasurementNoise',1.5*eye(3), ...
    'SensorIndex',1, 'ObjectClassID',1, 'ObjectAttributes',{'Sports Car',5});
```

Create the new filter from the detection report.

```
filter = initcvekf(detection)
```

```
filter =
    trackingEKF with properties:
        State: [6x1 double]
        StateCovariance: [6x6 double]
        StateTransitionFcn: @constvel
        StateTransitionJacobianFcn: @constveljac
        ProcessNoise: [3x3 double]
        HasAdditiveProcessNoise: 0
        MeasurementFcn: @cvmeas
        MeasurementJacobianFcn: @cvmeasjac
        HasMeasurementWrapping: 1
        MeasurementNoise: [3x3 double]
        HasAdditiveMeasurementNoise: 1
        MaxNumOOSMSteps: 0
```

```
EnableSmoothing: 0
```

Show the filter state.

```
filter.State
```

```
ans = 6×1
```

```
10
 0
20
 0
-5
 0
```

Show the state covariance.

```
filter.StateCovariance
```

```
ans = 6×6
```

```
1.5000    0    0    0    0    0
 0 100.0000    0    0    0    0
 0    0 1.5000    0    0    0
 0    0    0 100.0000    0    0
 0    0    0    0 1.5000    0
 0    0    0    0    0 100.0000
```

Create 3-D Constant Velocity EKF from Spherical Measurement

Initialize a 3-D constant-velocity extended Kalman filter from an initial detection report made from a 3-D measurement in spherical coordinates. If you want to use spherical coordinates, then you must supply a measurement parameter structure as part of the detection report with the `Frame` field set to `'spherical'`. Set the azimuth angle of the target to 45 degrees, the elevation to -10 degrees, the range to 1000 meters, and the range rate to -4.0 m/s.

```
frame = 'spherical';
sensorpos = [25,-40,0].';
sensorvel = [0;5;0];
laxes = eye(3);
measparms = struct('Frame',frame,'OriginPosition',sensorpos, ...
    'OriginVelocity',sensorvel,'Orientation',laxes,'HasVelocity',true, ...
    'HasElevation',true);
meas = [45;-10;1000;-4];
measnoise = diag([3.0,2.5,2,1.0].^2);
detection = objectDetection(0,meas,'MeasurementNoise', ...
    measnoise,'MeasurementParameters',measparms)
```

```
detection =
    objectDetection with properties:
        Time: 0
        Measurement: [4x1 double]
```



```

    MeasurementNoise: [4x4 double]
        SensorIndex: 1
        ObjectClassID: 0
    ObjectClassParameters: []
    MeasurementParameters: [1x1 struct]
    ObjectAttributes: {}

```

```
filter = initcvekf(detection);
```

Filter state vector.

```
disp(filter.State)
```

```

    721.3642
    -2.7855
    656.3642
     2.2145
   -173.6482
     0.6946

```

Input Arguments

detection — Detection report

objectDetection object

Detection report, specified as an objectDetection object.

Example: `detection = objectDetection(0,[1;4.5;3],'MeasurementNoise', [1.0 0 0; 0 2.0 0; 0 0 1.5])`

Output Arguments

filter — Extended Kalman filter

trackingEKF object

Extended Kalman filter, returned as a trackingEKF object.

Algorithms

- The function computes the process noise matrix assuming a one-second time step and an acceleration standard deviation of 1 m/s².
- You can use this function as the FilterInitializationFcn property of a multiObjectTracker object.

Version History

Introduced in R2017a

Extended Capabilities

C/C++ Code Generation

Generate C and C++ code using MATLAB® Coder™.

See Also

Functions

[initcaukf](#) | [initctekf](#) | [initctukf](#) | [initcvkf](#) | [initcvukf](#) | [initcakf](#) | [initcaekf](#)

Objects

[objectDetection](#) | [trackingKF](#) | [trackingEKF](#) | [trackingUKF](#) | [multiObjectTracker](#)

initcvkf

Create constant-velocity linear Kalman filter from detection report

Syntax

```
filter = initcvkf(detection)
```

Description

`filter = initcvkf(detection)` creates and initializes a constant-velocity linear Kalman filter from information contained in a `detection` report. For more information about the linear Kalman filter, see `trackingKF`.

The function initializes a constant velocity state with the same convention as `constvel` and `cvmeas`, $[x \ v_x \ y \ v_y \ z \ v_z]$.

Examples

Initialize 2-D Constant-Velocity Linear Kalman Filter

Create and initialize a 2-D linear Kalman filter object from an initial detection report.

Create the detection report from an initial 2-D measurement, (10,20), of the object position.

```
detection = objectDetection(0,[10;20], 'MeasurementNoise',[1 0.2; 0.2 2], ...
    'SensorIndex',1, 'ObjectClassID',1, 'ObjectAttributes',{'Yellow Car',5});
```

Create the new track from the detection report.

```
filter = initcvkf(detection)
```

```
filter =
```

```
trackingKF with properties:
```

```
    State: [4x1 double]
StateCovariance: [4x4 double]
```

```
    MotionModel: '2D Constant Velocity'
    ProcessNoise: [2x2 double]
```

```
    MeasurementModel: [2x4 double]
    MeasurementNoise: [2x2 double]
```

```
    MaxNumOOSMSteps: 0
```

```
    EnableSmoothing: 0
```

Show the state.

```
filter.State
```

```
ans = 4x1
    10
     0
    20
     0
```

Show the state transition model.

```
filter.StateTransitionModel
```

```
ans = 4x4
     1     1     0     0
     0     1     0     0
     0     0     1     1
     0     0     0     1
```

Initialize 3-D Constant-Velocity Linear Kalman Filter

Create and initialize a 3-D linear Kalman filter object from an initial detection report.

Create the detection report from an initial 3-D measurement, (10,20,-5), of the object position.

```
detection = objectDetection(0,[10;20;-5], 'MeasurementNoise', eye(3), ...
    'SensorIndex', 1, 'ObjectClassID', 1, 'ObjectAttributes', {'Green Car', 5});
```

Create the new filter from the detection report and display its properties.

```
filter = initcvkf(detection)

filter =
    trackingKF with properties:
        State: [6x1 double]
        StateCovariance: [6x6 double]
        MotionModel: '3D Constant Velocity'
        ProcessNoise: [3x3 double]
        MeasurementModel: [3x6 double]
        MeasurementNoise: [3x3 double]
        MaxNumOOSMSteps: 0
        EnableSmoothing: 0
```

Show the state.

```
filter.State
```

```
ans = 6x1
```

```

10
0
20
0
-5
0

```

Show the state transition model.

```
filter.StateTransitionModel
```

```
ans = 6×6
```

```

1     1     0     0     0     0
0     1     0     0     0     0
0     0     1     1     0     0
0     0     0     1     0     0
0     0     0     0     1     1
0     0     0     0     0     1

```

Input Arguments

detection — Detection report

objectDetection object

Detection report, specified as an objectDetection object.

Example: `detection = objectDetection(0,[1;4.5;3],'MeasurementNoise', [1.0 0 0; 0 2.0 0; 0 0 1.5])`

Output Arguments

filter — Linear Kalman filter

trackingKF object

Linear Kalman filter, returned as a trackingKF object.

Algorithms

- The function computes the process noise matrix assuming a one-second time step and an acceleration standard deviation of 1 m/s².
- You can use this function as the `FilterInitializationFcn` property of a `multiObjectTracker` object.

Version History

Introduced in R2017a

Extended Capabilities

C/C++ Code Generation

Generate C and C++ code using MATLAB® Coder™.

See Also

Functions

[initcakf](#) | [initcaekf](#) | [initcaukf](#) | [initctekf](#) | [initctukf](#) | [initcvekf](#) | [initcvukf](#)

Objects

[objectDetection](#) | [trackingKF](#) | [trackingEKF](#) | [trackingUKF](#) | [multiObjectTracker](#)

initcvukf

Create constant-velocity unscented Kalman filter from detection report

Syntax

```
filter = initcvukf(detection)
```

Description

`filter = initcvukf(detection)` creates and initializes a constant-velocity unscented Kalman filter from information contained in a `detection` report. For more information about the unscented Kalman filter, see `trackingUKF`.

The function initializes a constant velocity state with the same convention as `constvel` and `cvmeas`, $[x \ v_x \ y \ v_y \ z \ v_z]$.

Examples

Initialize 3-D Constant-Velocity Unscented Kalman Filter

Create and initialize a 3-D constant-velocity unscented Kalman filter object from an initial detection report.

Create the detection report from an initial 3-D measurement, (10,200,-5), of the object position.

```
detection = objectDetection(0,[10;200;-5], 'MeasurementNoise',1.5*eye(3), ...
    'SensorIndex',1, 'ObjectClassID',1, 'ObjectAttributes',{'Sports Car',5});
```

Create the new filter from the detection report and display the filter properties.

```
filter = initcvukf(detection)

filter =
    trackingUKF with properties:

        State: [6x1 double]
        StateCovariance: [6x6 double]

        StateTransitionFcn: @constvel
        ProcessNoise: [3x3 double]
        HasAdditiveProcessNoise: 0

        MeasurementFcn: @cvmeas
        HasMeasurementWrapping: 1
        MeasurementNoise: [3x3 double]
        HasAdditiveMeasurementNoise: 1

        Alpha: 1.0000e-03
        Beta: 2
        Kappa: 0
```

```
EnableSmoothing: 0
```

Display the state.

```
filter.State
```

```
ans = 6×1
```

```
10
0
200
0
-5
0
```

Show the state covariance.

```
filter.StateCovariance
```

```
ans = 6×6
```

```
1.5000    0    0    0    0    0
0 100.0000    0    0    0    0
0    0 1.5000    0    0    0
0    0    0 100.0000    0    0
0    0    0    0 1.5000    0
0    0    0    0    0 100.0000
```

Create Constant Velocity UKF from Spherical Measurement

Initialize a constant-velocity unscented Kalman filter from an initial detection report made from an initial measurement in spherical coordinates. Because the object lies in the x-y plane, no elevation measurement is made. If you want to use spherical coordinates, then you must supply a measurement parameter structure as part of the detection report with the `Frame` field set to `'spherical'`. Set the azimuth angle of the target to 45 degrees, the range to 1000 meters, and the range rate to -4.0 m/s.

```
frame = 'spherical';
sensorpos = [25,-40,0].';
sensorvel = [0;5;0];
laxes = eye(3);
```

Create the measurement parameters structure. Set `'HasElevation'` to `false`. Then, the measurement consists of azimuth, range, and range rate.

```
measparms = struct('Frame',frame,'OriginPosition',sensorpos, ...
    'OriginVelocity',sensorvel,'Orientation',laxes,'HasVelocity',true, ...
    'HasElevation',false);
meas = [45;1000;-4];
measnoise = diag([3.0,2,1.0].^2);
detection = objectDetection(0,meas,'MeasurementNoise', ...
    measnoise,'MeasurementParameters',measparms)
```

```
detection =
    objectDetection with properties:
```



```

        Time: 0
        Measurement: [3x1 double]
        MeasurementNoise: [3x3 double]
        SensorIndex: 1
        ObjectClassID: 0
        ObjectClassParameters: []
        MeasurementParameters: [1x1 struct]
        ObjectAttributes: {}

```

```
filter = initcvukf(detection);
```

Display filter state vector.

```
disp(filter.State)
```

```

732.1068
-2.8284
667.1068
 2.1716
      0
      0

```

Input Arguments

detection – Detection report

objectDetection object

Detection report, specified as an objectDetection object.

Example: `detection = objectDetection(0,[1;4.5;3],'MeasurementNoise', [1.0 0 0; 0 2.0 0; 0 0 1.5])`

Output Arguments

filter – Unscented Kalman filter

trackingUKF object

Unscented Kalman filter, returned as a trackingUKF object.

Algorithms

- The function computes the process noise matrix assuming a one-second time step and an acceleration standard deviation of 1 m/s².
- You can use this function as the `FilterInitializationFcn` property of a `multiObjectTracker` object.

Version History

Introduced in R2017a

Extended Capabilities

C/C++ Code Generation

Generate C and C++ code using MATLAB® Coder™.

See Also

Functions

[initcakf](#) | [initcaekf](#) | [initcaukf](#) | [initctekf](#) | [initctukf](#) | [initcvkf](#) | [initcvekf](#)

Objects

[objectDetection](#) | [trackingKF](#) | [trackingEKF](#) | [trackingUKF](#) | [multiObjectTracker](#)

insertLaneBoundary

Insert lane boundary into image

Syntax

```
rgb = insertLaneBoundary(I, boundaries, sensor, xVehicle)
rgb = insertLaneBoundary( ____, Name, Value)
```

Description

`rgb = insertLaneBoundary(I, boundaries, sensor, xVehicle)` inserts lane boundary markings into a truecolor image. The lanes are overlaid on the input road image, `I`. This image comes from the sensor specified in the `sensor` object. `xVehicle` specifies the `x`-coordinates at which to draw the lane markers. The `y`-coordinates are calculated based on the parameters of the boundary models in `boundaries`.

`rgb = insertLaneBoundary(____, Name, Value)` inserts lane boundary markings with additional options specified by one or more `Name, Value` pair arguments, using the previous input arguments.

Examples

Find Parabolic Lane Boundaries in Bird's-Eye-View Image

Find lanes in an image by using parabolic lane boundary models. Overlay the identified lanes on the original image and on a bird's-eye-view transformation of the image.

Load an image of a road with lanes. The image was obtained from a camera sensor mounted on the front of a vehicle.

```
I = imread('road.png');
```

Transform the image into a bird's-eye-view image by using a preconfigured sensor object. This object models the sensor that captured the original image.

```
bevSensor = load('birdsEyeConfig');
birdsEyeImage = transformImage(bevSensor.birdsEyeConfig, I);
imshow(birdsEyeImage)
```



Set the approximate lane marker width in world units (meters).

```
approxBoundaryWidth = 0.25;
```

Detect lane features and display them as a black-and-white image.

```
birdsEyeBW = segmentLaneMarkerRidge(im2gray(birdsEyeImage), ...  
    bevSensor.birdsEyeConfig,approxBoundaryWidth);  
imshow(birdsEyeBW)
```

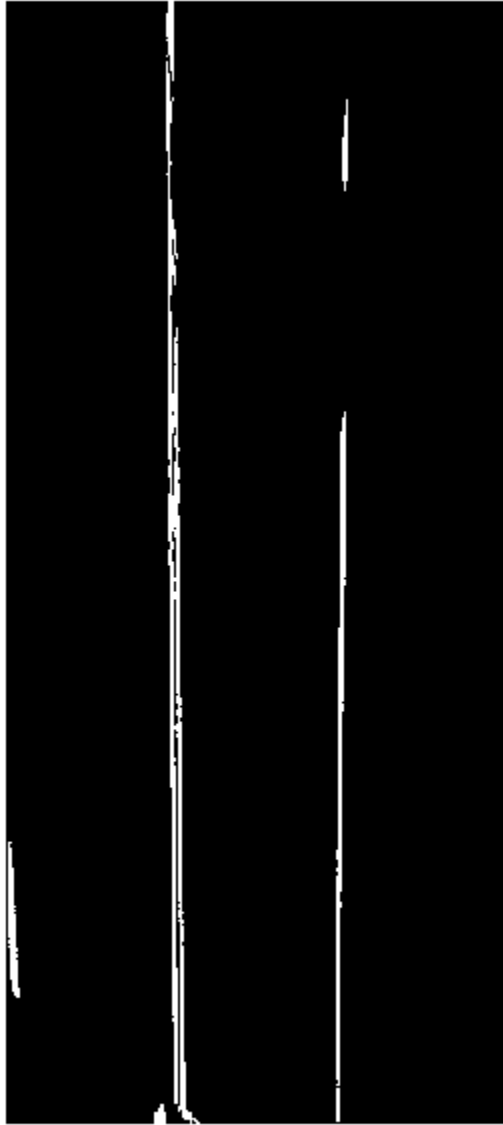

Obtain the image coordinates corresponding to the lane candidate positions. The `find` function returns pixel indices that correspond to the candidate lane positions. By convention, the order of the image coordinates is always reversed relative to the pixel indices. For more information about image coordinates, see “Coordinate Systems”.

Obtain the corresponding lane boundary points in vehicle coordinates by using the `imageToVehicle` function.

```
[imageY,imageX] = find(birdsEyeBW);  
xyBoundaryPoints = imageToVehicle(bevSensor.birdsEyeConfig,[imageX,imageY]);
```

Find lane boundaries in the image by using the `findParabolicLaneBoundaries` function. By default, the function returns a maximum of two lane boundaries. The boundaries are stored in an array of `parabolicLaneBoundary` objects.

```
boundaries = findParabolicLaneBoundaries(xyBoundaryPoints, approxBoundaryWidth);
```

Use `insertLaneBoundary` to overlay the lanes on the original image. The `XPoints` vector represents the lane points, in meters, that are within range of the ego vehicle's sensor. Specify the lanes in different colors. By default, lanes are yellow.

```
XPoints = 3:30;
```

```
figure  
sensor = bevSensor.birdsEyeConfig.Sensor;  
lanesI = insertLaneBoundary(I, boundaries(1), sensor, XPoints);  
lanesI = insertLaneBoundary(lanesI, boundaries(2), sensor, XPoints, 'Color', 'green');  
imshow(lanesI)
```



View the lanes in the bird's-eye-view image.

```
figure  
BEconfig = bevSensor.birdsEyeConfig;  
lanesBEI = insertLaneBoundary(birdsEyeImage, boundaries(1), BEconfig, XPoints);
```

```
lanesBEI = insertLaneBoundary(lanesBEI, boundaries(2), BEconfig, XPoints, 'Color', 'green');  
imshow(lanesBEI)
```

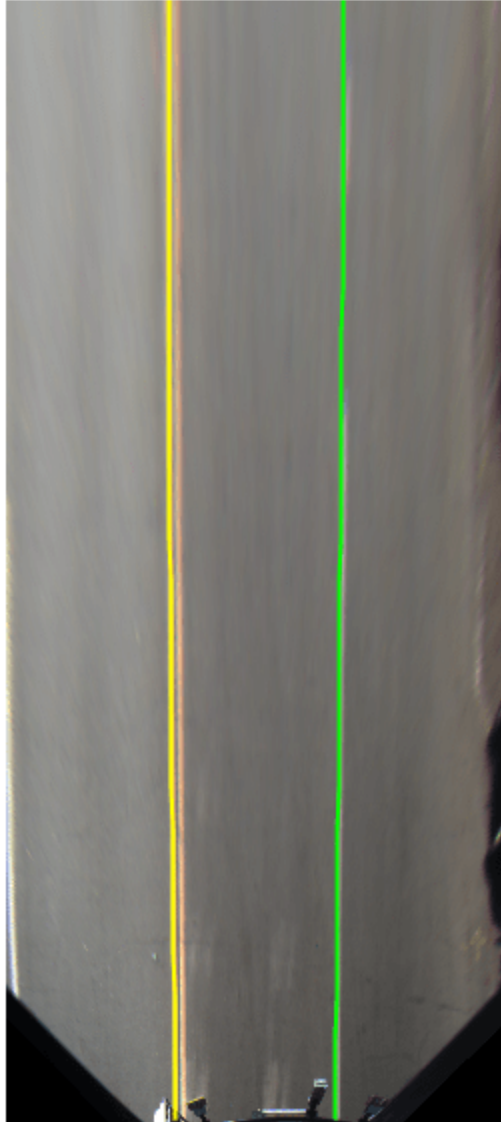

Input Arguments

I — Input road image

truecolor image | grayscale image

Input road image, specified as a truecolor or grayscale image.

Data Types: single | double | int8 | int16 | uint8 | uint16

boundaries — Lane boundary modelsarray of `parabolicLaneBoundary` objects | array of `cubicLaneBoundary` objects

Lane boundary models, specified as an array of `parabolicLaneBoundary` objects or `cubicLaneBoundary` objects. Lane boundary models contain the following properties:

- **Parameters** — A vector corresponding to the coefficients of the boundary model. The size of the vector depends on the degree of polynomial for the model.

Lane Boundary Object	Parameters
<code>parabolicLaneBoundary</code>	[A B C], corresponding to coefficients of a second-degree polynomial equation of the form $y = Ax^2 + Bx + C$
<code>cubicLaneBoundary</code>	[A B C D], corresponding to coefficients of a third-degree polynomial equation of the form $y = Ax^3 + Bx^2 + Cx + D$

- **BoundaryType** — A `LaneBoundaryType` enumeration of supported lane boundaries:
 - `Unmarked`
 - `Solid`
 - `Dashed`
 - `BottsDots`
 - `DoubleSolid`

Specify a lane boundary type as `LaneBoundaryType.BoundaryType`. For example:

```
LaneBoundaryType.BottsDots
```

- **Strength** — The ratio of the number of unique x-axis locations on the boundary to the total number of points along the line based on the `XExtent` property.
- **XExtent** — A two-element vector describing the minimum and maximum x-axis locations for the boundary points.

sensor — Sensor that collects images`birdsEyeView` object | `monoCamera` object

Sensor that collects images, specified as either a `birdsEyeView` or `monoCamera` object.

xVehicle — x-axis locations of boundary

real-valued vector

x-axis locations at which to display the lane boundaries, specified as a real-valued vector in vehicle coordinates. The spacing between points controls the spacing between dashes and dots for the corresponding types of boundaries. To show dashed boundaries clearly, specify at least four points in `xVehicle`. If you specify fewer than four points, the function draws a solid boundary.

Name-Value Pair Arguments

Specify optional pairs of arguments as `Name1=Value1, ..., NameN=ValueN`, where `Name` is the argument name and `Value` is the corresponding value. Name-value arguments must appear after other arguments, but the order of the pairs does not matter.

Before R2021a, use commas to separate each name and value, and enclose Name in quotes.

Example: 'Color',[0 1 0]

Color — Color of lane boundaries

'yellow' (default) | character vector | string scalar | [R,G,B] vector of RGB values | cell array of character vectors | string array | m -by-3 matrix of RGB values

Color of lane boundaries, specified as a character vector, string scalar, or [R,G,B] vector of RGB values. You can specify specific colors for each boundary in `boundaries` with a cell array of character vectors, a string array, or an m -by-3 matrix of RGB values. The colors correspond to the order of the boundary lanes.

RGB values must be in the range of the image data type.

Supported color values are 'blue', 'green', 'red', 'cyan', 'magenta', 'yellow', 'black', and 'white'.

Example: 'red'

Example: [1,0,0]

LineWidth — Line width for boundary lanes

3 (default) | positive integer

Line width for boundary lanes, specified as a positive integer in pixels.

Output Arguments

rgb — Image with boundary lanes

RGB truecolor image

Image with boundary lanes overlaid, returned as an RGB truecolor image. The output image class matches the input image, `I`.

Version History

Introduced in R2017a

Extended Capabilities

C/C++ Code Generation

Generate C and C++ code using MATLAB® Coder™.

See Also

`parabolicLaneBoundary` | `cubicLaneBoundary` | `fitPolynomialRANSAC` | `monoCamera` | `birdsEyeView`

lateralControllerStanley

Compute steering angle command for path following by using Stanley method

Syntax

```
steerCmd = lateralControllerStanley(refPose,currPose,currVelocity)
steerCmd = lateralControllerStanley(refPose,currPose,currVelocity,Name,Value)
```

Description

`steerCmd = lateralControllerStanley(refPose,currPose,currVelocity)` computes the steering angle command, in degrees, that adjusts the current pose of a vehicle to match a reference pose, given the current velocity of the vehicle. By default, the function assumes that the vehicle is in forward motion.

The controller computes the steering angle command using the Stanley method [1], whose control law is based on a kinematic bicycle model. Use this controller for path following in low-speed environments, where inertial effects are minimal.

`steerCmd = lateralControllerStanley(refPose,currPose,currVelocity,Name,Value)` specifies options using one or more name-value pairs. For example, `lateralControllerStanley(refPose,currPose,currVelocity,'Direction',-1)` computes the steering angle command for a vehicle in reverse motion.

Examples

Steering Angle Command for Vehicle in Forward Motion

Compute the steering angle command that adjusts the current pose of a vehicle to a reference pose along a driving path. The vehicle is in forward motion.

In this example, you compute a single steering angle command. In path-following algorithms, compute the steering angle continuously as the pose and velocity of the vehicle change.

Set a reference pose on the path. The pose is at position (4.8 m, 6.5 m) and has an orientation angle of 2 degrees.

```
refPose = [4.8, 6.5, 2]; % [meters, meters, degrees]
```

Set the current pose of the vehicle. The pose is at position (2 m, 6.5 m) and has an orientation angle of 0 degrees. Set the current velocity of the vehicle to 2 meters per second.

```
currPose = [2, 6.5, 0]; % [meters, meters, degrees]
currVelocity = 2; % meters per second
```

Compute the steering angle command. For the vehicle to match the reference pose, the steering wheel must turn 2 degrees counterclockwise.

```
steerCmd = lateralControllerStanley(refPose,currPose,currVelocity)
```

```
steerCmd = 2.0000
```

Steering Angle Command for Vehicle in Reverse Motion

Compute the steering angle command that adjusts the current pose of a vehicle to a reference pose along a driving path. The vehicle is in reverse motion.

In this example, you compute a single steering angle command. In path-following algorithms, compute the steering angle continuously as the pose and velocity of the vehicle change.

Set a reference pose on the path. The pose is at position (5 m, 9 m) and has an orientation angle of 90 degrees.

```
refPose = [5, 9, 90]; % [meters, meters, degrees]
```

Set the current pose of the vehicle. The pose is at position (5 m, 10 m) and has an orientation angle of 75 degrees.

```
currPose = [5, 10, 75]; % [meters, meters, degrees]
```

Set the current velocity of the vehicle to -2 meters per second. Because the vehicle is in reverse motion, the velocity must be negative.

```
currVelocity = -2; % meters per second
```

Compute the steering angle command. For the vehicle to match the reference pose, the steering wheel must turn 15 degrees clockwise.

```
steerCmd = lateralControllerStanley(refPose,currPose,currVelocity,'Direction',-1)
```

```
steerCmd = -15.0000
```

Input Arguments

refPose — Reference pose

[x, y, θ] vector

Reference pose, specified as an [x, y, θ] vector. x and y are in meters, and θ is in degrees.

x and y specify the reference point to steer the vehicle toward. θ specifies the orientation angle of the path at this reference point and is positive in the counterclockwise direction.

- For a vehicle in forward motion, the reference point is the point on the path that is closest to the center of the vehicle's front axle.

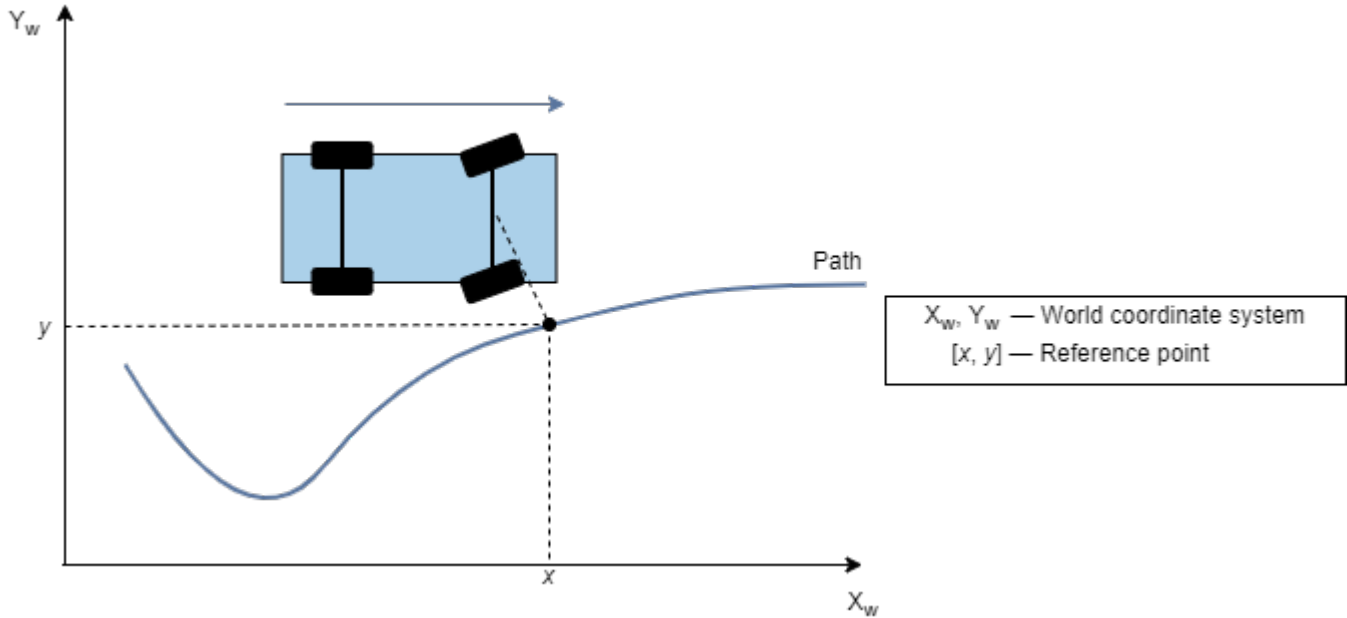

- For a vehicle in reverse motion, the reference point is the point on the path that is closest to the center of the vehicle's rear axle.

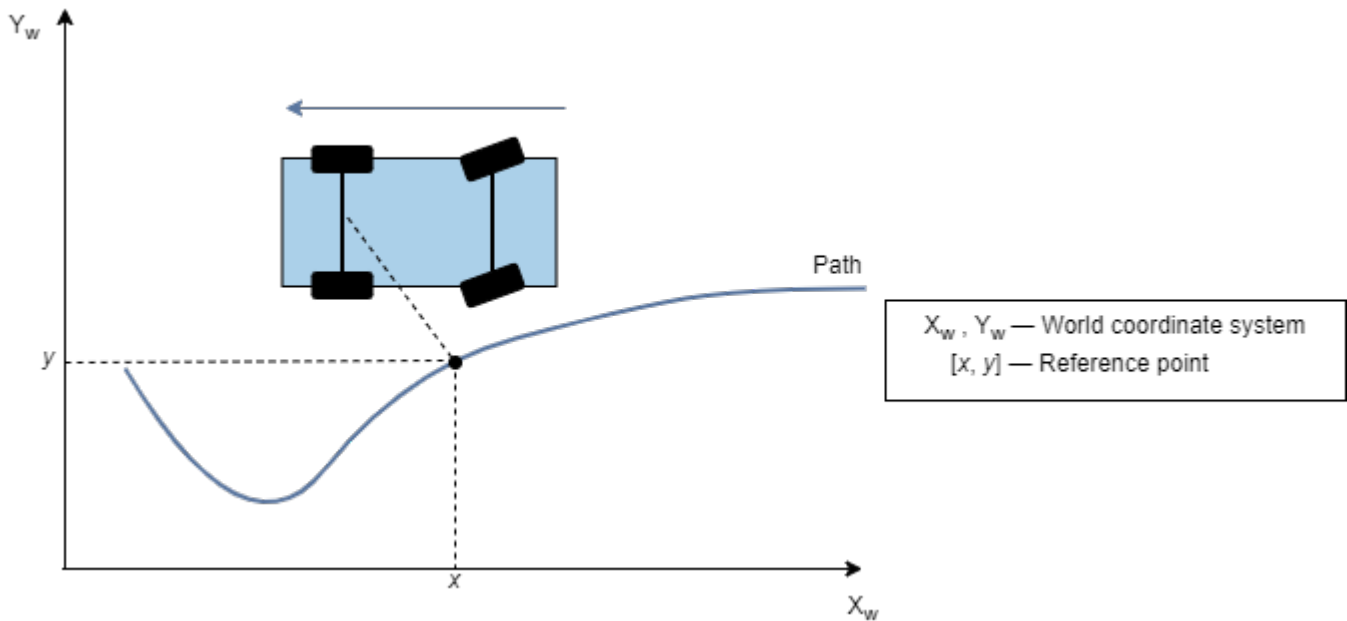

Data Types: single | double

currPose — Current pose

$[x, y, \theta]$ vector

Current pose of the vehicle, specified as an $[x, y, \theta]$ vector. x and y are in meters, and θ is in degrees.

x and y specify the location of the vehicle, which is defined as the center of the vehicle's rear axle.

θ specifies the orientation angle of the vehicle at location (x,y) and is positive in the counterclockwise direction.

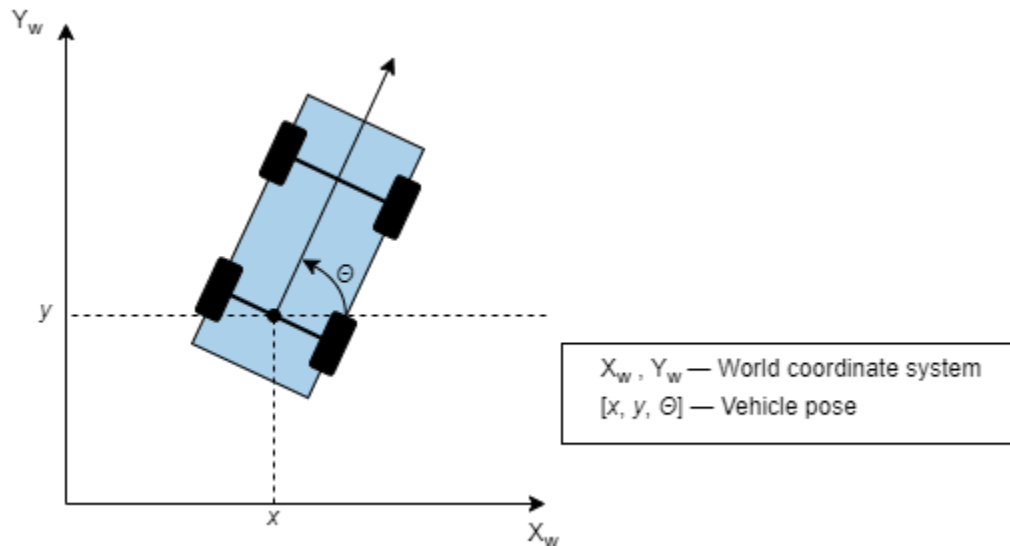

For more details on vehicle pose, see “Coordinate Systems in Automated Driving Toolbox”.

Data Types: `single` | `double`

currVelocity — Current longitudinal velocity

real scalar

Current longitudinal velocity of the vehicle, specified as a real scalar. Units are in meters per second.

- If the vehicle is in forward motion, then this value must be greater than 0.
- If the vehicle is in reverse motion, then this value must be less than 0.
- A value of 0 represents a vehicle that is not in motion.

Data Types: `single` | `double`

Name-Value Pair Arguments

Specify optional pairs of arguments as `Name1=Value1, ..., NameN=ValueN`, where `Name` is the argument name and `Value` is the corresponding value. Name-value arguments must appear after other arguments, but the order of the pairs does not matter.

Before R2021a, use commas to separate each name and value, and enclose Name in quotes.

Example: `'MaxSteeringAngle', 25`

Direction — Driving direction of vehicle

1 (forward motion) (default) | -1 (reverse motion)

Driving direction of the vehicle, specified as the comma-separated pair consisting of `'Direction'` and either 1 for forward motion or -1 for reverse motion. The driving direction determines the position error and angle error used to compute the steering angle command. For more details, see “Algorithms” on page 3-201.

PositionGain — Position gain

2.5 (default) | positive real scalar

Position gain of the vehicle, specified as the comma-separated pair consisting of 'PositionGain' and a positive real scalar. This value determines how much the position error affects the steering angle. Typical values are in the range [1, 5]. Increase this value to increase the magnitude of the steering angle.

Wheelbase — Distance between front and rear axles of vehicle

2.8 (default) | real scalar

Distance between the front and rear axles of the vehicle, in meters, specified as the comma-separated pair consisting of 'Wheelbase' and a real scalar. This value applies only when the vehicle is in forward motion.

MaxSteeringAngle — Maximum allowed steering angle

35 (default) | real scalar in the range (0, 180)

Maximum allowed steering angle of the vehicle, in degrees, specified as the comma-separated pair consisting of 'MaxSteeringAngle' and a real scalar in the range (0, 180).

The `steerCmd` value is saturated to the range $[-\text{MaxSteeringAngle}, \text{MaxSteeringAngle}]$.

- Values below $-\text{MaxSteeringAngle}$ are set to $-\text{MaxSteeringAngle}$.
- Values above MaxSteeringAngle are set to MaxSteeringAngle .

Output Arguments**steerCmd — Steering angle command**

real scalar

Steering angle command, in degrees, returned as a real scalar. This value is positive in the counterclockwise direction.

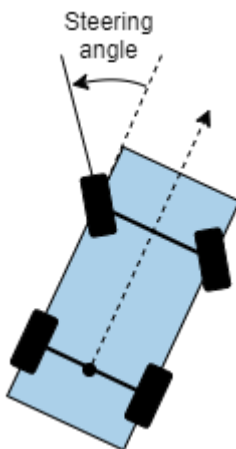

For more details, see “Coordinate Systems in Automated Driving Toolbox”.

Algorithms

To compute the steering angle command, the controller minimizes the position error and the angle error of the current pose with respect to the reference pose. The driving direction of the vehicle determines these error values.

When the vehicle is in forward motion ('Direction' name-value pair is 1):

- The position error is the lateral distance from the center of the front axle to the reference point on the path.
- The angle error is the angle of the front wheel with respect to reference path.

When the vehicle is in reverse motion ('Direction' name-value pair is -1):

- The position error is the lateral distance from the center of the rear axle to the reference point on the path.
- The angle error is the angle of the rear wheel with respect to reference path.

For details on how the controller minimizes these errors, see [1].

Version History

Introduced in R2018b

References

- [1] Hoffmann, Gabriel M., Claire J. Tomlin, Michael Montemerlo, and Sebastian Thrun. "Autonomous Automobile Trajectory Tracking for Off-Road Driving: Controller Design, Experimental Validation and Racing." *American Control Conference*. 2007, pp. 2296-2301. doi:10.1109/ACC.2007.4282788

Extended Capabilities

C/C++ Code Generation

Generate C and C++ code using MATLAB® Coder™.

See Also

Blocks

Lateral Controller Stanley | Longitudinal Controller Stanley

Objects

pathPlannerRRT

Topics

"Automated Parking Valet"

"Coordinate Systems in Automated Driving Toolbox"

publishActor

Package: Simulink.publish

Generate package for actor simulation

Syntax

```
Simulink.publish.publishActor(actorBehavior,Name,Value)  
Simulink.publish.publishActor(modelName,Name,Value)
```

Description

`Simulink.publish.publishActor(actorBehavior,Name,Value)` generates a package from the actor behavior specified by `actorBehavior` for actor simulation with additional options specified using one or more name-value arguments..

`Simulink.publish.publishActor(modelName,Name,Value)` generates a package from the model name specified by `modelName` for actor simulation with additional options specified using one or more name-value arguments..

Examples

Generate Package for Actor Simulation

Publish the model actor behavior as a package to use in actor simulation.

```
Simulink.publish.publishActor("mSimple",PackageType="actorRapid",...  
SetupScript="setup.m",OutputFile="output.zip")
```

Input Arguments

actorBehavior — Actor behavior

character vector | string

Actor behavior for MATLAB System object, specified as a character vector or string.

Example: "MySystemObjectBehavior.m"

Data Types: char | string

modelName — Simulink model name

character vector | string

Simulink model name, specified as a character vector or string.

Example: "mSimple"

Data Types: char | string

Name-Value Pair Arguments

Specify optional pairs of arguments as `Name1=Value1, . . . , NameN=ValueN`, where `Name` is the argument name and `Value` is the corresponding value. Name-value arguments must appear after other arguments, but the order of the pairs does not matter.

Before R2021a, use commas to separate each name and value, and enclose `Name` in quotes.

Example:

```
Simulink.publish.publishActor("mSimple",PackageType="actorRapid",SetupScript="setup.m",OutputFile="output.zip")
```

PackageType — Relation target mode

"actorNormal" (default) | "actorRapid"

Relation target mode the actor will use, specified as a `relationTarget` value "actorNormal" or "actorRapid".

Data Types: `string`

SetupScript — Setup script file

`string`

Setup script file to include in package, specified as a string of the file name.

Data Types: `string`

CleanupScript — Cleanup script file

`string`

Cleanup script file to include in package, specified as a string of the file name.

Data Types: `string`

OutputFile — Output file

`string`

Output file for package, specified as a string of the full file path with the ZIP extension.

Data Types: `string`

DataFiles — Data files

array of strings

Data files to attach, specified as an array of strings of data file names.

Data Types: `string`

Version History

Introduced in R2022a

See Also

`publishActorBehavior`

Topics

“Publish Actor Behavior as Proto File, Package, Action Asset or Event Asset”

publishActorBehavior

Package: Simulink.publish

Generate proto file for actor simulation

Syntax

```
Simulink.publish.publishActorBehavior(actorBehavior,Name,Value)  
Simulink.publish.publishActorBehavior(modelName,Name,Value)
```

Description

`Simulink.publish.publishActorBehavior(actorBehavior,Name,Value)` generates a proto file from the actor behavior specified by `actorBehavior` for actor simulation with additional options specified using one or more name-value arguments.

`Simulink.publish.publishActorBehavior(modelName,Name,Value)` generates a proto file from the model specified by `modelName` for actor simulation with additional options specified using one or more name-value arguments.

Examples

Generate Proto File for Actor Simulation

Publish the model actor behavior as a proto file to use in actor simulation.

```
Simulink.publish.publishActor("mSimple",OutputFile="output.slprotodata")
```

Input Arguments

actorBehavior — Actor behavior

character vector | string

Actor behavior for MATLAB System object, specified as a character vector or string.

Example: "MySystemObjectBehavior.m"

Data Types: char | string

modelName — Simulink model name

character vector | string

Simulink model name, specified as a character vector or string.

Example: "mSimple"

Data Types: char | string

Name-Value Pair Arguments

Specify optional pairs of arguments as `Name1=Value1, . . . , NameN=ValueN`, where `Name` is the argument name and `Value` is the corresponding value. Name-value arguments must appear after other arguments, but the order of the pairs does not matter.

Before R2021a, use commas to separate each name and value, and enclose `Name` in quotes.

Example:

```
Simulink.publish.publishActorBehavior("mSimple",OutputFile="output.slprotodata")
```

OutputFile – Output file

string

Output file for proto file, specified as a string of the full file path with or without the default `SLPROTODATA` extension.

Data Types: `string`

Version History

Introduced in R2022a

See Also

`publishActor`

Topics

“Publish Actor Behavior as Proto File, Package, Action Asset or Event Asset”

publishCustomAction

Generate asset file for user-defined action

Syntax

```
Simulink.publish.publishCustomAction(modelName)
```

Description

`Simulink.publish.publishCustomAction(modelName)` generates an action asset file for the Simulink actor behavior model `actorBehaviorModel` that handles a certain user-defined action.

Examples

Generate Action Asset File for Scenario Simulation

Publish Simulink actor behavior as an action asset file to use in a scenario simulation.

```
Simulink.publish.publishCustomAction("CustomDriveSimulinkModel");
```

Input Arguments

`modelName` — Simulink model name

character vector | string

Simulink model name, specified as a character vector or string.

Example: "mSimple"

Data Types: char | string

Version History

Introduced in R2022b

See Also

`publishCustomEvent`

publishCustomEvent

Generate asset file for user-defined event

Syntax

```
Simulink.publish.publishCustomEvent(modelName)
```

Description

`Simulink.publish.publishCustomEvent(modelName)` generates an event asset file for the Simulink actor behavior model `modelName` that reads or writes a certain user-defined event.

Examples

Generate Event Asset File for Scenario Simulation

Publish Simulink actor behavior as an event asset file to use in a scenario simulation.

```
Simulink.publish.publishCustomEvent("CustomEventOvertakeSimulinkModel");
```

Input Arguments

modelName — Simulink model name

character vector | string

Simulink model name, specified as a character vector or string.

Example: "mSimple"

Data Types: char | string

Version History

Introduced in R2023a

See Also

`publishCustomAction`

removeCustomBasemap

Remove custom basemap

Syntax

```
removeCustomBasemap(basemapName)
```

Description

`removeCustomBasemap(basemapName)` removes the custom basemap specified by `basemapName` from the list of available basemaps.

If the custom basemap specified by `basemapName` has not been previously added using the `addCustomBasemap` function, the `removeCustomBasemap` function returns an error.

Examples

Remove Custom Basemap

Add a custom basemap to view locations on an OpenStreetMap® basemap.

```
name = "openstreetmap";  
url = "a.tile.openstreetmap.org/{z}/{x}/{y}.png";  
copyright = char(uint8(169));  
attribution = copyright + "OpenStreetMap contributors";  
addCustomBasemap(name,url,"Attribution",attribution)
```

Use the custom basemap with a geographic player.

```
data = load("geoSequence.mat");  
player = geoplayer(data.latitude(1),data.longitude(1),"Basemap",name);  
plotRoute(player,data.latitude,data.longitude)
```

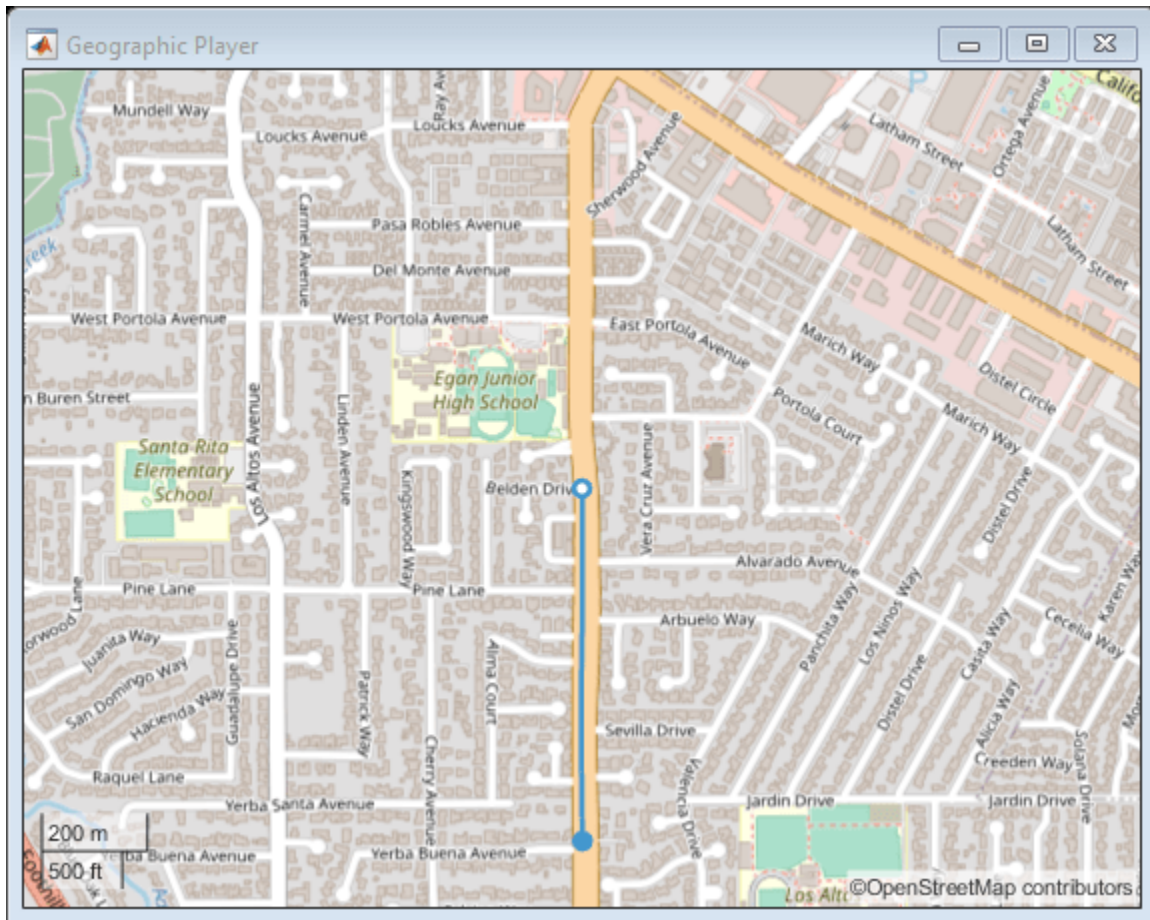

Remove the custom basemap. The custom basemap associated with the specified name remains stored in this geographic player. However, this basemap is no longer available for use with new players.

```
removeCustomBasemap(name)
```

Input Arguments

basemapName — Name of custom basemap

string scalar | character vector

Name of the custom basemap to remove, specified as a string scalar or character vector. You define the basemap name when you add the basemap using the `addCustomBasemap` function.

Data Types: string | char

Version History

Introduced in R2019a

See Also

[geoaxes](#) | [geobasemap](#) | [geobubble](#) | [geodensityplot](#) | [geoplot](#) | [geoscatter](#) | [addCustomBasemap](#) | [geoplayer](#)

segmentLaneMarkerRidge

Detect lanes in a grayscale intensity image

Syntax

```
birdsEyeBW = segmentLaneMarkerRidge(birdsEyeImage,birdsEyeConfig,  
approxMarkerWidth)  
birdsEyeBW = segmentLaneMarkerRidge( ____,Name,Value)
```

Description

`birdsEyeBW = segmentLaneMarkerRidge(birdsEyeImage,birdsEyeConfig,approxMarkerWidth)` returns a binary image that represents lane features. The function segments the input grayscale intensity image, `birdsEyeImage`, using a lane ridge detector. `birdsEyeConfig` transforms point locations from vehicle coordinates to image coordinates. The `approxMarkerWidth` argument is in world units, and specifies the approximate width of the lane-like features that are detected.

`birdsEyeBW = segmentLaneMarkerRidge(____,Name,Value)` returns a binary image with additional options specified by one or more `Name,Value` pair arguments.

Examples

Detect Lanes in Road Image

Load a bird's-eye-view configuration object.

```
load birdsEyeConfig
```

Load the image captured from the sensor that is defined in the bird's-eye-view configuration object.

```
I = imread('road.png');  
figure  
imshow(I)  
title('Original Image')
```

Original Image



Create a bird's-eye-view image.

```
birdsEyeImage = transformImage(birdsEyeConfig,I);  
imshow(birdsEyeImage)
```



Convert bird's-eye-view image to grayscale.

```
birdsEyeImage = im2gray(birdsEyeImage);
```

Set the approximate lane marker width to 25 cm, which is in world units.

```
approxMarkerWidth = 0.25;
```

Detect lane features.

```
birdsEyeBW = segmentLaneMarkerRidge(birdsEyeImage, birdsEyeConfig, approxMarkerWidth);  
imshow(birdsEyeBW)
```

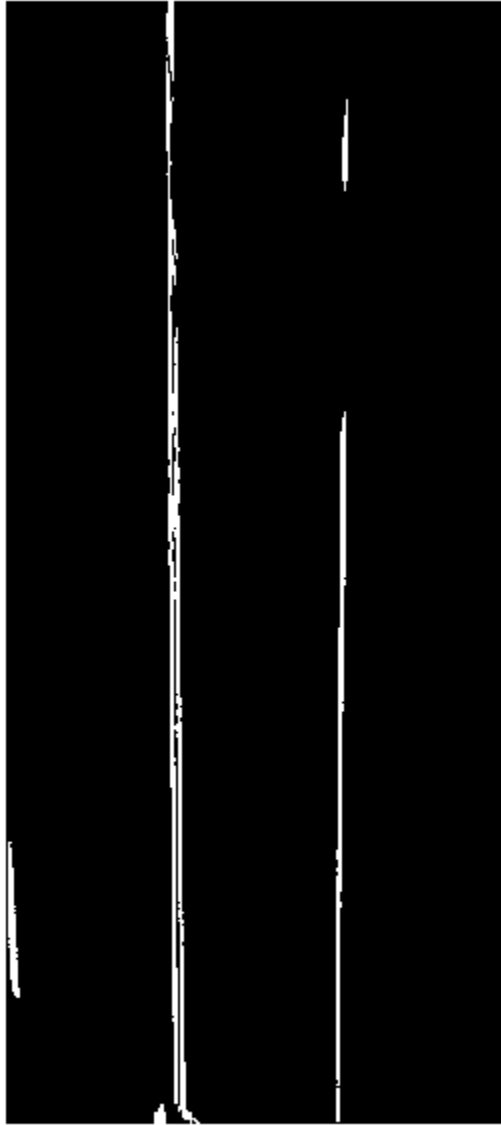

Input Arguments

birdsEyeImage — Bird's-eye-view image

matrix

Bird's-eye-view image, specified as a nonsparse matrix.

Data Types: `single` | `int16` | `uint16` | `uint8`

birdsEyeConfig — Object to transform point locations

`birdsEyeView` object

Object to transform point locations from vehicle to image coordinates, specified as a `birdsEyeView` object.

approxMarkerWidth — Approximate width of lane-like features

real scalar in world units

Approximate width of lane-like features for the function to detect in the bird's-eye-view image, specified as a real scalar in world units, such as meters.

Name-Value Pair Arguments

Specify optional pairs of arguments as `Name1=Value1, . . . , NameN=ValueN`, where `Name` is the argument name and `Value` is the corresponding value. Name-value arguments must appear after other arguments, but the order of the pairs does not matter.

Before R2021a, use commas to separate each name and value, and enclose Name in quotes.

Example: 'ROI' []

ROI — Region of interest

[] (default) | world units

Region of interest in world units, specified as the comma-separated pair consisting of 'ROI' and a 1-by-4 vector in the format `[xmin,xmax,ymin,ymax]`. The function searches for lane-like features only within this region of interest. If you do not specify ROI, the function searches the entire image.

Sensitivity — Sensitivity factor

0.25 (default) | real scalar in the range [0, 1]

Sensitivity factor, specified as the comma-separated pair consisting of 'Sensitivity' and a real scalar in the range [0, 1]. You can increase this value to detect more lane-like features. However, the higher sensitivity can increase the risk of false detections.

Output Arguments**birdsEyeBW — Bird's-eye-view image**

binary image

Bird's-eye-view image, returned as a binary image that represents lane features.

More About**Vehicle Coordinate System**

This function uses a vehicle coordinate system to define point locations, as defined by the sensor in the `birdsEyeView` object. It uses the same world units as defined by the `birdsEyeConfig.Sensor.WorldUnits` property. See "Coordinate Systems in Automated Driving Toolbox".

Algorithms

`segmentLaneMarkerRidge` selects lanes by searching for pixels that are lane-like. Lane-like pixels are groups of pixels with high-intensity contrast compared to neighboring pixels on either side. The

function chooses the filter used to threshold the intensity contrast based on the `approxMarkerWidth` value. The filter has high responses for pixels with intensity values higher than those of the left and right neighboring pixels that have a similar intensity at a distance of `approxMarkerWidth`. The function retains only certain values from the filtered image based on the `Sensitivity` factor.

Version History

Introduced in R2017a

References

- [1] Nieto, M., J. A. Laborda, and L. Salgado. "Road Environment Modeling Using Robust Perspective Analysis and Recursive Bayesian Segmentation." *Machine Vision and Applications*. Volume 22, Issue 6, 2011, pp. 927-945.

Extended Capabilities

C/C++ Code Generation

Generate C and C++ code using MATLAB® Coder™.

See Also

`birdsEyeView`

smoothPathSpline

Smooth vehicle path using cubic spline interpolation

Syntax

```
[poses,directions] = smoothPathSpline(refPoses,refDirections,numSmoothPoses)
[poses,directions] = smoothPathSpline(refPoses,refDirections,numSmoothPoses,
minSeparation)
[ ____,cumLengths,curvatures] = smoothPathSpline( ____ )
```

Description

`[poses,directions] = smoothPathSpline(refPoses,refDirections,numSmoothPoses)` generates a smooth vehicle path, consisting of `numSmoothPoses` discretized poses, by fitting the input reference path poses to a cubic spline. Given the input reference path directions, `smoothPathSpline` also returns the directions that correspond to each pose.

Use this function to convert a C^1 -continuous vehicle path to a C^2 -continuous path. C^1 -continuous paths include the `driving.DubinsPathSegment` or `driving.ReedsSheppPathSegment` paths that you can plan using a `pathPlannerRRT` object. For more details on these path types, see “ C^1 -Continuous and C^2 -Continuous Paths” on page 3-223.

You can use the returned poses and directions with a vehicle controller, such as the `lateralControllerStanley` function.

`[poses,directions] = smoothPathSpline(refPoses,refDirections,numSmoothPoses,minSeparation)` specifies a minimum separation threshold between poses. If the distance between two poses is smaller than `minSeparation`, the function uses only one of the poses for interpolation.

`[____,cumLengths,curvatures] = smoothPathSpline(____)` also returns the cumulative path length and signed path curvature at each returned pose, using any of the previous syntaxes. Use these values to generate a velocity profile along the path.

Examples

Smooth a Planned Path

Smooth a path that was planned by an RRT* path planner.

Load and plot a costmap of a parking lot.

```
data = load('parkingLotCostmap.mat');
costmap = data.parkingLotCostmap;
plot(costmap)
```

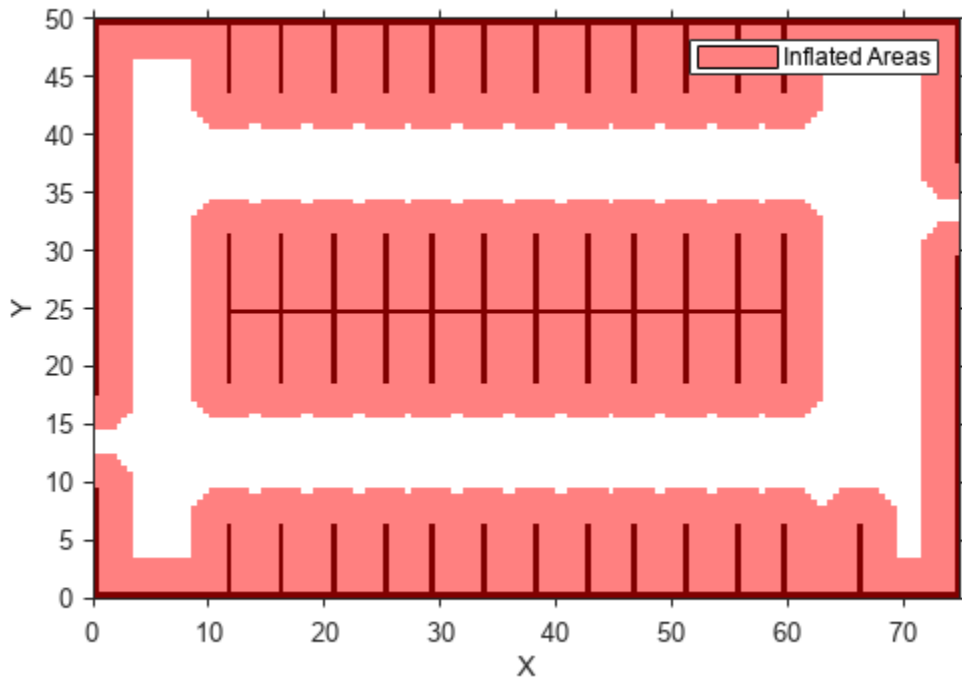
Define start and goal poses for the vehicle as $[x, y, \theta]$ vectors. World units for the (x,y) locations are in meters. World units for the θ orientation angles are in degrees.

```
startPose = [4,4,90]; % [meters, meters, degrees]
goalPose = [30,13,0];
```

Use a `pathPlannerRRT` object to plan a path from the start pose to the goal pose.

```
planner = pathPlannerRRT(costmap);
refPath = plan(planner,startPose,goalPose);
```

Plot and zoom in on the planned path. The path is composed of a sequence of Dubins curves. These curves include abrupt changes in curvature that are not suitable for driving with passengers.

```
hold on
plot(refPath,'Vehicle','off','DisplayName','Reference path')
xlim([3 31])
ylim([3 18])
```

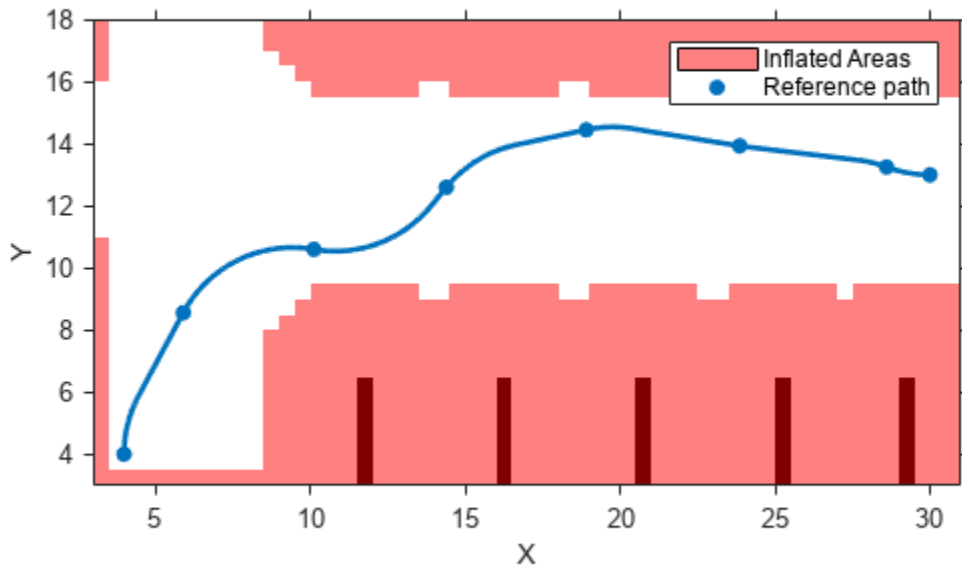

Interpolate the transition poses of the path. Use these poses as the reference poses for interpolating the smooth path. Also return the motion directions at each pose.

```
[refPoses,refDirections] = interpolate(refPath);
```

Specify the number of poses to return in the smooth path. Return poses spaced about 0.1 meters apart, along the entire length of the path.

```
approxSeparation = 0.1; % meters
numSmoothPoses = round(refPath.Length / approxSeparation);
```

Generate the smooth path by fitting a cubic spline to the reference poses. `smoothPathSpline` returns the specified number of discretized poses along the smooth path.

```
[poses,directions] = smoothPathSpline(refPoses,refDirections,numSmoothPoses);
```

Plot the smooth path. The more abrupt changes in curvature that were present in the reference path are now smoothed out.

```
plot(poses(:,1),poses(:,2),'LineWidth',2,'DisplayName','Smooth path')
hold off
```

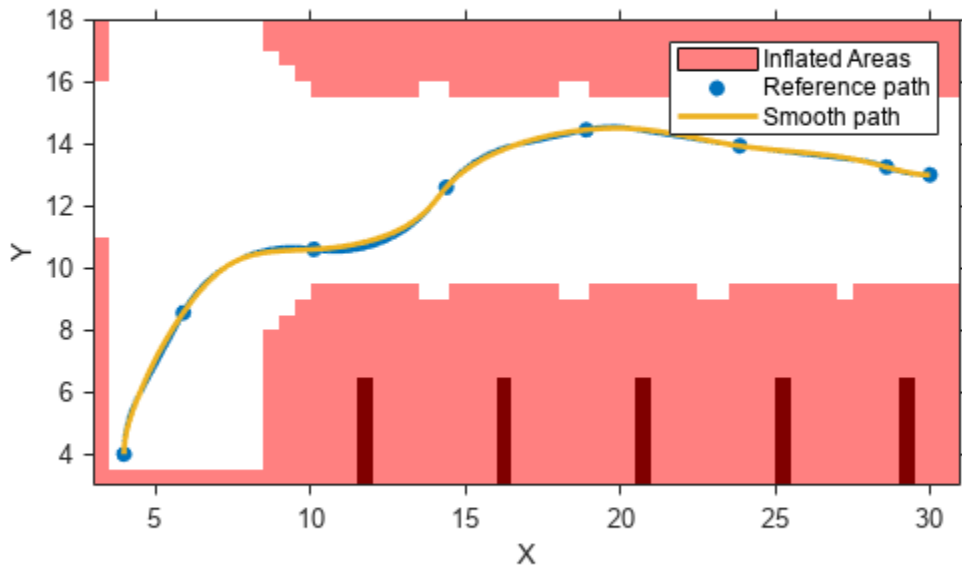

Input Arguments

refPoses — Reference poses

M -by-3 matrix of $[x, y, \theta]$ vectors

Reference poses of the vehicle along the path, specified as an M -by-3 matrix of $[x, y, \theta]$ vectors, where M is the number of poses.

x and y specify the location of the vehicle in meters. θ specifies the orientation angle of the vehicle in degrees.

Data Types: single | double

refDirections — Reference directions

M -by-1 column vector of 1s (forward motion) and -1s (reverse motion)

Reference directions of the vehicle along the path, specified as an M -by-1 column vector of 1s (forward motion) and -1s (reverse motion). M is the number of reference directions. Each element of `refDirections` corresponds to a pose in the `refPoses` input argument.

Data Types: single | double

numSmoothPoses — Number of smooth poses to return

positive integer

Number of smooth poses to return in the `poses` output argument, specified as a positive integer. To increase the granularity of the returned poses, increase `numSmoothPoses`.

minSeparation — Minimum separation between poses

1e-3 (default) | positive real scalar

Minimum separation between poses, in meters, specified as a positive real scalar. If the Euclidean (x , y) distance between two poses is less than this value, then the function uses only one of these poses for interpolation.

Output Arguments

poses — Discretized poses of smoothed path

`numSmoothPoses`-by-3 matrix of $[x, y, \theta]$ vectors

Discretized poses of the smoothed path, returned as a `numSmoothPoses`-by-3 matrix of $[x, y, \theta]$ vectors.

x and y specify the location of the vehicle in meters. θ specifies the orientation angle of the vehicle in degrees.

The values in `poses` are of the same data type as the values in the `refPoses` input argument.

directions — Motion directions at each output pose

`numSmoothPoses`-by-1 column vector of 1s (forward motion) and -1s (reverse motion)

Motion directions at each output pose in `poses`, returned as a `numSmoothPoses`-by-1 column vector of 1s (forward motion) and -1s (reverse motion).

The values in `directions` are of the same data type as the values in the `refDirections` input argument.

cumLengths — Cumulative path lengths

`numSmoothPoses`-by-1 real-valued column vector

Cumulative path length at each output pose in `poses`, returned as a `numSmoothPoses`-by-1 real-valued column vector. Units are in meters.

You can use the `cumLengths` and `curvatures` outputs to generate a velocity profile of the vehicle along the smooth path. For more details, see the “Automated Parking Valet” example.

curvatures — Signed path curvatures

`numSmoothPoses`-by-1 real-valued column vector

Signed path curvatures at each output pose in `poses`, returned as a `numSmoothPoses`-by-1 real-valued column vector. Units are in radians per meter.

You can use the `curvatures` and `cumLengths` outputs to generate a velocity profile of the vehicle along the smooth path. For more details, see the “Automated Parking Valet” example.

More About

C^1 -Continuous and C^2 -Continuous Paths

A path is C^1 -continuous if its derivative exists and is continuous. Paths that are only C^1 -continuous have discontinuities in their curvature. For example, a path composed of Dubins or Reeds-Shepp path segments has discontinuities in curvature at the points where the segments join. These discontinuities result in changes in direction that are not smooth enough for driving with passengers.

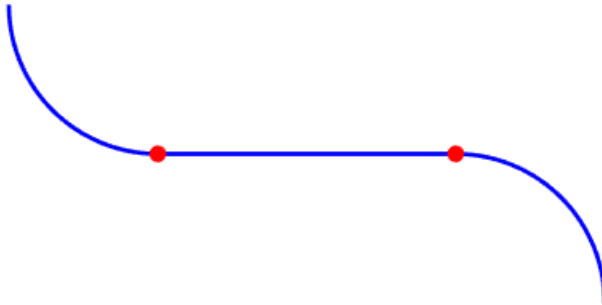

A path is also C^2 -continuous if its second derivative exists and is continuous. C^2 -continuous paths have continuous curvature and are smooth enough for driving with passengers.

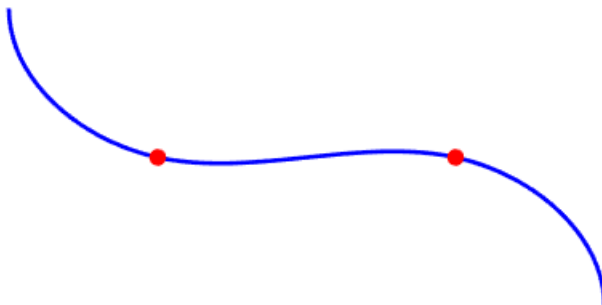

Tips

- To check if a smooth path is collision-free, specify the smooth poses as an input to the `checkPathValidity` function.

Algorithms

- The path-smoothing algorithm interpolates a parametric cubic spline that passes through all input reference pose points. The parameter of the spline is the cumulative chord length at these points. [1]
- The tangent direction of the smoothed output path approximately matches the orientation angle of the vehicle at the starting and goal poses.

Version History

Introduced in R2019a

References

- [1] Floater, Michael S. "On the Deviation of a Parametric Cubic Spline Interpolant from Its Data Polygon." *Computer Aided Geometric Design*. Vol. 25, Number 3, 2008, pp. 148-156.
- [2] Lepetic, Marko, Gregor Klančar, Igor Skrjanc, Drago Matko, and Bostjan Potocnik. "Time Optimal Path Planning Considering Acceleration Limits." *Robotics and Autonomous Systems*. Vol. 45, Numbers 3-4, 2003, pp. 199-210.

Extended Capabilities

C/C++ Code Generation

Generate C and C++ code using MATLAB® Coder™.

See Also

Functions

`lateralControllerStanley` | `pathPlannerRRT` | `driving.Path` | `checkPathValidity` | `spline` | `interpolate`

Blocks

Path Smoother Spline

Topics

"Automated Parking Valet"

updateLaneSpec

Update lane specifications using sensor detections

Syntax

```
rd = updateLaneSpec(laneDetections, roadProperties, refLaneSpec, egoTrajectory,
initialEgoLaneIdx)
rd = updateLaneSpec( ____, Name=Value)
```

Description

`rd = updateLaneSpec(laneDetections, roadProperties, refLaneSpec, egoTrajectory, initialEgoLaneIdx)` updates the reference lane specifications `refLaneSpec` using the recorded lane detection data `laneDetections`. For information on how to generate lane detections from camera data, see “Extract Lane Information from Recorded Camera Data for Scene Generation” example.

The function localizes the ego vehicle using the specified ego trajectory, road properties, and initial ego lane index, and then maps the lane boundary detections to update the lane markings and lane widths of the reference lane specifications. The function returns updated road properties, `rd`, that have the same data type as the input road properties `roadProperties`.

`rd = updateLaneSpec(____, Name=Value)` specifies options using one or more name-value arguments. For example, `UpdateRefLaneMarking=false` specifies not to update reference lane marking information.

Note This function requires the Scenario Builder for Automated Driving Toolbox support package and Sensor Fusion and Tracking Toolbox. You can install Scenario Builder for Automated Driving Toolbox from the Add-On Explorer. For more information about installing add-ons, see [Get and Manage Add-Ons](#).

Examples

Update Lane Specifications Using Recorded Lane Detections

Load recorded sensor data that contains lane detections, ego trajectory, and road data, stored as a structure, into the workspace. For more information on generating lane detections from recorded camera data, see “Extract Lane Information from Recorded Camera Data for Scene Generation”.

```
data = load("recordedLaneDetections.mat");
```

Extract the road data. The road data table contains these five road parameters: `RoadID`, `RoadCenters`, `RoadWidth`, `LeftBoundary`, and `RightBoundary`. Note that, because this road data has been generated from a standard definition (SD) map, it lacks lane information.

```
roadProperties = data.roadData
```

```
roadProperties=1x5 table
    RoadID    RoadCenters    RoadWidth    LeftBoundary    RightBoundary
```

73	{23x3 double}	6	{406x3 double}	{406x3 double}
----	---------------	---	----------------	----------------

Extract the ego trajectory.

```
egoTrajectory = data.egoTrajectory;
```

Extract the lane detections. The lane detections have been preprocessed to organize them into a format that the `updateLaneSpec` function supports. For more information on organizing recorded lane detections, see “Preprocess Lane Detections for Scenario Generation”.

```
laneDetections = data.laneDets;
```

Create reference lane specifications for three lanes, with solid lane markings for each lane boundary. Note that each lane has a default width of 3.6 meters.

```
lm = laneMarking("Solid");
ls = lanespec(3,Marking=lm);
```

Map the reference lane specifications to the extracted road ID using a dictionary object.

```
refLanespec = dictionary(roadProperties.RoadID,{ls});
```

Update the lane specifications using the recorded lane detections. The `updateLaneSpec` function returns a table that contains the updated road properties and an additional `Lanes` column, which contains the lane specifications.

```
rd = updateLaneSpec(laneDetections,roadProperties, ...
    refLanespec,egoTrajectory,2)
```

rd=1x6 table

RoadID	RoadCenters	RoadWidth	LeftBoundary	RightBoundary	Lanes
73	{23x3 double}	{[11.3091]}	{406x3 double}	{406x3 double}	{1x1 lanespec}

Display the updated lane widths. Notice that the function has updated the widths of the second and third lanes. By default, the function updates only those lanes that overlap with the ego trajectory. If you want to update all the lanes of a road, use the `ReplicateUpdatedLaneWidth` argument when specifying the `updateLaneSpec` function.

```
rd.Lanes{1,1}.Width
```

```
ans = 1x3
```

```
3.6000    3.5824    3.9767
```

Display the updated lane markings for the third and fourth lane boundaries. Notice that the function has updated these lane markings from solid lines to dashed lines.

```
[rd.Lanes{1,1}.Marking(3).Type rd.Lanes{1,1}.Marking(4).Type]
```

```
ans =
```

```
1x2 LaneBoundaryType enumeration array
```

Dashed Dashed

Input Arguments

laneDetections — Recorded lane detection data

laneData object | M -by- N table

Recorded lane detection data, specified as a laneData object or an M -by- N table. M is the number of lane-detection samples and $N-1$ is the maximum number of detected lane boundaries across all samples. This table shows an example of the laneDetections data organized using an M -by- N table. For information about how to organize lane detection data using a laneData object, see “Preprocess Lane Detections for Scenario Generation”.

Time (s)	LaneBoundary1	LaneBoundary2	LaneBoundary3
0	1x1 parabolicLaneBound ary	1x1 parabolicLaneBound ary	1x1 parabolicLaneBound ary
0.05	1x1 parabolicLaneBound ary	1x1 parabolicLaneBound ary	[]
0.1	1x1 parabolicLaneBound ary	1x1 parabolicLaneBound ary	1x1 parabolicLaneBound ary

- The first column of the table specifies the recorded time stamp, in seconds, for each detection. Other columns contain data for the detected lane boundaries specified as parabolicLaneBoundary objects, cubicLaneBoundary objects, or clothoidLaneBoundary objects. You must specify all lane boundaries using the same type of object.
- Empty cells represent missing lane boundary detections.
- The table must specify at least three columns: the first column for timestamps, and the remaining columns for two lane boundaries. The table must not have any empty cell in the first three columns.
- The detected lane boundaries must be in left-to-right order with respect to the travel direction of the ego vehicle.

roadProperties — Road properties

 P -by- Q table

Road properties, specified as a P -by- Q table. P is the number of roads and Q is the number of road properties. Q must be greater than 4. You can specify any number of road properties in any order, but the table must contain these five properties, which the function requires for updating lane specifications:

- RoadID — Identifier of road, specified as a positive integer.
- RoadCenters — Road centers used to define road, specified as a real-valued K -by-3 matrix, where K is the number of road centers. Each matrix row represents the (x, y, z) coordinates of a road center. Units are in meters.

- **RoadWidth** — Width of road, specified as a real positive scalar or vector. Units are in meters.
- **LeftBoundary** — Left boundary of road, specified as a real-valued L -by-3 matrix, where L is the number of left boundary points. Each matrix row represents the (x, y, z) coordinates of a left boundary point. Units are in meters.
- **RightBoundary** — Right boundary of road, specified as a real-valued R -by-3 matrix, where R is the number of right boundary points. Each matrix row represents the (x, y, z) coordinates of a right boundary point. Units are in meters.

Tip For the automatic scene generation workflow, use the `actorRoadProperties` output of the `selectActorRoads` function to specify road properties. For more information, see “Generate High Definition Scene from Lane Detections and OpenStreetMap”.

Data Types: table

refLaneSpec — Reference lane specifications

dictionary object | lanespec object | compositeLaneSpec object | P -by-1 cell array of lanespec objects | P -by-1 cell array of compositeLaneSpec objects

Reference lane specifications, specified as a dictionary object, or a scalar or P -by-1 cell array of lanespec objects or compositeLaneSpec objects. P is the number of roads specified using the `roadProperties` input.

When you specify the reference lane specifications as a dictionary object, the data types of keys and values of a dictionary must be `double` and `cell`, respectively. The keys must correspond to road IDs in the `roadProperties` input and the values must contain a lanespec or a compositeLaneSpec object for the corresponding road IDs. The number of keys and values of a dictionary must match the number of roads specified using the `roadProperties` input.

egoTrajectory — Trajectory information of ego vehicle

waypointTrajectory object

Trajectory information of the ego vehicle, specified as a waypointTrajectory object.

initialEgoLaneIdx — Starting lane index of ego vehicle

positive integer

Starting lane index of the ego vehicle, specified as a positive integer. You must number the lanes in left-to-right order along the travel direction of the ego vehicle.

Data Types: single | double | int8 | int16 | int32 | int64 | uint8 | uint16 | uint32 | uint64

Name-Value Pair Arguments

Specify optional pairs of arguments as `Name1=Value1, ..., NameN=ValueN`, where `Name` is the argument name and `Value` is the corresponding value. Name-value arguments must appear after other arguments, but the order of the pairs does not matter.

Example:

```
updateLaneSpec(laneDetections, roadProperties, refLaneSpec, egoTrajectory, initialEgoLaneIdx, UpdateRefLaneMarking=false) specifies not to update reference lane marking information.
```

UpdateRefLaneMarking — Reference lane markings update flag

true or 1 (default) | false or 0

Reference lane markings update flag, specified as a logical 1 (true) or 0 (false).

- true or 1 — Update the input lane markings information using the specified lane detection information.
- false or 0 — Do not update the input lane markings. The function updates only lane widths using the specified lane detection information.

Data Types: logical

ReplicateUpdatedLaneWidth — Non-detected lane width update flag

false or 0 (default) | true or 1

Non-detected lane width update flag, specified as a logical 1 (true) or 0 (false).

- false or 0 — Do not update the widths of non-detected lanes. The function updates the lane widths of only detected lanes.
- true or 1 — Update the widths of all lanes whether they are detected or not. For this option, the function computes the mean of the widths of the detected lanes, and then replaces the widths of all lanes with the computed mean value.

Data Types: logical

Output Arguments**rd — Updated road properties**

table

Updated road properties, returned as a table. If the roadProperties input contains a Lanes column, then the function returns the updated road properties as a table with the same size as the roadProperties input. Otherwise, the function returns the updated road properties table by appending a Lanes column to the roadProperties input table. The Lanes column describes lane specifications for each road in the table.

Data Types: table

Version History

Introduced in R2022b

R2023a: Specify recorded lane detections using laneData object

The updateLaneSpec function supports the laneData object to specify the laneDetections input. The object provides efficient data structure to store lane detections with timestamps. You can add or remove data from the object and find lane information nearest to the specified timestamp.

R2023a: Specify reference lane specifications using dictionary object

The updateLaneSpec function supports the dictionary object to specify the refLaneSpec input. The object makes it easier to define mapping between lane specifications and extracted road IDs.

See Also

roadprops | selectActorRoads | actorprops | getMapROI | waypointTrajectory

Topics

“Overview of Scenario Variant Generation”

“Extract Lane Information from Recorded Camera Data for Scene Generation”

“Preprocess Lane Detections for Scenario Generation”

“Generate High Definition Scene from Lane Detections and OpenStreetMap”

“Generate Scenario from Actor Track List and GPS Data”

vehicleDetectorACF

Load vehicle detector using aggregate channel features

Syntax

```
detector = vehicleDetectorACF  
detector = vehicleDetectorACF(modelName)
```

Description

`detector = vehicleDetectorACF` returns a pretrained vehicle detector using aggregate channel features (ACF). The returned `acfObjectDetector` object is trained using unoccluded images of the front, rear, left, and right sides of the vehicles.

`detector = vehicleDetectorACF(modelName)` returns a pretrained vehicle detector based on the model specified in `modelName`. A 'full-view' model uses training images that are unoccluded views from the front, rear, left, and right sides of vehicles. A 'front-rear-view' model uses images only from the front and rear sides of the vehicle.

Examples

Detect Vehicles in Image

Load the pre-trained detector for vehicles

```
detector = vehicleDetectorACF('front-rear-view');
```

Load an image and run the detector.

```
I = imread('highway.png');  
[bboxes,scores] = detect(detector,I);
```

Overlay bounding boxes and scores for vehicles detected in the image.

```
I = insertObjectAnnotation(I,'rectangle',bboxes,scores);  
figure  
imshow(I)  
title('Detected Vehicles and Detection Scores')
```

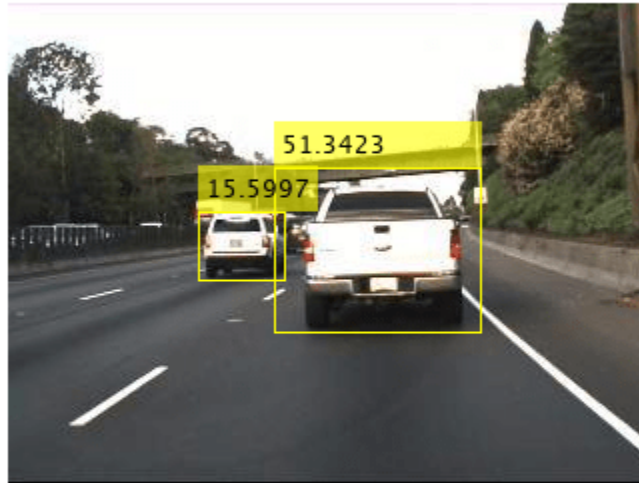
Detected Vehicles and Detection Scores

Input Arguments

modelName — Type of vehicle detector model

'full-view' (default) | 'front-rear-view'

Type of vehicle detector model, specified as either 'front-rear-view' or 'full-view'. A 'full-view' model uses training images that are unoccluded views from the front, rear, left, and right sides of vehicles. A 'front-rear-view' model uses images only from the front and rear sides of the vehicle.

Data Types: char | string

Output Arguments

detector — Trained ACF-based object detector

acfObjectDetector object

Trained ACF-based object detector, returned as an acfObjectDetector object.

Version History

Introduced in R2017a

See Also

acfObjectDetector | trainACFObjectDetector

vehicleDetectorFasterRCNN

Detect vehicles using Faster R-CNN

Syntax

```
detector = vehicleDetectorFasterRCNN
```

Description

`detector = vehicleDetectorFasterRCNN` returns a trained Faster R-CNN (regions with convolution neural networks) object detector for detecting vehicles. Faster R-CNN is a deep learning object detection framework that uses a convolutional neural network (CNN) for detection.

The detector is trained using unoccluded images of the front, rear, left, and right sides of vehicles. The CNN used with the vehicle detector uses a modified version of the MobileNet-v2 network architecture.

Use of this function requires Deep Learning Toolbox™.

Note The detector is trained using `uint8` images. Before using this detector, rescale the input images to the range `[0, 255]` by using `im2uint8` or `rescale`.

Examples

Detect Vehicles on Highway

Detect cars in a single image and annotate the image with the detection scores. To detect cars, use a Faster R-CNN object detector that was trained using images of vehicles.

Load the pretrained detector.

```
fasterRCNN = vehicleDetectorFasterRCNN;
```

Use the detector on a loaded image. Store the locations of the bounding boxes and their detection scores.

```
I = imread('highway.png');  
[bboxes,scores] = detect(fasterRCNN,I);
```

Annotate the image with the detections and their scores.

```
I = insertObjectAnnotation(I,'rectangle',bboxes,scores);  
figure  
imshow(I)  
title('Detected Vehicles and Detection Scores')
```

Detected Vehicles and Detection Scores

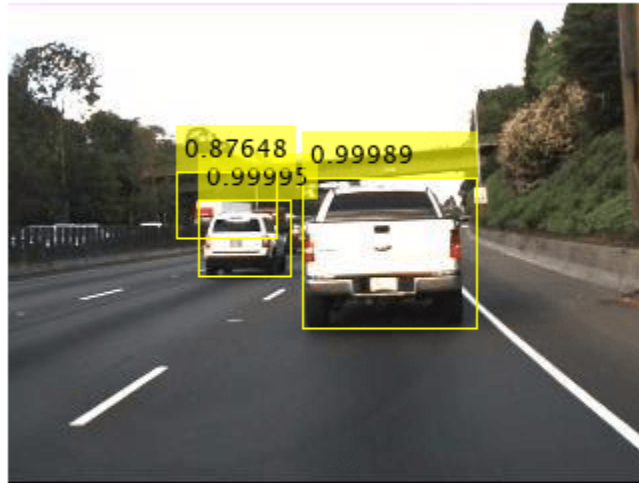

Output Arguments

detector — Trained Faster R-CNN-based object detector

`fasterRCNNObjectDetector` object

Trained Faster R-CNN-based object detector, returned as an `fasterRCNNObjectDetector` object.

Version History

Introduced in R2017a

R2020b: modelName input argument is not recommended

Behavior change in future release

`modelName` input argument is not recommended. To update your code, remove all instances of `modelName`.

Discouraged Usage	Recommended Replacement
<code>modelName = 'front-rear-view'</code> <code>detector = vehicleDetectorFasterRCNN(modelName);</code>	<code>detector = vehicleDetectorFasterRCNN;</code>

See Also

`fasterRCNNObjectDetector` | `trainFasterRCNNObjectDetector` | `vehicleDetectorACF` | `vehicleDetectorYOLOv2`

vehicleDetectorYOLOv2

Detect vehicles using YOLO v2 Network

Syntax

```
detector = vehicleDetectorYOLOv2
```

Description

`detector = vehicleDetectorYOLOv2` returns a trained you only look once (YOLO) v2 object detector for detecting vehicles. YOLO v2 is a deep learning object detection framework that uses a convolutional neural network (CNN) for detection.

The detector is trained using unoccluded RGB images of the front, rear, left, and right sides of cars on a highway scene. The CNN used with the vehicle detector uses a modified version of the MobileNet-v2 network architecture. You can also fine tune the vehicle detector with additional training data by using the `trainYOLOv2ObjectDetector`.

For information about creating a YOLO v2 object detector, see “Create YOLO v2 Object Detection Network”. Use of this function requires Deep Learning Toolbox.

Examples

Detect Vehicles Using YOLO v2 Detector

This example shows how to detect cars in an image and annotate the image with the detection scores. To detect the cars, use a YOLO v2 detector that is trained to detect vehicles in an image.

Load the pretrained detector.

```
detector = vehicleDetectorYOLOv2();
```

Read a test image into the workspace.

```
I = imread('highway.png');
```

Detect vehicles in the test image by using the trained YOLO v2 detector. Pass the test image and the detector as input to the `detect` function. The `detect` function returns the bounding boxes and the detection scores.

```
[bboxes,scores] = detect(detector,I);
```

Annotate the image with the bounding boxes and the detection scores. Display the detection results. The bounding boxes localize vehicles in the test image.

```
I = insertObjectAnnotation(I,'rectangle',bboxes,scores);
figure
imshow(I)
title('Detected vehicles and detection scores');
```

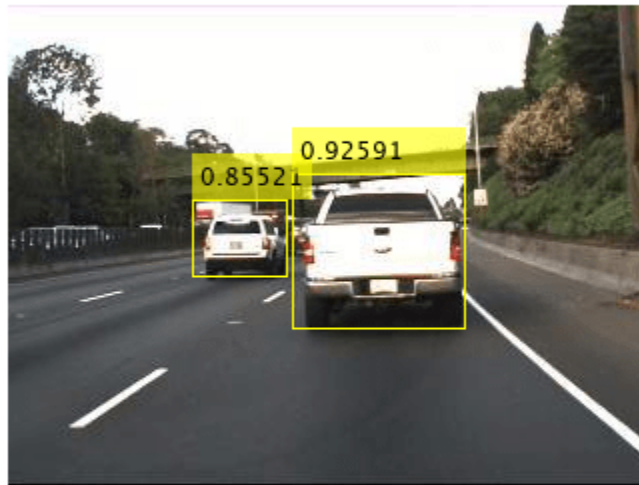
Detected vehicles and detection scores

Output Arguments

detector — Trained YOLO v2 network for vehicle detection

`yolov2objectDetector`

Trained YOLO v2 network for vehicle detection, returned as an `yolov2objectDetector` object. To detect vehicles in a test image, pass the YOLO v2 vehicle detector as input to the `detect` function.

Version History

Introduced in R2020a

Extended Capabilities

C/C++ Code Generation

Generate C and C++ code using MATLAB® Coder™.

For code generation, you can load the network by using the syntax `detectorNet = vehicleDetectorYOLOv2()` or by passing the `vehicleDetectorYOLOv2` function to `coder.loadDeepLearningNetwork`. For example: `detectorNet = coder.loadDeepLearningNetwork('vehicleDetectorYOLOv2')`

For more information, see “Load Pretrained Networks for Code Generation” (MATLAB Coder).

GPU Code Generation

Generate CUDA® code for NVIDIA® GPUs using GPU Coder™.

Usage notes and limitations:

For code generation, you can load the network by using the syntax `detectorNet = vehicleDetectorYOLOv2()` or by passing the `vehicleDetectorYOLOv2` function to

`coder.loadDeepLearningNetwork`. For example: `detectorNet = coder.loadDeepLearningNetwork('vehicleDetectorYOLOv2')`

For more information, see “Load Pretrained Networks for Code Generation” (GPU Coder).

See Also

Objects

`yolov2objectDetector`

Functions

`trainYOLOv2objectDetector` | `vehicleDetectorFasterRCNN` | `detect` | `configureDetectorMonoCamera`

Topics

“Create YOLO v2 Object Detection Network”

“Train YOLO v2 Network for Vehicle Detection”

“Object Detection Using YOLO v2 Deep Learning”

zenrinCredentials

Set up or delete Zenrin Japan Map API 3.0 (Itsumo NAVI API 3.0) credentials

Syntax

```
zenrinCredentials('setup')  
zenrinCredentials('delete')
```

Description

`zenrinCredentials('setup')` opens a dialog box for specifying the credentials required to access the Zenrin Japan Map API 3.0 (Itsumo NAVI API 3.0)⁴ service. By default, credentials last for the duration of a MATLAB session. To save credentials between sessions, in the Zenrin Japan Map API 3.0 (Itsumo NAVI API 3.0) Credentials dialog box, select the **Save my credentials between MATLAB sessions** check box.

The `zenrinCredentials` function requires Automated Driving Toolbox Importer for Zenrin Japan Map API 3.0 (Itsumo NAVI API 3.0) Service.

Simplified form: `zenrinCredentials setup`

`zenrinCredentials('delete')` deletes saved Zenrin Japan Map API 3.0 (Itsumo NAVI API 3.0) credentials. Any subsequent use of the Zenrin Japan Map API 3.0 (Itsumo NAVI API 3.0) service requires entering new credentials.

Simplified form: `zenrinCredentials delete`

Examples

Manage Zenrin Japan Map API 3.0 (Itsumo NAVI API 3.0) Credentials

Set up Zenrin Japan Map API 3.0 (Itsumo NAVI API 3.0) credentials.

```
zenrinCredentials setup
```

⁴ To gain access to the Zenrin Japan Map API 3.0 (Itsumo NAVI API 3.0) service and get the required credentials (a client ID and secret key), you must enter into a separate agreement with ZENRIN DataCom CO., LTD.

Enter a valid **Client ID** and **Secret Key**. You can obtain these credentials by entering into a separate agreement with ZENRIN DataCom CO., LTD.. Select the appropriate access point for your Zenrin license.

- **Production** (<https://core.its-mo.com>) — Use this option when you have a permanent license agreement to access Zenrin Japan Map API 3.0 (Itsumo NAVI API 3.0).
- **Verification** (<https://test.core.its-mo.com>) — Use this option when you have an evaluation license agreement to access Zenrin Japan Map API 3.0 (Itsumo NAVI API 3.0).

Optionally, select **Save my credentials between MATLAB sessions** to save your credentials between MATLAB sessions. Click **OK**.

Load a driving route.

```
data = load('tokyoSequence.mat');
lat = data.latitude;
lon = data.longitude;
```

Create a driving scenario, and import the Zenrin Japan Map API 3.0 (Itsumo NAVI API 3.0) road data that is nearest to the driving route into the scenario. The Zenrin Japan Map Credentials dialog box does not open because the credentials have already been set up.

```
scenario = drivingScenario;
roadNetwork(scenario, 'ZenrinJapanMap', lat, lon)
```

Delete the Zenrin Japan Map API 3.0 (Itsumo NAVI API 3.0) credentials you previously entered. The next time you import Zenrin Japan Map API 3.0 (Itsumo NAVI API 3.0) data, you must enter your credentials again.

```
zenrinCredentials delete
```

Version History

Introduced in R2021a

See Also

Objects

drivingScenario

Functions

roadNetwork

Apps

Driving Scenario Designer

Topics

“Import Zenrin Japan Map API 3.0 (Itsumo NAVI API 3.0) into Driving Scenario”

latlon2local

Convert geographic coordinates to local Cartesian coordinates

Syntax

```
[xEast,yNorth,zUp] = latlon2local(lat,lon,alt,origin)
```

Description

`[xEast,yNorth,zUp] = latlon2local(lat,lon,alt,origin)` converts point locations given by `lat`, `lon`, and `alt` from geographic coordinates to local Cartesian coordinates returned as `xEast`, `yNorth`, and `zUp`. `origin` specifies the anchor of the local coordinate system as a vector of the form `[latOrigin,lonOrigin,altOrigin]`. Local `x`, `y`, `z` coordinates align with east, north and up directions, respectively. `alt` and `altOrigin` are altitudes as returned by a typical GPS sensor.

Examples

Convert Route to Cartesian Coordinates

Load a GPS route.

```
d = load('geoRoute.mat');
```

Define the origin in geographic coordinates, latitude and longitude.

```
alt = 10; % 10 meters is an approximate altitude in Boston, MA  
origin = [d.latitude(1), d.longitude(1), alt];
```

Convert the route from geographic coordinates to Cartesian coordinates, `x` and `y`.

```
[xEast,yNorth] = latlon2local(d.latitude,d.longitude,alt,origin);
```

Plot the route in Cartesian coordinates.

```
figure;  
plot(xEast,yNorth)  
axis('equal'); % set 1:1 aspect ratio to see real-world shape
```

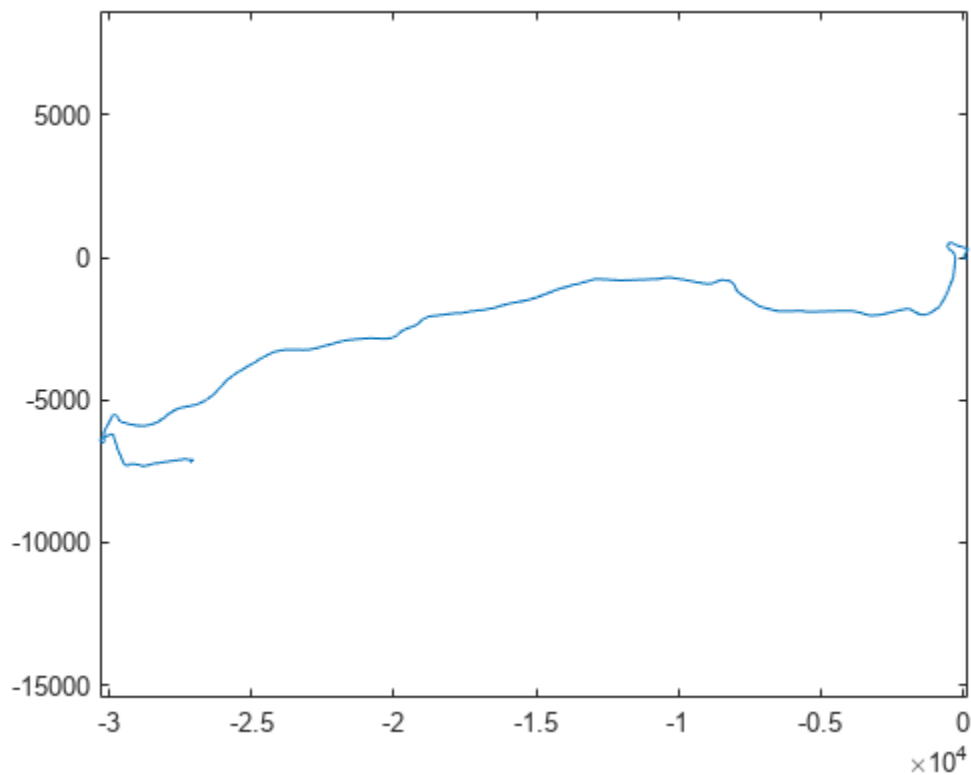

Input Arguments

lat — Latitude coordinates

numeric scalar | numeric vector

Latitude coordinates, in degrees, specified as a numeric scalar or vector. Value must be in the range $[-90, 90]$. `lat` must be the same length as `lon`.

Example: `lat = 42.3648`

Data Types: `single` | `double`

lon — Longitude coordinates

real scalar or vector in the range $[-180, 180]$

Longitude coordinates, in degrees, specified as a numeric scalar or vector. Value must be in the range $[-180, 180]$. `lon` must be the same length as `lat`.

Example: `lon = -71.0214`

Data Types: `single` | `double`

alt — Altitude

numeric scalar | numeric vector

Altitude, in meters, specified as a numeric scalar or vector.

Example: 10

Data Types: `single` | `double`

origin — Anchor of local coordinate system

three-element vector

Anchor of local coordinate system, specified as a three-element vector of the form `[latOrigin,lonOrigin,altOrigin]`.

Example: `[42.3648, -71.0214, 10.0]`;

Data Types: `single` | `double`

Output Arguments

xEast — x-coordinates

numeric scalar | numeric vector

x-coordinates, returned as a numeric scalar or vector, in meters.

xEast is the same class as `lat`. However, if any of the input arguments is of class `single`, then xEast is of class `single`.

yNorth — y-coordinates

numeric scalar | numeric vector

y-coordinates, returned as a numeric scalar or vector, in meters.

yNorth is the same class as `lon`. However, if any of the input arguments is of class `single`, then yNorth is of class `single`.

zUp — z-coordinates

numeric scalar or vector

z-coordinates, returned as a numeric scalar or vector, in meters.

zUp is the same class as `alt`. However, if any of the input arguments is of class `single`, then zUp is of class `single`.

Tips

- The latitude and longitude of the geographic coordinate system use the WGS84 standard that is commonly used by GPS receivers.
- This function defines altitude as the height, in meters, above the WGS84 reference ellipsoid.
- Some GPS receivers use standards other than WGS84. Conversions using other ellipsoids are available in the Mapping Toolbox. This function addresses the most common conversion between geographic locations and Cartesian coordinates used by the on-board sensors of a vehicle.

Version History

Introduced in R2020a

See Also

`geoplayer` | `local2latlon` | `geoplot`

local2latlon

Convert local Cartesian coordinates to geographic coordinates

Syntax

```
[lat,lon,alt] = local2latlon(xEast,yNorth,zUp,origin)
```

Description

`[lat,lon,alt] = local2latlon(xEast,yNorth,zUp,origin)` converts point locations given by `xEast`, `yNorth`, and `zUp` from local Cartesian coordinates to geographic coordinates returned as `lat`, `lon`, and `alt`. `origin` specifies the anchor of the local coordinate system as a three-element vector of the form `[latOrigin,lonOrigin,altOrigin]`. Local coordinates `xEast`, `yNorth`, and `zUp` align with the east, north, and up directions, respectively. `alt` and `altOrigin` are altitudes as typically returned by GPS sensors.

Examples

Convert Route to Geographic Coordinates

Establish an anchor point in the geographic coordinate system. These latitude and longitude coordinates specify Boston, MA.

```
origin = [42.3648, -71.0214, 10.0];
```

Generate local route in Cartesian coordinates, `x`, `y`, and `z`.

```
z = zeros(1,101);    % maintain height of 0 m
x = 0:1000:100000;  % 100 km in 1 km increments
y = x;              % move 100 km northeast
```

Convert the local route coordinates to geographic coordinates, latitude and longitude.

```
[lat,lon] = local2latlon(x,y,z,origin);
```

Visualize the route on a map.

```
zoomLevel = 12;
player = geoplayer(lat(1),lon(1),zoomLevel);
plotRoute(player,lat,lon);
```

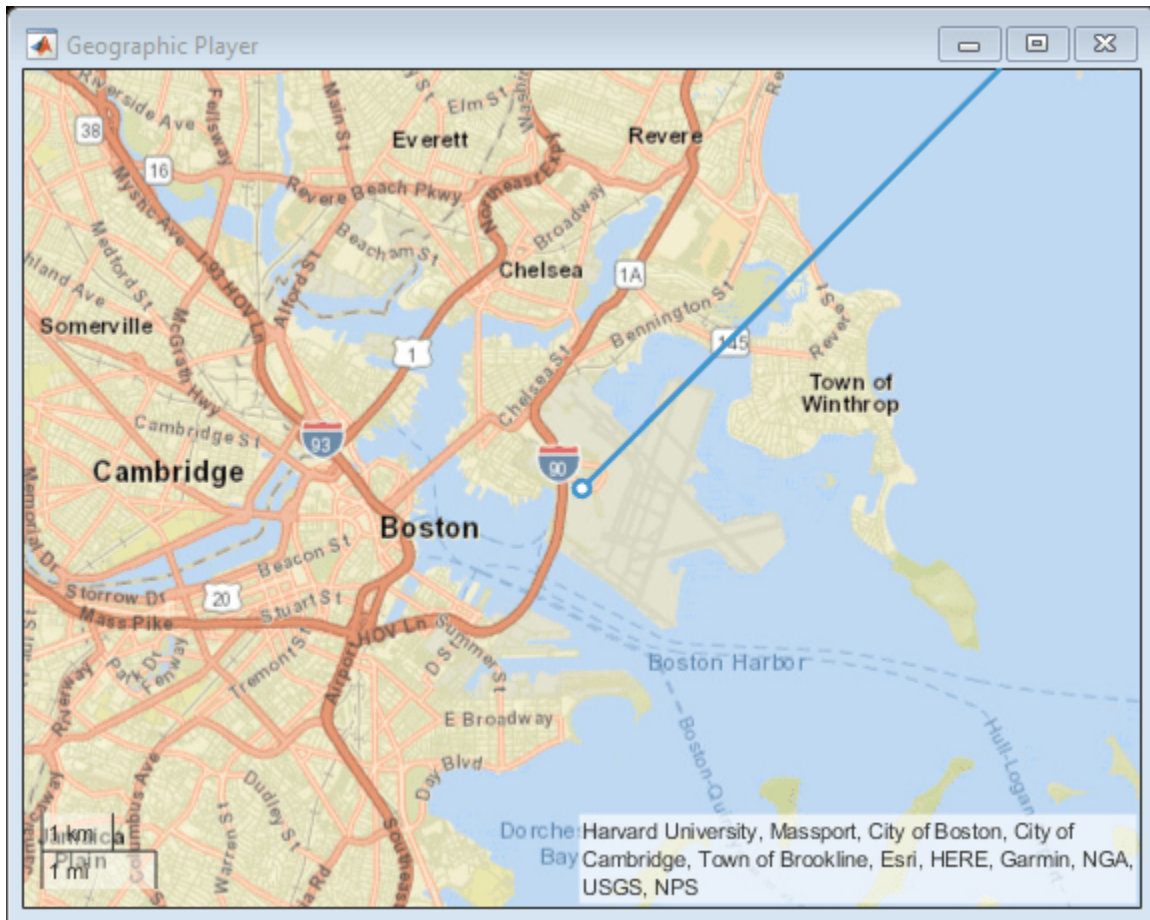

Input Arguments

xEast — x-coordinates

numeric scalar | numeric vector

x-coordinates in the local Cartesian coordinate system, specified as a numeric scalar or vector, in meters.

Example: -2.7119

Data Types: single | double

yNorth — y-coordinates

numeric scalar | numeric vector

y-coordinates in the local Cartesian coordinate system, specified as a numeric scalar or vector, in meters.

Example: -7.0681

Data Types: single | double

zUp — z-coordinates

numeric scalar | numeric vector

z-coordinates in the local Cartesian coordinate system, specified as a numeric scalar or vector, in meters.

Example: -0.2569

Data Types: `single` | `double`

origin — Anchor of local coordinate system

three-element vector

Anchor of local coordinate system, specified as a three-element vector of the form `[latOrigin,lonOrigin,altOrigin]`.

Example: `[42.3648 -71.0214 10]`

Data Types: `single` | `double`

Output Arguments

lat — Latitude

numeric scalar or vector

Latitude, in degrees, returned as a numeric scalar or vector.

`lat` is the same class as `xEast`. However, if any of the input arguments is of class `single`, then `lat` is of class `single`.

lon — Longitude

numeric scalar or vector

Longitude, in degrees, returned as a numeric scalar or vector.

`lon` is the same class as `yNorth`. However, if any of the input arguments is of class `single`, then `lon` is of class `single`.

alt — Altitude

numeric scalar or vector

Altitude, in meters, returned as a numeric scalar or vector, the same class as `zUp`.

`alt` is the same class as `zUp`. However, if any of the input arguments is of class `single`, then `alt` is of class `single`.

Tips

- The latitude and longitude of the geographic coordinate system use the WGS84 standard that is commonly used by GPS receivers.
- This function defines altitude as the height, in meters, above the WGS84 reference ellipsoid.
- Some GPS receivers use standards other than WGS84. Conversions using other ellipsoids are available in the Mapping Toolbox. This function addresses the most common conversion between geographic locations and Cartesian coordinates used by the on-board sensors of a vehicle.

Version History

Introduced in R2020a

See Also

`latlon2local` | `geoplayer` | `geoplot`

actorprops

Generate actor properties from track list

Syntax

```
actorInfo = actorprops(tracklist,egoTrajectory)
actorInfo = actorprops(tracklist,egoTrajectory,AgeThreshold=ageThreshold)
```

Description

`actorInfo = actorprops(tracklist,egoTrajectory)` generates a table containing actor properties based on the input track list `tracklist` and ego trajectory data `egoTrajectory`.

`actorInfo = actorprops(tracklist,egoTrajectory,AgeThreshold=ageThreshold)` excludes actors with age less than the specified age threshold `ageThreshold`.

Note This function requires the Scenario Builder for Automated Driving Toolbox support package and Sensor Fusion and Tracking Toolbox. You can install Scenario Builder for Automated Driving Toolbox from the Add-On Explorer. For more information about installing add-ons, see [Get and Manage Add-Ons](#).

Examples

Generate Actor Properties from Non-Ego Actor Track List

Load a non-ego actor tracklist, waypoints, and time of arrival for the ego vehicle into the workspace.

```
data = load("recordedSensorData");
```

Create a `waypointTrajectory` object for the ego vehicle.

```
egoTrajectory = waypointTrajectory(data.egoWaypoints, ...
    data.egoTimeOfArrival,ReferenceFrame="ENU");
```

Generate and display the actor properties table.

```
actorInfo = actorprops(data.actorTracklistData,egoTrajectory)
```

`actorInfo=18x9 table`

Age	TrackID	ClassID	EntryTime	ExitTime	Mesh	Waypoints
138	4	1	0.000383	6.8497	1x1 extendedObjectMesh	{138x3 double}
261	13	1	0.000383	13.001	1x1 extendedObjectMesh	{261x3 double}
51	22	1	0.000383	2.5007	1x1 extendedObjectMesh	{ 51x3 double}
59	23	1	1.9999	4.8997	1x1 extendedObjectMesh	{ 59x3 double}
6	24	1	3.0507	3.3003	1x1 extendedObjectMesh	{ 6x3 double}
12	25	1	4.6997	5.2497	1x1 extendedObjectMesh	{ 12x3 double}
167	26	1	5.1495	13.451	1x1 extendedObjectMesh	{167x3 double}

65	28	1	6.5994	9.7999	1x1	extendedObjectMesh	{ 65x3 double
31	31	1	9.4507	10.951	1x1	extendedObjectMesh	{ 31x3 double
377	32	1	11.151	29.951	1x1	extendedObjectMesh	{377x3 double
5	33	1	12.002	12.2	1x1	extendedObjectMesh	{ 5x3 double
240	37	1	14.049	26	1x1	extendedObjectMesh	{240x3 double
5	38	1	14.3	14.5	1x1	extendedObjectMesh	{ 5x3 double
5	39	1	14.5	14.7	1x1	extendedObjectMesh	{ 5x3 double
8	40	1	26.2	26.55	1x1	extendedObjectMesh	{ 8x3 double
16	42	1	27.101	27.85	1x1	extendedObjectMesh	{ 16x3 double
:							

Extract Actor Properties with Specified Actor Age Threshold

Load a non-ego actor tracklist, waypoints, and time of arrival for the ego vehicle into the workspace.

```
data = load("recordedSensorData");
```

Create a waypointTrajectory object for the ego vehicle.

```
egoTrajectory = waypointTrajectory(data.egoWaypoints, ...
    data.egoTimeOfArrival);
```

Generate the actor properties table without specifying an age threshold.

```
actorInfo1 = actorprops(data.actorTracklistData, egoTrajectory);
```

Generate an actor properties table with a specified age threshold.

```
actorInfo2 = actorprops(data.actorTracklistData, egoTrajectory, ...
    AgeThreshold=20);
```

Display the number of actors in each property table. The number of actors in actorInfo2 is less as compared to the number of actors in actorInfo1.

```
numActorsInActorInfo1 = numel(actorInfo1.TrackID)
```

```
numActorsInActorInfo1 = 18
```

```
numActorsInActorInfo2 = numel(actorInfo2.TrackID)
```

```
numActorsInActorInfo2 = 10
```

Input Arguments

tracklist — Actor track list information

actorTracklist object | *K*-by-2 table

Actor track list information, specified as an actorTracklist object, or a *K*-by-2 table. Each row in the table represents track information relative to its time.

The first column of the table must contain timestamps at which the track information was captured, specified as a positive scalar. Units are in seconds.

The second column of the table must contain track information of non-ego actors, specified as an M -by-1 structure. M is the number of actors. The structure must contain these fields:

Field	Description
TrackID	Track ID of the actor, specified as a numeric scalar, string scalar, or a character vector.
ClassID	Classification identifier of the actor, specified as one of these nonnegative integers: <ul style="list-style-type: none"> • 1 – Car • 2 – Truck • 3 – Bicycle • 4 – Pedestrian • 0 – Others
Position	Position of the actor with respect to the ego frame, specified as a 3-element numeric row vector of the form $[x \ y \ z]$. Units are in meters.

The structure can also contain these optional fields:

Field	Description
Dimension	Dimensions of the actor, specified as a 3-element numeric row vector of the form $[length \ width \ height]$. Units are in meters.
Yaw	Yaw angle of the actor with respect to the ego frame, specified as a scalar. Units are in degrees.
Speed	Speed of the actor with respect to the ego frame, specified as a scalar. Units are in meters per second.
Velocity	Velocity of the actor with respect to the ego frame, specified as a 3-element numeric row vector of the form $[v_x \ v_y \ v_z]$. Units are in meters per second.

The movements of the ego vehicle and non-ego actors must follow the vehicle coordinate system used by Automated Driving Toolbox. For more information on vehicle coordinate system, see “Vehicle Coordinate System”.

egoTrajectory – Ego trajectory information

waypointTrajectory object

Ego trajectory information, specified as a waypointTrajectory object.

ageThreshold – Actor age threshold

2 (default) | positive integer

Actor age threshold, specified as a positive integer. The returned `actorInfo` table excludes the actors with age less than the specified `ageThreshold` value.

Output Arguments

actorInfo – Actor trajectory information

table

Actor trajectory information, returned as a table. The trajectory parameters are in the world coordinate frame. Each row in the table represents the trajectory parameters of an actor.

The table contain these columns.

Column	Description
Age	Age of the actor, returned as a positive integer. This value specifies the number of times the actor has been tracked.
TrackID	Track ID of the actor, returned as a numeric scalar, string scalar, or a character vector.
ClassID	Actor classification identifier, returned as a nonnegative integer. Values are in the range 0 to 4.
EntryTime	Entry time of the actor, returned as a positive scalar. This value specifies the time of first detection of an actor. Units are in seconds.
ExitTime	Exit time of the actor, returned as a positive scalar. This value specifies the time of last detection of an actor. Units are in seconds.
Mesh	Mesh assigned to the actor, returned as an <code>extendedObjectMesh</code> object.
Waypoints	Waypoints of the actor center in the world frame from entry time to exit time, returned as an N -by-3 matrix. N is the number of waypoints. Units are in meters.
Speed	Speeds of the actor in the world frame from entry time to exit time, returned as an N -element column vector. Speed values are relative to the corresponding values of <code>Waypoints</code> . Units are in meters per second.
Yaw	Yaw angles of the actor in the world frame from entry time to exit time, returned as an N -element column vector. Yaw values are relative to the corresponding values of <code>Waypoints</code> . Units are in degrees.
Dimension	Dimensions of the actor, returned as a 3-element numeric row vector of the form <code>[length width height]</code> . Units are in meters. Dependencies This column is optional, and appears in the table only if <code>tracklist</code> contains the dimension information of the actor.

Version History

Introduced in R2022b

R2023a: Specify track list information using actorTracklist object

The actorprops function supports the actorTracklist object to specify the tracklist input. The object provides efficient data structure to store actor track list data with timestamps. You can add or remove data from the object and find track list information nearest to the specified timestamp.

See Also

actorTracklist | selectActorRoads | roadprops | waypointTrajectory

Topics

“Generate Scenario from Actor Track List and GPS Data”

getMapROI

Geographic bounding box coordinates from GPS data

Syntax

```
mapParameters = getMapROI(lat,lon)
mapParameters = getMapROI(lat,lon,Extent=extent)
```

Description

`mapParameters = getMapROI(lat,lon)` computes the geographic bounding box coordinates using latitude and longitude GPS data, and returns the map parameters `mapParameters`.

`mapParameters = getMapROI(lat,lon,Extent=extent)` computes the map parameters with the specified GPS buffer extent.

Note This function requires the Scenario Builder for Automated Driving Toolbox support package. You can install Scenario Builder for Automated Driving Toolbox from the Add-On Explorer. For more information about installing add-ons, see [Get and Manage Add-Ons](#).

Examples

Import OpenStreetMap Road Network Using Map ROI Parameters

Extract map ROI parameters from GPS data. Use the extracted `osmUrl` parameter to import roads from the OpenStreetMap® web service into a driving scenario. Then, plot the scenario.

Load GPS data containing latitude and longitude values into the workspace.

```
load("GPSData.mat")
```

Use the latitude and longitude to fetch the map parameters.

```
mapParameters = getMapROI(gps.lat,gps.lon);
```

Use the `osmUrl` parameter in the `mapParameters` output structure to import and save the OpenStreetMap file.

```
fileName = websave("drive_map.osm",mapParameters.osmUrl, ...
    weboptions(ContentType="xml"));
```

Import the roads from the OpenStreetMap road network file into a driving scenario.

```
scenario = drivingScenario;
roadNetwork(scenario,"OpenStreetMap",fileName)
```

Plot the scenario.

```
plot(scenario)
```

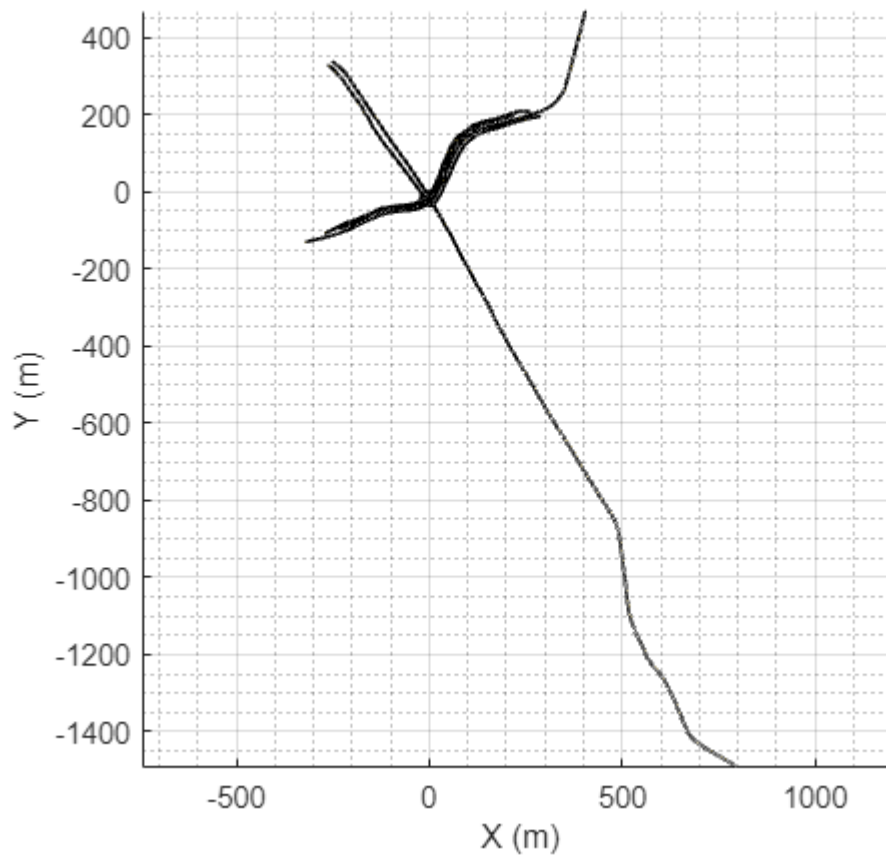

Import OpenStreetMap Road Network Using GPS Data and Extent

Extract map ROI parameters from GPS data by specifying GPS buffer extent. Use the extracted `osmUrl` parameter to import roads from the OpenStreetMap® web service into a driving scenario. Then, plot the scenario.

Load GPS data containing latitude and longitude values into the workspace.

```
load("GPSData.mat")
```

Specify the GPS buffer extent, in meters.

```
gpsBufferExtent = 10;
```

Use the latitude, longitude, and GPS buffer extent to fetch the map parameters.

```
mapParameters = getMapROI(gps.lat,gps.lon,Extent=gpsBufferExtent);
```

Use the `osmUrl` parameter in the `mapParameters` output structure to import and save the OpenStreetMap file.

```
fileName = websave("drive_map.osm",mapParameters.osmUrl, ...  
    weboptions(ContentType="xml"));
```

Import the roads from the OpenStreetMap road network file into a driving scenario.

```
scenario = drivingScenario;  
roadNetwork(scenario, "OpenStreetMap", fileName)
```

Plot the scenario.

```
plot(scenario)
```

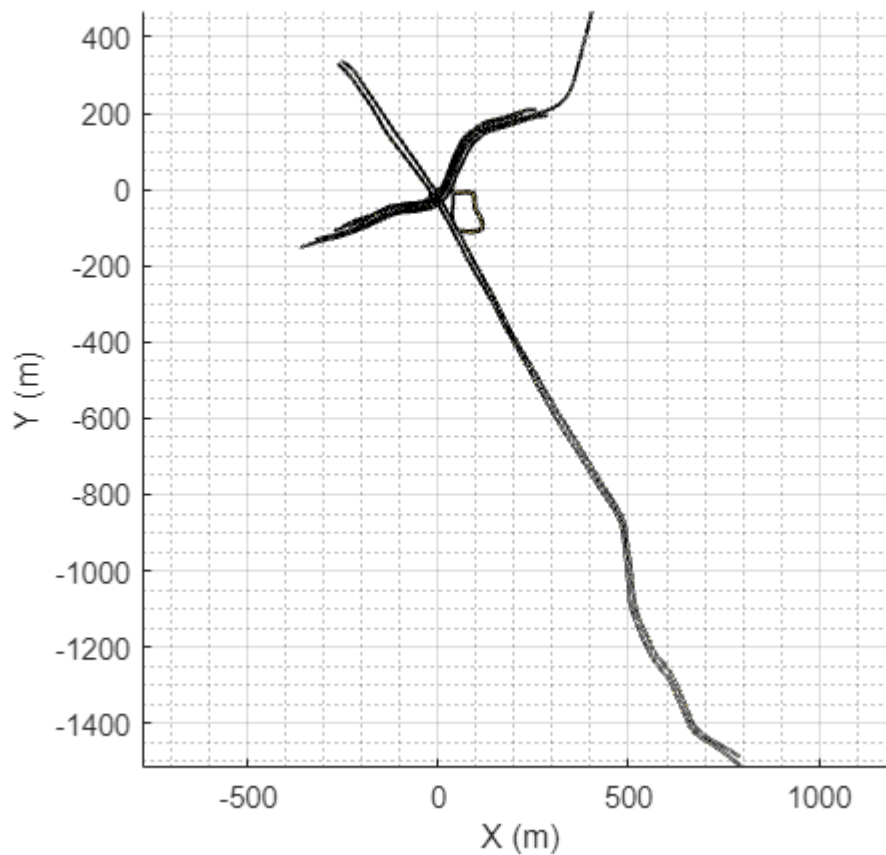

Input Arguments

lat — Latitude coordinates

numeric vector

Latitude coordinates in degrees, specified as a numeric vector. Each value in the vector must be in the range [-90, 90]. `lat` must be the same size as `lon`.

Data Types: `single` | `double`

lon — Longitude coordinates

numeric vector

Longitude coordinates in degrees, specified as a numeric vector. Each value in the vector must be in the range [-180, 180]. `lon` must be the same size as `lat`.

Data Types: `single` | `double`

extent — GPS buffer extent

0 (default) | nonnegative scalar

GPS buffer extent, in meters, specified as a nonnegative scalar. This function extends the rectangular GPS bounding box in all directions by the specified extent value.

Data Types: `single` | `double`

Output Arguments

mapParameters — Map region of interest parameters

structure

Map region of interest (ROI) parameters, returned as a structure.

The structure contains these fields:

Property	Description
<code>bufferInMeters</code>	GPS buffer extent, returned as a nonnegative scalar. Units are in meters.
<code>minLat</code>	Minimum latitude, returned as a scalar. Units are in degrees.
<code>maxLat</code>	Maximum latitude, returned as a scalar. Units are in degrees.
<code>minLon</code>	Minimum longitude, returned as a scalar. Units are in degrees.
<code>maxLon</code>	Maximum longitude, returned as a scalar. Units are in degrees.
<code>georeference</code>	Reference GPS location, returned as a 3-element row vector of the form [<i>latitude longitude altitude</i>]. Latitude and longitude are in degrees, and altitude is in meters.
<code>osmUrl</code>	OpenStreetMap URL, returned as a character vector.
<code>minLatitudeString</code>	Minimum latitude, returned as a character vector. Units are in degrees.
<code>minLongitudeString</code>	Minimum longitude, returned as a character vector. Units are in degrees.
<code>maxLatitudeString</code>	Maximum latitude, returned as a character vector. Units are in degrees.
<code>maxLongitudeString</code>	Maximum longitude, returned as a character vector. Units are in degrees.

The function computes the geographic bounding box coordinates using latitude and longitude GPS data and the specified `extent` value. The minimum and maximum latitude and longitude values in the structure represent a rectangular bounding box. This diagram displays the relationship between these coordinates.

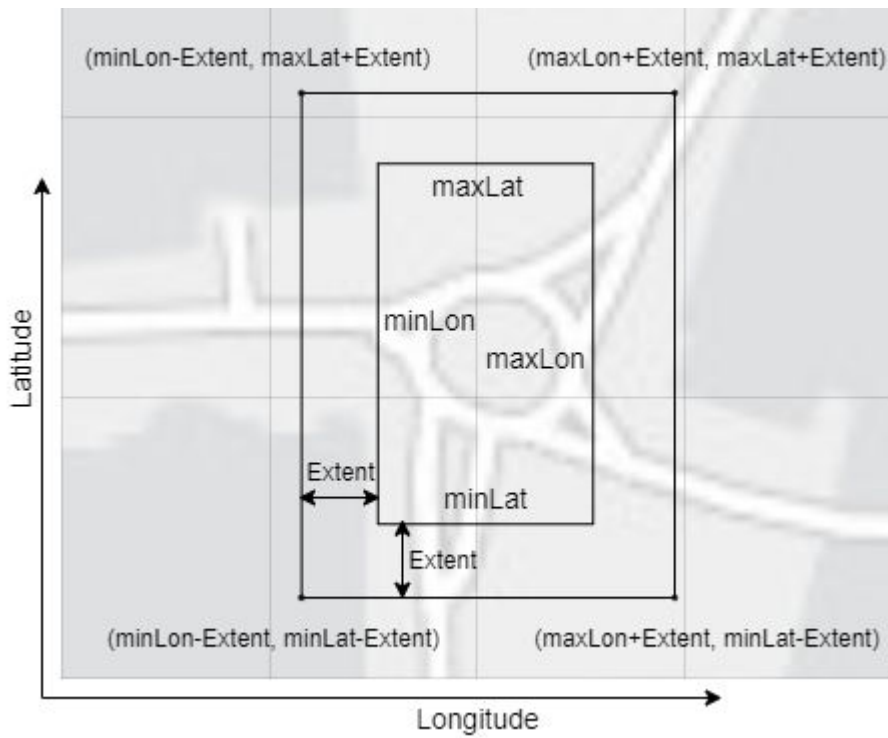

Version History

Introduced in R2022b

See Also

roadprops | latlon2local

getScenario

Get scenario object from scenario descriptor object

Syntax

```
scenario = getScenario(D, Simulator=simulator)
```

Description

`scenario = getScenario(D, Simulator=simulator)` returns a scenario object that supports the specified simulator `simulator` from the given `ScenarioDescriptor` object `D`.

Note This function requires the Scenario Variant Generator for Automated Driving Toolbox support package. You can install Scenario Variant Generator for Automated Driving Toolbox from the Add-On Explorer. For more information about installing add-ons, see [Get and Manage Add-Ons](#).

Examples

Recreate Driving Scenario from scenarioDescriptor Object

Create a driving scenario.

```
scenario = drivingScenario;
```

Add a road segment to the scenario.

```
roadCenters = [41 6; 7 6];
laneSpecification = lanespec([2 2]);
road(scenario, roadCenters, ...
    Lanes=laneSpecification, Name="Road");
```

Create a trajectory by adding an ego vehicle, waypoints, and speed information to the scenario.

```
egoVehicle = vehicle(scenario, ...
    ClassID=1, ...
    Position=[13 4 0], ...
    Mesh=driving.scenario.carMesh, ...
    Name="Car");
waypoints = [13 4 0;
    30 4 0;
    41 4 0];
speed = 30;
trajectory(egoVehicle, waypoints, speed)
```

Create a `scenarioDescriptor` object, and display it.

```
scenarioDescriptor = getScenarioDescriptor(scenario, Simulator="DrivingScenario")
scenarioDescriptor =
    ScenarioDescriptor with properties:
```

```
status: "DescriptorCreated"
```

Recreate the scenario as a `drivingScenario` object.

```
scenarioDS = getScenario(scenarioDescriptor, Simulator="DrivingScenario");
```

Input Arguments

D — Scenario variant descriptor

`ScenarioDescriptor` object

Scenario variant descriptor, specified as a `ScenarioDescriptor` object. The `ScenarioDescriptor` object stores scene, actor, and vehicle information extracted from a seed scenario, and uses this information to generate the scenario variants. You can use these scenario variants to perform safety assessments for various automated driving applications.

simulator — Name of simulator

"DrivingScenario"

Name of simulator, specified as "DrivingScenario". Currently, this function supports only the MATLAB driving scenario simulator.

Data Types: `char` | `string`

Output Arguments

scenario — Scenario for simulator

`drivingScenario` object

Scenario for the simulator, returned as a `drivingScenario` object.

Version History

Introduced in R2022b

See Also

`getScenarioDescriptor` | `drivingScenario`

getScenarioDescriptor

Extract properties from input scenario to generate scenario variants

Syntax

```
D = getScenarioDescriptor(scenario, Simulator=simulator)
```

Description

`D = getScenarioDescriptor(scenario, Simulator=simulator)` extracts the properties of an input scenario and stores these properties in a `ScenarioDescriptor` object, `D`, for scenario variant generation. `simulator` specifies the simulator used by the input scenario `scenario`.

Note This function requires the Scenario Variant Generator for Automated Driving Toolbox support package. You can install Scenario Variant Generator for Automated Driving Toolbox from the Add-On Explorer. For more information about installing add-ons, see [Get and Manage Add-Ons](#).

Examples

Recreate Driving Scenario from scenarioDescriptor Object

Create a driving scenario.

```
scenario = drivingScenario;
```

Add a road segment to the scenario.

```
roadCenters = [41 6; 7 6];
laneSpecification = lanespec([2 2]);
road(scenario, roadCenters, ...
    Lanes=laneSpecification, Name="Road");
```

Create a trajectory by adding an ego vehicle, waypoints, and speed information to the scenario.

```
egoVehicle = vehicle(scenario, ...
    ClassID=1, ...
    Position=[13 4 0], ...
    Mesh=driving.scenario.carMesh, ...
    Name="Car");
waypoints = [13 4 0;
    30 4 0;
    41 4 0];
speed = 30;
trajectory(egoVehicle, waypoints, speed)
```

Create a scenarioDescriptor object, and display it.

```
scenarioDescriptor = getScenarioDescriptor(scenario, Simulator="DrivingScenario")
scenarioDescriptor =
    ScenarioDescriptor with properties:
```

```
status: "DescriptorCreated"
```

Recreate the scenario as a `drivingScenario` object.

```
scenarioDS = getScenario(scenarioDescriptor, Simulator="DrivingScenario");
```

Input Arguments

scenario — Seed scenario

`drivingScenario` object

Seed scenario, specified as a `drivingScenario` object.

simulator — Simulator name of seed scenario

"DrivingScenario"

Simulator name of the seed scenario, specified as "DrivingScenario". Currently, this function supports only the MATLAB driving scenario simulator.

Data Types: `char` | `string`

Output Arguments

D — Scenario descriptor

`ScenarioDescriptor` object

Scenario descriptor, returned as a `ScenarioDescriptor` object. The `status` property of the descriptor object `D` indicates "DescriptorCreated" whether the object has been successfully created.

The `ScenarioDescriptor` object stores scene, actor, and vehicle information extracted from a seed scenario. You can use these scene information to generate scenario variants to perform safety assessments for various automated driving applications.

Tips

- To get a scenario from a `ScenarioDescriptor` object, use the `getScenario` function.

Version History

Introduced in R2022b

See Also

`getScenario` | `drivingScenario`

roadprops

Extract road properties from road network file or map data

Syntax

```
roadProperties = roadprops(OpenDrive=filename)
```

```
[roadProperties,geoReference] = roadprops(OpenStreetMap=filename)
```

```
[roadProperties,geoReference] = roadprops("HEREHDLiveMap",lat,lon)
[roadProperties,geoReference] = roadprops("HEREHDLiveMap",minLat,minLon,
maxLat,maxLon)
```

```
[roadProperties,geoReference] = roadprops("ZenrinJapanMap",lat,lon)
[roadProperties,geoReference] = roadprops("ZenrinJapanMap",minLat,minLon,
maxLat,maxLon)
```

Description

OpenDRIVE

`roadProperties = roadprops(OpenDrive=filename)` extracts road properties from an ASAM OpenDRIVE road network file. This function supports importing road networks from OpenDRIVE file versions 1.4 and 1.5, as well as ASAM OpenDRIVE file version 1.6.

OpenStreetMap

`[roadProperties,geoReference] = roadprops(OpenStreetMap=filename)` extracts road properties and the geographic reference coordinates of a road network from an OpenStreetMap road network file.

HERE HD Live Map

`[roadProperties,geoReference] = roadprops("HEREHDLiveMap",lat,lon)` extracts road properties from a HERE HD Live Map⁵ (HDLM) web service. The function extracts properties of the roads that are nearest to the latitude and longitude coordinates specified in `lat` and `lon`, respectively.

`[roadProperties,geoReference] = roadprops("HEREHDLiveMap",minLat,minLon,maxLat,maxLon)` extracts road properties for HERE HDLM roads that are at least partially within a geographic bounding box specified by minimum and maximum latitude and longitude.

Zenrin Japan Map API 3.0 (Itsumo NAVI API 3.0)

`[roadProperties,geoReference] = roadprops("ZenrinJapanMap",lat,lon)` extracts road parameters from a Zenrin Japan Map API 3.0 (Itsumo NAVI API 3.0)⁶ web service. The function extracts the properties of the roads that are nearest to the latitude and longitude coordinates specified in `lat` and `lon`, respectively.

5 You need to enter into a separate agreement with HERE in order to gain access to the HDLM services and to get the required credentials (`access_key_id` and `access_key_secret`) for using the HERE Service.

6 To gain access to the Zenrin Japan Map API 3.0 (Itsumo NAVI API 3.0) service and get the required credentials (a client ID and secret key), you must enter into a separate agreement with ZENRIN DataCom CO., LTD.

Importing roads from the Zenrin Japan Map API 3.0 (Itsumo NAVI API 3.0) service requires Automated Driving Toolbox Importer for Zenrin Japan Map API 3.0 (Itsumo NAVI API 3.0) Service.

`[roadProperties,geoReference] = roadprops("ZenrinJapanMap",minLat,minLon,maxLat,maxLon)` extracts Zenrin Japan Map API 3.0 (Itsumo NAVI API 3.0) roads that are at least partially within a geographic bounding box specified by minimum and maximum latitude and longitude.

Note This function requires the Scenario Builder for Automated Driving Toolbox support package. You can install Scenario Builder for Automated Driving Toolbox from the Add-On Explorer. For more information about installing add-ons, see [Get and Manage Add-Ons](#).

Examples

Extract Road Properties from OpenStreetMap Road Network

Load latitude and longitude coordinates into the workspace.

```
data = load("geoSequence.mat");
```

Use the `osmUrl` parameter in the `mapParameters` output structure to import and save the OpenStreetMap file.

```
mapParameters = getMapROI(data.latitude,data.longitude);
websave("geoSequence.osm",mapParameters.osmUrl,weboptions(ContentType="xml"));
```

Extract road properties from the OpenStreetMap file.

```
[roadProperties,geoReference] = roadprops(OpenStreetMap="geoSequence.osm");
```

Display the road properties.

```
disp(roadProperties)
```

RoadID	JunctionID	RoadName	RoadCenters	RoadWidth	BankAngle
1	0	"Acorn Lane"	{ 4×3 double}	7.35	{ 4×1 double}
2	0	"North San Antonio Road"	{ 4×3 double}	3.75	{ 4×1 double}
3	0	"North San Antonio Road"	{ 5×3 double}	3.75	{ 5×1 double}
4	0	"North San Antonio Road"	{ 5×3 double}	3.75	{ 5×1 double}
5	0	"791582878"	{10×3 double}	7.35	{10×1 double}

Extract Road Properties from HERE HD Live Map Road Network

Load latitude and longitude coordinates into the workspace.

```
data = load("geoSequence.mat");
```

Extract the properties of the roads from the HERE HD Live Map road network that matches the specified coordinates.

```
[roadProperties,geoReference] = roadprops("HEREHDLiveMap",data.latitude,data.longitude);
```

Display the first five entries of the road properties table.

```
disp(roadProperties(1:5,:));
```

RoadID	JunctionID	RoadName	RoadCenters	RoadWidth	BankAngle
1	0	"309106790_407373157"	{2×3 double}	{[12.0642]}	{2×1 double}
2	0	"309106790_410591167"	{3×3 double}	{[12.0636]}	{3×1 double}
3	0	"309106790_410591168"	{2×3 double}	{[8.1744]}	{2×1 double}
4	0	"309106790_410591169"	{2×3 double}	{[12.0579]}	{2×1 double}
5	0	"309106790_410591172"	{2×3 double}	{[12.0654]}	{2×1 double}

Extract Road Properties from ASAM OpenDRIVE Road Network

Extract road properties from an ASAM OpenDRIVE road network file.

```
roadProperties = roadprops("OpenDRIVE","roundabout.xodr");
```

Display the first six entries of the road properties table.

```
disp(roadProperties(1:6,:));
```

RoadID	JunctionID	RoadName	RoadCenters	RoadWidth	BankAngle
1	0	""	{18×3 double}	{[13.4200]}	{18×1 double}
2	0	""	{ 5×3 double}	{[13.4200]}	{ 5×1 double}
3	0	""	{13×3 double}	{[13.4200]}	{13×1 double}
4	0	""	{ 7×3 double}	{[13.4200]}	{ 7×1 double}
5	0	""	{ 8×3 double}	{[13.4200]}	{ 8×1 double}
6	0	""	{ 5×3 double}	{[13.4200 13.4200]}	{ 5×1 double}

Input Arguments

filename — Name of road network file

character vector | string scalar

Name of the road network file, specified as a character vector or string scalar.

filename must specify a file in the current folder, a file that is on the MATLAB search path, or a full or relative path to a file.

filename must end with a file extension that is valid for the source of the road network.

Road Network Source	Valid File Extensions	Sample Syntax
OpenDRIVE	.xodr .xml	roadprops(OpenDRIVE="C:\Desktop\roads.x

Road Network Source	Valid File Extensions	Sample Syntax
OpenStreetMap	.osm .xml	roadprops(OpenStreetMap="C:\Desktop\map

lat — Latitude coordinates

vector of elements in range [-90, 90]

Latitude coordinates, specified as a vector of elements in the range [-90, 90]. `lat` must be the same size as `lon`. Units are in degrees.

lon — Longitude coordinates

vector of elements in range [-180, 180]

Longitude coordinates, specified as a vector of elements in the range [-180, 180]. `lon` must be the same size as `lat`. Units are in degrees.

minLat — Minimum latitude coordinate of bounding box

scalar in range [-90, 90]

Minimum latitude coordinate of the bounding box, specified as a scalar in the range [-90, 90]. `minLat` must be less than `maxLat`. Units are in degrees.

minLon — Minimum longitude coordinate of bounding box

scalar in range [-180, 180]

Minimum longitude coordinate of the bounding box, specified as a scalar in the range [-180, 180]. `minLon` must be less than `maxLon`. Units are in degrees.

maxLat — Maximum latitude coordinate of bounding box

scalar in range [-90, 90]

Maximum latitude coordinate of the bounding box, specified as a scalar in the range [-90, 90]. `maxLat` must be greater than `minLat`. Units are in degrees.

maxLon — Maximum longitude coordinate of bounding box

scalar in range [-180, 180]

Maximum longitude coordinate of the bounding box, specified as a scalar in the range [-180, 180]. `maxLon` must be greater than `minLon`. Units are in degrees.

Output Arguments**roadProperties — Road properties**

table

Road properties, returned as a table. The table contains these columns.

Column	Description
RoadID	Identifier of road, returned as a positive integer.
JunctionID	Identifier of junction, returned as a positive integer.

Column	Description
RoadName	Name of road, returned as a character vector.
RoadCenters	Road centers used to define a road, returned as a real-valued N -by-3 matrix. N is the number of road centers.
RoadWidth	Width of road, returned as a positive real scalar. Units are in meters.
BankAngle	Banking angle of road, returned as an N -by-1 real-valued vector. N is the number of road centers. Units are in degrees.
Heading	Heading angle of road, returned as an N -by-1 real-valued vector in the range of $[-180, 180]$. N is the number of road centers. Units are in degrees.
Lanes	Lane information, returned as a <code>lanespec</code> or <code>compositeLaneSpec</code> object. This object holds this lane information: <ul style="list-style-type: none"> • Number of lanes • Width of each lane • Type of lane markings
LeftBoundary	Left boundaries of the road segment, returned as an M -by-3 matrix. M is the number of road boundary points.
RightBoundary	Right boundaries of the road segment, returned as an M -by-3 matrix. M is the number of road boundary points.

geoReference — Geographic reference coordinates

three-element row vector

Geographic reference coordinates of the road network origin, returned as a three-element row vector of the form $[latitude\ longitude\ altitude]$. Latitude and longitude are in degrees, and altitude is in meters.

Note OpenDRIVE file do not contain geographic reference coordinates.

Version History

Introduced in R2022b

See Also

`selectActorRoads` | `updateLaneSpec` | `getMapROI` | `actorprops`

selectActorRoads

Extract properties of roads in path of actor

Syntax

```
actorRoadProperties = selectActorRoads(roadProperties,waypoints)
actorRoadProperties = selectActorRoads( ____,Name=Value)
```

Description

`actorRoadProperties = selectActorRoads(roadProperties,waypoints)` extracts properties of roads in the path of an actor, `actorRoadProperties`, from the input road properties `roadProperties`, which contains road information for a road network. `waypoints` specifies the position of the actor at each waypoint.

`actorRoadProperties = selectActorRoads(____,Name=Value)` specifies options using name-value arguments in addition to the input arguments from the previous syntax. For example, `MaxDistance=2` specifies the maximum distance from a waypoint to a road boundary as 2 meters.

Note This function requires the Scenario Builder for Automated Driving Toolbox support package. You can install Scenario Builder for Automated Driving Toolbox from the Add-On Explorer. For more information about installing add-ons, see [Get and Manage Add-Ons](#).

Examples

Extract Actor Road Segments Using Waypoints

Specify geographic coordinates to create waypoints for an actor.

```
lat = linspace(42.300742,42.301988,50);
lon = linspace(-71.352551,-71.345491,50);
alt = zeros(1,50);
```

Use latitude and longitude to fetch the map parameters for the corresponding region.

```
mapParameters = getMapROI(lat,lon);
```

Use the `osmUrl` parameter in the `mapParameters` output structure to import and save the OpenStreetMap file.

```
filename = websave("drive_map.osm",mapParameters.osmUrl, ...
    weboptions('ContentType','xml'));
```

Get the road network properties from the map.

```
[roadProperties,geoReference] = roadprops("OpenStreetMap",filename);
```

Convert the geographic coordinates to local Cartesian coordinates, and create waypoints.

```
[xEast,yNorth,zUp] = latlon2local(lat,lon,alt,geoReference);
waypoints = [xEast; yNorth; zUp]';
```

Extract and display the actor road properties.

```
actorRoadProperties = selectActorRoads(roadProperties,waypoints)
```

```
actorRoadProperties=18x10 table
```

RoadID	JunctionID	RoadName	RoadCenters	RoadWidth	BankAngle
3	0	"Wheeler Lane"	{14x3 double}	7.35	{14x1 double}
11	0	"Worcester Street"	{44x3 double}	3.75	{41x1 double}
24	0	"567740618"	{18x3 double}	7.35	{18x1 double}
25	0	"567740619"	{ 5x3 double}	3.75	{ 5x1 double}
26	0	"567740619"	{ 5x3 double}	3.75	{ 5x1 double}
28	0	"567741165"	{ 2x3 double}	7.35	{ 2x1 double}
29	0	"567741168"	{51x3 double}	7.35	{10x1 double}
30	0	"567741168"	{13x3 double}	7.35	{13x1 double}
34	0	"567741798"	{19x3 double}	7.35	{19x1 double}
35	0	"567741799"	{ 4x3 double}	7.35	{ 4x1 double}
36	0	"567741799"	{ 7x3 double}	7.35	{ 7x1 double}
37	0	"567741799"	{ 3x3 double}	7.35	{ 3x1 double}
39	0	"567741801"	{ 3x3 double}	7.35	{ 3x1 double}
41	0	"567741801"	{ 3x3 double}	7.35	{ 3x1 double}
55	0	"Worcester Street"	{ 2x3 double}	3.75	{ 2x1 double}
56	0	"Worcester Street"	{ 3x3 double}	3.75	{ 3x1 double}
:					

Extract Road-Name-Specific Actor Road Properties

Specify geographic coordinates to create waypoints for an actor.

```
lat = linspace(42.300742,42.301688,50);
lon = linspace(-71.352551,-71.345491,50);
alt = zeros(1,50);
```

Use latitude and longitude to fetch the map parameters for the corresponding region.

```
mapParameters = getMapROI(lat,lon);
```

Use the `osmUrl` parameter in the `mapParameters` output structure to import and save the `OpenStreetMap` file.

```
filename = websave("drive_map.osm",mapParameters.osmUrl, ...
    weboptions(ContentType="xml"));
```

Get the road network properties from the map.

```
[roadProperties,geoReference] = roadprops("OpenStreetMap",filename);
```

Convert the geographic coordinates to local Cartesian coordinates, and create waypoints.

```
[xEast,yNorth,zUp] = latlon2local(lat,lon,alt,geoReference);
waypoints = [xEast; yNorth; zUp]';
```

Extract and display the actor road properties.

```
actorRoadProperties = selectActorRoads(roadProperties,waypoints, ...
    RoadNames="Worcester Street")
```

actorRoadProperties=4×10 table

RoadID	JunctionID	RoadName	RoadCenters	RoadWidth	BankAngle
7	0	"Worcester Street"	{44×3 double}	3.75	{41×1 double}
8	0	"Worcester Street"	{ 2×3 double}	3.75	{ 2×1 double}
9	0	"Worcester Street"	{ 2×3 double}	3.75	{ 2×1 double}
10	0	"Worcester Street"	{30×3 double}	3.75	{34×1 double}

Input Arguments

roadProperties — Road properties

table

Road properties of a road network, specified as a table. The table must contain these columns.

Column	Description
RoadID	Identifier of road, specified as a positive integer.
JunctionID	Identifier of junction, specified as a positive integer.
RoadName	Name of road, specified as a character vector.
RoadCenters	Road centers used to define a road, specified as a real-valued N -by-3 matrix, where N is the number of road centers.
RoadWidth	Width of road in meters, specified as a positive real scalar.
LeftBoundary	Left boundaries of the road segment, specified as an M -by-3 matrix. M is the number of road boundary points.
RightBoundary	Right boundaries of the road segment, specified as an M -by-3 matrix. M is the number of road boundary points.

waypoints — Actor positions in navigation coordinate system

P -by-3 matrix

Actor positions in the navigation coordinate system, in meters, specified as a P -by-3 matrix. P is the number of waypoints. Each waypoint represents the position of the actor in the form $[x\ y\ z]$.

Name-Value Pair Arguments

Specify optional pairs of arguments as Name1=Value1, ..., NameN=ValueN, where Name is the argument name and Value is the corresponding value. Name-value arguments must appear after other arguments, but the order of the pairs does not matter.

Example: `selectActorRoads(roadProperties,waypoints,MaxDistance=2)` specifies the maximum distance from a waypoint to a road boundary as 2 meters.

MaxDistance — Maximum Euclidean distance from waypoint to road boundary

5 (default) | nonnegative scalar

Maximum Euclidean distance from a waypoint to a road boundary, in meters, specified as a nonnegative scalar. Roads with boundaries at a distance greater than `MaxDistance` from each waypoint are excluded in the returned `actorRoadProperties` table.

Data Types: `single` | `double`

RoadNames — Name of roads in path of actor

character vector | string scalar | string array | cell array of character vectors

Name of the roads in the path of an actor, specified as a character vector, string scalar, string array, or cell array of character vectors.

By default, the function returns the properties of all the roads in the path of the actor. If you specify this argument, the function extracts only the roads in the path of the actor that are specified in `RoadNames`.

To use this name-value argument, you must know the names of the roads beforehand.

Note Road names are generally present only for road networks extracted using an OpenStreetMap road network file.

Data Types: `string` | `char` | `cell`

Output Arguments

actorRoadProperties — Actor road properties

table

Actor road properties, returned as a table. The table contains the properties of the roads near the specified actor waypoints. This table has the same columns as the `roadProperties` table.

Version History

Introduced in R2022b

See Also

`roadprops`

getCollisionData

Get collision information of colliding actors

Syntax

```
collisionInfo = getCollisionData(D)  
collisionInfo = getCollisionData(D,Name=Value)
```

Description

`collisionInfo = getCollisionData(D)` returns collision information for all possible pairs of colliding actors in the specified scenario `D`.

`collisionInfo = getCollisionData(D,Name=Value)` specifies options using one or more name-value arguments. For example, `Actor1ID=2` checks for collision between the actor with the ID 2, and all other actors in the scenario.

Note This function requires the Scenario Variant Generator for Automated Driving Toolbox support package. You can install Scenario Variant Generator for Automated Driving Toolbox from the Add-On Explorer. For more information about installing add-ons, see [Get and Manage Add-Ons](#).

Examples

Extract Collision Information From Scenario

Load a driving scenario containing actor collision into the workspace.

```
load("scenarioWithSingleCollision.mat")
```

Create a `scenarioDescriptor` object using the loaded driving scenario `scenario`.

```
scenarioDescriptor = getScenarioDescriptor(scenario, Simulator="DrivingScenario");
```

Extract collision information from the `scenarioDescriptor` object.

```
collisionsInScenario = getCollisionData(scenarioDescriptor);
```

Display the extracted collision information.

```
disp(collisionsInScenario.Collision)
```

```
Collision with properties:  
  
    Time: 0.4981  
    Point: [28.4345 4.0853]  
    Actor1Info: [1x1 struct]  
    Actor2Info: [1x1 struct]
```

Extract Collision Information From Scenario with Multiple Collisions

Load a driving scenario containing multiple actor collisions into the workspace.

```
load("scenarioWithMultipleCollisions.mat")
```

Create a scenarioDescriptor object using the loaded driving scenario scenario.

```
scenarioDescriptor = getScenarioDescriptor(scenario, Simulator="DrivingScenario");
```

Extract collision information from the scenarioDescriptor object.

```
collisionsInScenario = getCollisionData(scenarioDescriptor);
```

Display the extracted information of first collision.

```
disp(collisionsInScenario(1).Collision)
```

```
Collision with properties:
```

```
    Time: 3.0102
    Point: [30.5809 -1.0907]
    Actor1Info: [1x1 struct]
    Actor2Info: [1x1 struct]
```

Display the extracted information of second collision.

```
disp(collisionsInScenario(2).Collision)
```

```
Collision with properties:
```

```
    Time: 1.6756
    Point: [1.1088 -1.1493]
    Actor1Info: [1x1 struct]
    Actor2Info: [1x1 struct]
```

Input Arguments

D — Scenario variant descriptor

ScenarioDescriptor object

Scenario variant descriptor, specified as a ScenarioDescriptor object. The ScenarioDescriptor object stores scene, actor, and vehicle information extracted from a seed scenario, and uses this information to generate the scenario variants. You can use these scenario variants to perform safety assessments for various automated driving applications.

Name-Value Pair Arguments

Specify optional pairs of arguments as Name1=Value1, . . . , NameN=ValueN, where Name is the argument name and Value is the corresponding value. Name-value arguments must appear after other arguments, but the order of the pairs does not matter.

Example: getCollisionData(D, Actor1ID=[2 3], Actor2ID=[5 6]) checks for collisions of all possible pairs of the actors with IDs 2 and 3 and those with IDs 5 and 6.

Actor1ID — First actor ID

positive integer | row vector of positive integer

First actor ID, specified as a positive integer or a row vector of positive integers.

If you do not specify Actor2ID, the function checks for collision between each actor specified by Actor1ID and all other actors in the scenario.

If you specify Actor2ID, the function checks collision for all possible pairs between the actors specified by Actor1ID and those specified by Actor2ID.

Data Types: `single` | `double` | `uint8`

Actor2ID — Second actor ID

positive integer | row vector of positive integer

Second actor ID, specified as a positive integer or a row vector of positive integers.

If you do not specify Actor1ID, the function checks for collision between each actor specified by Actor2ID and all other actors in the scenario.

If you specify Actor1ID, the function checks collision for all possible pairs between the actors specified by Actor2ID and those specified by Actor1ID.

Data Types: `single` | `double` | `uint8`

Output Arguments

collisionInfo — Collision information between pairs of colliding actors

array of structures | []

Collision information between pairs of colliding actors, returned as an array of structures. Each structure in the array contains these fields:

- **Actor1ID** — ID of the first colliding actor in the pair, returned as a positive integer.
- **Actor2ID** — ID of the second colliding actor in the pair, returned as a positive integer.
- **Collision** — Collision information, returned as a `collision` object. The `collision` object has these properties:

Property	Description
Time	Simulation time at which collision occurs. Units are in seconds.
Point	Coordinates of the collision point in the world frame. Units are in meters
Actor1Info	Information about the first actor in the collision pair, returned as a structure.
Actor2Info	Information about the second actor in the collision pair, returned as a structure.

Each Actor1Info and Actor2Info structure contains these fields:

Field	Description
ID	ID of the corresponding actor, returned as a positive integer.
Position	Position of the actor at the time of collision, returned as a three-element numeric row vector of the form [<i>latitude longitude altitude</i>]. Units are in meters.
Speed	Speed of the actor at the time of collision, returned as a scalar. Units are in meters per second.
CollisionFraction	Point of collision relative to the collision side of the actor, returned as a fraction in the range [0, 1]. For more information, see “Collision Fraction” on page 3-275.
CollisionSide	Side of the actor at which collision occurs, returned as Front, Left, Back, or Right.

Note If the input scenario contains no collisions, or no collisions between the specified pairs of actors Actor1ID and Actor2ID, the function returns collisionInfo as an empty array, [].

More About

Collision Fraction

The collision fraction specifies the relative position on the collision side of a vehicle at which the collision occurs. For example, if the center of the front edge of the ego vehicle Actor-1 collides with the left corner on the front edge of the target vehicle Actor-2, then the collision fraction of Actor-1 is 0.5.

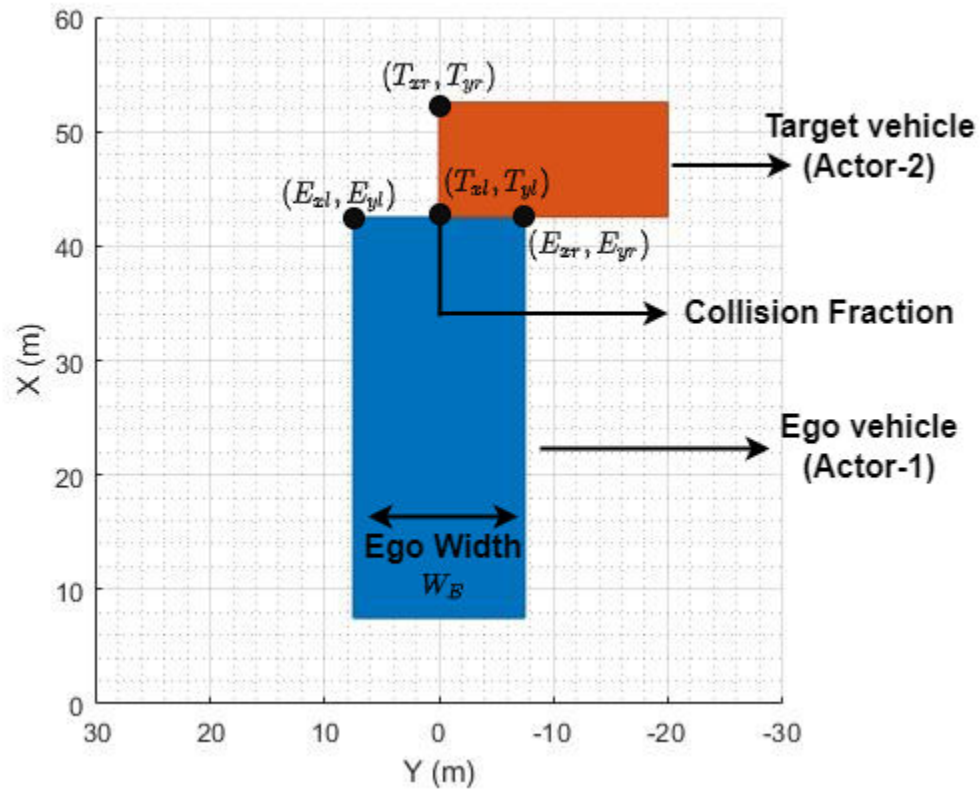

Collision fraction is defined by the equation

$$CF = \frac{|E_{xl} - T_{xl}| + |E_{yt} - T_{yt}|}{W_E},$$

where E_{xl} and E_{yt} are the x- and y-coordinates of the left corner of the ego vehicle collision side, T_{xl} and T_{yt} are the x- and y-coordinates of the collision point on the target vehicle, and W_E is the width of the collision side of the ego vehicle.

Version History

Introduced in R2023a

See Also

`getScenario` | `getScenarioDescriptor`

Objects

birdsEyePlot

Plot detections, tracks, and sensor coverages around vehicle

Description

The `birdsEyePlot` object displays a bird's-eye plot of a 2-D driving scenario in the immediate vicinity of an ego vehicle. You can use this plot with sensors capable of detecting objects and lanes.

To display aspects of a driving scenario on a bird's-eye plot:

- 1 Create a `birdsEyePlot` object.
- 2 Create plotters for the aspects of the driving scenario that you want to plot.
- 3 Use the plotters with their corresponding plot functions to display those aspects on the bird's-eye plot.

This table shows the plotter functions to use based on the driving scenario aspect that you want to plot.

Driving Scenario Aspect to Plot	Plotter Creation Function	Plotter Display Function
Sensor coverage areas	<code>coverageAreaPlotter</code>	<code>plotCoverageArea</code>
Sensor detections	<code>detectionPlotter</code> , <code>rangeDetectionPlotter</code>	<code>plotDetection</code> , <code>plotRangeDetection</code>
Lane boundaries	<code>laneBoundaryPlotter</code>	<code>plotLaneBoundary</code>
Lane markings	<code>laneMarkingPlotter</code>	<code>plotLaneMarking</code> , <code>plotParkingLaneMarking</code>
Object meshes	<code>meshPlotter</code>	<code>plotMesh</code>
Object outlines	<code>outlinePlotter</code>	<code>plotOutline</code> , <code>plotBarrierOutline</code>
Ego vehicle path	<code>pathPlotter</code>	<code>plotPath</code>
Point cloud	<code>pointCloudPlotter</code>	<code>plotPointCloud</code>
Object tracking results	<code>trackPlotter</code>	<code>plotTrack</code>

For an example of how to configure and use a bird's-eye plot, see “Visualize Sensor Coverage, Detections, and Tracks”.

Creation

Syntax

```
bep = birdsEyePlot
bep = birdsEyePlot(Name, Value)
```

Description

`bep = birdsEyePlot` creates a bird's-eye plot in a new figure.

`bep = birdsEyePlot(Name,Value)` sets properties on page 4-3 using one or more `Name,Value` pair arguments. For example, `birdsEyePlot('XLimits',[0 60],'YLimits',[-20 20])` displays the area that is 60 meters in front of the ego vehicle and 20 meters to either side of the ego vehicle. Enclose each property name in quotes.

Properties

Parent — Axes on which to plot

axes handle

Axes on which to plot, specified as an axes handle. By default, the `birdsEyePlot` object uses the current axes handle, which is returned by the `gca` function.

Plotters — Plotters created for bird's-eye plot

array of plotter objects

Plotters created for the bird's-eye plot, specified as an array of plotter objects.

XLimits — X-axis range

real-valued vector of the form $[X_{\min} X_{\max}]$

X-axis range of the bird's-eye plot, in vehicle coordinates, specified as a real-valued vector of the form $[X_{\min} X_{\max}]$. Units are in meters. If you do not specify `XLimits`, then the plot uses the default values for the parent axes.

The X-axis is vertical and positive in the forward direction of the ego vehicle. The origin is at the center of the rear axle of the ego vehicle.

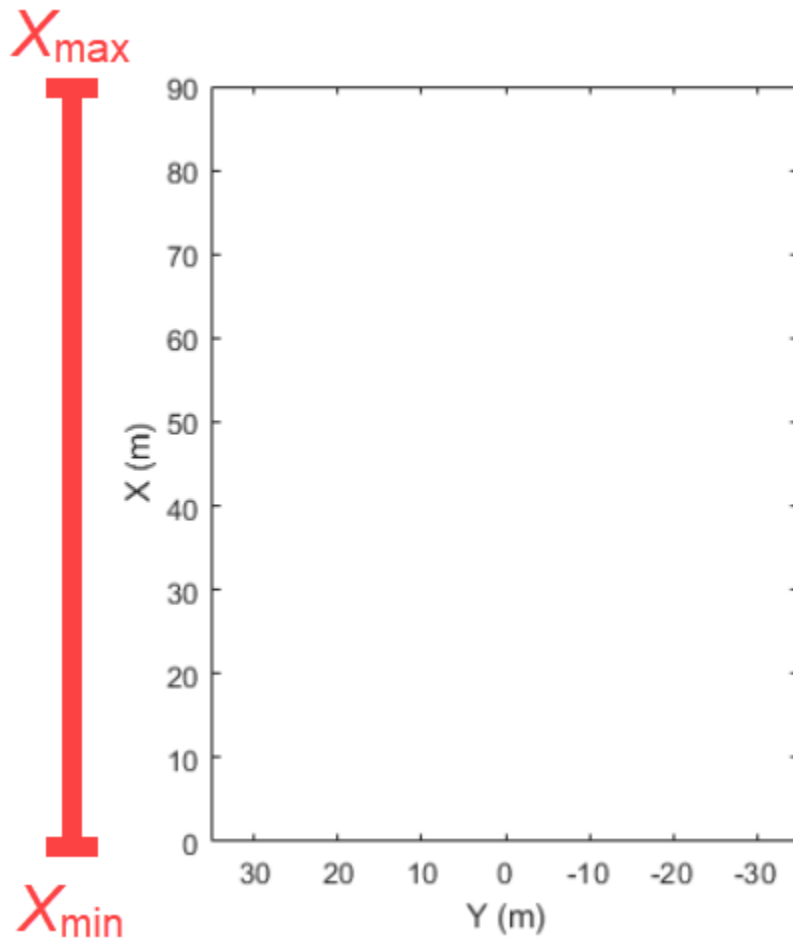

For more details on the coordinate system used in the bird's-eye plot, see “Vehicle Coordinate System” on page 4-12.

YLimits – Y-axis range

real-valued vector of the form $[Y_{\min} Y_{\max}]$

Y-axis range of the bird's-eye plot, in vehicle coordinates, specified as a real-valued vector of the form $[Y_{\min} Y_{\max}]$. Units are in meters. If you do not specify `YLimits`, then the plot uses the default values for the parent axes.

The Y-axis runs horizontally and is positive to the left of the ego vehicle, as viewed when facing forward. The origin is at the center of the rear axle of the ego vehicle.

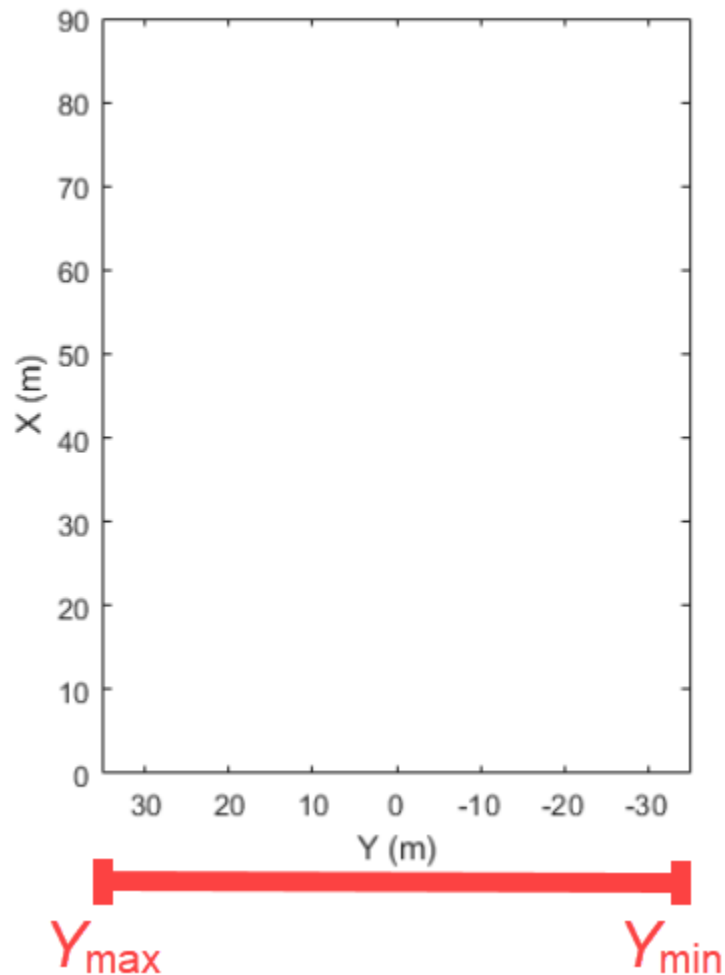

For more details on the coordinate system used in the `birdsEyePlot` object, see “Vehicle Coordinate System” on page 4-12.

Object Functions

Plotter Creation

<code>coverageAreaPlotter</code>	Coverage area plotter for bird's-eye plot
<code>detectionPlotter</code>	Detection plotter for bird's-eye plot
<code>laneBoundaryPlotter</code>	Lane boundary plotter for bird's-eye plot
<code>laneMarkingPlotter</code>	Lane marking plotter for bird's-eye plot
<code>meshPlotter</code>	Mesh plotter for bird's-eye plot
<code>outlinePlotter</code>	Outline plotter for bird's-eye plot
<code>pathPlotter</code>	Path plotter for bird's-eye plot
<code>pointCloudPlotter</code>	Point cloud plotter for bird's-eye plot
<code>trackPlotter</code>	Track plotter for bird's-eye plot

Plotter Display

plotCoverageArea	Display sensor coverage area on bird's-eye plot
plotDetection	Display object detections on bird's-eye plot
plotLaneBoundary	Display lane boundaries on bird's-eye plot
plotLaneMarking	Display lane markings on bird's-eye plot
plotParkingLaneMarking	Display parking lane markings on bird's-eye plot
plotMesh	Display object meshes on bird's-eye plot
plotOutline	Display object outlines on bird's-eye plot
plotPath	Display actor paths on bird's-eye plot
plotPointCloud	Display generated point cloud on bird's-eye plot
plotTrack	Display object tracks on bird's-eye plot

Plotter Utilities

clearData	Clear data from specific plotter of bird's-eye plot
clearPlotterData	Clear data from bird's-eye plot
findPlotter	Find plotters associated with bird's-eye plot

Examples

Create and Display a Bird's-Eye Plot

Create a bird's-eye plot with an x-axis range from 0 to 90 meters and a y-axis range from -35 to 35 meters.

```
bep = birdsEyePlot('XLim',[0 90],'YLim',[-35 35]);
```

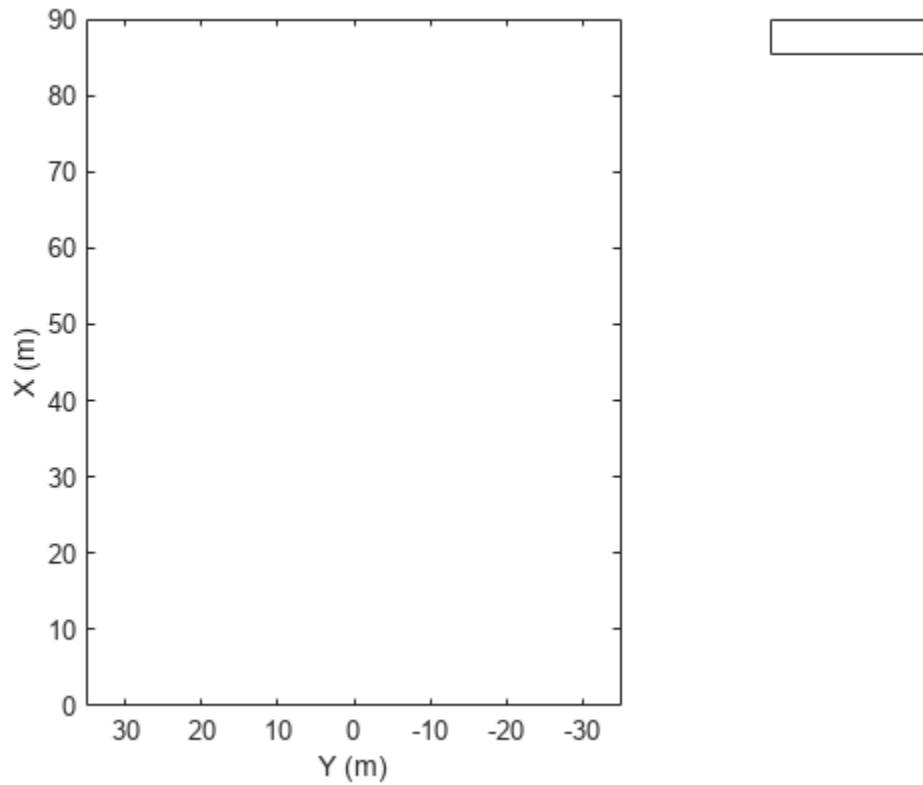
Display a coverage area with a 35-degree field of view and a 60-meter range.

```
caPlotter = coverageAreaPlotter(bep, 'DisplayName', 'Radar coverage area');  
mountPosition = [1 0];  
range = 60;  
orientation = 0;  
fieldOfView = 35;  
plotCoverageArea(caPlotter, mountPosition, range, orientation, fieldOfView);
```

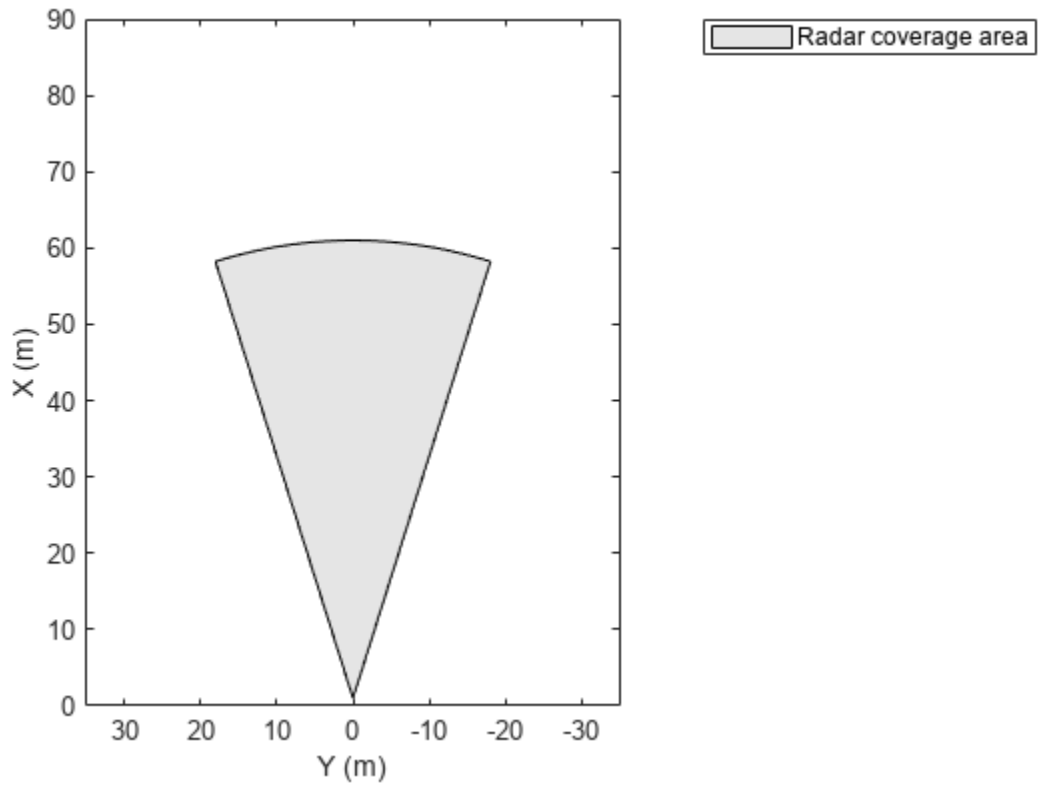

Display radar detections with coordinates at (30, -5), (50, -10), and (40, 7).

```
radarPlotter = detectionPlotter(bep, 'DisplayName', 'Radar detections');  
plotDetection(radarPlotter, [30 -5; 50 -10; 40 7]);
```

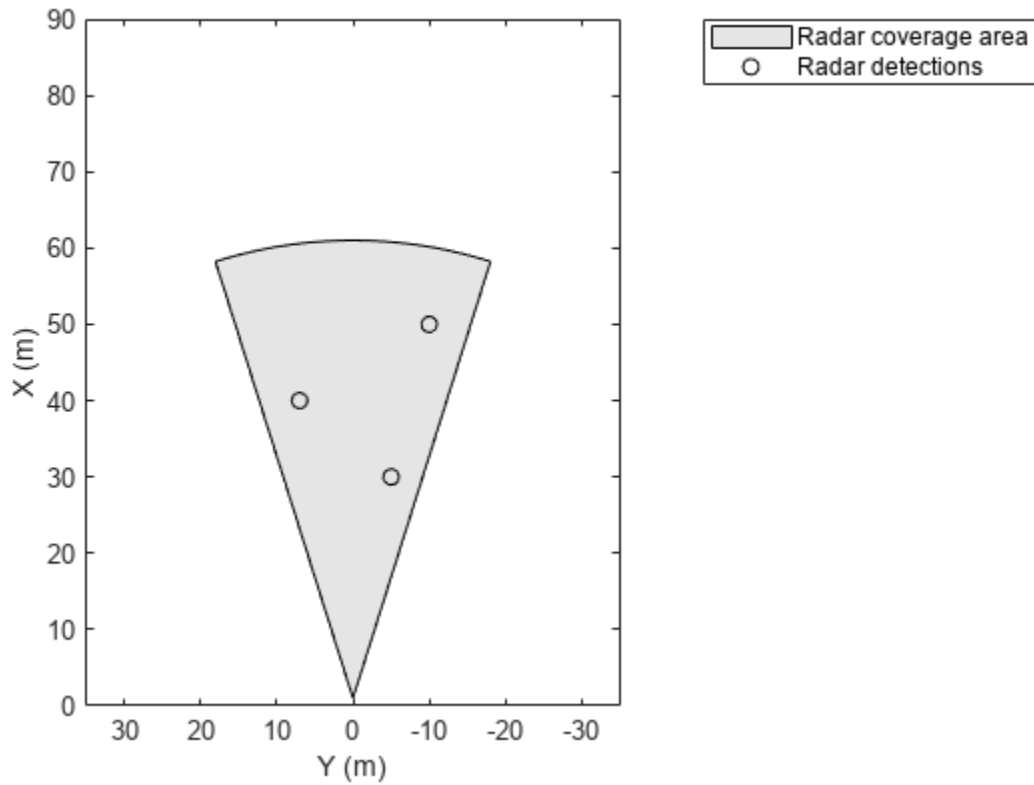

Create Bird's-Eye Plot with Coverage Area and Detection Plotters

Create a bird's-eye plot with an x-axis range of 0 to 90 meters and a y-axis range from -35 to 35 meters. Configure the plot to include a radar coverage area plotter and a detection plotter. Set the display names of these plotters.

```
bep = birdsEyePlot('XLim',[0 90],'YLim',[-35 35]);  
coverageAreaPlotter(bep,'DisplayName','Radar coverage area');  
detectionPlotter(bep,'DisplayName','Radar detections');
```

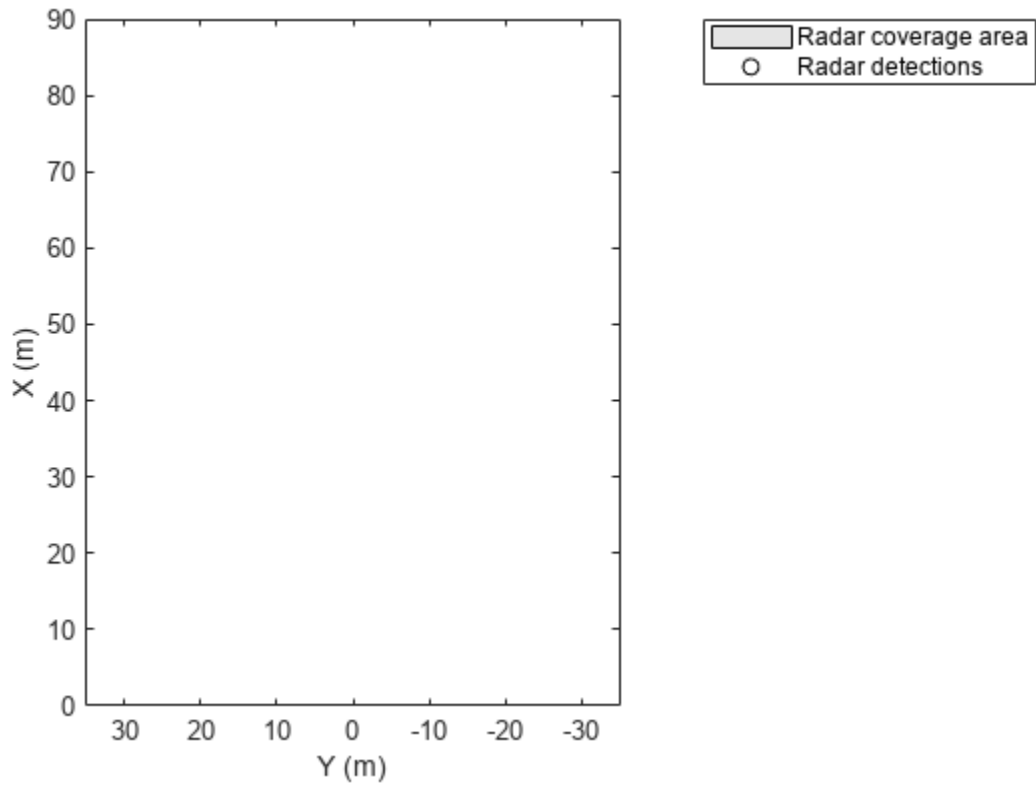

Use `findPlotter` to locate the plotters by their display names.

```
caPlotter = findPlotter(bep, 'DisplayName', 'Radar coverage area');  
radarPlotter = findPlotter(bep, 'DisplayName', 'Radar detections');
```

Plot the coverage area and detected objects.

```
plotCoverageArea(caPlotter, [1 0], 30, 0, 35);  
plotDetection(radarPlotter, [30 5; 30 -10; 30 15]);
```

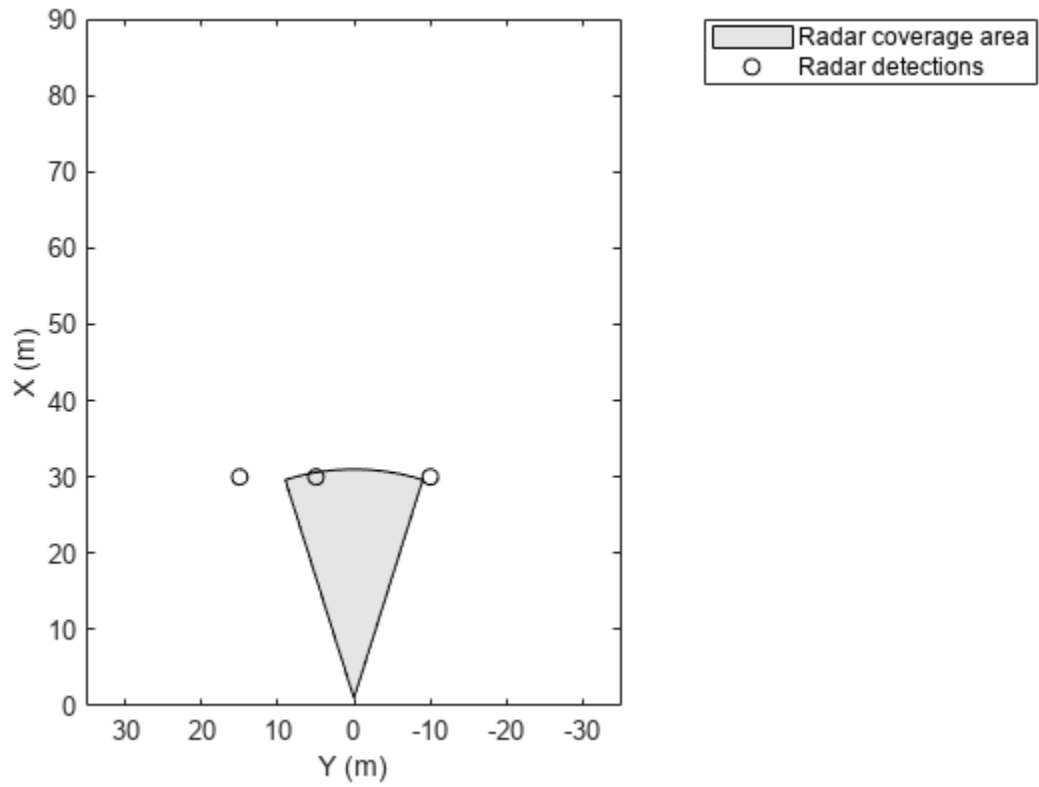

Clear data from the plot.

```
clearPlotterData(bep);
```

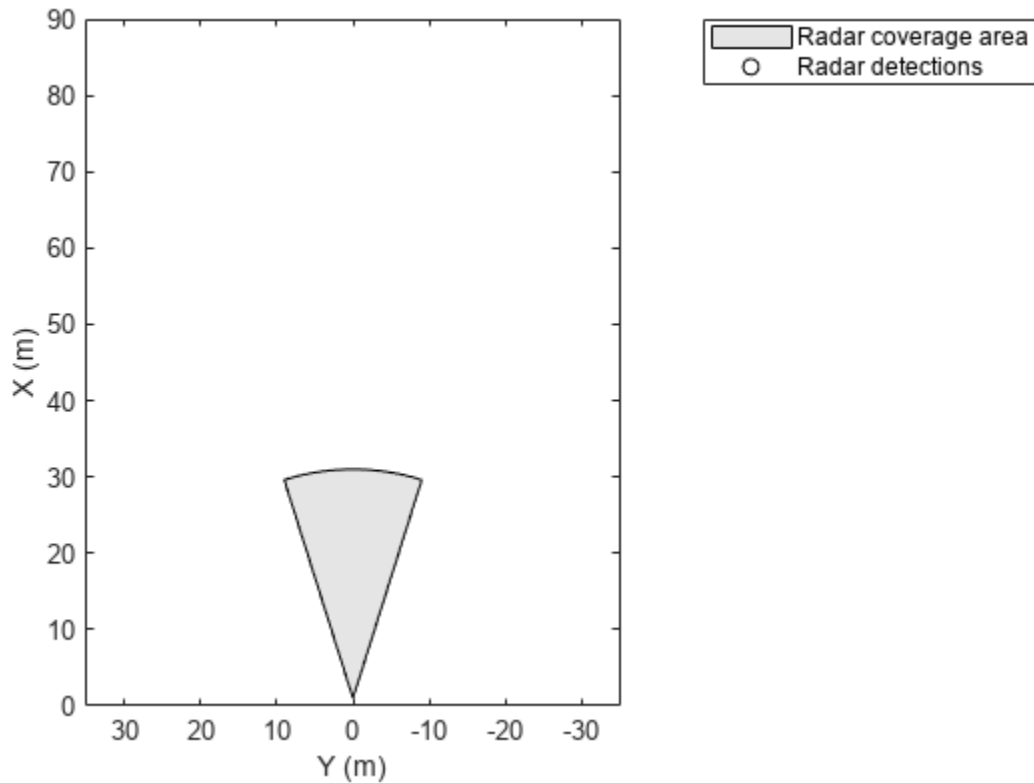

Limitations

The rectangle-zoom feature, where you draw a rectangle to zoom in on a section of a figure, does not work in bird's-eye plot figures.

More About

Vehicle Coordinate System

The `birdsEyePlot` uses the vehicle coordinate system (X_V , Y_V), where:

- The X_V -axis points forward from the ego vehicle.
- The Y_V -axis points to the left, as viewed when facing forward.

The origin is at the center of rotation of the ego vehicle. This point is on the road surface, beneath the center of the rear axle of the ego vehicle.



For more details about the vehicle coordinate system, see “Coordinate Systems in Automated Driving Toolbox”.

Version History

Introduced in R2017a

See Also

drivingScenario | **Bird's-Eye Scope**

Topics

“Visualize Sensor Coverage, Detections, and Tracks”

“Coordinate Systems in Automated Driving Toolbox”

clearData

Clear data from specific plotter of bird's-eye plot

Syntax

```
clearData(pl)
```

Description

`clearData(pl)` clears data belonging to the plotter `pl` associated with a bird's-eye plot. This function can clear data from these plotters:

- `detectionPlotter`
- `laneBoundaryPlotter`
- `laneMarkingPlotter`
- `outlinePlotter`
- `meshPlotter`
- `pathPlotter`
- `pointCloudPlotter`
- `rangeDetectionPlotter`
- `trackPlotter`

To clear data from all plotters belonging to a bird's-eye plot, use the `clearPlotterData` function.

Examples

Clear Specific Plotter Data from Bird's-Eye Plot

Create a bird's-eye plot. Add a track plotter and detection plotter to the bird's-eye plot.

```
bep = birdsEyePlot('XLim',[0,90],'YLim',[-35,35]);  
tPlotter = trackPlotter(bep,'DisplayName','Tracks');  
detPlotter = detectionPlotter(bep,'DisplayName','Radar detections');
```

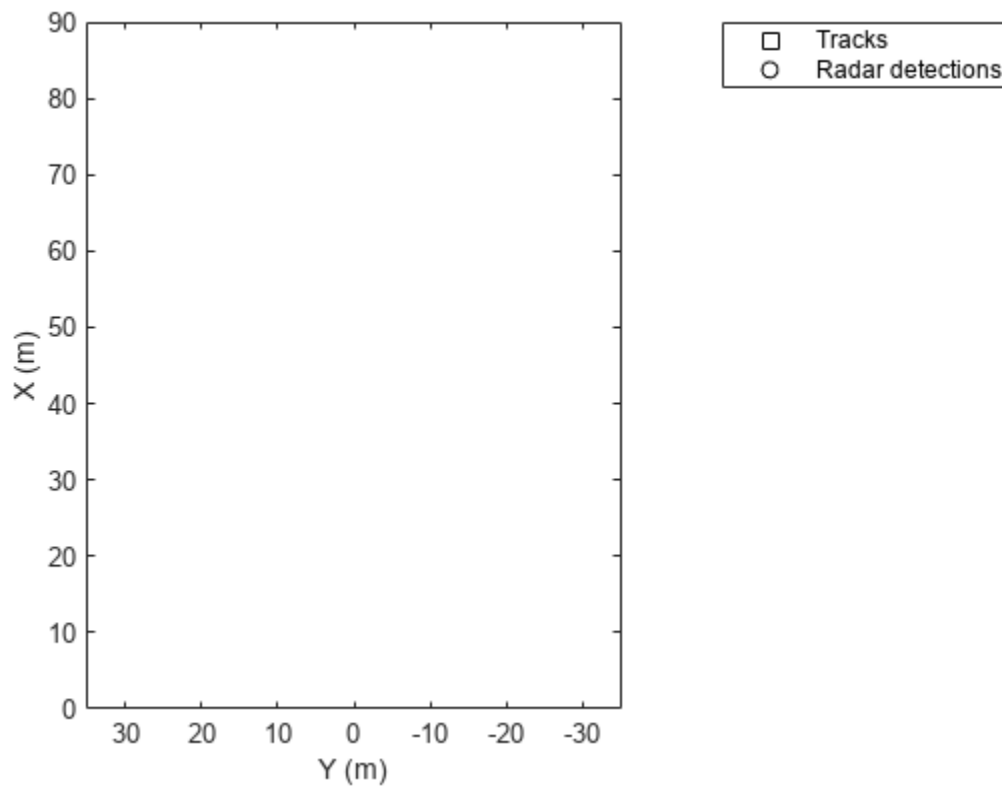
Create and display a set of tracks on the bird's-eye plot.

```
trackPos = [30 15 1; 60 -15 1; 20 5 1];  
trackLabels = {'T1', 'T2', 'T3'};  
plotTrack(tPlotter, trackPos, trackLabels)
```

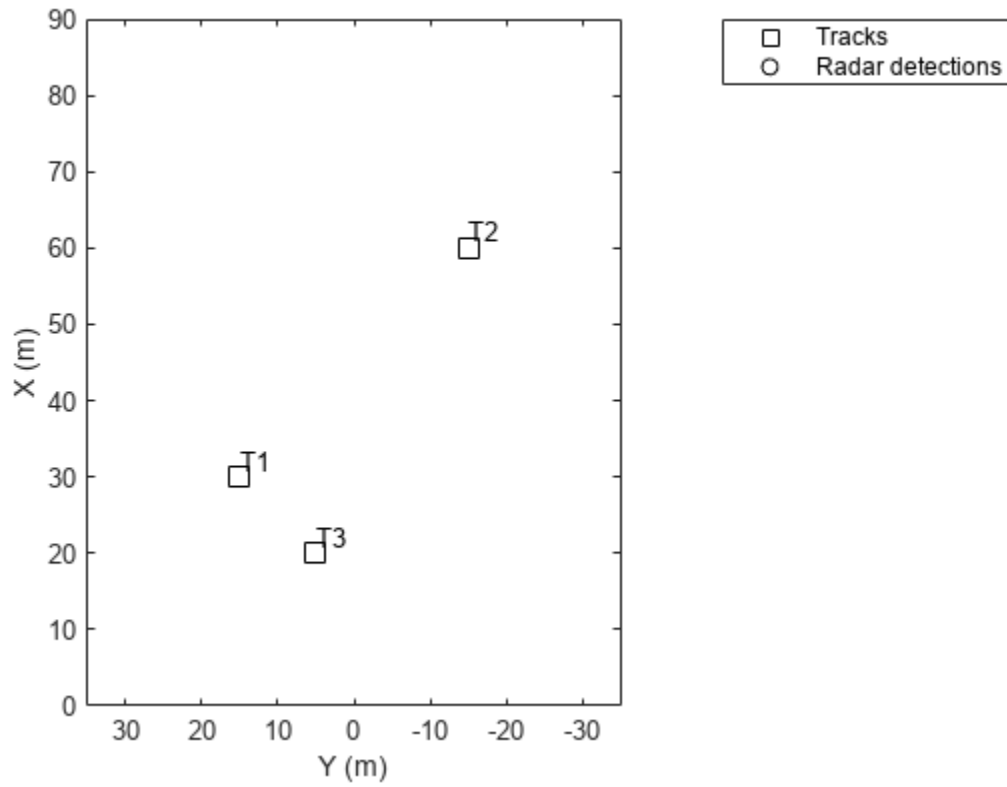

Create and display a set of detections on the bird's-eye plot.

```
detPos = [30 5 4; 30 -10 2; 50 15 1];  
detLabels = {'D1', 'D2', 'D3'};  
plotDetection(detPlotter, detPos, detLabels)
```

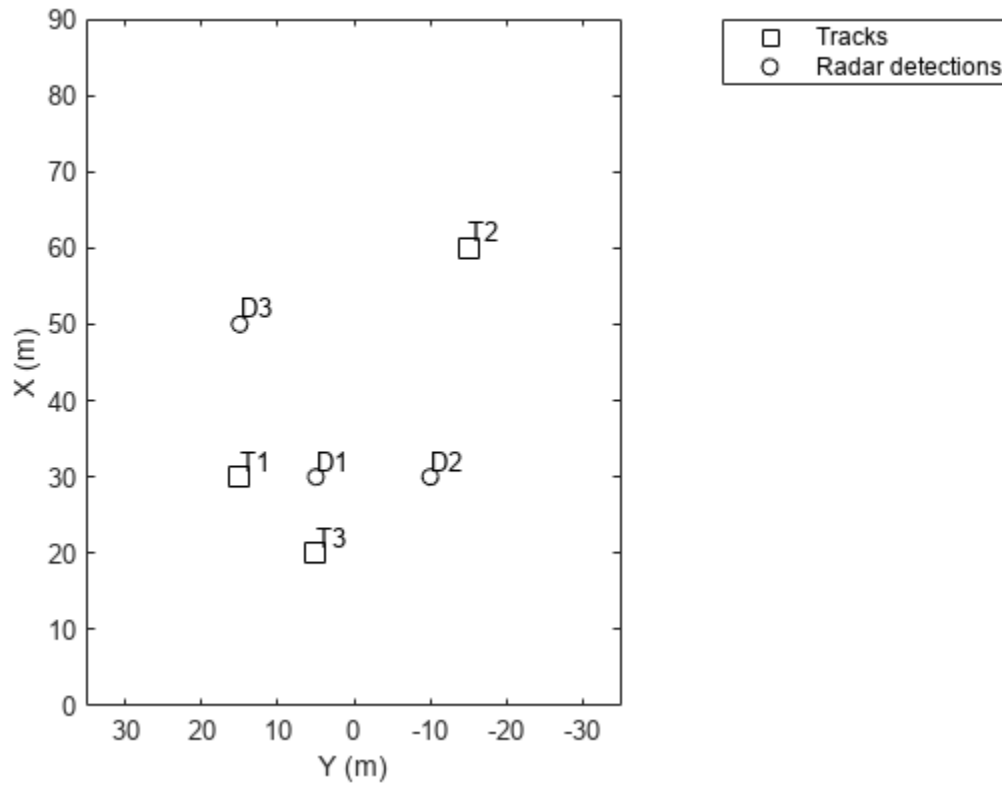

Clear the track plotter data from the bird's-eye plot.

```
clearData(tPlotter)
```

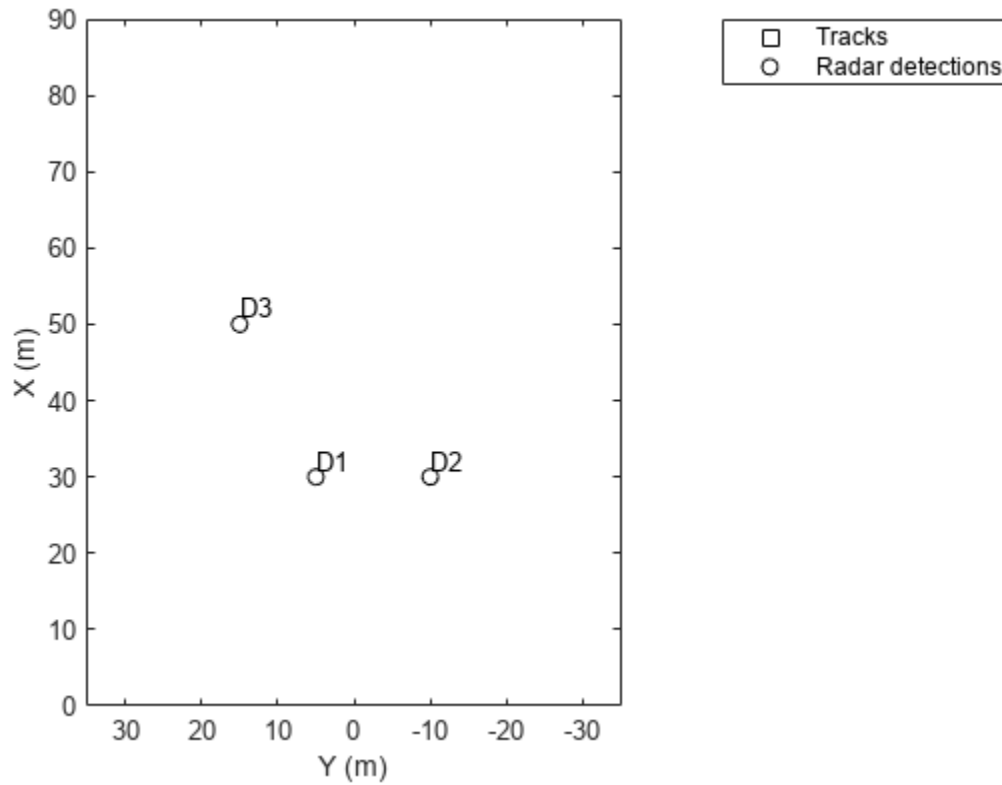

Input Arguments

p1 — Plotter belonging to bird's-eye plot
plotter object

Plotter belonging to a `birdsEyePlot` object, specified as a plotter object. You can clear data from any plotter except `coverageAreaPlotter`.

Version History

Introduced in R2017a

See Also

Objects

`birdsEyePlot` | `clearPlotterData` | `findPlotter`

clearPlotterData

Clear data from bird's-eye plot

Syntax

```
clearPlotterData(bep)
```

Description

`clearPlotterData(bep)` clears all plotter data displayed in the specified bird's-eye plot. Legend entries and coverage areas are not cleared from the plot.

To clear data from a specific plotter, use the `clearData` function.

Examples

Create Bird's-Eye Plot with Coverage Area and Detection Plotters

Create a bird's-eye plot with an x-axis range of 0 to 90 meters and a y-axis range from -35 to 35 meters. Configure the plot to include a radar coverage area plotter and a detection plotter. Set the display names of these plotters.

```
bep = birdsEyePlot('XLim',[0 90],'YLim',[-35 35]);  
coverageAreaPlotter(bep,'DisplayName','Radar coverage area');  
detectionPlotter(bep,'DisplayName','Radar detections');
```

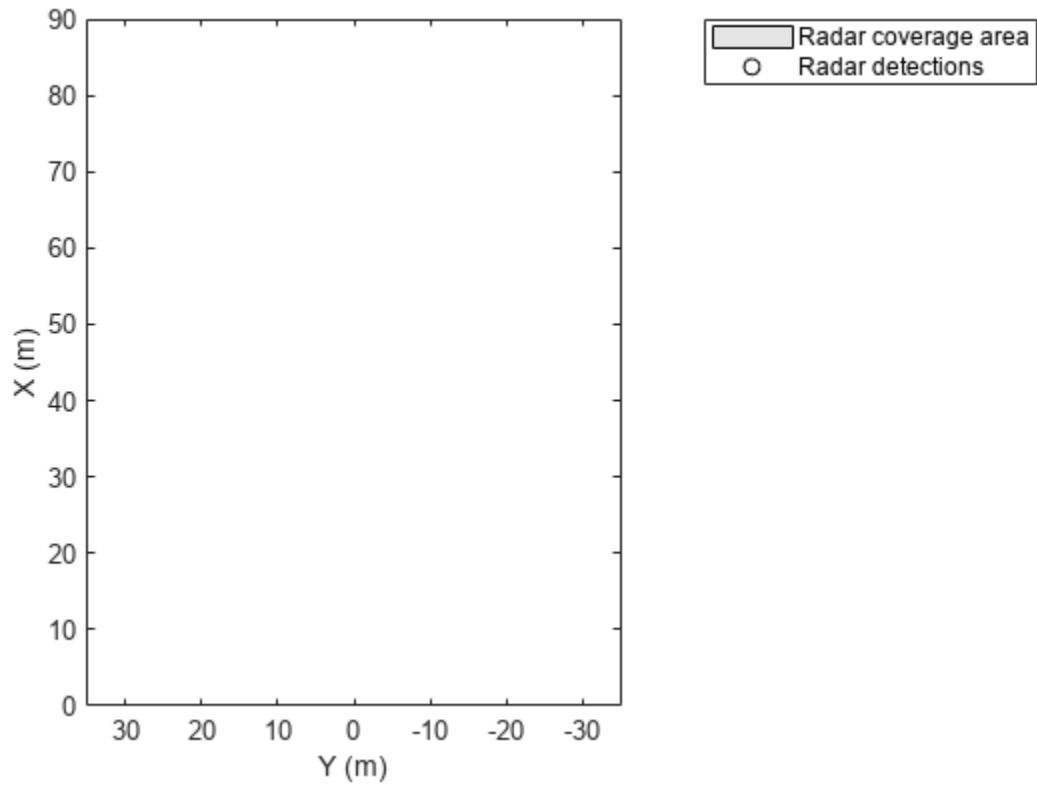

Use `findPlotter` to locate the plotters by their display names.

```
caPlotter = findPlotter(bep, 'DisplayName', 'Radar coverage area');  
radarPlotter = findPlotter(bep, 'DisplayName', 'Radar detections');
```

Plot the coverage area and detected objects.

```
plotCoverageArea(caPlotter, [1 0], 30, 0, 35);  
plotDetection(radarPlotter, [30 5; 30 -10; 30 15]);
```

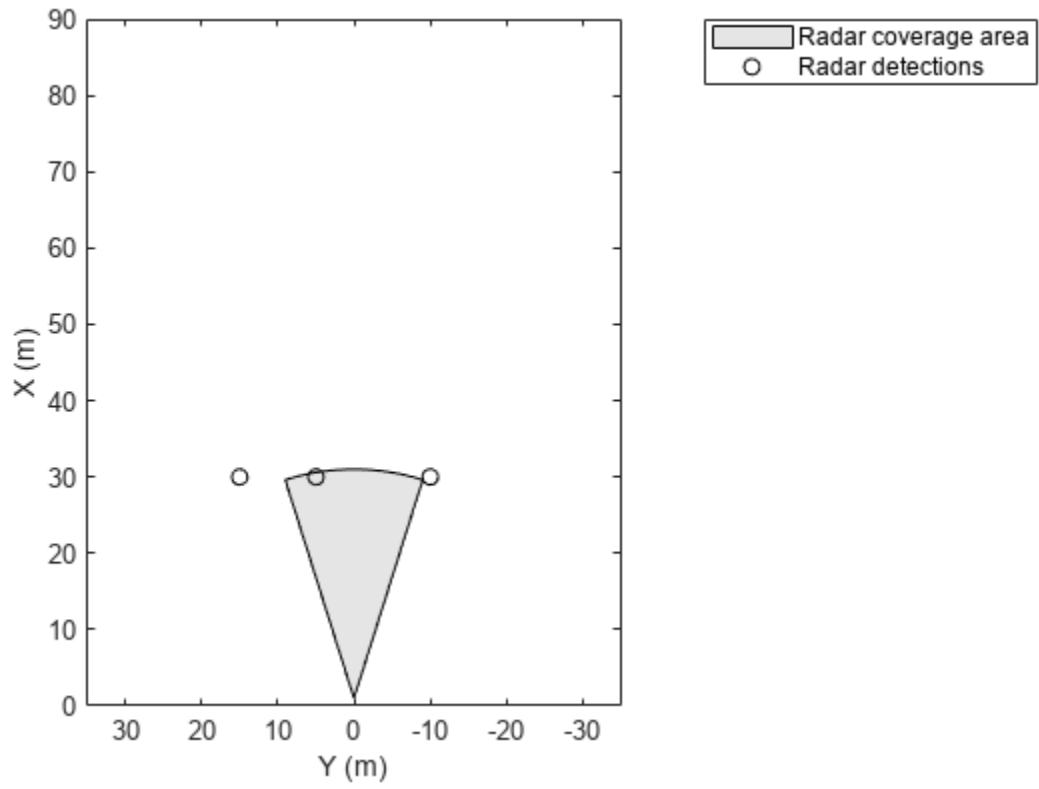

Clear data from the plot.

```
clearPlotterData(bep);
```

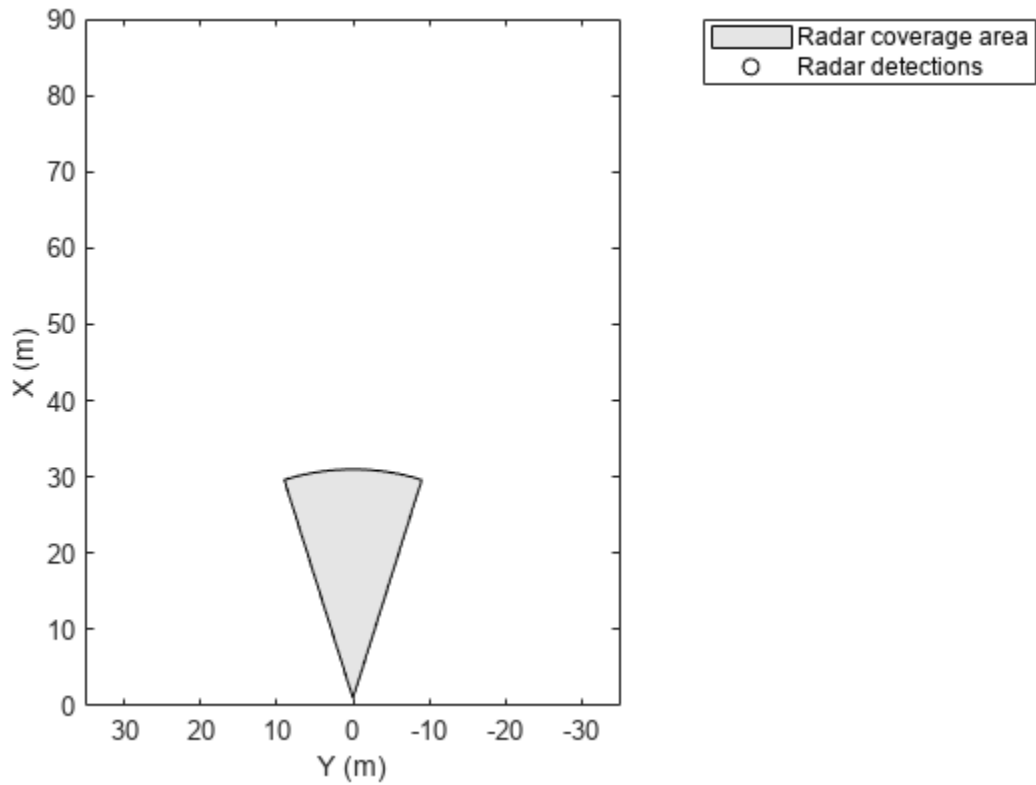

Input Arguments

bep — Bird's-eye plot
`birdsEyePlot` object

Bird's-eye plot, specified as a `birdsEyePlot` object.

Version History

Introduced in R2017a

See Also

Functions

`birdsEyePlot` | `clearData` | `findPlotter`

coverageAreaPlotter

Package:

Coverage area plotter for bird's-eye plot

Syntax

```
caPlotter = coverageAreaPlotter(bep)
caPlotter = coverageAreaPlotter(bep,Name,Value)
```

Description

`caPlotter = coverageAreaPlotter(bep)` creates a `CoverageAreaPlotter` object that configures the display of sensor coverage areas on a bird's-eye plot. The `CoverageAreaPlotter` object is stored in the `Plotters` property of the input `birdsEyePlot` object, `bep`. To display the sensor coverage areas, use the `plotCoverageArea` function.

`caPlotter = coverageAreaPlotter(bep,Name,Value)` sets properties using one or more `Name,Value` pair arguments. For example, `coverageAreaPlotter(bep,'DisplayName','Coverage area')` sets the display name that appears in the bird's-eye-plot legend.

Examples

Create and Display Coverage Area on Bird's-Eye Plot

Create a bird's-eye plot with an x-axis range from 0 to 90 meters and a y-axis range from -35 to 35 meters. Create a coverage area plotter that displays coverage areas in red.

```
bep = birdsEyePlot('XLim',[0 90],'YLim',[-35 35]);
caPlotter = coverageAreaPlotter(bep,'DisplayName','Radar coverage area','FaceColor','r');
```

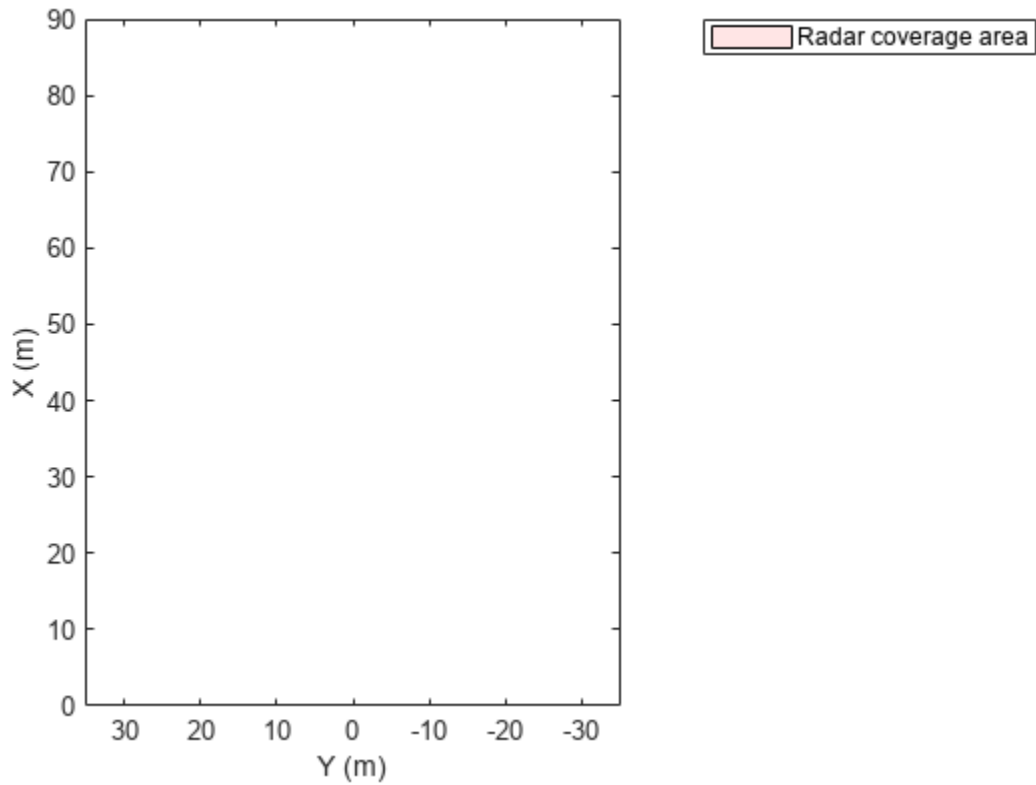

Display a coverage area that has a 35-degree field of view and a 60-meter range. Mount the coverage area sensor 1 meter in front of the origin. Set the orientation angle of the sensor to 0 degrees.

```
mountPosition = [1 0];  
range = 60;  
orientation = 0;  
fieldOfView = 35;  
plotCoverageArea(caPlotter, mountPosition, range, orientation, fieldOfView);
```

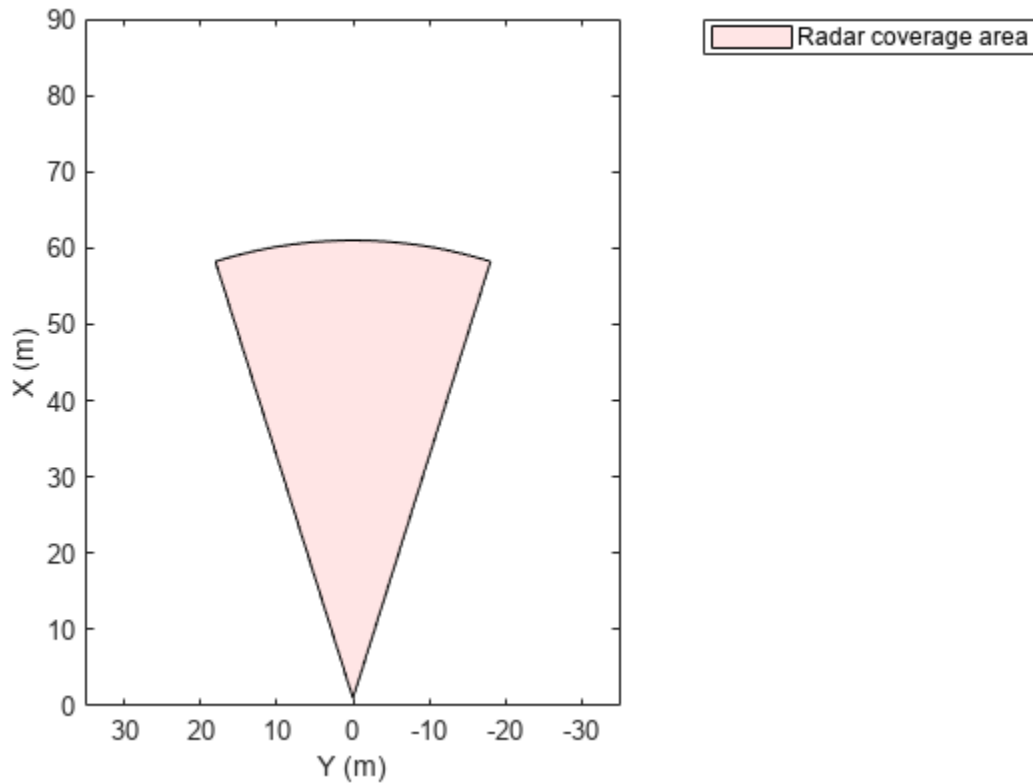

Input Arguments

bep — Bird's-eye plot

`birdsEyePlot` object

Bird's-eye plot, specified as a `birdsEyePlot` object.

Name-Value Pair Arguments

Specify optional pairs of arguments as `Name1=Value1, ..., NameN=ValueN`, where `Name` is the argument name and `Value` is the corresponding value. Name-value arguments must appear after other arguments, but the order of the pairs does not matter.

Before R2021a, use commas to separate each name and value, and enclose `Name` in quotes.

Example: `coverageAreaPlotter('FaceColor','red')` sets the fill color of sensor coverage areas to red.

DisplayName — Plotter name to display in legend

`''` (default) | character vector | string scalar

Plotter name to display in legend, specified as the comma-separated pair consisting of `'DisplayName'` and character vector or string scalar. If you do not specify a name, the bird's-eye plot does not display a legend entry for the plotter.

FaceColor — Fill color of coverage areas







[0 0 0] (black) (default) | RGB triplet | hexadecimal color code | color name | short color name

Fill color of coverage areas, specified as the comma-separated pair consisting of 'FaceColor' and an RGB triplet, a hexadecimal color code, a color name, or a short color name.





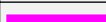
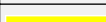
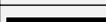

For a custom color, specify an RGB triplet or a hexadecimal color code.

- An RGB triplet is a three-element row vector whose elements specify the intensities of the red, green, and blue components of the color. The intensities must be in the range [0, 1], for example, [0.4 0.6 0.7].
- A hexadecimal color code is a string scalar or character vector that starts with a hash symbol (#) followed by three or six hexadecimal digits, which can range from 0 to F. The values are not case sensitive. Therefore, the color codes "#FF8800", "#ff8800", "#F80", and "#f80" are equivalent.

Alternatively, you can specify some common colors by name. This table lists the named color options, the equivalent RGB triplets, and hexadecimal color codes.

Color Name	Short Name	RGB Triplet	Hexadecimal Color Code	Appearance
"red"	"r"	[1 0 0]	"#FF0000"	
"green"	"g"	[0 1 0]	"#00FF00"	
"blue"	"b"	[0 0 1]	"#0000FF"	
"cyan"	"c"	[0 1 1]	"#00FFFF"	
"magenta"	"m"	[1 0 1]	"#FF00FF"	
"yellow"	"y"	[1 1 0]	"#FFFF00"	
"black"	"k"	[0 0 0]	"#000000"	
"white"	"w"	[1 1 1]	"#FFFFFF"	
"none"	Not applicable	Not applicable	Not applicable	No color

Here are the RGB triplets and hexadecimal color codes for the default colors MATLAB uses in many types of plots.

RGB Triplet	Hexadecimal Color Code	Appearance
[0 0.4470 0.7410]	"#0072BD"	
[0.8500 0.3250 0.0980]	"#D95319"	
[0.9290 0.6940 0.1250]	"#EDB120"	
[0.4940 0.1840 0.5560]	"#7E2F8E"	
[0.4660 0.6740 0.1880]	"#77AC30"	
[0.3010 0.7450 0.9330]	"#4DBEEE"	
[0.6350 0.0780 0.1840]	"#A2142F"	

EdgeColor — Border color of coverage areas







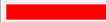

[0 0 0] (black) (default) | RGB triplet | hexadecimal color code | color name | short color name

Border color of coverage areas, specified as the comma-separated pair consisting of 'EdgeColor' and an RGB triplet, a hexadecimal color code, a color name, or a short color name.







For a custom color, specify an RGB triplet or a hexadecimal color code.

- An RGB triplet is a three-element row vector whose elements specify the intensities of the red, green, and blue components of the color. The intensities must be in the range [0, 1], for example, [0.4 0.6 0.7].
- A hexadecimal color code is a string scalar or character vector that starts with a hash symbol (#) followed by three or six hexadecimal digits, which can range from 0 to F. The values are not case sensitive. Therefore, the color codes "#FF8800", "#ff8800", "#F80", and "#f80" are equivalent.

Alternatively, you can specify some common colors by name. This table lists the named color options, the equivalent RGB triplets, and hexadecimal color codes.

Color Name	Short Name	RGB Triplet	Hexadecimal Color Code	Appearance
"red"	"r"	[1 0 0]	"#FF0000"	
"green"	"g"	[0 1 0]	"#00FF00"	
"blue"	"b"	[0 0 1]	"#0000FF"	
"cyan"	"c"	[0 1 1]	"#00FFFF"	
"magenta"	"m"	[1 0 1]	"#FF00FF"	
"yellow"	"y"	[1 1 0]	"#FFFF00"	
"black"	"k"	[0 0 0]	"#000000"	
"white"	"w"	[1 1 1]	"#FFFFFF"	
"none"	Not applicable	Not applicable	Not applicable	No color

Here are the RGB triplets and hexadecimal color codes for the default colors MATLAB uses in many types of plots.

RGB Triplet	Hexadecimal Color Code	Appearance
[0 0.4470 0.7410]	"#0072BD"	
[0.8500 0.3250 0.0980]	"#D95319"	
[0.9290 0.6940 0.1250]	"#EDB120"	
[0.4940 0.1840 0.5560]	"#7E2F8E"	
[0.4660 0.6740 0.1880]	"#77AC30"	
[0.3010 0.7450 0.9330]	"#4DBEEE"	
[0.6350 0.0780 0.1840]	"#A2142F"	

FaceAlpha — Transparency of coverage areas

0.1 (default) | scalar in the range [0, 1]

Transparency of coverage areas, specified as the comma-separated pair consisting of 'FaceAlpha' and a scalar in the range [0, 1]. A value of 0 makes the coverage area fully transparent. A value of 1 makes the coverage area fully opaque.

Tag — Tag associated with plotter object

'Plotter N ' (default) | character vector | string scalar

Tag associated with the plotter object, specified as the comma-separated pair consisting of 'Tag' and a character vector or string scalar. The default value is 'Plotter N ', where N is an integer that corresponds to the N th plotter associated with the input `birdsEyePlot` object.

Output Arguments**caPlotter — Coverage area plotter**

CoverageAreaPlotter object

Coverage area plotter, returned as a `CoverageAreaPlotter` object. You can modify this object by changing its property values. The property names correspond to the name-value pair arguments of the `coverageAreaPlotter` function.

`caPlotter` is stored in the `Plotters` property of the input `birdsEyePlot` object, `bep`. To plot the coverage areas, use the `plotCoverageArea` function.

Version History

Introduced in R2017a

See Also

`birdsEyePlot` | `plotCoverageArea` | `findPlotter`

detectionPlotter

Package:

Detection plotter for bird's-eye plot

Syntax

```
detPlotter = detectionPlotter(bep)
detPlotter = detectionPlotter(bep,Name,Value)
```

Description

`detPlotter = detectionPlotter(bep)` creates a `DetectionPlotter` object that configures the display of object detections on a bird's-eye plot. The `DetectionPlotter` object is stored in the `Plotters` property of the input `birdsEyePlot` object, `bep`. To plot the object detections, use the `plotDetection` function.

`detPlotter = detectionPlotter(bep,Name,Value)` sets properties using one or more `Name,Value` pair arguments. For example, `detectionPlotter(bep, 'DisplayName', 'Detections')` sets the display name that appears in the bird's-eye-plot legend.

Examples

Create and Display Labeled Detections on Bird's-Eye Plot

Create a bird's-eye plot with an x-axis range from 0 to 90 meters and a y-axis range from -35 to 35 meters. Create a radar detection plotter that displays detections in blue.

```
bep = birdsEyePlot('XLim',[0 90],'YLim',[-35 35]);
detPlotter = detectionPlotter(bep,'DisplayName','Radar detections', ...
    'MarkerFaceColor','b');
```

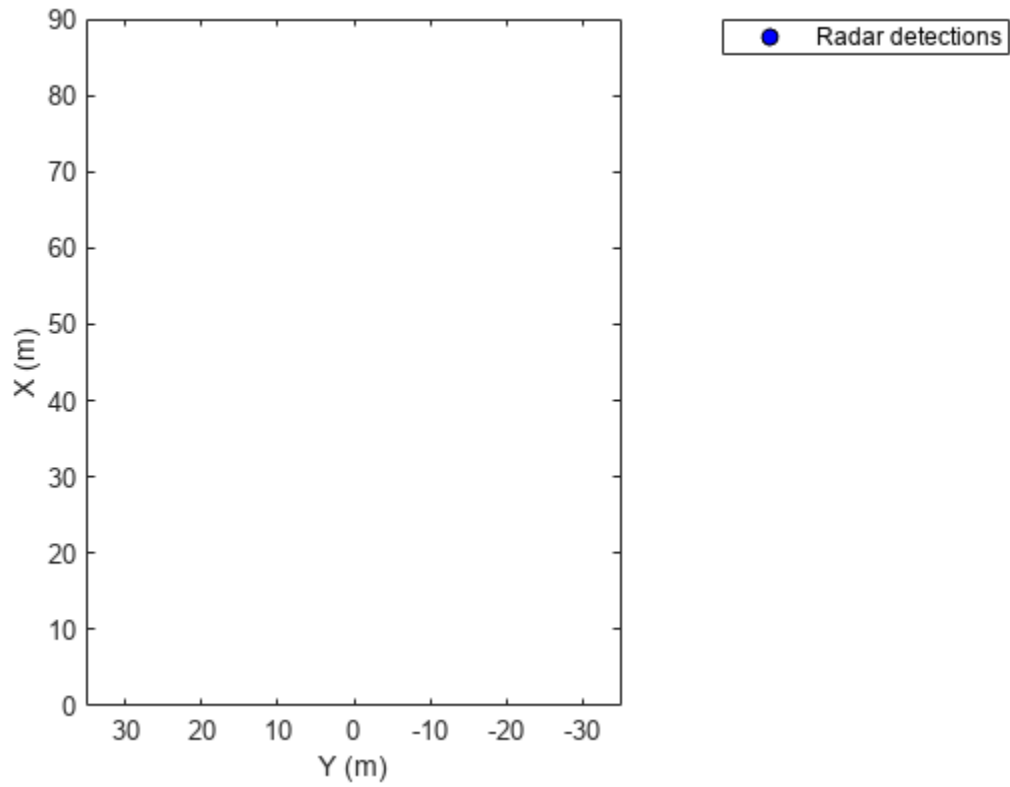

Display the positions and velocities of three labeled detections.

```
positions = [30 5; 30 -10; 30 15];  
velocities = [-10 0; -10 3; -10 -4];  
labels = {'D1', 'D2', 'D3'};  
plotDetection(detPlotter, positions, velocities, labels);
```

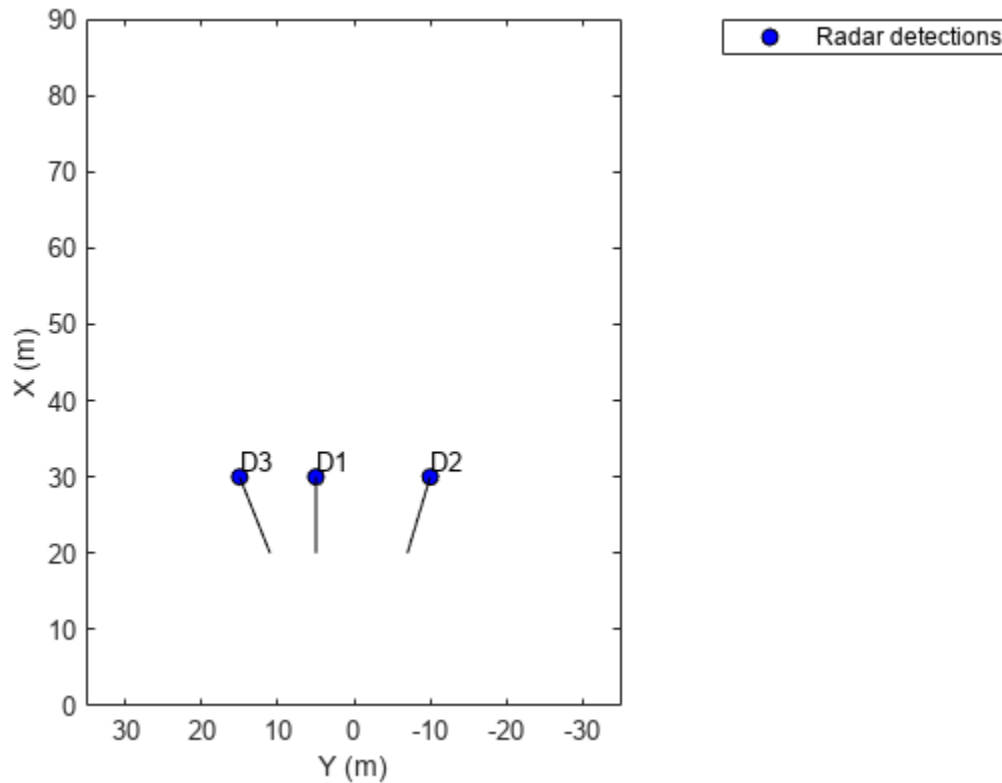
Input Arguments

bep — Bird's-eye plot

`birdsEyePlot` object

Bird's-eye plot, specified as a `birdsEyePlot` object.

Name-Value Pair Arguments

Specify optional pairs of arguments as `Name1=Value1, ..., NameN=ValueN`, where `Name` is the argument name and `Value` is the corresponding value. Name-value arguments must appear after other arguments, but the order of the pairs does not matter.

Before R2021a, use commas to separate each name and value, and enclose Name in quotes.

Example: `detectionPlotter('Marker', '+')` sets the marker symbol for detections to a plus sign.

DisplayName — Plotter name to display in legend

`''` (default) | character vector | string scalar

Plotter name to display in legend, specified as the comma-separated pair consisting of `'DisplayName'` and character vector or string scalar. If you do not specify a name, the bird's-eye plot does not display a legend entry for the plotter.

Marker — Marker symbol for detections

'o' (default) | '+' | '*' | '.' | 'x' | ...

Marker symbol for detections, specified as the comma-separated pair consisting of 'Marker' and one of the markers in this table.

Marker	Description	Resulting Marker
"o"	Circle	○
"+"	Plus sign	+
"*"	Asterisk	*
."	Point	•
"x"	Cross	×
"_"	Horizontal line	—
" "	Vertical line	
"square"	Square	□
"diamond"	Diamond	◇
"^"	Upward-pointing triangle	△
"v"	Downward-pointing triangle	▽
">"	Right-pointing triangle	▷
"<"	Left-pointing triangle	◁
"pentagram"	Pentagram	☆
"hexagram"	Hexagram	☆
"none"	No markers	Not applicable

MarkerSize — Size of marker for detections

6 (default) | positive integer

Size of marker, specified as the comma-separated pair consisting of 'MarkerSize' and a positive integer in points.

MarkerEdgeColor — Marker outline color for detections







[0 0 0] (black) (default) | RGB triplet | hexadecimal color code | color name | short color name

Marker outline color for detections, specified as the comma-separated pair consisting of 'MarkerEdgeColor' and an RGB triplet, a hexadecimal color code, a color name, or a short color name.





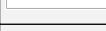

For a custom color, specify an RGB triplet or a hexadecimal color code.

- An RGB triplet is a three-element row vector whose elements specify the intensities of the red, green, and blue components of the color. The intensities must be in the range $[0, 1]$, for example, $[0.4 \ 0.6 \ 0.7]$.
- A hexadecimal color code is a string scalar or character vector that starts with a hash symbol (#) followed by three or six hexadecimal digits, which can range from 0 to F. The values are not case sensitive. Therefore, the color codes "#FF8800", "#ff8800", "#F80", and "#f80" are equivalent.

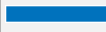
Alternatively, you can specify some common colors by name. This table lists the named color options, the equivalent RGB triplets, and hexadecimal color codes.

Color Name	Short Name	RGB Triplet	Hexadecimal Color Code	Appearance
"red"	"r"	[1 0 0]	"#FF0000"	
"green"	"g"	[0 1 0]	"#00FF00"	
"blue"	"b"	[0 0 1]	"#0000FF"	
"cyan"	"c"	[0 1 1]	"#00FFFF"	
"magenta"	"m"	[1 0 1]	"#FF00FF"	
"yellow"	"y"	[1 1 0]	"#FFFF00"	
"black"	"k"	[0 0 0]	"#000000"	
"white"	"w"	[1 1 1]	"#FFFFFF"	
"none"	Not applicable	Not applicable	Not applicable	No color

Here are the RGB triplets and hexadecimal color codes for the default colors MATLAB uses in many types of plots.

RGB Triplet	Hexadecimal Color Code	Appearance
[0 0.4470 0.7410]	"#0072BD"	
[0.8500 0.3250 0.0980]	"#D95319"	
[0.9290 0.6940 0.1250]	"#EDB120"	
[0.4940 0.1840 0.5560]	"#7E2F8E"	
[0.4660 0.6740 0.1880]	"#77AC30"	
[0.3010 0.7450 0.9330]	"#4DBEEE"	
[0.6350 0.0780 0.1840]	"#A2142F"	

MarkerFaceColor — Marker fill color







'none' (default) | RGB triplet | hexadecimal color code | color name | short color name

Marker fill color, specified as the comma-separated pair consisting of 'MarkerFaceColor' and an RGB triplet, a hexadecimal color code, a color name, or a short color name.

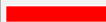



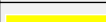

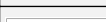
For a custom color, specify an RGB triplet or a hexadecimal color code.

- An RGB triplet is a three-element row vector whose elements specify the intensities of the red, green, and blue components of the color. The intensities must be in the range $[0, 1]$, for example, $[0.4 \ 0.6 \ 0.7]$.
- A hexadecimal color code is a string scalar or character vector that starts with a hash symbol (#) followed by three or six hexadecimal digits, which can range from 0 to F. The values are not case sensitive. Therefore, the color codes "#FF8800", "#ff8800", "#F80", and "#f80" are equivalent.

Alternatively, you can specify some common colors by name. This table lists the named color options, the equivalent RGB triplets, and hexadecimal color codes.

Color Name	Short Name	RGB Triplet	Hexadecimal Color Code	Appearance
"red"	"r"	[1 0 0]	"#FF0000"	
"green"	"g"	[0 1 0]	"#00FF00"	
"blue"	"b"	[0 0 1]	"#0000FF"	
"cyan"	"c"	[0 1 1]	"#00FFFF"	
"magenta"	"m"	[1 0 1]	"#FF00FF"	
"yellow"	"y"	[1 1 0]	"#FFFF00"	
"black"	"k"	[0 0 0]	"#000000"	
"white"	"w"	[1 1 1]	"#FFFFFF"	
"none"	Not applicable	Not applicable	Not applicable	No color

Here are the RGB triplets and hexadecimal color codes for the default colors MATLAB uses in many types of plots.

RGB Triplet	Hexadecimal Color Code	Appearance
[0 0.4470 0.7410]	"#0072BD"	
[0.8500 0.3250 0.0980]	"#D95319"	
[0.9290 0.6940 0.1250]	"#EDB120"	
[0.4940 0.1840 0.5560]	"#7E2F8E"	
[0.4660 0.6740 0.1880]	"#77AC30"	
[0.3010 0.7450 0.9330]	"#4DBEEE"	
[0.6350 0.0780 0.1840]	"#A2142F"	

FontSize — Font size for labeling detections

10 points (default) | positive integer

Font size for labeling detections, specified as the comma-separated pair consisting of 'FontSize' and a positive integer in font points.

LabelOffset — Gap between label and positional point

[0 0] (default) | real-valued vector of the form [x y]

Gap between label and positional point, specified as the comma-separated pair consisting of 'LabelOffset' and a real-valued vector of the form [x y]. Units are in meters.

VelocityScaling — Scale factor for magnitude length of velocity vectors

1 (default) | positive real scalar

Scale factor for magnitude length of velocity vectors, specified as the comma-separated pair consisting of 'VelocityScaling' and a positive real scalar. The bird's-eye plot renders the magnitude vector value as $M \times \text{VelocityScaling}$, where M is the magnitude of velocity.

Tag — Tag associated with plotter object

'Plotter N ' (default) | character vector | string scalar

Tag associated with the plotter object, specified as the comma-separated pair consisting of 'Tag' and a character vector or string scalar. The default value is 'Plotter N ', where N is an integer that corresponds to the N th plotter associated with the input `birdsEyePlot` object.

Output Arguments**detPlotter — Detection plotter**

DetectionPlotter object

Detection plotter, returned as a `DetectionPlotter` object. You can modify this object by changing its property values. The property names correspond to the name-value pair arguments of the `detectionPlotter` function.

`detPlotter` is stored in the `Plotters` property of the input `birdsEyePlot` object, `bep`. To plot the detections, use the `plotDetection` function.

Version History

Introduced in R2017a

See Also

`birdsEyePlot` | `plotDetection` | `findPlotter` | `clearData` | `clearPlotterData`

findPlotter

Find plotters associated with bird's-eye plot

Syntax

```
p = findPlotter(bep)
p = findPlotter(bep,Name,Value)
```

Description

`p = findPlotter(bep)` returns an array of plotters associated with a bird's-eye plot.

`p = findPlotter(bep,Name,Value)` specifies options using one or more `Name,Value` pair arguments. For example, `findPlotter(bep,'Tag','Plotter1')` returns the plotter object whose `Tag` property value is `'Plotter1'`.

Examples

Create Bird's-Eye Plot with Coverage Area and Detection Plotters

Create a bird's-eye plot with an *x*-axis range of 0 to 90 meters and a *y*-axis range from -35 to 35 meters. Configure the plot to include a radar coverage area plotter and a detection plotter. Set the display names of these plotters.

```
bep = birdsEyePlot('XLim',[0 90],'YLim',[-35 35]);
coverageAreaPlotter(bep,'DisplayName','Radar coverage area');
detectionPlotter(bep,'DisplayName','Radar detections');
```

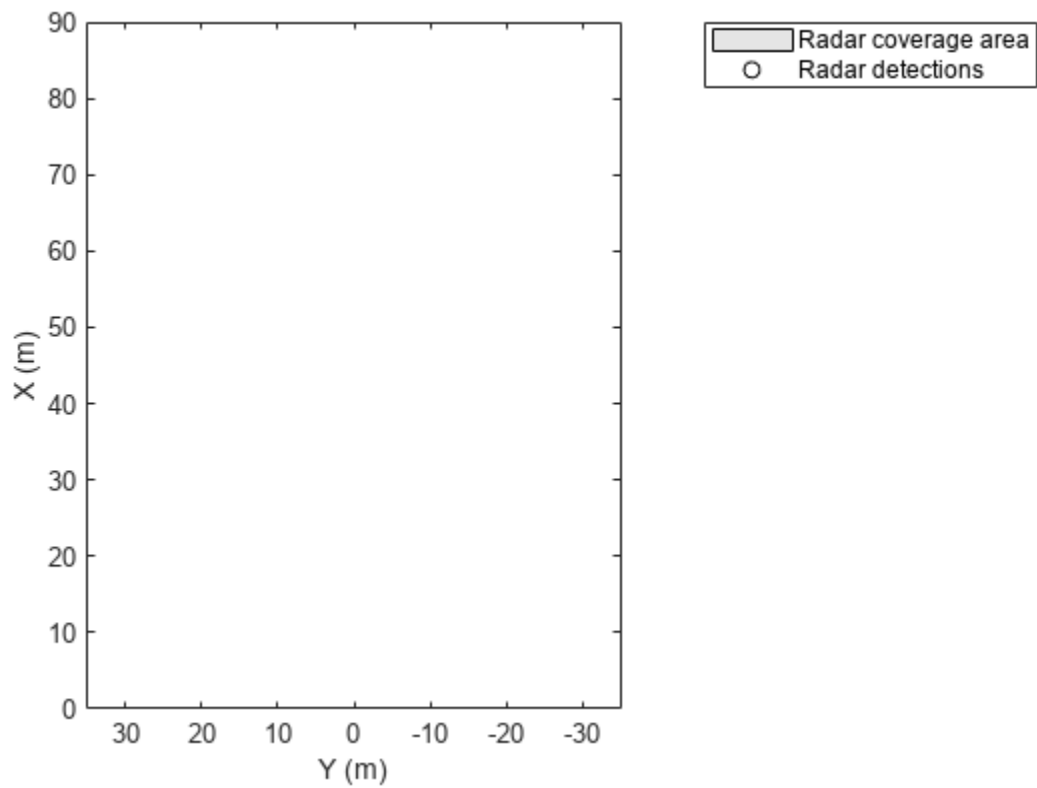

Use `findPlotter` to locate the plotters by their display names.

```
caPlotter = findPlotter(bep, 'DisplayName', 'Radar coverage area');  
radarPlotter = findPlotter(bep, 'DisplayName', 'Radar detections');
```

Plot the coverage area and detected objects.

```
plotCoverageArea(caPlotter, [1 0], 30, 0, 35);  
plotDetection(radarPlotter, [30 5; 30 -10; 30 15]);
```

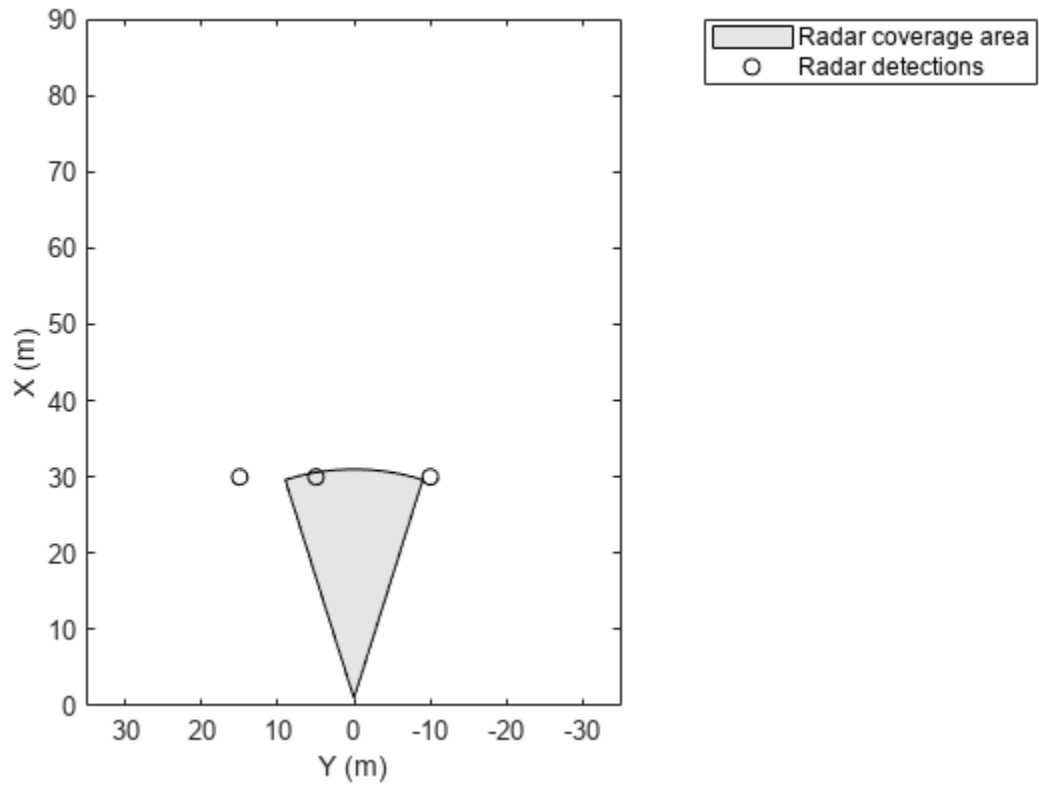

Clear data from the plot.

```
clearPlotterData(bep);
```

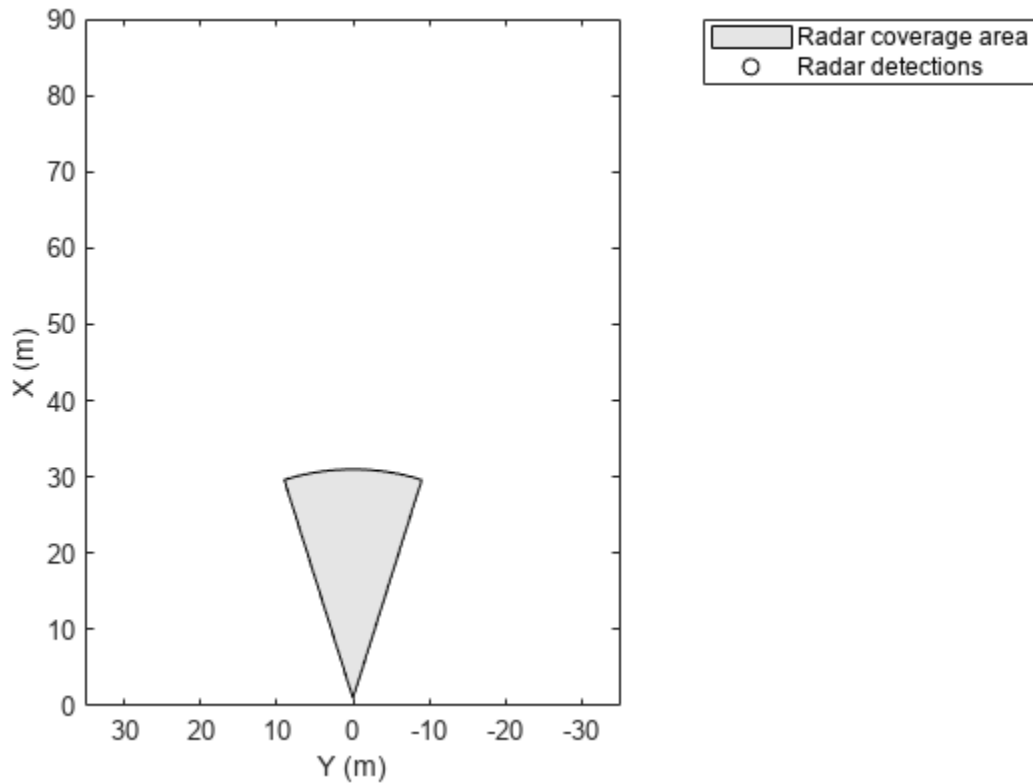
Input Arguments

bep — Bird's-eye plot

`birdsEyePlot` object

Bird's-eye plot, specified as a `birdsEyePlot` object.

Name-Value Pair Arguments

Specify optional pairs of arguments as `Name1=Value1, ..., NameN=ValueN`, where `Name` is the argument name and `Value` is the corresponding value. Name-value arguments must appear after other arguments, but the order of the pairs does not matter.

Before R2021a, use commas to separate each name and value, and enclose Name in quotes.

Example: `'DisplayName','MyBirdsEyePlots'`

DisplayName — Display name of plotter to find

character vector | string scalar

Display name of the plotter to find, specified as the comma-separated pair consisting of `'DisplayName'` and a character vector or string scalar. `DisplayName` is the plotter name that appears in the legend of the bird's-eye plot. To match missing legend entries, specify `DisplayName` as `''`.

Tag — Tag of plotter to find

'Plotter*N*' (default) | character vector | string scalar

Tag of plotter to find, specified as the comma-separated pair consisting of 'Tag' and a character vector or string scalar. By default, plotter objects have a Tag property with a default value of 'Plotter*N*'. *N* is an integer that corresponds to the *N*th plotter associated with the specified birdsEyePlot object, bep.

Output Arguments**p — Plotters associated with input bird's-eye plot**

array of plotter objects

Plotters associated with the input bird's-eye plot, returned as an array of plotter objects.

Version History

Introduced in R2017a

See Also**Functions**

birdsEyePlot | clearData | clearPlotterData

laneBoundaryPlotter

Package:

Lane boundary plotter for bird's-eye plot

Syntax

```
lbPlotter = laneBoundaryPlotter(bep)
lbPlotter = laneBoundaryPlotter(bep,Name,Value)
```

Description

`lbPlotter = laneBoundaryPlotter(bep)` creates a `LaneBoundaryPlotter` object that configures the display of lane boundaries on a bird's-eye plot. The `LaneBoundaryPlotter` object is stored in the `Plotters` property of the input `birdsEyePlot` object, `bep`. To display the lane boundaries, use the `plotLaneBoundary` function.

`lbPlotter = laneBoundaryPlotter(bep,Name,Value)` sets properties using one or more `Name,Value` pair arguments. For example, `laneBoundaryPlotter(bep,'DisplayName','Lane boundaries')` sets the display name that appears in the bird's-eye-plot legend.

Examples

Create and Display Lane Boundaries on Bird's-Eye Plot

Create left-lane and right-lane boundaries.

```
leftlb = parabolicLaneBoundary([-0.001,0.01,-1.8]);
rightlb = parabolicLaneBoundary([-0.001,0.01,1.8]);
```

Create a bird's-eye plot with an x-axis range from 0 to 30 meters and a y-axis range from -5 to 5 meters.

```
bep = birdsEyePlot('XLimits',[0 30],'YLimits',[-5 5]);
```

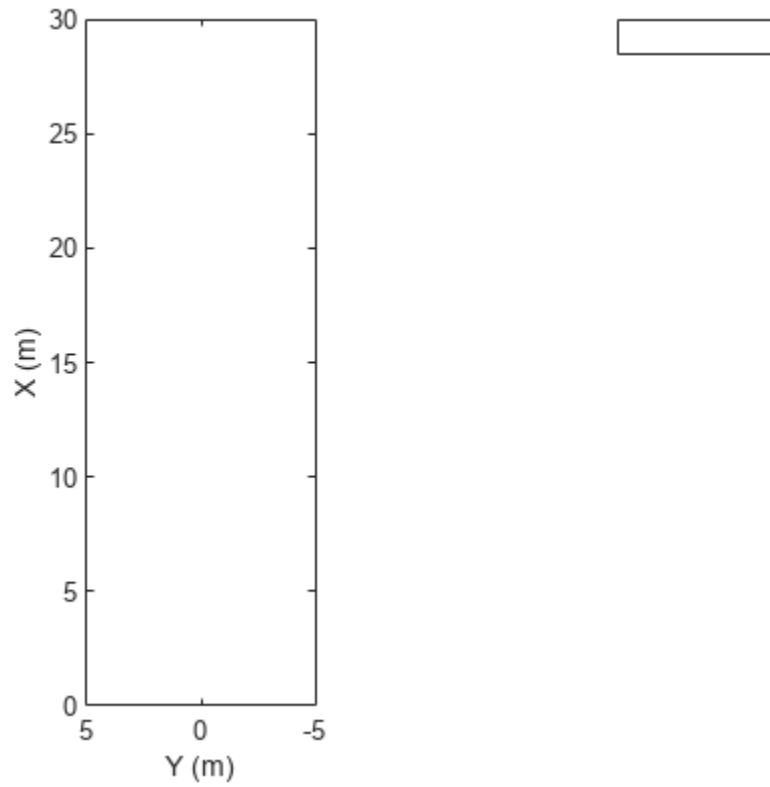

Create a lane boundary plotter.

```
lbPlotter = laneBoundaryPlotter(bep, 'DisplayName', 'Lane boundaries');
```

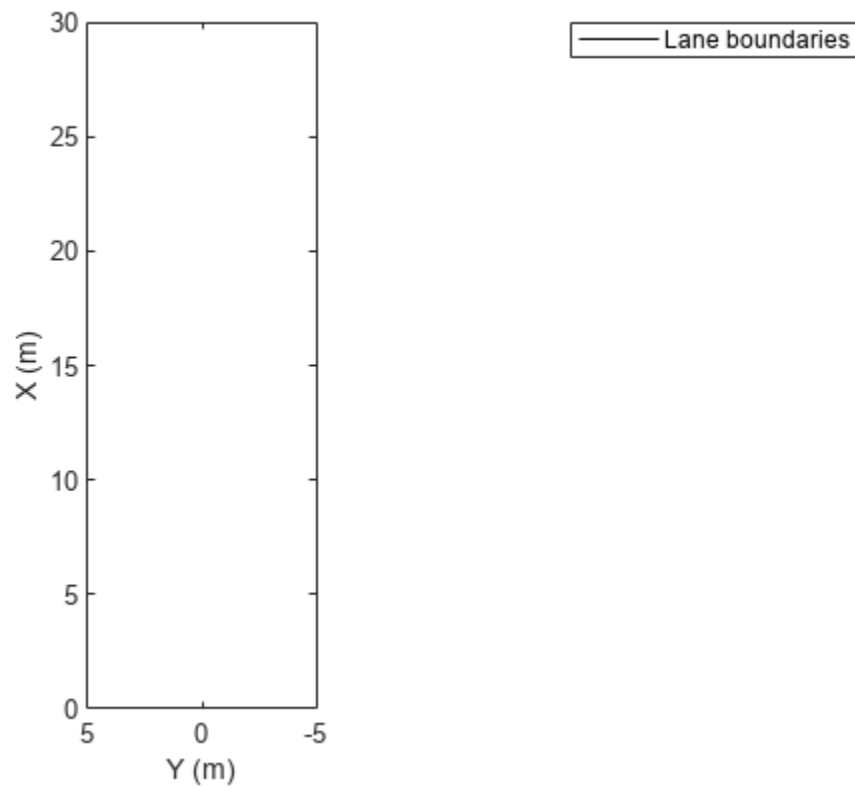

Display the lane boundaries on the bird's-eye plot.

```
plotLaneBoundary(lbPlotter,[leftlb rightlb]);
```

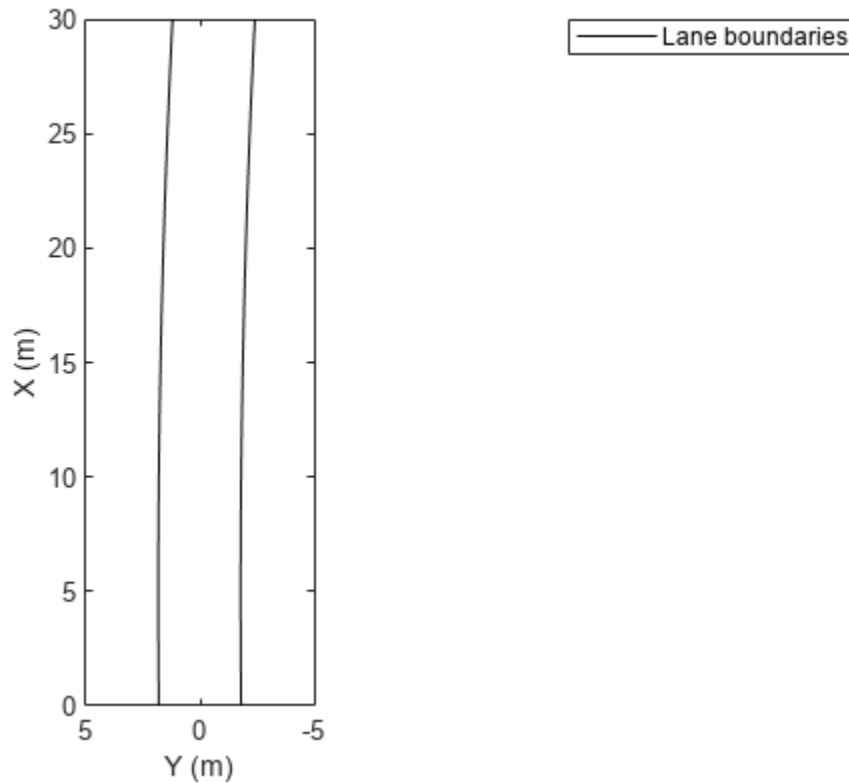

Input Arguments

bep — Bird's-eye plot

`birdsEyePlot` object

Bird's-eye plot, specified as a `birdsEyePlot` object.

Name-Value Pair Arguments

Specify optional pairs of arguments as `Name1=Value1, ..., NameN=ValueN`, where `Name` is the argument name and `Value` is the corresponding value. Name-value arguments must appear after other arguments, but the order of the pairs does not matter.

Before R2021a, use commas to separate each name and value, and enclose Name in quotes.

Example: `laneBoundaryPlotter('Color', 'red')` sets the color of lane boundaries to red.

DisplayName — Plotter name to display in legend

`''` (default) | character vector | string scalar

Plotter name to display in legend, specified as the comma-separated pair consisting of `'DisplayName'` and character vector or string scalar. If you do not specify a name, the bird's-eye plot does not display a legend entry for the plotter.

Color — Lane boundary color







`[0 0 0]` (black) (default) | RGB triplet | hexadecimal color code | color name | short color name

Lane boundary color, specified as the comma-separated pair consisting of 'Color' and an RGB triplet, a hexadecimal color code, a color name, or a short color name.

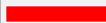



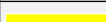

For a custom color, specify an RGB triplet or a hexadecimal color code.

- An RGB triplet is a three-element row vector whose elements specify the intensities of the red, green, and blue components of the color. The intensities must be in the range [0, 1], for example, [0.4 0.6 0.7].
- A hexadecimal color code is a string scalar or character vector that starts with a hash symbol (#) followed by three or six hexadecimal digits, which can range from 0 to F. The values are not case sensitive. Therefore, the color codes "#FF8800", "#ff8800", "#F80", and "#f80" are equivalent.

Alternatively, you can specify some common colors by name. This table lists the named color options, the equivalent RGB triplets, and hexadecimal color codes.

Color Name	Short Name	RGB Triplet	Hexadecimal Color Code	Appearance
"red"	"r"	[1 0 0]	"#FF0000"	
"green"	"g"	[0 1 0]	"#00FF00"	
"blue"	"b"	[0 0 1]	"#0000FF"	
"cyan"	"c"	[0 1 1]	"#00FFFF"	
"magenta"	"m"	[1 0 1]	"#FF00FF"	
"yellow"	"y"	[1 1 0]	"#FFFF00"	
"black"	"k"	[0 0 0]	"#000000"	
"white"	"w"	[1 1 1]	"#FFFFFF"	
"none"	Not applicable	Not applicable	Not applicable	No color



Here are the RGB triplets and hexadecimal color codes for the default colors MATLAB uses in many types of plots.

RGB Triplet	Hexadecimal Color Code	Appearance
[0 0.4470 0.7410]	"#0072BD"	
[0.8500 0.3250 0.0980]	"#D95319"	
[0.9290 0.6940 0.1250]	"#EDB120"	
[0.4940 0.1840 0.5560]	"#7E2F8E"	
[0.4660 0.6740 0.1880]	"#77AC30"	
[0.3010 0.7450 0.9330]	"#4DBEEE"	
[0.6350 0.0780 0.1840]	"#A2142F"	

LineStyle — Lane boundary line style

'-' (default) | '--' | ':' | '-.' | 'none'

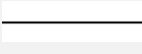
Lane boundary line style, specified as the comma-separated pair consisting of 'LineStyle' and one of the options listed in this table.

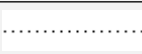
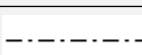
Line Style	Description	Resulting Line
"_"	Solid line	
"--"	Dashed line	
":"	Dotted line	
"-."	Dash-dotted line	
"none"	No line	No line

Tag — Tag associated with plotter object

'Plotter N ' (default) | character vector | string scalar

Tag associated with the plotter object, specified as the comma-separated pair consisting of 'Tag' and a character vector or string scalar. The default value is 'Plotter N ', where N is an integer that corresponds to the N th plotter associated with the input `birdsEyePlot` object.

Output Arguments

lbPlotter — Lane boundary plotter

LaneBoundaryPlotter object

Lane boundary plotter, returned as a `LaneBoundaryPlotter` object. You can modify this object by changing its property values. The property names correspond to the name-value pair arguments of the `laneBoundaryPlotter` function.

`lbPlotter` is stored in the `Plotters` property of the input `birdsEyePlot` object, `bep`. To plot the lane boundaries, use the `plotLaneBoundary` function.

Version History

Introduced in R2017a

See Also

`birdsEyePlot` | `plotLaneBoundary` | `findPlotter` | `clearData` | `clearPlotterData`

laneMarkingPlotter

Package:

Lane marking plotter for bird's-eye plot

Syntax

```
lmPlotter = laneMarkingPlotter(bep)
lmPlotter = laneMarkingPlotter(bep,Name,Value)
```

Description

`lmPlotter = laneMarkingPlotter(bep)` creates a `LaneMarkingPlotter` object that configures the display of lane markings on a bird's-eye plot. The `LaneMarkingPlotter` object is stored in the `Plotters` property of the input `birdsEyePlot` object, `bep`. To display the lane markings, use the `plotLaneMarking` function.

`lmPlotter = laneMarkingPlotter(bep,Name,Value)` sets properties using one or more `Name,Value` pair arguments. For example, `laneMarkingPlotter(bep,'DisplayName','Lane markings')` sets the display name that appears in the bird's-eye-plot legend.

Examples

Generate Object and Lane Boundary Detections

Create a driving scenario containing an ego vehicle and a target vehicle traveling along a three-lane road. Detect the lane boundaries by using a vision detection generator.

```
scenario = drivingScenario;
```

Create a three-lane road by using lane specifications.

```
roadCenters = [0 0 0; 60 0 0; 120 30 0];
lspc = lanespec(3);
road(scenario,roadCenters,'Lanes',lspc);
```

Specify that the ego vehicle follows the center lane at 30 m/s.

```
egovehicle = vehicle(scenario,'ClassID',1);
egopath = [1.5 0 0; 60 0 0; 111 25 0];
egospeed = 30;
smoothTrajectory(egovehicle,egopath,egospeed);
```

Specify that the target vehicle travels ahead of the ego vehicle at 40 m/s and changes lanes close to the ego vehicle.

```
targetcar = vehicle(scenario,'ClassID',1);
targetpath = [8 2; 60 -3.2; 120 33];
targetspeed = 40;
smoothTrajectory(targetcar,targetpath,targetspeed);
```

Display a chase plot for a 3-D view of the scenario from behind the ego vehicle.

```
chasePlot(egovehicle)
```

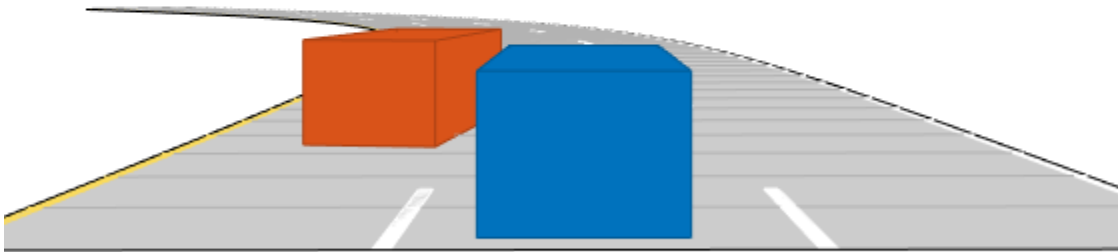

Create a vision detection generator that detects lanes and objects. The pitch of the sensor points one degree downward.

```
visionSensor = visionDetectionGenerator('Pitch',1.0);  
visionSensor.DetectorOutput = 'Lanes and objects';  
visionSensor.ActorProfiles = actorProfiles(scenario);
```

Run the simulation.

- 1 Create a bird's-eye plot and the associated plotters.
- 2 Display the sensor coverage area.
- 3 Display the lane markings.
- 4 Obtain ground truth poses of targets on the road.
- 5 Obtain ideal lane boundary points up to 60 m ahead.
- 6 Generate detections from the ideal target poses and lane boundaries.
- 7 Display the outline of the target.
- 8 Display object detections when the object detection is valid.
- 9 Display the lane boundary when the lane detection is valid.

```
bep = birdsEyePlot('XLim',[0 60],'YLim',[-35 35]);  
caPlotter = coverageAreaPlotter(bep,'DisplayName','Coverage area', ...
```

```

    'FaceColor','blue');
detPlotter = detectionPlotter(bep,'DisplayName','Object detections');
lmPlotter = laneMarkingPlotter(bep,'DisplayName','Lane markings');
lbPlotter = laneBoundaryPlotter(bep,'DisplayName', ...
    'Lane boundary detections','Color','red');
olPlotter = outlinePlotter(bep);
plotCoverageArea(caPlotter,visionSensor.SensorLocation,...
    visionSensor.MaxRange,visionSensor.Yaw, ...
    visionSensor.FieldOfView(1));
while advance(scenario)
    [lmv,lmf] = laneMarkingVertices(egovehicle);
    plotLaneMarking(lmPlotter,lmv,lmf)
    tgtpose = targetPoses(egovehicle);
    lookaheadDistance = 0:0.5:60;
    lb = laneBoundaries(egovehicle,'XDistance',lookaheadDistance,'LocationType','inner');
    [obdets,nobdets,obValid,lb_dets,nlb_dets,lbValid] = ...
        visionSensor(tgtpose,lb,scenario.SimulationTime);
    [objposition,objyaw,objlength,objwidth,objjoriginOffset,color] = targetOutlines(egovehicle);
    plotOutline(olPlotter,objposition,objyaw,objlength,objwidth, ...
        'OriginOffset',objjoriginOffset,'Color',color)
    if obValid
        detPos = cellfun(@(d)d.Measurement(1:2),obdets,'UniformOutput',false);
        detPos = vertcat(zeros(0,2),cell2mat(detPos)');
        plotDetection(detPlotter,detPos)
    end
    if lbValid
        plotLaneBoundary(lbPlotter,vertcat(lb_dets.LaneBoundaries))
    end
end
end

```

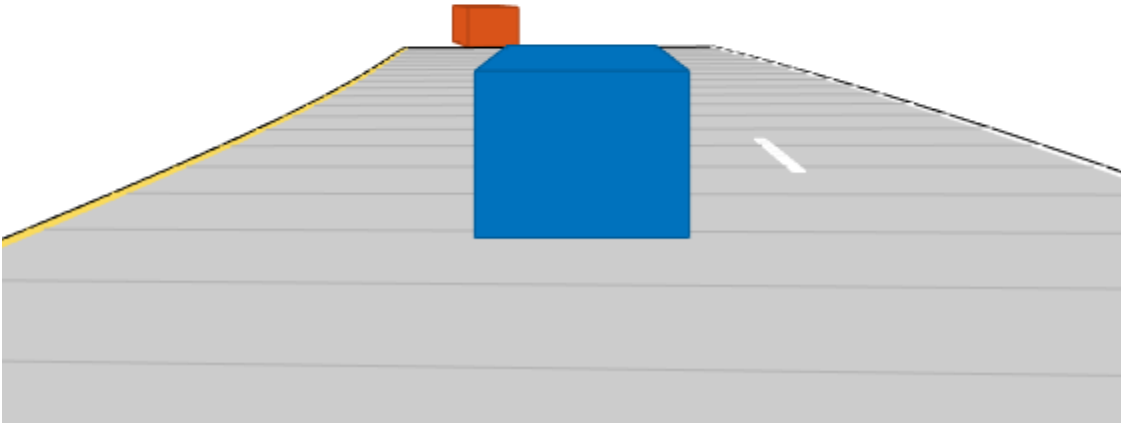

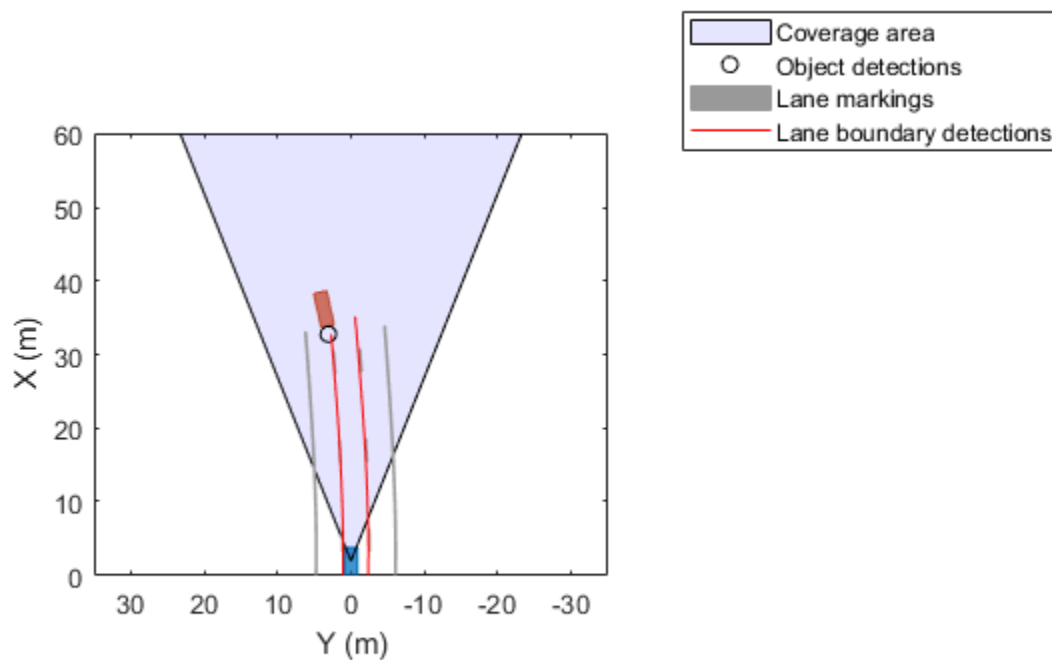

Input Arguments

bep — Bird's-eye plot

birdsEyePlot object

Bird's-eye plot, specified as a birdsEyePlot object.

Name-Value Pair Arguments

Specify optional pairs of arguments as Name1=Value1, ..., NameN=ValueN, where Name is the argument name and Value is the corresponding value. Name-value arguments must appear after other arguments, but the order of the pairs does not matter.

Before R2021a, use commas to separate each name and value, and enclose Name in quotes.

Example: laneBoundaryPlotter('Color', 'red') sets the color of lane markings to red.

DisplayName — Plotter name to display in legend

' ' (default) | character vector | string scalar









Plotter name to display in legend, specified as the comma-separated pair consisting of 'DisplayName' and character vector or string scalar. If you do not specify a name, the bird's-eye plot does not display a legend entry for the plotter.

FaceColor — Face color of lane marking patches

[0.6 0.6 0.6] (gray) (default) | RGB triplet | color name

Face color of lane marking patches, specified as the comma-separated pair consisting of 'FaceColor' and an RGB triplet or one of the color names listed in the table.

For a custom color, specify an RGB triplet. An RGB triplet is a three-element row vector whose elements specify the intensities of the red, green, and blue components of the color. The intensities must be in the range [0, 1]; for example, [0.4 0.6 0.7]. Alternatively, you can specify some common colors by name. This table lists the named color options and the equivalent RGB triplet values.

Color Name	RGB Triplet	Appearance
'red'	[1 0 0]	
'green'	[0 1 0]	
'blue'	[0 0 1]	
'cyan'	[0 1 1]	
'magenta'	[1 0 1]	
'yellow'	[1 1 0]	
'black'	[0 0 0]	
'white'	[1 1 1]	

Tag — Tag associated with plotter object

'PlotterN' (default) | character vector | string scalar

Tag associated with the plotter object, specified as the comma-separated pair consisting of 'Tag' and a character vector or string scalar. The default value is 'PlotterN', where N is an integer that corresponds to the Nth plotter associated with the input birdsEyePlot object.

Output Arguments

lmPlotter — Lane marking plotter

LaneMarkingPlotter object

Lane marking plotter, returned as a LaneMarkingPlotter object. You can modify this object by changing its property values. The property names correspond to the name-value pair arguments of the laneMarkingPlotter function.

lmPlotter is stored in the Plotters property of the input birdsEyePlot object, bep. To plot the lane markings, use the plotLaneMarking function.

Version History

Introduced in R2018a

See Also

birdsEyePlot | plotLaneMarking | plotParkingLaneMarking | findPlotter | clearData | clearPlotterData

meshPlotter

Package:

Mesh plotter for bird's-eye plot

Syntax

```
mPlotter = meshPlotter(bep)
mPlotter = meshPlotter(bep,Name,Value)
```

Description

`mPlotter = meshPlotter(bep)` creates a `MeshPlotter` object that configures the display of meshes on page 4-57 on a bird's-eye plot. The `MeshPlotter` object is stored in the `Plotters` property of the input `birdsEyePlot` object, `bep`. To display the mesh representations of objects, use the `plotMesh` function.

`mPlotter = meshPlotter(bep,Name,Value)` sets properties using one or more `Name,Value` pair arguments. For example, `meshPlotter(bep, 'FaceAlpha', 1)` sets the mesh faces to be fully opaque.

Examples

Display Actor Meshes in Driving Scenario

Display actors in a driving scenario by using their mesh representations instead of their cuboid representations.

Create a driving scenario, and add a 25-meter straight road to the scenario.

```
scenario = drivingScenario;
roadcenters = [0 0 0; 25 0 0];
road(scenario,roadcenters);
```

Add a pedestrian and a vehicle to the scenario. Specify the mesh dimensions of the actors using prebuilt meshes.

- Specify the pedestrian mesh as a `driving.scenario.pedestrianMesh` object.
- Specify the vehicle mesh as a `driving.scenario.carMesh` object.

```
p = actor(scenario,'ClassID',4, ...
          'Length',0.2,'Width',0.4, ...
          'Height',1.7,'Mesh',driving.scenario.pedestrianMesh);
v = vehicle(scenario,'ClassID',1, ...
            'Mesh',driving.scenario.carMesh);
```

Add trajectories for the pedestrian and vehicle.

- Specify for the pedestrian to cross the road at 1 meter per second.
- Specify for the vehicle to follow the road at 10 meters per second.

```
waypointsP = [15 -3 0; 15 3 0];  
speedP = 1;  
smoothTrajectory(p,waypointsP,speedP);
```

```
wayPointsV = [v.RearOverhang 0 0; (25 - v.Length + v.RearOverhang) 0 0];  
speedV = 10;  
smoothTrajectory(v,wayPointsV,speedV)
```

Add an egocentric plot for the vehicle. Turn the display of meshes on.

```
chasePlot(v, 'Meshes', 'on')
```

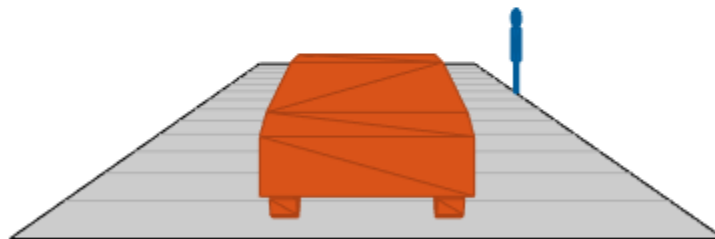

Create a bird's-eye plot in which to display the meshes. Also create a mesh plotter and lane boundary plotter. Then run the simulation loop.

- 1 Obtain the road boundaries of the road the vehicle is on.
- 2 Obtain the mesh vertices, faces, and colors of the actor meshes, with positions relative to the vehicle.
- 3 Plot the road boundaries and actor meshes on the bird's-eye plot.
- 4 Pause the scenario to allow time for the plots to update. The chase plot updates every time you advance the scenario.

```
bep = birdsEyePlot('XLim',[-25 25],'YLim',[-10 10]);  
mPlotter = meshPlotter(bep);  
lbPlotter = laneBoundaryPlotter(bep);  
legend('off')  
  
while advance(scenario)  
    rb = roadBoundaries(v);  
  
    [vertices,faces,colors] = targetMeshes(v);  
  
    plotLaneBoundary(lbPlotter,rb)  
    plotMesh(mPlotter,vertices,faces,'Color',colors)  
  
    pause(0.01)  
end
```

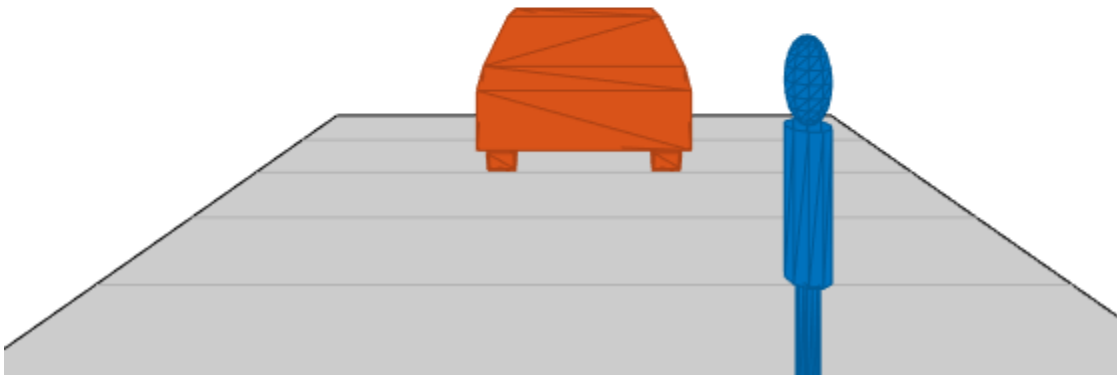

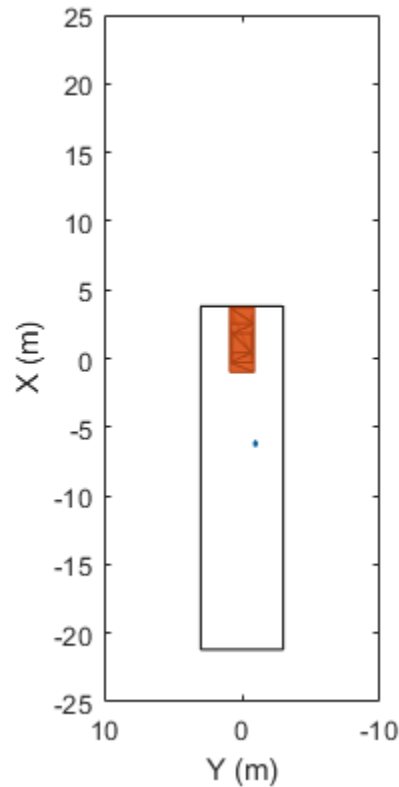

Input Arguments

bep — Bird's-eye plot

`birdsEyePlot` object

Bird's-eye plot, specified as a `birdsEyePlot` object.

Name-Value Pair Arguments

Specify optional pairs of arguments as `Name1=Value1, ..., NameN=ValueN`, where `Name` is the argument name and `Value` is the corresponding value. Name-value arguments must appear after other arguments, but the order of the pairs does not matter.

Before R2021a, use commas to separate each name and value, and enclose Name in quotes.

Example: `meshPlotter('FaceAlpha',0.5)` sets the mesh faces to be 50% transparent.

FaceAlpha — Transparency of mesh faces

0.75 (default) | scalar in the range [0, 1]

Transparency of mesh faces, specified as the comma-separated pair consisting of 'FaceAlpha' and a scalar in the range [0, 1]. A value of 0 makes the mesh faces fully transparent. A value of 1 makes the mesh faces fully opaque.

Tag — Tag associated with plotter object

'PlotterN' (default) | character vector | string scalar

Tag associated with the plotter object, specified as the comma-separated pair consisting of 'Tag' and a character vector or string scalar. The default value is 'Plotter N ', where N is an integer that corresponds to the N th plotter associated with the input `birdsEyePlot` object.

Output Arguments

mPlotter – Mesh plotter

MeshPlotter object

Mesh plotter, returned as a `MeshPlotter` object. You can modify this object by changing its property values. The property names correspond to the name-value pair arguments of the `meshPlotter` function.



`mPlotter` is stored in the `Plotters` property of the input `birdsEyePlot` object, `bep`. To plot the meshes, use the `plotMesh` function.

More About

Meshes

In driving scenarios, a mesh is a triangle-based 3-D representation of an object. Mesh representations of objects are more detailed than the default cuboid (box-shaped) representations of objects. Meshes are useful for generating synthetic point cloud data from a driving scenario.

This table shows the difference between a cuboid representation and a mesh representation of a vehicle in a driving scenario.

Cuboid	Mesh
	

Version History

Introduced in R2020b

See Also

`birdsEyePlot` | `plotMesh` | `clearData` | `clearPlotterData` | `targetMeshes`

outlinePlotter

Package:

Outline plotter for bird's-eye plot

Syntax

```
olPlotter = outlinePlotter(bep)
olPlotter = outlinePlotter(bep,Name,Value)
```

Description

`olPlotter = outlinePlotter(bep)` creates an `OutlinePlotter` object that configures the display of object outlines on a bird's-eye plot. The `OutlinePlotter` object is stored in the `Plotters` property of the `birdsEyePlot` object, `bep`. To display the outlines of actors that are in a driving scenario, first use `targetOutlines` to get the dimensions of the actors and barriers. Then, after creating an outline plotter object, use the `plotOutline` and `plotBarrierOutline` functions to display the outlines of all the actors and barriers in the bird's-eye plot, respectively.

`olPlotter = outlinePlotter(bep,Name,Value)` sets properties using one or more `Name,Value` pair arguments. For example, `outlinePlotter(bep, 'FaceAlpha', 0)` sets the areas within each outline to be fully transparent.

Examples

Plot Outlines of Targets on Bird's-Eye Plot

Create a driving scenario. Create a 25 m road segment with a barrier on its left edge. Add a pedestrian that crosses the road at 1 m/s, and a vehicle that drives along the road at 10 m/s.

```
scenario = drivingScenario;

r = road(scenario,[0 0 0; 25 0 0]);
barrier(scenario,r,'RoadEdge','left')

p = actor(scenario,'ClassID',4,'Length',0.2,'Width',0.4,'Height',1.7);
v = vehicle(scenario,'ClassID',1);

smoothTrajectory(p,[15 -3 0; 15 3 0],1)
smoothTrajectory(v,[v.RearOverhang 0 0; 25-v.Length+v.RearOverhang 0 0],10)
```

Use a chase plot to display the scenario from the perspective of the vehicle.

```
chasePlot(v,'Centerline','on')
```

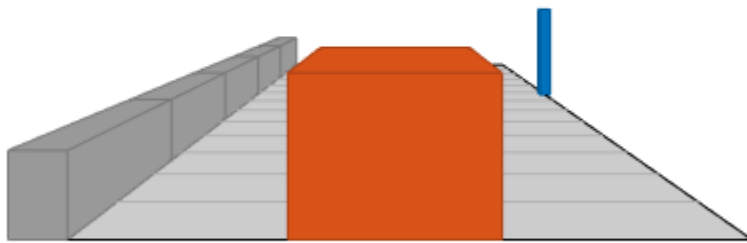

Create a bird's-eye plot, outline plotter, and lane boundary plotter.

```
bep = birdsEyePlot('XLim',[-25 25], 'YLim',[-10 10]);  
olPlotter = outlinePlotter(bep);  
lbPlotter = laneBoundaryPlotter(bep);  
legend('off')
```

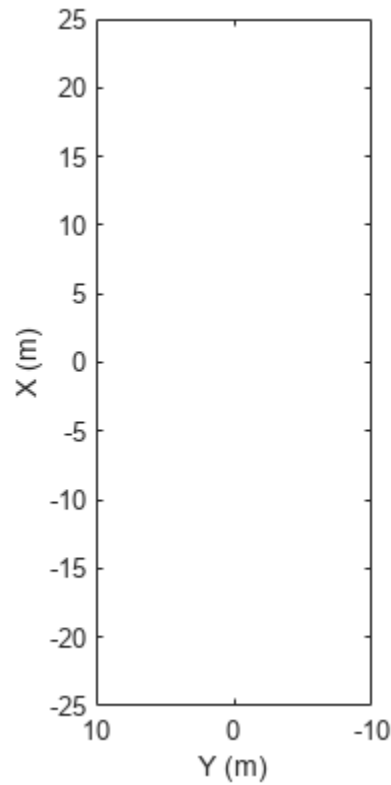

Run the simulation loop. Update the plotter with outlines for the targets.

```

while advance(scenario)
    % Obtain the road boundaries and rectangular outlines.
    rb = roadBoundaries(v);
    [position,yaw,length,width,originOffset,color] = targetOutlines(v);
    [bposition,byaw,blength,bwidth,boriginOffset,bcolor,numBarrierSegments] = targetOutlines(v,'B');

    % Update the bird's-eye plotters with the road, actors and barriers.
    plotLaneBoundary(lbPlotter,rb);
    plotOutline(olPlotter,position,yaw,length,width, ...
        'OriginOffset',originOffset,'Color',color);
    plotBarrierOutline(olPlotter,numBarrierSegments,bposition,byaw,blength,bwidth, ...
        'OriginOffset',boriginOffset,'Color',bcolor);
    % Allow time for plot to update.
    pause(0.01)
end

```

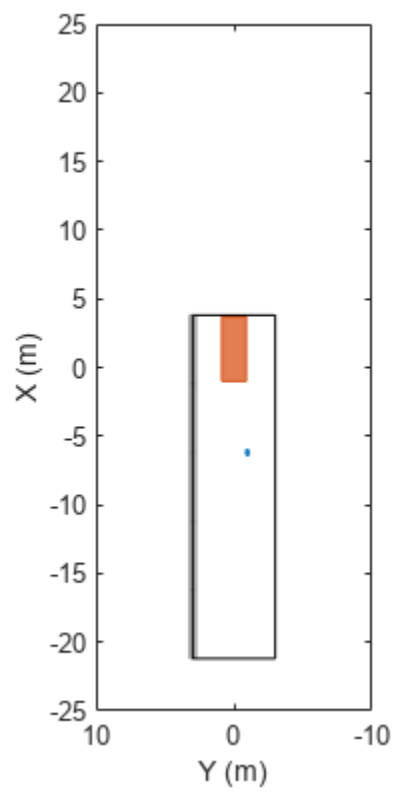

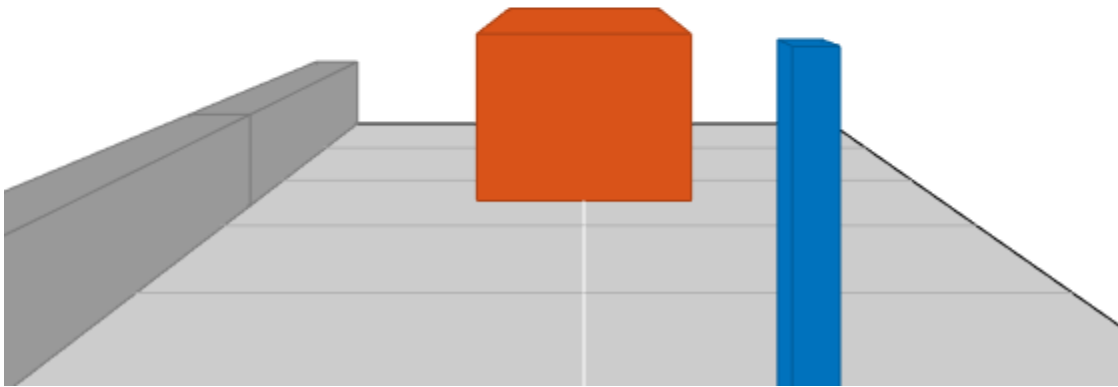

Input Arguments

bep — Bird's-eye plot

`birdsEyePlot` object

Bird's-eye plot, specified as a `birdsEyePlot` object.

Name-Value Pair Arguments

Specify optional pairs of arguments as `Name1=Value1, ..., NameN=ValueN`, where `Name` is the argument name and `Value` is the corresponding value. Name-value arguments must appear after other arguments, but the order of the pairs does not matter.

Before R2021a, use commas to separate each name and value, and enclose Name in quotes.

Example: `outlinePlotter('FaceAlpha',1)` sets the areas within each outline to be fully opaque.

FaceAlpha — Transparency of area within each outline

0.75 (default) | real scalar

Transparency of the area within each outline, specified as the comma-separated pair consisting of 'FaceAlpha' and a real scalar in the range [0, 1]. A value of 0 makes the areas fully transparent. A value of 1 makes the areas fully opaque.

Tag — Tag associated with plotter object

'PlotterN' (default) | character vector | string scalar

Tag associated with the plotter object, specified as the comma-separated pair consisting of 'Tag' and a character vector or string scalar. The default value is 'Plotter*N*', where *N* is an integer that corresponds to the *N*th plotter associated with the input `birdsEyePlot` object.

Output Arguments

olPlotter – Outline plotter

OutlinePlotter object

Outline plotter, returned as an `OutlinePlotter` object. You can modify this object by changing its property values. The property names correspond to the name-value pair arguments of the `outlinePlotter` function.

`olPlotter` is stored in the `Plotters` property of a `birdsEyePlot` object. To plot the outlines of actors that are in a driving scenario, first use `targetOutlines` to get the dimensions of the actors and barriers. Then, after calling `outlinePlotter` to create a plotter object, use `plotOutline` and `plotBarrierOutline` to plot the outlines of all the actors and barriers in a bird's-eye plot, respectively.

Version History

Introduced in R2017b

See Also

`birdsEyePlot` | `plotOutline` | `plotBarrierOutline` | `findPlotter` | `clearData` | `clearPlotterData`

pathPlotter

Package:

Path plotter for bird's-eye plot

Syntax

```
pPlotter = pathPlotter(bep)
pPlotter = pathPlotter(bep,Name,Value)
```

Description

`pPlotter = pathPlotter(bep)` creates a `PathPlotter` object that configures the display of actor paths on a bird's-eye plot. The `PathPlotter` object is stored in the `Plotters` property of the input `birdsEyePlot` object, `bep`. To display the paths, use the `plotPath` function.

`pPlotter = pathPlotter(bep,Name,Value)` sets properties using one or more `Name,Value` pair arguments. For example, `pathPlotter(bep,'DisplayName','Actor paths')` sets the display name that appears in the bird's-eye-plot legend.

Examples

Plot Path of Ego Vehicle

Create a 3-meter-wide lane.

```
lb = parabolicLaneBoundary([-0.001,0.01,1.5]);
rb = parabolicLaneBoundary([-0.001,0.01,-1.5]);
```

Compute the lane boundary model manually from 0 to 30 meters along the x-axis.

```
xWorld = (0:30)';
yLeft = computeBoundaryModel(lb,xWorld);
yRight = computeBoundaryModel(rb,xWorld);
```

Create a bird's-eye plot and lane boundary plotter. Display the lane information on the bird's-eye plot.

```
bep = birdsEyePlot('XLimits',[0 30],'YLimits',[-5 5]);
lanePlotter = laneBoundaryPlotter(bep,'DisplayName','Lane boundaries');
plotLaneBoundary(lanePlotter,{[xWorld,yLeft],[xWorld,yRight]});
```

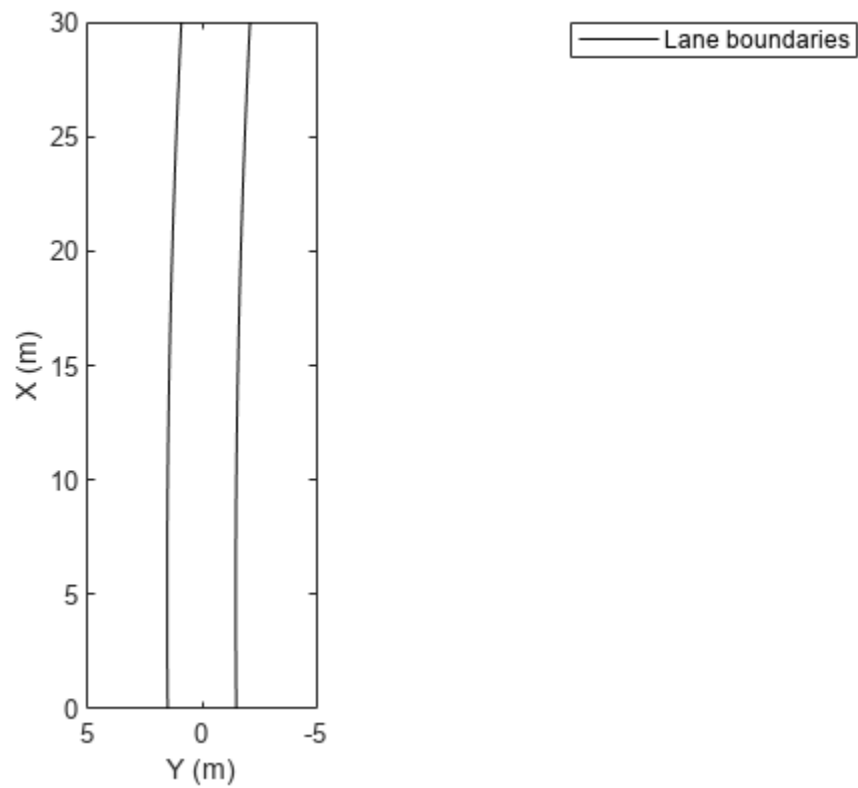

Create a path plotter. Create and display the path of an ego vehicle that travels through the center of the lane.

```
yCenter = (yLeft + yRight)/2;  
egoPathPlotter = pathPlotter(bep, 'DisplayName', 'Ego vehicle path');  
plotPath(egoPathPlotter, {[xWorld, yCenter]});
```

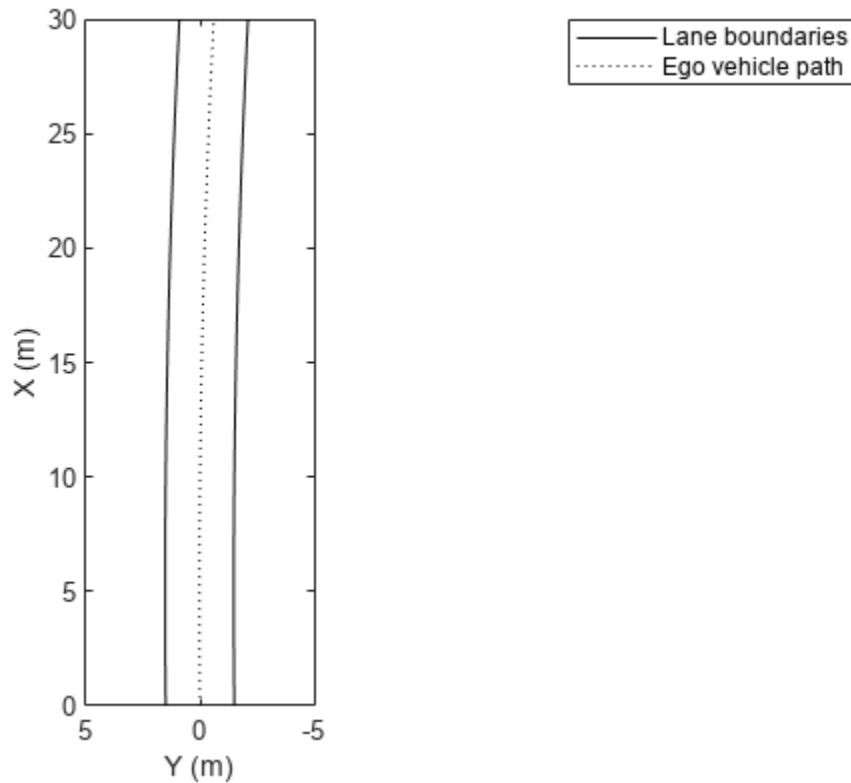

Input Arguments

bep — Bird's-eye plot

`birdsEyePlot` object

Bird's-eye plot, specified as a `birdsEyePlot` object.

Name-Value Pair Arguments

Specify optional pairs of arguments as `Name1=Value1, ..., NameN=ValueN`, where `Name` is the argument name and `Value` is the corresponding value. Name-value arguments must appear after other arguments, but the order of the pairs does not matter.

Before R2021a, use commas to separate each name and value, and enclose Name in quotes.

Example: `pathPlotter('Color', 'red')` sets the color of the path to red.

DisplayName — Plotter name to display in legend

`''` (default) | character vector | string scalar

Plotter name to display in legend, specified as the comma-separated pair consisting of `'DisplayName'` and character vector or string scalar. If you do not specify a name, the bird's-eye plot does not display a legend entry for the plotter.

Color — Path color







`[0 0 0]` (black) (default) | RGB triplet | hexadecimal color code | color name | short color name

Path color, specified as the comma-separated pair consisting of 'Color' and an RGB triplet, a hexadecimal color code, a color name, or a short color name.

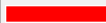



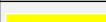

For a custom color, specify an RGB triplet or a hexadecimal color code.

- An RGB triplet is a three-element row vector whose elements specify the intensities of the red, green, and blue components of the color. The intensities must be in the range $[0, 1]$, for example, $[0.4 \ 0.6 \ 0.7]$.
- A hexadecimal color code is a string scalar or character vector that starts with a hash symbol (#) followed by three or six hexadecimal digits, which can range from 0 to F. The values are not case sensitive. Therefore, the color codes "#FF8800", "#ff8800", "#F80", and "#f80" are equivalent.

Alternatively, you can specify some common colors by name. This table lists the named color options, the equivalent RGB triplets, and hexadecimal color codes.

Color Name	Short Name	RGB Triplet	Hexadecimal Color Code	Appearance
"red"	"r"	[1 0 0]	"#FF0000"	
"green"	"g"	[0 1 0]	"#00FF00"	
"blue"	"b"	[0 0 1]	"#0000FF"	
"cyan"	"c"	[0 1 1]	"#00FFFF"	
"magenta"	"m"	[1 0 1]	"#FF00FF"	
"yellow"	"y"	[1 1 0]	"#FFFF00"	
"black"	"k"	[0 0 0]	"#000000"	
"white"	"w"	[1 1 1]	"#FFFFFF"	
"none"	Not applicable	Not applicable	Not applicable	No color



Here are the RGB triplets and hexadecimal color codes for the default colors MATLAB uses in many types of plots.

RGB Triplet	Hexadecimal Color Code	Appearance
[0 0.4470 0.7410]	"#0072BD"	
[0.8500 0.3250 0.0980]	"#D95319"	
[0.9290 0.6940 0.1250]	"#EDB120"	
[0.4940 0.1840 0.5560]	"#7E2F8E"	
[0.4660 0.6740 0.1880]	"#77AC30"	
[0.3010 0.7450 0.9330]	"#4DBEEE"	
[0.6350 0.0780 0.1840]	"#A2142F"	

LineStyle — Path line style

' : ' (default) | '- ' | '- - ' | '- . ' | 'none'

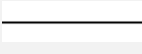
Path line style, specified as the comma-separated pair consisting of 'LineStyle' and one of the options listed in this table.

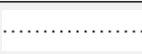
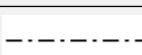
Line Style	Description	Resulting Line
"_"	Solid line	
"--"	Dashed line	
":"	Dotted line	
"-."	Dash-dotted line	
"none"	No line	No line

Tag — Tag associated with plotter object

'PlotterN' (default) | character vector | string scalar

Tag associated with the plotter object, specified as the comma-separated pair consisting of 'Tag' and a character vector or string scalar. The default value is 'PlotterN', where *N* is an integer that corresponds to the *N*th plotter associated with the input `birdsEyePlot` object.

Output Arguments

pPlotter — Path plotter

PathPlotter object

Path plotter, returned as a `PathPlotter` object. You can modify this object by changing its property values. The property names correspond to the name-value pair arguments of the `pathPlotter` function.

`pPlotter` is stored in the `Plotters` property of the input `birdsEyePlot` object, `bep`. To plot the paths, use the `plotPath` function.

Version History

Introduced in R2017a

See Also

`birdsEyePlot` | `plotPath` | `findPlotter` | `clearData` | `clearPlotterData`

pointCloudPlotter

Package:

Point cloud plotter for bird's-eye plot

Syntax

```
pcPlotter = pointCloudPlotter(bep)
pcPlotter = pointCloudPlotter(bep,Name,Value)
```

Description

`pcPlotter = pointCloudPlotter(bep)` creates a point cloud plotter object that configures the display of lidar point cloud data on a bird's-eye plot. The point cloud plotter object is stored in the `Plotters` property of the input bird's-eye plot object, `bep`. To plot the lidar point cloud data, use the `plotPointCloud` function.

`pcPlotter = pointCloudPlotter(bep,Name,Value)` specifies options using one or more name-value pair arguments. For example, `'DisplayName','Point Cloud'` sets the display name that appears in the bird's-eye-plot legend to "Point Cloud".

Examples

Generate Lidar Point Cloud Data of Multiple Actors

Generate lidar point cloud data for a driving scenario with multiple actors by using the `lidarPointCloudGenerator` System object. Create the driving scenario by using `drivingScenario` object. It contains an ego-vehicle, pedestrian and two other vehicles.

Create and plot a driving scenario with multiple vehicles

Create a driving scenario.

```
scenario = drivingScenario;
```

Add a straight road to the driving scenario. The road has one lane in each direction.

```
roadCenters = [0 0 0; 70 0 0];
laneSpecification = lanespec([1 1]);
road(scenario,roadCenters,'Lanes',laneSpecification);
```

Add an ego vehicle to the driving scenario.

```
egoVehicle = vehicle(scenario,'ClassID',1,'Mesh',driving.scenario.carMesh);
waypoints = [1 -2 0; 35 -2 0];
smoothTrajectory(egoVehicle,waypoints,10);
```

Add a truck, pedestrian, and bicycle to the driving scenario and plot the scenario.

```
truck = vehicle(scenario,'ClassID',2,'Length', 8.2,'Width',2.5,'Height',3.5, ...
    'Mesh',driving.scenario.truckMesh);
```

```

waypoints = [70 1.7 0; 20 1.9 0];
smoothTrajectory(truck,waypoints,15);

pedestrian = actor(scenario,'ClassID',4,'Length',0.24,'Width',0.45,'Height',1.7, ...
    'Mesh',driving.scenario.pedestrianMesh);
waypoints = [23 -4 0; 10.4 -4 0];
smoothTrajectory(pedestrian,waypoints,1.5);

bicycle = actor(scenario,'ClassID',3,'Length',1.7,'Width',0.45,'Height',1.7, ...
    'Mesh',driving.scenario.bicycleMesh);
waypoints = [12.7 -3.3 0; 49.3 -3.3 0];
smoothTrajectory(bicycle,waypoints,5);

plot(scenario,'Meshes','on')

```

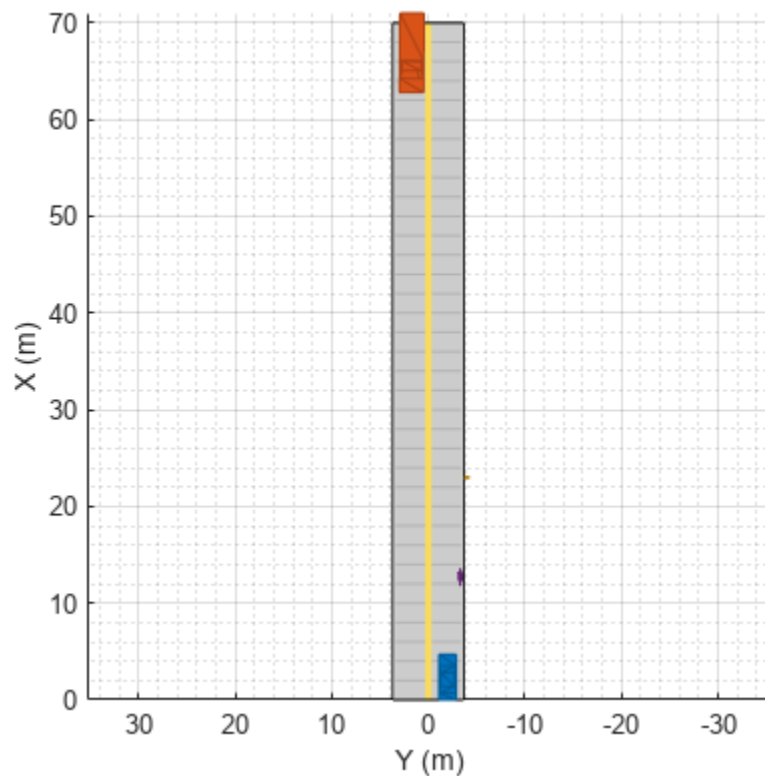

Generate and plot lidar point cloud data

Create a `lidarPointCloudGenerator` System object.

```
lidar = lidarPointCloudGenerator;
```

Add actor profiles and the ego vehicle actor ID from the driving scenario to the System object.

```
lidar.ActorProfiles = actorProfiles(scenario);
lidar.EgoVehicleActorID = egoVehicle.ActorID;
```

Plot the point cloud data.

```
bep = birdsEyePlot('Xlimits',[0 70],'Ylimits',[-30 30]);  
plotter = pointCloudPlotter(bep);  
legend('off');  
while advance(scenario)  
    tgts = targetPoses(egoVehicle);  
    rdmesh = roadMesh(egoVehicle);  
    [ptCloud,isValidTime] = lidar(tgts,rdmesh,scenario.SimulationTime);  
    if isValidTime  
        plotPointCloud(plotter,ptCloud);  
    end  
end
```

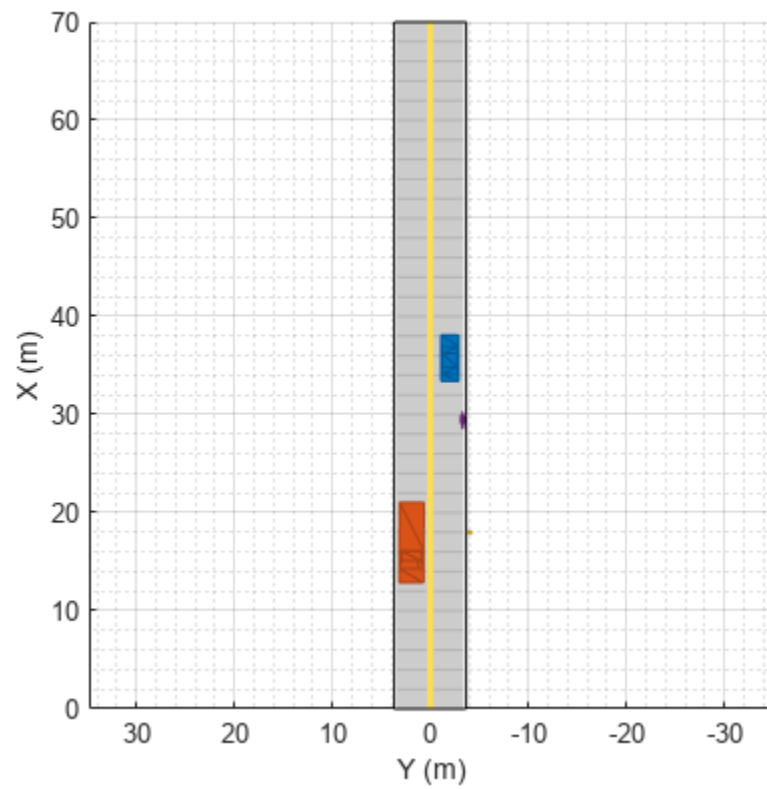

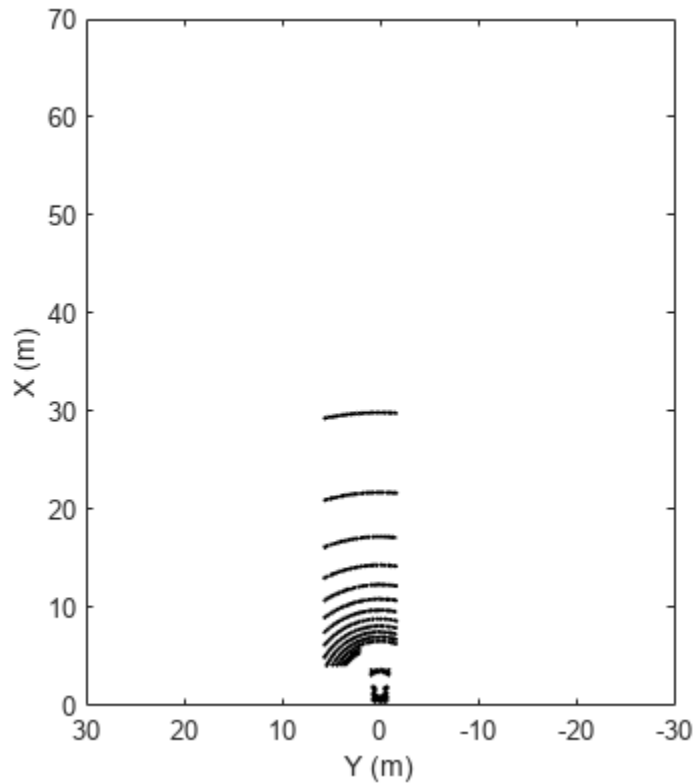

Input Arguments

bep — Bird's-eye plot

`birdsEyePlot` object

Bird's-eye plot, specified as a `birdsEyePlot` object.

Name-Value Pair Arguments

Specify optional pairs of arguments as `Name1=Value1, ..., NameN=ValueN`, where `Name` is the argument name and `Value` is the corresponding value. Name-value arguments must appear after other arguments, but the order of the pairs does not matter.

Before R2021a, use commas to separate each name and value, and enclose Name in quotes.

Example: `'DisplayName', 'Point Cloud'` sets the display name that appears in the bird's-eye-plot legend to "Point Cloud".

DisplayName — Plotter name to display in legend

`'` (default) | character vector | string scalar

Plotter name to display in legend, specified as the comma-separated pair consisting of `'DisplayName'` and character vector or string scalar. If you do not specify a name, the bird's-eye plot does not display a legend entry for the plotter.

Data Types: `char` | `string`

PointSize – Size of marker for points in point cloud

6 (default) | positive integer

Size of marker for points in a point cloud, specified as the comma-separated pair consisting of 'PointSize' and a positive integer in points.

Color – Point fill color







'none' (default) | RGB triplet | hexadecimal color code | color name | short color name

Point fill color, specified as the comma-separated pair consisting of 'Color' and an RGB triplet, a hexadecimal color code, a color name, or a short color name.



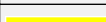

For a custom color, specify an RGB triplet or a hexadecimal color code.



- An RGB triplet is a three-element row vector whose elements specify the intensities of the red, green, and blue components of the color. The intensities must be in the range $[0, 1]$, for example, $[0.4 \ 0.6 \ 0.7]$.
- A hexadecimal color code is a string scalar or character vector that starts with a hash symbol (#) followed by three or six hexadecimal digits, which can range from 0 to F. The values are not case sensitive. Therefore, the color codes "#FF8800", "#ff8800", "#F80", and "#f80" are equivalent.

Alternatively, you can specify some common colors by name. This table lists the named color options, the equivalent RGB triplets, and hexadecimal color codes.

Color Name	Short Name	RGB Triplet	Hexadecimal Color Code	Appearance
"red"	"r"	[1 0 0]	"#FF0000"	
"green"	"g"	[0 1 0]	"#00FF00"	
"blue"	"b"	[0 0 1]	"#0000FF"	
"cyan"	"c"	[0 1 1]	"#00FFFF"	
"magenta"	"m"	[1 0 1]	"#FF00FF"	
"yellow"	"y"	[1 1 0]	"#FFFF00"	
"black"	"k"	[0 0 0]	"#000000"	
"white"	"w"	[1 1 1]	"#FFFFFF"	
"none"	Not applicable	Not applicable	Not applicable	No color

Here are the RGB triplets and hexadecimal color codes for the default colors MATLAB uses in many types of plots.

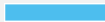
RGB Triplet	Hexadecimal Color Code	Appearance
[0 0.4470 0.7410]	"#0072BD"	
[0.8500 0.3250 0.0980]	"#D95319"	
[0.9290 0.6940 0.1250]	"#EDB120"	
[0.4940 0.1840 0.5560]	"#7E2F8E"	
[0.4660 0.6740 0.1880]	"#77AC30"	

RGB Triplet	Hexadecimal Color Code	Appearance
[0.3010 0.7450 0.9330]	"#4DBEEE"	
[0.6350 0.0780 0.1840]	"#A2142F"	

Tag — Tag associated with plotter object

'Plotter N ' (default) | character vector | string scalar

Tag associated with the plotter object, specified as the comma-separated pair consisting of 'Tag' and a character vector or string scalar. The default value is 'Plotter N ', where N is an integer that corresponds to the N th plotter associated with the input `birdsEyePlot` object.

Output Arguments

pcPlotter — Point cloud plotter

`pointCloudPlotter` object

Point cloud plotter, returned as a `pointCloudPlotter` object. You can modify this object by changing its property values.

`pcPlotter` is stored in the `Plotters` property of the input, `bep`. To plot the point cloud data, use the `plotPointCloud` function.

Version History

Introduced in R2020a

See Also

`birdsEyePlot` | `plotPointCloud` | `findPlotter` | `clearData` | `clearPlotterData`

plotCoverageArea

Display sensor coverage area on bird's-eye plot

Syntax

```
plotCoverageArea(caPlotter,position,range,orientation,fieldOfView)
```

Description

`plotCoverageArea(caPlotter,position,range,orientation,fieldOfView)` displays the coverage area of an ego vehicle sensor on a bird's-eye plot. Specify the position, range, orientation angle, and field of view of the sensor. The coverage area plotter, `caPlotter`, is associated with a `birdsEyePlot` object and configures the display of sensor coverage areas.

Examples

Display Coverage Area for Radar Sensor

Create a bird's-eye plot with an x-axis range from 0 to 90 meters and a y-axis range from -35 to 35 meters.

```
bep = birdsEyePlot('XLim',[0 90],'YLim',[-35 35]);
```

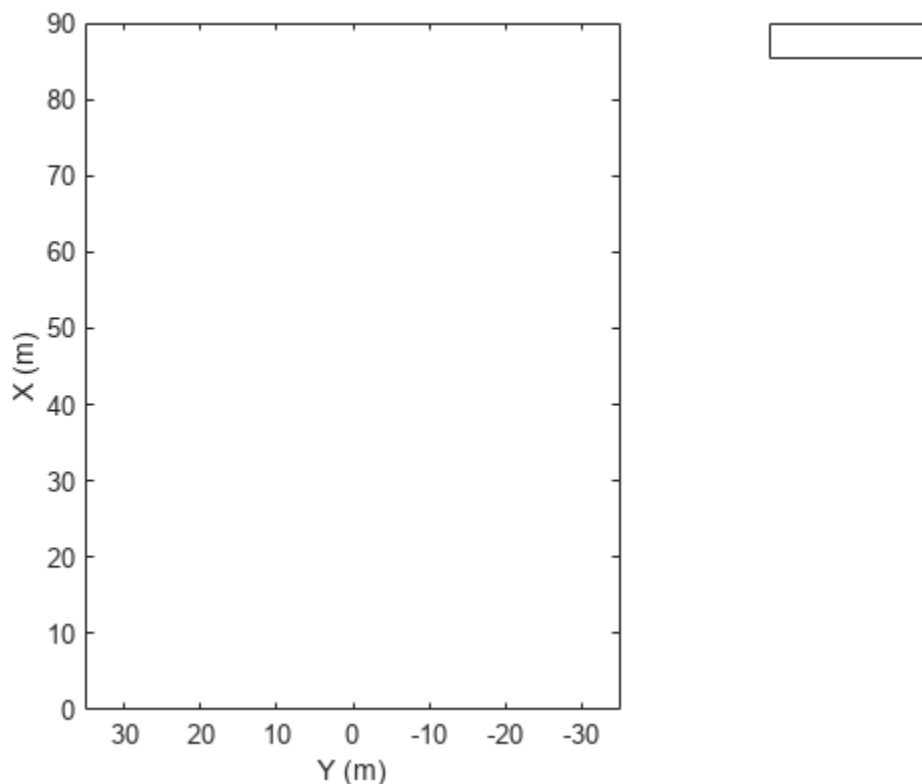

Create a coverage area plotter for the bird's-eye plot.

```
caPlotter = coverageAreaPlotter(bep, 'DisplayName', 'Radar coverage area');
```

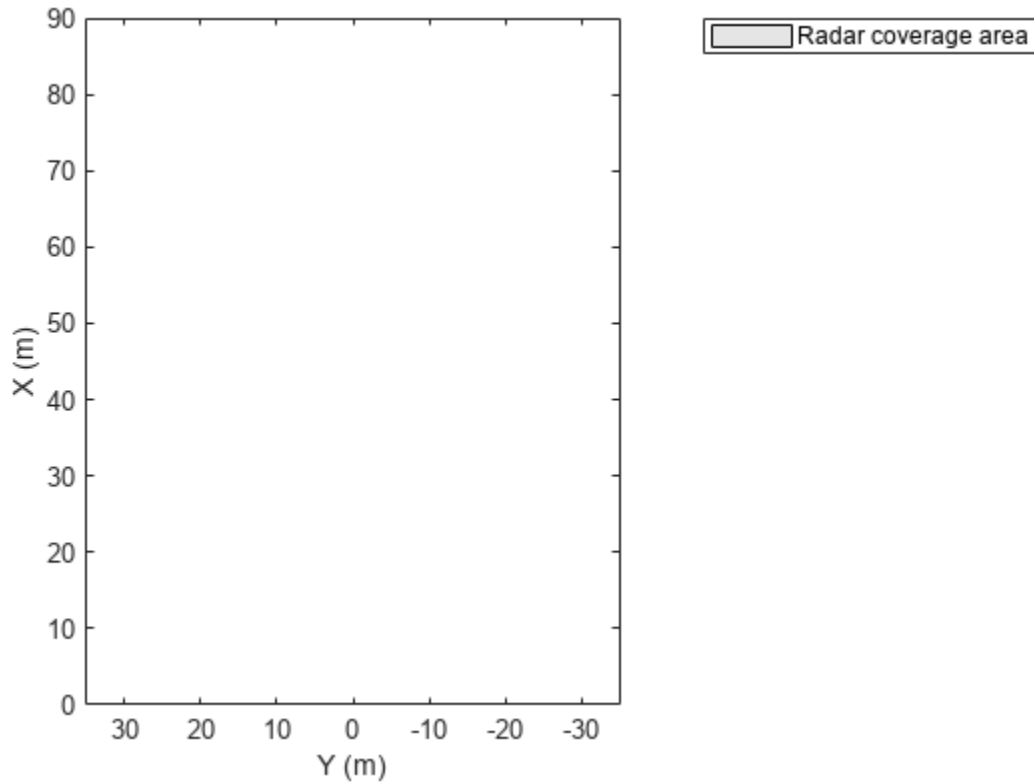

Display a coverage area that has a 35-degree field of view and a 60-meter range. Mount the coverage area sensor 1 meter in front of the origin. Set the orientation angle of the sensor to 0 degrees.

```
mountPosition = [1 0];  
range = 60;  
orientation = 0;  
fieldOfView = 35;
```

Plot the coverage area.

```
plotCoverageArea(caPlotter, mountPosition, range, orientation, fieldOfView);
```

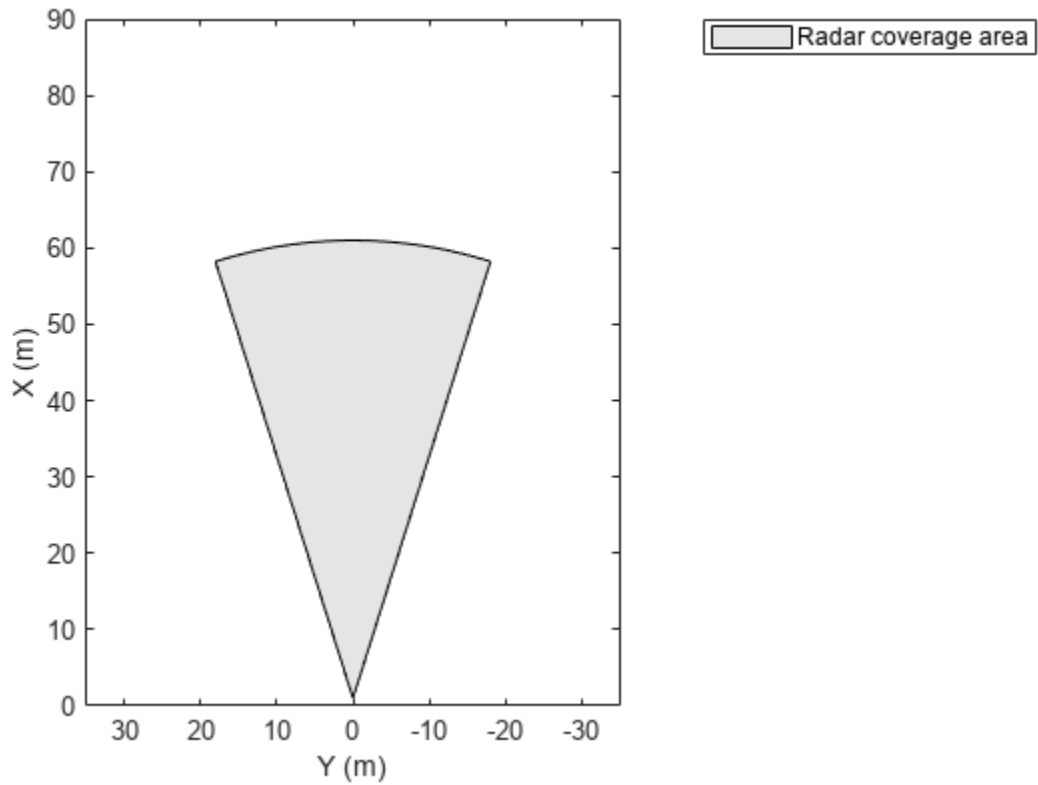

Display Sensor Coverage Areas from Four Corners of Vehicle

Create a bird's-eye plot with an x-axis range from -100 to 100 meters and a y-axis range from -100 to 100 meters

```
bep = birdsEyePlot('XLim',[-100 100], 'YLim',[-100 100]);
```

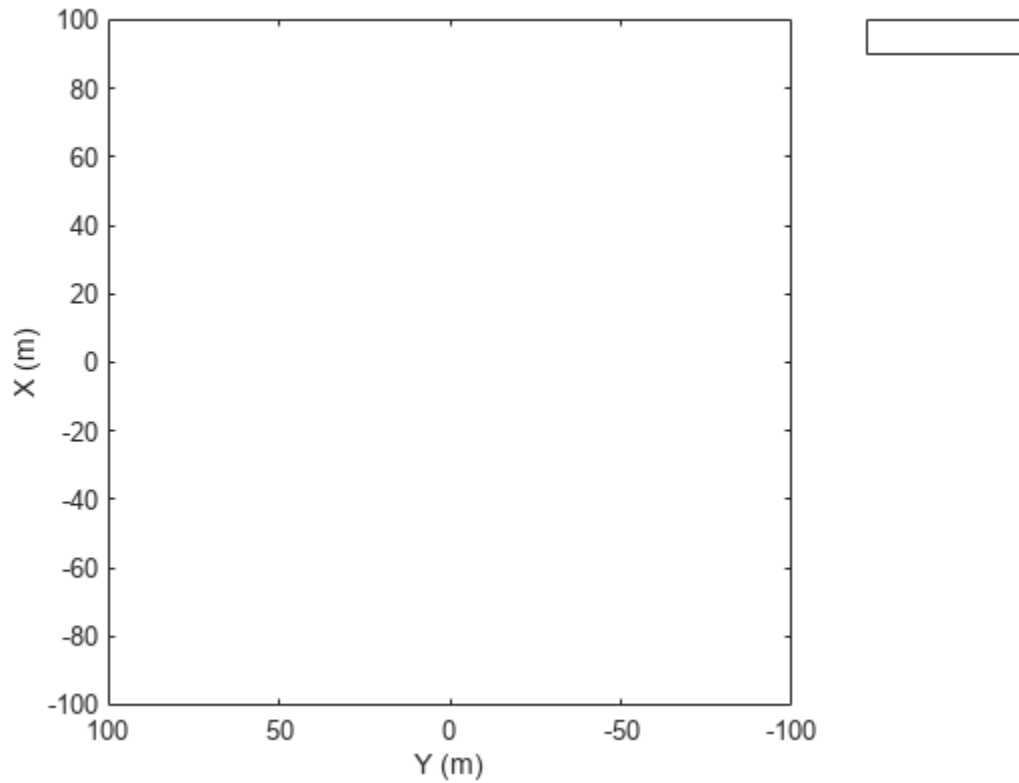

Create coverage area plotters with unique display names and fill colors for each sensor location on the vehicle.

```
rearLeftPlotter = coverageAreaPlotter(bep, 'DisplayName', 'Rear left', 'FaceColor', 'r');  
rearRightPlotter = coverageAreaPlotter(bep, 'DisplayName', 'Rear right', 'FaceColor', 'b');  
frontLeftPlotter = coverageAreaPlotter(bep, 'DisplayName', 'Front left', 'FaceColor', 'y');  
frontRightPlotter = coverageAreaPlotter(bep, 'DisplayName', 'Front right', 'FaceColor', 'g');
```

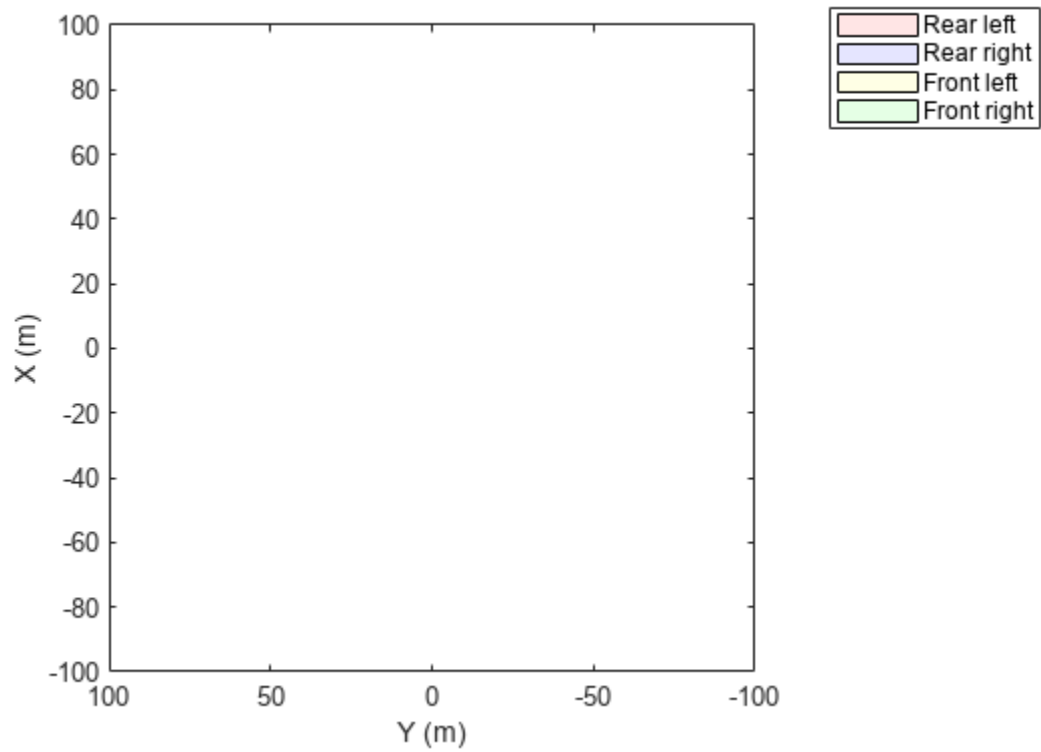
Set the positions, ranges, orientations, and fields of view for the sensors. The sensors have a maximum range of 90 meters and a field of view of 30 degrees. Plot the coverage areas.

```
plotCoverageArea(rearLeftPlotter, [0 0.9], 90, 120, 30);  
plotCoverageArea(rearRightPlotter, [0 -0.9], 90, -120, 30);  
plotCoverageArea(frontLeftPlotter, [2.8 0.9], 90, 60, 30);  
plotCoverageArea(frontRightPlotter, [2.8 -0.9], 90, -60, 30);
```

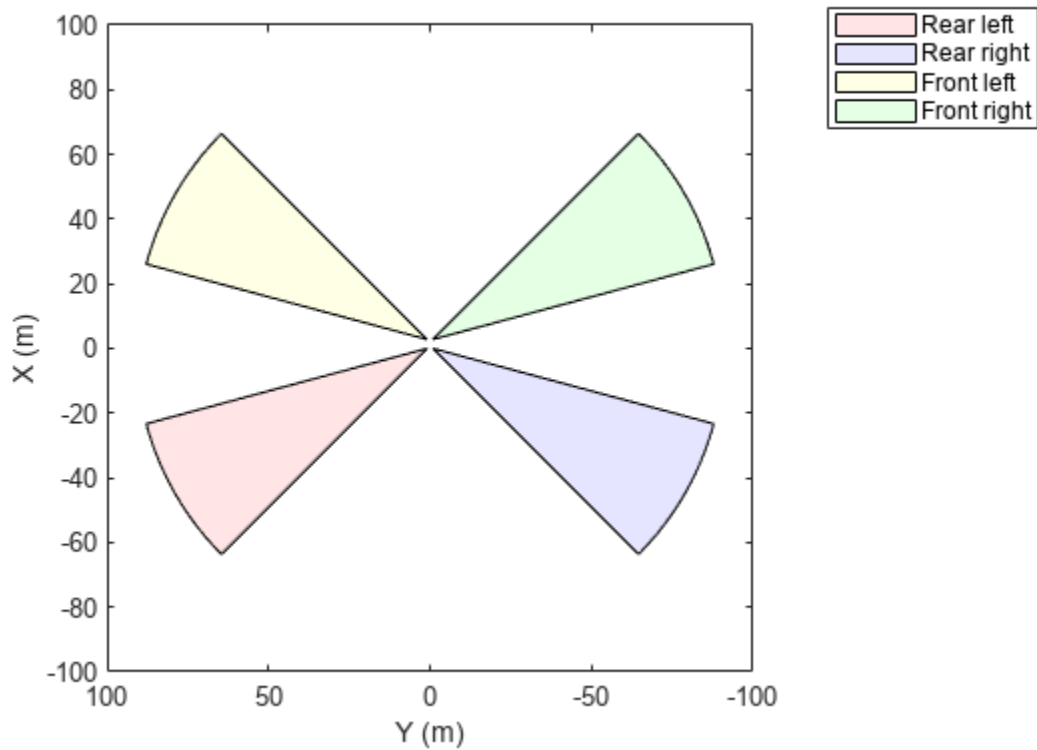

Input Arguments

caPlotter — Coverage area plotter

CoverageAreaPlotter object

Coverage area plotter, specified as a CoverageAreaPlotter object. This object is stored in the Plotters property of a birdsEyePlot object and configures the display of coverage areas in the bird's-eye plot. To create this object, use the coverageAreaPlotter function.

position — Position of sensor

real-valued vector of the form $[X_{\text{OriginOffset}} \ Y_{\text{OriginOffset}}]$

Position of the sensor in vehicle coordinates, specified as a real-valued vector of the form $[X_{\text{OriginOffset}} \ Y_{\text{OriginOffset}}]$. Units are in meters.

- $X_{\text{OriginOffset}}$ specifies the distance that the sensor is in front of the origin.
- $Y_{\text{OriginOffset}}$ specifies the distance that the sensor is to the left of the origin.

The origin is located at the center of the rear axle, as shown in this figure of the vehicle coordinate system.

**range – Range of sensor**

positive real scalar

Range of sensor, specified as a positive real scalar. Units are in meters.

orientation – Orientation angle of sensor

real scalar

Orientation angle of the sensor relative to the X -axis of the ego vehicle, specified as a real scalar. Units are in degrees. `orientation` is positive in the counterclockwise direction (to the left).

fieldOfView – Field of view of sensor

positive real scalar

Field of view of the sensor coverage area, specified as a positive real scalar. Units are in degrees.

Version History

Introduced in R2017a

See Also

birdsEyePlot | coverageAreaPlotter

plotDetection

Display object detections on bird's-eye plot

Syntax

```
plotDetection(detPlotter,positions)
plotDetection(detPlotter,positions,velocities)
plotDetection(detPlotter,positions,labels)
plotDetection(detPlotter,positions,velocities,labels)
```

Description

`plotDetection(detPlotter,positions)` displays object detections from a list of object positions on a bird's-eye plot. The detection plotter, `detPlotter`, is associated with a `birdsEyePlot` object and configures the display of the specified detections.

To remove all detections associated with detection plotter `detPlotter`, call the `clearData` function and specify `detPlotter` as the input argument.

`plotDetection(detPlotter,positions,velocities)` displays detections and their velocities on a bird's-eye plot.

`plotDetection(detPlotter,positions,labels)` displays detections and their labels on a bird's-eye plot.

`plotDetection(detPlotter,positions,velocities,labels)` displays detections and their velocities and labels on a bird's-eye plot. `velocities` and `labels` can appear in either order but must come after `detPlotter` and `positions`.

Examples

Create and Display a Bird's-Eye Plot

Create a bird's-eye plot with an x-axis range from 0 to 90 meters and a y-axis range from -35 to 35 meters.

```
bep = birdsEyePlot('XLim',[0 90],'YLim',[-35 35]);
```

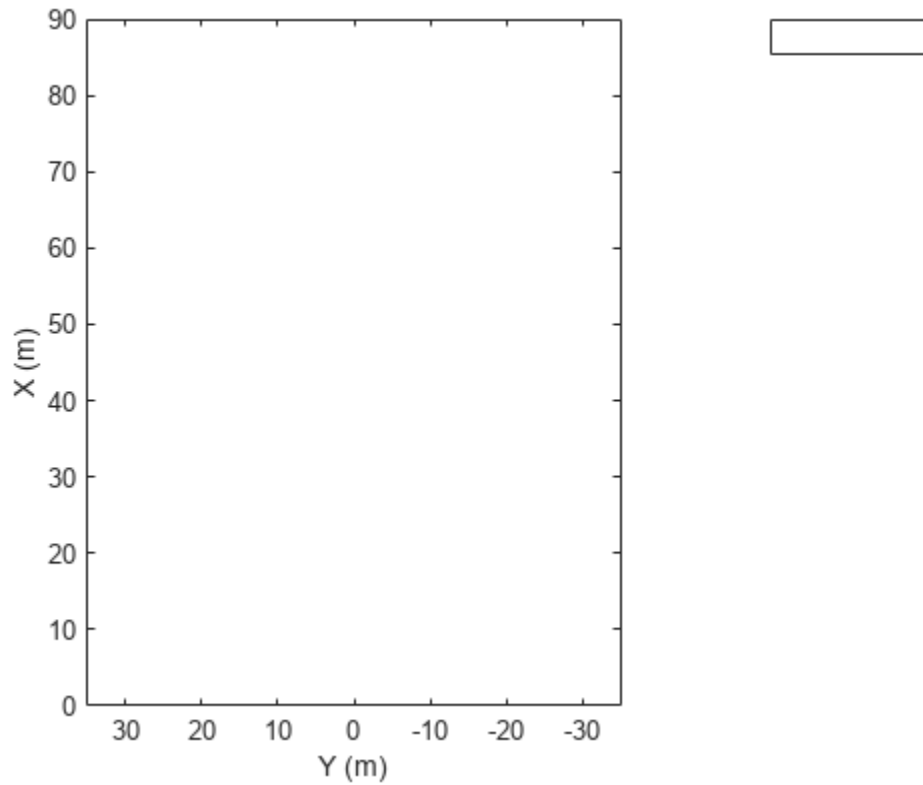

Display a coverage area with a 35-degree field of view and a 60-meter range.

```
caPlotter = coverageAreaPlotter(bep, 'DisplayName', 'Radar coverage area');  
mountPosition = [1 0];  
range = 60;  
orientation = 0;  
fieldOfView = 35;  
plotCoverageArea(caPlotter, mountPosition, range, orientation, fieldOfView);
```

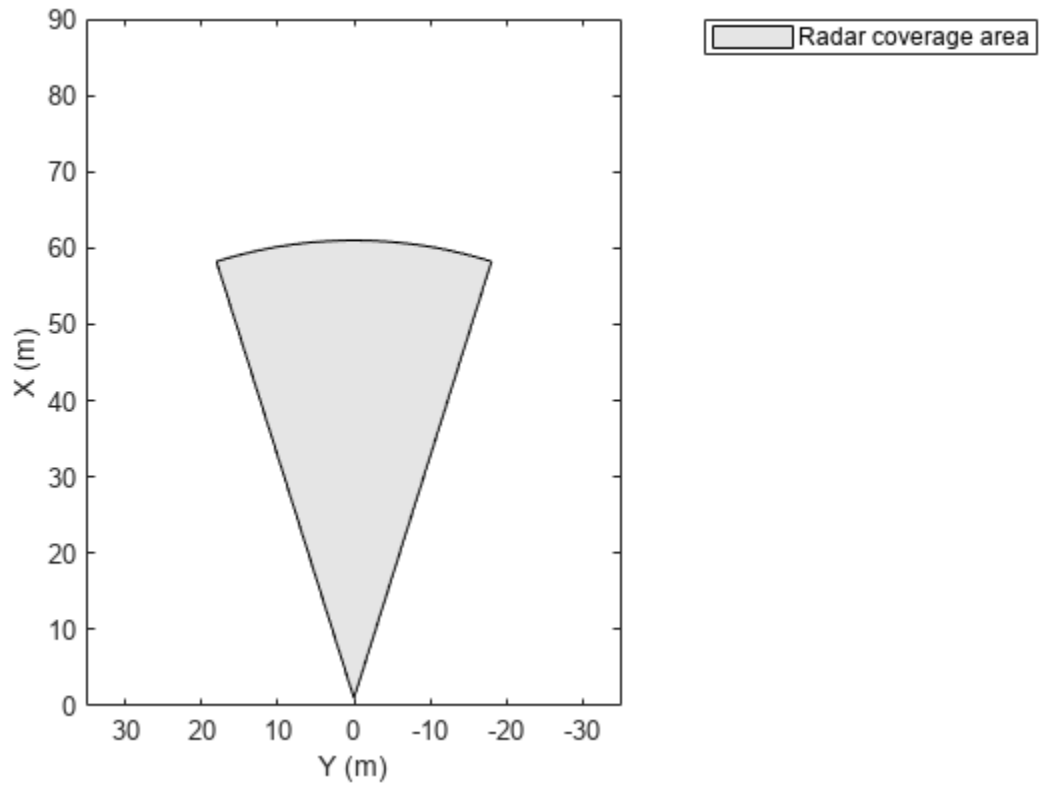

Display radar detections with coordinates at (30, -5), (50, -10), and (40, 7).

```
radarPlotter = detectionPlotter(bep, 'DisplayName', 'Radar detections');  
plotDetection(radarPlotter, [30 -5; 50 -10; 40 7]);
```

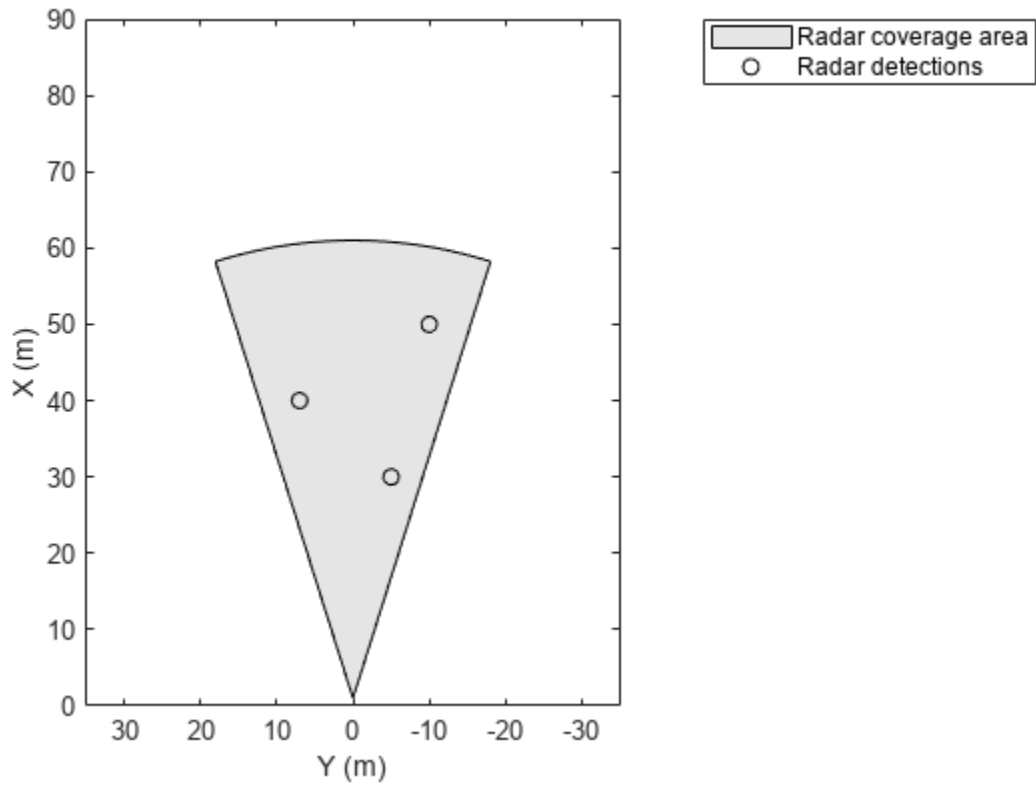

Create and Display Labeled Detections on Bird's-Eye Plot

Create a bird's-eye plot with an x-axis range from 0 to 90 meters and a y-axis range from -35 to 35 meters. Create a radar detection plotter that displays detections in blue.

```
bep = birdsEyePlot('XLim',[0 90], 'YLim',[-35 35]);  
detPlotter = detectionPlotter(bep, 'DisplayName', 'Radar detections', ...  
    'MarkerFaceColor', 'b');
```

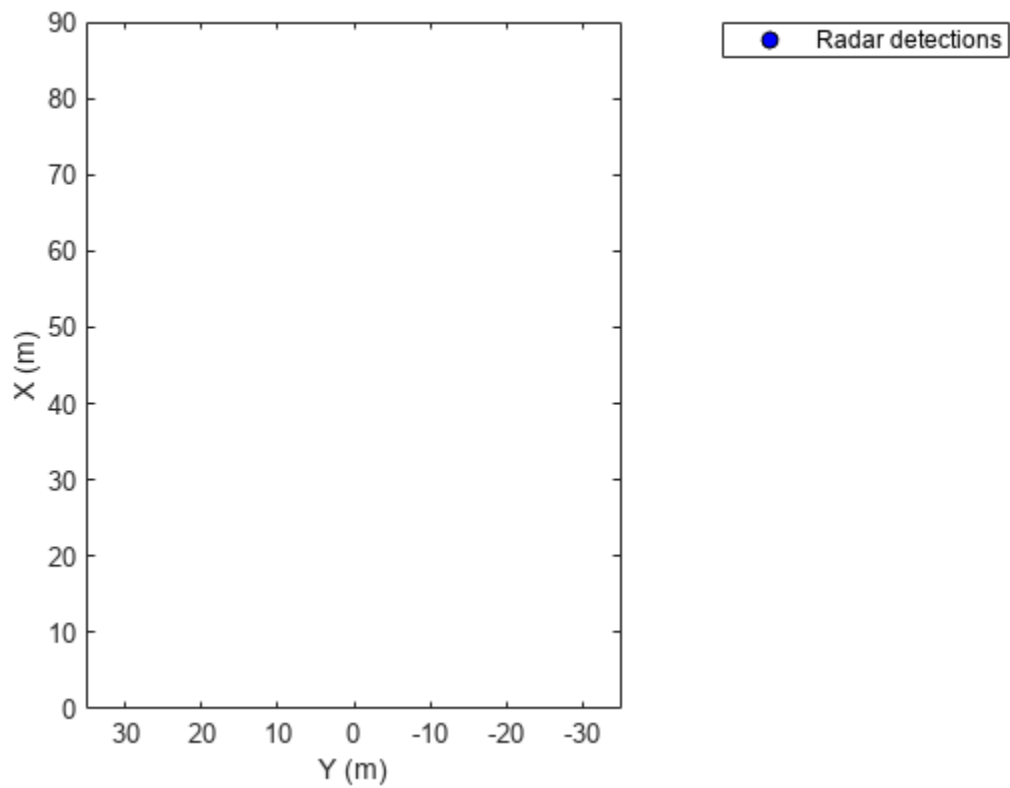
Display the positions and velocities of three labeled detections.

```
positions = [30 5; 30 -10; 30 15];  
velocities = [-10 0; -10 3; -10 -4];  
labels = {'D1', 'D2', 'D3'};  
plotDetection(detPlotter, positions, velocities, labels);
```

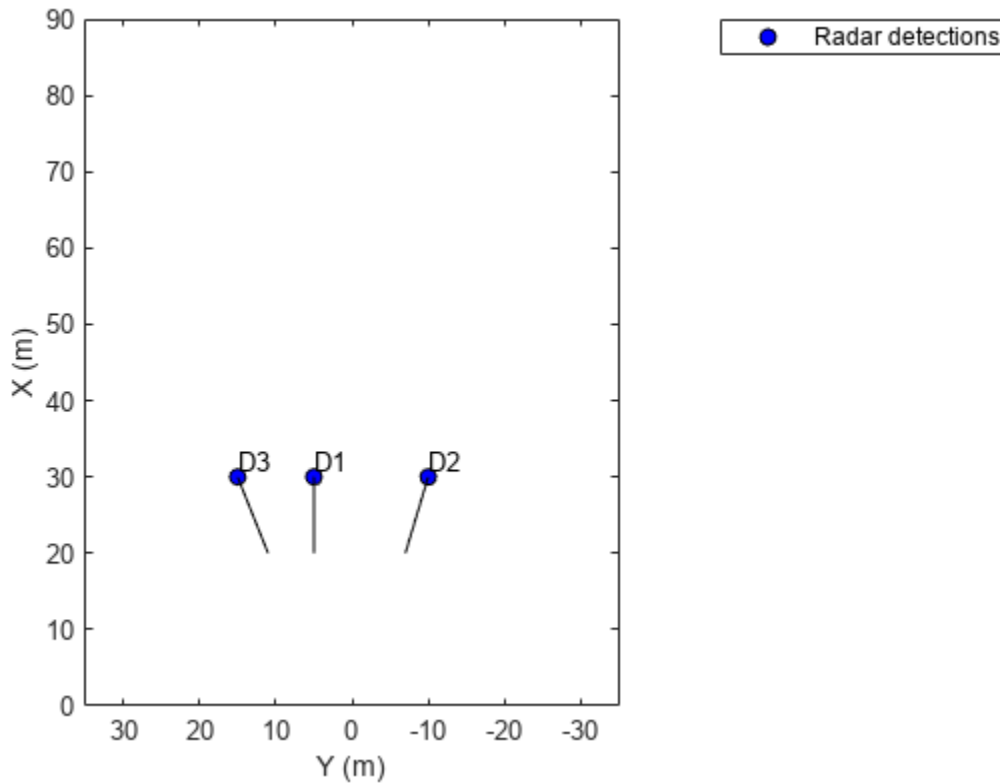

Input Arguments

detPlotter — Detection plotter

DetectionPlotter object

Detection plotter, specified as a DetectionPlotter object. This object is stored in the `Plotters` property of a `birdsEyePlot` object and configures the display of the specified detections in the bird's-eye plot. To create this object, use the `detectionPlotter` function.

positions — Positions of detected objects

M -by-2 real-valued matrix

Positions of detected objects in vehicle coordinates, specified as an M -by-2 real-valued matrix of (X, Y) positions. M is the number of detected objects. The positive X -direction points ahead of the center of the vehicle. The positive Y -direction points to the left of the origin of the vehicle, which is the center of the rear axle, as shown in this figure of the vehicle coordinate system.



velocities – Velocities of detected objects

M-by-2 real-valued matrix

Velocities of detected objects, specified as an *M*-by-2 real-valued matrix of velocities in the (*X*, *Y*) direction. *M* is the number of detected objects. The velocities are plotted as line vectors that originate from the center positions of the detections as they are tracked.

labels – Detection labels

M-length string array | *M*-length cell array of character vectors

Detection labels, specified as an *M*-length string array or *M*-length cell array of character vectors. *M* is the number of detected objects. The labels correspond to the locations in the `positions` matrix. By default, detections do not have labels. To remove all annotations and labels associated with the detection plotter, use the `clearData` function.

Version History

Introduced in R2017a

See Also

`birdsEyePlot` | `detectionPlotter`

plotLaneBoundary

Display lane boundaries on bird's-eye plot

Syntax

```
plotLaneBoundary(lbPlotter, boundaryCoords)
plotLaneBoundary(lbPlotter, boundaries)
```

Description

`plotLaneBoundary(lbPlotter, boundaryCoords)` displays lane boundaries from a list of boundary coordinates on a bird's-eye plot. The lane boundary plotter, `lbPlotter`, is associated with a `birdsEyePlot` object and configures the display of the specified lane boundaries.

To remove all lane boundaries associated with lane boundary plotter `lbPlotter`, call the `clearData` function and specify `lbPlotter` as the input argument.

`plotLaneBoundary(lbPlotter, boundaries)` displays lane boundaries from a lane boundary object or an array of lane boundary objects, `boundaries`.

Examples

Create and Display Road Boundaries

Create a driving scenario containing a figure-8 road specified in the world coordinates of the scenario. Convert the world coordinates of the scenario to the coordinate system of the ego vehicle.

Create an empty driving scenario.

```
scenario = drivingScenario;
```

Add a figure-8 road to the scenario. Display the scenario.

```
roadCenters = [0  0  1
               20 -20 1
               20  20 1
               -20 -20 1
               -20  20 1
               0  0  1];

roadWidth = 3;
bankAngle = [0 15 15 -15 -15 0];
road(scenario, roadCenters, roadWidth, bankAngle);
plot(scenario)
```

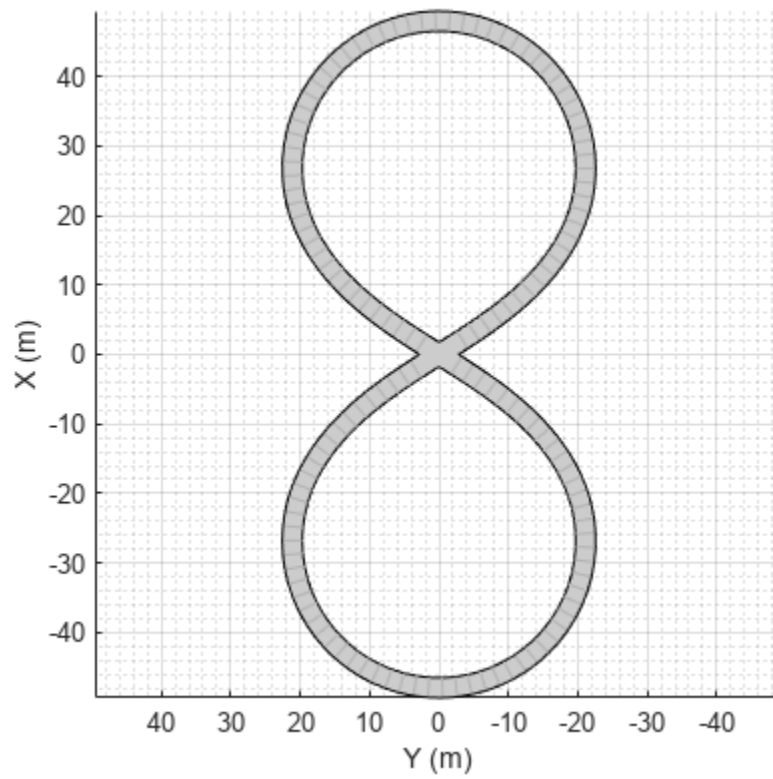

Add an ego vehicle to the scenario. Position the vehicle at world coordinates (20, -20) and orient it at a -15 degree yaw angle.

```
ego = actor(scenario, 'ClassID', 1, 'Position', [20 -20 0], 'Yaw', -15);
```

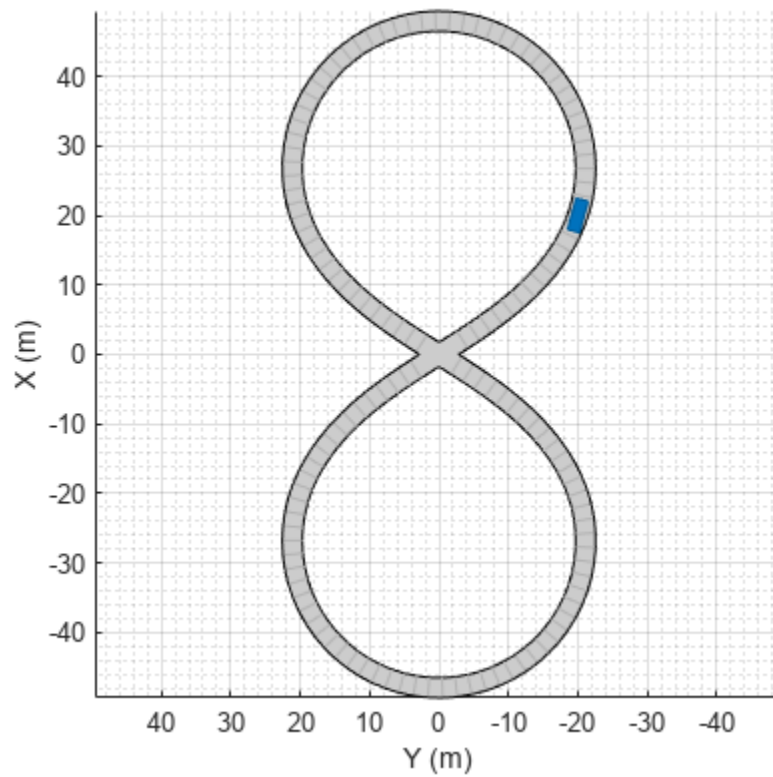

Obtain the road boundaries in ego vehicle coordinates by using the `roadBoundaries` function. Specify the ego vehicle as the input argument.

```
rbEgo1 = roadBoundaries(ego);
```

Display the result on a bird's-eye plot.

```
bep = birdsEyePlot;  
lbp = laneBoundaryPlotter(bep, 'DisplayName', 'Road');  
plotLaneBoundary(lbp, rbEgo1)
```

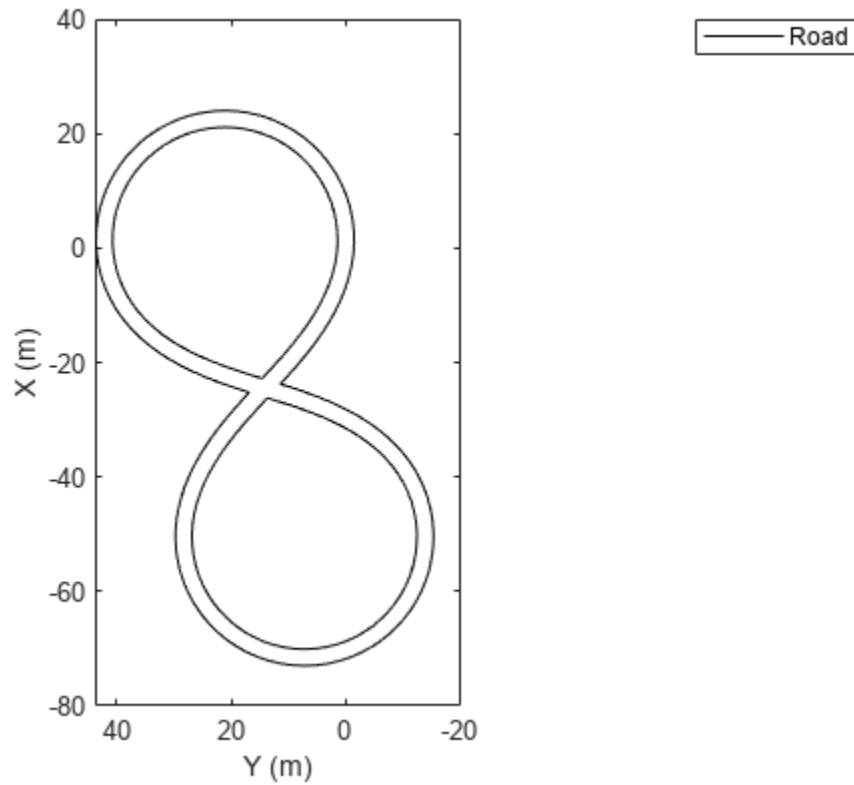

Obtain the road boundaries in world coordinates by using the `roadBoundaries` function. Specify the scenario as the input argument.

```
rbScenario = roadBoundaries(scenario);
```

Obtain the road boundaries in ego vehicle coordinates by using the `driving.scenario.roadBoundariesToEgo` function.

```
rbEgo2 = driving.scenario.roadBoundariesToEgo(rbScenario, ego);
```

Display the road boundaries on a bird's-eye plot.

```
bep = birdsEyePlot;  
lbp = laneBoundaryPlotter(bep, 'DisplayName', 'Road boundaries');  
plotLaneBoundary(lbp, {rbEgo2})
```

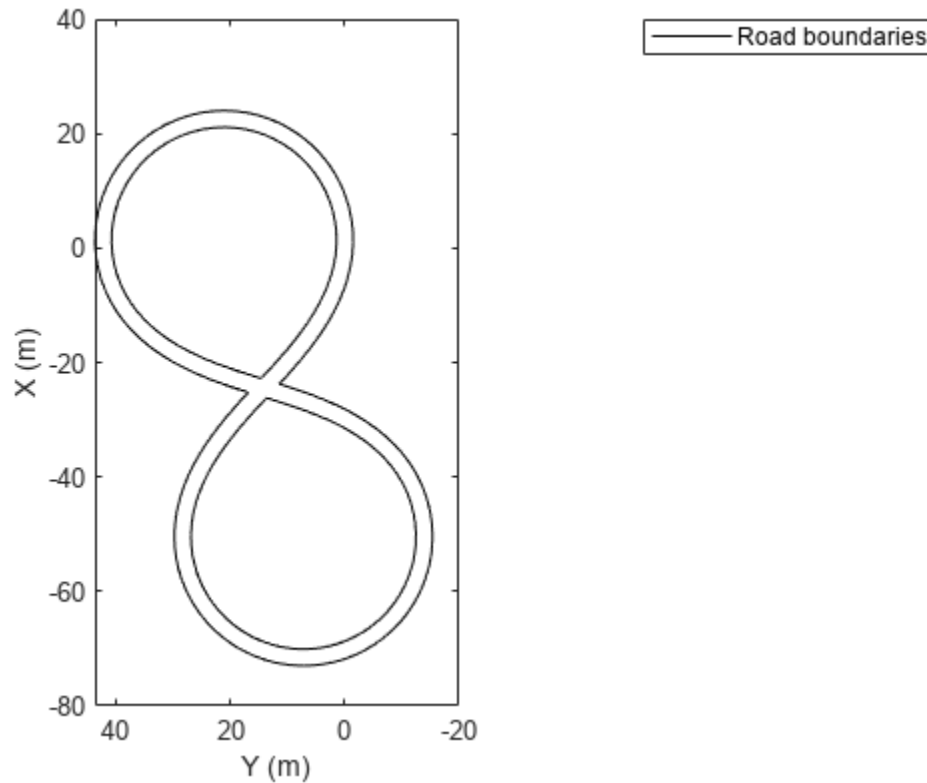
Input Arguments

lbPlotter — Lane boundary plotter

LaneBoundaryPlotter object

Lane boundary plotter, specified as a LaneBoundaryPlotter object. This object is stored in the Plotters property of a birdsEyePlot object and configures the display of the specified lane boundaries in the bird's-eye plot. To create this object, use the laneBoundaryPlotter function.

boundaryCoords — Lane boundary coordinates

cell array of M -by-2 real-valued matrices

Lane boundary coordinates, specified as a cell array of M -by-2 real-valued matrices. Each matrix represents the coordinates for a different lane boundary. M is the number of coordinates in a lane boundary and can be different for each lane boundary. Each row represents the (X, Y) positions of a curve. The positive X -direction points ahead of the center of the vehicle. The positive Y -direction points to the left of the origin of the vehicle, which is the center of the rear axle, as shown in this figure of the vehicle coordinate system.

**boundaries – Lane boundaries**

lane boundary object | array of lane boundary objects

Lane boundaries, specified as a lane boundary object or an array of lane boundary objects. Valid lane boundary objects are `parabolicLaneBoundary`, `cubicLaneBoundary`, and `clothoidLaneBoundary`. If you specify an array of lane boundary objects, all objects must be of the same type. Z-data, which represents height, is ignored.

Version History

Introduced in R2017a

See Also

`birdsEyePlot` | `laneBoundaryPlotter`

plotLaneMarking

Display lane markings on bird's-eye plot

Syntax

```
plotLaneMarking(lmPlotter, lmv, lmf)
```

Description

`plotLaneMarking(lmPlotter, lmv, lmf)` displays lane marking vertices, `lmv`, and lane marking faces, `lmf`, on a bird's-eye plot. The lane marking plotter, `lmPlotter`, is associated with a `birdsEyePlot` object and configures the display of the specified lane markings.

To remove all lane markings associated with the lane marking plotter `lmPlotter`, call the `clearData` function and specify `lmPlotter` as the input argument.

Examples

Display Lane Markings in Car and Pedestrian Scenario

Create a driving scenario containing a car and pedestrian on a straight road. Then, create and display the lane markings of the road on a bird's-eye plot.

Create an empty driving scenario.

```
scenario = drivingScenario;
```

Create a straight, 25-meter road segment with two travel lanes in one direction.

```
lm = [laneMarking('Solid')
      laneMarking('Dashed', 'Length', 2, 'Space', 4)
      laneMarking('Solid')];
l = lanespec(2, 'Marking', lm);
road(scenario, [0 0 0; 25 0 0], 'Lanes', l);
```

Add to the driving scenario a pedestrian crossing the road at 1 meter per second and a car following the road at 10 meters per second.

```
ped = actor(scenario, 'ClassID', 4, 'Length', 0.2, 'Width', 0.4, 'Height', 1.7);
car = vehicle(scenario, 'ClassID', 1);
smoothTrajectory(ped, [15 -3 0; 15 3 0], 1);
smoothTrajectory(car, [car.RearOverhang 0 0; 25-car.Length+car.RearOverhang 0 0], 10);
```

Display the scenario and corresponding chase plot.

```
plot(scenario)
```

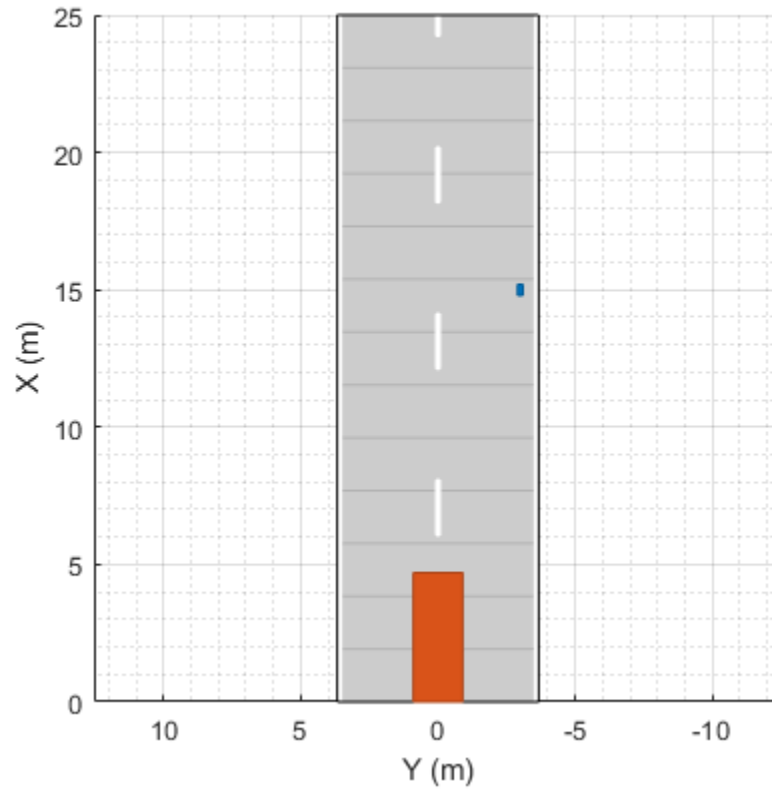

chasePlot(car)

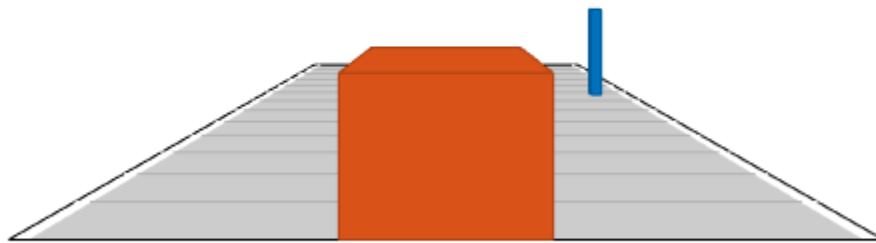

Run the simulation.

- 1 Create a bird's-eye plot.
- 2 Create an outline plotter, lane boundary plotter, and lane marking plotter for the bird's-eye plot.
- 3 Obtain the road boundaries and target outlines.
- 4 Obtain the lane marking vertices and faces.
- 5 Display the lane boundaries and lane markers.
- 6 Run the simulation loop.

```
bep = birdsEyePlot('XLim',[-25 25],'YLim',[-10 10]);
olPlotter = outlinePlotter(bep);
lbPlotter = laneBoundaryPlotter(bep);
lmPlotter = laneMarkingPlotter(bep,'DisplayName','Lanes');
legend('off');
while advance(scenario)
    rb = roadBoundaries(car);
    [position,yaw,length,width,originOffset,color] = targetOutlines(car);
    [lmv,lmf] = laneMarkingVertices(car);
    plotLaneBoundary(lbPlotter,rb);
    plotLaneMarking(lmPlotter,lmv,lmf);
    plotOutline(olPlotter,position,yaw,length,width, ...
        'OriginOffset',originOffset,'Color',color);
end
```

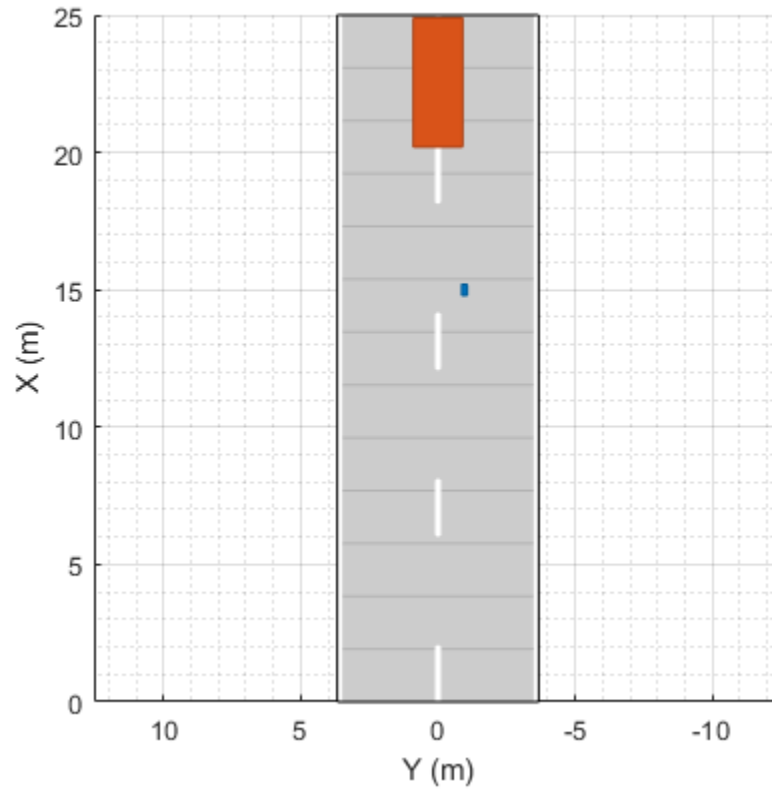

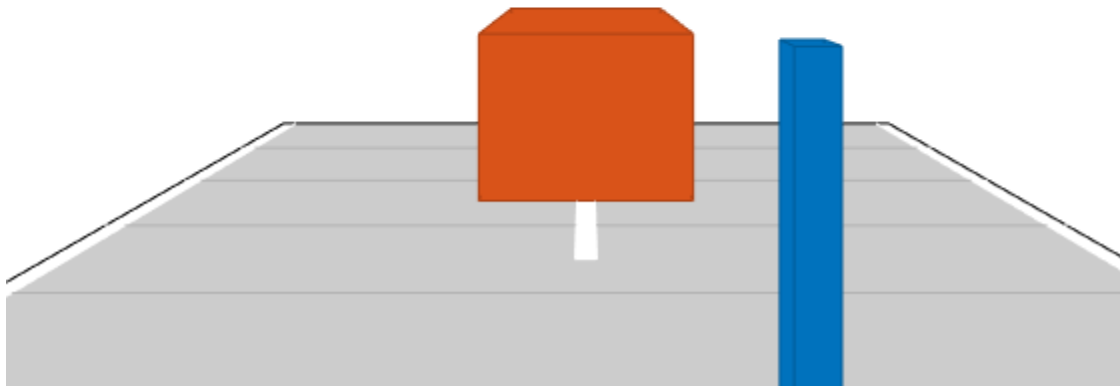

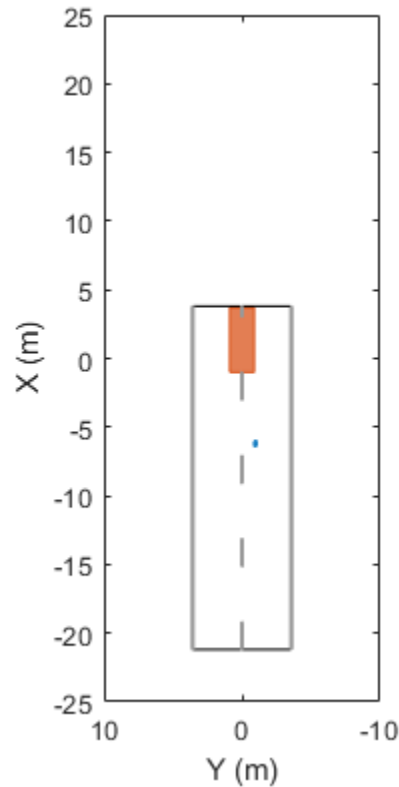

Input Arguments

lmPlotter — Lane marking plotter

LaneMarkingPlotter object

Lane marking plotter, specified as a LaneMarkingPlotter object. This object is stored in the `Plotters` property of a `birdsEyePlot` object and configures the display of the specified lane markings in the bird's-eye plot. To create this object, use the `laneMarkingPlotter` function.

lmv — Lane marking vertices

V -by-3 real-valued matrix

Lane marking vertices, specified as a V -by-3 real-valued matrix. Each row of `lmv` represents the x , y , and z coordinates of one vertex in the lane marking. The plotter uses only the x and y coordinates. V is the number of vertices in the marking.

To obtain lane marking vertices and faces from a driving scenario, use the `laneMarkingVertices` function.

lmf — Lane marking faces

integer-valued matrix

Lane marking faces, specified as an integer-valued matrix. Each row of `lmf` is a face that defines the connection between vertices for one lane marking.

To obtain lane marking vertices and faces from a driving scenario, use the `laneMarkingVertices` function.

Version History

Introduced in R2018a

See Also

`birdsEyePlot` | `laneMarkingPlotter` | `laneMarkingVertices`

plotParkingLaneMarking

Display parking lane markings on bird's-eye plot

Syntax

```
plotParkingLaneMarking(lmPlotter,plmv,plmf)
```

Description

`plotParkingLaneMarking(lmPlotter,plmv,plmf)` displays parking lane marking vertices `plmv` and parking lane marking faces `plmf` on a bird's-eye plot. The lane marking plotter `lmPlotter` is associated with a `birdsEyePlot` object and configures the display of the specified lane markings.

To remove all lane markings associated with the lane marking plotter `lmPlotter`, use the `clearData` function and specify `lmPlotter` as the input argument.

Examples

Generate Detections of Cars in Parking Lot

Generate detections of cars parked in a parking lot, and plot the detections on a bird's-eye plot.

Create a driving scenario containing a road and parking lot.

```
scenario = drivingScenario;  
roadcenters = [10 40; 10 -40];  
road(scenario,roadcenters);  
vertices = [0 20; 20 20; 20 -20; 0 -20];  
parkingLot(scenario,vertices,ParkingSpace=parkingSpace);
```

Add an ego vehicle and specify a trajectory in which the vehicle drives through the parking lot.

```
ego = vehicle(scenario);  
waypoints = [10 35 0; 10 10 0];  
speed = 5; % m/s  
smoothTrajectory(ego,waypoints,speed)
```

Create parked cars in several parking spaces. Plot the scenario.

```
parkedCar1 = vehicle(scenario,Position=[15.8 12.4 0]);  
parkedCar2 = vehicle(scenario,Position=[15.8 -12.4 0]);  
parkedCar3 = vehicle(scenario,Position=[2 -9.7 0]);  
parkedCar4 = vehicle(scenario,Position=[2 9.7 0]);  
plot(scenario)
```

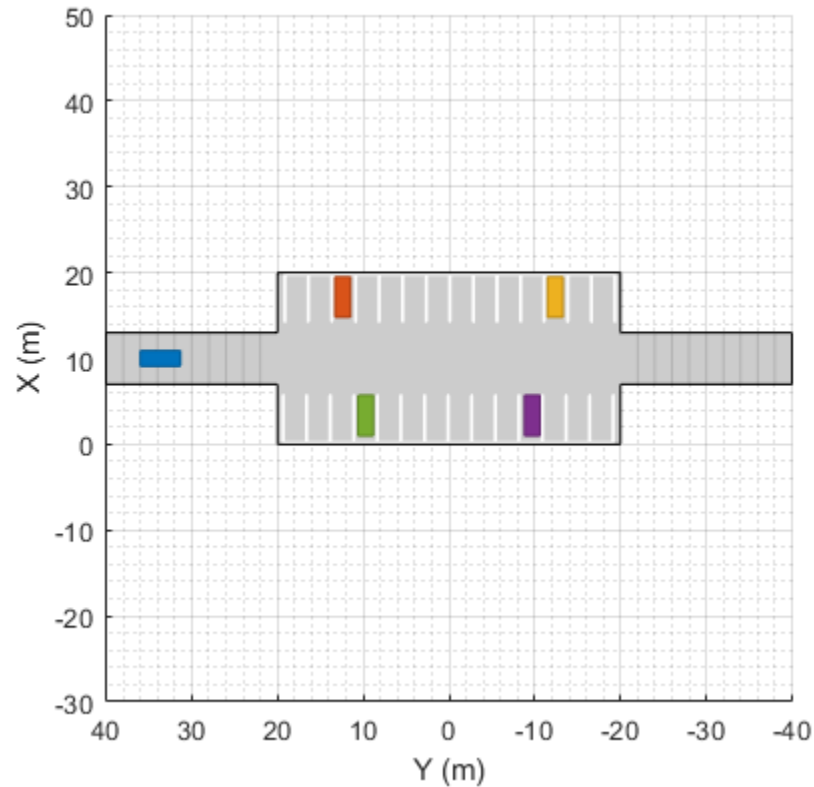

Create a vision sensor for generating the detections. By default, the sensor is mounted to the front bumper of the ego vehicle.

```
sensor = visionDetectionGenerator;
```

Create a bird's-eye plot and plotters for visualizing the target outlines, road boundaries, parking lane markings, sensor coverage area, and detections. Then, simulate the scenario and generate the detections.

```
bep = birdsEyePlot(XLim=[-40 40],YLim=[-30 30]);
olPlotter = outlinePlotter(bep);
lbPlotter = laneBoundaryPlotter(bep);
lmPlotter = laneMarkingPlotter(bep,DisplayName="Parking lanes");
caPlotter = coverageAreaPlotter(bep,DisplayName="Coverage area");
detPlotter = detectionPlotter(bep,DisplayName="Detections");

while advance(scenario)

    % Plot target outlines.
    [position,yaw,length,width,originOffset,color] = targetOutlines(ego);
    plotOutline(olPlotter,position,yaw,length,width)

    % Plot lane boundaries of ego vehicle.
    rbEgo = roadBoundaries(ego);
    plotLaneBoundary(lbPlotter,rbEgo)

    % Plot parking lane markings.
```

```
[plmv,plmf] = parkingLaneMarkingVertices(ego);
plotParkingLaneMarking(lmPlotter,plmv,plmf)

% Plot sensor coverage area.
mountPosition = sensor.SensorLocation;
range = sensor.MaxRange;
orientation = sensor.Yaw;
fieldOfView = sensor.FieldOfView(1);
plotCoverageArea(caPlotter,mountPosition,range,orientation,fieldOfView)

% Generate and plot detections.
actors = targetPoses(ego);
time = scenario.SimulationTime;
[dets,isValidTime] = sensor(actors,time);
if isValidTime
    positions = cell2mat(cellfun(@(x)([x.Measurement(1) x.Measurement(2)]), ...
        dets,UniformOutput=false));
    plotDetection(detPlotter,positions)
end
end
```

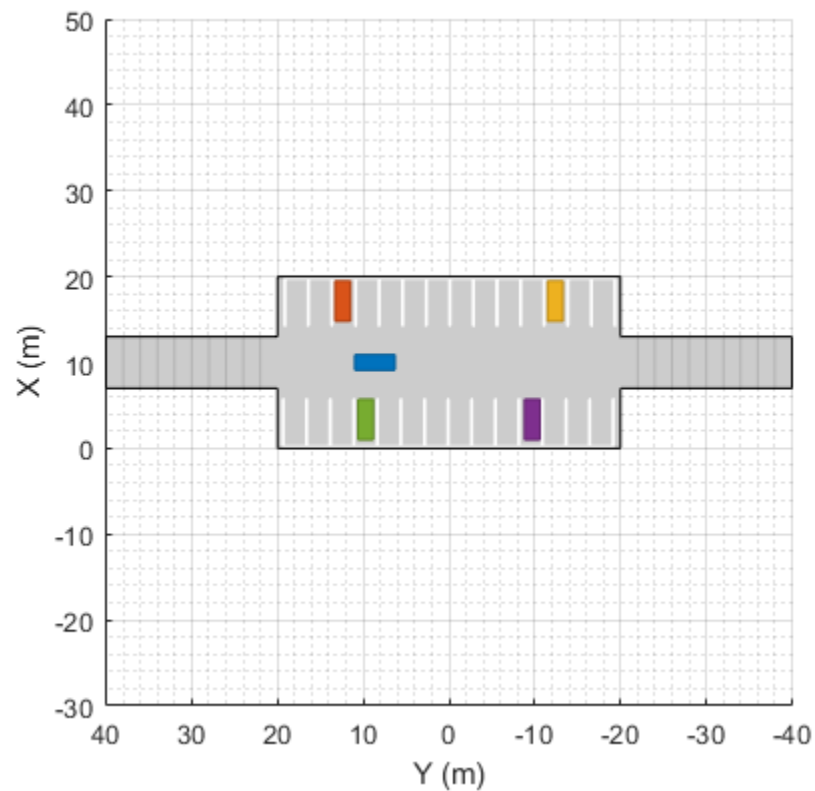

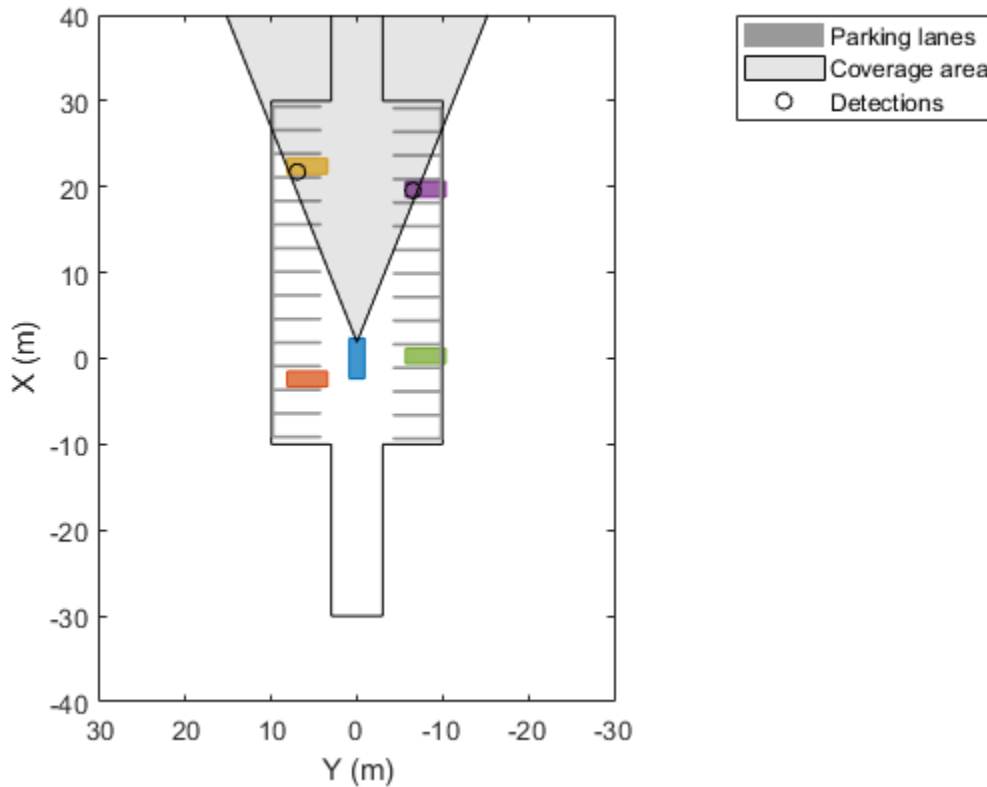

Input Arguments

lmPlotter — Lane marking plotter

LaneMarkingPlotter object

Lane marking plotter, specified as a LaneMarkingPlotter object. This object is stored in the Plotters property of a birdsEyePlot object and configures the display of the specified parking lane markings in the bird's-eye plot. To create this object, use the laneMarkingPlotter function.

pLmv — Parking lane marking vertices

V -by-3 real-valued matrix

Parking lane marking vertices, specified as a V -by-3 real-valued matrix. Each row of pLmv represents the x , y , and z coordinates of one vertex in the lane marking. The plotter uses only the x and y coordinates. V is the number of vertices in the marking.

To obtain vertices and faces from parking lane markings in a driving scenario, use the parkingLaneMarkingVertices function.

pLmf — Parking lane marking faces

matrix of integers

Parking lane marking faces, specified as a matrix of integers. Each row of pLmf is a face that defines the connection between vertices for one parking lane marking. For more details, see "Faces".

To obtain vertices and faces from parking lane markings in a driving scenario, use the `parkingLaneMarkingVertices` function.

Version History

Introduced in R2021b

See Also

`birdsEyePlot` | `laneMarkingPlotter` | `parkingLaneMarkingVertices`

Topics

“Simulate Vehicle Parking Maneuver in Driving Scenario”

plotMesh

Package:

Display object meshes on bird's-eye plot

Syntax

```
plotMesh(mPlotter,vertices,faces)
plotMesh(mPlotter,vertices,faces,'Color',colors)
```

Description

`plotMesh(mPlotter,vertices,faces)` displays meshes on page 4-113 composed of the specified vertices and faces on a bird's-eye plot. To obtain the mesh vertices and faces of an object in a driving scenario, use the `targetMeshes` function. The mesh plotter, `mPlotter`, is associated with a `birdsEyePlot` object and configures the display of the meshes.

The bird's-eye plot assigns a different color to each actor, based on the default color order of `Axes` objects. For more details, see the `ColorOrder` property for `Axes` objects.

To remove all meshes associated with mesh plotter `mPlotter`, call the `clearData` function and specify `mPlotter` as the input argument.

`plotMesh(mPlotter,vertices,faces,'Color',colors)` specifies the colors of the meshes.

Examples

Display Actor Meshes in Driving Scenario

Display actors in a driving scenario by using their mesh representations instead of their cuboid representations.

Create a driving scenario, and add a 25-meter straight road to the scenario.

```
scenario = drivingScenario;
roadcenters = [0 0 0; 25 0 0];
road(scenario,roadcenters);
```

Add a pedestrian and a vehicle to the scenario. Specify the mesh dimensions of the actors using prebuilt meshes.

- Specify the pedestrian mesh as a `driving.scenario.pedestrianMesh` object.
- Specify the vehicle mesh as a `driving.scenario.carMesh` object.

```
p = actor(scenario,'ClassID',4, ...
          'Length',0.2,'Width',0.4, ...
          'Height',1.7,'Mesh',driving.scenario.pedestrianMesh);
v = vehicle(scenario,'ClassID',1, ...
            'Mesh',driving.scenario.carMesh);
```

Add trajectories for the pedestrian and vehicle.

- Specify for the pedestrian to cross the road at 1 meter per second.
- Specify for the vehicle to follow the road at 10 meters per second.

```
waypointsP = [15 -3 0; 15 3 0];
speedP = 1;
smoothTrajectory(p,waypointsP,speedP);
```

```
wayPointsV = [v.RearOverhang 0 0; (25 - v.Length + v.RearOverhang) 0 0];
speedV = 10;
smoothTrajectory(v,wayPointsV,speedV)
```

Add an egocentric plot for the vehicle. Turn the display of meshes on.

```
chasePlot(v, 'Meshes', 'on')
```

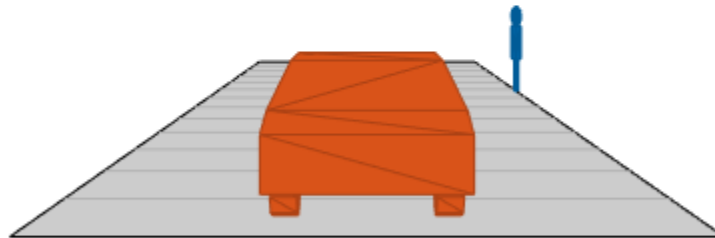

Create a bird's-eye plot in which to display the meshes. Also create a mesh plotter and lane boundary plotter. Then run the simulation loop.

- 1 Obtain the road boundaries of the road the vehicle is on.
- 2 Obtain the mesh vertices, faces, and colors of the actor meshes, with positions relative to the vehicle.
- 3 Plot the road boundaries and actor meshes on the bird's-eye plot.
- 4 Pause the scenario to allow time for the plots to update. The chase plot updates every time you advance the scenario.

```
bep = birdsEyePlot('XLim',[-25 25],'YLim',[-10 10]);  
mPlotter = meshPlotter(bep);  
lbPlotter = laneBoundaryPlotter(bep);  
legend('off')  
  
while advance(scenario)  
    rb = roadBoundaries(v);  
  
    [vertices,faces,colors] = targetMeshes(v);  
  
    plotLaneBoundary(lbPlotter,rb)  
    plotMesh(mPlotter,vertices,faces,'Color',colors)  
  
    pause(0.01)  
end
```

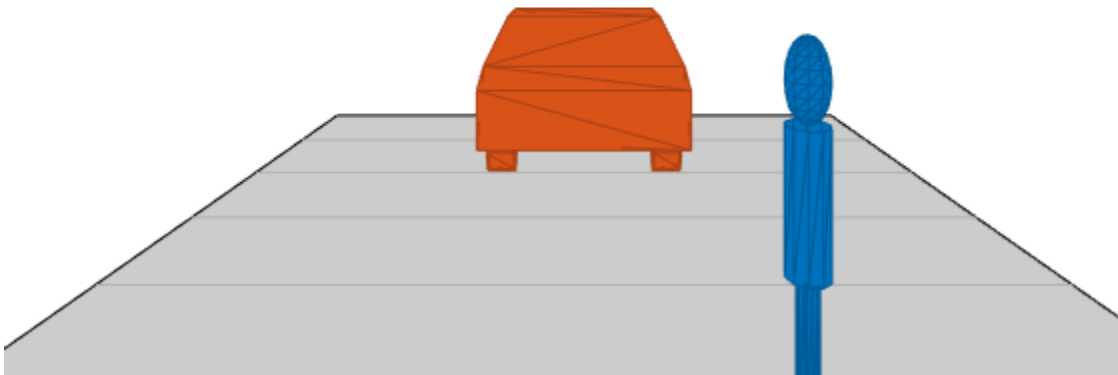

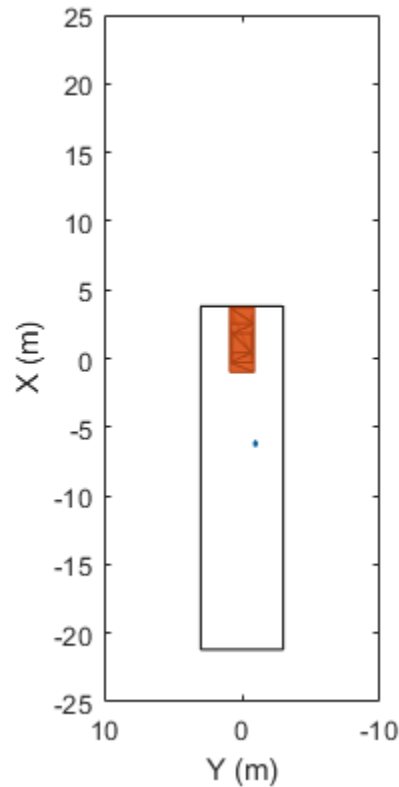

Input Arguments

mPlotter — Mesh plotter

MeshPlotter object

Mesh plotter, specified as a MeshPlotter object. This object is stored in the `Plotters` property of a `birdsEyePlot` object and configures the display of meshes in the bird's-eye plot. To create this object, use the `meshPlotter` function.

vertices — Mesh vertices of each actor

N-element cell array

Mesh vertices of each actor, specified as an *N*-element cell array, where *N* is the number of actors.

Each element in `vertices` must be a *V*-by-3 real-valued matrix containing the vertices of an actor, where:

- *V* is the number of vertices.
- Each row defines the 3-D (*x,y,z*) position of a vertex. When you use the `targetMeshes` function to obtain mesh vertices, the vertex positions are relative to the position of the actor that is input to that function. Units are in meters.

faces — Mesh faces of each actor

N-element cell array

Mesh faces of each actor, specified as an *N*-element cell array, where *N* is the number of actors.

Each element in `faces` must be an F -by-3 integer-valued matrix containing the faces of an actor, where:

- F is the number of faces.
- Each row defines a triangle of vertex IDs that make up the face. The vertex IDs correspond to row numbers within `vertices`.

Suppose the first face of the i th element of `faces` has these vertex IDs.

```
faces{i}(1,:)
```

```
ans =
```

```
    1    2    3
```

In the i th element of `vertices`, rows 1, 2, and 3 contain the (x, y, z) positions of the vertices that make up this face.

```
vertices{i}(1:3,:)
```

```
ans =
```

```
    3.7000    0.9000    0.8574
    3.7000   -0.9000    0.8574
    3.7000   -0.9000    0.3149
```

colors — Color of mesh faces for each actor

N -by-3 matrix of RGB triplets

Color of the mesh faces for each actor, specified as an N -by-3 matrix of RGB triplets. N is the number of actors and is equal to the number of elements in `vertices` and `faces`.

The i th row of `colors` is the RGB color value of the faces in the i th element of `faces`. The function applies the same color to all mesh faces of an actor.



An RGB triplet is a three-element row vector whose elements specify the intensities of the red, green, and blue components of the color. The intensities must be in the range $[0, 1]$. For example, $[0.4 \ 0.6 \ 0.7]$.

More About

Meshes

In driving scenarios, a mesh is a triangle-based 3-D representation of an object. Mesh representations of objects are more detailed than the default cuboid (box-shaped) representations of objects. Meshes are useful for generating synthetic point cloud data from a driving scenario.

This table shows the difference between a cuboid representation and a mesh representation of a vehicle in a driving scenario.

Cuboid	Mesh
	

Version History

Introduced in R2020b

See Also

[meshPlotter](#) | [birdsEyePlot](#) | [targetMeshes](#)

plotOutline

Display object outlines on bird's-eye plot

Syntax

```
plotOutline(olPlotter,positions,yaw,length,width)
plotOutline( ____,Name,Value)
```

Description

`plotOutline(olPlotter,positions,yaw,length,width)` displays the rectangular outlines of cuboid objects on a bird's-eye plot. Specify the position, yaw angle of rotation, length, and width of each cuboid. The outline plotter, `olPlotter`, is associated with a `birdsEyePlot` object and configures the display of the specified outlines.

To remove all outlines associated with outline plotter `olPlotter`, call the `clearData` function and specify `olPlotter` as the input argument.

To display the outlines of actors that are in a driving scenario, first use `targetOutlines` to get the dimensions of the actors. Then, after calling `outlinePlotter` to create a plotter object, use the `plotOutline` function to display the outlines of all the actors in a bird's-eye plot, except barriers. Use `plotBarrierOutline` function to display barriers.

`plotOutline(____,Name,Value)` specifies options using one or more `Name,Value` pair arguments and the input arguments from the previous syntax.

Examples

Plot Outlines of Targets on Bird's-Eye Plot

Create a driving scenario. Create a 25 m road segment with a barrier on its left edge. Add a pedestrian that crosses the road at 1 m/s, and a vehicle that drives along the road at 10 m/s.

```
scenario = drivingScenario;

r = road(scenario,[0 0 0; 25 0 0]);
barrier(scenario,r,'RoadEdge','left')

p = actor(scenario,'ClassID',4,'Length',0.2,'Width',0.4,'Height',1.7);
v = vehicle(scenario,'ClassID',1);

smoothTrajectory(p,[15 -3 0; 15 3 0],1)
smoothTrajectory(v,[v.RearOverhang 0 0; 25-v.Length+v.RearOverhang 0 0],10)
```

Use a chase plot to display the scenario from the perspective of the vehicle.

```
chasePlot(v,'Centerline','on')
```

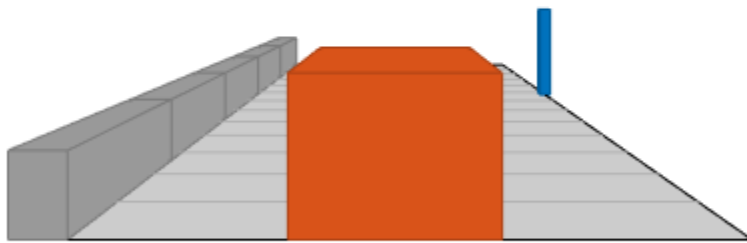

Create a bird's-eye plot, outline plotter, and lane boundary plotter.

```
bep = birdsEyePlot('XLim',[-25 25], 'YLim',[-10 10]);  
olPlotter = outlinePlotter(bep);  
lbPlotter = laneBoundaryPlotter(bep);  
legend('off')
```

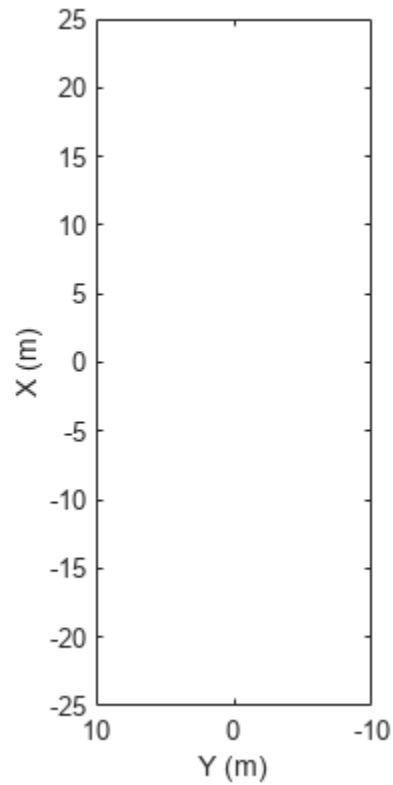

Run the simulation loop. Update the plotter with outlines for the targets.

```

while advance(scenario)
    % Obtain the road boundaries and rectangular outlines.
    rb = roadBoundaries(v);
    [position,yaw,length,width,originOffset,color] = targetOutlines(v);
    [bposition,byaw,blength,bwidth,boriginOffset,bcolor,numBarrierSegments] = targetOutlines(v,'B');

    % Update the bird's-eye plotters with the road, actors and barriers.
    plotLaneBoundary(lbPlotter,rb);
    plotOutline(olPlotter,position,yaw,length,width, ...
        'OriginOffset',originOffset,'Color',color);
    plotBarrierOutline(olPlotter,numBarrierSegments,bposition,byaw,blength,bwidth, ...
        'OriginOffset',boriginOffset,'Color',bcolor);
    % Allow time for plot to update.
    pause(0.01)
end

```

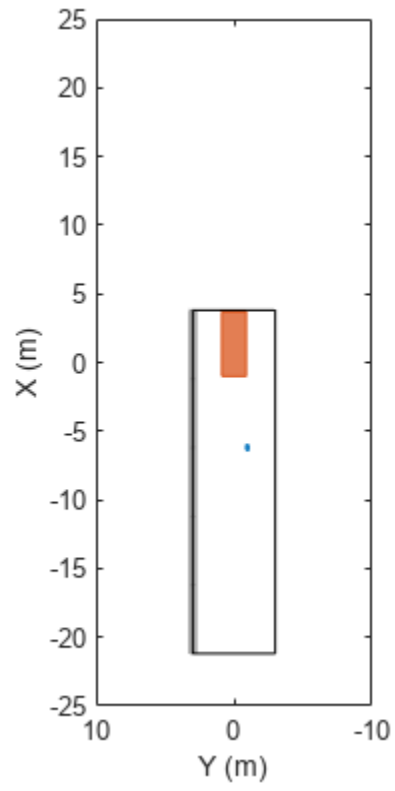

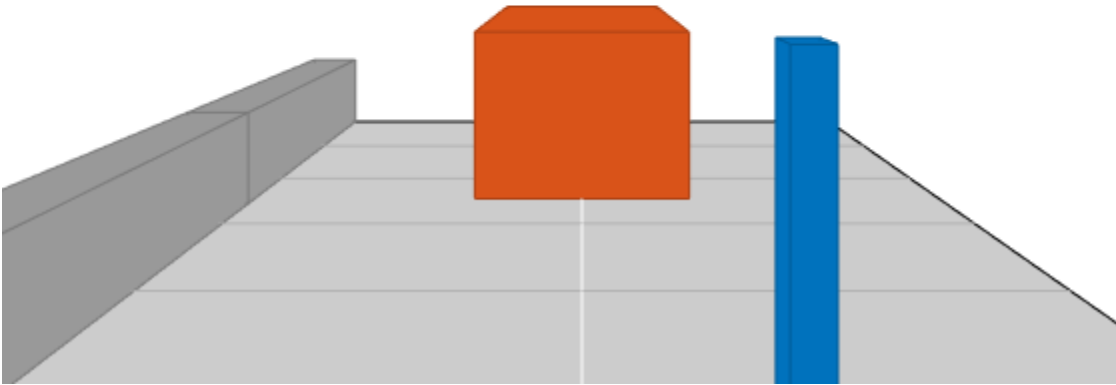

Input Arguments

olPlotter — Outline plotter

OutlinePlotter object

Outline plotter, specified as an OutlinePlotter object. This object is stored in the Plotters property of a birdsEyePlot object and configures the display of the specified outlines in the bird's-eye plot. To create this object, use the outlinePlotter function.

positions — Positions of detected objects

M -by-2 real-valued matrix

Positions of detected objects in vehicle coordinates, specified as an M -by-2 real-valued matrix of (X, Y) positions. M is the number of detected objects. The positive X -direction points ahead of the center of the vehicle. The positive Y -direction points to the left of the origin of the vehicle, which is the center of the rear axle, as shown in this figure of the vehicle coordinate system.

**yaw – Angles of rotation**

M-element real-valued vector

Angles of rotation for object outlines, specified as an *M*-element real-valued vector, where *M* is the number of objects.

length – Lengths of outlines

M-element real-valued vector

Lengths of object outlines, specified as an *M*-element real-valued vector, where *M* is the number of objects.

width – Widths of outlines

M-element real-valued vector

Widths of object outlines, specified as an *M*-element real-valued vector, where *M* is the number of objects.

Name-Value Pair Arguments

Specify optional pairs of arguments as `Name1=Value1, . . . , NameN=ValueN`, where `Name` is the argument name and `Value` is the corresponding value. Name-value arguments must appear after other arguments, but the order of the pairs does not matter.

Before R2021a, use commas to separate each name and value, and enclose Name in quotes.

Example: 'Marker','x'

OriginOffset – Rotational centers of rectangles relative to origin

M-by-2 real-valued matrix

Rotational centers of rectangles relative to origin, specified as the comma-separated pair consisting of 'OriginOffset' and an *M*-by-2 real-valued matrix. *M* is the number of objects. Each row corresponds to the rotational center about which to rotate the corresponding rectangle, specified as an (*X*,*Y*) displacement from the geometrical center of that rectangle.

Color – Outline color

M-by-3 matrix of RGB triplets

Outline color, specified as the comma-separated pair consisting of 'Color' and an *M*-by-3 matrix of RGB triplets. *M* is the number of objects. If you do not specify this argument, the function uses the default colormap for each object.

Example: 'Color',[0 0.5 0.75; 0.8 0.3 0.1]

Version History

Introduced in R2017b

See Also

birdsEyePlot | outlinePlotter

plotBarrierOutline

Display barrier outlines on bird's-eye plot

Syntax

```
plotBarrierOutline(olPlotter,barrierSegments,positions,yaw,length,width)
plotBarrierOutline( ____,Name,Value)
```

Description

`plotBarrierOutline(olPlotter,barrierSegments,positions,yaw,length,width)` displays the rectangular outlines of barriers on a bird's-eye plot. Specify the barrier, as well as the position, yaw angle of rotation, length, and width of each barrier segment. The outline plotter `olPlotter`, is associated with a `birdsEyePlot` object, and configures the display of the specified outlines.

To remove all outlines associated with the outline plotter `olPlotter`, use the `clearData` function and specify `olPlotter` as the input argument.

To display the outlines of the barriers that are in a driving scenario, first use `targetOutlines` with the 'Barriers' flag as input, to get the dimensions of the barriers. Then, use the `plotBarrierOutline` function to display the outlines of all the barriers in a bird's-eye plot.

`plotBarrierOutline(____,Name,Value)` specifies options using one or more `Name,Value` pair arguments and the input arguments from the previous syntax.

Examples

Plot Outlines of Targets on Bird's-Eye Plot

Create a driving scenario. Create a 25 m road segment with a barrier on its left edge. Add a pedestrian that crosses the road at 1 m/s, and a vehicle that drives along the road at 10 m/s.

```
scenario = drivingScenario;

r = road(scenario,[0 0 0; 25 0 0]);
barrier(scenario,r,'RoadEdge','left')

p = actor(scenario,'ClassID',4,'Length',0.2,'Width',0.4,'Height',1.7);
v = vehicle(scenario,'ClassID',1);

smoothTrajectory(p,[15 -3 0; 15 3 0],1)
smoothTrajectory(v,[v.RearOverhang 0 0; 25-v.Length+v.RearOverhang 0 0],10)
```

Use a chase plot to display the scenario from the perspective of the vehicle.

```
chasePlot(v,'Centerline','on')
```

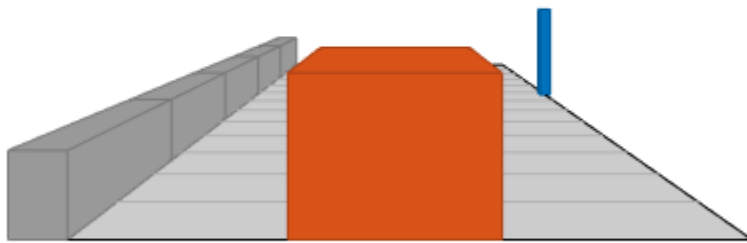

Create a bird's-eye plot, outline plotter, and lane boundary plotter.

```
bep = birdsEyePlot('XLim',[-25 25],'YLim',[-10 10]);  
olPlotter = outlinePlotter(bep);  
lbPlotter = laneBoundaryPlotter(bep);  
legend('off')
```

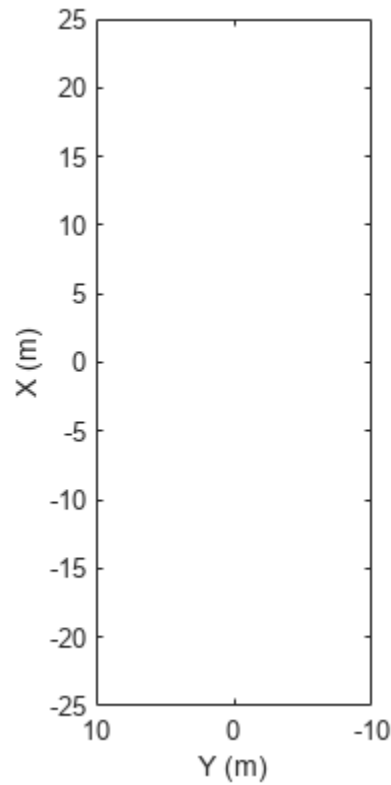

Run the simulation loop. Update the plotter with outlines for the targets.

```

while advance(scenario)
    % Obtain the road boundaries and rectangular outlines.
    rb = roadBoundaries(v);
    [position,yaw,length,width,originOffset,color] = targetOutlines(v);
    [bposition,byaw,blength,bwidth,boriginOffset,bcolor,numBarrierSegments] = targetOutlines(v,'B');

    % Update the bird's-eye plotters with the road, actors and barriers.
    plotLaneBoundary(lbPlotter,rb);
    plotOutline(olPlotter,position,yaw,length,width, ...
        'OriginOffset',originOffset,'Color',color);
    plotBarrierOutline(olPlotter,numBarrierSegments,bposition,byaw,blength,bwidth, ...
        'OriginOffset',boriginOffset,'Color',bcolor);
    % Allow time for plot to update.
    pause(0.01)
end

```

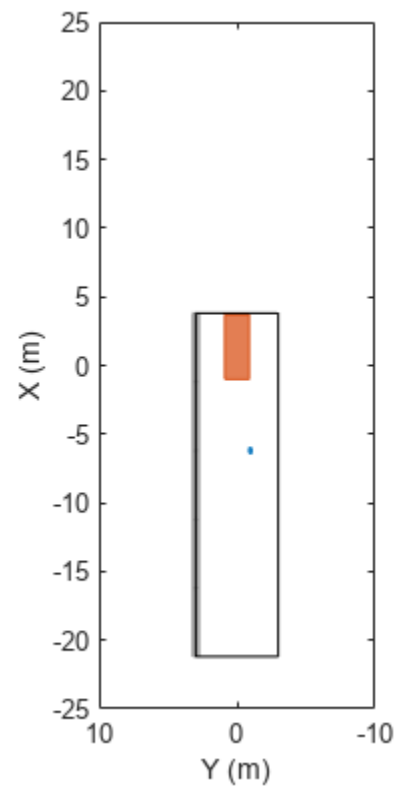

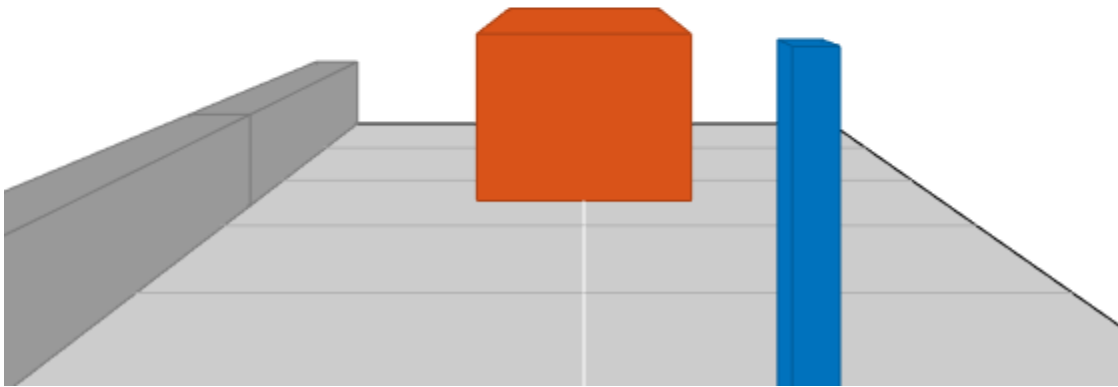

Input Arguments

olPlotter — Outline plotter

OutlinePlotter object

Outline plotter, specified as an OutlinePlotter object. This object is stored in the `Plotters` property of a `birdsEyePlot` object and configures the display of the specified outlines in the bird's-eye plot. To create this object, use the `outlinePlotter` function.

barrierSegments — Number of barrier segments in each barrier

nonnegative real-valued M -by-1 vector

Number of barrier segments in each barrier, specified as a nonnegative real-valued M -by-1 vector. M is the number of barriers in the scenario.

positions — Positions of all barrier segments in the detected barriers

M -by-2 real-valued matrix

Positions of all the barrier segments in the detected barriers, specified as an M -by-2 real-valued matrix of (X,Y) positions. M is the number of barrier segments in the detected barriers.

yaw — Angles of rotation

M -element real-valued vector

Angles of rotation for barrier outlines, specified as an M -element real-valued vector, where M is the number of barrier segments in the detected barriers.

length — Lengths of barrier outlines

M -element real-valued vector

Lengths of barrier outlines, specified as an M -element real-valued vector, where M is the number of barrier segments in the detected barriers.

width — Widths of barrier outlines

M -element real-valued vector

Widths of barrier outlines, specified as an M -element real-valued vector, where M is the number of barrier segments in the detected barriers.

Name-Value Pair Arguments

Specify optional pairs of arguments as `Name1=Value1, ..., NameN=ValueN`, where `Name` is the argument name and `Value` is the corresponding value. Name-value arguments must appear after other arguments, but the order of the pairs does not matter.

Before R2021a, use commas to separate each name and value, and enclose Name in quotes.

Example: `'Color',[1 0 0]` changes the color of a barrier outline to red.

OriginOffset — Rotational centers of rectangles relative to origin

M -by-2 real-valued matrix

Rotational centers of the rectangles relative to origin, specified as the comma-separated pair consisting of `'OriginOffset'` and an M -by-2 real-valued matrix. M is the number of barrier segments in the detected barriers. Each row specifies the rotational center of the rectangle representing the barrier segment outline as an (X,Y) displacement from the geometric center of that rectangle.

Color — Outline color

M -by-3 matrix of RGB triplets

Outline color, specified as the comma-separated pair consisting of `'Color'` and an M -by-3 matrix of RGB triplets. M is the number of barrier segments in the detected barriers. If you do not specify this argument, the function uses the default colormap for each object.

Example: `'Color',[0 0.5 0.75; 0.8 0.3 0.1]`

Version History

Introduced in R2021a

See Also

`birdsEyePlot` | `plotOutline` | `outlinePlotter`

plotPointCloud

Package:

Display generated point cloud on bird's-eye plot

Syntax

```
plotPointCloud(pcPlotter,pcObject)
plotPointCloud(pcPlotter,pointCloudMatrix)
```

Description

`plotPointCloud(pcPlotter,pcObject)` displays a point cloud generated from a point cloud data object, `pcObject`. The point cloud plotter, `pcPlotter`, is associated with a `birdsEyePlot` object and configures the display of the specified point cloud.

To remove the point cloud associated with the point cloud plotter, use the `clearData` function with `pcPlotter` specified as the input argument.

`plotPointCloud(pcPlotter,pointCloudMatrix)` specifies the point cloud data as a matrix of 2-D or 3-D points, `pointCloudMatrix`.

Examples

Generate Lidar Point Cloud Data of Multiple Actors

Generate lidar point cloud data for a driving scenario with multiple actors by using the `lidarPointCloudGenerator` System object. Create the driving scenario by using `drivingScenario` object. It contains an ego-vehicle, pedestrian and two other vehicles.

Create and plot a driving scenario with multiple vehicles

Create a driving scenario.

```
scenario = drivingScenario;
```

Add a straight road to the driving scenario. The road has one lane in each direction.

```
roadCenters = [0 0 0; 70 0 0];
laneSpecification = lanespec([1 1]);
road(scenario,roadCenters,'Lanes',laneSpecification);
```

Add an ego vehicle to the driving scenario.

```
egoVehicle = vehicle(scenario,'ClassID',1,'Mesh',driving.scenario.carMesh);
waypoints = [1 -2 0; 35 -2 0];
smoothTrajectory(egoVehicle,waypoints,10);
```

Add a truck, pedestrian, and bicycle to the driving scenario and plot the scenario.

```
truck = vehicle(scenario,'ClassID',2,'Length', 8.2,'Width',2.5,'Height',3.5, ...
    'Mesh',driving.scenario.truckMesh);
```

```

waypoints = [70 1.7 0; 20 1.9 0];
smoothTrajectory(truck,waypoints,15);

pedestrian = actor(scenario,'ClassID',4,'Length',0.24,'Width',0.45,'Height',1.7, ...
    'Mesh',driving.scenario.pedestrianMesh);
waypoints = [23 -4 0; 10.4 -4 0];
smoothTrajectory(pedestrian,waypoints,1.5);

bicycle = actor(scenario,'ClassID',3,'Length',1.7,'Width',0.45,'Height',1.7, ...
    'Mesh',driving.scenario.bicycleMesh);
waypoints = [12.7 -3.3 0; 49.3 -3.3 0];
smoothTrajectory(bicycle,waypoints,5);

plot(scenario,'Meshes','on')

```

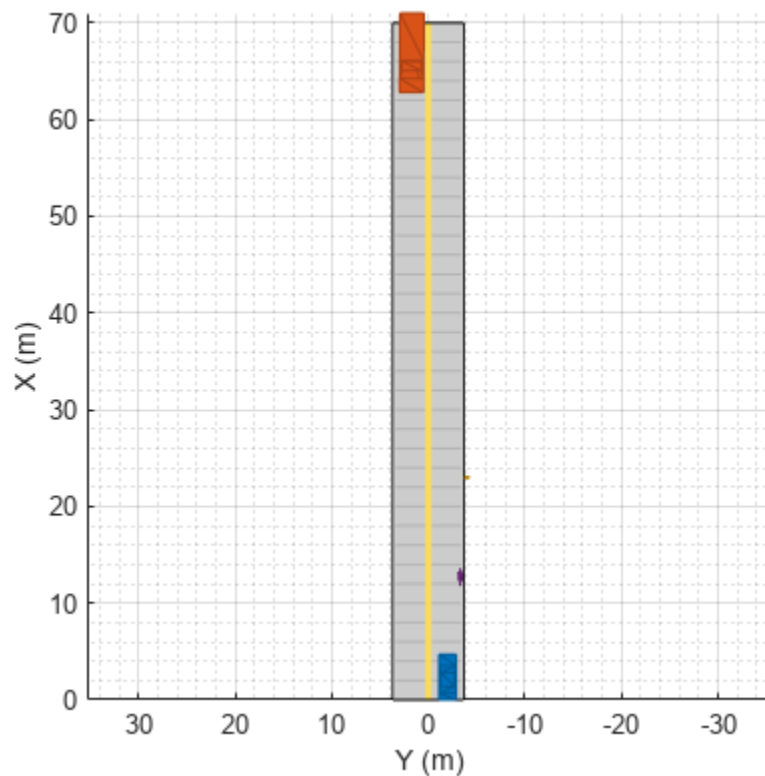

Generate and plot lidar point cloud data

Create a `lidarPointCloudGenerator` System object.

```
lidar = lidarPointCloudGenerator;
```

Add actor profiles and the ego vehicle actor ID from the driving scenario to the System object.

```
lidar.ActorProfiles = actorProfiles(scenario);
lidar.EgoVehicleActorID = egoVehicle.ActorID;
```

Plot the point cloud data.

```
bep = birdsEyePlot('Xlimits',[0 70],'Ylimits',[-30 30]);
plotter = pointCloudPlotter(bep);
legend('off');
while advance(scenario)
    tgts = targetPoses(egoVehicle);
    rdmesh = roadMesh(egoVehicle);
    [ptCloud,isValidTime] = lidar(tgts,rdmesh,scenario.SimulationTime);
    if isValidTime
        plotPointCloud(plotter,ptCloud);
    end
end
```

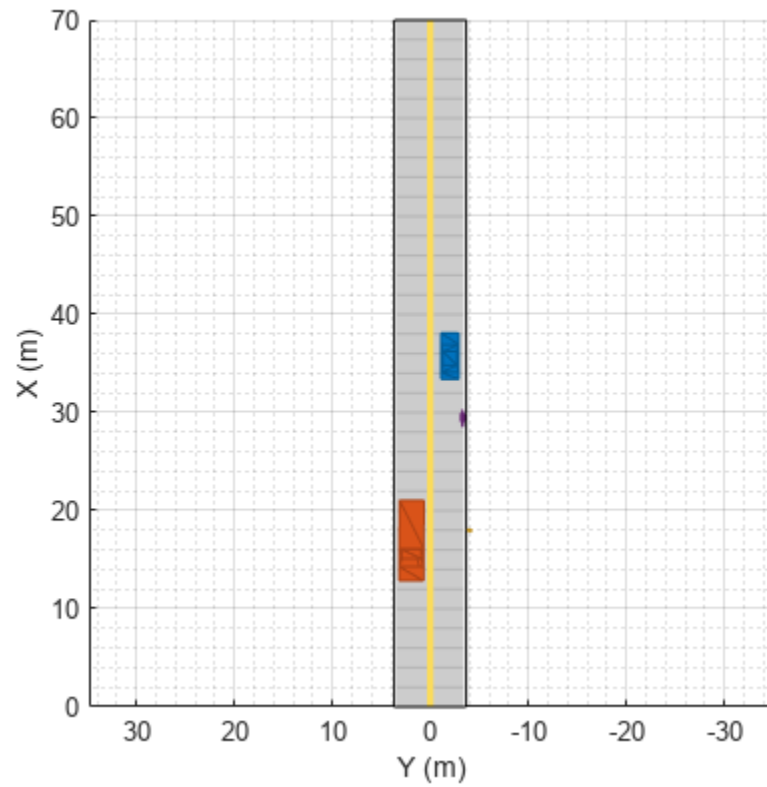

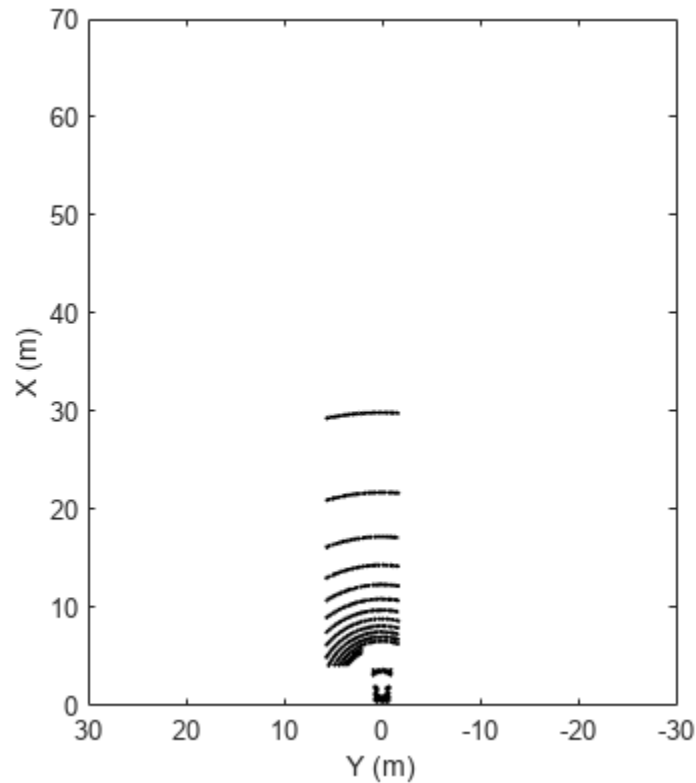

Input Arguments

pcPlotter — Point cloud plotter

`pointCloudPlotter` object

Point cloud plotter, specified as a `pointCloudPlotter` object. This object is stored in the `Plotters` property of a `birdsEyePlot` object and configures the display of the specified point cloud in the bird's-eye plot. The property names correspond to the name-value pair arguments of the `pointCloudPlotter` function.

pcObject — Point cloud data object

`pointCloud` object

Point cloud data object, specified as a `pointCloud` object.

pointCloudMatrix — Point cloud data matrix

N -by-2 or N -by-3 real-valued matrix

Point cloud data matrix, specified as a N -by-2 or N -by-3 real-valued matrix. Each element in the first column of the matrix corresponds to the x -coordinates of a point in the point cloud. The elements in the second and third columns correspond to y - and z -coordinates.

Data Types: `single` | `double`

Version History

Introduced in R2020a

See Also

`birdsEyePlot` | `pointCloudPlotter` | `findPlotter` | `clearData` | `clearPlotterData`

plotPath

Display actor paths on bird's-eye plot

Syntax

```
plotPath(pPlotter, pathCoords)
```

Description

`plotPath(pPlotter, pathCoords)` displays the paths of actors from a list of path coordinates on a bird's-eye plot. The path plotter object, `pPlotter`, is associated with a `birdsEyePlot` object and configures the display of the specified path.

To remove all paths associated with the path plotter `pPlotter`, call the `clearData` function and specify `pPlotter` as the input argument.

Examples

Plot Path of Ego Vehicle

Create a 3-meter-wide lane.

```
lb = parabolicLaneBoundary([-0.001, 0.01, 1.5]);
rb = parabolicLaneBoundary([-0.001, 0.01, -1.5]);
```

Compute the lane boundary model manually from 0 to 30 meters along the x-axis.

```
xWorld = (0:30)';
yLeft = computeBoundaryModel(lb, xWorld);
yRight = computeBoundaryModel(rb, xWorld);
```

Create a bird's-eye plot and lane boundary plotter. Display the lane information on the bird's-eye plot.

```
bep = birdsEyePlot('XLimits', [0 30], 'YLimits', [-5 5]);
lanePlotter = laneBoundaryPlotter(bep, 'DisplayName', 'Lane boundaries');
plotLaneBoundary(lanePlotter, {[xWorld, yLeft], [xWorld, yRight]});
```

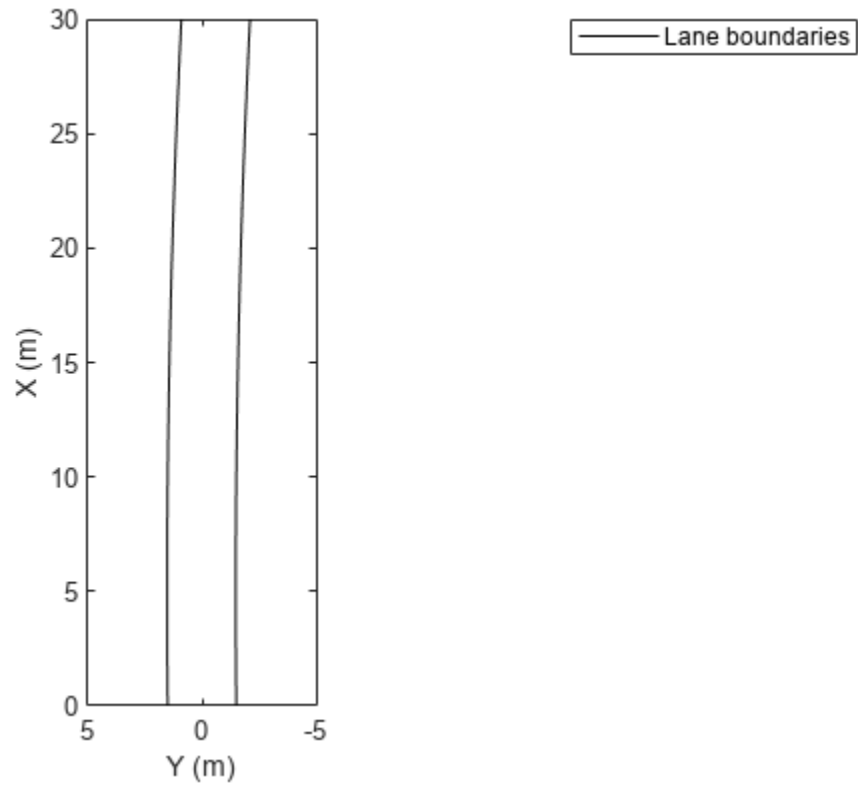

Create a path plotter. Create and display the path of an ego vehicle that travels through the center of the lane.

```
yCenter = (yLeft + yRight)/2;  
egoPathPlotter = pathPlotter(bep, 'DisplayName', 'Ego vehicle path');  
plotPath(egoPathPlotter, {[xWorld, yCenter]});
```

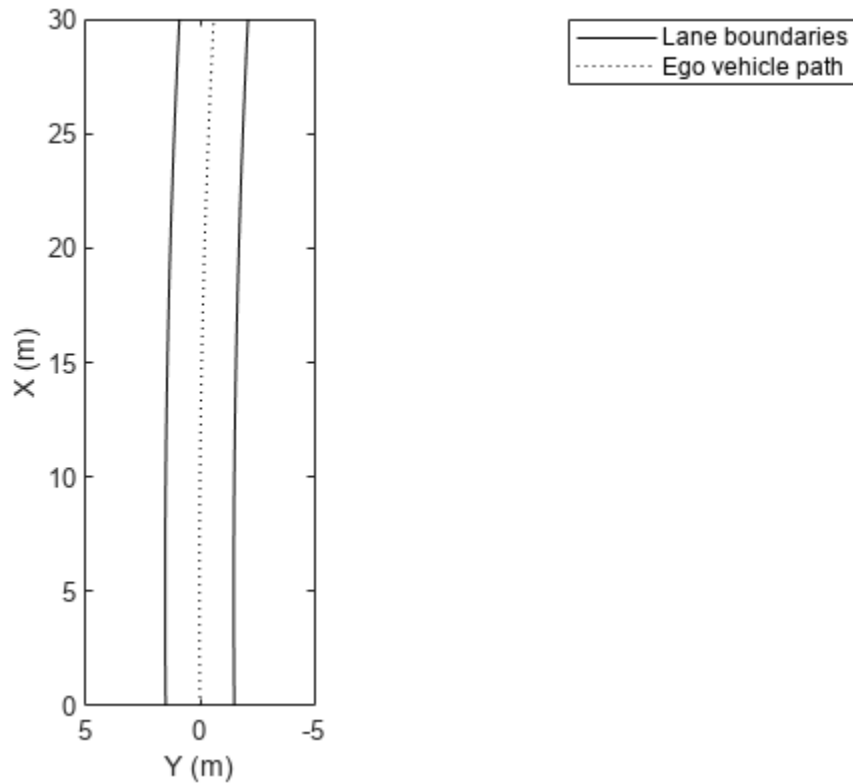
Input Arguments

pPlotter — Path plotter

PathPlotter object

Path plotter, specified as a PathPlotter object. This object is stored in the Plotters property of a birdsEyePlot object and configures the display of the specified actor paths in the bird's-eye plot. To create this object, use the pathPlotter function.

pathCoords — Path coordinates

cell array of M -by-2 real-valued matrices

Path coordinates, specified as a cell array of M -by-2 real-valued matrices. Each matrix represents the coordinates for a different path. M is the number of coordinates in a path and can be different for each path. The first and second columns of each matrix represent the (X, Y) positions of the path curve. The positive X -direction points ahead of the center of the vehicle. The positive Y -direction points to the left of the origin of the vehicle, which is the center of the rear axle, as shown in this figure of the vehicle coordinate system..



Path coordinates are relative to the ego vehicle.

Version History

Introduced in R2017a

See Also

[birdsEyePlot](#) | [pathPlotter](#)

plotTrack

Display object tracks on bird's-eye plot

Syntax

```
plotTrack(tPlotter,positions)
plotTrack(tPlotter,positions,velocities)
plotTrack(tPlotter,positions,labels)
plotTrack(tPlotter,positions,covariances)
plotTrack(tPlotter,positions,velocities,labels,covariances)
```

Description

`plotTrack(tPlotter,positions)` displays object tracks from a list of object positions on a bird's-eye plot. The track plotter, `tPlotter`, is associated with a `birdsEyePlot` object and configures the display of the object tracks.

To remove all tracks associated with track plotter `tPlotter`, call the `clearData` function and specify `tPlotter` as the input argument.

`plotTrack(tPlotter,positions,velocities)` displays tracks and their velocities on a bird's-eye plot.

`plotTrack(tPlotter,positions,labels)` displays tracks and their labels on a bird's-eye plot.

`plotTrack(tPlotter,positions,covariances)` displays tracks and the covariances of track uncertainties on a bird's-eye plot.

`plotTrack(tPlotter,positions,velocities,labels,covariances)` displays tracks and their velocities, labels, and covariances on a bird's-eye plot. You can specify one or more of `velocities`, `labels`, and `covariances`. These arguments can appear in any order but they must come after `tPlotter` and `positions`.

Examples

Create and Display Labeled Tracks on Bird's-Eye Plot

Create a bird's-eye plot with an x-axis range from 0 to 90 meters and a y-axis range from -35 to 35 meters. Create a track plotter that displays up to seven history values for each track and offsets labels by 3 meters in front of the tracks.

```
bep = birdsEyePlot('XLim',[0 90],'YLim',[-35 35]);
tPlotter = trackPlotter(bep,'DisplayName','Tracks','HistoryDepth',7,'LabelOffset',[3 0]);
```

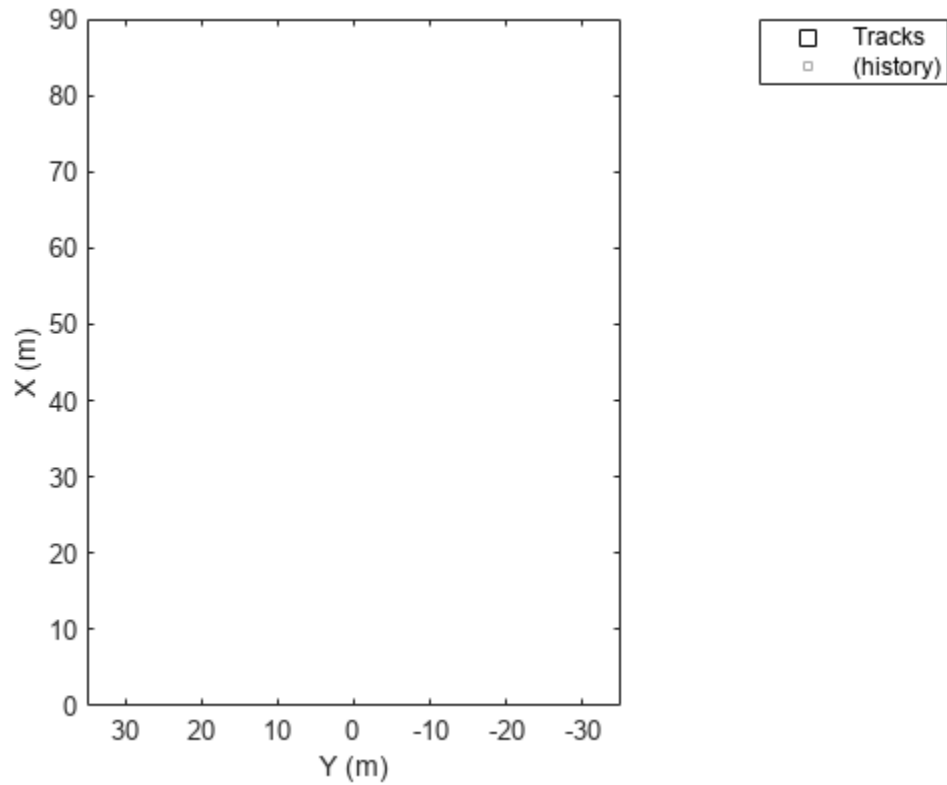

Set the positions and velocities of three labeled tracks.

```
positions = [30, 5; 30, 5; 30, 5];  
velocities = [3, 0; 3, 2; 3, -3];  
labels = {'T1', 'T2', 'T3'};
```

Display the tracks for 10 trials. The bird's-eye plot shows the seven history values specified previously.

```
for i=1:10  
    plotTrack(tPlotter, positions, velocities, labels);  
    positions = positions + velocities;  
end
```

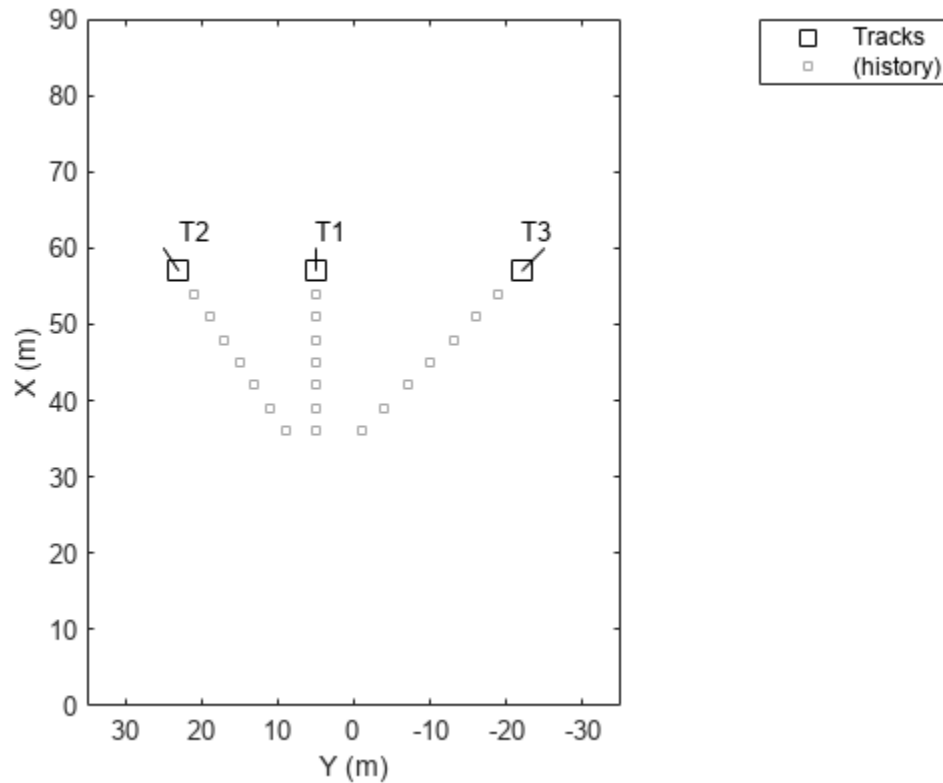

Input Arguments

tPlotter — Track plotter

TrackPlotter object

Track plotter, specified as a TrackPlotter object. This object is stored in the Plotters property of a birdsEyePlot object and configures the display of the specified tracks in the bird's-eye plot. To create this object, use the trackPlotter function.

positions — Positions of tracked objects

M -by-2 real-valued matrix

Positions of tracked objects in vehicle coordinates, specified as an M -by-2 real-valued matrix of (X, Y) positions. M is the number of tracked objects. The positive X -direction points ahead of the center of the vehicle. The positive y -direction points to the left of the origin of the vehicle, which is the center of the rear axle, as shown in this figure of the vehicle coordinate system.

**velocities – Velocities of tracked objects**

M -by-2 real-valued matrix

Velocities of tracked objects, specified as an M -by-2 real-valued matrix of velocities in the (X, Y) direction. M is the number of tracked objects. The velocities are plotted as line vectors that originate from the center positions of the tracked objects.

labels – Track labels

M -length string array | M -length cell array of character vectors

Track labels, specified as an M -length string array or an M -length cell array of character vectors. M is the number of tracked objects. The labels correspond to the locations in the `positions` matrix. By default, tracks do not have labels. To remove all annotations and labels associated with the track plotter, use the `clearData` function.

covariances – Covariances of track uncertainties

2-by-2-by- M real-valued array

Covariances of track uncertainties centered at the track positions, specified as a 2-by-2-by- M real-valued array. The uncertainties are plotted as an ellipse.

Version History

Introduced in R2017a

See Also

birdsEyePlot | trackPlotter

plotRangeDetection

Display range detections on bird's-eye-plot

Syntax

```
plotRangeDetection(rangeDetPlotter, ranges, fovs, locations, angles)
plotRangeDetection(rangeDetPlotter, ranges, ____, labels)
```

Description

`plotRangeDetection(rangeDetPlotter, ranges, fovs, locations, angles)` displays object detections on a bird's-eye-plot from a list of ranges, azimuthal fields of view, sensor mounting locations, and angles. `plotRangeDetection` displays each object detection as an arc whose radius is the corresponding range value, with arc length proportional to the azimuthal field of view of the sensor. The mounting locations and angles of the sensor determine the center of the arc.

The range detection plotter, `rangeDetPlotter`, is associated with a `birdsEyePlot` object and configures the display of the specified detections.

To remove all detections associated with detection plotter `rangeDetPlotter`, call the `clearData` function and specify `rangeDetPlotter` as the input argument.

`plotRangeDetection(rangeDetPlotter, ranges, ____, labels)` displays detections and their labels on a bird's-eye plot in addition to all input arguments from the previous syntax.

Examples

Generate Ultrasonic Detections of Multiple Vehicles

Use a simulated ultrasonic sensor to generate detections for multiple vehicles in a driving scenario.

Create Driving Scenario

Create a driving scenario containing a three-lane road using lane specifications.

```
scenario = drivingScenario;
roadCenters = [-120 30 0; -60 0 0; 0 0 0; 60 0 0; 120 30 0];
lspc = lanespec(3);
road(scenario, roadCenters, Lanes=lspc);
```

Create an ego vehicle that travels in the center lane at a velocity of 30 m/s.

```
egovehicle = vehicle(scenario, ClassID=1);
egopath = [1.5 0 0; 60 0 0; 111 25 0];
egospeed = 30;
smoothTrajectory(egovehicle, egopath, egospeed);
```

Add a target vehicle that travels ahead of the ego vehicle at 30.5 m/s in the right lane, and changes lanes close to the ego vehicle.

```

ftargetcar = vehicle(scenario,ClassID=1);
ftargetpath = [8 2; 60 -3.2; 120 33];
ftargetspeed = 30.5;
smoothTrajectory(ftargetcar,ftargetpath,ftargetspeed);

```

Add a second target vehicle that travels in the left lane at 32m/s.

```

ltargetcar = vehicle(scenario,ClassID=1);
ltargetpath = [-5.0 3.5 0; 60 3.5 0; 111 28.5 0];
ltargetspeed = 32;
smoothTrajectory(ltargetcar,ltargetpath,ltargetspeed);

```

Display a chase plot from behind the ego vehicle for a 3D view of the scenario..

```
chasePlot(egovehicle)
```

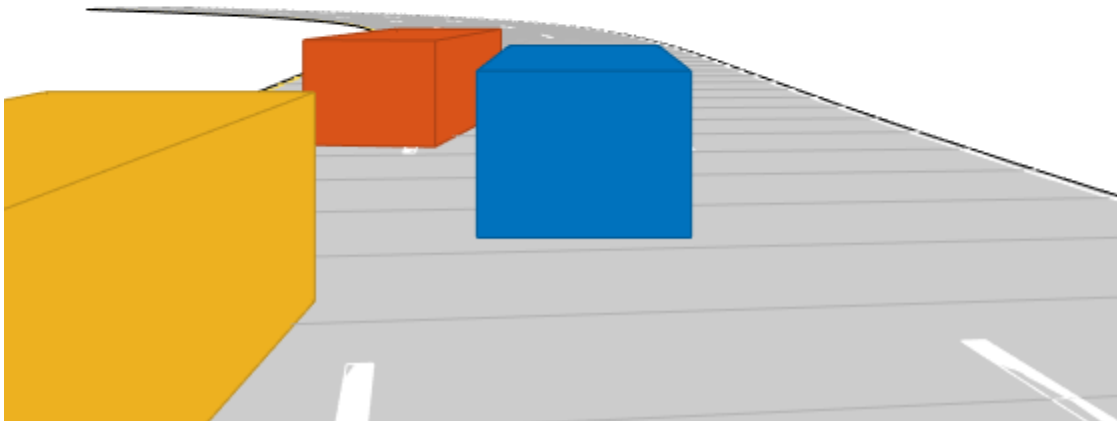

Create Ultrasonic Sensors

Create an ultrasonic sensor mounted at the front of the ego vehicle.

```

frontUltrasonic = ultrasonicDetectionGenerator(1,FieldOfView=[70 35]);
frontUltrasonic.Profiles = actorProfiles(scenario);

```

Create a second ultrasonic sensor mounted on the left side of the ego vehicle.

```

leftUltrasonic = ultrasonicDetectionGenerator(2,MountingLocation=[0.5 1 0.2],MountingAngles=[90 0 90]);
leftUltrasonic.Profiles = actorProfiles(scenario);

```

Create Bird's-Eye-Plot

Create a bird's-eye-plot for visualizing the sensor data. Add plotters for visualizing the ultrasonic coverage areas, detections, and points on targets. Use a `rangeDetectionPlotter` object to visualize ultrasonic detections as arcs and a `detectionPlotter` object to visualize the closest points on the target as markers. Add plotters to display the lane markings and vehicle outlines.

```
% Create bird's eye plot
bep = birdsEyePlot(XLim=[-20 20],YLim=[-12 12]);

% Plotters for Coverage areas of two ultrasonic sensors
fcaPlotter = coverageAreaPlotter(bep,DisplayName="Front Ultrasonic field of view");
plotCoverageArea(fcaPlotter,frontUltrasonic.MountingLocation(1:2), ...
    frontUltrasonic.DetectionRange(3),frontUltrasonic.MountingAngles(1),frontUltrasonic.FieldOfView(1));

lcaPlotter = coverageAreaPlotter(bep,DisplayName="Left Ultrasonic field of view",FaceColor="y");
plotCoverageArea(lcaPlotter,leftUltrasonic.MountingLocation(1:2), ...
    leftUltrasonic.DetectionRange(3),leftUltrasonic.MountingAngles(1),leftUltrasonic.FieldOfView(1));

% Range Detection Plotters for Ultrasonic Detections
frdPlotter = rangeDetectionPlotter(bep,DisplayName="Front Ultrasonic Ranges");
lrdPlotter = rangeDetectionPlotter(bep,DisplayName="Left Ultrasonic Ranges",LineStyle=":");

% Detection plotters for closest points on targets
fdetPlotter = detectionPlotter(bep,DisplayName="Point-On-Target (Front Ultrasonic)",MarkerFaceColor="r");
ldetPlotter = detectionPlotter(bep,DisplayName="Point-On-Target (Rear Ultrasonic)",MarkerFaceColor="r");

% Plotters for vehicle and target outlines, lane markings
olPlotter = outlinePlotter(bep);
lmPlotter = laneMarkingPlotter(bep,DisplayName="Lane markings");
```

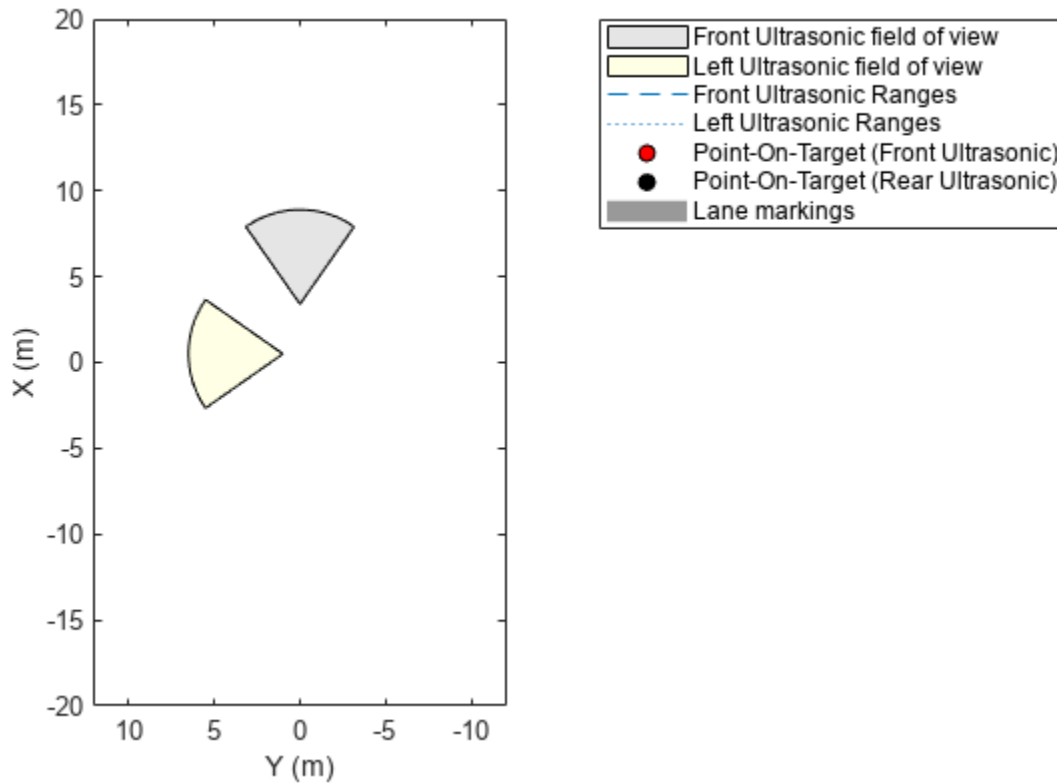

Run the Simulation and Generate Detections

Run the scenario simulation. At each timestep:

- 1 Obtain the ground truth target poses, and generate detections for the two ultrasonic sensors.
- 2 Obtain and display the target outlines and lane markings.
- 3 When there are valid detections, display the detections and the corresponding points-on-targets generated by the ultrasonic sensor.

```
while advance(scenario)
```

```
    tgtpose = targetPoses(egovehicle);
```

```
    [fobdets, fisValid] = frontUltrasonic(tgtpose, scenario.SimulationTime);
    [lobdets, lisValid] = leftUltrasonic(tgtpose, scenario.SimulationTime);
```

```
    [objposition, objyaw, objlength, objwidth, objoriginOffset, color] = targetOutlines(egovehicle);
    plotOutline(olPlotter, objposition, objyaw, objlength, objwidth, ...
        OriginOffset=objoriginOffset, Color=color)
```

```
    [lmv, lmf] = laneMarkingVertices(egovehicle);
    plotLaneMarking(lmPlotter, lmv, lmf)
```

```
    if ~isempty(fobdets) && fisValid
        franges = fobdets{1}.Measurement;
        plotRangeDetection(frdPlotter, franges, frontUltrasonic.FieldOfView(1), frontUltrasonic.Mour
        plotDetection(fdetPlotter, fobdets{1}.ObjectAttributes{1}.PointOnTarget(1:2)')
```

```

end
if ~isempty(lobdets) && lisValid
    lranges = lobdets{1}.Measurement;
    plotRangeDetection(lrdPlotter,lranges,leftUltrasonic.FieldOfView(1),leftUltrasonic.Mount);
    plotDetection(ldetPlotter,lobdets{1}.ObjectAttributes{1}.PointOnTarget(1:2)')
end
end
end

```

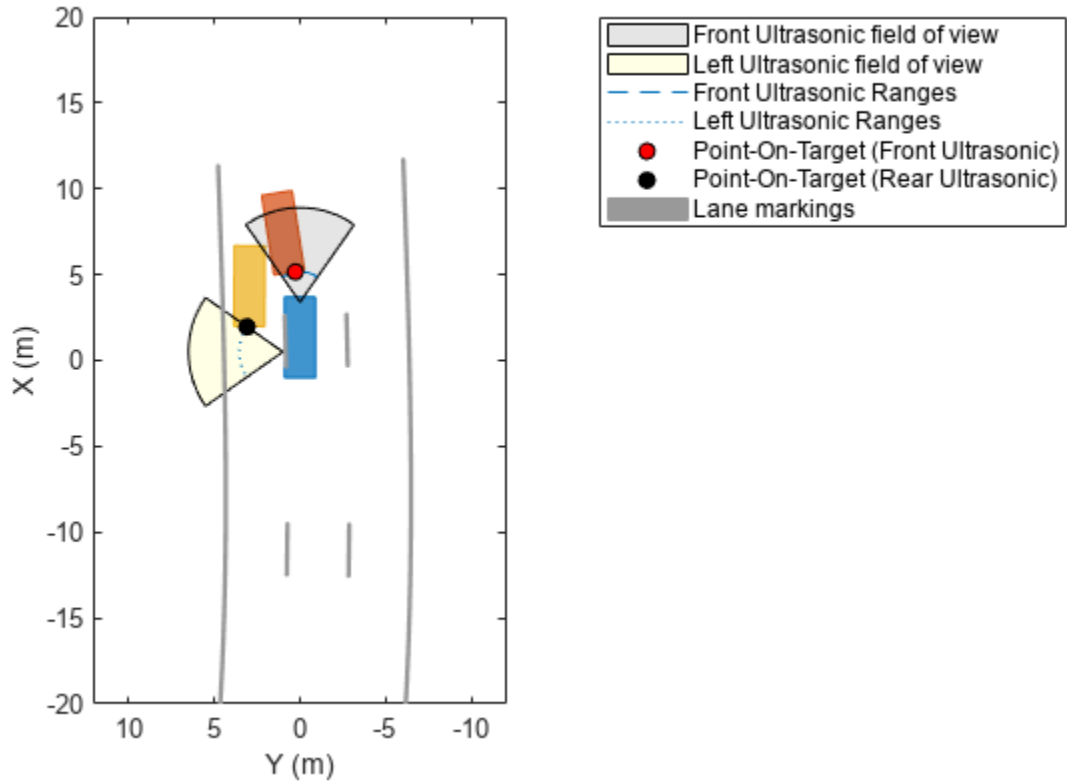

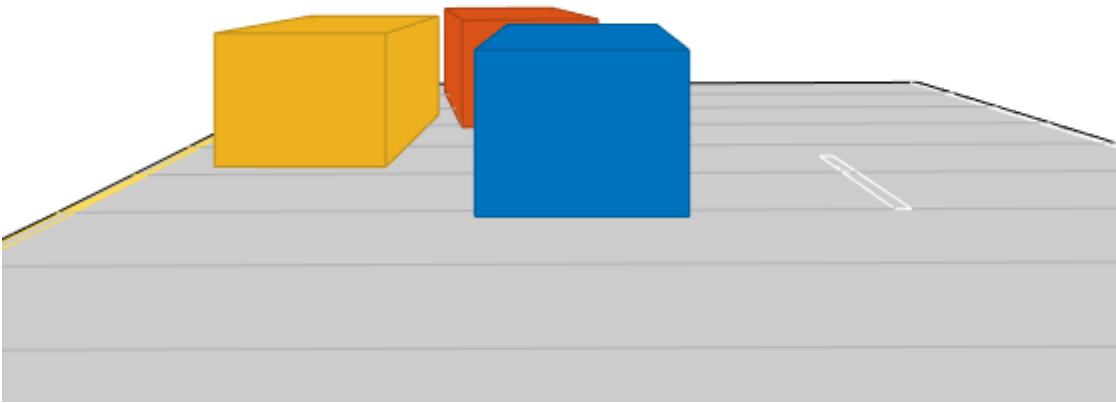

Input Arguments

rangeDetPlotter — Range detection plotter

`rangeDetectionPlotter` object

Range detection plotter, specified as a `rangeDetectionPlotter` object. This object is stored in the `Plotters` property of a `birdsEyePlot` object and configures the display of the specified detections in the bird's-eye plot. To create this object, use the `rangeDetectionPlotter` function.

ranges — Range values of detected objects

1-by- M real-valued vector

Range values of detected objects, specified as a 1-by- M real-valued vector. M is the number of detected objects. Each range value is the distance from the sensor to the detected object in vehicle coordinates. The range values are plotted as arcs whose radii are the corresponding range values, with arc lengths proportional to the azimuthal fields of view values of the sensors. Units are in meters.

fovs — Azimuthal fields of view of sensors

360 (default) | 1-by- M real-valued vector

Azimuthal fields of view of the sensors, specified as an 1-by- M real-valued vector. Each element is the azimuthal field of view of the sensor that measured the corresponding range value in `ranges`. Units are in degrees.

locations — Mounting locations of sensors`[0 0 0]` (default) | M -by-3 real-valued matrix

Mounting locations of the sensors, specified as an M -by-3 real-valued matrix. Each row is the mounting location of the sensor that measured the corresponding range value in `ranges`, and is of the form $[x\ y\ z]$. Units are in meters.

angles — Mounting angles of sensors`[0 0 0]` (default) | M -by-3 real-valued matrix

Mounting angles of the sensors, specified as an M -by-3 real-valued matrix. Each row is the mounting angle of the sensor that measured the corresponding range value in `ranges`, and is of the form $[z_{yaw}\ y_{pitch}\ x_{roll}]$. Units are in degrees.

labels — Detection labels M -element string array | M -element cell array of character vectors

Detection labels, specified as an M -element string array or M -element cell array of character vectors. M is the number of detected objects. The labels correspond to the locations in the `ranges` vector. By default, detections do not have labels. To remove all annotations and labels associated with the detection plotter, use the `clearData` function.

Version History

Introduced in R2022a**See Also**`rangeDetectionPlotter` | `ultrasonicDetectionGenerator` | `birdsEyePlot`

rangeDetectionPlotter

Package:

Range detection plotter for bird's-eye-plot

Syntax

```
rangeDetPlotter = rangeDetectionPlotter(bep)
rangeDetPlotter = rangeDetectionPlotter(bep,Name=Value)
```

Description

`rangeDetPlotter = rangeDetectionPlotter(bep)` creates a `rangeDetectionPlotter` object that configures the display of object detections from an ultrasonic sensor on a bird's-eye plot. The `rangeDetectionPlotter` object is stored in the `Plotters` property of the input `birdsEyePlot` object, `bep`. To plot the object detections, use the `plotRangeDetection` function.

`rangeDetPlotter = rangeDetectionPlotter(bep,Name=Value)` sets properties using one or more `Name=Value` arguments. For example, `rangeDetectionPlotter(bep,DisplayName="Range Detections")` sets the display name that appears in the bird's-eye-plot legend.

Examples

Generate Ultrasonic Detections of Multiple Vehicles

Use a simulated ultrasonic sensor to generate detections for multiple vehicles in a driving scenario.

Create Driving Scenario

Create a driving scenario containing a three-lane road using lane specifications.

```
scenario = drivingScenario;
roadCenters = [-120 30 0; -60 0 0; 0 0 0; 60 0 0; 120 30 0];
lspc = lanespec(3);
road(scenario,roadCenters,Lanes=lspc);
```

Create an ego vehicle that travels in the center lane at a velocity of 30 m/s.

```
egovehicle = vehicle(scenario,ClassID=1);
egopath = [1.5 0 0; 60 0 0; 111 25 0];
egospeed = 30;
smoothTrajectory(egovehicle,egopath,egospeed);
```

Add a target vehicle that travels ahead of the ego vehicle at 30.5 m/s in the right lane, and changes lanes close to the ego vehicle.

```
ftargetcar = vehicle(scenario,ClassID=1);
ftargetpath = [8 2; 60 -3.2; 120 33];
ftargetspeed = 30.5;
smoothTrajectory(ftargetcar,ftargetpath,ftargetspeed);
```

Add a second target vehicle that travels in the left lane at 32m/s.

```
ltargetcar = vehicle(scenario,ClassID=1);  
ltargetpath = [-5.0 3.5 0; 60 3.5 0; 111 28.5 0];  
ltargetspeed = 32;  
smoothTrajectory(ltargetcar,ltargetpath,ltargetspeed);
```

Display a chase plot from behind the ego vehicle for a 3D view of the scenario..

```
chasePlot(egovehicle)
```

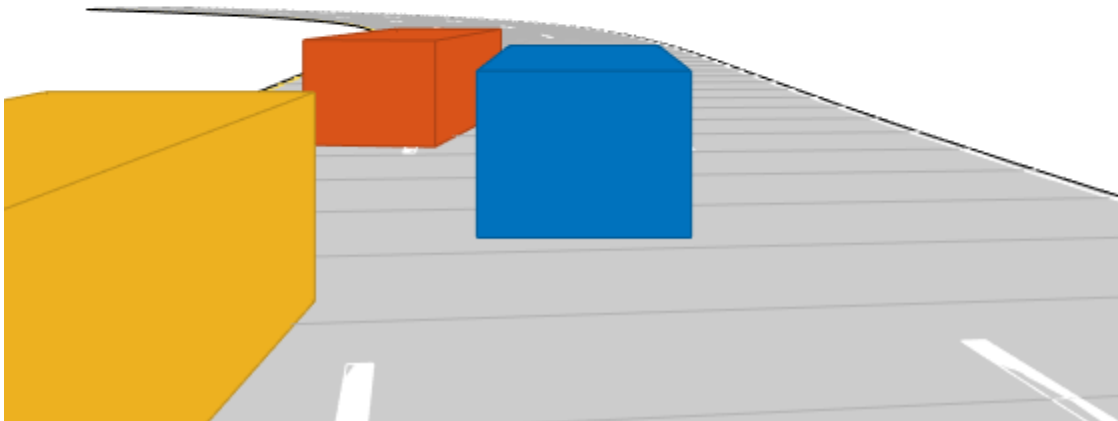

Create Ultrasonic Sensors

Create an ultrasonic sensor mounted at the front of the ego vehicle.

```
frontUltrasonic = ultrasonicDetectionGenerator(1,FieldOfView=[70 35]);  
frontUltrasonic.Profiles = actorProfiles(scenario);
```

Create a second ultrasonic sensor mounted on the left side of the ego vehicle.

```
leftUltrasonic = ultrasonicDetectionGenerator(2,MountingLocation=[0.5 1 0.2],MountingAngles=[90  
leftUltrasonic.Profiles = actorProfiles(scenario);
```

Create Bird's-Eye-Plot

Create a bird's-eye-plot for visualizing the sensor data. Add plotters for visualizing the ultrasonic coverage areas, detections, and points on targets. Use a `rangeDetectionPlotter` object to

visualize ultrasonic detections as arcs and a `detectionPlotter` object to visualize the closest points on the target as markers. Add plotters to display the lane markings and vehicle outlines.

```
% Create bird's eye plot
```

```
bep = birdsEyePlot(XLim=[-20 20],YLim=[-12 12]);
```

```
% Plotters for Coverage areas of two ultrasonic sensors
```

```
fcaPlotter = coverageAreaPlotter(bep,DisplayName="Front Ultrasonic field of view");
```

```
plotCoverageArea(fcaPlotter,frontUltrasonic.MountingLocation(1:2), ...
    frontUltrasonic.DetectionRange(3),frontUltrasonic.MountingAngles(1),frontUltrasonic.FieldOfView(1));
```

```
lcaPlotter = coverageAreaPlotter(bep,DisplayName="Left Ultrasonic field of view",FaceColor="y");
```

```
plotCoverageArea(lcaPlotter,leftUltrasonic.MountingLocation(1:2), ...
    leftUltrasonic.DetectionRange(3),leftUltrasonic.MountingAngles(1),leftUltrasonic.FieldOfView(1));
```

```
% Range Detection Plotters for Ultrasonic Detections
```

```
frdPlotter = rangeDetectionPlotter(bep,DisplayName="Front Ultrasonic Ranges");
```

```
lrdPlotter = rangeDetectionPlotter(bep,DisplayName="Left Ultrasonic Ranges",LineStyle=":");
```

```
% Detection plotters for closest points on targets
```

```
fdetPlotter = detectionPlotter(bep,DisplayName="Point-On-Target (Front Ultrasonic)",MarkerFaceColor="r");
```

```
ldetPlotter = detectionPlotter(bep,DisplayName="Point-On-Target (Rear Ultrasonic)",MarkerFaceColor="b");
```

```
% Plotters for vehicle and target outlines, lane markings
```

```
olPlotter = outlinePlotter(bep);
```

```
lmPlotter = laneMarkingPlotter(bep,DisplayName="Lane markings");
```

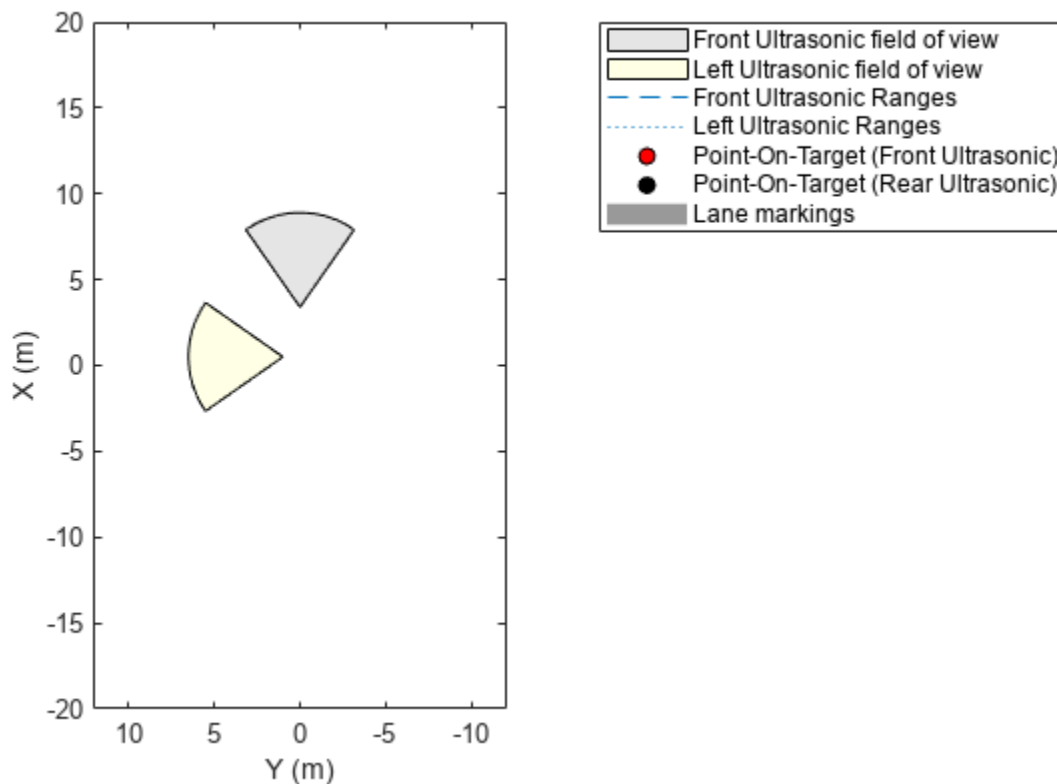

Run the Simulation and Generate Detections

Run the scenario simulation. At each timestep:

- 1 Obtain the ground truth target poses, and generate detections for the two ultrasonic sensors.
- 2 Obtain and display the target outlines and lane markings.
- 3 When there are valid detections, display the detections and the corresponding points-on-targets generated by the ultrasonic sensor.

```

while advance(scenario)

    tgtpose = targetPoses(egovehicle);

    [fobdets,fisValid] = frontUltrasonic(tgtpose,scenario.SimulationTime);
    [lobdets,lisValid] = leftUltrasonic(tgtpose,scenario.SimulationTime);

    [objposition,objyaw,objlength,objwidth,objjoriginOffset,color] = targetOutlines(egovehicle);
    plotOutline(olPlotter,objposition,objyaw,objlength,objwidth, ...
        OriginOffset=objjoriginOffset,Color=color)

    [lmv,lmf] = laneMarkingVertices(egovehicle);
    plotLaneMarking(lmPlotter,lmv,lmf)

    if ~isempty(fobdets) && fisValid
        franges = fobdets{1}.Measurement;
        plotRangeDetection(frdPlotter,franges,frontUltrasonic.FieldOfView(1),frontUltrasonic.Mount);
        plotDetection(fdetPlotter,fobdets{1}.ObjectAttributes{1}.PointOnTarget(1:2)')
    end

    if ~isempty(lobdets) && lisValid
        lranges = lobdets{1}.Measurement;
        plotRangeDetection(lrdPlotter,lranges,leftUltrasonic.FieldOfView(1),leftUltrasonic.Mount);
        plotDetection(ldetPlotter,lobdets{1}.ObjectAttributes{1}.PointOnTarget(1:2)')
    end
end

```

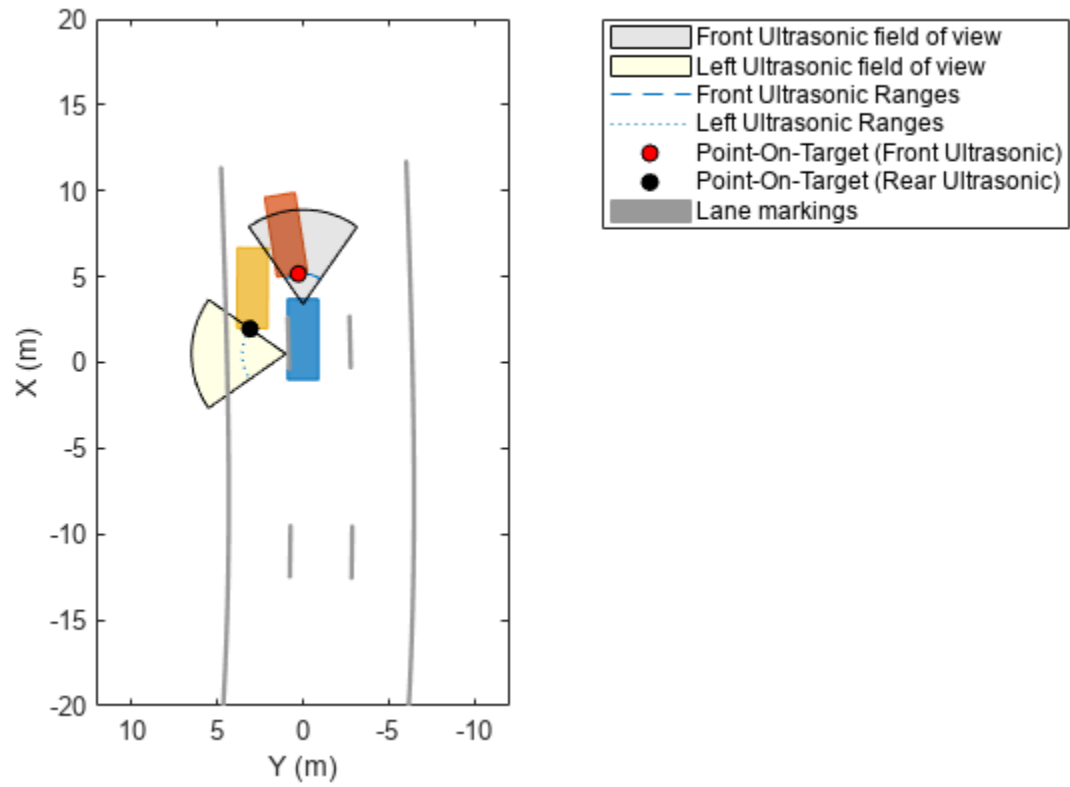

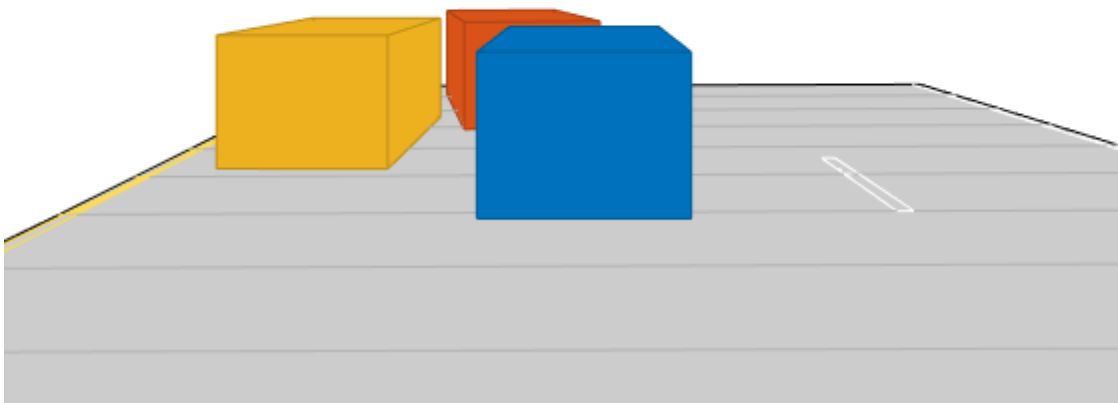

Input Arguments

bep — Bird's-eye plot

`birdsEyePlot` object

Bird's-eye plot, specified as a `birdsEyePlot` object.

Name-Value Pair Arguments

Specify optional pairs of arguments as `Name1=Value1, ..., NameN=ValueN`, where `Name` is the argument name and `Value` is the corresponding value. Name-value arguments must appear after other arguments, but the order of the pairs does not matter.

Before R2021a, use commas to separate each name and value, and enclose Name in quotes.

Example: `LineWidth=1`

DisplayName — Plotter name to display in legend





`''` (default) | character vector | string scalar

Plotter name to display in the legend, specified as a character vector or string scalar. If you do not specify a name, the bird's-eye plot does not display a legend entry for the plotter.

LineStyle — Range line style

`'--'` (default) | `'-'` | `':'` | `'-.'` | `'none'`

Range line style, specified as one of the options listed in this table.

Line Style	Description	Resulting Line
"_"	Solid line	
"_ _"	Dashed line	
":"	Dotted line	
"- ."	Dash-dotted line	
"none"	No line	No line

LineWidth — Width of range line

0.5 (default) | positive scalar

Width of range line, specified as a positive scalar.

FontSize — Font size for range labels

10 points (default) | positive integer

Font size for range labels, specified as a positive integer in font points.

LabelOffset — Gap between label and positional point

[0 0] (default) | real-valued vector of form [x y]

Gap between label and positional point, specified as a real-valued vector of the form [x y]. Units are in meters.

Tag — Tag associated with plotter object

'PlotterN' (default) | character vector | string scalar

Tag associated with the plotter object, specified a character vector or string scalar. The default value is 'PlotterN', where *N* is an integer that corresponds to the *N*th plotter associated with the input `birdsEyePlot` object.

Output Arguments

rangeDetPlotter — Range detection plotter

rangeDetectionPlotter object

Range detection plotter, returned as a `rangeDetectionPlotter` object. You can modify this object by changing its property values. The property names correspond to the name-value arguments of the `rangeDetectionPlotter` function.

`rangeDetPlotter` is stored in the `Plotters` property of the input `birdsEyePlot` object, `bep`. To plot the detections, use the `plotRangeDetection` function.

Version History

Introduced in R2022a

See Also

`plotRangeDetection` | `ultrasonicDetectionGenerator` | `birdsEyePlot` | `clearData`

trackPlotter

Package:

Track plotter for bird's-eye plot

Syntax

```
tPlotter = trackPlotter(bep)
tPlotter = trackPlotter(bep,Name,Value)
```

Description

`tPlotter = trackPlotter(bep)` creates a `TrackPlotter` object that configures the display of tracks on a bird's-eye plot. The `TrackPlotter` object is stored in the `Plotters` property of the input `birdsEyePlot` object, `bep`. To display the tracks, use the `plotTrack` function.

`tPlotter = trackPlotter(bep,Name,Value)` sets properties using one or more `Name,Value` pair arguments. For example, `trackPlotter(bep,'DisplayName','Tracks')` sets the display name that appears in the bird's-eye-plot legend.

Examples

Create and Display Labeled Tracks on Bird's-Eye Plot

Create a bird's-eye plot with an x-axis range from 0 to 90 meters and a y-axis range from -35 to 35 meters. Create a track plotter that displays up to seven history values for each track and offsets labels by 3 meters in front of the tracks.

```
bep = birdsEyePlot('XLim',[0 90],'YLim',[-35 35]);
tPlotter = trackPlotter(bep,'DisplayName','Tracks','HistoryDepth',7,'LabelOffset',[3 0]);
```

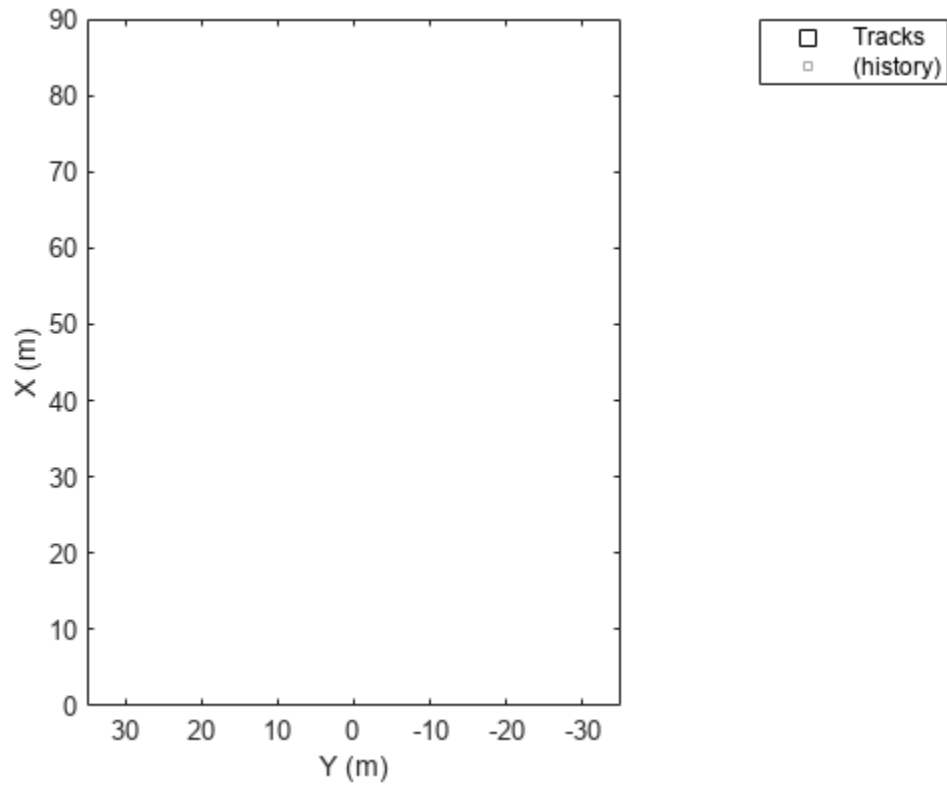

Set the positions and velocities of three labeled tracks.

```
positions = [30, 5; 30, 5; 30, 5];  
velocities = [3, 0; 3, 2; 3, -3];  
labels = {'T1', 'T2', 'T3'};
```

Display the tracks for 10 trials. The bird's-eye plot shows the seven history values specified previously.

```
for i=1:10  
    plotTrack(tPlotter, positions, velocities, labels);  
    positions = positions + velocities;  
end
```

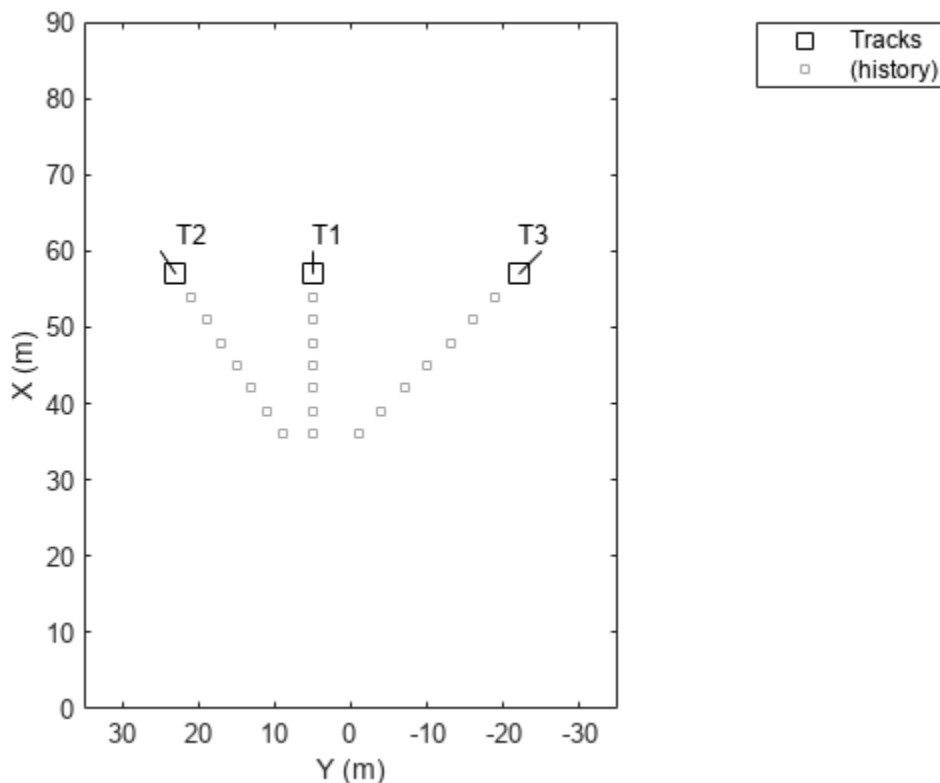
Input Arguments

bep — Bird's-eye plot

`birdsEyePlot` object

Bird's-eye plot, specified as a `birdsEyePlot` object.

Name-Value Pair Arguments

Specify optional pairs of arguments as `Name1=Value1, ..., NameN=ValueN`, where `Name` is the argument name and `Value` is the corresponding value. Name-value arguments must appear after other arguments, but the order of the pairs does not matter.

Before R2021a, use commas to separate each name and value, and enclose Name in quotes.

Example: `trackPlotter('Marker','*')` sets the marker symbol for tracks to an asterisk.

DisplayName — Plotter name to display in legend

`''` (default) | character vector | string scalar

Plotter name to display in legend, specified as the comma-separated pair consisting of `'DisplayName'` and character vector or string scalar. If you do not specify a name, the bird's-eye plot does not display a legend entry for the plotter.

HistoryDepth — Number of previous track updates to display

0 (default) | integer in the range [0, 100]

Number of previous track updates to display, specified as the comma-separated pair consisting of 'HistoryDepth' and an integer in the range [0, 100]. When you set this value to 0, the bird's-eye plot displays no previous updates.

Marker — Marker symbol for tracks

'square' (default) | '+' | '*' | '.' | 'x' | ...

Marker symbol for tracks, specified as the comma-separated pair consisting of 'Marker' and one of the markers in this table.

Marker	Description	Resulting Marker
"o"	Circle	○
"+"	Plus sign	+
"*"	Asterisk	*
."	Point	•
"x"	Cross	×
"_"	Horizontal line	—
" "	Vertical line	
"square"	Square	□
"diamond"	Diamond	◇
"^"	Upward-pointing triangle	△
"v"	Downward-pointing triangle	▽
">"	Right-pointing triangle	▷
"<"	Left-pointing triangle	◁
"pentagram"	Pentagram	☆
"hexagram"	Hexagram	☆
"none"	No markers	Not applicable

MarkerSize — Size of marker for tracks

10 (default) | positive integer

Size of marker for tracks, specified as the comma-separated pair consisting of 'MarkerSize' and a positive integer in points.

MarkerEdgeColor — Marker outline color for tracks







[0 0 0] (black) (default) | RGB triplet | hexadecimal color code | color name | short color name

Marker outline color for tracks, specified as the comma-separated pair consisting of 'MarkerEdgeColor' and an RGB triplet, a hexadecimal color code, a color name, or a short color name.





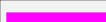
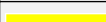

For a custom color, specify an RGB triplet or a hexadecimal color code.

- An RGB triplet is a three-element row vector whose elements specify the intensities of the red, green, and blue components of the color. The intensities must be in the range $[0, 1]$, for example, $[0.4 \ 0.6 \ 0.7]$.
- A hexadecimal color code is a string scalar or character vector that starts with a hash symbol (#) followed by three or six hexadecimal digits, which can range from 0 to F. The values are not case sensitive. Therefore, the color codes "#FF8800", "#ff8800", "#F80", and "#f80" are equivalent.

Alternatively, you can specify some common colors by name. This table lists the named color options, the equivalent RGB triplets, and hexadecimal color codes.

Color Name	Short Name	RGB Triplet	Hexadecimal Color Code	Appearance
"red"	"r"	[1 0 0]	"#FF0000"	
"green"	"g"	[0 1 0]	"#00FF00"	
"blue"	"b"	[0 0 1]	"#0000FF"	
"cyan"	"c"	[0 1 1]	"#00FFFF"	
"magenta"	"m"	[1 0 1]	"#FF00FF"	
"yellow"	"y"	[1 1 0]	"#FFFF00"	
"black"	"k"	[0 0 0]	"#000000"	
"white"	"w"	[1 1 1]	"#FFFFFF"	
"none"	Not applicable	Not applicable	Not applicable	No color

Here are the RGB triplets and hexadecimal color codes for the default colors MATLAB uses in many types of plots.

RGB Triplet	Hexadecimal Color Code	Appearance
[0 0.4470 0.7410]	"#0072BD"	
[0.8500 0.3250 0.0980]	"#D95319"	
[0.9290 0.6940 0.1250]	"#EDB120"	
[0.4940 0.1840 0.5560]	"#7E2F8E"	
[0.4660 0.6740 0.1880]	"#77AC30"	
[0.3010 0.7450 0.9330]	"#4DBEEE"	
[0.6350 0.0780 0.1840]	"#A2142F"	

MarkerFaceColor — Marker fill color for tracks







'none' (default) | RGB triplet | hexadecimal color code | color name | short color name

Marker fill color for tracks, specified as the comma-separated pair consisting of 'MarkerFaceColor' and an RGB triplet, a hexadecimal color code, a color name, or a short color name.

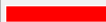



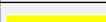

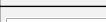
For a custom color, specify an RGB triplet or a hexadecimal color code.

- An RGB triplet is a three-element row vector whose elements specify the intensities of the red, green, and blue components of the color. The intensities must be in the range $[0, 1]$, for example, $[0.4 \ 0.6 \ 0.7]$.
- A hexadecimal color code is a string scalar or character vector that starts with a hash symbol (#) followed by three or six hexadecimal digits, which can range from 0 to F. The values are not case sensitive. Therefore, the color codes "#FF8800", "#ff8800", "#F80", and "#f80" are equivalent.

Alternatively, you can specify some common colors by name. This table lists the named color options, the equivalent RGB triplets, and hexadecimal color codes.

Color Name	Short Name	RGB Triplet	Hexadecimal Color Code	Appearance
"red"	"r"	[1 0 0]	"#FF0000"	
"green"	"g"	[0 1 0]	"#00FF00"	
"blue"	"b"	[0 0 1]	"#0000FF"	
"cyan"	"c"	[0 1 1]	"#00FFFF"	
"magenta"	"m"	[1 0 1]	"#FF00FF"	
"yellow"	"y"	[1 1 0]	"#FFFF00"	
"black"	"k"	[0 0 0]	"#000000"	
"white"	"w"	[1 1 1]	"#FFFFFF"	
"none"	Not applicable	Not applicable	Not applicable	No color

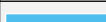
Here are the RGB triplets and hexadecimal color codes for the default colors MATLAB uses in many types of plots.

RGB Triplet	Hexadecimal Color Code	Appearance
[0 0.4470 0.7410]	"#0072BD"	
[0.8500 0.3250 0.0980]	"#D95319"	
[0.9290 0.6940 0.1250]	"#EDB120"	
[0.4940 0.1840 0.5560]	"#7E2F8E"	
[0.4660 0.6740 0.1880]	"#77AC30"	
[0.3010 0.7450 0.9330]	"#4DBEEE"	
[0.6350 0.0780 0.1840]	"#A2142F"	

FontSize – Font size for labeling tracks

10 points (default) | positive integer

Font size for labeling tracks, specified as the comma-separated pair consisting of 'FontSize' and a positive integer in font points.

LabelOffset — Gap between label and positional point

[0 0] (default) | real-valued vector of the form [x y]

Gap between label and positional point, specified as the comma-separated pair consisting of 'LabelOffset' and a real-valued vector of the form [x y]. Units are in meters.

VelocityScaling — Scale factor for magnitude length of velocity vectors

1 (default) | positive real scalar

Scale factor for magnitude length of velocity vectors, specified as the comma-separated pair consisting of 'VelocityScaling' and a positive real scalar. The bird's-eye plot renders the magnitude vector value as $M \times \text{VelocityScaling}$, where M is the magnitude of velocity.

Tag — Tag associated with plotter object

'PlotterN' (default) | character vector | string scalar

Tag associated with the plotter object, specified as the comma-separated pair consisting of 'Tag' and a character vector or string scalar. The default value is 'PlotterN', where N is an integer that corresponds to the N th plotter associated with the input birdsEyePlot object.

Output Arguments**tPlotter — Track plotter**

TrackPlotter object

Track plotter, returned as a TrackPlotter object. You can modify this object by changing its property values. The property names correspond to the name-value pair arguments of the trackPlotter function.

tPlotter is stored in the Plotters property of the input birdsEyePlot object, bep. To plot the tracks, use the plotTrack function.

Version History

Introduced in R2017a

See Also

birdsEyePlot | plotTrack | findPlotter | clearData | clearPlotterData

birdsEyeView

Create bird's-eye view using inverse perspective mapping

Description

Use the `birdsEyeView` object to create a bird's-eye view of a 2-D scene using inverse perspective mapping. To transform an image into a bird's-eye view, pass a `birdsEyeView` object and that image to the `transformImage` function. To convert the bird's-eye-view image coordinates to or from vehicle coordinates, use the `imageToVehicle` and `vehicleToImage` functions. All of these functions assume that the input image does not have lens distortion. To remove lens distortion, use the `undistortImage` function.

Creation

Syntax

```
birdsEye = birdsEyeView(sensor,outView,outImageSize)
```

Description

`birdsEye = birdsEyeView(sensor,outView,outImageSize)` creates a `birdsEyeView` object for transforming an image to a bird's-eye-view.

- `sensor` is a `monoCamera` object that defines the configuration of the camera sensor. This input sets the `Sensor` property.
- `outView` defines the portion of the camera view, in vehicle coordinates, that is transformed into a bird's-eye view. This input sets the `OutputView` property.
- `outImageSize` defines the size, in pixels, of the output bird's-eye-view image. This input sets the `ImageSize` property.

Properties

Sensor — Camera sensor configuration

`monoCamera` object

Camera sensor configuration, specified as a `monoCamera` object. The object contains the intrinsic camera parameters, the mounting height, and the camera mounting angles. This configuration defines the vehicle coordinate system of the `birdsEyeView` object. For more details, see “Vehicle Coordinate System” on page 4-169.

OutputView — Coordinates of region to transform

four-element vector of form `[xmin xmax ymin ymax]`

Coordinates of the region to transform into a bird's-eye-view image, specified as a four-element vector of the form `[xmin xmax ymin ymax]`. The units are in world coordinates, such as meters or feet, as determined by the `Sensor` property. The four coordinates define the output space in the (X, Y) coordinate system, with the origin centered on the location of the camera sensor.

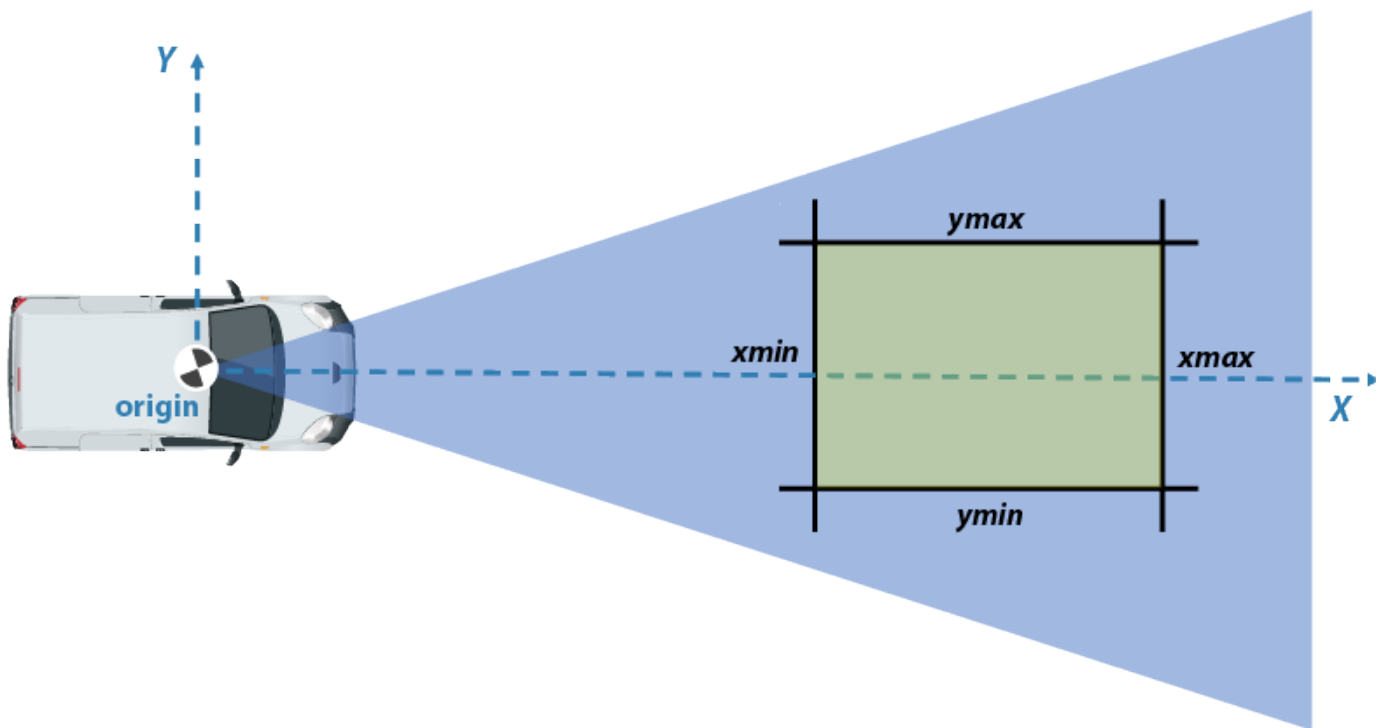

You can set this property when you create the object. After you create the object, this property is read-only.

ImageSize — Size of output bird's-eye-view images

two-element vector

Size of output bird's-eye-view images, in pixels, specified as a two-element vector of the form $[m \ n]$, where m and n specify the number of rows and columns of pixels for the output image, respectively. If you specify a value for one dimension, you can set the other dimension to NaN and `birdsEyeView` calculates this value automatically. Setting one dimension to NaN maintains the same pixel to world-unit ratio along the X_V -axis and Y_V -axis.

You can set this property when you create the object. After you create the object, this property is read-only.

Object Functions

<code>transformImage</code>	Transform image to bird's-eye view
<code>imageToVehicle</code>	Convert bird's-eye-view image coordinates to vehicle coordinates
<code>vehicleToImage</code>	Convert vehicle coordinates to bird's-eye-view image coordinates

Examples

Transform Road Image to Bird's-Eye-View Image

Create a bird's-eye-view image from an image obtained by a front-facing camera mounted on a vehicle. Display points within the bird's-eye view using the vehicle and image coordinate systems.

Define the camera intrinsics and create an object containing these intrinsics.

```
focalLength = [309.4362 344.2161];  
principalPoint = [318.9034 257.5352];  
imageSize = [480 640];
```

```
camIntrinsics = cameraIntrinsics(focalLength,principalPoint,imageSize);
```

Set the height of the camera to be about 2 meters above the ground. Set the pitch of the camera to 14 degrees toward the ground.

```
height = 2.1798;  
pitch = 14;
```

Create an object containing the camera configuration.

```
sensor = monoCamera(camIntrinsics,height,'Pitch',pitch);
```

Define the area in front of the camera that you want to transform into a bird's-eye view. Set an area from 3 to 30 meters in front of the camera, with 6 meters to either side of the camera.

```
distAhead = 30;  
spaceToOneSide = 6;  
bottomOffset = 3;
```

```
outView = [bottomOffset,distAhead,-spaceToOneSide,spaceToOneSide];
```

Set the output image width to 250 pixels. Compute the output length automatically from the width by setting the length to NaN.

```
outImageSize = [NaN,250];
```

Create an object for performing bird's-eye-view transforms, using the previously defined parameters.

```
birdsEye = birdsEyeView(sensor,outView,outImageSize);
```

Load an image that was captured by the sensor.

```
I = imread('road.png');  
figure  
imshow(I)  
title('Original Image')
```

Original Image



Transform the input image into a bird's-eye-view image.

```
BEV = transformImage(birdsEye,I);
```

In the bird's-eye-view image, place a 20-meter marker directly in front of the sensor. Use the `vehicleToImage` function to specify the location of the marker in vehicle coordinates. Display the marker on the bird's-eye-view image.

```
imagePoint = vehicleToImage(birdsEye,[20 0]);  
annotatedBEV = insertMarker(BEV,imagePoint);  
annotatedBEV = insertText(annotatedBEV,imagePoint + 5,'20 meters');
```

```
figure  
imshow(annotatedBEV)  
title('Bird's-Eye-View Image: vehicleToImage')
```

Bird's-Eye-View Image: vehicleToImage

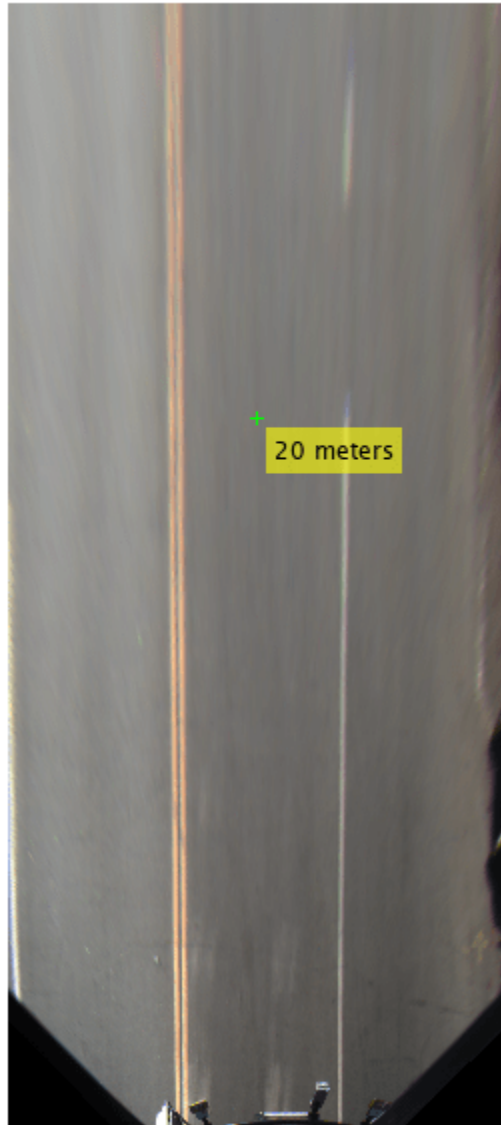

Define a location in the original bird's-eye-view image, this time in image coordinates. Use the `imageToVehicle` function to convert the image coordinates to vehicle coordinates. Display the distance between the marker and the front of the vehicle.

```
imagePoint2 = [120 400];  
annotatedBEV = insertMarker(BEV,imagePoint2);  
  
vehiclePoint = imageToVehicle(birdsEye,imagePoint2);  
xAhead = vehiclePoint(1);  
displayText = sprintf('%.2f meters',xAhead);  
annotatedBEV = insertText(annotatedBEV,imagePoint2 + 5,displayText);
```

```
figure
imshow(annotatedBEV)
title('Bird''s-Eye-View Image: imageToVehicle')
```

Bird's-Eye-View Image: imageToVehicle

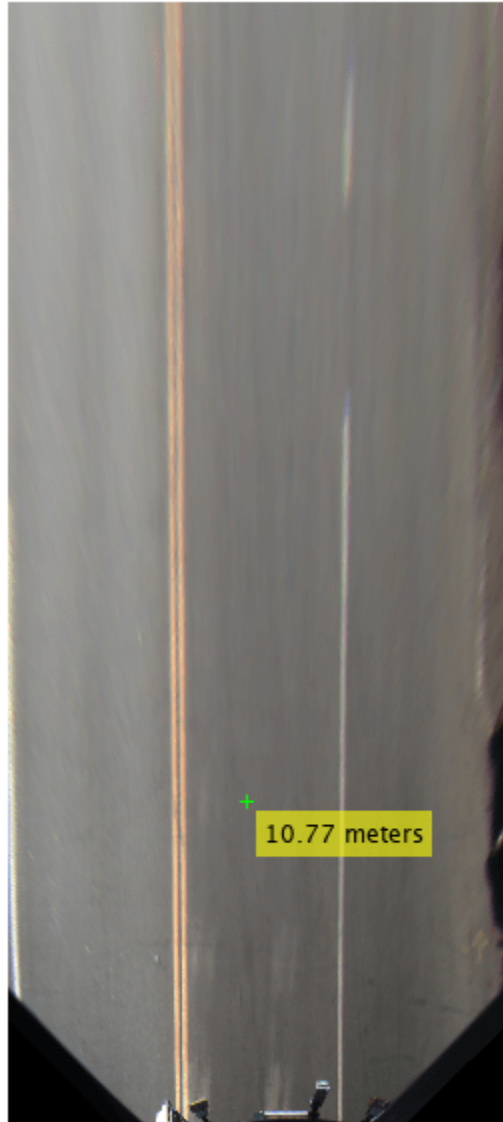

More About

Vehicle Coordinate System

In the vehicle coordinate system (X_V , Y_V , Z_V) defined by the input `monoCamera` object:

- The X_V -axis points forward from the vehicle.
- The Y_V -axis points to the left, as viewed when facing forward.
- The Z_V -axis points up from the ground to maintain the right-handed coordinate system.

The default origin of this coordinate system is on the road surface, directly below the camera center. The focal point of the camera defines this center point.

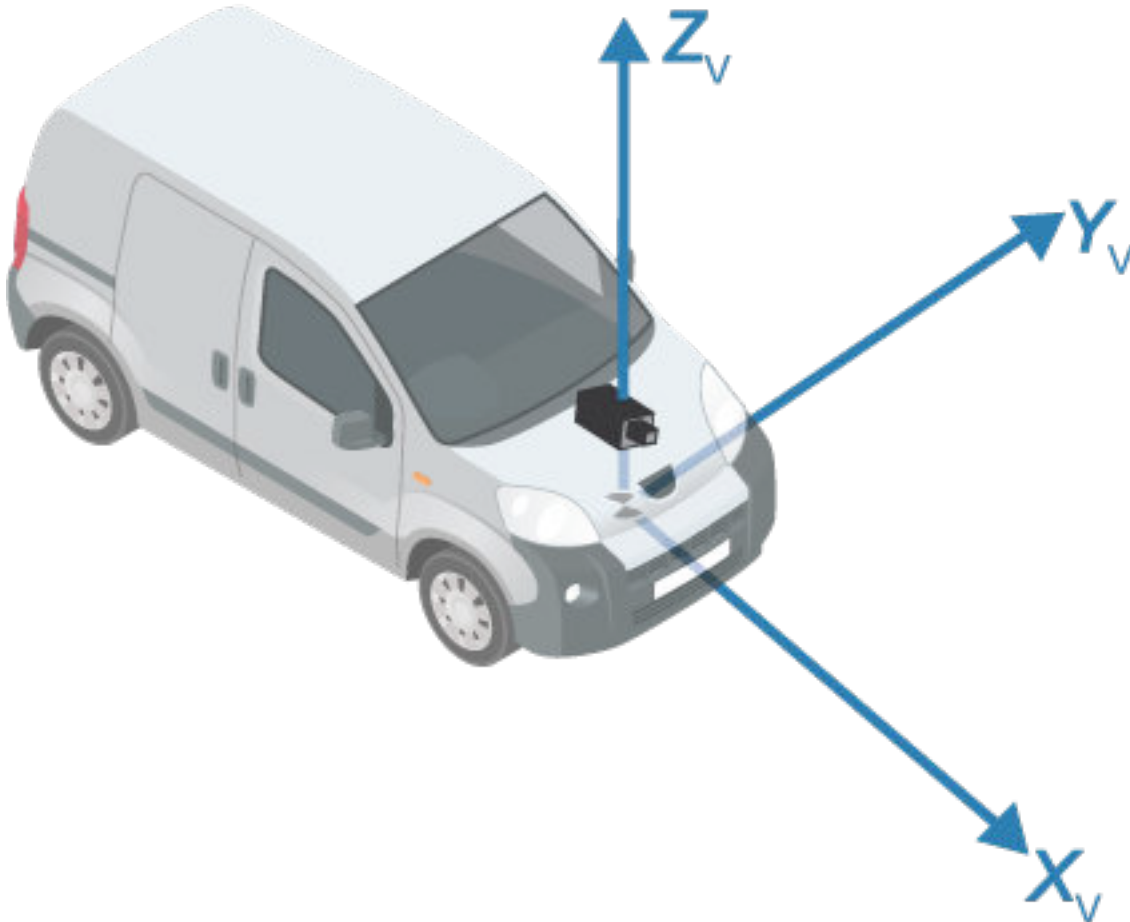

To change the placement of the origin within the vehicle coordinate system, update the `SensorLocation` property of the input `monoCamera` object.

For more details about the vehicle coordinate system, see “Coordinate Systems in Automated Driving Toolbox”.

Version History

Introduced in R2017a

Extended Capabilities

C/C++ Code Generation

Generate C and C++ code using MATLAB® Coder™.

See Also

Functions

monoCamera

Topics

“Create 360° Bird's-Eye-View Image Around a Vehicle”

“Perception-Based Parking Spot Detection Using Unreal Engine Simulation”

“Coordinate Systems in Automated Driving Toolbox”

imageToVehicle

Convert bird's-eye-view image coordinates to vehicle coordinates

Syntax

```
vehiclePoints = imageToVehicle(birdsEye,imagePoints)
```

Description

`vehiclePoints = imageToVehicle(birdsEye,imagePoints)` converts bird's-eye-view image coordinates to [x y] vehicle coordinates.

Examples

Transform Road Image to Bird's-Eye-View Image

Create a bird's-eye-view image from an image obtained by a front-facing camera mounted on a vehicle. Display points within the bird's-eye view using the vehicle and image coordinate systems.

Define the camera intrinsics and create an object containing these intrinsics.

```
focalLength = [309.4362 344.2161];  
principalPoint = [318.9034 257.5352];  
imageSize = [480 640];
```

```
camIntrinsics = cameraIntrinsics(focalLength,principalPoint,imageSize);
```

Set the height of the camera to be about 2 meters above the ground. Set the pitch of the camera to 14 degrees toward the ground.

```
height = 2.1798;  
pitch = 14;
```

Create an object containing the camera configuration.

```
sensor = monoCamera(camIntrinsics,height,'Pitch',pitch);
```

Define the area in front of the camera that you want to transform into a bird's-eye view. Set an area from 3 to 30 meters in front of the camera, with 6 meters to either side of the camera.

```
distAhead = 30;  
spaceToOneSide = 6;  
bottomOffset = 3;
```

```
outView = [bottomOffset,distAhead,-spaceToOneSide,spaceToOneSide];
```

Set the output image width to 250 pixels. Compute the output length automatically from the width by setting the length to NaN.

```
outImageSize = [NaN,250];
```

Create an object for performing bird's-eye-view transforms, using the previously defined parameters.

```
birdsEye = birdsEyeView(sensor,outView,outImageSize);
```

Load an image that was captured by the sensor.

```
I = imread('road.png');
figure
imshow(I)
title('Original Image')
```

Original Image



Transform the input image into a bird's-eye-view image.

```
BEV = transformImage(birdsEye,I);
```

In the bird's-eye-view image, place a 20-meter marker directly in front of the sensor. Use the `vehicleToImage` function to specify the location of the marker in vehicle coordinates. Display the marker on the bird's-eye-view image.

```
imagePoint = vehicleToImage(birdsEye,[20 0]);
annotatedBEV = insertMarker(BEV,imagePoint);
annotatedBEV = insertText(annotatedBEV,imagePoint + 5,'20 meters');
```

```
figure
imshow(annotatedBEV)
title('Bird's-Eye-View Image: vehicleToImage')
```

Bird's-Eye-View Image: vehicleToImage

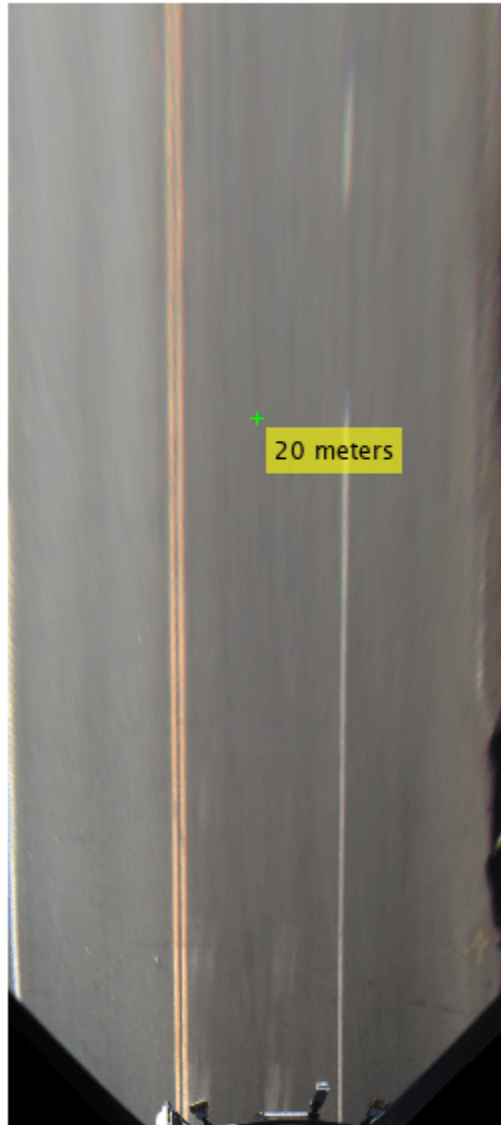

Define a location in the original bird's-eye-view image, this time in image coordinates. Use the `imageToVehicle` function to convert the image coordinates to vehicle coordinates. Display the distance between the marker and the front of the vehicle.

```
imagePoint2 = [120 400];  
annotatedBEV = insertMarker(BEV,imagePoint2);  
  
vehiclePoint = imageToVehicle(birdsEye,imagePoint2);  
xAhead = vehiclePoint(1);  
displayText = sprintf('%.2f meters',xAhead);  
annotatedBEV = insertText(annotatedBEV,imagePoint2 + 5,displayText);
```



```
figure
imshow(annotatedBEV)
title('Bird''s-Eye-View Image: imageToVehicle')
```

Bird's-Eye-View Image: imageToVehicle



Input Arguments

birdsEye — Object for transforming image to bird's-eye view

birdsEyeView object

Object for transforming image to bird's-eye view, specified as a `birdsEyeView` object.

imagePoints — Image points*M*-by-2 matrix

Image points, specified as an *M*-by-2 matrix containing *M* number of [x y] image coordinates.

Output Arguments**vehiclePoints — Vehicle points***M*-by-2 matrix

Vehicle points, returned as an *M*-by-2 matrix containing *M* number of [x y] vehicle coordinates.

Version History

Introduced in R2017a

Extended Capabilities**C/C++ Code Generation**

Generate C and C++ code using MATLAB® Coder™.

See Also**Objects**

birdsEyeView

Functions

vehicleToImage

Topics

"Coordinate Systems in Automated Driving Toolbox"

transformImage

Transform image to bird's-eye view

Syntax

```
J = transformImage(birdsEye,I)
```

Description

`J = transformImage(birdsEye,I)` transforms the input image, `I`, to a bird's-eye-view image, `J`. The `OutputView` and `ImageSize` properties of the `birdsEyeView` object, `birdsEye`, determine the portion of `I` to transform and the size of `J`, respectively.

Examples

Transform Road Image to Bird's-Eye-View Image

Create a bird's-eye-view image from an image obtained by a front-facing camera mounted on a vehicle. Display points within the bird's-eye view using the vehicle and image coordinate systems.

Define the camera intrinsics and create an object containing these intrinsics.

```
focalLength = [309.4362 344.2161];
principalPoint = [318.9034 257.5352];
imageSize = [480 640];
```

```
camIntrinsics = cameraIntrinsics(focalLength,principalPoint,imageSize);
```

Set the height of the camera to be about 2 meters above the ground. Set the pitch of the camera to 14 degrees toward the ground.

```
height = 2.1798;
pitch = 14;
```

Create an object containing the camera configuration.

```
sensor = monoCamera(camIntrinsics,height,'Pitch',pitch);
```

Define the area in front of the camera that you want to transform into a bird's-eye view. Set an area from 3 to 30 meters in front of the camera, with 6 meters to either side of the camera.

```
distAhead = 30;
spaceToOneSide = 6;
bottomOffset = 3;
```

```
outView = [bottomOffset,distAhead,-spaceToOneSide,spaceToOneSide];
```

Set the output image width to 250 pixels. Compute the output length automatically from the width by setting the length to `NaN`.

```
outImageSize = [NaN,250];
```

Create an object for performing bird's-eye-view transforms, using the previously defined parameters.

```
birdsEye = birdsEyeView(sensor,outView,outImageSize);
```

Load an image that was captured by the sensor.

```
I = imread('road.png');  
figure  
imshow(I)  
title('Original Image')
```



Transform the input image into a bird's-eye-view image.

```
BEV = transformImage(birdsEye,I);
```

In the bird's-eye-view image, place a 20-meter marker directly in front of the sensor. Use the `vehicleToImage` function to specify the location of the marker in vehicle coordinates. Display the marker on the bird's-eye-view image.

```
imagePoint = vehicleToImage(birdsEye,[20 0]);  
annotatedBEV = insertMarker(BEV,imagePoint);  
annotatedBEV = insertText(annotatedBEV,imagePoint + 5,'20 meters');
```

```
figure
```

```
imshow(annotatedBEV)  
title('Bird's-Eye-View Image: vehicleToImage')
```

Bird's-Eye-View Image: vehicleToImage

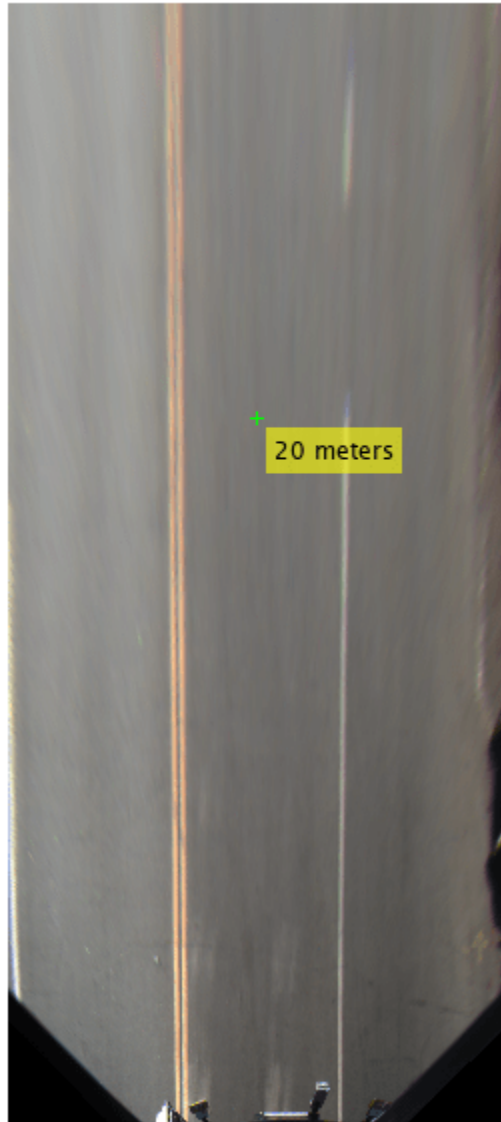

Define a location in the original bird's-eye-view image, this time in image coordinates. Use the `imageToVehicle` function to convert the image coordinates to vehicle coordinates. Display the distance between the marker and the front of the vehicle.

```
imagePoint2 = [120 400];  
annotatedBEV = insertMarker(BEV,imagePoint2);  
  
vehiclePoint = imageToVehicle(birdsEye,imagePoint2);  
xAhead = vehiclePoint(1);
```

```
displayText = sprintf('%.2f meters',xAhead);  
annotatedBEV = insertText(annotatedBEV,imagePoint2 + 5,displayText);  
  
figure  
imshow(annotatedBEV)  
title('Bird''s-Eye-View Image: imageToVehicle')
```

Bird's-Eye-View Image: imageToVehicle



Input Arguments

birdsEye — Object for transforming image to bird's-eye view

birdsEyeView object

Object for transforming image to bird's-eye view, specified as a `birdsEyeView` object.

I — Input image

truecolor image | grayscale image

Input image, specified as a truecolor or grayscale image. The `OutputView` property of `birdsEye` determines the portion of `I` to transform to a bird's-eye view.

`I` must not contain lens distortion. You can remove lens distortion by using the `undistortImage` function. In high-end optics, you can ignore distortion.

Output Arguments

J — Bird's-eye-view image

truecolor image | grayscale image

Bird's-eye-view image, returned as a truecolor or grayscale image. The `ImageSize` property of `birdsEye` determines the size of `J`.

Version History

Introduced in R2017a

Extended Capabilities

C/C++ Code Generation

Generate C and C++ code using MATLAB® Coder™.

See Also

Objects

`birdsEyeView`

Functions

`imageToVehicle` | `vehicleToImage`

vehicleToImage

Convert vehicle coordinates to bird's-eye-view image coordinates

Syntax

```
imagePoints = vehicleToImage(birdsEye,vehiclePoints)
```

Description

`imagePoints = vehicleToImage(birdsEye,vehiclePoints)` converts vehicle coordinates to [x y] bird's-eye-view image coordinates.

Examples

Transform Road Image to Bird's-Eye-View Image

Create a bird's-eye-view image from an image obtained by a front-facing camera mounted on a vehicle. Display points within the bird's-eye view using the vehicle and image coordinate systems.

Define the camera intrinsics and create an object containing these intrinsics.

```
focalLength = [309.4362 344.2161];  
principalPoint = [318.9034 257.5352];  
imageSize = [480 640];
```

```
camIntrinsics = cameraIntrinsics(focalLength,principalPoint,imageSize);
```

Set the height of the camera to be about 2 meters above the ground. Set the pitch of the camera to 14 degrees toward the ground.

```
height = 2.1798;  
pitch = 14;
```

Create an object containing the camera configuration.

```
sensor = monoCamera(camIntrinsics,height,'Pitch',pitch);
```

Define the area in front of the camera that you want to transform into a bird's-eye view. Set an area from 3 to 30 meters in front of the camera, with 6 meters to either side of the camera.

```
distAhead = 30;  
spaceToOneSide = 6;  
bottomOffset = 3;
```

```
outView = [bottomOffset,distAhead,-spaceToOneSide,spaceToOneSide];
```

Set the output image width to 250 pixels. Compute the output length automatically from the width by setting the length to NaN.

```
outImageSize = [NaN,250];
```

Create an object for performing bird's-eye-view transforms, using the previously defined parameters.

```
birdsEye = birdsEyeView(sensor,outView,outImageSize);
```

Load an image that was captured by the sensor.

```
I = imread('road.png');
figure
imshow(I)
title('Original Image')
```

Original Image



Transform the input image into a bird's-eye-view image.

```
BEV = transformImage(birdsEye,I);
```

In the bird's-eye-view image, place a 20-meter marker directly in front of the sensor. Use the `vehicleToImage` function to specify the location of the marker in vehicle coordinates. Display the marker on the bird's-eye-view image.

```
imagePoint = vehicleToImage(birdsEye,[20 0]);
annotatedBEV = insertMarker(BEV,imagePoint);
annotatedBEV = insertText(annotatedBEV,imagePoint + 5,'20 meters');
```

```
figure
imshow(annotatedBEV)
title('Bird's-Eye-View Image: vehicleToImage')
```

Bird's-Eye-View Image: vehicleToImage

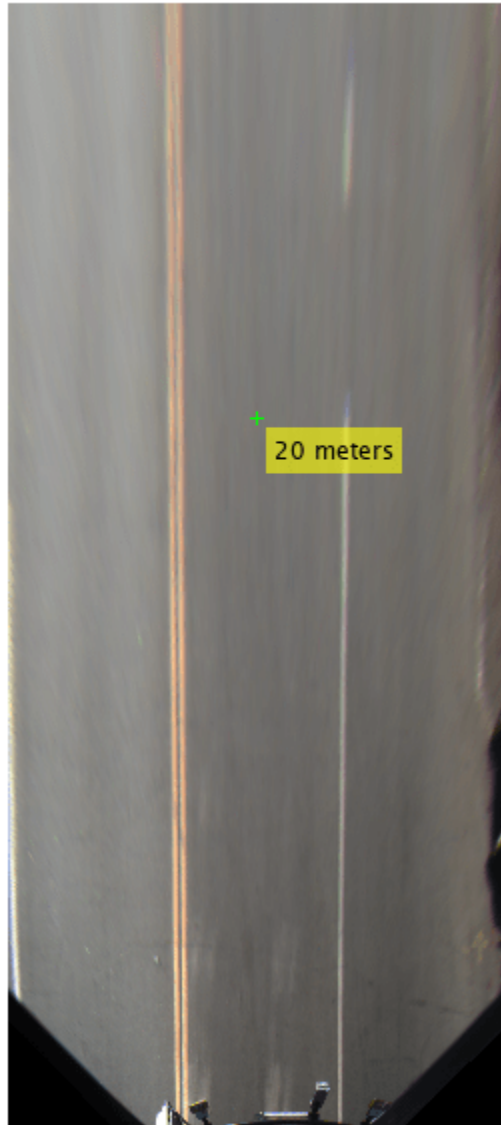

Define a location in the original bird's-eye-view image, this time in image coordinates. Use the `imageToVehicle` function to convert the image coordinates to vehicle coordinates. Display the distance between the marker and the front of the vehicle.

```
imagePoint2 = [120 400];  
annotatedBEV = insertMarker(BEV,imagePoint2);  
  
vehiclePoint = imageToVehicle(birdsEye,imagePoint2);  
xAhead = vehiclePoint(1);  
displayText = sprintf('%.2f meters',xAhead);  
annotatedBEV = insertText(annotatedBEV,imagePoint2 + 5,displayText);
```

```
figure
imshow(annotatedBEV)
title('Bird''s-Eye-View Image: imageToVehicle')
```

Bird's-Eye-View Image: imageToVehicle

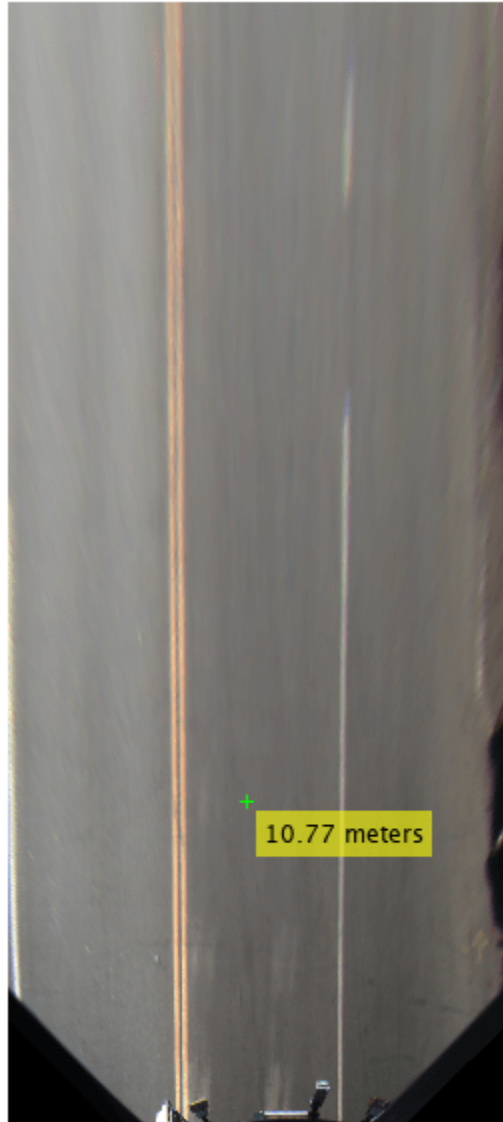

Input Arguments

birdsEye — Object for transforming image to bird's-eye view

birdsEyeView object

Object for transforming image to bird's-eye view, specified as a `birdsEyeView` object.

vehiclePoints — Vehicle points*M*-by-2 matrix

Vehicle points, specified as an *M*-by-2 matrix containing *M* number of [*x* *y*] vehicle coordinates.

Output Arguments**imagePoints — Image points***M*-by-2 matrix

Image points, returned as an *M*-by-2 matrix containing *M* number of [*x* *y*] image coordinates.

Version History

Introduced in R2017a

Extended Capabilities**C/C++ Code Generation**

Generate C and C++ code using MATLAB® Coder™.

See Also**Objects**

birdsEyeView

Functions

imageToVehicle

Topics

"Coordinate Systems in Automated Driving Toolbox"

driving.connector.Connector class

Package: driving.connector

Interface to connect external tool to Ground Truth Labeler app

Description

The `driving.connector.Connector` class creates an interface between a custom visualization or analysis tool and a signal in the **Ground Truth Labeler** app. You can use the connector with video and image sequence signals only.

The `driving.connector.Connector` class is a `handle` class.

Creation

The `Connector` class that is inherited from the `Connector` interface is called a client.

The client can:

- Sync an external tool to each frame change event for a specific signal loaded into the **Ground Truth Labeler**. Syncing allows you to control the external tool through the range slider and playback controls of the app.
- Control the current time in the external tool and the corresponding display in the app.
- Export custom labeled data from an external tool via the app.

To connect an external tool to the **Ground Truth Labeler** app, follow these steps:

- 1 Define a client class that inherits from `driving.connector.Connector`. You can use the `Connector` class template to define a class and implement your custom visualization or analysis tool. At the MATLAB command prompt, enter:

```
driving.connector.Connector.openTemplateInEditor
```

Follow the steps found in the template.

- 2 Save the file to any folder on the MATLAB path. Alternatively, save the file to a folder and add the folder to MATLAB path by using the `addpath` function.

Properties

VideoStartTime — Start time of signal

real scalar in seconds

Start time of the signal, specified as a real scalar in seconds.

Attributes:

GetAccess	public
SetAccess	private

VideoEndTime — End time of signal

real scalar in seconds

End time of the signal, specified as a real scalar in seconds.

Attributes:

GetAccess	public
SetAccess	private

StartTime — Start of time interval in app

real scalar in seconds

Start of the time interval in the app, specified as a real scalar in seconds. To set the start time, use the start flag interval in the app.

Attributes:

GetAccess	public
SetAccess	private

CurrentTime — Time of frame currently displaying in app

real scalar in seconds

Time of the frame currently displaying in the app for the connected signal, specified as a real scalar in seconds. If the slider is between two timestamps, then the currently displaying frame is the frame that is at the previous timestamp. For more details, see “Control Playback of Signal Frames for Labeling”.

Attributes:

GetAccess	public
SetAccess	private

EndTime — End of time interval in app

real scalar in seconds

End of the time interval in the app, specified as a real scalar in seconds. To set the end time, use the end flag interval in the app.

Attributes:

GetAccess	public
SetAccess	private

TimeVector — Timestamps for connected signal

duration vector

Timestamps for the connected signal, specified as a duration vector. This signal must be the main signal. If you change the main signal, the TimeVector property updates to the timestamps for new main signal.

Attributes:

GetAccess	public
SetAccess	private

LabelData — Label data imported from external tool

two-column table

Label data imported from the external tool, specified as a two-column table. The first column contains the timestamps of the connected signal and the second column contains the label information that you specify for the corresponding timestamp.

- The first column contains the timestamps for that signal
- The second column contains the label information that you specify for the corresponding timestamp.

Attributes:

GetAccess	public
SetAccess	private

LabelName — Names of labels

character vector | string scalar | cell array of character vectors | string array

Names of labels, specified as a character vector, a string scalar, a cell array of character vectors, or a string array. These names must be valid MATLAB variables that correspond to the label names specified in the second column of `LabelData`.

Attributes:

GetAccess	public
SetAccess	public
Dependent	true

LabelDescription — Descriptions of labels

' ' (default) | character vector | string scalar | cell array of character vectors | string array

Descriptions of labels, specified as a character vector, a string scalar, a cell array of character vectors, or a string array. Each description of `LabelDescription` corresponds to a label specified in `LabelName`.

Attributes:

GetAccess	public
SetAccess	public

Methods**Public Methods**

<code>frameChangeListener</code>	Update external tool when new frame is displayed in Ground Truth Labeler app
<code>labelDefinitionLoadListener</code>	Update external tool for new label definitions in Ground Truth Labeler app
<code>labelLoadListener</code>	Update external tool for new label data in Ground Truth Labeler app
<code>addLabelData</code>	Add custom label data at current time
<code>queryLabelData</code>	Query for custom label data at current time
<code>updateLabelerCurrentTime</code>	Update current time in Ground Truth Labeler app
<code>close</code>	Close external tool connected to Ground Truth Labeler app
<code>disconnect</code>	Disconnect external tool from Ground Truth Labeler app

`dataSourceChangeListener` Update external tool when connecting to signal being loaded into Ground Truth Labeler app

Examples

Connect Lidar Display to Ground Truth Labeler

Connect a lidar display tool to the **Ground Truth Labeler** app. Use the app and tool to display synchronized lidar and video data.

Specify the name of a video signal to load into the app.

```
signalName = '01_city_c2s_fcw_10s.mp4';
```

Add the path to the function handle for the lidar display tool.

```
path = fullfile(toolboxdir('driving'),'drivingdemos');
addpath(path)
```

Connect the lidar display to the app.

```
groundTruthLabeler(signalName,'ConnectorTargetHandle',@LidarDisplay);
```

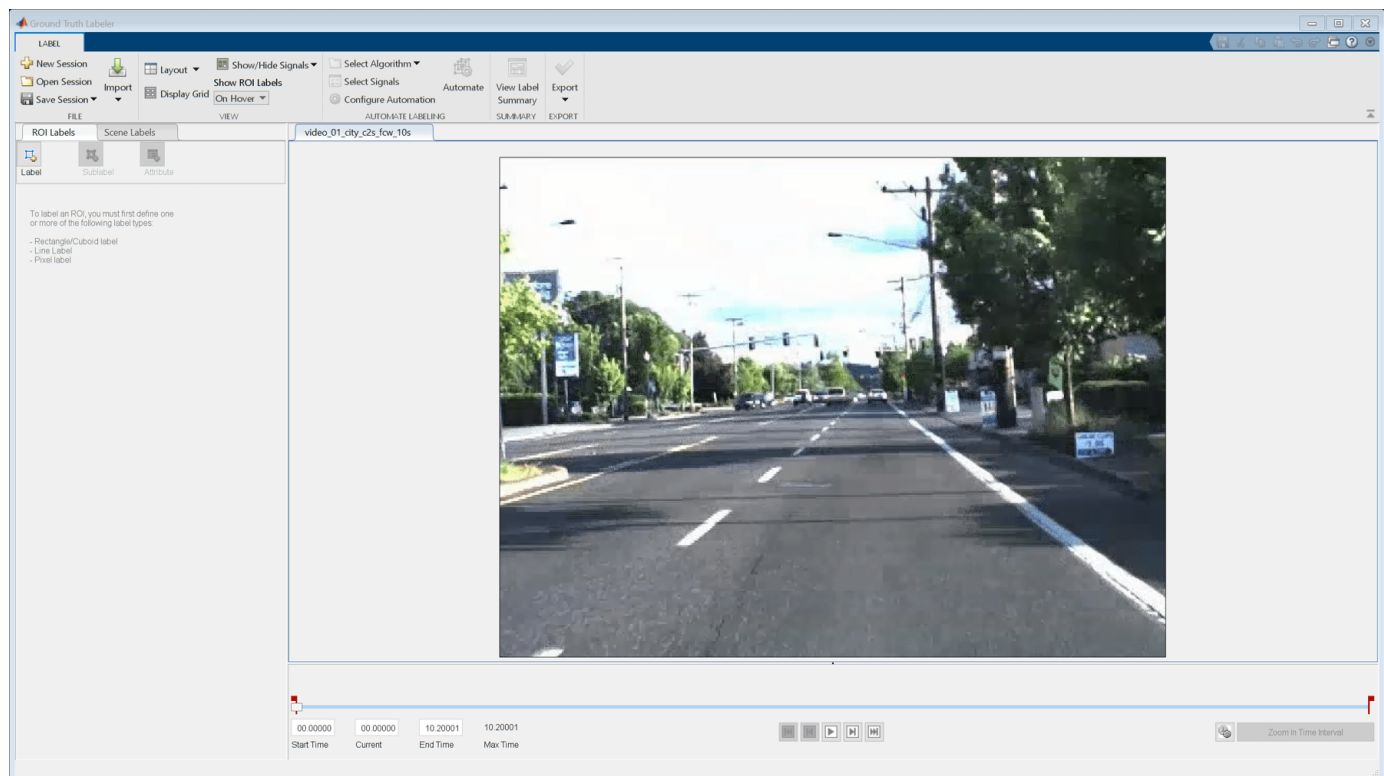

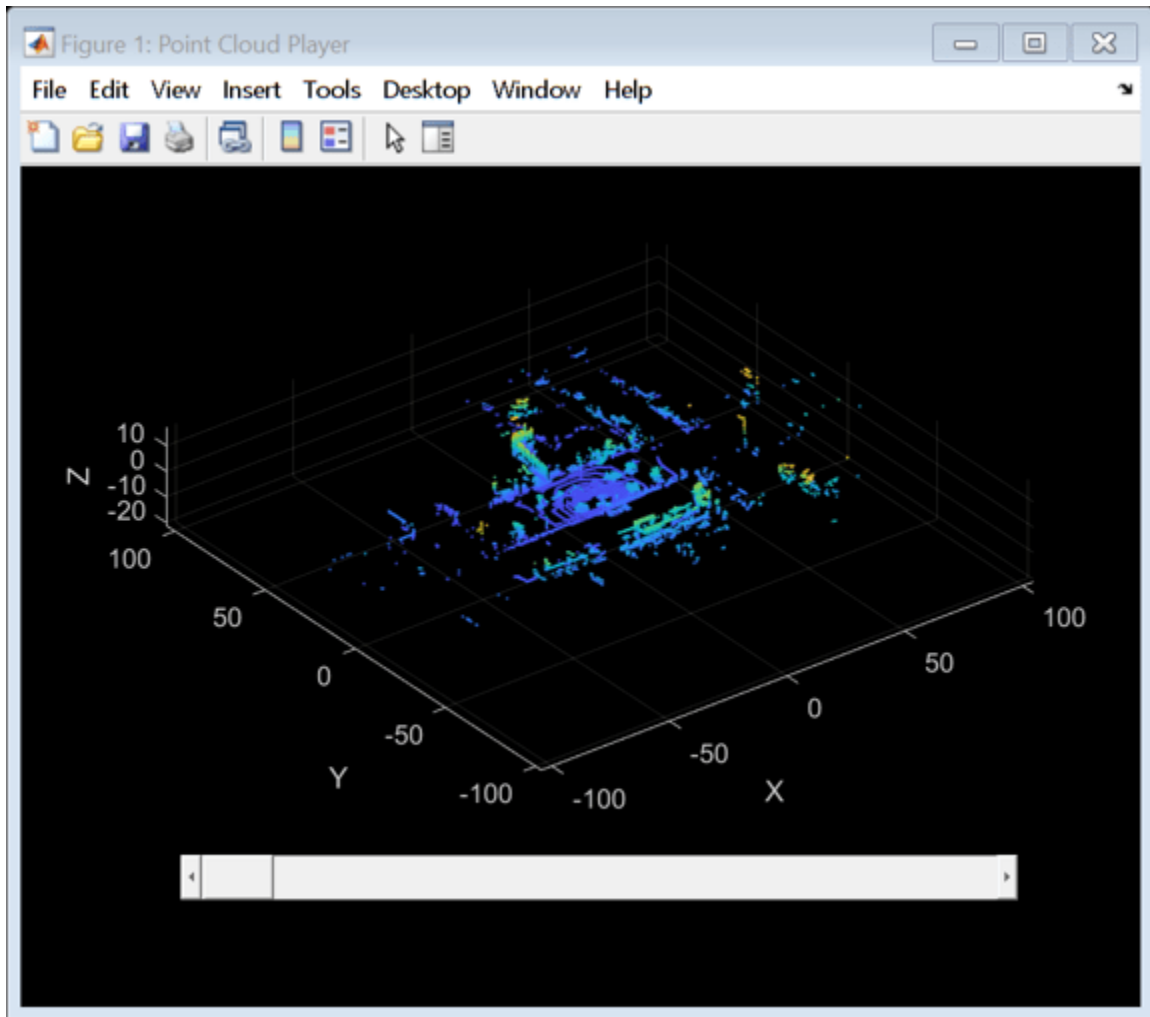

After the app loads the video and lidar display tool, remove the path to the function handle.

```
rmpath(path)
```

Tips

- For an example of an external tool, see this `driving.connector.Connector` class implementation. This class implements a lidar visualization tool. You can use this code as a starting point for creating your own tools.

```
edit LidarDisplay
```

- To keep an external tool synchronized with the app, specify timestamps that are at the same frame rate as the signals loaded in the app. If the tool visualizes data at a timestamp that is between two frames, then the app displays the frame that is at the previous timestamp. For more details, see “Control Playback of Signal Frames for Labeling”.

Version History

Introduced in R2017a

See Also

Apps
Ground Truth Labeler

addLabelData

Class: `driving.connector.Connector`

Package: `driving.connector`

Add custom label data at current time

Syntax

```
addLabelData(connectorObj, labelData)
```

Description

`addLabelData(connectorObj, labelData)` adds the custom label data related to the current time that is shown in the **Ground Truth Labeler** app. The client calls this method using the `connectorObj` object.

Note The client class can call this method.

Input Arguments

connectorObj — Connector object

`driving.connector.Connector` object

Connector object, specified as a `driving.connector.Connector` object.

labelData — Label data

cell array of character vectors | string array

Label data, specified as a cell array of character vectors or as a string array. Each element of `labelData` must correspond to a label stored in the `labelData` property of the input `driving.connector.Connector` object, `connectorObj`. The app appends label data only to the signal to which the external tool is connected.

Version History

Introduced in R2017a

See Also

Ground Truth Labeler | `driving.connector.Connector`

close

Class: `driving.connector.Connector`

Package: `driving.connector`

Close external tool connected to Ground Truth Labeler app

Syntax

```
close(connectorObj)
```

Description

`close(connectorObj)` provides the option to close the external tool that is connected to the **Ground Truth Labeler** app when the app closes. The app calls this method using the `connectorObj` object.

Note The client class can optionally implement this method.

Input Arguments

connectorObj — **Connector object**

`driving.connector.Connector` object

Connector object, specified as a `driving.connector.Connector` object.

Version History

Introduced in R2017a

See Also

`driving.connector.Connector` | **Ground Truth Labeler**

dataSourceChangeListener

Class: `driving.connector.Connector`

Package: `driving.connector`

Update external tool when connecting to signal being loaded into Ground Truth Labeler app

Syntax

```
dataSourceChangeListener(connectorObj)
```

Description

`dataSourceChangeListener(connectorObj)` provides the option to update the external tool when a new data source is loaded into the **Ground Truth Labeler** app. The app calls this method using the `connectorObj` object.

You can optionally use this method to react to when the tool connects to a signal that is being loaded into the app.

Note The client class can optionally implement this method.

Input Arguments

connectorObj — **Connector object**

`driving.connector.Connector` object

Connector object, specified as a `driving.connector.Connector` object.

Version History

Introduced in R2017a

See Also

`driving.connector.Connector` | **Ground Truth Labeler**

disconnect

Class: `driving.connector.Connector`

Package: `driving.connector`

Disconnect external tool from Ground Truth Labeler app

Syntax

```
disconnect(connectorObj)
```

Description

`disconnect(connectorObj)` disconnects the interface between an external tool and the **Ground Truth Labeler** app. The client calls this method using the `connectorObj` object. After the external tool is disconnected, the **Ground Truth Labeler** app no longer calls the `frameChangeListener` method in the client class.

Note The client class can call this method.

Input Arguments

connectorObj — **Connector object**

`driving.connector.Connector` object

Connector object, specified as a `driving.connector.Connector` object.

Version History

Introduced in R2017a

See Also

Ground Truth Labeler | `driving.connector.Connector`

frameChangeListener

Class: `driving.connector.Connector`

Package: `driving.connector`

Update external tool when new frame is displayed in Ground Truth Labeler app

Syntax

```
frameChangeListener(connectorObj)
```

Description

`frameChangeListener(connectorObj)` provides an option to synchronize an external tool with the frame changes in the **Ground Truth Labeler** app. The app calls this method when a new frame is displayed in the app. If the slider is between two timestamps, then the app displays the frame that is at the previous timestamp. For more details, see “Control Playback of Signal Frames for Labeling”.

Note The client class must implement this method.

Input Arguments

connectorObj — **Connector object**

`driving.connector.Connector` object

Connector object, specified as a `driving.connector.Connector` object.

Version History

Introduced in R2017a

See Also

`driving.connector.Connector` | **Ground Truth Labeler**

labelDefinitionLoadListener

Class: `driving.connector.Connector`

Package: `driving.connector`

Update external tool for new label definitions in Ground Truth Labeler app

Syntax

```
labelDefinitionLoadListener(connectorObj)
```

Description

`labelDefinitionLoadListener(connectorObj)` provides an option to update the external tool that is connected to the **Ground Truth Labeler** app when new set of label definitions is imported into the app. The app calls this method using the `connectorObj` object. You can optionally use this method to react to the event of connecting a new data source to the app.

Note The client class can optionally implement this method.

Input Arguments

connectorObj — **Connector object**

`driving.connector.Connector` object

Connector object, specified as a `driving.connector.Connector` object.

Version History

Introduced in R2017a

See Also

`driving.connector.Connector` | **Ground Truth Labeler**

labelLoadListener

Class: `driving.connector.Connector`

Package: `driving.connector`

Update external tool for new label data in Ground Truth Labeler app

Syntax

```
labelLoadListener(connectorObj)
```

Description

`labelLoadListener(connectorObj)` provides the option to update the external tool that is connected to the **Ground Truth Labeler** app when a new set of label data or new session with label data is imported into the app. The app calls this method using the `connectorObj` object. Use this method to react to the event of loading a new label data into the app.

Note The client class can optionally implement this method.

Input Arguments

connectorObj — **Connector object**

`driving.connector.Connector` object

Connector object, specified as a `driving.connector.Connector` object.

Version History

Introduced in R2017a

See Also

`driving.connector.Connector` | **Ground Truth Labeler**

queryLabelData

Class: `driving.connector.Connector`

Package: `driving.connector`

Query for custom label data at current time

Syntax

```
queryLabelData(connectorObj)
```

Description

`queryLabelData(connectorObj)` queries for label data related to the current time in the **Ground Truth Labeler** app. The client calls this method using the `connectorObj`.

Note The client class can call this method.

Input Arguments

connectorObj — **Connector object**

`driving.connector.Connector` object

Connector object, specified as a `driving.connector.Connector` object.

Version History

Introduced in R2017a

See Also

Ground Truth Labeler | `driving.connector.Connector`

updateLabelerCurrentTime

Class: `driving.connector.Connector`

Package: `driving.connector`

Update current time in Ground Truth Labeler app

Syntax

```
updateLabelerCurrentTime(connectorObj, newTime)
```

Description

`updateLabelerCurrentTime(connectorObj, newTime)` updates the current time in the **Ground Truth Labeler** app to `newTime`. The client calls this method using the `connectorObj` object.

Note The client class can call this method.

Input Arguments

connectorObj — Connector object

`driving.connector.Connector` object

Connector object, specified as a `driving.connector.Connector` object.

newTime — Current time for app

real scalar in seconds

Current time for app, specified as a real scalar in seconds. The `newTime` value sets the current time in the **Ground Truth Labeler** app.

Version History

Introduced in R2017a

See Also

Ground Truth Labeler | `driving.connector.Connector`

drivingRadarDataGenerator

Generate radar sensor detections and tracks from driving scenario

Description

The `drivingRadarDataGenerator` System object generates detection or track reports of targets from an automotive radar sensor model. Use this object to generate sensor data from a driving scenario containing actors and trajectories, which you can create by using a `drivingScenario` object. When creating scenarios using the **Driving Scenario Designer** app, the radar sensors mounted on the ego vehicle are output as `drivingRadarDataGenerator` objects.

The `drivingRadarDataGenerator` object can simulate clustered or unclustered detections with added random noise and also generate false alarm detections. You can fuse the generated detections with other sensor data and track objects using a `multiObjectTracker` object. You can also output tracks directly from the `drivingRadarDataGenerator` object. To configure whether targets are output as clustered detections, unclustered detections, or tracks, use the `TargetReportFormat` property.

To generate radar detection or track reports:

- 1 Create the `drivingRadarDataGenerator` object and set its properties.
- 2 Call the object with arguments, as if it were a function.

To learn more about how System objects work, see [What Are System Objects?](#)

Creation

Syntax

```
rdr = drivingRadarDataGenerator
rdr = drivingRadarDataGenerator(id)
rdr = drivingRadarDataGenerator( ___,Name,Value)
```

Description

`rdr = drivingRadarDataGenerator` creates a radar sensor that reports clustered detections and uses default property values.

`rdr = drivingRadarDataGenerator(id)` sets the `SensorIndex` property to `id`.

`rdr = drivingRadarDataGenerator(___,Name,Value)` sets properties on page 4-203 using one or more name-value pairs. Enclose each property name in quotes. For example, `drivingRadarDataGenerator('TargetReportFormat','Tracks','FilterInitializationFcn',@initcvkf)` creates a radar sensor that generates track reports by using a tracker that is initialized by a constant-velocity linear Kalman filter.

Properties

Unless otherwise indicated, properties are *nontunable*, which means you cannot change their values after calling the object. Objects lock when you call them, and the `release` function unlocks them.

If a property is *tunable*, you can change its value at any time.

For more information on changing property values, see System Design in MATLAB Using System Objects.

Sensor Identification

SensorIndex — Unique sensor identifier

0 (default) | positive integer

Unique sensor identifier, specified as a positive integer. Use this property to distinguish between detections or tracks that come from different sensors in a multisensor system. Specify a unique value for each sensor. If you do not update `SensorIndex` from the default value of 0, then the radar returns an error at the start of simulation.

Data Types: double

UpdateRate — Sensor update rate (Hz)

10 (default) | positive real scalar

Sensor update rate, in hertz, specified as a positive real scalar. The reciprocal of the update rate must be an integer multiple of the simulation time interval. The radar generates new reports at intervals defined by this reciprocal value. Any sensor update requested between update intervals contains no detections or tracks.

Data Types: double

Sensor Mounting

MountingLocation — Sensor location on ego vehicle (m)

[3.4 0 0.2] (default) | 1-by-3 real-valued vector of form [x y z]

Sensor location on the ego vehicle body frame, in meters, specified as a 1-by-3 real-valued vector of the form [x y z]. This property defines the coordinates of the sensor along the x-axis, y-axis, and z-axis relative to the ego vehicle origin, where:

- The x-axis points forward from the vehicle.
- The y-axis points to the left of the vehicle.
- The z-axis points up from the ground.

The default value corresponds to a radar that is mounted at the center of the front grill of a sedan.

For more details on the ego vehicle coordinate system, see “Coordinate Systems in Automated Driving Toolbox”.

Data Types: double

MountingAngles — Mounting rotation angles of radar (deg)

[0 0 0] (default) | 1-by-3 real-valued vector of form [z_{yaw} y_{pitch} x_{roll}]

Mounting rotation angles of the radar, in degrees, specified as a 1-by-3 real-valued vector of form $[z_{\text{yaw}} \ y_{\text{pitch}} \ x_{\text{roll}}]$. This property defines the intrinsic Euler angle rotation of the sensor around the z-axis, y-axis, and x-axis with respect to the ego vehicle body frame, where:

- z_{yaw} , or yaw angle, rotates the sensor around the z-axis of the ego vehicle.
- y_{pitch} , or pitch angle, rotates the sensor around the y-axis of the ego vehicle. This rotation is relative to the sensor position that results from the z_{yaw} rotation.
- x_{roll} , or roll angle, rotates the sensor about the x-axis of the ego vehicle. This rotation is relative to the sensor position that results from the z_{yaw} and y_{pitch} rotations.

These angles are clockwise-positive when looking in the forward direction of the z-axis, y-axis, and x-axis, respectively. If you visualize sensor data from a bird's-eye view perspective, then the yaw angle is counterclockwise-positive because you are viewing the data in the negative direction of the z-axis, which points up from the ground.

For more details on this coordinate system, see “Coordinate Systems in Automated Driving Toolbox”.

Data Types: `double`

Detection Reporting

HasElevation — Enable radar to measure target elevation angles

`false` or `0` (default) | `true` or `1`

Enable the radar to measure target elevation angles, specified as a logical `0` (`false`) or `1` (`true`). Set this property to `true` to model a radar sensor that can estimate target elevation.

Data Types: `logical`

HasRangeRate — Enable radar to measure target range rates

`true` or `1` (default) | `false` or `0`

Enable the radar to measure target range rates, specified as a logical `1` (`true`) or `0` (`false`). Set this property to `true` to model a radar sensor that can measure range rates from target detections.

Data Types: `logical`

HasNoise — Enable addition of noise to radar sensor measurements

`true` or `1` (default) | `false` or `0`

Enable the addition of noise to radar sensor measurements, specified as a logical `1` (`true`) or `0` (`false`). Set this property to `true` to add noise to the radar measurements. Otherwise, the measurements have no noise. Even if you set `HasNoise` to `false`, the measurement noise covariance matrix reported in the `MeasurementNoise` property of the generated object detections output, `dets`, represents the measurement noise that is added when `HasNoise` is `true`.

Data Types: `logical`

HasFalseAlarms — Enable creating false alarm radar detections

`true` or `1` (default) | `false` or `0`

Enable creating false alarm radar measurements, specified as a logical `1` (`true`) or `0` (`false`). Set this property to `true` to report false alarms. Otherwise, the radar reports only actual detections.

Data Types: `logical`

HasOcclusion — Enable line-of-sight occlusion`true` or `1` (default) | `false` or `0`

Enable line-of-sight occlusion, specified as a logical `1` (`true`) or `0` (`false`). To generate detections only from objects for which the radar has a direct line of sight, set this property to `true`. For example, with this property enabled, the radar does not generate a detection for a vehicle that is behind another vehicle and blocked from view.

Data Types: `logical`**MaxNumReportsSource — Source of maximum for number of detection or track reports**`'Auto'` (default) | `'Property'`

Source of the maximum for the number of detection or track reports, specified as one of these options:

- `'Auto'` — The sensor reports all detections or tracks.
- `'Property'` — The sensor reports the first N valid detections or tracks, where N is equal to the `MaxNumReports` property value.

MaxNumReports — Maximum number of detections or tracks`50` (default) | positive integer

Maximum number of detections or tracks that the sensor reports, specified as a positive integer. The sensor reports detections in the order of increasing distance from the sensor until reaching this maximum number.

Dependencies

To enable this property, set the `MaxNumReportsSource` property to `'Property'`.

Data Types: `double`**TargetReportFormat — Format of generated target reports**`'Clustered detections'` (default) | `'Tracks'` | `'Detections'`

Format of generated target reports, specified as one of these options:

- `'Clustered detections'` — The sensor generates target reports as clustered detections, where each target is reported as a single detection that is the centroid of the unclustered target detections. The sensor returns clustered detections as an array of `objectDetection` objects, as described in the `dets` output argument.
- `'Tracks'` — The sensor generates target reports as tracks, which are clustered detections that have been processed by a tracking filter. The sensor returns tracks as an array of `objectTrack` objects, as described in the `tracks` output argument.
- `'Detections'` — The sensor generates target reports as unclustered detections, where each target can have multiple detections. The sensor returns unclustered detections as an array of `objectDetection` objects, as described in the `dets` output argument.

DetectionCoordinates — Coordinate system of reported detections`'Body'` (default) | `'Sensor rectangular'` | `'Sensor spherical'`

Coordinate system of reported detections, specified as one of these options:

- `'Body'` — Detections are reported in the rectangular body system of the ego vehicle.

- 'Sensor rectangular' — Detections are reported in the rectangular body system of the radar sensor.
- 'Sensor spherical' — Detections are reported in a spherical coordinate system that is centered at the radar sensor and aligned with the orientation of the radar on the ego vehicle.

Measurement Resolution**AzimuthResolution — Azimuth resolution of radar (deg)**

4 (default) | positive real scalar

Azimuth resolution of the radar, in degrees, specified as a positive scalar. The azimuth resolution defines the minimum separation in azimuth angle at which the radar can distinguish between two targets. The azimuth resolution is typically the 3 dB downpoint of the azimuth angle beamwidth of the radar.

Data Types: double

ElevationResolution — Elevation resolution of radar (deg)

5 (default) | positive real scalar

Elevation resolution of the radar, in degrees, specified as a positive real scalar. The elevation resolution defines the minimum separation in elevation angle at which the radar can distinguish between two targets. The elevation resolution is typically the half-power beamwidth of the elevation angle beamwidth of the radar.

Dependencies

To enable this property, set the HasElevation property to `true`.

Data Types: double

RangeResolution — Range resolution of radar (m)

2.5 (default) | positive real scalar

Range resolution of the radar, in meters, specified as a positive real scalar. The range resolution defines the minimum separation in range at which the radar can distinguish between two targets.

Data Types: double

RangeRateResolution — Range rate resolution of radar (m/s)

0.5 (default) | positive real scalar

Range rate resolution of the radar, in meters per second, specified as a positive real scalar. The range rate resolution defines the minimum separation in range rate at which the radar can distinguish between two targets.

Dependencies

To enable this property, set the HasRangeRate property to `true`.

Data Types: double

Measurement Bias**AzimuthBiasFraction — Azimuth bias fraction of radar**

0.1 (default) | nonnegative scalar

Azimuth bias fraction of the radar, specified as a nonnegative scalar. Azimuth bias is expressed as a fraction of the azimuth resolution specified in the `AzimuthResolution` property. This value sets a lower bound on the azimuthal accuracy of the radar and is dimensionless.

Data Types: `double`

ElevationBiasFraction — Elevation bias fraction of radar

0.1 (default) | nonnegative scalar

Elevation bias fraction of the radar, specified as a nonnegative scalar. Elevation bias is expressed as a fraction of the elevation resolution specified by the `ElevationResolution` property. This value sets a lower bound on the elevation accuracy of the radar and is dimensionless.

Dependencies

To enable this property, set the `HasElevation` property to `true`.

Data Types: `double`

RangeBiasFraction — Range bias fraction

0.05 (default) | nonnegative scalar

Range bias fraction of the radar, specified as a nonnegative scalar. Range bias is expressed as a fraction of the range resolution specified by the `RangeResolution` property. This property sets a lower bound on the range accuracy of the radar and is dimensionless.

Data Types: `double`

RangeRateBiasFraction — Range-rate bias fraction

0.05 (default) | nonnegative scalar

Range-rate bias fraction of the radar, specified as a nonnegative scalar. Range-rate bias is expressed as a fraction of the range-rate resolution specified by the `RangeRateResolution` property. This property sets a lower bound on the range rate accuracy of the radar and is dimensionless.

Dependencies

To enable this property, set the `HasRangeRate` property to `true`.

Data Types: `double`

Detection Settings

DetectionProbability — Probability of detecting target

0.9 (default) | scalar in range (0, 1]

Probability of detecting a target, specified as a scalar in the range (0, 1]. This property defines the probability of detecting a target with a radar cross-section (RCS), `ReferenceRCS`, at the reference detection range, `ReferenceRange`.

Data Types: `double`

ReferenceRange — Reference range for given probability of detection (m)

100 (default) | positive real scalar

Reference range for the given probability of detection and the given reference radar cross-section (RCS), in meters, specified as a positive real scalar. The reference range is the range at which a target having a radar cross-section specified by the `ReferenceRCS` property is detected with a probability of detection specified by the `DetectionProbability` property.

Data Types: double

ReferenceRCS — Reference radar cross-section for given probability of detection (dBsm)

0 (default) | real scalar

Reference radar cross-section (RCS) for a given probability of detection and reference range, in decibel square meters, specified as a real scalar. The reference RCS is the RCS value at which a target is detected with a probability specified by `DetectionProbability` at the specified `ReferenceRange` value.

Data Types: double

FalseAlarmRate — False alarm report rate

1e-6 (default) | positive real scalar in range $[10^{-7}, 10^{-3}]$

False alarm report rate within each radar resolution cell, specified as a positive real scalar in the range $[10^{-7}, 10^{-3}]$. Units are dimensionless. The object determines resolution cells from the `AzimuthResolution` and `RangeResolution` properties and, when enabled, from the `ElevationResolution` and `RangeRateResolution` properties.

Data Types: double

CenterFrequency — Center frequency of radar band (Hz)

77e9 (default) | positive real scalar

Center frequency of the radar band, in hertz, specified as a positive scalar.

Data Types: double

FieldOfView — Angular field of view of radar (deg)

[20 5] | 1-by-2 positive real-valued vector of form [azfov elfov]

Angular field of view of radar, in degrees, specified as a 1-by-2 positive real-valued vector of the form [azfov elfov]. The field of view defines the total angular extent spanned by the sensor. The azimuth field of view, azfov, must lie in the interval (0, 360]. The elevation field of view, elfov, must lie in the interval (0, 180].

Data Types: double

RangeLimits — Minimum and maximum range of radar (m)

[0 150] (default) | 1-by-2 nonnegative real-valued vector of form [min max]

Minimum and maximum range of radar, in meters, specified as a 1-by-2 nonnegative real-valued vector of the form [min max]. The radar does not detect targets that are outside this range. The maximum range, max, must be greater than the minimum range, min.

RangeRateLimits — Minimum and maximum range rate of radar (m/s)

[-100 100] (default) | 1-by-2 real-valued vector of form [min max]

Minimum and maximum range rate of radar, in meters per second, specified as a 1-by-2 real-valued vector of the form [min max]. The radar does not detect targets that are outside this range rate. The maximum range rate, max, must be greater than the minimum range rate, min.

Dependencies

To enable this property, set the `HasRangeRate` property to `true`.

RadarLoopGain — Radar loop gain

real scalar

This property is read-only.

Radar loop gain, specified as a real scalar. RadarLoopGain depends on the values of the DetectionProbability, ReferenceRange, ReferenceRCS, and FalseAlarmRate properties. Radar loop gain is a function of the reported signal-to-noise ratio of the radar, *SNR*, the target radar cross-section, *RCS*, and the target range, *R*, as described by this equation:

$$SNR = \text{RadarLoopGain} + RCS - 40\log_{10}(R)$$

SNR and *RCS* are in decibels and decibel square meters, respectively, *R* is in meters, and RadarLoopGain is in decibels.

Data Types: double

Tracking Settings**FilterInitializationFcn — Kalman filter initialization function**

@initcvekf (default) | function handle | character vector | string scalar

Kalman filter initialization function, specified as a function handle or as a character vector or string scalar of the name of a valid Kalman filter initialization function.

The table shows the initialization functions that you can use to specify FilterInitializationFcn.

Initialization Function	Function Definition
initcaabf	Initialize constant-acceleration alpha-beta Kalman filter
initcvabf	Initialize constant-velocity alpha-beta Kalman filter
initcakf	Initialize constant-acceleration linear Kalman filter.
initcvkf	Initialize constant-velocity linear Kalman filter.
initcaekf	Initialize constant-acceleration extended Kalman filter.
initctekf	Initialize constant-turnrate extended Kalman filter.
initcvekf	Initialize constant-velocity extended Kalman filter.
initcaukf	Initialize constant-acceleration unscented Kalman filter.
initctukf	Initialize constant-turnrate unscented Kalman filter.
initcvukf	Initialize constant-velocity unscented Kalman filter.

You can also write your own initialization function. The function must have the following syntax:

```
filter = filterInitializationFcn(detection)
```

The input to this function is a detection report like those created by an `objectDetection` object. The output of this function must be a tracking filter object, such as `trackingKF`, `trackingEKF`, `trackingUKF`, or `trackingABF`.

To guide you in writing this function, you can examine the details of the supplied functions from within MATLAB. For example:

```
type initcvekf
```

Dependencies

To enable this property, set the `TargetReportFormat` property to `'Tracks'`.

Data Types: `function_handle` | `char` | `string`

ConfirmationThreshold — Threshold for track confirmation

[2 3] (default) | 1-by-2 vector of positive integers

Threshold for track confirmation, specified as a 1-by-2 vector of positive integers of the form [M N]. A track is confirmed if it receives at least M detections in the last N updates. M must be less than or equal to N.

- When setting M, take into account the probability of object detection for the sensors. The probability of detection depends on factors such as occlusion or clutter. You can reduce M when tracks fail to be confirmed or increase M when too many false detections are assigned to tracks.
- When setting N, consider the number of times you want the tracker to update before it makes a confirmation decision. For example, if a tracker updates every 0.05 seconds, and you want to allow 0.5 seconds to make a confirmation decision, set `N = 10`.

Example: [3 5]

Dependencies

To enable this property, set the `TargetReportFormat` property to `'Tracks'`.

Data Types: `double`

DeletionThreshold — Threshold for track deletion

[5 5] (default) | 1-by-2 vector of positive integers

Threshold for track deletion, specified as a 1-by-2 vector of positive integers of the form [P R]. If a confirmed track is not assigned to any detection P times in the last R tracker updates, then the track is deleted. P must be less than or equal to R.

- To reduce how long the radar maintains tracks, decrease R or increase P.
- To maintain tracks for a longer time, increase R or decrease P.

Example: [3 5]

Dependencies

To enable this property, set the `TargetReportFormat` property to `'Tracks'`.

Data Types: `double`

TrackCoordinates — Coordinate system of reported tracks

'Body' (default) | 'Sensor'

Coordinate system of reported tracks, specified as one of these options:

- 'Body' — Tracks are reported in the rectangular body system of the ego vehicle.
- 'Sensor' — Tracks are reported in the rectangular body system of the radar sensor.

Dependencies

To enable this property, set the `TargetReportFormat` property to 'Tracks'.

Target Profiles

Profiles — Actor profiles

structure | array of structures

Actor profiles, specified as a structure or as an array of structures. Each structure contains the physical and radar characteristics of an actor.

- If `ActorProfiles` is a single structure, all actors passed into the `drivingRadarDataGenerator` object use this profile.
- If `ActorProfiles` is an array, each actor passed into the object must have a unique actor profile.

To generate an array of structures for your driving scenario, use the `actorProfiles` function. The table shows the valid structure fields. If you do not specify a field, that field is set to its default value. If no actors are passed into the object, then the `ActorID` field is not included.

Field	Description
ActorID	Scenario-defined actor identifier, specified as a positive integer.
ClassID	Classification identifier, specified as a nonnegative integer. 0 is reserved for an object of an unknown or unassigned class.
Length	Length of actor, specified as a positive real scalar. The default is 4.7. Units are in meters.
Width	Width of actor, specified as a positive real scalar. The default is 1.8. Units are in meters.
Height	Height of actor, specified as a positive real scalar. The default is 1.4. Units are in meters.
OriginOffset	Offset of the rotational center of the actor from its geometric center, specified as an [x y z] real-valued vector. The rotational center, or origin, is located at the bottom center of the actor. For vehicles, the rotational center is the point on the ground beneath the center of the rear axle. The default is [0 0 0]. Units are in meters.
RCSPattern	Radar cross-section pattern of actor, specified as a <code>numel(RCSElevationAngles)</code> -by- <code>numel(RCSAzimuthAngles)</code> real-valued matrix. The default is [10 10; 10 10]. Units are in decibels per square meter.

Field	Description
RCSAzimuthAngles	Azimuth angles corresponding to rows of RCSPattern, specified as a vector of real values in the range [-180, 180]. The default is [-180 180]. Units are in degrees.
RCSElevationAngles	Elevation angles corresponding to rows of RCSPattern, specified as a vector of real values in the range [-90, 90]. The default is [-90 90]. Units are in degrees.

For full definitions of the structure fields, see the `actor` and `vehicle` functions.

Data Types: `struct`

Usage

Syntax

```
dets = rdr(targets,simTime)
[dets,numReports] = rdr(targets,simTime)
[dets,numReports,isValidTime] = rdr(targets,simTime)
```

```
tracks = rdr(targets,simTime)
[tracks,numReports] = rdr(targets,simTime)
[tracks,numReports,isValidTime] = rdr(targets,simTime)
```

Description

Generate Detections

These syntaxes apply when you set the `TargetReportFormat` property to 'Clustered detections' or 'Detections'.

`dets = rdr(targets,simTime)` creates radar detections, `dets`, from sensor measurements taken of target poses, `targets`, relative to the ego vehicle at the current simulation time, `simTime`. The object can generate sensor detections for multiple actors simultaneously.

`[dets,numReports] = rdr(targets,simTime)` also returns the number of valid detections reported, `numReports`.

`[dets,numReports,isValidTime] = rdr(targets,simTime)` also returns a logical value, `isValidTime`, indicating whether `simTime` is a valid time for generating detections. If `simTime` is an integer multiple of the reciprocal of the `UpdateRate` property value, then `isValidTime` is 1 (`true`).

Generate Tracks

These syntaxes apply when you set the `TargetReportFormat` property to 'Tracks'.

`tracks = rdr(targets,simTime)` creates radar tracks, `tracks`, from sensor measurements taken of target poses, `targets`, relative to the ego vehicle at the current simulation time, `simTime`. The object can generate sensor tracks for multiple actors simultaneously.

[tracks,numReports] = rdr(targets,simTime) also returns the number of valid tracks reported, numReports.

[tracks,numReports,isValidTime] = rdr(targets,simTime) also returns a logical value, isValidTime, indicating whether simTime is a valid time for generating tracks. If simTime is an integer multiple of the reciprocal of the UpdateRate property value, then isValidTime is 1 (true).

Input Arguments

targets — Target actor poses

structure | structure array

Target actor poses, specified as a structure or structure array. Each structure corresponds to the pose of a target actor relative to the ego vehicle. To generate these structures, use the targetPoses function. You can also create these structures manually. Do not include the ego vehicle pose in the structure array.

This table shows the required fields for the structures.

Field	Description
ActorID	Scenario-defined actor identifier, specified as a positive integer.
ClassID	Classification identifier, specified as a nonnegative integer. 0 represents an object of an unknown or unassigned class.
Position	Position of actor, specified as a real-valued vector of the form [x y z]. Units are in meters.
Velocity	Velocity (v) of actor in the x -, y -, and z -directions, specified as a real-valued vector of the form [v_x v_y v_z]. Units are in meters per second.
Roll	Roll angle of actor, specified as a real scalar. Units are in degrees.
Pitch	Pitch angle of actor, specified as a real scalar. Units are in degrees.
Yaw	Yaw angle of actor, specified as a real scalar. Units are in degrees.
AngularVelocity	Angular velocity (ω) of actor in the x -, y -, and z -directions, specified as a real-valued vector of the form [ω_x ω_y ω_z]. Units are in degrees per second.

simTime — Current simulation time

nonnegative real scalar

Current simulation time, in seconds, specified as a nonnegative real scalar.

Example: 10.5

Data Types: double

Output Arguments

dets — Generated detections

cell array of `objectDetection` objects

Generated detections, returned as a cell array of `objectDetection` objects. Each object contains these properties:

Property	Definition
Time	Measurement time
Measurement	Object measurements
MeasurementNoise	Measurement noise covariance matrix
SensorIndex	Unique ID of the sensor
ObjectClassID	Object classification
MeasurementParameters	Parameters used by initialization functions of nonlinear Kalman tracking filters
ObjectAttributes	Additional information passed to tracker

For rectangular coordinates, `Measurement` and `MeasurementNoise` are reported in the rectangular coordinate system specified by the `DetectionCoordinates` property of the `drivingRadarDataGenerator` object.

For spherical coordinates, `Measurement` and `MeasurementNoise` are reported in the spherical coordinate system, which is based on the sensor rectangular coordinate system.

Measurement and MeasurementNoise

DetectionCoordinates Value	Measurement and MeasurementNoise Coordinates		
'Body'	Coordinate Dependence on HasRangeRate		
'Sensor rectangular'	HasRangeRate	Coordinates	
	true	[x;y;z;vx;vy;vz]	
	false	[x;y;z]	
'Sensor spherical'	Coordinate Dependence on HasRangeRate and HasElevation		
	HasRangeRate	HasElevation	Coordinates
	true	true	[az;el;rng;rr]
	true	false	[az;rng;rr]
	false	true	[az;el;rng]
	false	false	[az;rng]

For `ObjectAttributes`, this table describes the additional information used for tracking.

ObjectAttributes

Attribute	Definition
TargetIndex	Identifier of the actor, ActorID, that generated the detection. For false alarms, this value is negative.
SNR	Detection signal-to-noise ratio, in dB.

For MeasurementParameters, the measurements are relative to the parent frame. When you set the DetectionCoordinates property to 'Body', the parent frame is the ego vehicle body. When you set DetectionCoordinates to 'Sensor rectangular' or 'Sensor spherical', the parent frame is the sensor.

MeasurementParameters

Parameter	Definition
Frame	Enumerated type indicating the frame used to report measurements. When Frame is set to 'rectangular', detections are reported in rectangular coordinates. When Frame is set to 'spherical', detections are reported in spherical coordinates.
OriginPosition	3-D vector offset of the sensor origin from the parent frame origin.
OriginVelocity	Velocity of the sensor coordinate system with respect to the parent frame.
Orientation	Orientation of the radar sensor coordinate system with respect to the parent frame.
IsParentToChild	Logical scalar indicating if Orientation performs a frame rotation from the parent coordinate frame to the child coordinate frame. When IsParentToChild is false, then Orientation performs a frame rotation from the child coordinate frame to the parent coordinate frame.
HasAzimuth	Indicates whether measurements contain azimuth components.
HasElevation	Indicates whether measurements contain elevation components.
HasRange	Indicates whether measurements contain range components.
HasVelocity	Indicates whether measurements contain velocity or range rate components.

tracks — Generated tracks

objectTrack array | structure array

Generated tracks, returned as an `objectTrack` array in MATLAB and a structure array in generated code. In generated code, the field names of the returned structure are same as the property names of the `objectTrack` object.

The sensor returns only confirmed tracks, which are tracks that satisfy the confirmation threshold specified in the `ConfirmationThreshold` property. For these tracks, the `IsConfirmed` property of the object or field of the structure is `true`.

Data Types: `struct` | `object`

numReports — Number of reported detections or tracks

nonnegative integer

Number of reported detections or tracks, returned as a nonnegative integer. `numReports` is equal to the length of `dets` when generating detections and `tracks` when generating tracks.

Data Types: `double`

isValidTime — Valid time for generating reports

0 | 1

Valid time for generating reports, returned as a logical 0 (`false`) or 1 (`true`).

If `isValidTime` is 0 (`false`), then the reports returned by `dets` (for generated detections) or `tracks` (for generated tracks) are invalid because the sensor generated them at a time that is inconsistent with the sensor update rate.

The sensor generates reports only when the current simulation time, `simTime`, is an integer multiple of the time interval at which the sensor generates reports. This time interval is equal to the reciprocal of the `UpdateRate` property value.

Data Types: `logical`

Object Functions

To use an object function, specify the System object as the first input argument. For example, to release system resources of a System object named `obj`, use this syntax:

```
release(obj)
```

Specific to drivingRadarDataGenerator

`isLocked` Determine if System object is in use

`clone` Create duplicate System object

Common to All System Objects

`step` Run System object algorithm

`release` Release resources and allow changes to System object property values and input characteristics

`reset` Reset internal states of System object

Examples

Generate Radar Detections and Tracks of Multiple Vehicles

Use a radar sensor to generate clustered detections, unclustered detections, and tracks of multiple vehicles in a driving scenario.

Create Driving Scenario

Create an empty driving scenario and add a two-lane, 100-meter road segment. Separate the lanes by using dashed lane markings.

```
scenario = drivingScenario('SampleTime',0.02);
roadCenters = [0 0 0; 100 0 0];
marking = [laneMarking('Solid') laneMarking('Dashed') laneMarking('Solid')];
laneSpecification = lanespec([1 1],'Marking',marking);
road(scenario,roadCenters,'Lanes',laneSpecification);
```

Add the ego vehicle. The vehicle travels 90 meters in the right lane at a constant speed of 20 meters per second.

```
ego = vehicle(scenario,'ClassID',1,'Position',[5 -1.8 0]);
egoWaypoints = [ego.Position; ...
                (ego.Position(1) + 90) ego.Position(2:3)];
egoSpeed = 20; % m/s
smoothTrajectory(ego,egoWaypoints,egoSpeed)
```

Add the target vehicles that the radar can generate detections and tracks from.

- The first vehicle is a car that starts 10 meters in front of the ego vehicle and travels along the lane at a constant speed of 30 meters per second.
- The second vehicle is a truck that travels in the left lane at a constant speed of 30 meters per second.

```
car = vehicle(scenario,'ClassID',1,'Position',[ego.Position(1)+10 -1.8 0]);
carWaypoints = [car.Position; ...
                (car.Position(1) + 75) car.Position(2:3)];
carSpeed = 30; % m/s
smoothTrajectory(car,carWaypoints,carSpeed)
```

```
truck = vehicle(scenario,'ClassID',2,'Position',[5 1.8 0], ...
                'Length',8.2,'Width',2.5,'Height',3.5);
truckWaypoints = [truck.Position; ...
                  (truck.Position(1) + 90) truck.Position(2:3)];
truckSpeed = 30; % m/s
smoothTrajectory(truck,truckWaypoints,truckSpeed)
```

Plot the driving scenario and pause to allow time for the plot to update.

```
plot(scenario)
while advance(scenario)
    pause(scenario.SampleTime)
end
```

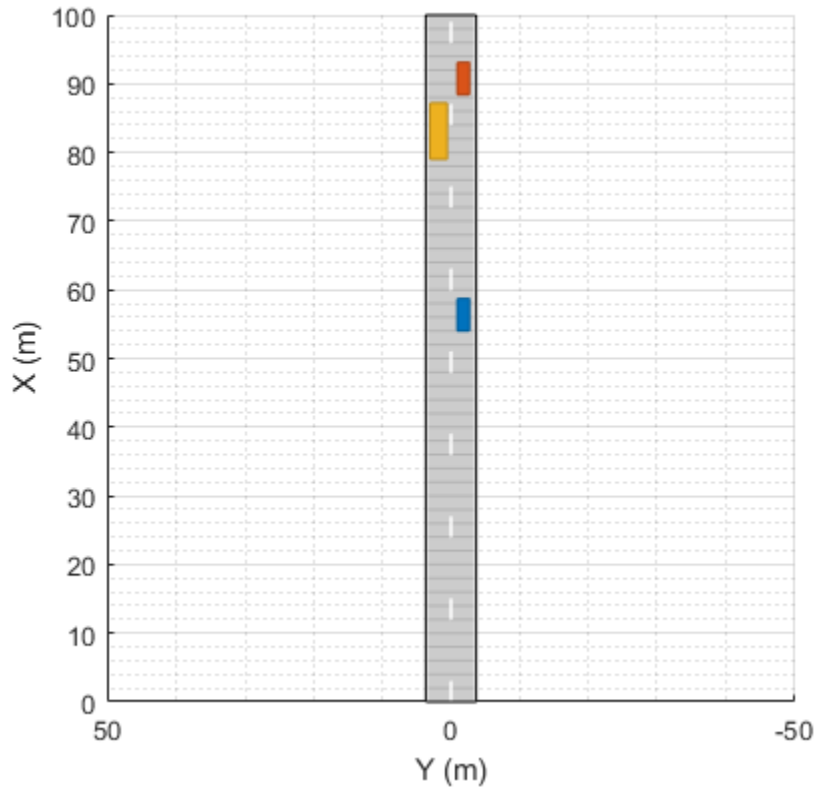

Create Radar Sensor

Create a radar sensor with a maximum range of 100 meters and mount it to the front mirror of the ego vehicle. Configure the sensor to update at the same rate as the sample time of the scenario. Specify for the radar to use the target profiles of the car and truck for generating data.

```
close(gcf)
```

```
maxRange = 100; % m
frontMirror = [ego.FrontOverhang 0 (ego.Height-0.1)];
profiles = actorProfiles(scenario);
targetProfiles = profiles(2:end);

id = 1;
rdr = drivingRadarDataGenerator(id, 'UpdateRate', 1/scenario.SampleTime, ...
    'MountingLocation', frontMirror, ...
    'RangeLimits', [0 maxRange], ...
    'Profiles', targetProfiles)
```

```
rdr =
```

```
drivingRadarDataGenerator with properties:
```

```
    SensorIndex: 1
    UpdateRate: 50
```

```
MountingLocation: [0.9000 0 1.3000]
```

```

MountingAngles: [0 0 0]

FieldOfView: [20 5]
RangeLimits: [0 100]
RangeRateLimits: [-100 100]

DetectionProbability: 0.9000
FalseAlarmRate: 1.0000e-06

```

Use `get` to show all properties

Create Bird's-Eye Plot

Create a bird's-eye plot for visualizing the sensor data. Add plotters for visualizing the lane markings, vehicle outlines, and radar coverage area. Use the `helperPlotScenario` function to plot these aspects of the scenario. This helper function is defined at the end of the example.

```

bep = birdsEyePlot('XLim',[0 60],'YLim',[-35 35]);

lmPlotter = laneMarkingPlotter(bep,'Tag','lm','DisplayName','Lane markings');
olPlotter = outlinePlotter(bep,'Tag','ol');
caPlotter = coverageAreaPlotter(bep, ...
    'Tag','ca', ...
    'DisplayName','Radar coverage area', ...
    'FaceColor','red','EdgeColor','red');

helperPlotScenario(bep,rdr,ego)

```

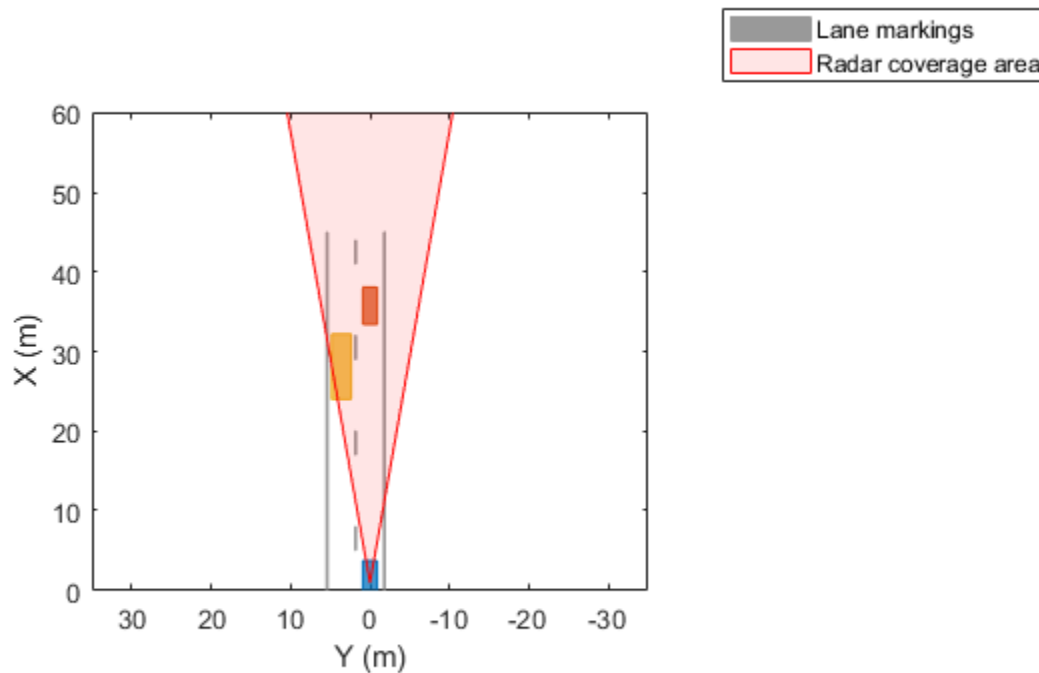

Generate Clustered Detections

Use the radar to generate clustered detections of the target vehicles. Visualize these detections on the bird's-eye plot. At each simulation time step, the radar generates only one detection per target.

```
clusterDetPlotter = detectionPlotter(bep, ...
    'DisplayName','Clustered detections', ...
    'MarkerEdgeColor','red', ...
    'MarkerFaceColor','red');

restart(scenario)
while advance(scenario)

    simTime = scenario.SimulationTime;
    targets = targetPoses(ego);
    [dets,numDets,isValidTime] = rdr(targets,simTime);

    helperPlotScenario(bep,rdr,ego)

    if isValidTime && numDets > 0
        detPos = cell2mat(cellfun(@(d)d.Measurement(1:2),dets, ...
            'UniformOutput',false)');
        plotDetection(clusterDetPlotter,detPos)
    end
end
```

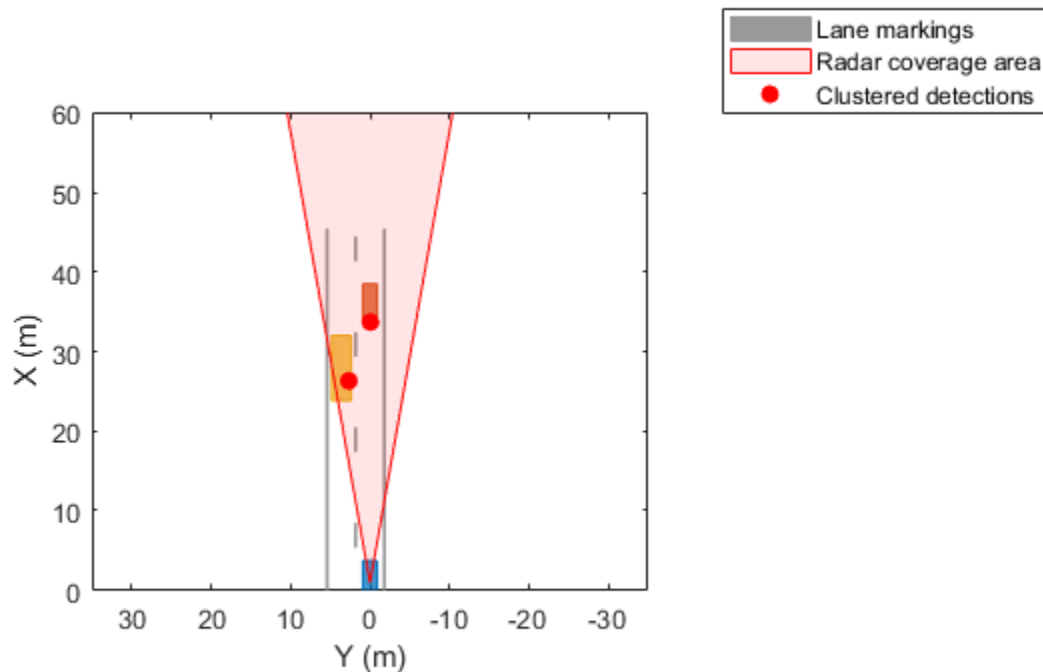

Generate Unclustered Detections

Use the radar to generate unclustered detections of the target vehicles. Visualize these detections on the bird's-eye plot. At each simulation time step, the radar generates multiple detections per target.

```
clearData(clusterDetPlotter)
release(rdr)

rdr.TargetReportFormat = "Detections";
detPlotter = detectionPlotter(bep, ...
    'DisplayName','Unclustered detections', ...
    'MarkerEdgeColor','red');

restart(scenario)
while advance(scenario)

    simTime = scenario.SimulationTime;
    targets = targetPoses(ego);
    [dets,numDets,isValidTime] = rdr(targets,simTime);

    helperPlotScenario(bep,rdr,ego)

    if isValidTime && numDets > 0
        detPos = cell2mat(cellfun(@(d)d.Measurement(1:2),dets, ...
            'UniformOutput',false)'));
        plotDetection(detPlotter,detPos)
    end
end
```

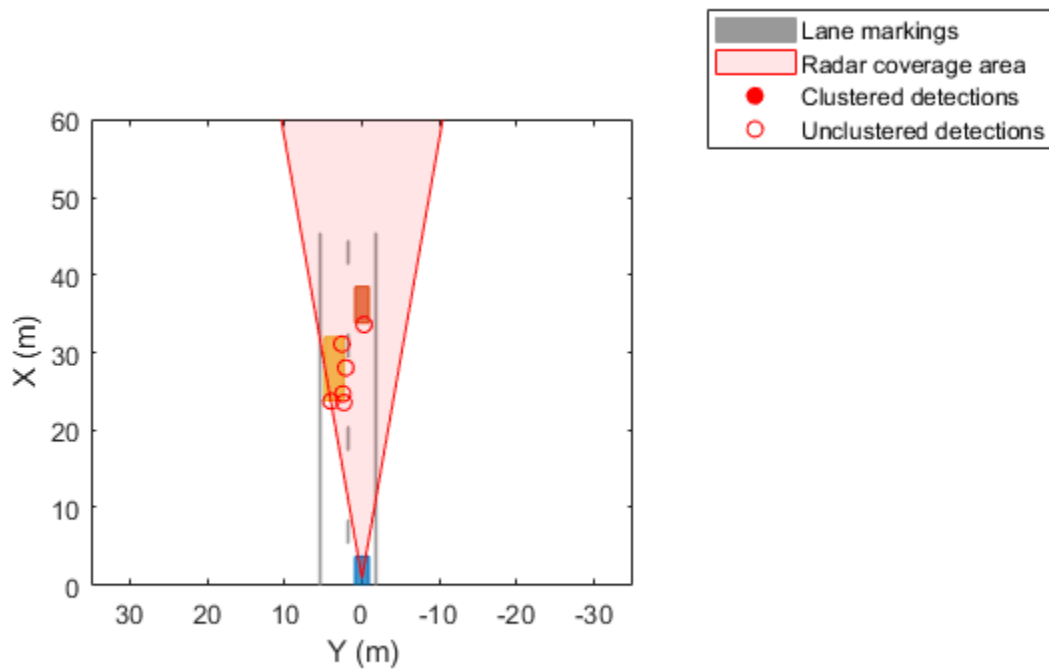

Generate Tracks

Use the radar to generate tracks of the target vehicles. Visualize these tracks and the track history on the bird's-eye plot.

```
clearData(detPlotter)
release(rdr)

rdr.TargetReportFormat = "Tracks";
historyDepth = 20;
tPlotter = trackPlotter(bep, 'DisplayName', 'Tracks', ...
    'HistoryDepth', historyDepth);

restart(scenario)
while advance(scenario)

    simTime = scenario.SimulationTime;
    targets = targetPoses(ego);
    [tracks, numTracks, isValidTime] = rdr(targets, simTime);

    helperPlotScenario(bep, rdr, ego)

    if isValidTime && numTracks > 0
        trackPos = cell2mat(arrayfun(@(t)t.State(1:2:end), tracks, ...
            'UniformOutput', false));
        plotTrack(tPlotter, trackPos(:, 1:2))
    end
end
```

end

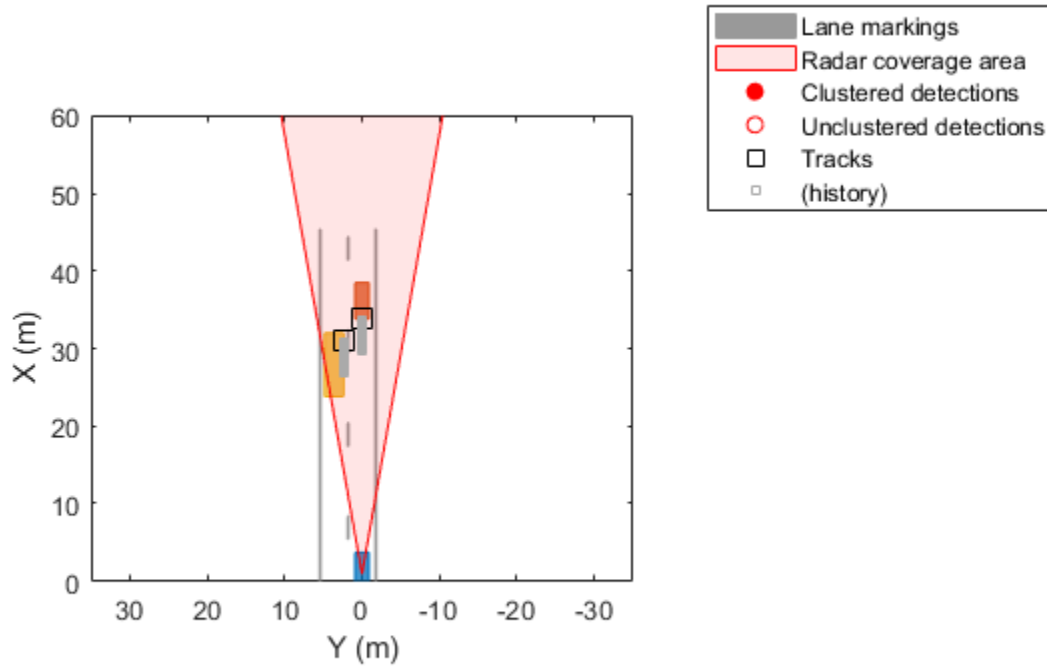

Close the bird's-eye plot, restart the scenario, and release the radar sensor.

```
close(gcf)
restart(scenario)
release(rdr)
```

Supporting Functions

`helperPlotScenario` plots the lane markings and vehicle outlines of the ego vehicle on the bird's-eye plot. It also plots the coverage area of the radar sensor.

```
function helperPlotScenario(bep, radar, ego)

% Plot lane markings
lmPlotter = findPlotter(bep, 'Tag', 'lm');
[lmv, lmf] = laneMarkingVertices(ego);
plotLaneMarking(lmPlotter, lmv, lmf)

% Plot vehicle outlines
olPlotter = findPlotter(bep, 'Tag', 'ol');
[position, yaw, length, width, originOffset, color] = targetOutlines(ego);
plotOutline(olPlotter, position, yaw, length, width, ...
            'OriginOffset', originOffset, 'Color', color)

% Plot radar coverage area
```

```
caPlotter = findPlotter(bep, 'Tag', 'ca');  
plotCoverageArea(caPlotter, radar.MountingLocation(1:2), ...  
    radar.RangeLimits(2), radar.MountingAngles(1), ...  
    radar.FieldOfView(1))
```

end

Version History

Introduced in R2021a

See Also

Objects

objectDetection | objectTrack | drivingScenario | multiObjectTracker |
visionDetectionGenerator | lidarPointCloudGenerator | insSensor

Functions

actorProfiles

Blocks

Driving Radar Data Generator

Apps

Driving Scenario Designer

Topics

“Sensor Fusion Using Synthetic Radar and Vision Data”

“Track-Level Fusion of Radar and Lidar Data”

“Model Radar Sensor Detections”

“Coordinate Systems in Automated Driving Toolbox”

visionDetectionGenerator

Generate vision detections for driving scenario

Description

The `visionDetectionGenerator` System object generates detections from a monocular camera sensor mounted on an ego vehicle. All detections are referenced to the coordinate system of the ego vehicle or the vehicle-mounted sensor. You can use the `visionDetectionGenerator` object in a scenario containing actors and trajectories, which you can create by using a `drivingScenario` object. Using a statistical mode, the generator can simulate real detections with added random noise and also generate false alarm detections. In addition, you can use the `visionDetectionGenerator` object to create input to a `multiObjectTracker`. When building scenarios using the **Driving Scenario Designer** app, the camera sensors mounted on the ego vehicle are output as `visionDetectionGenerator` objects.

To generate visual detections:

- 1 Create the `visionDetectionGenerator` object and set its properties.
- 2 Call the object with arguments, as if it were a function.

To learn more about how System objects work, see [What Are System Objects?](#)

Creation

Syntax

```
sensor = visionDetectionGenerator
sensor = visionDetectionGenerator(cameraConfig)
sensor = visionDetectionGenerator(Name,Value)
```

Description

`sensor = visionDetectionGenerator` creates a vision detection generator object with default property values.

`sensor = visionDetectionGenerator(cameraConfig)` creates a vision detection generator object using the `monoCamera` configuration object, `cameraConfig`.

`sensor = visionDetectionGenerator(Name,Value)` sets properties on page 4-226 using one or more name-value pairs. For example, `visionDetectionGenerator('DetectionCoordinates','SensorCartesian','MaxRange',200)` creates a vision detection generator that reports detections in the sensor Cartesian coordinate system and has a maximum detection range of 200 meters. Enclose each property name in quotes.

Properties

Unless otherwise indicated, properties are *nontunable*, which means you cannot change their values after calling the object. Objects lock when you call them, and the `release` function unlocks them.

If a property is *tunable*, you can change its value at any time.

For more information on changing property values, see System Design in MATLAB Using System Objects.

DetectorOutput — Types of detections generated by sensor

'Objects only' (default) | 'Lanes only' | 'Lanes with occlusion' | 'Lanes and objects'

Types of detections generated by the sensor, specified as 'Objects only', 'Lanes only', 'Lanes with occlusion', or 'Lanes and objects'.

- When set to 'Objects only', only actors are detected.
- When set to 'Lanes only', only lanes are detected.
- When set to 'Lanes with occlusion', only lanes are detected but actors in the camera field of view can impair the sensor ability to detect lanes.
- When set to 'Lanes and objects', the sensor generates both object detections and occluded lane detections.

Example: 'Lanes with occlusion'

Data Types: char | string

SensorIndex — Unique sensor identifier

positive integer

Unique sensor identifier, specified as a positive integer. This property distinguishes detections that come from different sensors in a multi-sensor system.

Example: 5

Data Types: double

UpdateInterval — Required time interval between sensor updates

0.1 | positive real scalar

Required time interval between sensor updates, specified as a positive real scalar. The `drivingScenario` object calls the vision detection generator at regular time intervals. The vision detector generates new detections at intervals defined by the `UpdateInterval` property. The value of the `UpdateInterval` property must be an integer multiple of the simulation time interval. Updates requested from the sensor between update intervals contain no detections. Units are in seconds.

Example: 5

Data Types: double

SensorLocation — Sensor location

[3.4 0] | [x y] vector

Location of the vision sensor center, specified as an [x y]. The `SensorLocation` and `Height` properties define the coordinates of the vision sensor with respect to the ego vehicle coordinate

system. The default value corresponds to a forward-facing sensor mounted on a vehicle dashboard. Units are in meters.

Example: [4 0.1]

Data Types: double

Height — Sensor height above ground plane

1.1 | positive real scalar

Sensor height above the vehicle ground plane, specified as a positive real scalar. The default value corresponds to a forward-facing vision sensor mounted on the dashboard of a sedan. Units are in meters.

Example: 1.5

Data Types: double

Yaw — Yaw angle of vision sensor

0 | real scalar

Yaw angle of vision sensor, specified as a real scalar. The yaw angle is the angle between the center line of the ego vehicle and the down-range axis of the vision sensor. A positive yaw angle corresponds to a clockwise rotation when looking in the positive direction of the z-axis of the ego vehicle coordinate system. Units are in degrees.

Example: -4

Data Types: double

Pitch — Pitch angle of vision sensor

0 | real scalar

Pitch angle of vision sensor, specified as a real scalar. The pitch angle is the angle between the down-range axis of the vision sensor and the x-y plane of the ego vehicle coordinate system. A positive pitch angle corresponds to a clockwise rotation when looking in the positive direction of the y-axis of the ego vehicle coordinate system. Units are in degrees.

Example: 3

Data Types: double

Roll — Roll angle of vision sensor

0 | real scalar

Roll angle of the vision sensor, specified as a real scalar. The roll angle is the angle of rotation of the down-range axis of the vision sensor around the x-axis of the ego vehicle coordinate system. A positive roll angle corresponds to a clockwise rotation when looking in the positive direction of the x-axis of the coordinate system. Units are in degrees.

Example: -4

Data Types: double

Intrinsics — Intrinsic calibration parameters of vision sensor

cameraIntrinsics([800 800],[320 240],[480 640]) (default) | cameraIntrinsics object

Intrinsic calibration parameters of vision sensor, specified as a cameraIntrinsics object.

FieldOfView — Angular field of view of vision sensor

real-valued 1-by-2 vector of positive values

This property is read-only.

Angular field of view of vision sensor, specified as a real-valued 1-by-2 vector of positive values, [azfov, elfov]. The field of view defines the azimuth and elevation extents of the sensor image. Each component must lie in the interval from 0 degrees to 180 degrees. The field of view is derived from the intrinsic parameters of the vision sensor. Targets outside of the angular field of view of the sensor are not detected. Units are in degrees.

Data Types: double

MaxRange — Maximum detection range

150 | positive real scalar

Maximum detection range, specified as a positive real scalar. The sensor cannot detect a target beyond this range. Units are in meters.

Example: 200

Data Types: double

MaxSpeed — Maximum detectable object speed

100 (default) | nonnegative real scalar

Maximum detectable object speed, specified as a nonnegative real scalar. Units are in meters per second.

Example: 10.0

Data Types: double

MaxAllowedOcclusion — Maximum allowed occlusion of an object

0.5 (default) | real scalar in the range [0 1]

Maximum allowed occlusion of an object, specified as a real scalar in the range [0 1]. Occlusion is the fraction of the total surface area of an object not visible to the sensor. A value of one indicates that the object is fully occluded. Units are dimensionless.

Example: 0.2

Data Types: double

DetectionProbability — Probability of detection

0.9 (default) | positive real scalar less than or equal to 1

Probability of detecting a target, specified as a positive real scalar less than or equal to 1. This quantity defines the probability that the sensor detects a detectable object. A detectable object is an object that satisfies the minimum detectable size, maximum range, maximum speed, and maximum allowed occlusion constraints.

Example: 0.95

Data Types: double

FalsePositivesPerImage — Number of false detections per image

0.1 (default) | nonnegative real scalar

Number of false detections that the vision sensor generates for each image, specified as a nonnegative real scalar.

Example: 2

Data Types: `double`

MinObjectImageSize — Minimum image size of detectable object

[15 15] (default) | 1-by-2 vector of positive values

Minimum height and width of an object that the vision sensor detects within an image, specified as a [minHeight,minWidth] vector of positive values. The 2-D projected height of an object must be greater than or equal to minHeight. The projected width of an object must be greater than or equal to minWidth. Units are in pixels.

Example: [30 20]

Data Types: `double`

BoundingBoxAccuracy — Bounding box accuracy

5 (default) | positive real scalar

Bounding box accuracy, specified as a positive real scalar. This quantity defines the accuracy with which the detector can match a bounding box to a target. Units are in pixels.

Example: 4

Data Types: `double`

ProcessNoiseIntensity — Noise intensity used for filtering position and velocity measurements

5 (default) | positive real scalar

Noise intensity used for filtering position and velocity measurements, specified as a positive real scalar. Noise intensity defines the standard deviation of the process noise of the internal constant-velocity Kalman filter used in a vision sensor. The filter models the process noise using a piecewise-constant white noise acceleration model. Noise intensity is typically of the order of the maximum acceleration magnitude expected for a target. Units are in m/s².

Example: 2.5

Data Types: `double`

HasNoise — Enable adding noise to vision sensor measurements

`true` (default) | `false`

Enable adding noise to vision sensor measurements, specified as `true` or `false`. Set this property to `true` to add noise to the sensor measurements. Otherwise, the measurements have no noise. Even if you set `HasNoise` to `false`, the object still computes the `MeasurementNoise` property of each detection.

Data Types: `logical`

MaxNumDetectionsSource — Source of maximum number of detections reported

'Auto' (default) | 'Property'

Source of maximum number of detections reported by the sensor, specified as 'Auto' or 'Property'. When this property is set to 'Auto', the sensor reports all detections. When this

property is set to 'Property', the sensor reports no more than the number of detections specified by the `MaxNumDetections` property.

Data Types: `char` | `string`

MaxNumDetections — Maximum number of reported detections

50 (default) | positive integer

Maximum number of detections reported by the sensor, specified as a positive integer. The detections closest to the sensor are reported.

Dependencies

To enable this property, set the `MaxNumDetectionsSource` property to 'Property'.

Data Types: `double`

DetectionCoordinates — Coordinate system of reported detections

'Ego Cartesian' (default) | 'Sensor Cartesian'

Coordinate system of reported detections, specified as one of these values:

- 'Ego Cartesian' — Detections are reported in the ego vehicle Cartesian coordinate system.
- 'Sensor Cartesian' — Detections are reported in the sensor Cartesian coordinate system.

Data Types: `char` | `string`

LaneUpdateInterval — Required time interval between lane detection updates

0.1 (default) | positive real scalar

Required time interval between lane detection updates, specified as a positive real scalar. The `drivingScenario` object calls the vision detection generator at regular time intervals. The vision detector generates new lane detections at intervals defined by this property which must be an integer multiple of the simulation time interval. Updates requested from the sensor between update intervals contain no lane detections. Units are in seconds.

Example: 0.4

Data Types: `double`

MinLaneImageSize — Minimum lane size in image

[20 5] (default) | 1-by-2 real-valued vector

Minimum size of a projected lane marking that can be detected by the sensor after accounting for curvature, specified as a 1-by-2 real-valued vector, [`minHeight` `minWidth`]. Lane markings must exceed both of these values to be detected. This property is used only when detecting lanes. Units are in pixels.

Example: [5,7]

Data Types: `double`

LaneBoundaryAccuracy — Accuracy of lane boundaries

3 | positive real scalar

Accuracy of lane boundaries, specified as a positive real scalar. This property defines the accuracy with which the lane sensor can place a lane boundary. Units are in pixels. This property is used only when detecting lanes.

MaxNumLanesSource — Source of maximum number of reported lanes

'Property' (default) | 'Auto'

Source of maximum number of reported lanes, specified as 'Auto' or 'Property'. When specified as 'Auto', the maximum number of lanes is computed automatically. When specified as 'Property', use the MaxNumLanes property to set the maximum number of lanes.

Data Types: char | string

MaxNumLanes — Maximum number of reported lanes

30 (default) | positive integer

Maximum number of reported lanes, specified as a positive integer.

Dependencies

To enable this property, set the MaxNumLanesSource property to 'Property'.

Data Types: char | string

ActorProfiles — Actor profiles

structure | array of structures

Actor profiles, specified as a structure or as an array of structures. Each structure contains the physical and radar characteristics of an actor.

- If ActorProfiles is a single structure, all actors passed into the visionDetectionGenerator object use this profile.
- If ActorProfiles is an array, each actor passed into the object must have a unique actor profile.

To generate an array of structures for your driving scenario, use the actorProfiles function. The table shows the valid structure fields. If you do not specify a field, that field is set to its default value. If no actors are passed into the object, then the ActorID field is not included.

Field	Description
ActorID	Scenario-defined actor identifier, specified as a positive integer.
ClassID	Classification identifier, specified as a nonnegative integer. 0 is reserved for an object of an unknown or unassigned class.
Length	Length of actor, specified as a positive real scalar. The default is 4.7. Units are in meters.
Width	Width of actor, specified as a positive real scalar. The default is 1.8. Units are in meters.
Height	Height of actor, specified as a positive real scalar. The default is 1.4. Units are in meters.

Field	Description
OriginOffset	Offset of the rotational center of the actor from its geometric center, specified as an [x y z] real-valued vector. The rotational center, or origin, is located at the bottom center of the actor. For vehicles, the rotational center is the point on the ground beneath the center of the rear axle. The default is [0 0 0]. Units are in meters.
RCSPattern	Radar cross-section pattern of actor, specified as a numel(RCSElevationAngles)-by-numel(RCSAzimuthAngles) real-valued matrix. The default is [10 10; 10 10]. Units are in decibels per square meter.
RCSAzimuthAngles	Azimuth angles corresponding to rows of RCSPattern, specified as a vector of real values in the range [-180, 180]. The default is [-180 180]. Units are in degrees.
RCSElevationAngles	Elevation angles corresponding to rows of RCSPattern, specified as a vector of real values in the range [-90, 90]. The default is [-90 90]. Units are in degrees.

For full definitions of the structure fields, see the `actor` and `vehicle` functions.

Usage

Syntax

```
dets = sensor(actors,time)
lanedets = sensor(laneboundaries,time)
lanedets = sensor(actors,laneboundaries,time)
[ ___,numValidDets] = sensor( ___ )
[ ___,numValidDets,isValidTime] = sensor( ___ )
[dets,numValidDets,isValidTime,lanedets,numValidLaneDets,isValidLaneTime] =
sensor(actors,laneboundaries,time)
```

Description

`dets = sensor(actors,time)` creates visual detections, `dets`, from sensor measurements taken of `actors` at the current simulation time. The object can generate sensor detections for multiple actors simultaneously. Do not include the ego vehicle as one of the actors.

To enable this syntax, set `DetectionOutput` to 'Objects only'.

`lanedets = sensor(laneboundaries,time)` generates lane detections, `lanedets`, from lane boundary structures, `laneboundaries`.

To enable this syntax set `DetectionOutput` to 'Lanes only'. The lane detector generates lane boundaries at intervals specified by the `LaneUpdateInterval` property.

`lanedets = sensor(actors, laneboundaries, time)` generates lane detections, `lanedets`, from lane boundary structures, `laneboundaries`.

To enable this syntax, set `DetectionOutput` to 'Lanes with occlusion'. The lane detector generates lane boundaries at intervals specified by the `LaneUpdateInterval` property.

`[____, numValidDets] = sensor(____)` also returns the number of valid detections reported, `numValidDets`.

`[____, numValidDetsisValidTime] = sensor(____)` also returns a logical value, `isValidTime`, indicating that the `UpdateInterval` time to generate detections has elapsed.

`[dets, numValidDets, isValidTime, lanedets, numValidLaneDets, isValidLaneTime] = sensor(actors, laneboundaries, time)` returns both object detections, `dets`, and lane detections `lanedets`. This syntax also returns the number of valid lane detections reported, `numValidLaneDets`, and a flag, `isValidLaneTime`, indicating whether the required simulation time to generate lane detections has elapsed.

To enable this syntax, set `DetectionOutput` to 'Lanes and objects'.

Input Arguments

actors — Scenario actor poses

structure | structure array

Scenario actor poses, specified as a structure or structure array. Each structure corresponds to an actor. You can generate this structure using the `actorPoses` function. You can also create these structures manually. The table shows the fields that the object uses to generate detections. All other fields are ignored.

Field	Description
ActorID	Scenario-defined actor identifier, specified as a positive integer.
Position	Position of actor, specified as a real-valued vector of the form $[x \ y \ z]$. Units are in meters.
Velocity	Velocity (v) of actor in the x - y -, and z -directions, specified as a real-valued vector of the form $[v_x \ v_y \ v_z]$. Units are in meters per second.
Roll	Roll angle of actor, specified as a real-valued scalar. Units are in degrees.
Pitch	Pitch angle of actor, specified as a real-valued scalar. Units are in degrees.
Yaw	Yaw angle of actor, specified as a real-valued scalar. Units are in degrees.
AngularVelocity	Angular velocity (ω) of actor in the x -, y -, and z -directions, specified as a real-valued vector of the form $[\omega_x \ \omega_y \ \omega_z]$. Units are in degrees per second.

For full definitions of the structure fields, see the `actor` and `vehicle` functions.

Dependencies

To enable this argument, set the `DetectorOutput` property to 'Objects only', 'Lanes with occlusion', or 'Lanes and objects'.

laneboundaries — Lane boundaries

array of lane boundary structures

Lane boundaries, specified as an array of lane boundary structures. The table shows the fields for each structure.

Field	Description
Coordinates	<p>Lane boundary coordinates, specified as a real-valued N-by-3 matrix, where N is the number of lane boundary coordinates. Lane boundary coordinates define the position of points on the boundary at specified longitudinal distances away from the ego vehicle, along the center of the road.</p> <ul style="list-style-type: none"> In MATLAB, specify these distances by using the 'XDistance' name-value pair argument of the <code>laneBoundaries</code> function. In Simulink, specify these distances by using the Distances from ego vehicle for computing boundaries (m) parameter of the Scenario Reader block or the Distance from parent for computing lane boundaries parameter of the Simulation 3D Vision Detection Generator block. <p>This matrix also includes the boundary coordinates at zero distance from the ego vehicle. These coordinates are to the left and right of the ego-vehicle origin, which is located under the center of the rear axle. Units are in meters.</p>
Curvature	<p>Lane boundary curvature at each row of the <code>Coordinates</code> matrix, specified as a real-valued N-by-1 vector. N is the number of lane boundary coordinates. Units are in radians per meter.</p>
CurvatureDerivative	<p>Derivative of lane boundary curvature at each row of the <code>Coordinates</code> matrix, specified as a real-valued N-by-1 vector. N is the number of lane boundary coordinates. Units are in radians per square meter.</p>
HeadingAngle	<p>Initial lane boundary heading angle, specified as a real scalar. The heading angle of the lane boundary is relative to the ego vehicle heading. Units are in degrees.</p>

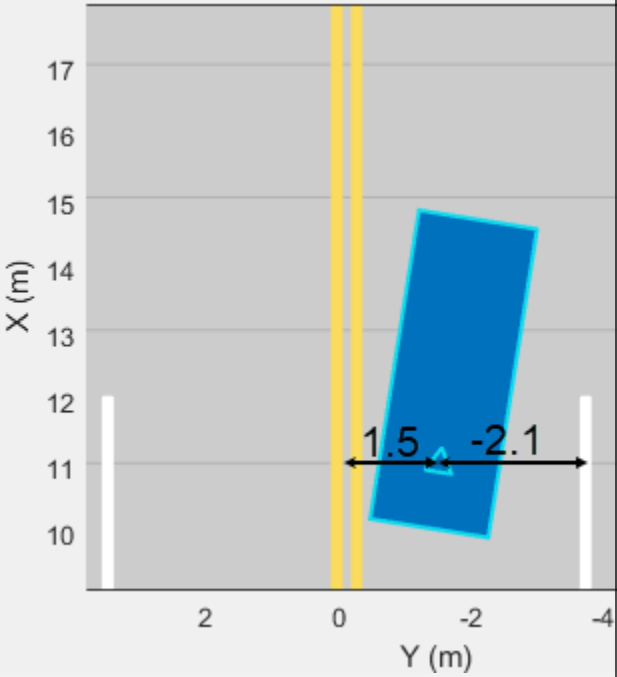
LateralOffset	<p>Lateral offset of the ego vehicle position from the lane boundary, specified as a real scalar. An offset to a lane boundary to the left of the ego vehicle is positive. An offset to the right of the ego vehicle is negative. Units are in meters. In this image, the ego vehicle is offset 1.5 meters from the left lane and 2.1 meters from the right lane.</p> 
BoundaryType	<p>Type of lane boundary marking, specified as one of these values:</p> <ul style="list-style-type: none"> • 'Unmarked' — No physical lane marker exists • 'Solid' — Single unbroken line • 'Dashed' — Single line of dashed lane markers • 'DoubleSolid' — Two unbroken lines • 'DoubleDashed' — Two dashed lines • 'SolidDashed' — Solid line on the left and a dashed line on the right • 'DashedSolid' — Dashed line on the left and a solid line on the right

Strength	Saturation strength of the lane boundary marking, specified as a real scalar from 0 to 1. A value of 0 corresponds to a marking whose color is fully unsaturated. The marking is gray. A value of 1 corresponds to a marking whose color is fully saturated.
Width	Lane boundary width, specified as a positive real scalar. In a double-line lane marker, the same width is used for both lines and for the space between lines. Units are in meters.
Length	Length of dash in dashed lines, specified as a positive real scalar. In a double-line lane marker, the same length is used for both lines.
Space	Length of space between dashes in dashed lines, specified as a positive real scalar. In a dashed double-line lane marker, the same space is used for both lines.

Dependencies

To enable this argument, set the `DetectorOutput` property to 'Lanes only', 'Lanes with occlusion', or 'Lanes and objects'.

Data Types: `struct`

time — Current simulation time

positive real scalar

Current simulation time, specified as a positive real scalar. The `drivingScenario` object calls the vision detection generator at regular time intervals. The vision detector generates new detections at intervals defined by the `UpdateInterval` property. The values of the `UpdateInterval` and `LanesUpdateInterval` properties must be an integer multiple of the simulation time interval. Updates requested from the sensor between update intervals contain no detections. Units are in seconds.

Example: 10.5

Data Types: `double`

Output Arguments

dets — Object detections

cell array of `objectDetection` objects

Object detections, returned as a cell array of `objectDetection` objects. Each object contains these fields:

Property	Definition
Time	Measurement time
Measurement	Object measurements
MeasurementNoise	Measurement noise covariance matrix

Property	Definition
SensorIndex	Unique ID of the sensor
ObjectClassID	Object classification
MeasurementParameters	Parameters used by initialization functions of nonlinear Kalman tracking filters
ObjectAttributes	Additional information passed to tracker

Measurement, MeasurementNoise, and MeasurementParameters are reported in the coordinate system specified by the DetectionCoordinates property of the visionDetectionGenerator.

Measurement

DetectionCoordinates Property	Measurement and Measurement Noise Coordinates
'Ego Cartesian'	[x;y;z;vx;vy;vz]
'Sensor Cartesian'	

MeasurementParameters

Parameter	Definition
Frame	Enumerated type indicating the frame used to report measurements. When Frame is set to 'rectangular', detections are reported in Cartesian coordinates. When Frame is set 'spherical', detections are reported in spherical coordinates.
OriginPosition	3-D vector offset of the sensor origin from the ego vehicle origin. The vector is derived from the SensorLocation and Height properties specified in the visionDetectionGenerator.
Orientation	Orientation of the vision sensor coordinate system with respect to the ego vehicle coordinate system. The orientation is derived from the Yaw, Pitch, and Roll properties of the visionDetectionGenerator.
HasVelocity	Indicates whether measurements contain velocity or range rate components.

ObjectAttributes

Attribute	Definition
TargetIndex	Identifier of the actor, ActorID, that generated the detection. For false alarms, this value is negative.

numValidDets – Number of detections

nonnegative integer

Number of detections returned, defined as a nonnegative integer.

- When the `MaxNumDetectionsSource` property is set to 'Auto', `numValidDets` is set to the length of `dets`.
- When the `MaxNumDetectionsSource` is set to 'Property', `dets` is a cell array with length determined by the `MaxNumDetections` property. No more than `MaxNumDetections` number of detections are returned. If the number of detections is fewer than `MaxNumDetections`, the first `numValidDets` elements of `dets` hold valid detections. The remaining elements of `dets` are set to the default value.

Data Types: `double`

isValidTime – Valid detection time

0 | 1

Valid detection time, returned as 0 or 1. `isValidTime` is 0 when detection updates are requested at times that are between update intervals specified by `UpdateInterval`.

Data Types: `logical`

lanedets – Lane boundary detections

lane boundary detection structure

Lane boundary detections, returned as an array structures. The fields of the structure are:

Lane Boundary Detection Structure

Field	Description
Time	Lane detection time
SensorIndex	Unique identifier of sensor
LaneBoundaries	Array of <code>clothoidLaneBoundary</code> objects.

numValidLaneDets – Number of detections

nonnegative integer

Number of lane detections returned, defined as a nonnegative integer.

- When the `MaxNumLanesSource` property is set to 'Auto', `numValidLaneDets` is set to the length of `lanedets`.
- When the `MaxNumLanesSource` is set to 'Property', `lanedets` is a cell array with length determined by the `MaxNumLanes` property. No more than `MaxNumLanes` number of lane detections are returned. If the number of detections is fewer than `MaxNumLanes`, the first `numValidLaneDetections` elements of `lanedets` hold valid lane detections. The remaining elements of `lanedets` are set to the default value.

Data Types: `double`

isValidLaneTime – Valid lane detection time

0 | 1

Valid lane detection time, returned as 0 or 1. `isValidLaneTime` is 0 when lane detection updates are requested at times that are between update intervals specified by `LaneUpdateInterval`.

Data Types: `logical`

Object Functions

To use an object function, specify the System object as the first input argument. For example, to release system resources of a System object named `obj`, use this syntax:

```
release(obj)
```

Specific to visionDetectionGenerator

`isLocked` Determine if System object is in use

Common to All System Objects

`step` Run System object algorithm

`release` Release resources and allow changes to System object property values and input characteristics

`reset` Reset internal states of System object

Examples

Generate Visual Detections of Multiple Vehicles

Generate detections using a forward-facing automotive vision sensor mounted on an ego vehicle. Assume that there are two target vehicles:

- Vehicle 1 is directly in front of the ego vehicle and moving at the same speed.
- Vehicle 2 vehicle is driving faster than the ego vehicle by 12 kph in the left lane.

All positions, velocities, and measurements are relative to the ego vehicle. Run the simulation for ten steps.

```
dt = 0.1;
car1 = struct('ActorID',1,'Position',[100 0 0],'Velocity',[5*1000/3600 0 0]);
car2 = struct('ActorID',2,'Position',[150 10 0],'Velocity',[12*1000/3600 0 0]);
```

Create an automotive vision sensor having a location offset from the ego vehicle. By default, the sensor location is at (3.4,0) meters from the vehicle center and 1.1 meters above the ground plane.

```
sensor = visionDetectionGenerator('DetectionProbability',1, ...
    'MinObjectImageSize',[5 5],'MaxRange',200,'DetectionCoordinates','Sensor Cartesian');
tracker = multiObjectTracker('FilterInitializationFcn',@initcvkf, ...
    'ConfirmationParameters',[3 4],'NumCoastingUpdates',6);
```

Generate visual detections for the non-ego actors as they move. The output detections form a cell array. Extract only position information from the detections to pass to the `multiObjectTracker`, which expects only position information. Then update the tracker for each new set of detections.

```
simTime = 0;
nsteps = 10;
for k = 1:nsteps
    dets = sensor([car1 car2],simTime);
    n = size(dets,1);
```

```

for k = 1:n
    meas = dets{k}.Measurement(1:3);
    dets{k}.Measurement = meas;
    measmtx = dets{k}.MeasurementNoise(1:3,1:3);
    dets{k}.MeasurementNoise = measmtx;
end
[confirmedTracks,tentativeTracks,allTracks] = updateTracks(tracker,dets,simTime);
simTime = simTime + dt;
car1.Position = car1.Position + dt*car1.Velocity;
car2.Position = car2.Position + dt*car2.Velocity;
end

```

Use `birdsEyePlot` to create an overhead view of the detections. Plot the sensor coverage area. Extract the x and y positions of the targets by converting the `Measurement` fields of the cell into a MATLAB® array. Then, plot the detections using `birdsEyePlot` functions.

```

BEplot = birdsEyePlot('XLim',[0 220],'YLim',[-75 75]);
caPlotter = coverageAreaPlotter(BEplot,'DisplayName','Vision Coverage Area');
plotCoverageArea(caPlotter,sensor.SensorLocation,sensor.MaxRange, ...
    sensor.Yaw,sensor.FieldOfView(1))
detPlotter = detectionPlotter(BEplot,'DisplayName','Vision Detections');
detPos = cellfun(@(d)d.Measurement(1:2),dets,'UniformOutput',false);
detPos = cell2mat(detPos)';
if ~isempty(detPos)
    plotDetection(detPlotter,detPos)
end

```

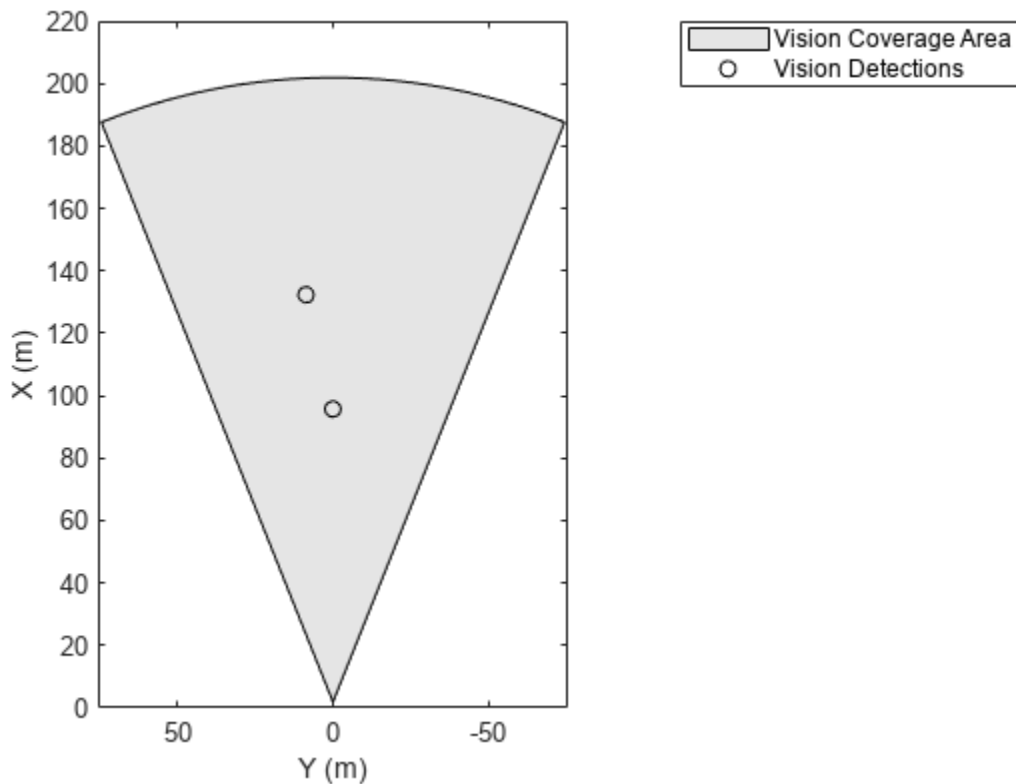

Generate Visual Detections from Monocular Camera

Create a vision sensor by using a monocular camera configuration, and generate detections from that sensor.

Specify the intrinsic parameters of the camera and create a `monoCamera` object from these parameters. The camera is mounted on top of an ego vehicle at a height of 1.5 meters above the ground and a pitch of 1 degree toward the ground.

```
focalLength = [800 800];
principalPoint = [320 240];
imageSize = [480 640];
intrinsics = cameraIntrinsics(focalLength,principalPoint,imageSize);

height = 1.5;
pitch = 1;
monoCamConfig = monoCamera(intrinsics,height,'Pitch',pitch);
```

Create a vision detection generator using the monocular camera configuration.

```
visionSensor = visionDetectionGenerator(monoCamConfig);
```

Generate a driving scenario with an ego vehicle and two target cars. Position the first target car 30 meters directly in front of the ego vehicle. Position the second target car 20 meters in front of the ego vehicle but offset to the left by 3 meters.

```
scenario = drivingScenario;
egoVehicle = vehicle(scenario,'ClassID',1);
targetCar1 = vehicle(scenario,'ClassID',1,'Position',[30 0 0]);
targetCar2 = vehicle(scenario,'ClassID',1,'Position',[20 3 0]);
```

Use a bird's-eye plot to display the vehicle outlines and sensor coverage area.

```
figure
bep = birdsEyePlot('XLim',[0 50],'YLim',[-20 20]);

olPlotter = outlinePlotter(bep);
[position,yaw,length,width,originOffset,color] = targetOutlines(egoVehicle);
plotOutline(olPlotter,position,yaw,length,width);

caPlotter = coverageAreaPlotter(bep,'DisplayName','Coverage area','FaceColor','blue');
plotCoverageArea(caPlotter,visionSensor.SensorLocation,visionSensor.MaxRange, ...
    visionSensor.Yaw,visionSensor.FieldOfView(1))
```

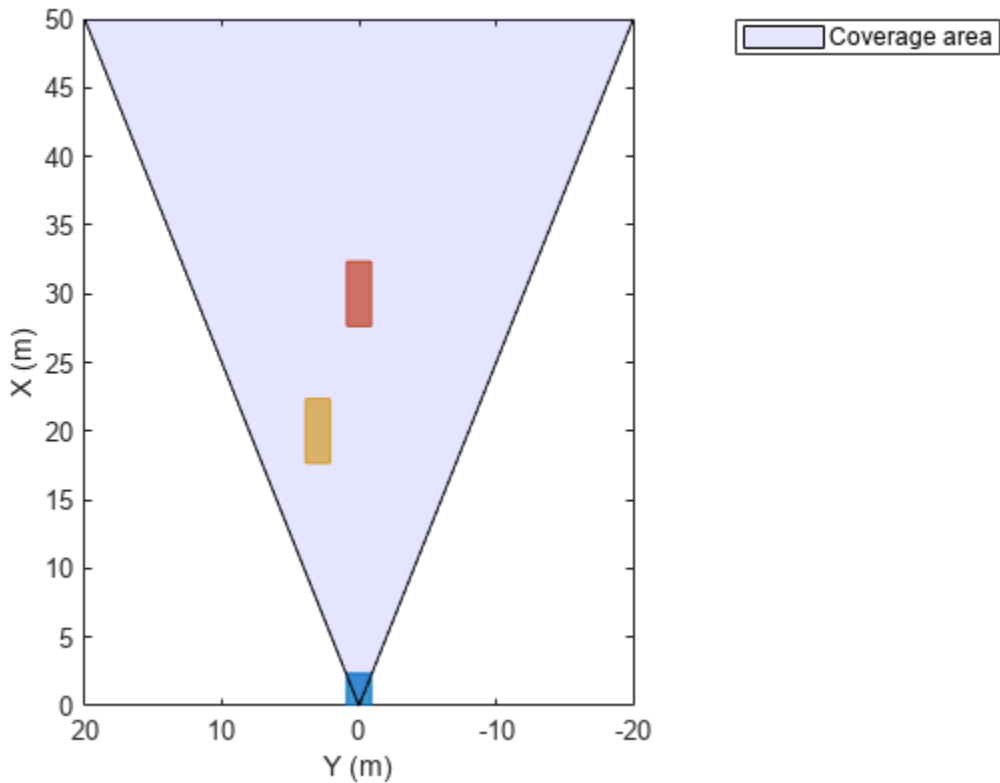

Obtain the poses of the target cars from the perspective of the ego vehicle. Use these poses to generate detections from the sensor.

```
poses = targetPoses(egoVehicle);
[dets,numValidDets] = visionSensor(poses,scenario.SimulationTime);
```

Display the (X,Y) positions of the valid detections. For each detection, the (X,Y) positions are the first two values of the Measurement field.

```
for i = 1:numValidDets
    XY = dets{i}.Measurement(1:2);
    detXY = sprintf('Detection %d: X = %.2f meters, Y = %.2f meters',i,XY);
    disp(detXY)
end
```

```
Detection 1: X = 19.09 meters, Y = 2.79 meters
Detection 2: X = 27.81 meters, Y = 0.08 meters
```

Generate Object and Lane Boundary Detections

Create a driving scenario containing an ego vehicle and a target vehicle traveling along a three-lane road. Detect the lane boundaries by using a vision detection generator.

```
scenario = drivingScenario;
```

Create a three-lane road by using lane specifications.

```
roadCenters = [0 0 0; 60 0 0; 120 30 0];
lspc = lanespec(3);
road(scenario,roadCenters,'Lanes',lspc);
```

Specify that the ego vehicle follows the center lane at 30 m/s.

```
egovehicle = vehicle(scenario,'ClassID',1);
egopath = [1.5 0 0; 60 0 0; 111 25 0];
egospeed = 30;
smoothTrajectory(egovehicle,egopath,egospeed);
```

Specify that the target vehicle travels ahead of the ego vehicle at 40 m/s and changes lanes close to the ego vehicle.

```
targetcar = vehicle(scenario,'ClassID',1);
targetpath = [8 2; 60 -3.2; 120 33];
targetspeed = 40;
smoothTrajectory(targetcar,targetpath,targetspeed);
```

Display a chase plot for a 3-D view of the scenario from behind the ego vehicle.

```
chasePlot(egovehicle)
```

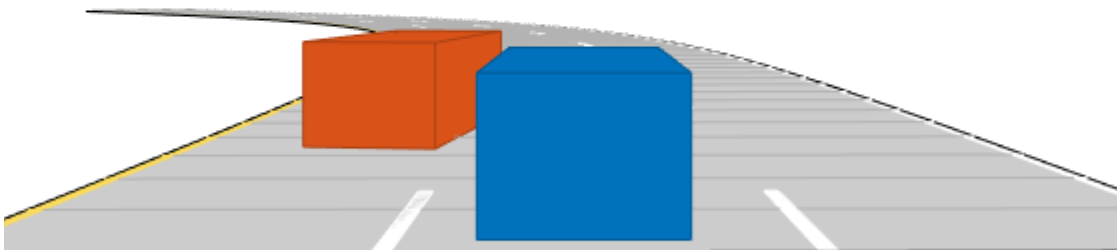

Create a vision detection generator that detects lanes and objects. The pitch of the sensor points one degree downward.

```

visionSensor = visionDetectionGenerator('Pitch',1.0);
visionSensor.DetectorOutput = 'Lanes and objects';
visionSensor.ActorProfiles = actorProfiles(scenario);

```

Run the simulation.

- 1 Create a bird's-eye plot and the associated plotters.
- 2 Display the sensor coverage area.
- 3 Display the lane markings.
- 4 Obtain ground truth poses of targets on the road.
- 5 Obtain ideal lane boundary points up to 60 m ahead.
- 6 Generate detections from the ideal target poses and lane boundaries.
- 7 Display the outline of the target.
- 8 Display object detections when the object detection is valid.
- 9 Display the lane boundary when the lane detection is valid.

```

bep = birdsEyePlot('XLim',[0 60],'YLim',[-35 35]);
caPlotter = coverageAreaPlotter(bep,'DisplayName','Coverage area', ...
    'FaceColor','blue');
detPlotter = detectionPlotter(bep,'DisplayName','Object detections');
lmPlotter = laneMarkingPlotter(bep,'DisplayName','Lane markings');
lbPlotter = laneBoundaryPlotter(bep,'DisplayName', ...
    'Lane boundary detections','Color','red');
olPlotter = outlinePlotter(bep);
plotCoverageArea(caPlotter,visionSensor.SensorLocation,...
    visionSensor.MaxRange,visionSensor.Yaw, ...
    visionSensor.FieldOfView(1));
while advance(scenario)
    [lmv,lmf] = laneMarkingVertices(egovehicle);
    plotLaneMarking(lmPlotter,lmv,lmf)
    tgtpose = targetPoses(egovehicle);
    lookaheadDistance = 0:0.5:60;
    lb = laneBoundaries(egovehicle,'XDistance',lookaheadDistance,'LocationType','inner');
    [obdets,nobdets,obValid,lb_dets,nlb_dets,lbValid] = ...
        visionSensor(tgtpose,lb,scenario.SimulationTime);
    [objposition,objyaw,objlength,objwidth,objoriginOffset,color] = targetOutlines(egovehicle);
    plotOutline(olPlotter,objposition,objyaw,objlength,objwidth, ...
        'OriginOffset',objoriginOffset,'Color',color)
    if obValid
        detPos = cellfun(@(d)d.Measurement(1:2),obdets,'UniformOutput',false);
        detPos = vertcat(zeros(0,2),cell2mat(detPos)');
        plotDetection(detPlotter,detPos)
    end
    if lbValid
        plotLaneBoundary(lbPlotter,vertcat(lb_dets.LaneBoundaries))
    end
end

```

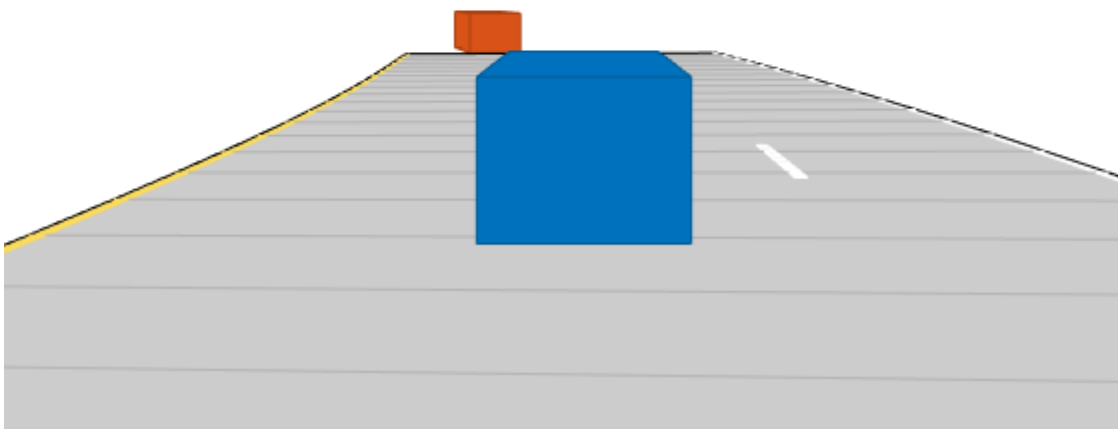

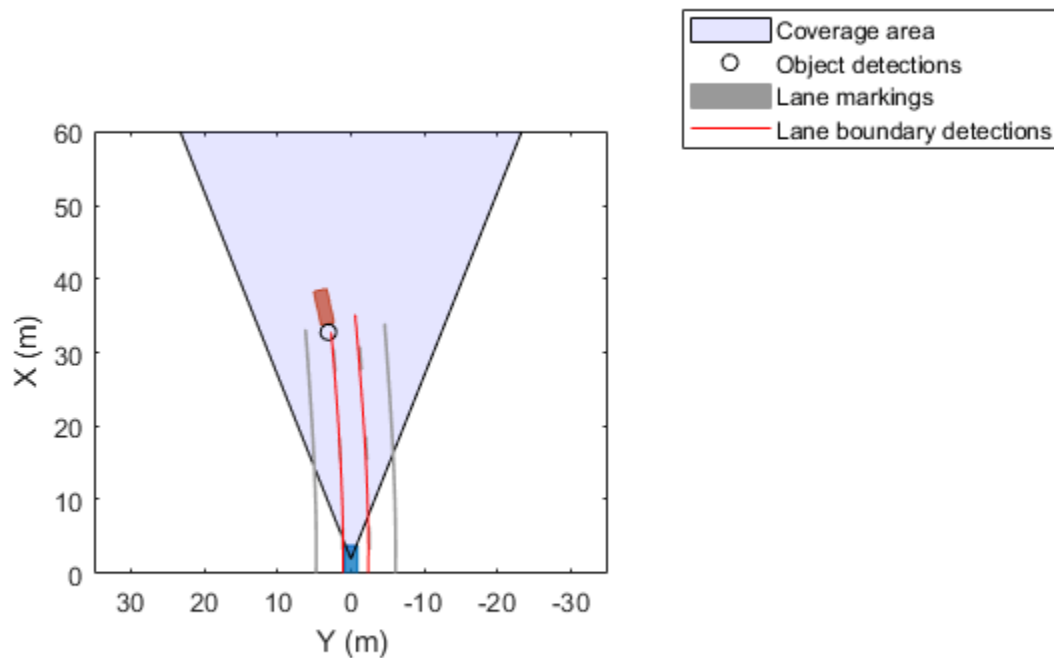

Configure Ideal Vision Sensor

Generate detections from an ideal vision sensor and compare these detections to ones from a noisy sensor. An *ideal sensor* is one that always generates detections, with no false positives and no added random noise.

Create a Driving Scenario

Create a driving scenario in which the ego vehicle is positioned in front of a diagonal array of target cars. With this configuration, you can later plot the measurement noise covariances of the detected targets without having the target cars occlude one another.

```
scenario = drivingScenario;
egoVehicle = vehicle(scenario, 'ClassID', 1);

numTgts = 6;
x = linspace(20, 50, numTgts)';
y = linspace(-20, 0, numTgts)';
x = [x; x(1:end-1)];
y = [y; -y(1:end-1)];
numTgts = numel(x);

for m = 1:numTgts
    vehicle(scenario, 'ClassID', 1, 'Position', [x(m) y(m) 0]);
end
```

Plot the driving scenario in a bird's-eye plot.

```
bep = birdsEyePlot('XLim',[0 60]);
legend('hide')

olPlotter = outlinePlotter(bep);
[position,yaw,length,width,originOffset,color] = targetOutlines(egoVehicle);
plotOutline(olPlotter,position,yaw,length,width, ...
    'OriginOffset',originOffset,'Color',color)
```

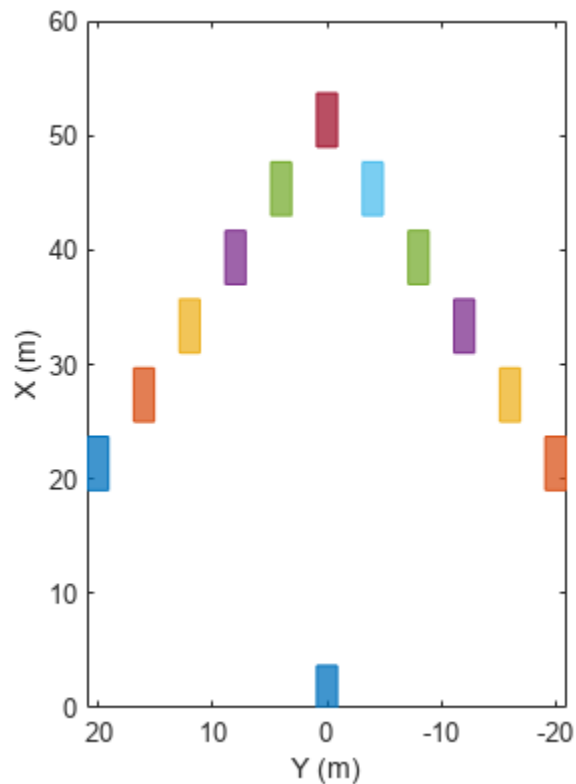

Create an Ideal Vision Sensor

Create a vision sensor by using the `visionDetectionGenerator System` object™. To generate ideal detections, set `DetectionProbability` to 1, `FalsePositivesPerImage` to 0, and `HasNoise` to false.

- `DetectionProbability = 1` — The sensor always generates detections for a target, as long as the target is not occluded and meets the range, speed, and image size constraints.
- `FalsePositivesPerImage = 0` — The sensor generates detections from only real targets in the driving scenario.
- `HasNoise = false` — The sensor does not add random noise to the reported position and velocity of the target. However, the `objectDetection` objects returned by the sensor have measurement noise values set to the noise variance that would have been added if `HasNoise` were true. With these noise values, you can process ideal detections using the `multiObjectTracker`. This technique is useful for analyzing maneuver lag without needing to run time-consuming Monte Carlo simulations.

```

idealSensor = visionDetectionGenerator( ...
    'SensorIndex',1, ...
    'UpdateInterval',scenario.SampleTime, ...
    'SensorLocation',[0.75*egoVehicle.Wheelbase 0], ...
    'Height',1.1, ...
    'Pitch',0, ...
    'Intrinsics',cameraIntrinsics(800,[320 240],[480 640]), ...
    'BoundingBoxAccuracy',50, ... % Make the noise large for illustrative purposes
    'ProcessNoiseIntensity',5, ...
    'MaxRange',60, ...
    'DetectionProbability',1, ...
    'FalsePositivesPerImage',0, ...
    'HasNoise',false, ...
    'ActorProfiles',actorProfiles(scenario))

```

```

idealSensor =
    visionDetectionGenerator with properties:

        SensorIndex: 1
        UpdateInterval: 0.0100

        SensorLocation: [2.1000 0]
            Height: 1.1000
            Yaw: 0
            Pitch: 0
            Roll: 0
        Intrinsics: [1x1 cameraIntrinsics]

        DetectorOutput: 'Objects only'
        FieldOfView: [43.6028 33.3985]
        MaxRange: 60
        MaxSpeed: 100
        MaxAllowedOcclusion: 0.5000
        MinObjectImageSize: [15 15]

        DetectionProbability: 1
        FalsePositivesPerImage: 0

```

Show all properties

Plot the coverage area of the ideal vision sensor.

```

legend('show')
caPlotter = coverageAreaPlotter(bep,'DisplayName','Coverage area','FaceColor','blue');
mountPosition = idealSensor.SensorLocation;
range = idealSensor.MaxRange;
orientation = idealSensor.Yaw;
fieldOfView = idealSensor.FieldOfView(1);
plotCoverageArea(caPlotter,mountPosition,range,orientation,fieldOfView);

```

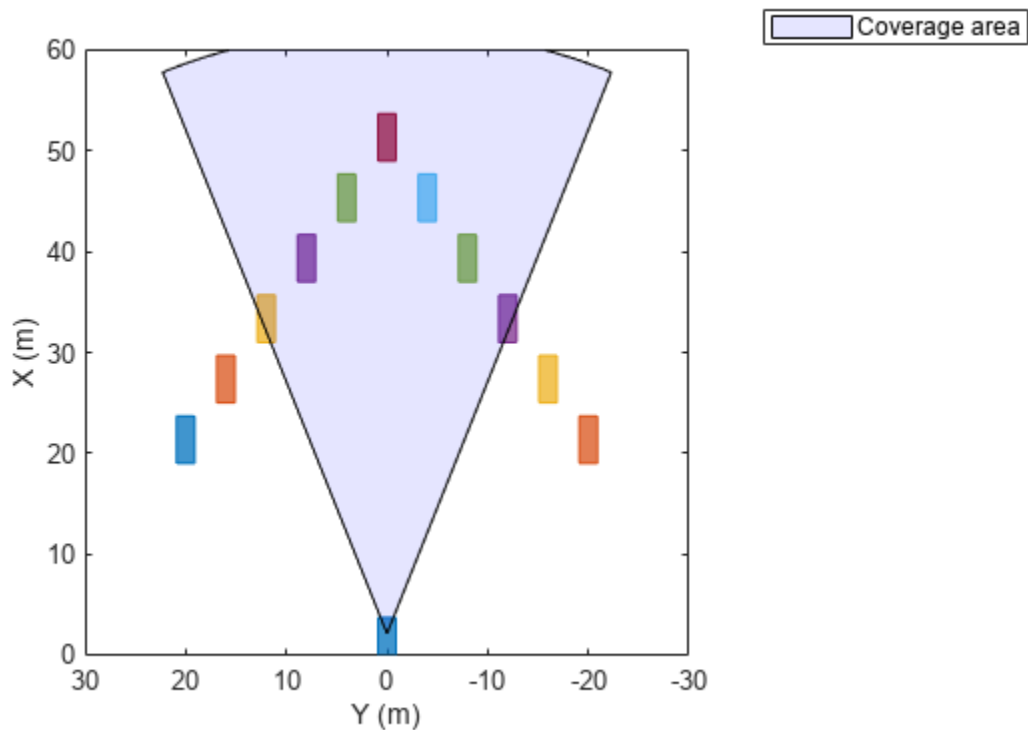

Simulate Ideal Vision Detections

Obtain the positions of the targets. The positions are in ego vehicle coordinates.

```
gTruth = targetPoses(egoVehicle);
```

Generate timestamped vision detections. These detections are returned as a cell array of `objectDetection` objects.

```
time = scenario.SimulationTime;
dets = idealSensor(gTruth,time);
```

Inspect the measurement and measurement noise variance of the first (leftmost) detection. Even though the detection is ideal and therefore has no added random noise, the `MeasurementNoise` property shows the values as if the detection did have noise.

```
dets{1}.Measurement
```

```
ans = 6×1
    31.0000
   -11.2237
         0
         0
         0
         0
```

```
dets{1}.MeasurementNoise
```

```
ans = 6×6
```

```

    1.5427    -0.5958         0         0         0         0
   -0.5958     0.2422         0         0         0         0
         0         0  100.0000         0         0         0
         0         0         0     0.5398    -0.1675         0
         0         0         0    -0.1675     0.1741         0
         0         0         0         0         0     100.0000

```

Plot the ideal detections and ellipses for the 2-sigma contour of the measurement noise covariance.

```

pos = cell2mat(cellfun(@(d)d.Measurement(1:2)',dets, ...
    'UniformOutput',false));
cov = reshape(cell2mat(cellfun(@(d)d.MeasurementNoise(1:2,1:2),dets, ...
    'UniformOutput',false))',2,2,[]);
plotter = trackPlotter(bep,'DisplayName','Ideal detections', ...
    'MarkerEdgeColor','blue','MarkerFaceColor','blue');
sigma = 2;
plotTrack(plotter,pos,sigma^2*cov)

```

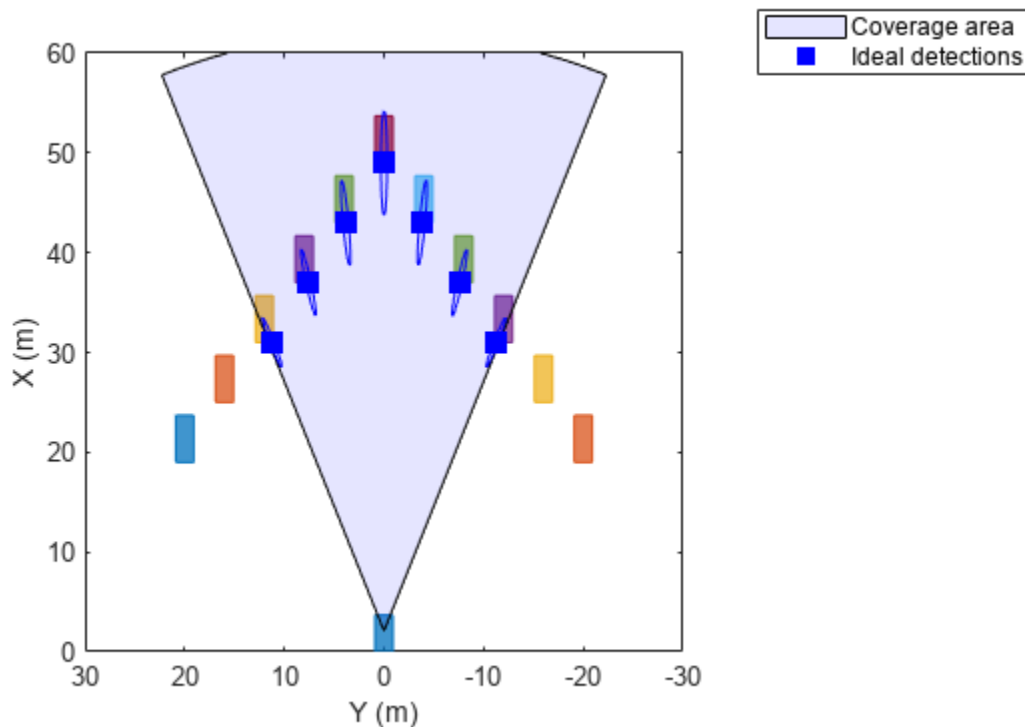

Simulate Noisy Detections for Comparison

Create a noisy sensor based on the properties of the ideal sensor.

```
noisySensor = clone(idealSensor);  
release(noisySensor)  
noisySensor.HasNoise = true;
```

Reset the driving scenario back to its original state.

```
restart(scenario)
```

Collect statistics from the noisy detections.

```
numMonte = 1e3;  
pos = [];  
for itr = 1:numMonte  
    time = scenario.SimulationTime;  
    dets = noisySensor(gTruth,time);  
  
    % Save noisy measurements  
    pos = [pos;cell2mat(cellfun(@(d)d.Measurement(1:2)',dets,'UniformOutput',false))];  
  
    advance(scenario);  
end
```

Plot the noisy detections.

```
plotter = detectionPlotter(bep,'DisplayName','Noisy detections', ...  
    'Marker','.', 'MarkerEdgeColor','red', 'MarkerFaceColor','red');  
plotDetection(plotter,pos)
```

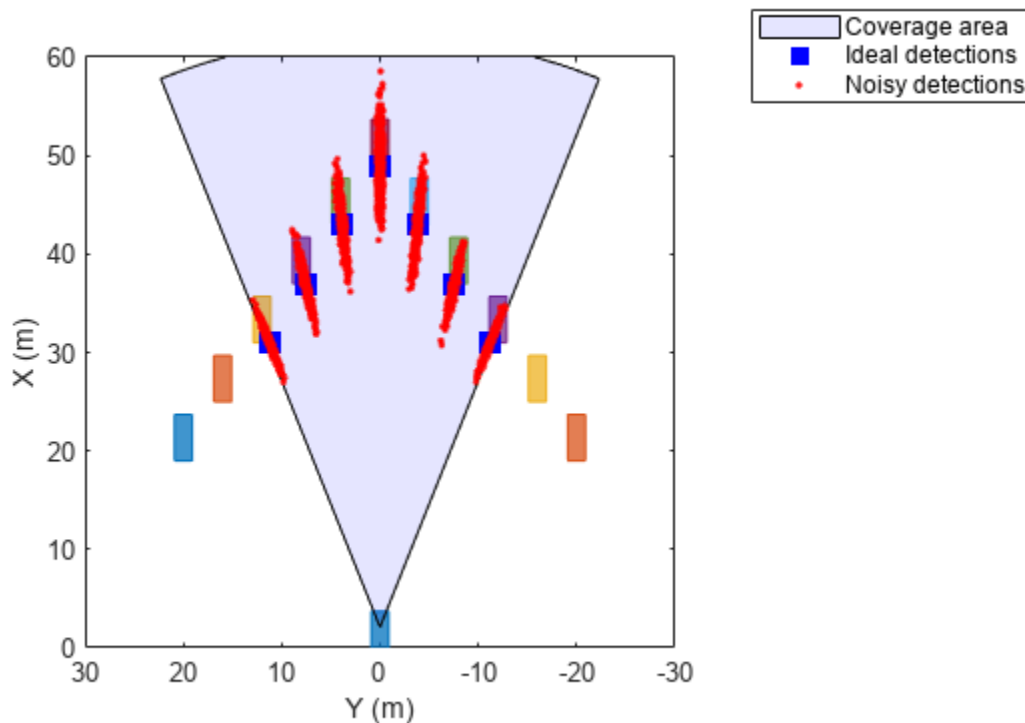

Algorithms

The vision sensor models a monocular camera that produces 2-D camera images. To project the coordinates of these 2-D images into the 3-D world coordinates used in driving scenarios, the sensor algorithm assumes that the z-position (height) of all image points of the bottom edge of the target's image bounding box lie on the ground. The plane defining the ground is defined by the height property of the vision detection generator, which defines the offset of the monocular camera above the ground plane. With this projection, the vertical locations of objects in the produced images are strongly correlated to their heights above the road. However, if the road is not flat and the heights of objects differ from the height of the sensor, then the sensor reports inaccurate detections. For an example that shows this behavior, see "Model Vision Sensor Detections".

Version History

Introduced in R2017a

Extended Capabilities

C/C++ Code Generation

Generate C and C++ code using MATLAB® Coder™.

Usage notes and limitations:

- For standalone deployment, the visionDetectionGenerator System object supports only Simulink Real-Time targets.
- See “System Objects in MATLAB Code Generation” (MATLAB Coder).

See Also

Objects

lidarPointCloudGenerator | objectDetection | drivingScenario | laneMarking | lanespec | monoCamera | multiObjectTracker | drivingRadarDataGenerator | insSensor

Functions

laneBoundaries | road | actorPoses | actorProfiles

Apps

Driving Scenario Designer

Topics

“Model Vision Sensor Detections”

“Coordinate Systems in Automated Driving Toolbox”

lidarPointCloudGenerator

Generate lidar point cloud data for driving scenario

Description

The `lidarPointCloudGenerator` System object generates detections from a lidar sensor mounted on an ego vehicle. All detections are referenced to the coordinate system of the ego vehicle or the vehicle-mounted sensor. You can use the `lidarPointCloudGenerator` object in a scenario containing actors and trajectories, which you can create by using a `drivingScenario` object. Using a statistical sensor model, `lidarPointCloudGenerator` object can simulate real detections with added random noise.

To generate lidar point clouds:

- 1 Create the `lidarPointCloudGenerator` object and set its properties.
- 2 Call the object with arguments, as if it were a function.

To learn more about how System objects work, see [What Are System Objects?](#)

Creation

Syntax

```
lidar = lidarPointCloudGenerator  
lidar = lidarPointCloudGenerator(Name,Value)
```

Description

`lidar = lidarPointCloudGenerator` creates a `lidarPointCloudGenerator` object with default property values to generate a point cloud for a lidar sensor.

`lidar = lidarPointCloudGenerator(Name,Value)` sets properties on page 4-254 using one or more name-value pairs. For example, `lidarPointCloudGenerator('DetectionCoordinates','SensorCartesian','MaxRange',200)` creates a lidar point cloud generator that reports detections in the sensor Cartesian coordinate system and has a maximum detection range of 200 meters. Enclose each property name in quotes.

Properties

Unless otherwise indicated, properties are *nontunable*, which means you cannot change their values after calling the object. Objects lock when you call them, and the `release` function unlocks them.

If a property is *tunable*, you can change its value at any time.

For more information on changing property values, see [System Design in MATLAB Using System Objects](#).

SensorLocation — Sensor location

[1.5 0] (default) | [x y] vector

Location of the lidar sensor center, specified as a [x y] vector. The `SensorLocation` and `Height` properties define the coordinates of the lidar sensor with respect to the ego vehicle coordinate system. The default value corresponds to a lidar sensor mounted on a sedan, at the center of the roof's front edge. Units are in meters.

Example: [4 0.1]

Data Types: double

SensorIndex — Unique sensor identifier

1 (default) | positive integer

Unique sensor identifier, specified as a positive integer. This property distinguishes detections that come from different sensors in a multisensor system.

Example: 5

Data Types: double

UpdateInterval — Required time interval between sensor updates

0.1 (default) | positive real scalar

Required time interval between sensor updates, specified as a positive real scalar. The `drivingScenario` object calls the lidar point cloud generator at regular time intervals. `lidarPointCloudGenerator` object generates new detections at intervals defined by the `UpdateInterval` property. The value of the `UpdateInterval` property must be an integer multiple of the simulation time interval. Updates requested from the sensor between update intervals contain no detections. Units are in seconds.

Example: 5

Data Types: double

Height — Sensor height above ground plane

1.6 (default) | positive real scalar

Sensor height above the vehicle ground plane, specified as a positive real scalar. The default value corresponds to a lidar sensor mounted on a sedan, at the center of the roof's front edge. Units are in meters.

Example: 1.5

Data Types: double

Yaw — Yaw angle of lidar sensor

0 (default) | real scalar

Yaw angle of the lidar sensor, specified as a real scalar. The yaw angle is the angle between the center line of the ego vehicle and the downrange axis of the lidar sensor. A positive yaw angle corresponds to a clockwise rotation when looking in the positive direction of the z-axis of the ego vehicle coordinate system. Units are in degrees.

Example: -4

Data Types: double

Pitch — Pitch angle of lidar sensor

0 (default) | real scalar

Pitch angle of the lidar sensor, specified as a real scalar. The pitch angle is the angle between the downrange axis of the lidar sensor and the x-y plane of the ego vehicle coordinate system. A positive pitch angle corresponds to a clockwise rotation when looking in the positive direction of the y-axis of the ego vehicle coordinate system. Units are in degrees.

Example: 3

Data Types: double

Roll — Roll angle of lidar sensor

0 (default) | real scalar

Roll angle of the lidar sensor, specified as a real scalar. The roll angle is the angle of rotation of the downrange axis of the lidar sensor around the x-axis of the ego vehicle coordinate system. A positive roll angle corresponds to a clockwise rotation when looking in the positive direction of the x-axis of the coordinate system. Units are in degrees.

Example: -4

Data Types: double

MaxRange — Maximum detection range

120 (default) | positive real scalar

Maximum detection range, specified as a positive real scalar. The sensor cannot detect roads and actors beyond this range. Units are in meters.

Example: 200

Data Types: double

RangeAccuracy — Accuracy of range measurements

0.002 (default) | positive real scalar

Accuracy of range measurements, specified as a positive real scalar. Units are in meters.

Example: 0.01

Data Types: single | double

AzimuthResolution — Azimuth resolution of lidar

0.16 (default) | positive real scalar

Azimuth resolution of the lidar, specified as a positive real scalar. The azimuth resolution defines the minimum separation in azimuth angle at which the lidar can distinguish two targets. Units are in degrees.

Example: 0.5

Data Types: single | double

ElevationResolution — Elevation resolution of lidar

1.25 (default) | positive real scalar

Elevation resolution of the lidar, specified as a positive real scalar. The elevation resolution defines the minimum separation in elevation angle at which the lidar can distinguish two targets. Units are in degrees.

Example: 0.5

Data Types: single | double

AzimuthLimits — Azimuth limits of lidar

[-180 180] (default) | 1-by-2 real-valued vector

Azimuth limits of lidar, specified as a 1-by-2 real-valued vector of the form [min, max]. Units are in degrees.

Example: [-100 50]

Data Types: single | double

ElevationLimits — Elevation limits of lidar

[-20 20] (default) | 1-by-2 real-valued vector

Elevation limits of lidar, specified as a 1-by-2 real-valued vector of the form [min, max]. Units are in degrees.

Example: [-10 10]

Data Types: single | double

HasNoise — Enable adding noise to lidar sensor measurements

true (default) | false

Enable adding noise to lidar sensor measurements, specified as true or false. Set this property to true to add noise to the sensor measurements. Otherwise, the measurements have no noise.

Data Types: logical

HasOrganizedOutput — Output organized point cloud

true (default) | false

Output the generated data as an organized point cloud, specified as true or false. Set this property to true to output an organized point cloud. Otherwise, the output is unorganized.

Data Types: logical

HasEgoVehicle — Include ego vehicle in point cloud

true (default) | false

Include ego vehicle in the generated point cloud, specified as true or false. Set this property to true to include the ego vehicle in the output. Otherwise, the output point cloud has no ego vehicle.

Data Types: logical

HasRoadsInputPort — Include road mesh data in generated point cloud

true (default) | false

Include road mesh data in the generated point cloud, specified as true or false. Set this property to true to generate point cloud data from the input road mesh, rdMesh. Otherwise, the output point cloud has no road mesh data and you cannot specify rdMesh.

Data Types: logical

EgoVehicleActorID — ActorID of ego vehicle

1 (default) | positive integer

ActorID of ego vehicle, specified as a positive integer scalar. ActorID is the unique identifier for an actor.

Example: 4

Data Types: single | double

DetectionCoordinates — Coordinate system of reported detections

'Ego Cartesian' (default) | 'Sensor Cartesian'

Coordinate system of reported detections, specified as one of these values:

- 'Ego Cartesian' — Detections are reported in the ego vehicle Cartesian coordinate system.
- 'Sensor Cartesian' — Detections are reported in the sensor Cartesian coordinate system.

Data Types: char | string

ActorProfiles — Actor profiles

structure | array of structures

Actor profiles, specified as a structure or as an array of structures. Each structure contains the physical and radar characteristics of an actor.

- If ActorProfiles is a single structure, all actors passed into the lidarPointCloudGenerator object use this profile.
- If ActorProfiles is an array, each actor passed into the object must have a unique actor profile.

To generate an array of structures for your driving scenario, use the actorProfiles function. The table shows the valid structure fields. If you do not specify a field, the fields are set to their default values. If no actors are passed into the object, then the ActorID field is not included.

Field	Description
ActorID	Scenario-defined actor identifier, specified as a positive integer.
ClassID	Classification identifier, specified as a nonnegative integer. 0 represents an object of an unknown or unassigned class.
Length	Length of actor, specified as a positive real-valued scalar. Units are in meters.
Width	Width of actor, specified as a positive real-valued scalar. Units are in meters.
Height	Height of actor, specified as a positive real-valued scalar. Units are in meters.
OriginOffset	Offset of actor's rotational center from its geometric center, specified as a real-valued vector of the form $[x, y, z]$. The rotational center, or origin, is located at the bottom center of the actor. For vehicles, the rotational center is the point on the ground beneath the center of the rear axle. Units are in meters.

Field	Description
MeshVertices	Mesh vertices of actor, specified as an n -by-3 real-valued matrix of vertices. Each row in the matrix defines a point in 3-D space.
MeshFaces	Mesh faces of actor, specified as an m -by-3 matrix of integers. Each row of <code>MeshFaces</code> represents a triangle defined by the vertex IDs, which are the row numbers of vertices.
RCSPattern	Radar cross-section (RCS) pattern of actor, specified as a <code>numel(RCSElevationAngles)</code> -by- <code>numel(RCSAzimuthAngles)</code> real-valued matrix. Units are in decibels per square meter.
RCSAzimuthAngles	Azimuth angles corresponding to rows of <code>RCSPattern</code> , specified as a vector of values in the range $[-180, 180]$. Units are in degrees.
RCSElevationAngles	Elevation angles corresponding to rows of <code>RCSPattern</code> , specified as a vector of values in the range $[-90, 90]$. Units are in degrees.

For full definitions of the structure fields, see the `actor` and `vehicle` functions.

Usage

Syntax

```
ptCloud = lidar(actors,rdMesh,simTime)
[ptCloud,isValidTime] = lidar(actors,rdMesh,simTime)
[ptCloud,isValidTime,clusters] = lidar(actors,rdMesh,simTime)
[___] = lidar(actors,simTime)
```

Description

`ptCloud = lidar(actors,rdMesh,simTime)` creates a statistical sensor model to generate a lidar point cloud, `ptCloud`, from sensor measurements taken of actors, `actors`, at the current simulation time, `simTime`. An `extendedObjectMesh` object, `rdMesh`, contains road data around the ego vehicle.

`[ptCloud,isValidTime] = lidar(actors,rdMesh,simTime)` additionally returns `isValidTime`, which indicates whether the point cloud is generated at the specified simulation time.

`[ptCloud,isValidTime,clusters] = lidar(actors,rdMesh,simTime)` additionally returns `clusters`, which contains clusters the classification data of the generated point cloud.

`[___] = lidar(actors,simTime)` excludes road mesh data from the generated point cloud by disabling specification of the `rdMesh` input. Using this syntax, you can return any of the outputs described in the previous syntaxes.

To exclude road mesh data, set the `HasRoadsInputPort` property to `false`.

Input Arguments

actors — Scenario actor poses

structure | structure array

Scenario actor poses, specified as a structure or structure array. Each structure corresponds to an actor. You can generate this structure using the `actorPoses` function. You can also create these structures manually. The table shows the properties that the object uses to generate detections. All other actor properties are ignored.

Field	Description
ActorID	Scenario-defined actor identifier, specified as a positive integer.
Position	Position of actor, specified as a real-valued vector of the form $[x\ y\ z]$. Units are in meters.
Velocity	Velocity (v) of actor in the x - y -, and z -directions, specified as a real-valued vector of the form $[v_x\ v_y\ v_z]$. Units are in meters per second.
Roll	Roll angle of actor, specified as a real-valued scalar. Units are in degrees.
Pitch	Pitch angle of actor, specified as a real-valued scalar. Units are in degrees.
Yaw	Yaw angle of actor, specified as a real-valued scalar. Units are in degrees.
AngularVelocity	Angular velocity (ω) of actor in the x -, y -, and z -directions, specified as a real-valued vector of the form $[\omega_x\ \omega_y\ \omega_z]$. Units are in degrees per second.

For full definitions of the structure fields, see the `actor` and `vehicle` functions.

Data Types: `struct`

rdMesh — Mesh representation of roads near to actor

extendedObjectMesh object

Mesh representation of roads near to the actor, specified as an `extendedObjectMesh` object.

simTime — Current simulation time

positive real scalar

Current simulation time, specified as a positive real scalar. The `drivingScenario` object calls the lidar point cloud generator at regular time intervals to generate new point clouds at intervals defined by the `UpdateInterval` property. The value of the `UpdateInterval` property must be an integer multiple of the simulation time interval. Updates requested from the sensor between update intervals do not generate a point cloud. Units are in seconds.

Example: `10.5`

Data Types: `double`

Output Arguments

ptCloud — Point cloud data

pointCloud object

Point cloud data, returned as a pointCloud object.

isValidTime — Valid time to generate point cloud

0 | 1

Valid time to generate point cloud, returned as 0 or 1. isValidTime is 0 when updates are requested at times that are between update intervals specified by UpdateInterval.

Data Types: logical

clusters — Classification data of generated point cloud

N-by-2 vector

Classification data of the generated point cloud, returned as an *N*-by-2 vector. The vector defines the IDs of the target from which the point cloud was generated. *N* is equal to the Count property of the pointCloud object. The vector contains ActorID in the first column and ClassID in the second column.

Object Functions

To use an object function, specify the System object as the first input argument. For example, to release system resources of a System object named obj, use this syntax:

```
release(obj)
```

Specific to lidarPointCloudGenerator

isLocked Determine if System object is in use

Common to All System Objects

step Run System object algorithm

release Release resources and allow changes to System object property values and input characteristics

reset Reset internal states of System object

Examples

Generate Lidar Point Cloud Data of Multiple Actors

Generate lidar point cloud data for a driving scenario with multiple actors by using the lidarPointCloudGenerator System object. Create the driving scenario by using drivingScenario object. It contains an ego-vehicle, pedestrian and two other vehicles.

Create and plot a driving scenario with multiple vehicles

Create a driving scenario.

```
scenario = drivingScenario;
```

Add a straight road to the driving scenario. The road has one lane in each direction.

```
roadCenters = [0 0 0; 70 0 0];  
laneSpecification = lanespec([1 1]);  
road(scenario,roadCenters,'Lanes',laneSpecification);
```

Add an ego vehicle to the driving scenario.

```
egoVehicle = vehicle(scenario,'ClassID',1,'Mesh',driving.scenario.carMesh);  
waypoints = [1 -2 0; 35 -2 0];  
smoothTrajectory(egoVehicle,waypoints,10);
```

Add a truck, pedestrian, and bicycle to the driving scenario and plot the scenario.

```
truck = vehicle(scenario,'ClassID',2,'Length',8.2,'Width',2.5,'Height',3.5, ...  
    'Mesh',driving.scenario.truckMesh);  
waypoints = [70 1.7 0; 20 1.9 0];  
smoothTrajectory(truck,waypoints,15);  
  
pedestrian = actor(scenario,'ClassID',4,'Length',0.24,'Width',0.45,'Height',1.7, ...  
    'Mesh',driving.scenario.pedestrianMesh);  
waypoints = [23 -4 0; 10.4 -4 0];  
smoothTrajectory(pedestrian,waypoints,1.5);  
  
bicycle = actor(scenario,'ClassID',3,'Length',1.7,'Width',0.45,'Height',1.7, ...  
    'Mesh',driving.scenario.bicycleMesh);  
waypoints = [12.7 -3.3 0; 49.3 -3.3 0];  
smoothTrajectory(bicycle,waypoints,5);  
  
plot(scenario,'Meshes','on')
```

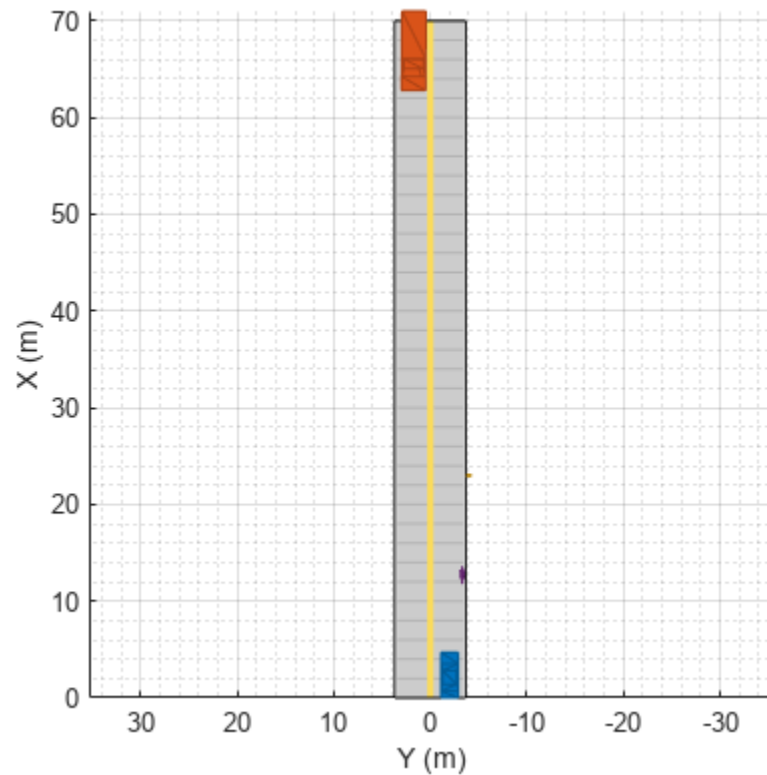
Generate and plot lidar point cloud data

Create a `lidarPointCloudGenerator` System object.

```
lidar = lidarPointCloudGenerator;
```

Add actor profiles and the ego vehicle actor ID from the driving scenario to the System object.

```
lidar.ActorProfiles = actorProfiles(scenario);
lidar.EgoVehicleActorID = egoVehicle.ActorID;
```

Plot the point cloud data.

```
bep = birdsEyePlot('Xlimits',[0 70],'Ylimits',[-30 30]);
plotter = pointCloudPlotter(bep);
legend('off');
while advance(scenario)
    tgts = targetPoses(egoVehicle);
    rdmesh = roadMesh(egoVehicle);
    [ptCloud,isValidTime] = lidar(tgts,rdmesh,scenario.SimulationTime);
    if isValidTime
        plotPointCloud(plotter,ptCloud);
    end
end
```

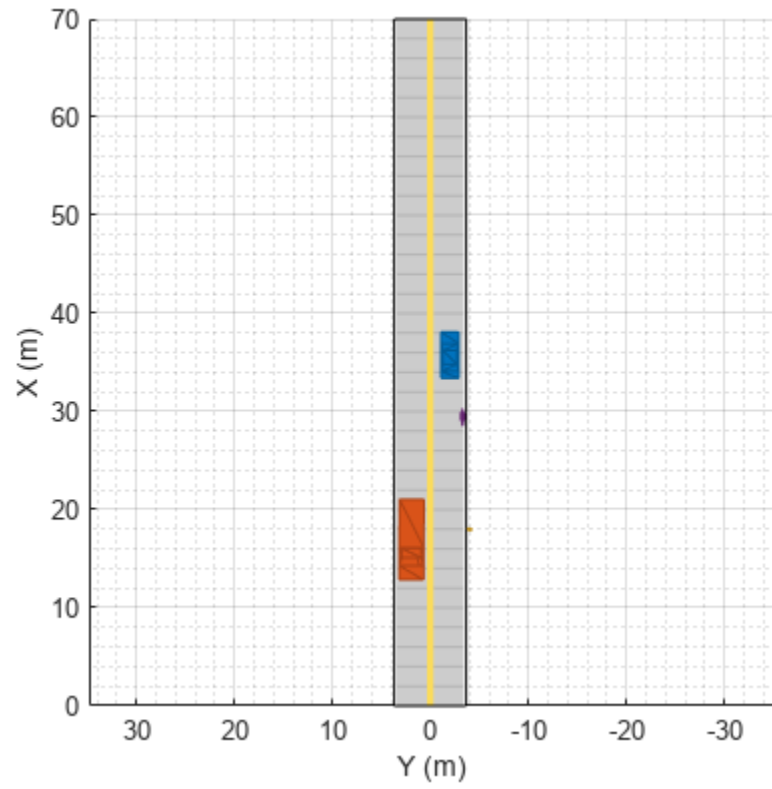

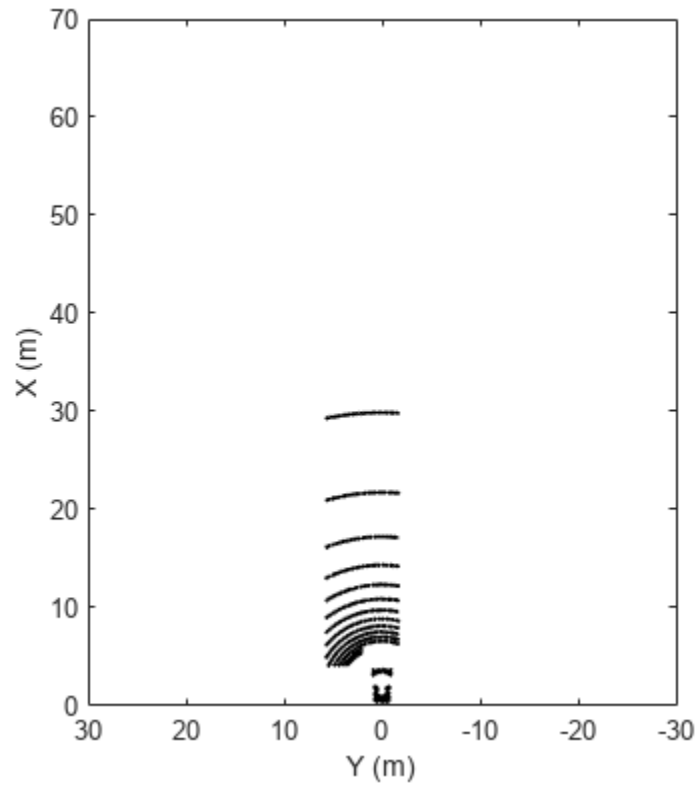

Version History

Introduced in R2020a

See Also

Objects

[objectDetection](#) | [drivingScenario](#) | [laneMarking](#) | [lanespec](#) | [monoCamera](#) | [multiObjectTracker](#) | [drivingRadarDataGenerator](#) | [visionDetectionGenerator](#) | [extendedObjectMesh](#) | [insSensor](#)

Functions

[laneBoundaries](#) | [road](#) | [actorPoses](#) | [actorProfiles](#) | [roadMesh](#)

Blocks

Lidar Point Cloud Generator

Apps

Driving Scenario Designer

Topics

“Track-Level Fusion of Radar and Lidar Data”
“Coordinate Systems in Automated Driving Toolbox”

roadMesh

Mesh representation of roads near actor

Syntax

```
rdMesh = roadMesh(ac)
mesh = roadMesh(ac,maxRadius)
```

Description

`rdMesh = roadMesh(ac)` creates a mesh representation of roads nearest to the specified actor `ac`. The function returns the mesh as an `extendedObjectMesh` object. By default, the function searches for roads within a 120 m radius of the input actor.

`mesh = roadMesh(ac,maxRadius)` specifies the maximum search radius.

Examples

Generate Lidar Point Cloud Data of Multiple Actors

Generate lidar point cloud data for a driving scenario with multiple actors by using the `lidarPointCloudGenerator` System object. Create the driving scenario by using `drivingScenario` object. It contains an ego-vehicle, pedestrian and two other vehicles.

Create and plot a driving scenario with multiple vehicles

Create a driving scenario.

```
scenario = drivingScenario;
```

Add a straight road to the driving scenario. The road has one lane in each direction.

```
roadCenters = [0 0 0; 70 0 0];
laneSpecification = lanespec([1 1]);
road(scenario,roadCenters,'Lanes',laneSpecification);
```

Add an ego vehicle to the driving scenario.

```
egoVehicle = vehicle(scenario,'ClassID',1,'Mesh',driving.scenario.carMesh);
waypoints = [1 -2 0; 35 -2 0];
smoothTrajectory(egoVehicle,waypoints,10);
```

Add a truck, pedestrian, and bicycle to the driving scenario and plot the scenario.

```
truck = vehicle(scenario,'ClassID',2,'Length',8.2,'Width',2.5,'Height',3.5, ...
'Mesh',driving.scenario.truckMesh);
waypoints = [70 1.7 0; 20 1.9 0];
smoothTrajectory(truck,waypoints,15);
```

```
pedestrian = actor(scenario,'ClassID',4,'Length',0.24,'Width',0.45,'Height',1.7, ...
'Mesh',driving.scenario.pedestrianMesh);
```

```

waypoints = [23 -4 0; 10.4 -4 0];
smoothTrajectory(pedestrian,waypoints,1.5);

bicycle = actor(scenario,'ClassID',3,'Length',1.7,'Width',0.45,'Height',1.7, ...
    'Mesh',driving.scenario.bicycleMesh);
waypoints = [12.7 -3.3 0; 49.3 -3.3 0];
smoothTrajectory(bicycle,waypoints,5);

plot(scenario,'Meshes','on')

```

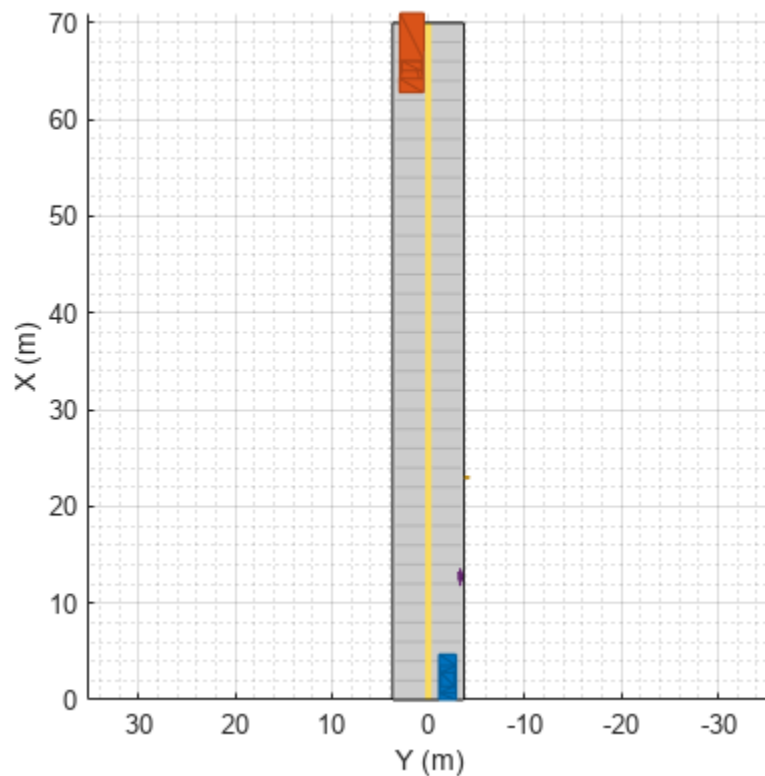

Generate and plot lidar point cloud data

Create a `lidarPointCloudGenerator` System object.

```
lidar = lidarPointCloudGenerator;
```

Add actor profiles and the ego vehicle actor ID from the driving scenario to the System object.

```
lidar.ActorProfiles = actorProfiles(scenario);
lidar.EgoVehicleActorID = egoVehicle.ActorID;
```

Plot the point cloud data.

```

bep = birdsEyePlot('Xlimits',[0 70],'Ylimits',[-30 30]);
plotter = pointCloudPlotter(bep);
legend('off');
while advance(scenario)
    tgts = targetPoses(egoVehicle);
end

```

```
rdmesh = roadMesh(egoVehicle);  
[ptCloud,isValidTime] = lidar(tgts,rdmesh,scenario.SimulationTime);  
if isValidTime  
    plotPointCloud(plotter,ptCloud);  
end  
end
```

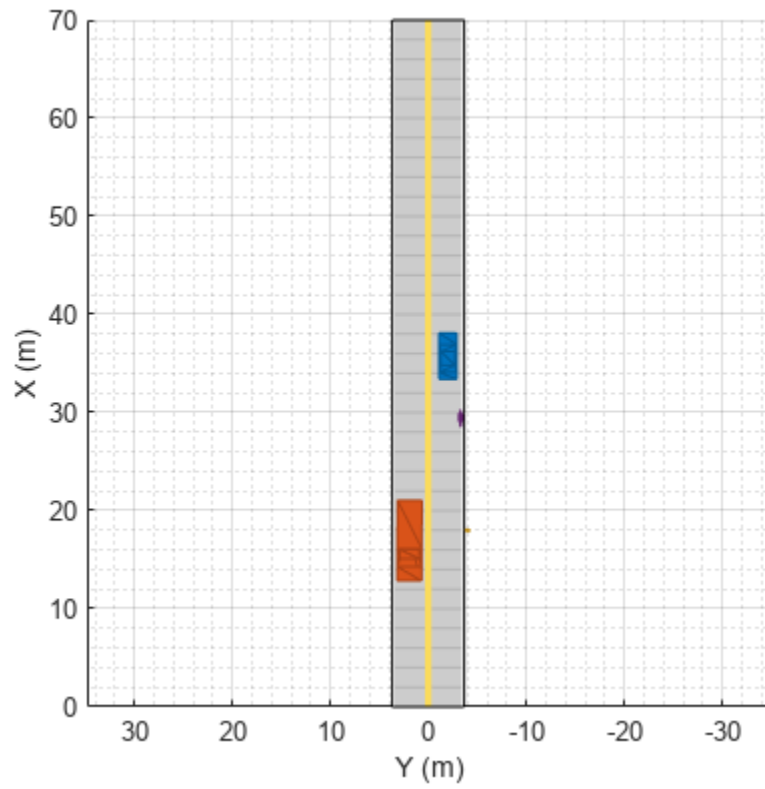

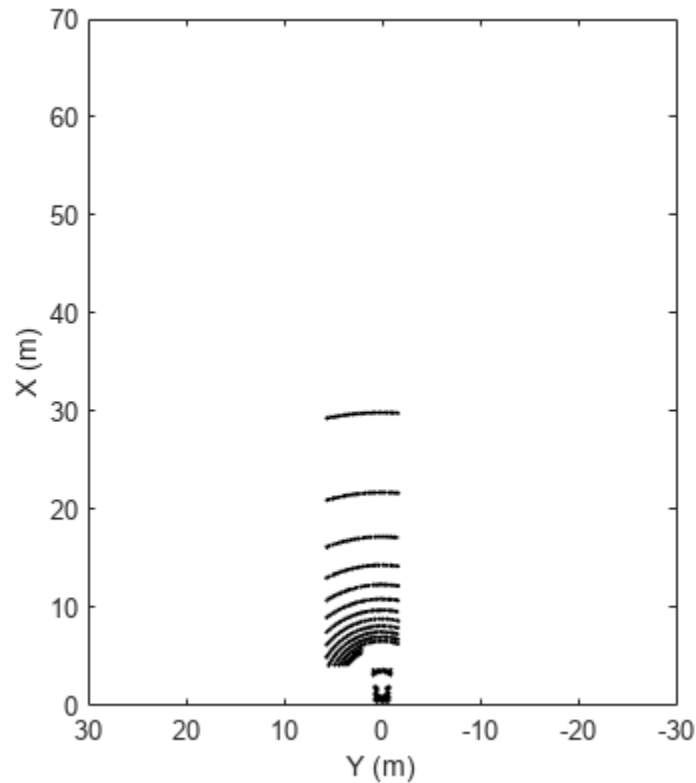

Input Arguments

ac – Actor

Actor object | Vehicle object

Actor belonging to a `drivingScenario` object, specified as an `Actor` or `Vehicle` object. To create these objects, use the `actor` and `vehicle` functions, respectively.

maxRadius – Maximum radius of search area

120 (default) | integer in the range [1, 500]

Maximum radius of search area, specified as an integer in the range [1, 500].

Data Types: `single` | `double` | `int16` | `int32` | `int64` | `uint16` | `uint32` | `uint64`

Output Arguments

rdMesh – Mesh representation of roads near to actor

`extendedObjectMesh` object

Mesh representation of roads near to the actor, returned as an `extendedObjectMesh` object.

Version History

Introduced in R2020a

See Also

Objects

`extendedObjectMesh` | `lidarPointCloudGenerator`

Functions

`driving.scenario.bicycleMesh` | `driving.scenario.carMesh` |
`driving.scenario.pedestrianMesh` | `driving.scenario.truckMesh`

ultrasonicDetectionGenerator

Generate ultrasonic range detections in driving scenario

Description

The `ultrasonicDetectionGenerator` System object generates detections from an ultrasonic sensor mounted on an ego vehicle. The detections are range measurements that indicate the distance between the sensor and the closest point of the detected object. You can use an `ultrasonicDetectionGenerator` object in a scenario containing actors and trajectories, which you can create by using a `drivingScenario` object.

To generate ultrasonic detections:

- 1 Create the `ultrasonicDetectionGenerator` object and set its properties.
- 2 Call the object with arguments, as if it were a function.

To learn more about how System objects work, see [What Are System Objects?](#)

Creation

Syntax

```
ultrasonic = ultrasonicDetectionGenerator
ultrasonic = ultrasonicDetectionGenerator(Name=Value)
```

Description

`ultrasonic = ultrasonicDetectionGenerator` creates an `ultrasonicDetectionGenerator` object with default property values to generate range detections for a simulated ultrasonic sensor.

`ultrasonic = ultrasonicDetectionGenerator(Name=Value)` sets properties on page 4-271 using one or more name-value arguments. For example, `ultrasonicDetectionGenerator(MountingLocation=[1 0 0.5],MountingAngles=[0 0 pi/20])` specifies the mounting location and angle of the ultrasonic sensor on the ego vehicle.

Properties

Unless otherwise indicated, properties are *nontunable*, which means you cannot change their values after calling the object. Objects lock when you call them, and the `release` function unlocks them.

If a property is *tunable*, you can change its value at any time.

For more information on changing property values, see [System Design in MATLAB Using System Objects](#).

SensorIndex — Unique sensor identifier

1 (default) | positive integer

Unique sensor identifier, specified as a positive integer. This property distinguishes detections that come from different sensors in a multisensor system.

Example: 5

Data Types: double

UpdateRate — Sensor update rate

10 (default) | positive real scalar

Sensor update rate, specified as a positive real scalar, in Hz. The value of this property must be an integer multiple of the simulation update rate defined by the associated `drivingScenario` object. Simulation updates between sensor updates contain no detections

Example: 5

Data Types: double

MountingLocation — Sensor mounting location on ego vehicle

[3.4 0 0.2] (default) | 1-by-3 real-valued vector of form [x y z]

Sensor mounting location on the ego vehicle, specified as a 1-by-3 real-valued vector of the form [x y z]. This property defines the coordinates of the sensor in meters, along the x-, y-, and z-axes relative to the ego vehicle origin, where:

- The x-axis points forward from the vehicle.
- The y-axis points to the left of the vehicle.
- The z-axis points up from the ground.

The default value defines an ultrasonic sensor that is mounted at the center of the front bumper of a sedan.

For more details on the ego vehicle coordinate system, see “Coordinate Systems in Automated Driving Toolbox”.

Data Types: double

MountingAngles — Sensor mounting orientation on ego vehicle

[0 0 0] (default) | 1-by-3 real-valued vector of form [z_{yaw} y_{pitch} x_{roll}]

Sensor mounting orientation on ego vehicle, specified as a 1-by-3 real-valued vector of form [z_{yaw} y_{pitch} x_{roll}]. This property defines the intrinsic Euler angle rotation of the sensor, in degrees, around the z-, y-, and x-axes with respect to the ego vehicle body frame, where:

- z_{yaw}, or yaw angle, rotates the sensor around the z-axis of the ego vehicle.
- y_{pitch}, or pitch angle, rotates the sensor around the y-axis of the ego vehicle. This rotation is relative to the sensor position that results from the z_{yaw} rotation.
- x_{roll}, or roll angle, rotates the sensor around the x-axis of the ego vehicle. This rotation is relative to the sensor position that results from the z_{yaw} and y_{pitch} rotations.

These angles are clockwise-positive when looking in the forward direction of the z-axis, y-axis, and x-axis, respectively. If you visualize sensor data from a bird's-eye view perspective, then the yaw angle is counterclockwise-positive because you are viewing the data in the negative direction of the z-axis, which points up from the ground.

For more details on this coordinate system, see “Coordinate Systems in Automated Driving Toolbox”.

Data Types: double

FieldOfView — Angular field of view of ultrasonic sensor

[70 35] (default) | 1-by-2 positive real-valued vector of form [azfov elfov]

Angular field of view of the ultrasonic sensor, specified as a 1-by-2 positive real-valued vector of the form [azfov elfov]. The field of view defines the total angular extent spanned by the sensor. You must specify the azimuth field of view azfov in the range (0, 360], and the elevation field of view elfov in the range (0, 180]. Units are in degrees.

Data Types: double

DetectionRange — Detection range vector of ultrasonic sensor (m)

[0.03 0.15 5.5] (default) | 1-by-3 nonnegative real-valued vector of form [minDetOnlyRange minDistRange maxDistRange]

Detection range vector of the ultrasonic sensor, specified as a 1-by-3 nonnegative real-valued vector of the form [minDetOnlyRange minDistRange maxDistRange], where $\text{minDetOnlyRange} < \text{minDistRange} < \text{maxDistRange}$. Units are in meters. These values determine the detections and distance values returned by the ultrasonic sensor.

- When the detected object is at a distance between minDistRange and maxDistRange, the sensor returns a positive distance value.
- When the detected object is at a distance between minDetOnlyRange and minDistRange, the sensor detects the object, but cannot determine the distance and returns a value of 0.
- When the object is at a distance below minDetOnlyRange or above maxDistRange, the sensor returns an empty cell array.

Data Types: double

Profiles — Actor profiles

structure | array of structures

Actor profiles, specified as a structure or as an array of structures. Each structure contains the physical and radar characteristics of an actor.

- If ActorProfiles is a single structure, all actors passed into the ultrasonicDetectionGenerator object use this profile.
- If ActorProfiles is an array, each actor passed into the object must have a unique actor profile.

To generate an array of structures for your driving scenario, use the actorProfiles function. The table shows the valid structure fields. If you do not specify a field, that field is set to its default value. If no actors are passed into the object, then the ActorID field is not included.

Field	Description
ActorID	Scenario-defined actor identifier, specified as a positive integer.
ClassID	Classification identifier, specified as a nonnegative integer. 0 is reserved for an object of an unknown or unassigned class.
Length	Length of actor, specified as a positive real scalar. The default is 4.7. Units are in meters.

Field	Description
Width	Width of actor, specified as a positive real scalar. The default is 1.8. Units are in meters.
Height	Height of actor, specified as a positive real scalar. The default is 1.4. Units are in meters.
OriginOffset	Offset of the rotational center of the actor from its geometric center, specified as an [x y z] real-valued vector. The rotational center, or origin, is located at the bottom center of the actor. For vehicles, the rotational center is the point on the ground beneath the center of the rear axle. The default is [-1.35 0 0]. Units are in meters.
RCSPattern	Radar cross-section pattern of actor, specified as a numel(RCSElevationAngles)-by-numel(RCSAzimuthAngles) real-valued matrix. The default is [10 10; 10 10]. Units are in decibels per square meter.
RCSAzimuthAngles	Azimuth angles corresponding to rows of RCSPattern, specified as a vector of real values in the range [-180, 180]. The default is [-180 180]. Units are in degrees.
RCSElevationAngles	Elevation angles corresponding to rows of RCSPattern, specified as a vector of real values in the range [-90, 90]. The default is [-90 90]. Units are in degrees.

For full definitions of the structure fields, see the `actor` and `vehicle` functions.

Data Types: struct

Usage

Syntax

```
dets = ultrasonic(targets,simTime)
[dets,isValidTime] = ultrasonic(targets,simTime)
```

Description

`dets = ultrasonic(targets,simTime)` creates ultrasonic detections, `dets`, from sensor measurements taken of target poses, `targets`, relative to the ego vehicle at the current simulation time `simTime`. The object can generate sensor detections for multiple actors simultaneously.

`[dets,isValidTime] = ultrasonic(targets,simTime)` also returns a logical value, `isValidTime`, indicating whether `simTime` is a valid time for generating detections. If `simTime` is an integer multiple of the reciprocal of the `UpdateRate` property value, then `isValidTime` is 1 (true).

Input Arguments

targets — Target actor poses

structure | structure array

Target actor poses, specified as a structure or structure array. Each structure describes the pose of a target actor relative to the ego vehicle. To generate these structures, use the `targetPoses` function. You can also create these structures manually. Do not include the ego vehicle pose in this argument.

This table shows the required fields for the structures.

Field	Description
ActorID	Scenario-defined actor identifier, specified as a positive integer.
ClassID	Classification identifier, specified as a nonnegative integer. 0 represents an object of an unknown or unassigned class.
Position	Position of actor, specified as a real-valued vector of the form $[x \ y \ z]$. Units are in meters.
Velocity	Velocity (v) of actor in the x-, y-, and z-directions, specified as a real-valued vector of the form $[v_x \ v_y \ v_z]$. Units are in meters per second.
Roll	Roll angle of actor, specified as a real scalar. Units are in degrees.
Pitch	Pitch angle of actor, specified as a real scalar. Units are in degrees.
Yaw	Yaw angle of actor, specified as a real scalar. Units are in degrees.
AngularVelocity	Angular velocity (ω) of actor in the x-, y-, and z-directions, specified as a real-valued vector of the form $[\omega_x \ \omega_y \ \omega_z]$. Units are in degrees per second.

simTime — Current simulation time

nonnegative real scalar

Current simulation time, specified as a nonnegative real scalar in seconds.

Example: 10.5

Data Types: double

Output Arguments

dets — Generated detections

cell array of `objectDetection` objects

Generated detections, returned as a cell array of `objectDetection` objects. Each object contains these properties:

Property	Description
Time	Measurement time
Measurement	Distance measurement to the closest object
MeasurementNoise	Measurement noise covariance matrix
SensorIndex	Unique ID of the sensor
ObjectClassID	Object classification
ObjectAttributes	Additional information passed to tracker
MeasurementParameters	Parameters used by initialization functions of nonlinear Kalman tracking filters

This table describes the additional information in the `ObjectAttributes` property.

ObjectAttributes

Attribute	Definition
TargetIndex	Identifier of the actor, <code>ActorID</code> , that generated the detection. For false alarms, this value is negative.
PointOnTarget	Coordinate of the point on the detected object that the sensor used to compute the distance measurement. It is in the vehicle coordinate system.

For `MeasurementParameters`, the measurements are relative to the parent frame. The parent frame is the ego vehicle body.

MeasurementParameters

Parameter	Definition
Frame	Enumerated type indicating the frame used to report measurements. The Frame is always set to 'spherical' and the detections are reported in spherical coordinates for ultrasonicDetectionGenerator.
OriginPosition	3-D vector offset of the sensor origin from the parent frame origin.
OriginVelocity	Velocity of the sensor coordinate system with respect to the parent frame.
IsParentToChild	Logical scalar indicating if Orientation performs a frame rotation from the parent coordinate frame to the child coordinate frame. When IsParentToChild is false, then Orientation performs a frame rotation from the child coordinate frame to the parent coordinate frame.
HasAzimuth	Indicates whether measurements contain azimuth components.
HasRange	Indicates whether measurements contain range components. Always true for ultrasonicDetectionGenerator.
HasElevation	Indicates whether measurements contain elevation components. Always false for Ultrasonic Detection Generator.
HasVelocity	Indicates whether measurements contain velocity or range rate components. Always false for ultrasonicDetectionGenerator.
FieldOfView	2-D vector containing the azimuth and elevation field of view values of the sensor.

isValidTime – Valid time for generating reports

0 | 1

Valid time for generating reports, returned as a logical 0 (false) or 1 (true).

If the reports `dets` generated by the sensor are invalid because the sensor generated them at a time inconsistent with the sensor update rate, then `isValidTime` is 0.

The sensor generates reports only when the current simulation time, `simTime`, is an integer multiple of the time interval at which the sensor generates reports. This time interval is equal to the reciprocal of the `UpdateRate` property value.

Data Types: `logical`

Object Functions

To use an object function, specify the System object as the first input argument. For example, to release system resources of a System object named `obj`, use this syntax:

```
release(obj)
```

Common to All System Objects

<code>step</code>	Run System object algorithm
<code>release</code>	Release resources and allow changes to System object property values and input characteristics
<code>reset</code>	Reset internal states of System object
<code>isLocked</code>	Determine if System object is in use
<code>clone</code>	Create duplicate System object

Examples

Generate Ultrasonic Detections of Multiple Vehicles

Use a simulated ultrasonic sensor to generate detections for multiple vehicles in a driving scenario.

Create Driving Scenario

Create a driving scenario containing a three-lane road using lane specifications.

```
scenario = drivingScenario;  
roadCenters = [-120 30 0; -60 0 0; 0 0 0; 60 0 0; 120 30 0];  
lspc = lanespec(3);  
road(scenario, roadCenters, Lanes=lspc);
```

Create an ego vehicle that travels in the center lane at a velocity of 30 m/s.

```
egovehicle = vehicle(scenario, ClassID=1);  
egopath = [1.5 0 0; 60 0 0; 111 25 0];  
egospeed = 30;  
smoothTrajectory(egovehicle, egopath, egospeed);
```

Add a target vehicle that travels ahead of the ego vehicle at 30.5 m/s in the right lane, and changes lanes close to the ego vehicle.

```
ftargetcar = vehicle(scenario, ClassID=1);  
ftargetpath = [8 2; 60 -3.2; 120 33];  
ftargetspeed = 30.5;  
smoothTrajectory(ftargetcar, ftargetpath, ftargetspeed);
```

Add a second target vehicle that travels in the left lane at 32m/s.

```
ltargetcar = vehicle(scenario, ClassID=1);  
ltargetpath = [-5.0 3.5 0; 60 3.5 0; 111 28.5 0];  
ltargetspeed = 32;  
smoothTrajectory(ltargetcar, ltargetpath, ltargetspeed);
```

Display a chase plot from behind the ego vehicle for a 3D view of the scenario..

```
chasePlot(egovehicle)
```

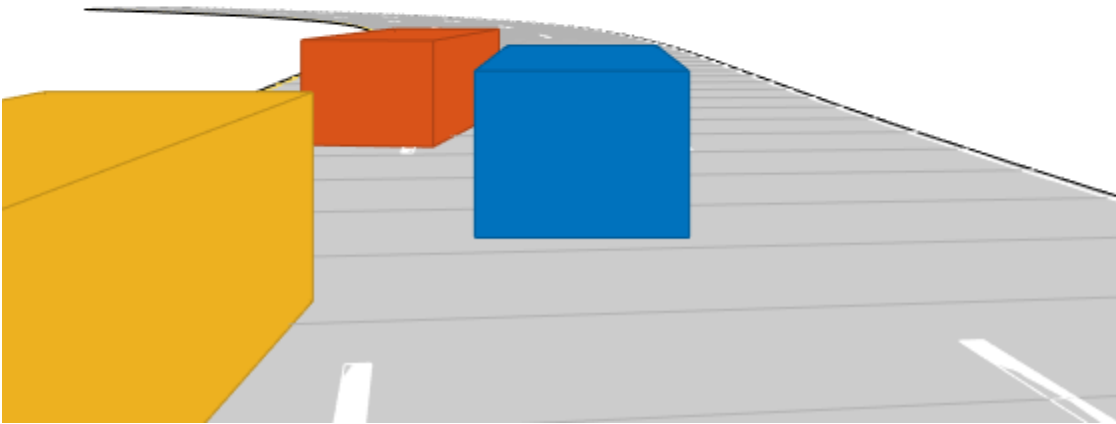
Create Ultrasonic Sensors

Create an ultrasonic sensor mounted at the front of the ego vehicle.

```
frontUltrasonic = ultrasonicDetectionGenerator(1,FieldOfView=[70 35]);
frontUltrasonic.Profiles = actorProfiles(scenario);
```

Create a second ultrasonic sensor mounted on the left side of the ego vehicle.

```
leftUltrasonic = ultrasonicDetectionGenerator(2,MountingLocation=[0.5 1 0.2],MountingAngles=[90 0 90]);
leftUltrasonic.Profiles = actorProfiles(scenario);
```

Create Bird's-Eye-Plot

Create a bird's-eye-plot for visualizing the sensor data. Add plotters for visualizing the ultrasonic coverage areas, detections, and points on targets. Use a `rangeDetectionPlotter` object to visualize ultrasonic detections as arcs and a `detectionPlotter` object to visualize the closest points on the target as markers. Add plotters to display the lane markings and vehicle outlines.

```
% Create bird's eye plot
bep = birdsEyePlot(XLim=[-20 20],YLim=[-12 12]);

% Plotters for Coverage areas of two ultrasonic sensors
fcaPlotter = coverageAreaPlotter(bep,DisplayName="Front Ultrasonic field of view");
plotCoverageArea(fcaPlotter,frontUltrasonic.MountingLocation(1:2), ...
    frontUltrasonic.DetectionRange(3),frontUltrasonic.MountingAngles(1),frontUltrasonic.FieldOfView);

lcaPlotter = coverageAreaPlotter(bep,DisplayName="Left Ultrasonic field of view",FaceColor="y");
```

```

plotCoverageArea(lcaPlotter,leftUltrasonic.MountingLocation(1:2), ...
    leftUltrasonic.DetectionRange(3),leftUltrasonic.MountingAngles(1),leftUltrasonic.FieldOfView(1)

% Range Detection Plotters for Ultrasonic Detections
frdPlotter = rangeDetectionPlotter(bep,DisplayName="Front Ultrasonic Ranges");
lrdPlotter = rangeDetectionPlotter(bep,DisplayName="Left Ultrasonic Ranges",LineStyle=":");

% Detection plotters for closest points on targets
fdetPlotter = detectionPlotter(bep,DisplayName="Point-On-Target (Front Ultrasonic)",MarkerFaceColor="r");
ldetPlotter = detectionPlotter(bep,DisplayName="Point-On-Target (Rear Ultrasonic)",MarkerFaceColor="b");

% Plotters for vehicle and target outlines, lane markings
olPlotter = outlinePlotter(bep);
lmPlotter = laneMarkingPlotter(bep,DisplayName="Lane markings");

```

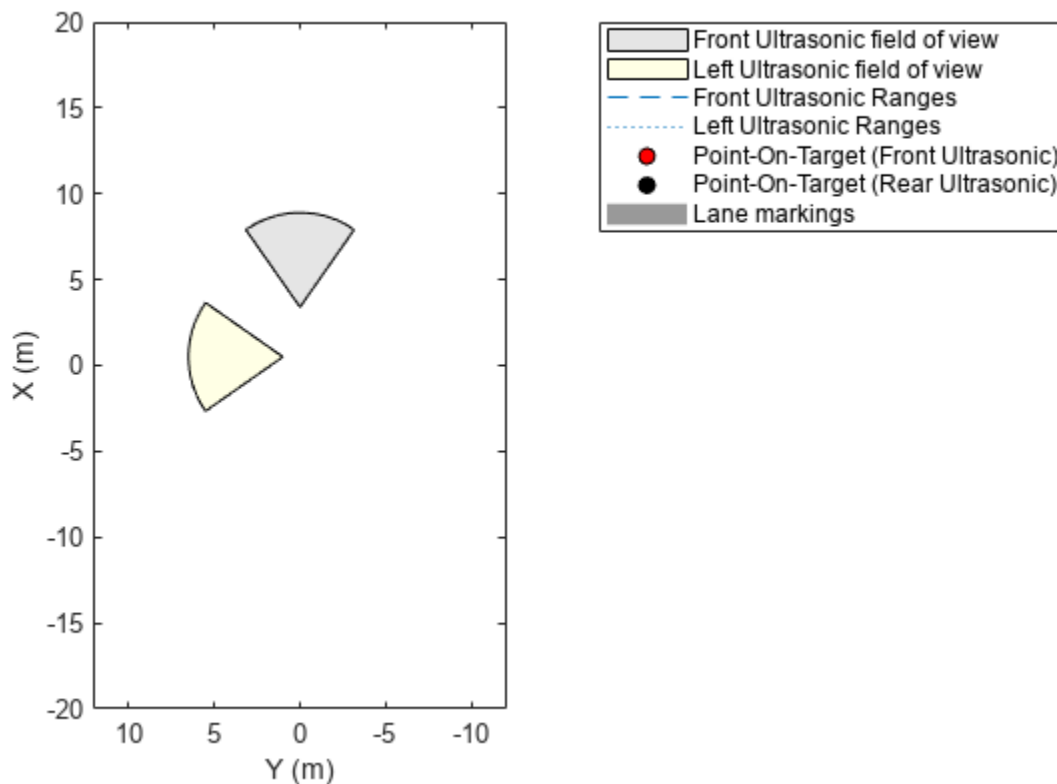

Run the Simulation and Generate Detections

Run the scenario simulation. At each timestep:

- 1 Obtain the ground truth target poses, and generate detections for the two ultrasonic sensors.
- 2 Obtain and display the target outlines and lane markings.
- 3 When there are valid detections, display the detections and the corresponding points-on-targets generated by the ultrasonic sensor.

```

while advance(scenario)
    tgtpose = targetPoses(egovehicle);

```

```

[fobdets, fisValid] = frontUltrasonic(tgtpose, scenario.SimulationTime);
[lobdets, lisValid] = leftUltrasonic(tgtpose, scenario.SimulationTime);

[objposition, objyaw, objlength, objwidth, objoriginOffset, color] = targetOutlines(egovehicle);
plotOutline(olPlotter, objposition, objyaw, objlength, objwidth, ...
    OriginOffset=objoriginOffset, Color=color)

[lmv, lmf] = laneMarkingVertices(egovehicle);
plotLaneMarking(lmPlotter, lmv, lmf)

if ~isempty(fobdets) && fisValid
    franges = fobdets{1}.Measurement;
    plotRangeDetection(frdPlotter, franges, frontUltrasonic.FieldOfView(1), frontUltrasonic.Mount);
    plotDetection(fdetPlotter, fobdets{1}.ObjectAttributes{1}.PointOnTarget(1:2)')
end

if ~isempty(lobdets) && lisValid
    lranges = lobdets{1}.Measurement;
    plotRangeDetection(lrdPlotter, lranges, leftUltrasonic.FieldOfView(1), leftUltrasonic.Mount);
    plotDetection(ldetPlotter, lobdets{1}.ObjectAttributes{1}.PointOnTarget(1:2)')
end
end

```

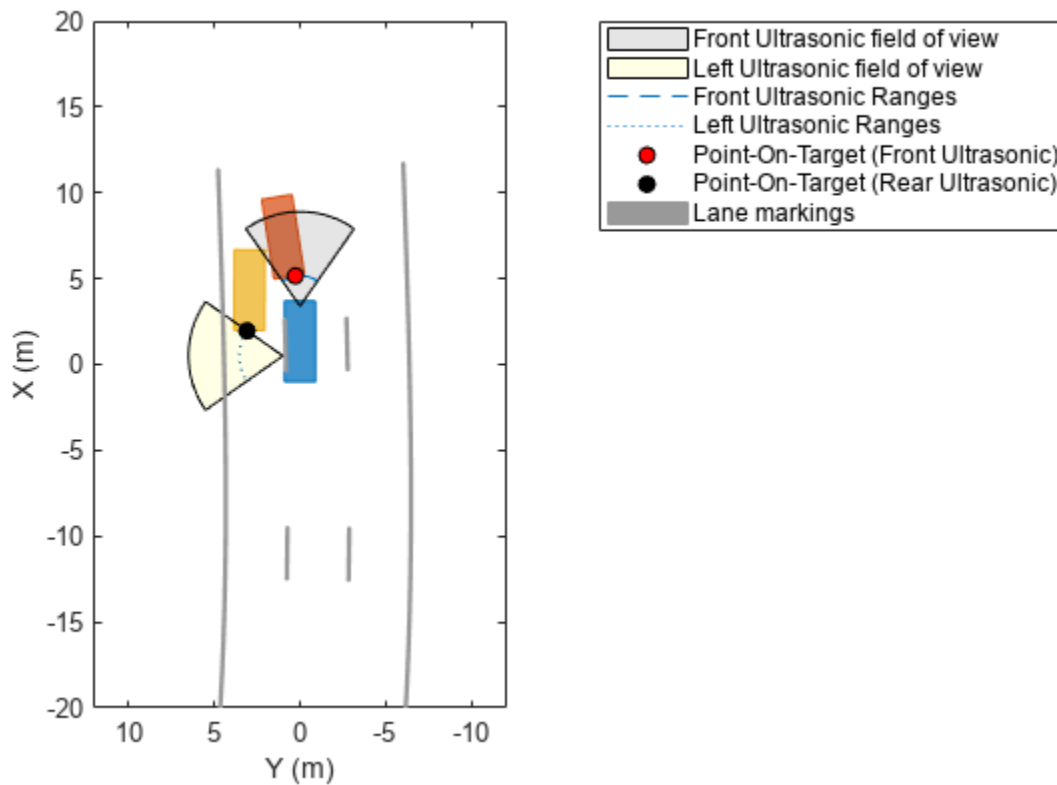

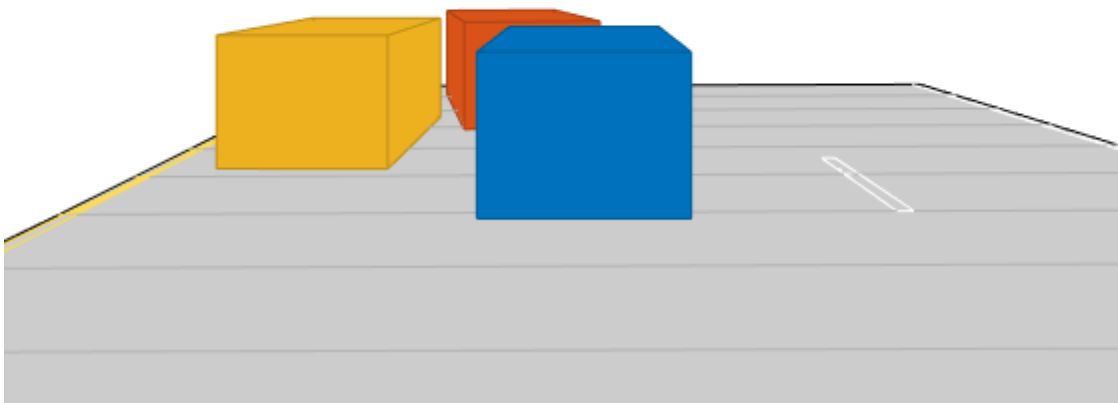

Version History

Introduced in R2022a

See Also

Objects

[objectDetection](#) | [drivingScenario](#) | [drivingRadarDataGenerator](#) | [visionDetectionGenerator](#) | [lidarPointCloudGenerator](#) | [insSensor](#)

Functions

[actorProfiles](#) | [actorPoses](#)

Apps

[Driving Scenario Designer](#)

driving.Path

Planned vehicle path

Description

The `driving.Path` object represents a vehicle path composed of a sequence of path segments. These segments can be either `driving.DubinsPathSegment` objects or `driving.ReedsSheppPathSegment` objects and are stored in the `PathSegments` property of `driving.Path`.

To check the validity of the path against a `vehicleCostmap` object, use the `checkPathValidity` function. To interpolate poses along the length of the path, use the `interpolate` function.

Creation

To create a `driving.Path` object, use the `plan` function, specifying a `pathPlannerRRT` object as input.

Properties

StartPose — Initial pose of vehicle

`[x, y, θ]` vector

This property is read-only.

Initial pose of the vehicle, specified as an `[x, y, θ]` vector. `x` and `y` are in world units, such as meters. θ is in degrees.

GoalPose — Goal pose of vehicle

`[x, y, θ]` vector

This property is read-only.

Goal pose of the vehicle, specified as an `[x, y, θ]` vector. `x` and `y` are in world units, such as meters. θ is in degrees.

PathSegments — Segments along path

array of `driving.DubinsPathSegment` objects | array of `driving.ReedsSheppPathSegment` objects

This property is read-only.

Segments along the path, specified as an array of `driving.DubinsPathSegment` objects or `driving.ReedsSheppPathSegment` objects.

Length — Length of path

positive real scalar

This property is read-only.

Length of the path, in world units, specified as a positive real scalar.

Object Functions

interpolate Interpolate poses along planned vehicle path
 plot Plot planned vehicle path

Examples

Plan Path and Check Its Validity

Plan a vehicle path through a parking lot by using the optimal rapidly exploring random tree (RRT*) algorithm. Check that the path is valid, and then plot the transition poses along the path.

Load a costmap of a parking lot. Plot the costmap to see the parking lot and inflated areas for the vehicle to avoid.

```
data = load('parkingLotCostmap.mat');
costmap = data.parkingLotCostmap;
plot(costmap)
```

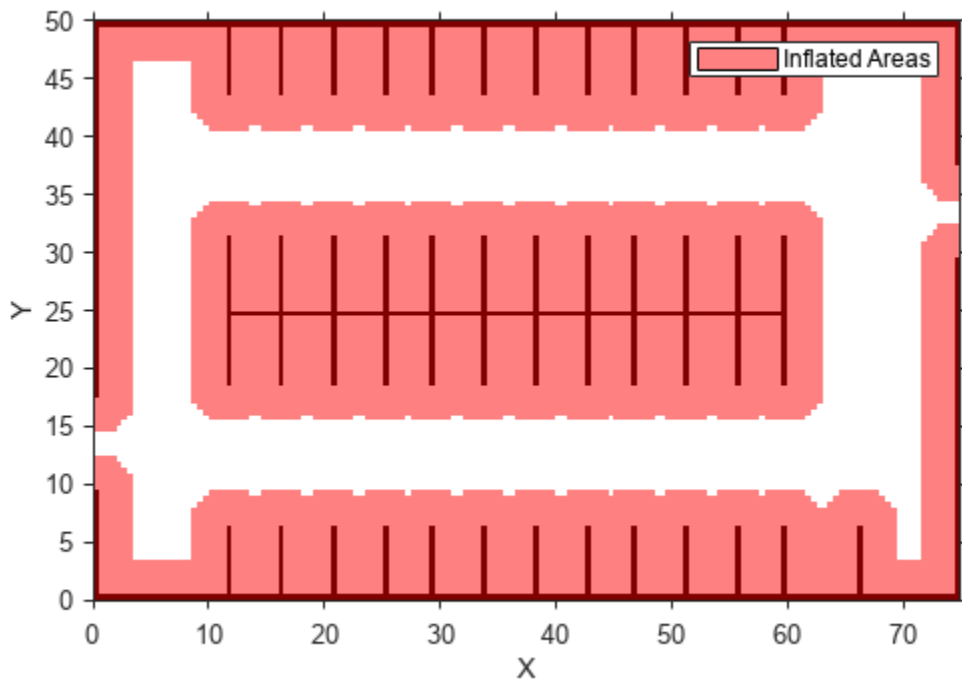

Define start and goal poses for the vehicle as $[x, y, \theta]$ vectors. World units for the (x,y) locations are in meters. World units for the θ orientation angles are in degrees.

```
startPose = [4, 4, 90]; % [meters, meters, degrees]
goalPose = [30, 13, 0];
```

Use a `pathPlannerRRT` object to plan a path from the start pose to the goal pose.

```
planner = pathPlannerRRT(costmap);
refPath = plan(planner,startPose,goalPose);
```

Check that the path is valid.

```
isPathValid = checkPathValidity(refPath,costmap)
```

```
isPathValid = logical
    1
```

Interpolate the transition poses along the path.

```
transitionPoses = interpolate(refPath);
```

Plot the planned path and the transition poses on the costmap.

```
hold on
plot(refPath,'DisplayName','Planned Path')
scatter(transitionPoses(:,1),transitionPoses(:,2),[],'filled', ...
    'DisplayName','Transition Poses')
hold off
```

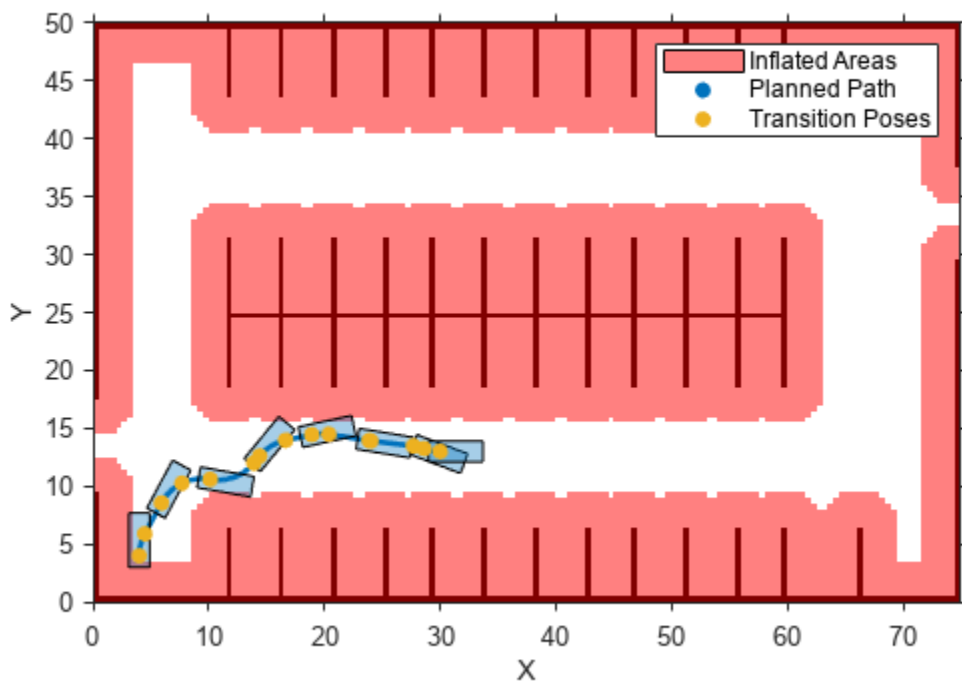

Plan Path and Interpolate Along Path

Plan a vehicle path through a parking lot by using the rapidly exploring random tree (RRT*) algorithm. Interpolate the poses of the vehicle at points along the path.

Load a costmap of a parking lot. Plot the costmap to see the parking lot and inflated areas for the vehicle to avoid.

```
data = load('parkingLotCostmap.mat');
costmap = data.parkingLotCostmap;
plot(costmap)
```

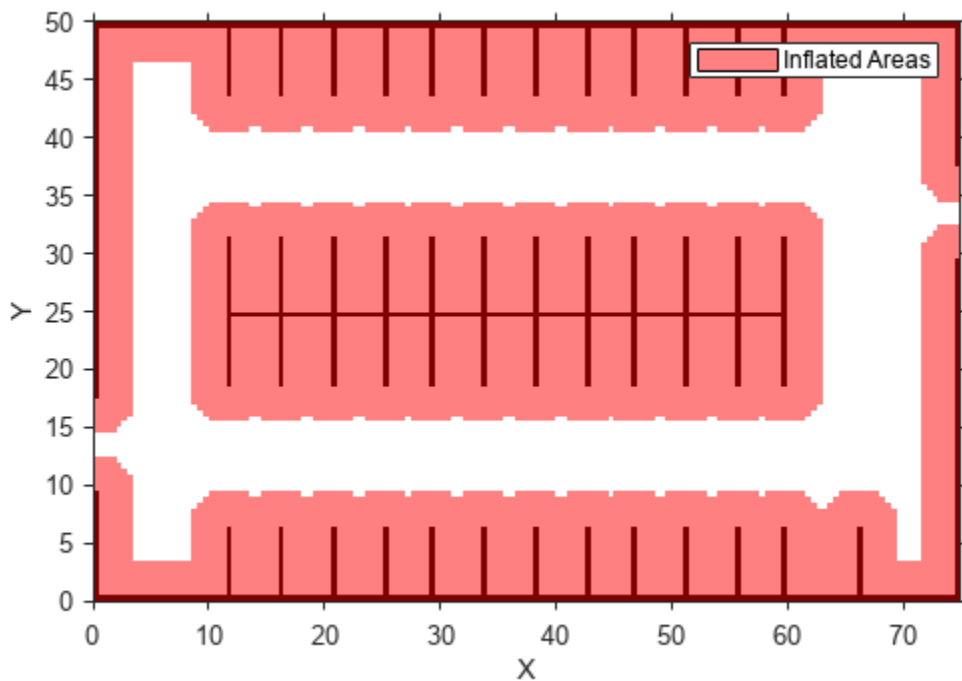

Define start and goal poses for the vehicle as $[x, y, \theta]$ vectors. World units for the (x,y) locations are in meters. World units for the θ orientation angles are in degrees.

```
startPose = [4, 4, 90]; % [meters, meters, degrees]
goalPose = [30, 13, 0];
```

Use a pathPlannerRRT object to plan a path from the start pose to the goal pose.

```
planner = pathPlannerRRT(costmap);
refPath = plan(planner, startPose, goalPose);
```

Interpolate the vehicle poses every 1 meter along the entire path.

```
lengths = 0 : 1 : refPath.Length;
poses = interpolate(refPath, lengths);
```

Plot the interpolated poses on the costmap.

```
plot(costmap)
hold on
scatter(poses(:,1),poses(:,2), 'DisplayName', 'Interpolated Poses')
hold off
```

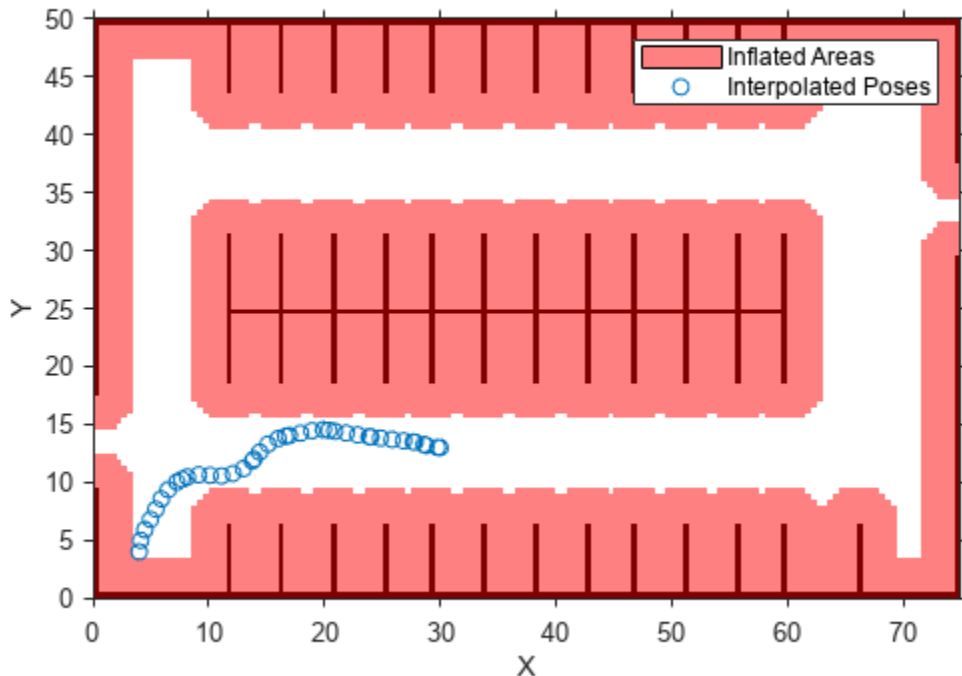

Version History

Introduced in R2018a

R2018b: connectingPoses function and driving.Path object properties KeyPoses and NumSegments are not recommended

Not recommended starting in R2018b

The `connectingPoses` function and the `KeyPoses` and `NumSegments` properties of the `driving.Path` object are not recommended. Instead, use the `interpolate` function, which returns key poses, connecting poses, transition poses, and direction changes. The `KeyPoses` and `NumSegments` properties are no longer relevant. `KeyPoses`, `NumSegments`, and `connectingPoses` will be removed in a future release.

In R2018a, `connectingPoses` enabled you to obtain intermediate poses either along the entire path or along the path segments that are between key poses (as specified by `KeyPoses`). Using the `interpolate` function, you can now obtain intermediate poses at any specified point along the path. The `interpolate` function also provides transition poses at which changes in direction occur.

Update Code

Remove all instances of `KeyPoses` and `NumSegments` and replace all instances of `connectingPoses` with `interpolate`. The table shows typical usages of `connectingPoses` and how to update your code to use `interpolate` instead. Here, `path` is a `driving.Path` object returned by `pathPlannerRRT`.

Discouraged Usage	Recommended Replacement
<code>poses = connectingPoses(path);</code>	<code>poses = interpolate(path);</code>
<code>segID = 1;</code> <code>posesSegment = connectingPoses(path, segID);</code>	<code>interpolate</code> does not have a direct syntax for obtaining segment poses. However, you can sample poses of a segment using a specified step time. For example: <code>step = 0.1;</code> <code>samples = 0 : step : path.PathSegments(1).Length;</code> <code>segmentPoses = interpolate(path, samples);</code>

Extended Capabilities**C/C++ Code Generation**

Generate C and C++ code using MATLAB® Coder™.

See Also**Functions**

`plan` | `plot` | `checkPathValidity` | `interpolate` | `smoothPathSpline`

Objects

`pathPlannerRRT` | `vehicleCostmap` | `driving.DubinsPathSegment` | `driving.ReedsSheppPathSegment`

Topics

"Automated Parking Valet"

connectingPoses

Package: driving

(Not recommended) Obtain connecting poses along vehicle path

Note connectingPoses is not recommended. Use interpolate instead. For more information, see “Compatibility Considerations”

Syntax

```
poses = connectingPoses(path)
poses = connectingPoses(path, segID)
poses = connectingPoses( ____, 'NumSamples', numSamples)
```

Description

`poses = connectingPoses(path)` returns the connecting poses that are between the key poses of a vehicle path.

`poses = connectingPoses(path, segID)` returns the connecting poses that are along the path segment specified by `segID`.

`poses = connectingPoses(____, 'NumSamples', numSamples)` specifies the number of connecting poses to compute between successive key poses, using either of the preceding syntaxes.

Input Arguments

path — Planned vehicle path

driving.Path object

Planned vehicle path from which to obtain connecting poses, specified as a `driving.Path` object.

segID — ID of path segment

positive integer

ID of the path segment from which to obtain connecting poses, specified as a positive integer. Each path segment has two successive key poses as its endpoints. `segID` must be less than the number of segments in the input path.

numSamples — Number of connecting poses to sample

100 (default) | integer greater than 1

Number of connecting poses to sample from each segment, specified as an integer greater than 1.

Example: 'NumSamples', 50

Output Arguments

poses — Connecting poses

m -by-3 matrix of $[x, y, \theta]$ poses

Connecting poses, returned as an m -by-3 matrix of $[x, y, \theta]$ poses. Each row corresponds to a separate pose. x and y are specified in world coordinates and θ is in degrees. `poses` includes all key poses.

Version History

Introduced in R2018a

R2018b: `connectingPoses` function and `driving.Path` object properties `KeyPoses` and `NumSegments` are not recommended

Not recommended starting in R2018b

The `connectingPoses` function and the `KeyPoses` and `NumSegments` properties of the `driving.Path` object are not recommended. Instead, use the `interpolate` function, which returns key poses, connecting poses, transition poses, and direction changes. The `KeyPoses` and `NumSegments` properties are no longer relevant. `KeyPoses`, `NumSegments`, and `connectingPoses` will be removed in a future release.

In R2018a, `connectingPoses` enabled you to obtain intermediate poses either along the entire path or along the path segments that are between key poses (as specified by `KeyPoses`). Using the `interpolate` function, you can now obtain intermediate poses at any specified point along the path. The `interpolate` function also provides transition poses at which changes in direction occur.

Update Code

Remove all instances of `KeyPoses` and `NumSegments` and replace all instances of `connectingPoses` with `interpolate`. The table shows typical usages of `connectingPoses` and how to update your code to use `interpolate` instead. Here, `path` is a `driving.Path` object returned by `pathPlannerRRT`.

Discouraged Usage	Recommended Replacement
<code>poses = connectingPoses(path);</code>	<code>poses = interpolate(path);</code>
<code>segID = 1;</code> <code>posesSegment = connectingPoses(path, segID);</code>	<code>interpolate</code> does not have a direct syntax for obtaining segment poses. However, you can sample poses of a segment using a specified step time. For example: <code>step = 0.1;</code> <code>samples = 0 : step : path.PathSegments(1).Length;</code> <code>segmentPoses = interpolate(path, samples);</code>

See Also

Functions

`plan` | `checkPathValidity` | `interpolate`

Objects

`pathPlannerRRT` | `driving.Path`

Topics

“Automated Parking Valet”

plot

Package: driving

Plot planned vehicle path

Syntax

```
plot(refPath)
plot(refPath, Name, Value)
```

Description

`plot(refPath)` plots the planned vehicle path.

`plot(refPath, Name, Value)` specifies options using one or more name-value pair arguments. For example, `plot(path, 'Vehicle', 'off')` plots the path without displaying the vehicle.

Examples

Plan Path and Check Its Validity

Plan a vehicle path through a parking lot by using the optimal rapidly exploring random tree (RRT*) algorithm. Check that the path is valid, and then plot the transition poses along the path.

Load a costmap of a parking lot. Plot the costmap to see the parking lot and inflated areas for the vehicle to avoid.

```
data = load('parkingLotCostmap.mat');
costmap = data.parkingLotCostmap;
plot(costmap)
```

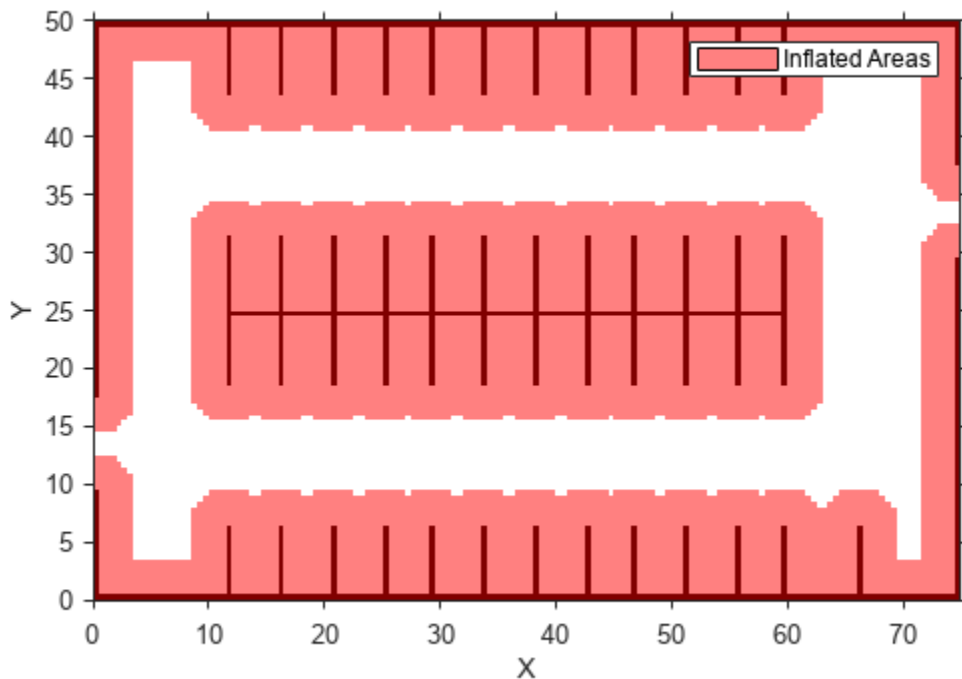

Define start and goal poses for the vehicle as $[x, y, \theta]$ vectors. World units for the (x,y) locations are in meters. World units for the θ orientation angles are in degrees.

```
startPose = [4, 4, 90]; % [meters, meters, degrees]
goalPose = [30, 13, 0];
```

Use a `pathPlannerRRT` object to plan a path from the start pose to the goal pose.

```
planner = pathPlannerRRT(costmap);
refPath = plan(planner,startPose,goalPose);
```

Check that the path is valid.

```
isPathValid = checkPathValidity(refPath,costmap)
isPathValid = logical
    1
```

Interpolate the transition poses along the path.

```
transitionPoses = interpolate(refPath);
```

Plot the planned path and the transition poses on the costmap.

```
hold on
plot(refPath,'DisplayName','Planned Path')
scatter(transitionPoses(:,1),transitionPoses(:,2),[],'filled', ...
```

```
'DisplayName','Transition Poses')
hold off
```

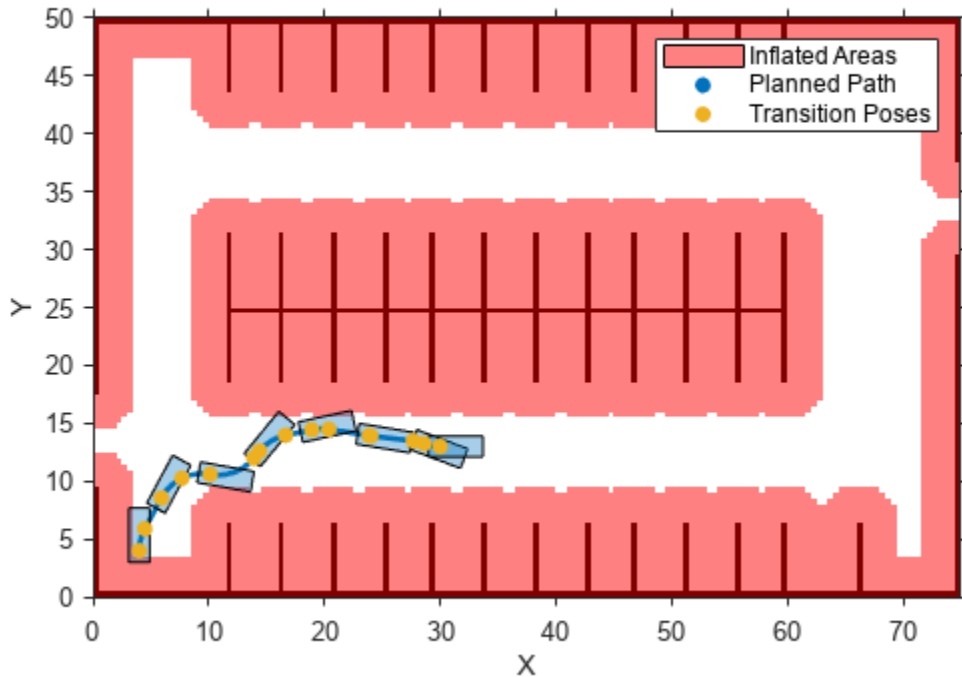

Input Arguments

refPath — Planned vehicle path

driving.Path object

Planned vehicle path, specified as a driving.Path object.

Name-Value Pair Arguments

Specify optional pairs of arguments as Name1=Value1, ..., NameN=ValueN, where Name is the argument name and Value is the corresponding value. Name-value arguments must appear after other arguments, but the order of the pairs does not matter.

Before R2021a, use commas to separate each name and value, and enclose Name in quotes.

Example: 'Inflation','off'

Parent — Axes object

axes object

Axes object in which to draw the plot, specified as the comma-separated pair consisting of 'Parent' and an axes object. If you do not specify Parent, a new figure is created.

Vehicle — Display vehicle

'on' (default) | 'off'

Display vehicle, specified as the comma-separated pair consisting of 'Vehicle' and 'on' or 'off'. Setting this argument to 'on' displays the vehicle along the path.

VehicleDimensions — Dimensions of vehicle

vehicleDimensions object

Dimensions of the vehicle, specified as the comma-separated pair consisting of 'VehicleDimensions' and a vehicleDimensions object.

DisplayName — Name of entry in legend

'' (default) | character vector | string scalar







Name of the entry in the legend, specified as the comma-separated pair consisting of 'DisplayName' and a character vector or string scalar.

Color — Path color

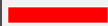
color name | short color name | RGB triplet

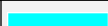
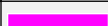
Path color, specified as the comma-separated pair consisting of 'Color' and a color name, short color name, or RGB triplet.

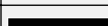
For a custom color, specify an RGB triplet. An RGB triplet is a three-element row vector whose elements specify the intensities of the red, green, and blue components of the color. The intensities must be in the range $[0, 1]$; for example, $[0.4 \ 0.6 \ 0.7]$. Alternatively, you can specify some common colors by name. This table lists the named color options and the equivalent RGB triplet values.

Color Name	Color Short Name	RGB Triplet	Appearance
'red'	'r'	[1 0 0]	
'green'	'g'	[0 1 0]	
'blue'	'b'	[0 0 1]	
'cyan'	'c'	[0 1 1]	
'magenta'	'm'	[1 0 1]	
'yellow'	'y'	[1 1 0]	
'black'	'k'	[0 0 0]	
'white'	'w'	[1 1 1]	

Example: 'Color', [1 0 1]

Example: 'Color', 'm'

Example: 'Color', 'magenta'

Tag — Tag to identify path

'' (default) | character vector | string scalar

Tag to identify path, specified as the comma-separated pair consisting of 'Tag' and a character vector or string scalar.

Version History

Introduced in R2018a

See Also

Functions

plan | checkPathValidity | interpolate

Objects

pathPlannerRRT | driving.Path | vehicleDimensions

Topics

“Automated Parking Valet”

interpolate

Package: driving

Interpolate poses along planned vehicle path

Syntax

```
poses = interpolate(refPath)
poses = interpolate(refPath,lengths)
[poses,directions] = interpolate( ___ )
```

Description

`poses = interpolate(refPath)` interpolates along the length of a reference path, returning transition poses. For more information, see Transition Poses on page 4-302.

`poses = interpolate(refPath,lengths)` interpolates poses at specified points along the length of the path. In addition to including poses corresponding to specified lengths, `poses` also includes the transition poses.

`[poses,directions] = interpolate(___)` also returns the motion directions of the vehicle at each pose, using inputs from any of the preceding syntaxes.

Examples

Plan Path and Check Its Validity

Plan a vehicle path through a parking lot by using the optimal rapidly exploring random tree (RRT*) algorithm. Check that the path is valid, and then plot the transition poses along the path.

Load a costmap of a parking lot. Plot the costmap to see the parking lot and inflated areas for the vehicle to avoid.

```
data = load('parkingLotCostmap.mat');
costmap = data.parkingLotCostmap;
plot(costmap)
```

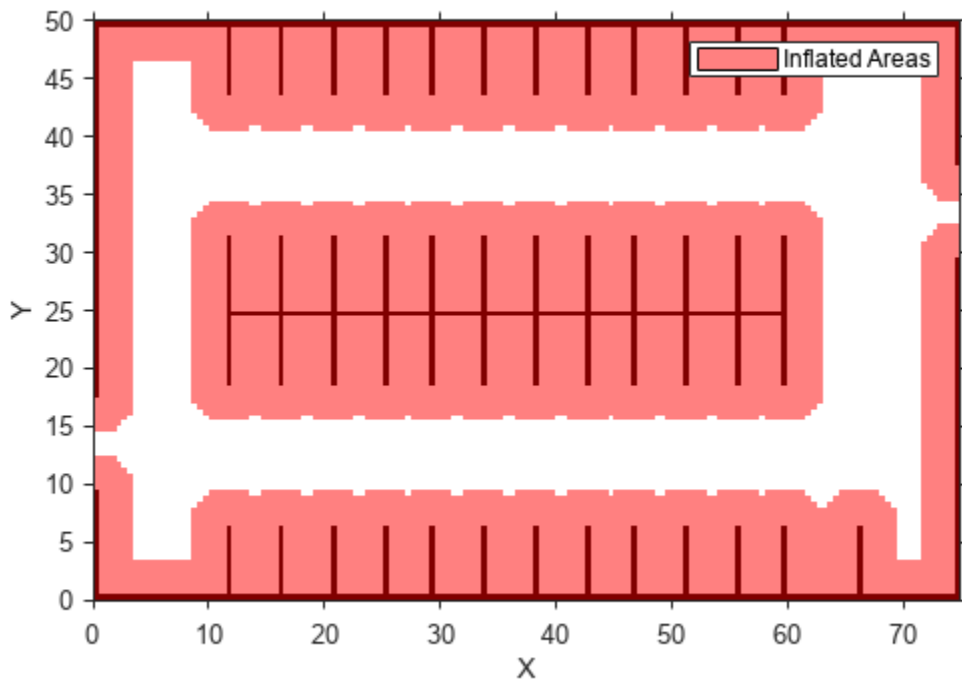

Define start and goal poses for the vehicle as $[x, y, \theta]$ vectors. World units for the (x,y) locations are in meters. World units for the θ orientation angles are in degrees.

```
startPose = [4, 4, 90]; % [meters, meters, degrees]
goalPose = [30, 13, 0];
```

Use a `pathPlannerRRT` object to plan a path from the start pose to the goal pose.

```
planner = pathPlannerRRT(costmap);
refPath = plan(planner,startPose,goalPose);
```

Check that the path is valid.

```
isPathValid = checkPathValidity(refPath,costmap)
isPathValid = logical
    1
```

Interpolate the transition poses along the path.

```
transitionPoses = interpolate(refPath);
```

Plot the planned path and the transition poses on the costmap.

```
hold on
plot(refPath,'DisplayName','Planned Path')
scatter(transitionPoses(:,1),transitionPoses(:,2),[],'filled', ...
```

```
'DisplayName','Transition Poses')
hold off
```

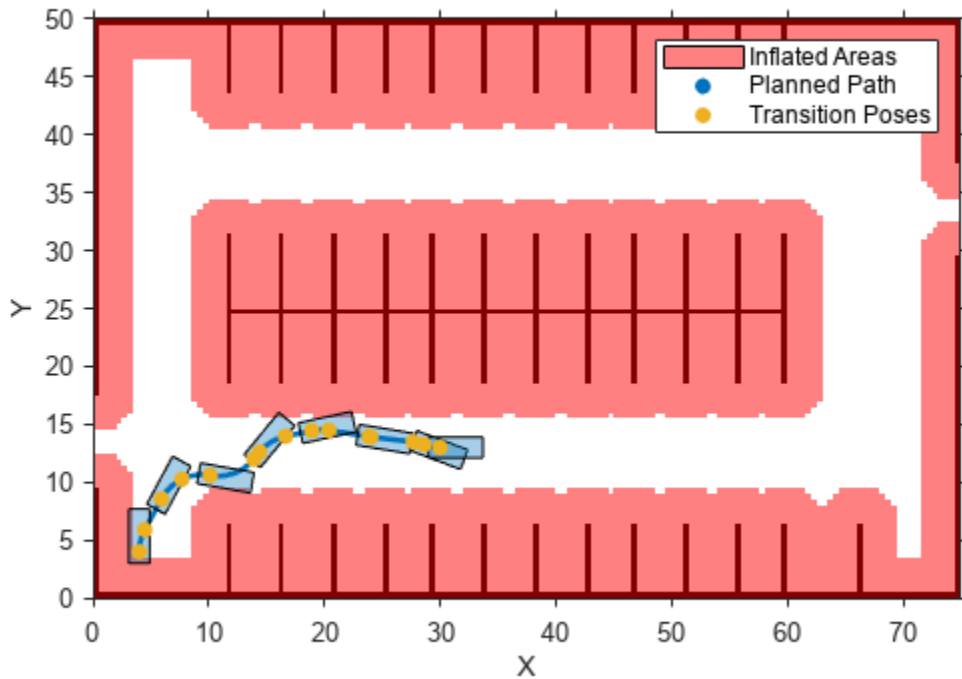

Plan Path and Interpolate Along Path

Plan a vehicle path through a parking lot by using the rapidly exploring random tree (RRT*) algorithm. Interpolate the poses of the vehicle at points along the path.

Load a costmap of a parking lot. Plot the costmap to see the parking lot and inflated areas for the vehicle to avoid.

```
data = load('parkingLotCostmap.mat');
costmap = data.parkingLotCostmap;
plot(costmap)
```

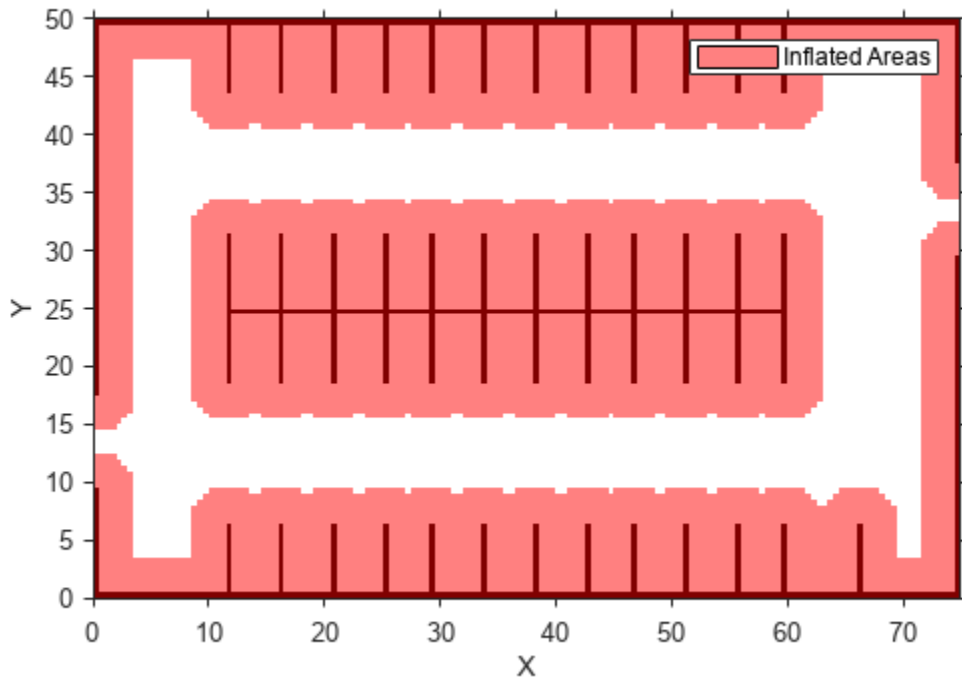

Define start and goal poses for the vehicle as $[x, y, \theta]$ vectors. World units for the (x,y) locations are in meters. World units for the θ orientation angles are in degrees.

```
startPose = [4, 4, 90]; % [meters, meters, degrees]
goalPose = [30, 13, 0];
```

Use a `pathPlannerRRT` object to plan a path from the start pose to the goal pose.

```
planner = pathPlannerRRT(costmap);
refPath = plan(planner,startPose,goalPose);
```

Interpolate the vehicle poses every 1 meter along the entire path.

```
lengths = 0 : 1 : refPath.Length;
poses = interpolate(refPath,lengths);
```

Plot the interpolated poses on the costmap.

```
plot(costmap)
hold on
scatter(poses(:,1),poses(:,2),'DisplayName','Interpolated Poses')
hold off
```

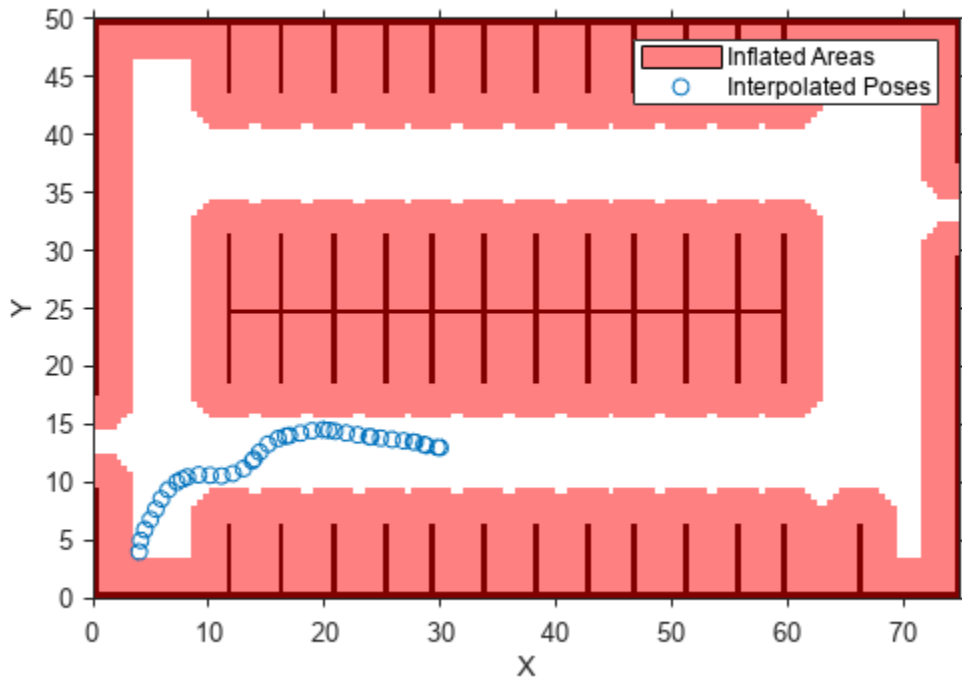

Input Arguments

refPath — Planned vehicle path

`driving.Path` object

Planned vehicle path, specified as a `driving.Path` object.

lengths — Points along length of path

real-valued vector

Points along the length of the path, specified as a real-valued vector. Values must be in the range from 0 to the length of the path, as determined by the `Length` property of `refPath`. The `interpolate` function interpolates poses at these specified points. `lengths` is in world units, such as meters.

Example: `poses = interpolate(refPath,0:0.1:refPath.Length)` interpolates poses every 0.1 meter along the entire length of the path.

Output Arguments

poses — Vehicle poses

m -by-3 matrix of $[x, y, \theta]$ vectors

Vehicle poses along the path, returned as an m -by-3 matrix of $[x, y, \theta]$ vectors. m is the number of returned poses.

x and y specify the location of the vehicle in world units, such as meters. θ specifies the orientation angle of the vehicle in degrees.

`poses` always includes the transition poses, even if you interpolate only at specified points along the path. If you do not specify the `lengths` input argument, then `poses` includes only the transition poses.

directions – Motion directions

m -by-1 vector of 1s (forward motion) and -1s (reverse motion)

Motion directions of vehicle poses, returned as an m -by-1 vector of 1s (forward motion) and -1s (reverse motion). m is the number of returned poses. Each element of `directions` corresponds to a row of `poses`.

More About

Transition Poses

A path is composed of multiple segments that are combinations of motions (for example, left turn, straight, and right turn). Transition poses are vehicle poses corresponding to the end of one motion and the beginning of another motion. They represent points along the path corresponding to a change in the direction or orientation of the vehicle. The `interpolate` function always returns transition poses, even if you interpolate only at specified points along the path.

The path length between transition poses is given by the `MotionLengths` property of the path segments. For example, consider the following path, which is a `driving.Path` object composed of a single Dubins path segment. This segment consists of three motions, as described by the `MotionLengths` and `MotionTypes` properties of the segment.

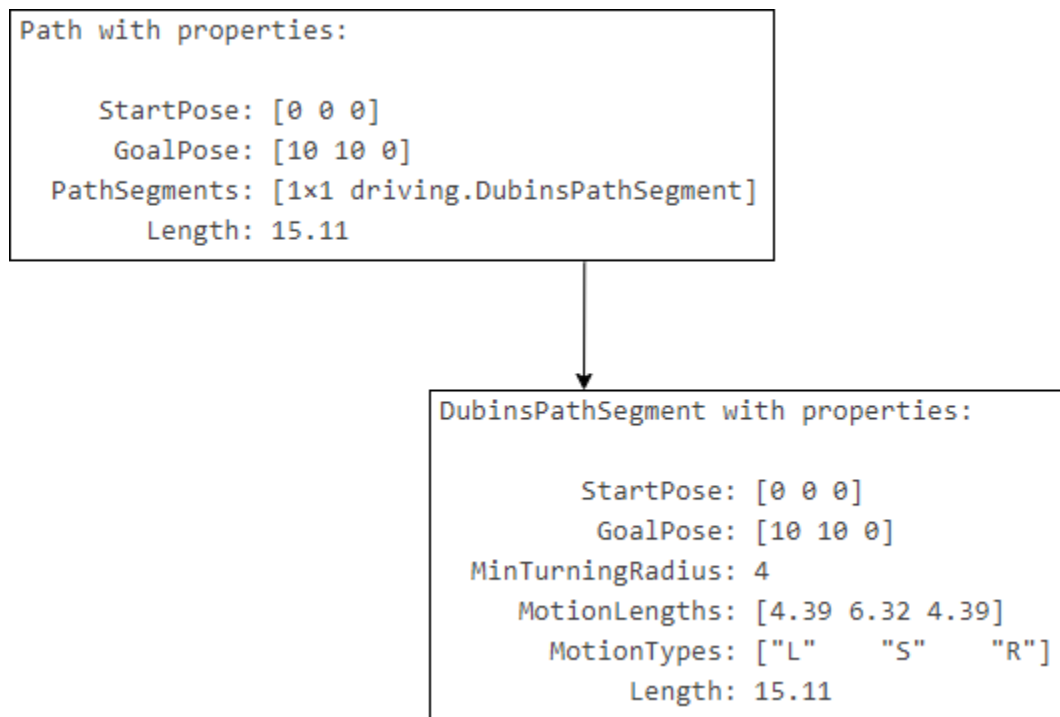

The `interpolate` function interpolates the following transition poses in this order:

- 1 The initial pose of the vehicle, StartPose.
- 2 The pose after the vehicle turns left ("L") for 4.39 meters at its maximum steering angle.
- 3 The pose after the vehicle goes straight ("S") for 6.32 meters.
- 4 The pose after the vehicle turns right ("R") for 4.39 meters at its maximum steering angle. This pose is also the goal pose, because it is the last pose of the entire path.

The plot shows these transition poses, which are $[x, y, \theta]$ vectors. x and y specify the location of the vehicle in world units, such as meters. θ specifies the orientation angle of the vehicle in degrees.

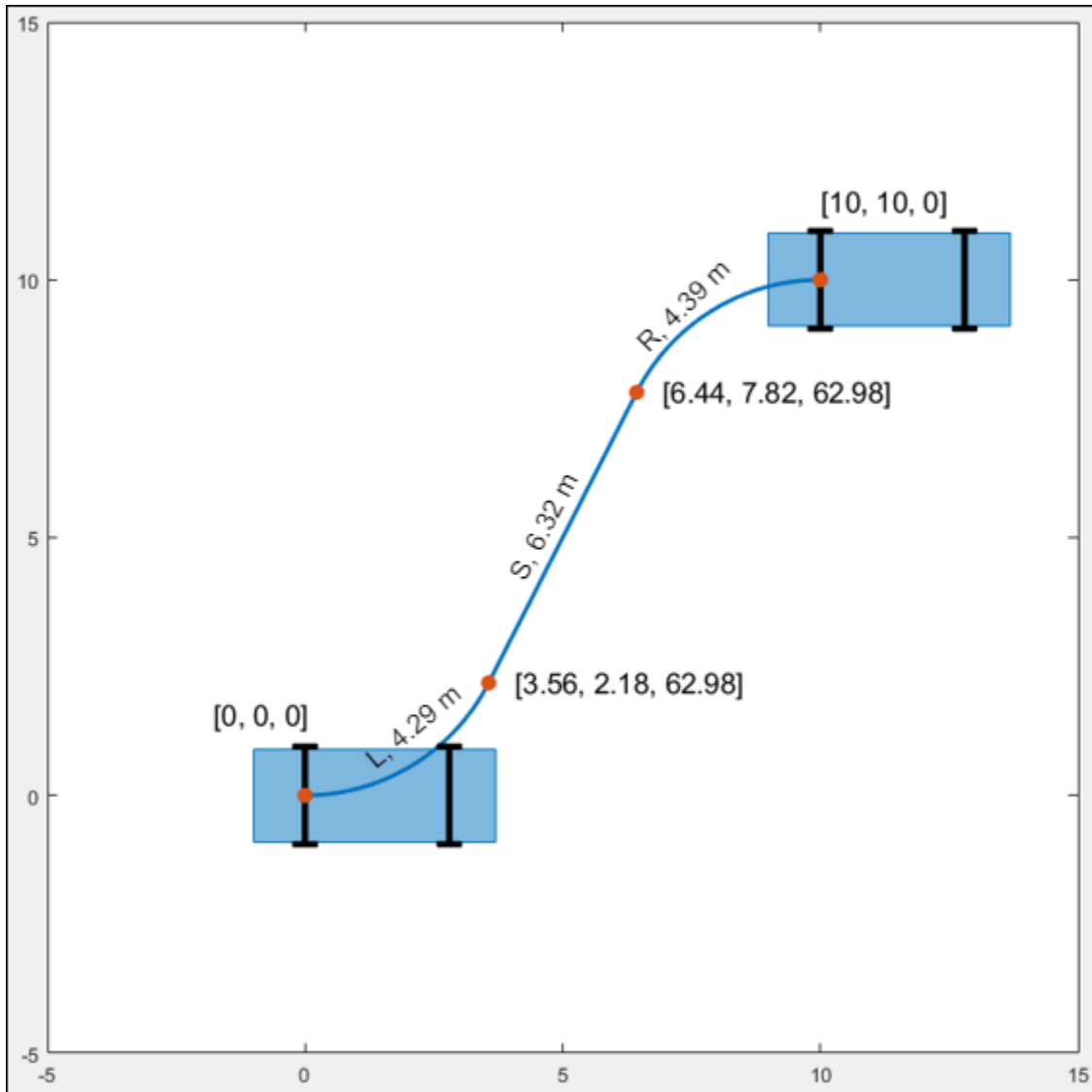

Version History

Introduced in R2018b

Extended Capabilities

C/C++ Code Generation

Generate C and C++ code using MATLAB® Coder™.

See Also

Functions

checkPathValidity | smoothPathSpline

Objects

pathPlannerRRT | driving.Path

Topics

“Automated Parking Valet”

driving.DubinsPathSegment

Dubins path segment

Description

A `driving.DubinsPathSegment` object represents a segment of a planned vehicle path that was connected using the Dubins connection method [1]. A Dubins path segment is composed of a sequence of three motions. Each motion is one of these types:

- Straight
- Left turn at the maximum steering angle of the vehicle
- Right turn at the maximum steering angle of the vehicle

A vehicle path composed of Dubins path segments allows motion in the forward direction only.

The `driving.DubinsPathSegment` objects that represent a path are stored in the `PathSegments` property of a `driving.Path` object. These paths are planned by a `pathPlannerRRT` object whose `ConnectionMethod` property is set to 'Dubins'.

Properties

StartPose — Initial pose of vehicle

$[x, y, \theta]$ vector

This property is read-only.

Initial pose of the vehicle at the start of the path segment, specified as an $[x, y, \theta]$ vector. x and y are in world units, such as meters. θ is in degrees.

GoalPose — Goal pose of vehicle

$[x, y, \theta]$ vector

This property is read-only.

Goal pose of the vehicle at the end of the path segment, specified as an $[x, y, \theta]$ vector. x and y are in world units, such as meters. θ is in degrees.

MinTurningRadius — Minimum turning radius of vehicle

positive real scalar

This property is read-only.

Minimum turning radius of the vehicle, in world units, specified as a positive real scalar. This value corresponds to the radius of the turning circle at the maximum steering angle of the vehicle.

MotionLengths — Length of each motion

three-element real-valued vector

This property is read-only.

Length of each motion in the path segment, in world units, specified as a three-element real-valued vector. Each motion length corresponds to a motion type specified in `MotionTypes`.

MotionTypes — Type of each motion

three-element string array

This property is read-only.

Type of each motion in the path segment, specified as a three-element string array. Valid values are shown in this table.

Motion Type	Description
"S"	Straight
"L"	Left turn at the maximum steering angle of the vehicle
"R"	Right turn at the maximum steering angle of the vehicle

Each motion type corresponds to a motion length specified in `MotionLengths`.

Example: ["R" "S" "R"]

Length — Length of path segment

positive real scalar

This property is read-only.

Length of the path segment, in world units, specified as a positive real scalar.

Examples

Plan Path Using Dubins Path Segments

Plan a vehicle path through a parking lot by using the optimal rapidly exploring random tree (RRT*) algorithm. The planned path is composed of a sequence of Dubins path segments. Check that the path is valid, and then plot the transition poses along the path.

Load a costmap of a parking lot. Plot the costmap to see the parking lot and inflated areas for the vehicle to avoid.

```
data = load('parkingLotCostmapReducedInflation.mat');
costmap = data.parkingLotCostmapReducedInflation;
plot(costmap)
```

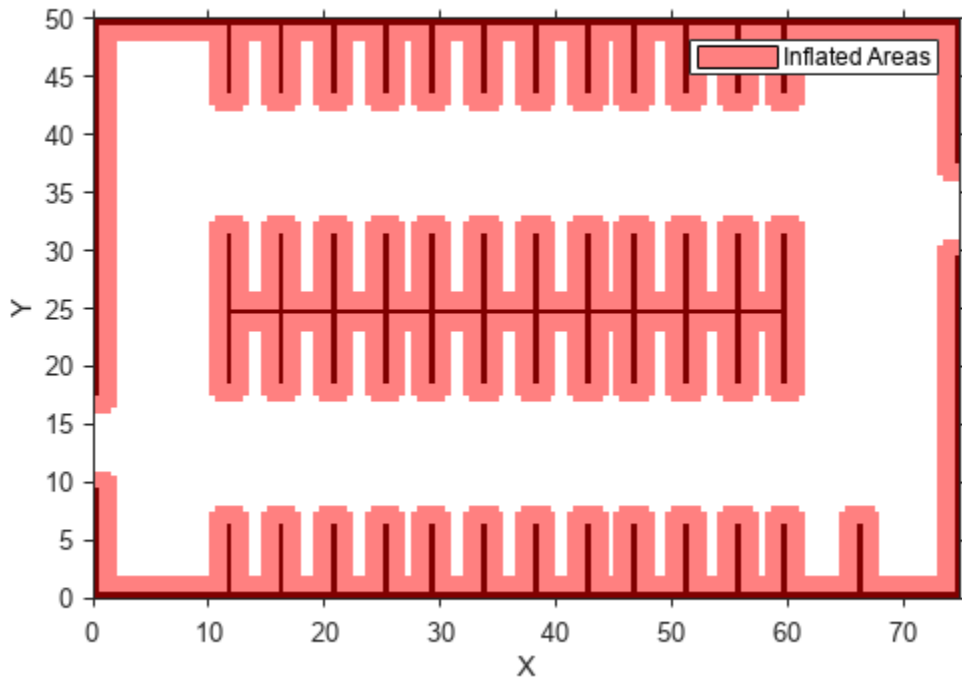

Define start and goal poses for the vehicle as $[x, y, \theta]$ vectors. World units for the (x,y) locations are in meters. World units for the θ orientation angles are in degrees.

```
startPose = [4, 4, 90]; % [meters, meters, degrees]
goalPose = [53.3, 19, 90];
```

Use a pathPlannerRRT object to plan a path from the start pose to the goal pose. Set the ConnectionMethod property of the pathPlannerRRT object to 'Dubins'.

```
planner = pathPlannerRRT(costmap);
planner.ConnectionMethod = 'Dubins';
refPath = plan(planner,startPose,goalPose);
```

Check that the path is valid.

```
isPathValid = checkPathValidity(refPath,costmap)
isPathValid = logical
    1
```

Interpolate the transition poses along the path.

```
transitionPoses = interpolate(refPath);
```

Plot the planned path and the transition poses on the costmap.

```
hold on
plot(refPath,'DisplayName','Planned Path')
```

```
scatter(transitionPoses(:,1),transitionPoses(:,2),[],'filled', ...
        'DisplayName','Transition Poses')
hold off
```

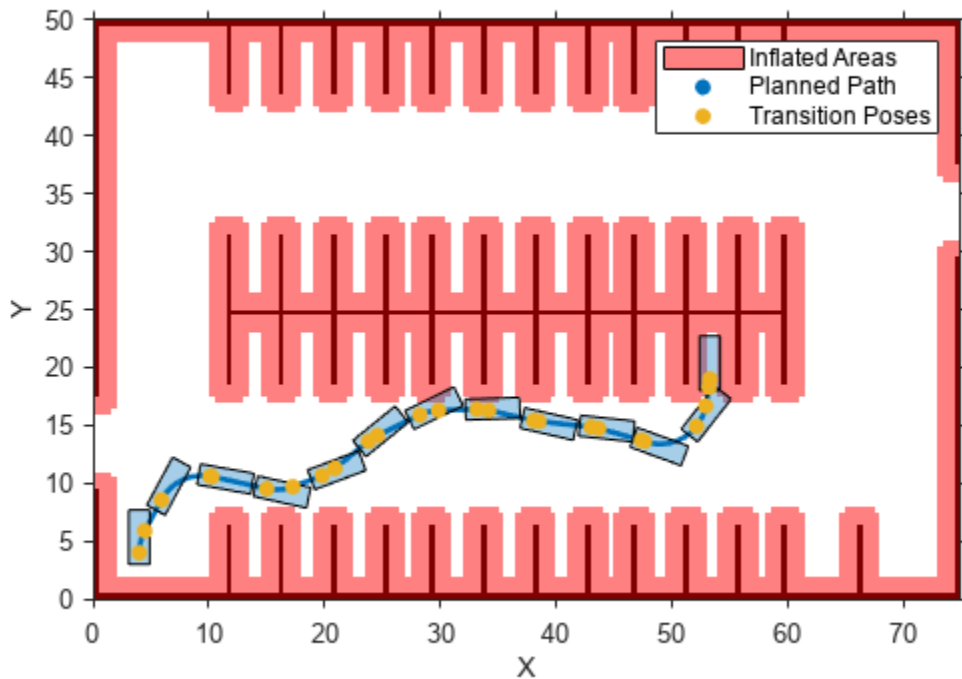

Notice that the path from the start pose to the goal pose does not require a reverse motion. Hence, the planned path is valid. In scenarios where a reverse motion is required to reach the goal pose, use Reeds-Shepp path segments as Dubins path segments do not allow reverse motion.

Version History

Introduced in R2018b

References

[1] Shkel, Andrei M., and Vladimir Lumelsky. "Classification of the Dubins Set." *Robotics and Autonomous Systems*. Vol. 34, Number 4, 2001, pp. 179-202.

Extended Capabilities

C/C++ Code Generation

Generate C and C++ code using MATLAB® Coder™.

Usage notes and limitations:

- Only one-dimensional indexing is supported.

See Also

Objects

`pathPlannerRRT` | `driving.Path` | `driving.ReedsSheppPathSegment`

Topics

“Automated Parking Valet”

driving.ReedsSheppPathSegment

Reeds-Shepp path segment

Description

A `driving.ReedsSheppPathSegment` object represents a segment of a planned vehicle path that was connected using the Reeds-Shepp connection method [1]. A Reeds-Shepp path segment is composed of a sequence of three to five motions. Each motion is one of these types:

- Straight (forward or reverse)
- Left turn at the maximum steering angle of the vehicle (forward or reverse)
- Right turn at the maximum steering angle of the vehicle (forward or reverse)

The `driving.ReedsSheppPathSegment` objects that represent a path are stored in the `PathSegments` property of a `driving.Path` object. These paths are planned by a `pathPlannerRRT` object whose `ConnectionMethod` property is set to 'Reeds-Shepp'.

Properties

StartPose — Initial pose of vehicle

$[x, y, \theta]$ vector

This property is read-only.

Initial pose of the vehicle at the start of the path segment, specified as an $[x, y, \theta]$ vector. x and y are in world units, such as meters. θ is in degrees.

GoalPose — Goal pose of vehicle

$[x, y, \theta]$ vector

This property is read-only.

Goal pose of the vehicle at the end of the path segment, specified as an $[x, y, \theta]$ vector. x and y are in world units, such as meters. θ is in degrees.

MinTurningRadius — Minimum turning radius of vehicle

positive real scalar

This property is read-only.

Minimum turning radius of the vehicle, in world units, specified as a positive real scalar. This value corresponds to the radius of the turning circle at the maximum steering angle of the vehicle.

MotionLengths — Length of each motion

five-element real-valued vector

This property is read-only.

Length of each motion in the path segment, in world units, specified as a five-element real-valued vector. Each motion length corresponds to a motion type specified in `MotionTypes` and a motion direction specified in `MotionDirections`.

When a path segment requires fewer than five motions, the remaining `MotionLengths` elements are set to 0. The remaining `MotionTypes` elements are set to "N" (no motion).

MotionTypes – Type of each motion

five-element string array

This property is read-only.

Type of each motion in the path segment, specified as a five-element string array. Valid values are shown in this table.

Motion Type	Description
"S"	Straight (forward or reverse)
"L"	Left turn at the maximum steering angle of the vehicle (forward or reverse)
"R"	Right turn at the maximum steering angle of the vehicle (forward or reverse)
"N"	No motion

`MotionTypes` contains a minimum of three motions, specified as a combination of "S", "L", and "R" elements. If a path segment has fewer than five motions, the remaining elements of `MotionTypes` are "N" (no motion).

Each motion type corresponds to a motion length specified in `MotionLengths` and a motion direction specified in `MotionDirections`.

Example: ["R" "S" "R" "L" "N"]

MotionDirections – Direction of each motion

five-element vector of 1s (forward motion) and -1s (reverse motion)

This property is read-only.

Direction of each motion in the path segment, specified as a five-element vector of 1s (forward motion) and -1s (reverse motion). Each motion direction corresponds to a motion length specified in `MotionLengths` and a motion type specified in `MotionTypes`.

When no motion occurs, that is, when a `MotionTypes` value is "N", then the corresponding `MotionDirections` element is 1.

Example: [-1 1 -1 1 1]

Length – Length of path segment

positive real scalar

This property is read-only.

Length of the path segment, in world units, specified as a positive real scalar.

Examples

Plan Path Using Reeds-Shepp Path Segments

Plan a vehicle path through a parking lot by using the optimal rapidly exploring random tree (RRT*) algorithm. The planned path is composed of a sequence of Reeds-Shepp path segments. Check that the path is valid, and then plot the transition poses along the path.

Load a costmap of a parking lot. Plot the costmap to see the parking lot and inflated areas for the vehicle to avoid.

```
data = load('parkingLotCostmapReducedInflation.mat');
costmap = data.parkingLotCostmapReducedInflation;
plot(costmap)
```

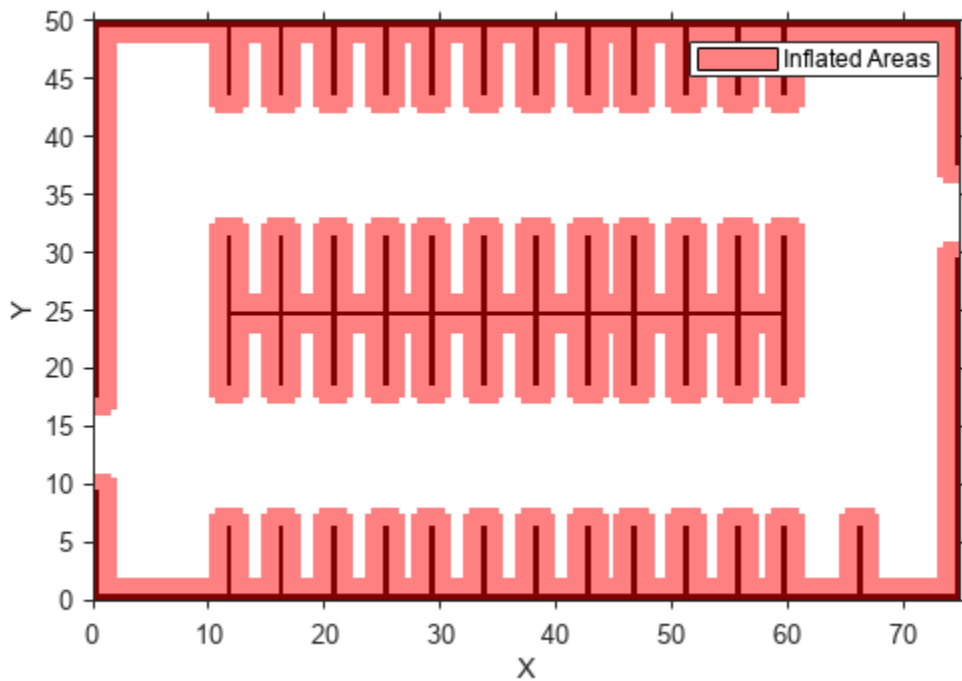

Define start and goal poses for the vehicle as $[x, y, \theta]$ vectors. World units for the (x,y) locations are in meters. World units for the θ orientation angles are in degrees.

```
startPose = [4, 4, 90]; % [meters, meters, degrees]
goalPose = [48.75, 29.75, 90];
```

Use a `pathPlannerRRT` object to plan a path from the start pose to the goal pose. Set the `ConnectionMethod` property of the `pathPlannerRRT` object to 'Reeds-Shepp'.

```

planner = pathPlannerRRT(costmap);
planner.ConnectionMethod = 'Reeds-Shepp';
refPath = plan(planner,startPose,goalPose);

```

Check that the path is valid.

```
isPathValid = checkPathValidity(refPath,costmap)
```

```
isPathValid = logical
    1
```

Interpolate the transition poses along the path.

```
transitionPoses = interpolate(refPath);
```

Plot the planned path and the transition poses on the costmap.

```

hold on
plot(refPath,'DisplayName','Planned Path')
scatter(transitionPoses(:,1),transitionPoses(:,2),[],'filled', ...
    'DisplayName','Transition Poses')
hold off

```

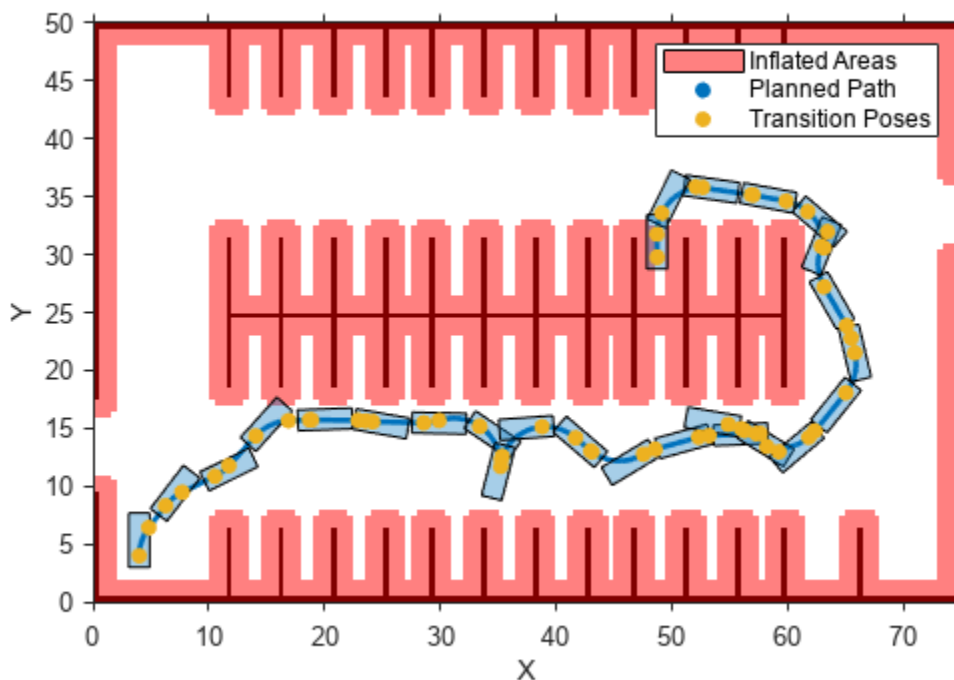

Notice that the path from the start pose to the goal pose requires at least one reverse motion before sliding into the parking spot at the goal position. In such scenarios where a reverse motion is required to reach the goal pose, Reeds-Shepp path segments are useful as Dubins path segments do not allow reverse motion.

Version History

Introduced in R2018b

References

- [1] Reeds, J. A., and L. A. Shepp. "Optimal Paths for a Car That Goes Both Forwards and Backwards." *Pacific Journal of Mathematics*. Vol. 145, Number 2, 1990, pp. 367-393.

Extended Capabilities

C/C++ Code Generation

Generate C and C++ code using MATLAB® Coder™.

Usage notes and limitations:

- Only one-dimensional indexing is supported.

See Also

Objects

`pathPlannerRRT` | `driving.Path` | `driving.DubinsPathSegment`

Topics

"Automated Parking Valet"

drivingScenario

Create driving scenario

Description

The `drivingScenario` object represents a 3-D arena containing roads, parking lots, vehicles, pedestrians, barriers, and other aspects of a driving scenario. Use this object to model realistic traffic scenarios and to generate synthetic detections for testing controllers or sensor fusion algorithms.

- To add roads, use the `road` function. To specify lanes in the roads, create a `lanespec` object. You can also import roads from a third-party road network by using the `roadNetwork` function.
- To add parking lots, use the `parkingLot` function.
- To add actors (cars, pedestrians, bicycles, and so on), use the `actor` function. To add actors with properties designed specifically for vehicles, use the `vehicle` function. To add barriers, use the `barrier` function. All actors, including vehicles and barriers, are modeled as cuboids (box shapes) with unique actor IDs.
- To simulate a scenario, call the `advance` function in a loop, which advances the simulation one time step at a time.

You can also create driving scenarios interactively by using the **Driving Scenario Designer** app. In addition, you can export `drivingScenario` objects from the app to produce scenario variations for use in either the app or in Simulink. For more details, see “Create Driving Scenario Variations Programmatically”.

Creation

Syntax

```
scenario = drivingScenario
scenario = drivingScenario(Name,Value)
```

Description

`scenario = drivingScenario` creates an empty driving scenario.

`scenario = drivingScenario(Name,Value)` sets the `SampleTime`, `StopTime`, and `GeoReference` properties using name-value pairs. For example, `drivingScenario('GeoReference',[42.3 -71.0 0])` sets the geographic origin of the scene to a latitude-longitude coordinate of (42.3, -71.0) and an altitude of 0.

Properties

SampleTime — Time interval between scenario simulation steps

0.01 (default) | positive real scalar

Time interval between scenario simulation steps, specified as a positive real scalar. Units are in seconds.

Example: 1.5

StopTime — End time of simulation

Inf (default) | positive real scalar

End time of simulation, specified as a positive real scalar. Units are in seconds. The default `StopTime` of `Inf` causes the simulation to end when the first actor reaches the end of its trajectory.

Example: 60.0

SimulationTime — Current time of simulation

nonnegative real scalar

This property is read-only.

Current time of the simulation, specified as a nonnegative real scalar. To reset the time to zero, call the `restart` function. Units are in seconds.

IsRunning — Simulation state

true | false

This property is read-only.

Simulation state, specified as `true` or `false`. If the simulation is running, `IsRunning` is `true`.

Actors — Actors and vehicles contained in scenario

heterogeneous array of `Actor` and `Vehicle` objects

This property is read-only.

Actors and vehicles contained in the scenario, specified as a heterogeneous array of `Actor` and `Vehicle` objects. To add actors and vehicles to a driving scenario, use the `actor` and `vehicle` functions.

Barriers — Barriers contained in scenario

heterogeneous array of `Barrier` objects

This property is read-only.

Barriers contained in the scenario, specified as a heterogeneous array of `Barrier` objects. To add barriers to a driving scenario, use the `barrier` function.

ParkingLots — Parking lots contained in scenario

heterogeneous array of `ParkingLot` objects

This property is read-only.

Parking lots contained in the scenario, specified as a heterogeneous array of `ParkingLot` objects. To add parking lots to a driving scenario, use the `parkingLot` function.

GeoReference — Geographic coordinates of road network origin

three-element numeric row vector of form [lat, lon, alt]

This property is read-only.

Geographic coordinates of the road network origin, specified as a three-element numeric row vector of the form [lat, lon, alt], where:

- `lat` is the latitude of the coordinate in degrees.
- `lon` is the longitude of the coordinate in degrees.
- `alt` is the altitude of the coordinate in meters.

These values are with respect to the WGS84 reference ellipsoid, which is a standard ellipsoid used by GPS data.

You can set `GeoReference` when you create the driving scenario. The `roadNetwork` function also sets this property when you import roads into an empty driving scenario.

- If you import roads by specifying coordinates, then the `roadNetwork` function sets `GeoReference` to the first (or only) specified coordinate.
- If you import roads by specifying a region or map file, then the `roadNetwork` sets `GeoReference` to the center point of the region or map.

The `roadNetwork` function overrides any previously set `GeoReference` value.

In the **Driving Scenario Designer** app, when you import map data and export a `drivingScenario` object, the `GeoReference` property of that object is set to the geographic reference of the app scenario.

By specifying these coordinates as the origin in the `latLon2local` function, you can convert geographic coordinates of a driving route into the local coordinates of a driving scenario. Then, you can specify this converted route as a vehicle trajectory in the scenario.

If your driving scenario does not use geographic coordinates, then `GeoReference` is an empty array, `[]`.

Object Functions

Scenarios

<code>advance</code>	Advance driving scenario simulation by one time step
<code>plot</code>	Plot driving scenario
<code>record</code>	Run driving scenario and record actor states
<code>restart</code>	Restart driving scenario simulation from beginning
<code>updatePlots</code>	Update driving scenario plots
<code>export</code>	Export driving scenario to ASAM OpenDRIVE, ASAM OpenSCENARIO or RoadRunner HD Map file

Actors

<code>actor</code>	Add actor to driving scenario
<code>actorPoses</code>	Positions, velocities, and orientations of actors in driving scenario
<code>actorProfiles</code>	Physical and radar characteristics of actors in driving scenario
<code>vehicle</code>	Add vehicle to driving scenario
<code>barrier</code>	Add a barrier to a driving scenario
<code>chasePlot</code>	Ego-centric projective perspective plot
<code>trajectory</code>	Create actor or vehicle trajectory in driving scenario
<code>smoothTrajectory</code>	Create smooth, jerk-limited actor trajectory in driving scenario
<code>targetPoses</code>	Target positions and orientations relative to host vehicle

targetOutlines	Outlines of targets viewed by actor
driving.scenario.targetsToEgo	Convert target poses from scenario to ego coordinates
driving.scenario.targetsToScenario	Convert target poses from ego to scenario coordinates

Roads

road	Add road to driving scenario or road group
roadNetwork	Add road network to driving scenario
roadBoundaries	Get road boundaries
driving.scenario.roadBoundariesToEgo	Convert road boundaries to ego vehicle coordinates

Lanes

lanespec	Create road lane specifications
laneMarking	Create road lane marking object
laneMarkingVertices	Lane marking vertices and faces in driving scenario
currentLane	Get current lane of actor
laneBoundaries	Get lane boundaries of actor lane
clothoidLaneBoundary	Clothoid-shaped lane boundary model
computeBoundaryModel	Compute lane boundary points from clothoid lane boundary model
laneType	Create road lane type object

Parking Lots

parkingLot	Add parking lot to driving scenario
parkingSpace	Define parking space for parking lot
insertParkingSpaces	Insert parking spaces into parking lot
parkingLaneMarkingVertices	Parking lane marking vertices and faces in driving scenario

Examples

Create Driving Scenario with Multiple Actors and Roads

Create a driving scenario containing a curved road, two straight roads, and two actors: a car and a bicycle. Both actors move along the road for 60 seconds.

Create the driving scenario object.

```
scenario = drivingScenario('SampleTime',0.1,'StopTime',60);
```

Create the curved road using road center points following the arc of a circle with an 800-meter radius. The arc starts at 0°, ends at 90°, and is sampled at 5° increments.

```
angs = [0:5:90]';  
R = 800;  
roadcenters = R*[cosd(angs) sind(angs) zeros(size(angs))];  
roadwidth = 10;  
cr = road(scenario,roadcenters,roadwidth);
```

Add two straight roads with the default width, using road center points at each end. To the first straight road add barriers on both road edges.

```
roadcenters = [700 0 0; 100 0 0];  
sr1 = road(scenario,roadcenters);
```



```

barrier(scenario,sr1)
barrier(scenario,sr1,'RoadEdge','left')
roadcenters = [400 400 0; 0 0 0];
road(scenario,roadcenters);

```

Get the road boundaries.

```

rbdry = roadBoundaries(scenario);

```

Add a car and a bicycle to the scenario. Position the car at the beginning of the first straight road.

```

car = vehicle(scenario,'ClassID',1,'Position',[700 0 0], ...
    'Length',3,'Width',2,'Height',1.6);

```

Position the bicycle farther down the road.

```

bicycle = actor(scenario,'ClassID',3,'Position',[706 376 0]', ...
    'Length',2,'Width',0.45,'Height',1.5);

```

Plot the scenario.

```

plot(scenario,'Centerline','on','RoadCenters','on');
title('Scenario');

```

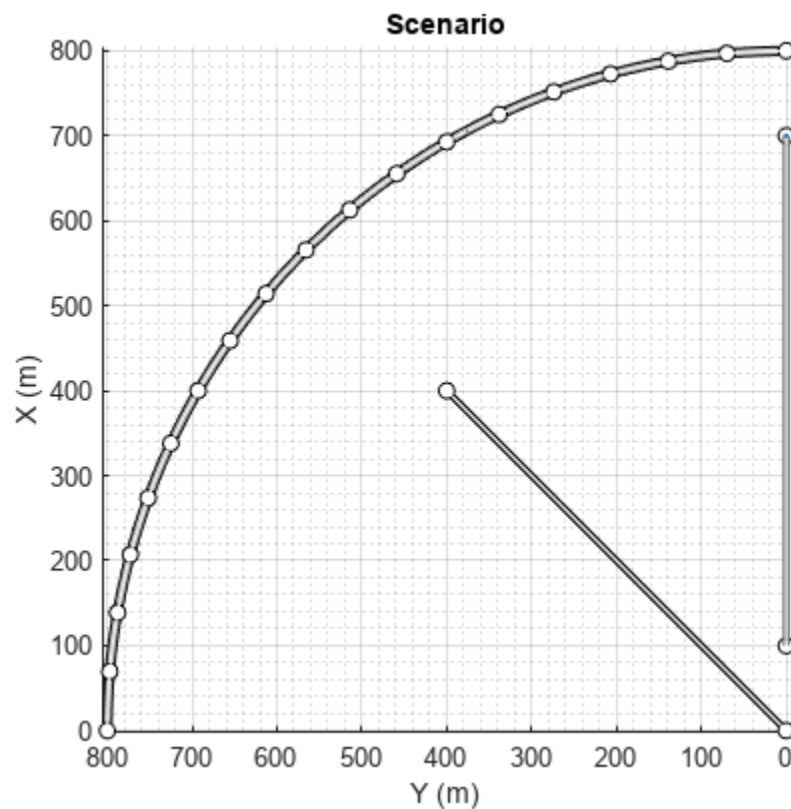

Display the actor poses and profiles.

```

allActorPoses = actorPoses(scenario)

```

```
allActorPoses=242x1 struct array with fields:
```

```
ActorID  
Position  
Velocity  
Roll  
Pitch  
Yaw  
AngularVelocity
```

```
allActorProfiles = actorProfiles(scenario)
```

```
allActorProfiles=242x1 struct array with fields:
```

```
ActorID  
ClassID  
Length  
Width  
Height  
OriginOffset  
MeshVertices  
MeshFaces  
RCSPattern  
RCSAzimuthAngles  
RCSElevationAngles
```

Because there are barriers in this scenario, and each barrier segment is considered an actor, `actorPoses` and `actorProfiles` functions return the poses of all stationary and non-stationary actors. To only obtain the poses and profiles of non-stationary actors such as vehicles and bicycles, first obtain their corresponding actor IDs using the `scenario.actors.ActorID` property.

```
movableActorIDs = [scenario.actors.ActorID];
```

Then, use those IDs to filter only non-stationary actor poses and profiles.

```
movableActorPoseIndices = ismember([allActorPoses.ActorID],movableActorIDs);
```

```
movableActorPoses = allActorPoses(movableActorPoseIndices)
```

```
movableActorPoses=2x1 struct array with fields:
```

```
ActorID  
Position  
Velocity  
Roll  
Pitch  
Yaw  
AngularVelocity
```

```
movableActorProfiles = allActorProfiles(movableActorPoseIndices)
```

```
movableActorProfiles=2x1 struct array with fields:
```

```
ActorID  
ClassID  
Length  
Width  
Height  
OriginOffset  
MeshVertices
```

```

MeshFaces
RCSPattern
RCSAzimuthAngles
RCSElevationAngles

```

Show Target Outlines in Driving Scenario Simulation

Create a driving scenario and show how target outlines change as the simulation advances.

Create a driving scenario consisting of two intersecting straight roads. The first road segment is 45 meters long. The second straight road is 32 meters long with jersey barriers along both its edges, and intersects the first road. A car traveling at 12.0 meters per second along the first road approaches a running pedestrian crossing the intersection at 2.0 meters per second.

```

scenario = drivingScenario('SampleTime',0.1,'StopTime',1);
road1 = road(scenario,[-10 0 0; 45 -20 0]);
road2 = road(scenario,[-10 -10 0; 35 10 0]);
barrier(scenario,road1)
barrier(scenario,road1,'RoadEdge','left')
ped = actor(scenario,'ClassID',4,'Length',0.4,'Width',0.6,'Height',1.7);
car = vehicle(scenario,'ClassID',1);
pedspeed = 2.0;
carspeed = 12.0;
smoothTrajectory(ped,[15 -3 0; 15 3 0],pedspeed);
smoothTrajectory(car,[-10 -10 0; 35 10 0],carspeed);

```

Create an ego-centric chase plot for the vehicle.

```

chasePlot(car,'Centerline','on')

```

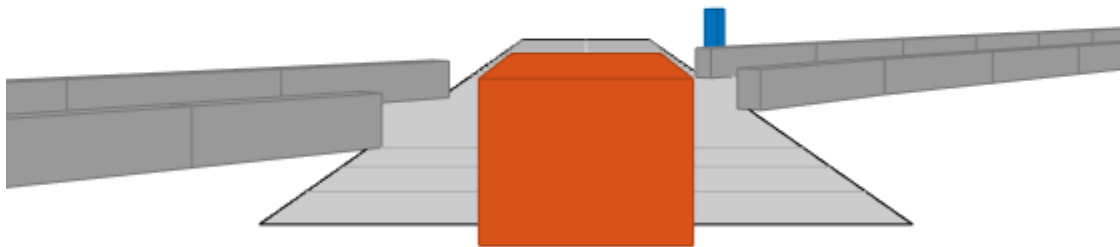

Create an empty bird's-eye plot and add an outline plotter and lane boundary plotter. Then, run the simulation. At each simulation step:

- Update the chase plot to display the road boundaries and target outlines.
- Update the bird's-eye plot to display the updated road boundaries and target outlines. The plot perspective is always with respect to the ego vehicle.

```
bepPlot = birdsEyePlot('XLim',[-50 50],'YLim',[-40 40]);
outlineplotter = outlinePlotter(bepPlot);
laneplotter = laneBoundaryPlotter(bepPlot);
legend('off')

while advance(scenario)
    rb = roadBoundaries(car);
    [position,yaw,length,width,originOffset,color] = targetOutlines(car);
    [bposition,byaw,blength,bwidth,boriginOffset,bcolor,barrierSegments] = targetOutlines(car,'B');
    plotLaneBoundary(laneplotter,rb)
    plotOutline(outlineplotter,position,yaw,length,width, ...
        'OriginOffset',originOffset,'Color',color)
    plotBarrierOutline(outlineplotter,barrierSegments,bposition,byaw,blength,bwidth, ...
        'OriginOffset',boriginOffset,'Color',bcolor)
    pause(0.01)
end
```

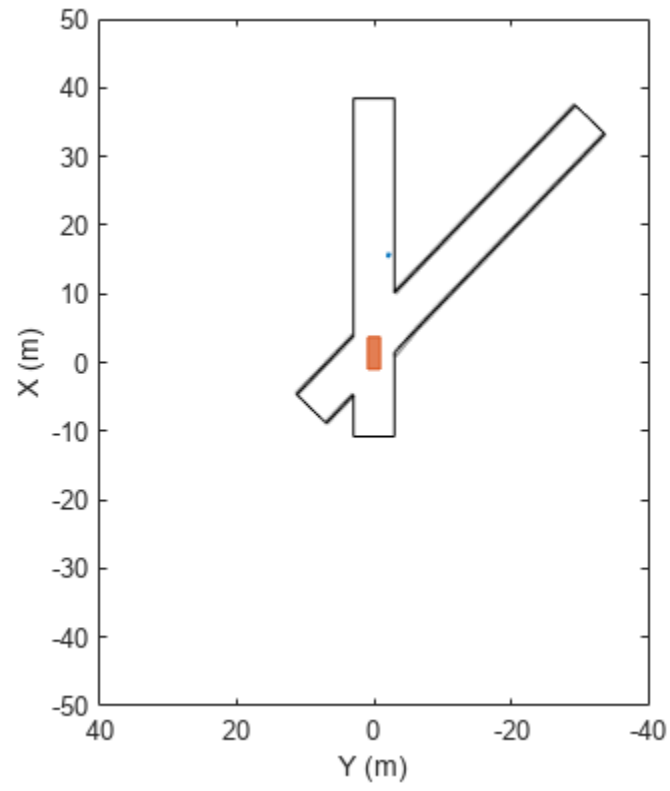

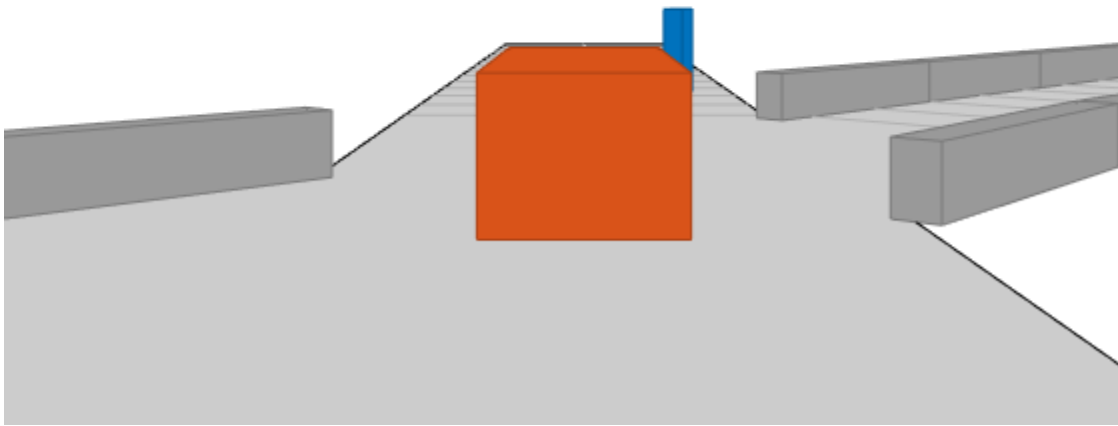

Generate Object and Lane Boundary Detections

Create a driving scenario containing an ego vehicle and a target vehicle traveling along a three-lane road. Detect the lane boundaries by using a vision detection generator.

```
scenario = drivingScenario;
```

Create a three-lane road by using lane specifications.

```
roadCenters = [0 0 0; 60 0 0; 120 30 0];  
lspc = lanespec(3);  
road(scenario,roadCenters,'Lanes',lspc);
```

Specify that the ego vehicle follows the center lane at 30 m/s.

```
egovehicle = vehicle(scenario,'ClassID',1);  
egopath = [1.5 0 0; 60 0 0; 111 25 0];  
egospeed = 30;  
smoothTrajectory(egovehicle,egopath,egospeed);
```

Specify that the target vehicle travels ahead of the ego vehicle at 40 m/s and changes lanes close to the ego vehicle.

```
targetcar = vehicle(scenario,'ClassID',1);  
targetpath = [8 2; 60 -3.2; 120 33];
```

```

targetspeed = 40;
smoothTrajectory(targetcar, targetpath, targetspeed);

```

Display a chase plot for a 3-D view of the scenario from behind the ego vehicle.

```
chasePlot(egovehicle)
```

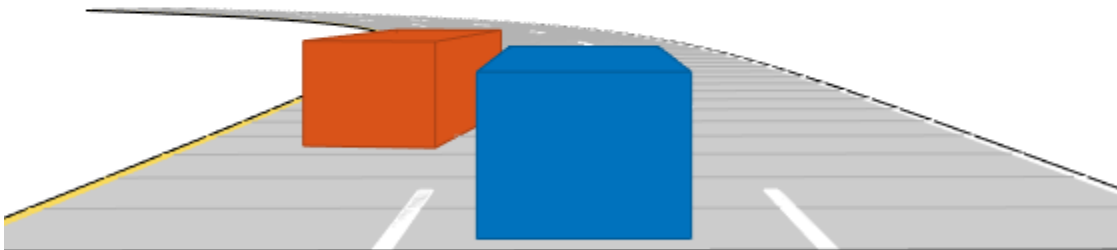

Create a vision detection generator that detects lanes and objects. The pitch of the sensor points one degree downward.

```

visionSensor = visionDetectionGenerator('Pitch',1.0);
visionSensor.DetectorOutput = 'Lanes and objects';
visionSensor.ActorProfiles = actorProfiles(scenario);

```

Run the simulation.

- 1 Create a bird's-eye plot and the associated plotters.
- 2 Display the sensor coverage area.
- 3 Display the lane markings.
- 4 Obtain ground truth poses of targets on the road.
- 5 Obtain ideal lane boundary points up to 60 m ahead.
- 6 Generate detections from the ideal target poses and lane boundaries.
- 7 Display the outline of the target.
- 8 Display object detections when the object detection is valid.

9 Display the lane boundary when the lane detection is valid.

```

bep = birdsEyePlot('XLim',[0 60],'YLim',[-35 35]);
caPlotter = coverageAreaPlotter(bep,'DisplayName','Coverage area', ...
    'FaceColor','blue');
detPlotter = detectionPlotter(bep,'DisplayName','Object detections');
lmPlotter = laneMarkingPlotter(bep,'DisplayName','Lane markings');
lbPlotter = laneBoundaryPlotter(bep,'DisplayName', ...
    'Lane boundary detections','Color','red');
olPlotter = outlinePlotter(bep);
plotCoverageArea(caPlotter,visionSensor.SensorLocation,...
    visionSensor.MaxRange,visionSensor.Yaw, ...
    visionSensor.FieldOfView(1));
while advance(scenario)
    [lmv,lmf] = laneMarkingVertices(egovehicle);
    plotLaneMarking(lmPlotter,lmv,lmf)
    tgtpose = targetPoses(egovehicle);
    lookaheadDistance = 0:0.5:60;
    lb = laneBoundaries(egovehicle,'XDistance',lookaheadDistance,'LocationType','inner');
    [obdets,nobdets,obValid,lb_dets,nlb_dets,lbValid] = ...
        visionSensor(tgtpose,lb,scenario.SimulationTime);
    [objposition,objyaw,objlength,objwidth,objoriginOffset,color] = targetOutlines(egovehicle);
    plotOutline(olPlotter,objposition,objyaw,objlength,objwidth, ...
        'OriginOffset',objoriginOffset,'Color',color)
    if obValid
        detPos = cellfun(@(d)d.Measurement(1:2),obdets,'UniformOutput',false);
        detPos = vertcat(zeros(0,2),cell2mat(detPos)');
        plotDetection(detPlotter,detPos)
    end
    if lbValid
        plotLaneBoundary(lbPlotter,vertcat(lb_dets.LaneBoundaries))
    end
end

```

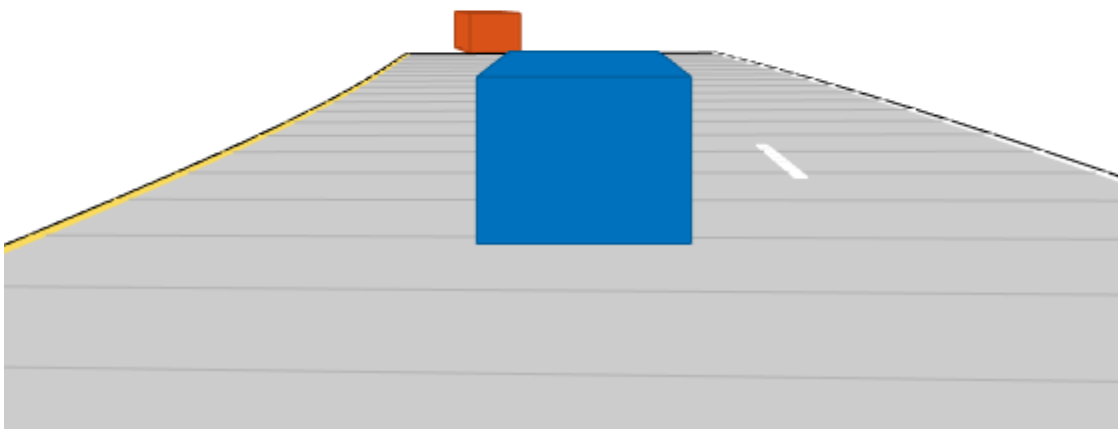

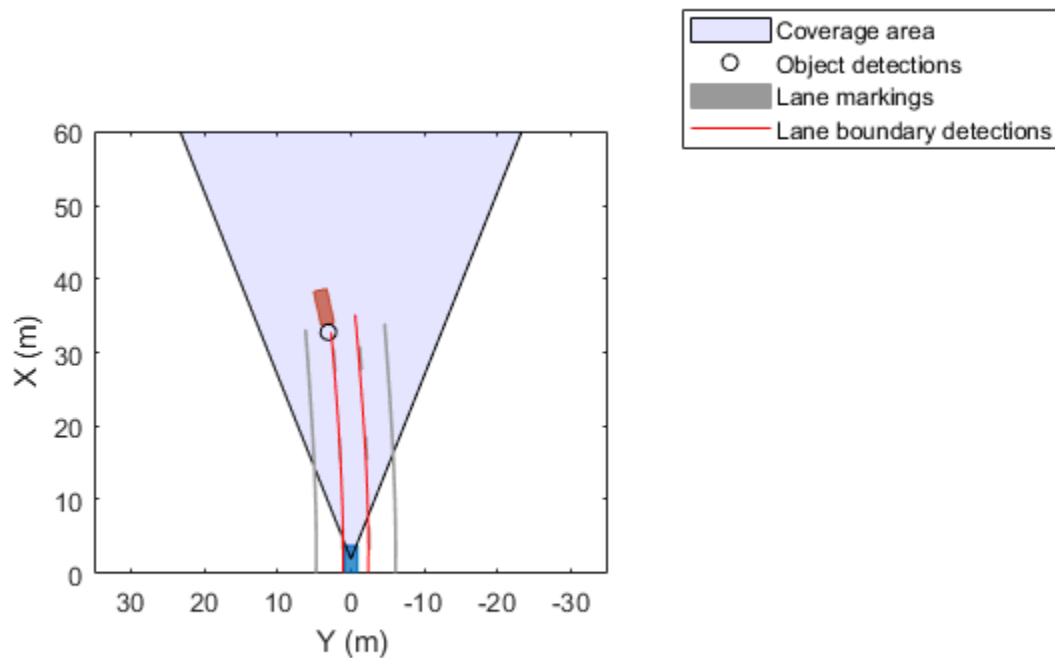
Add Sensors to Driving Scenario and Get Target Poses Using Sensor Input

In this example, you will add sensors to a driving scenario using the `addSensors` function and get ground-truth target poses based on the individual sensor inputs. Then, you process the ground-truth target poses into detections and visualize them.

Set Up Driving Scenario and Bird's-Eye-Plot

Create a driving scenario with an ego vehicle and two target vehicles. One target vehicle is in the front and the other is to the left of the ego-vehicle.

```
[scenario, egovehicle] = helperCreateDrivingScenario;
```

Configure a vision sensor to be mounted at the front of the ego vehicle.

```
visionSensor = visionDetectionGenerator(SensorIndex=1,SensorLocation=[4.0 0],Height=1.1,Pitch=1.0);
```

Configure an ultrasonic sensor to be mounted at the left side of the ego-vehicle.

```
leftUltrasonic = ultrasonicDetectionGenerator(SensorIndex=2,MountingLocation=[0.5 1 0.2],MountingAngle=90);
```

Create a bird's-eye-plot to visualize the driving scenario.

```
[detPlotter, lmPlotter, olPlotter, lulrdPlotter, luldetPlotter, bepAxes] = helperCreateBEP(visionSensor, leftUltrasonic, egovehicle);
```

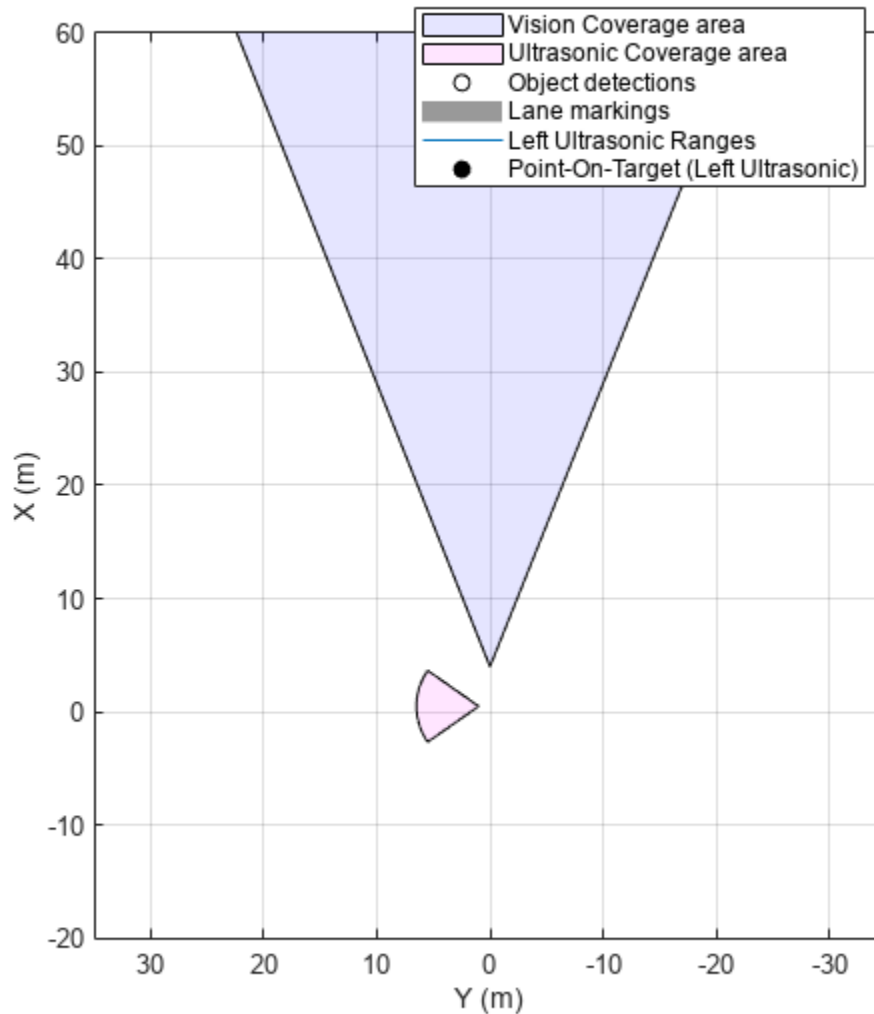

Add Sensors and Simulate Driving Scenario

Add both vision and ultrasonic sensors to the driving scenario using the `addSensors` function. You can add sensors to any vehicle in the driving scenario using the `addSensors` function by specifying the actor ID of the desired vehicle. In this example, specify the ego-vehicle actor ID.

```
addSensors(scenario, {visionSensor, leftUltrasonic}, egovehicle.ActorID);
```

Simulate the driving scenario. Note that you get separate target poses based on individual sensors by specifying their respective sensor IDs as inputs to the `targetPoses` function. This syntax returns the ground-truth poses of targets only within the range of the specified sensor. You then pass the ground-truth poses to their respective sensor models to generate detections and visualize them.

```
legend(bepAxes, 'show')
lookaheadDistance = 0:0.5:60;
while advance(scenario)

    lb = laneBoundaries(egovehicle, 'XDistance', lookaheadDistance, 'LocationType', 'inner');
    [lmv, lmf] = laneMarkingVertices(egovehicle);

    % Get ground-truth poses of targets in the range of vision and ultrasonic sensors separately
    tgtposeVision = targetPoses(scenario, visionSensor.SensorIndex);
    tgtposeUltrasonic = targetPoses(scenario, leftUltrasonic.SensorIndex);

    % Obtain detections based on targets only in range
    [obdets, obValid] = visionSensor(tgtposeVision, scenario.SimulationTime);
    [lobdets, lobValid] = leftUltrasonic(tgtposeUltrasonic, scenario.SimulationTime);

    helperPlotBEPVision(egovehicle, lmv, lmf, obdets, obValid, detPlotter, lmPlotter, olPlotter)
    helperPlotBEPUltrasonic(lobdets, lobValid, leftUltrasonic, lulrdPlotter, luldetPlotter)
end
```

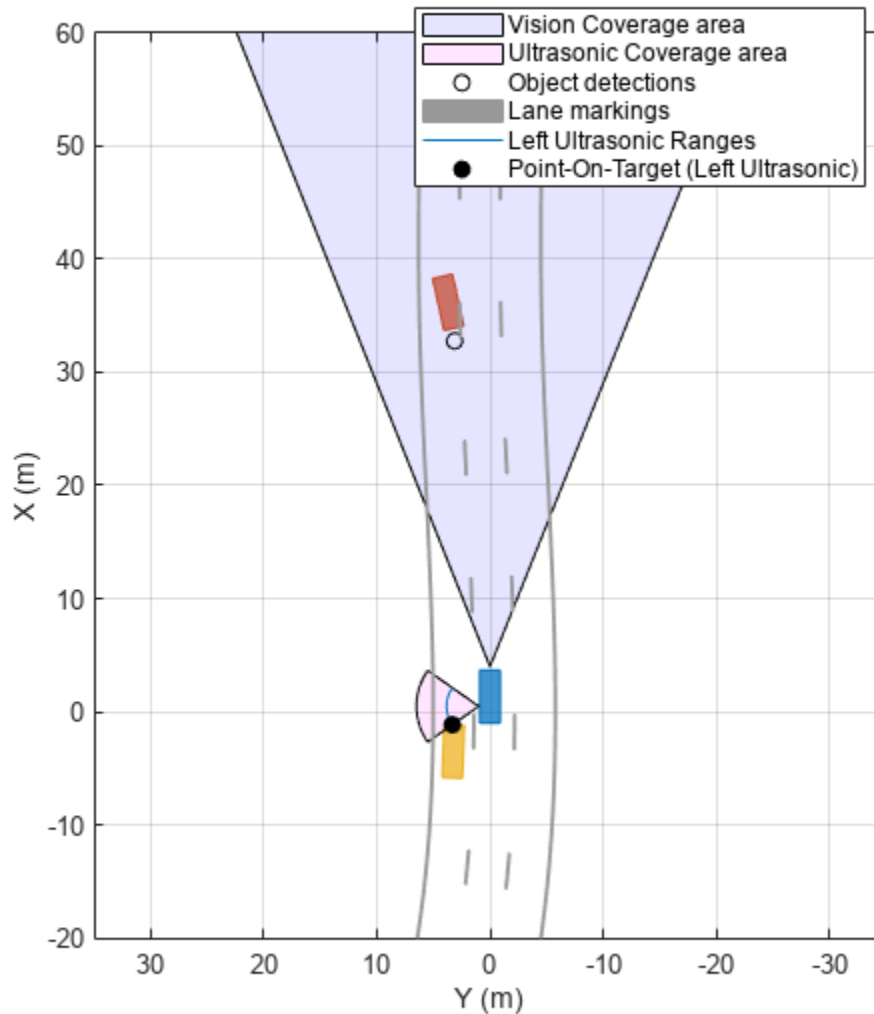

Helper Functions

`helperCreateDrivingScenario` creates a driving scenario by specifying the road and vehicle properties.

```
function [scenario, egovehicle] = helperCreateDrivingScenario
    scenario = drivingScenario;
    roadCenters = [-120 30 0; -60 0 0; 0 0 0; 60 0 0; 120 30 0; 180 60 0];
    lspc = lanespec(3);
    road(scenario, roadCenters, Lanes=lspc);

    % Create an ego vehicle that travels in the center lane at a velocity of 30 m/s.
    egovehicle = vehicle(scenario, ClassID=1);
    egopath = [1.5 0 0; 60 0 0; 111 25 0];
```

```

egospeed = 30;
smoothTrajectory(egovehicle, egopath, egospeed);

% Add a target vehicle that travels ahead of the ego vehicle at 30.5 m/s in the right lane,
ftargetcar = vehicle(scenario, ClassID=1);
ftargetpath = [8 2; 60 -3.2; 120 33];
ftargetspeed = 40;
smoothTrajectory(ftargetcar, ftargetpath, ftargetspeed);

% Add a second target vehicle that travels in the left lane at 32m/s.
ltargetcar = vehicle(scenario, ClassID=1);
ltargetpath = [-5.0 3.5 0; 60 3.5 0; 111 28.5 0];
ltargetspeed = 30;
smoothTrajectory(ltargetcar, ltargetpath, ltargetspeed);
end

```

helperCreateBEP creates a bird's-eye-plot for visualizing the driving scenario simulation.

```

function [detPlotter, lmPlotter, olPlotter, lulrdPlotter, luldetPlotter, bepAxes] = helperCreateBEP(scenario, egoVehicle, egoPath, egoSpeed, targetCar, targetPath, targetSpeed, secondTargetCar, secondTargetPath, secondTargetSpeed)
figureName = "BEP";
Figure = findobj('Type', 'Figure', Name=figureName);
if isempty(Figure)
    screenSize = double(get(groot, 'ScreenSize'));
    Figure = figure(Name=figureName);
    Figure.Position = [screenSize(3)*0.17 screenSize(4)*0.15 screenSize(3)*0.4 screenSize(4)*0.4];
    Figure.NumberTitle = 'off';
    Figure.MenuBar = 'none';
    Figure.ToolBar = 'none';
end
clf(Figure);
bepAxes = axes(Figure);
grid(bepAxes, 'on');
legend(bepAxes, 'hide');

bep = birdsEyePlot(Parent=bepAxes, XLim=[-20 60], YLim=[-35 35]);
caPlotterV = coverageAreaPlotter(bep, DisplayName="Vision Coverage area", FaceColor="b");
caPlotterU = coverageAreaPlotter(bep, DisplayName="Ultrasonic Coverage area", FaceColor="m");
detPlotter = detectionPlotter(bep, DisplayName="Object detections");
lmPlotter = laneMarkingPlotter(bep, DisplayName="Lane markings");
olPlotter = outlinePlotter(bep);
plotCoverageArea(caPlotterV, visionSensor.SensorLocation, ...
    visionSensor.MaxRange, visionSensor.Yaw, ...
    visionSensor.FieldOfView(1));
plotCoverageArea(caPlotterU, leftUltrasonic.MountingLocation(1:2), ...
    leftUltrasonic.DetectionRange(3), leftUltrasonic.MountingAngles(1), ...
    leftUltrasonic.FieldOfView(1));

lulrdPlotter = rangeDetectionPlotter(bep, DisplayName="Left Ultrasonic Ranges", LineStyle="-");
luldetPlotter = detectionPlotter(bep, DisplayName="Point-On-Target (Left Ultrasonic)", MarkerFaceColor="r");
end

```

helperPlotBEPVision plots ego vehicle outlines, lanes and vision detections on the bird's-eye-plot.

```

function helperPlotBEPVision(egovehicle, lmv, lmf, obdets, obValid, detPlotter, lmPlotter, olPlotter)
plotLaneMarking(lmPlotter, lmv, lmf)

[objposition, objyaw, objlength, objwidth, objoriginOffset, color] = targetOutlines(egovehicle);
plotOutline(olPlotter, objposition, objyaw, objlength, objwidth, ...

```

```

        OriginOffset=objoriginOffset,Color=color)

    if obValid
        detPos = cellfun(@(d)d.Measurement(1:2),obdets,UniformOutput=false);
        detPos = vertcat(zeros(0,2),cell2mat(detPos'))';
        plotDetection(detPlotter,detPos)
    end

end

helperPlotBEPUltrasonic plots ultrasonic range measurements and points on targets.

function helperPlotBEPUltrasonic(lobdets,lobValid,leftUltrasonic,lulrdPlotter,luldetPlotter)

    if ~isempty(lobdets) && lobValid
        lranges = lobdets{1}.Measurement;
        plotRangeDetection(lulrdPlotter,lranges,leftUltrasonic.FieldOfView(1),leftUltrasonic.Mour
        plotDetection(luldetPlotter,lobdets{1}.ObjectAttributes{1}.PointOnTarget(1:2)')
    end

end

```

Algorithms

Specify Actor Motion in Driving Scenarios

To specify the motion of actors in a driving scenario, you can either define trajectories for the actors or specify their motion manually.

Specify Motion Using Trajectory

The `trajectory` and `smoothTrajectory` functions determine actor pose properties based on a set of waypoints and the speeds at which the actor travels between those waypoints. Actor pose properties are position, velocity, roll, pitch, yaw, and angular velocity. With this approach, motion is defined by speed, not velocity, because the trajectory determines the direction of motion.

The `smoothTrajectory` function additionally determines the acceleration of the actor between waypoints based on the waypoints, speed, and maximum longitudinal jerk.

The actor moves along the trajectory each time the `advance` function is called. You can manually update actor pose properties at any time during a simulation. However, these properties are overwritten with updated values at the next call to `advance`.

Specify Motion Manually

When you specify actor motion manually, setting the velocity or angular velocity properties does not automatically move the actor in successive calls to the `advance` function. Therefore, you must use your own motion model to update the position, velocity, and other pose parameters at each simulation time step.

Version History

Introduced in R2017a

See Also

Apps

Driving Scenario Designer

Objects

drivingRadarDataGenerator | visionDetectionGenerator | multiObjectTracker | lidarPointCloudGenerator | insSensor

Topics

“Create Driving Scenario Variations Programmatically”

“Create Driving Scenario Programmatically”

“Define Road Layouts Programmatically”

“Create Actor and Vehicle Trajectories Programmatically”

“Scenario Generation from Recorded Vehicle Data”

“Coordinate Systems in Automated Driving Toolbox”

advance

Advance driving scenario simulation by one time step

Syntax

```
isRunning = advance(scenario)
```

Description

`isRunning = advance(scenario)` advances a driving scenario simulation by one time step. To specify the step time, use the `SampleTime` property of the input `drivingScenario` object, `scenario`. The function returns the status, `isRunning`, of the simulation.

Examples

Advance Driving Scenario Simulation

Create a driving scenario. Use the default sample time of 0.01 second.

```
scenario = drivingScenario;
```

Add a straight, 30-meter road to the scenario. The road has two lanes.

```
roadCenters = [0 0; 30 0];  
road(scenario, roadCenters, 'Lanes', lanespec(2));
```

Add a vehicle that travels in the left lane at a constant speed of 30 meters per second. Plot the scenario before running the simulation.

```
v = vehicle(scenario, 'ClassID', 1);  
waypoints = [5 2; 25 2];  
speed = 30; % m/s  
smoothTrajectory(v, waypoints, speed)
```

```
plot(scenario)
```

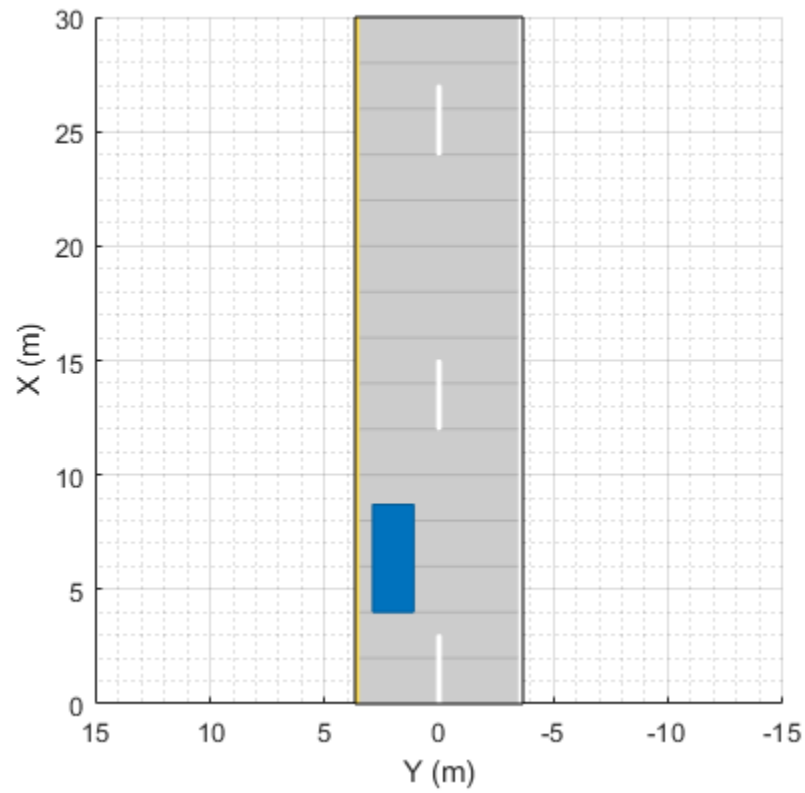

Call the advance function in a loop to advance the simulation one time step at a time. Pause every 0.01 second to observe the motion of the vehicle on the plot.

```
while advance(scenario)
    pause(0.01)
end
```

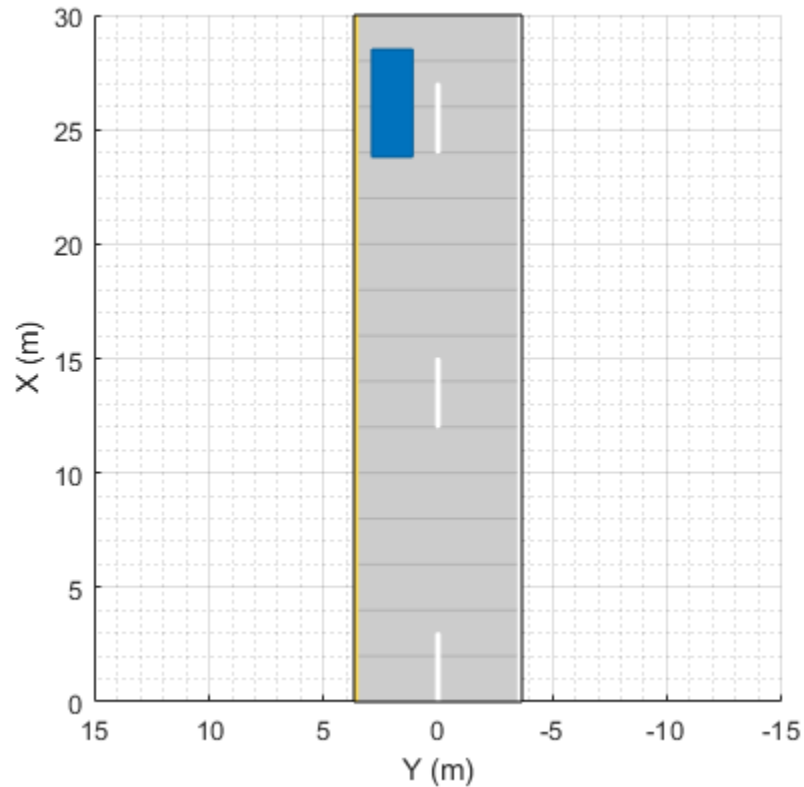

Show Target Outlines in Driving Scenario Simulation

Create a driving scenario and show how target outlines change as the simulation advances.

Create a driving scenario consisting of two intersecting straight roads. The first road segment is 45 meters long. The second straight road is 32 meters long with jersey barriers along both its edges, and intersects the first road. A car traveling at 12.0 meters per second along the first road approaches a running pedestrian crossing the intersection at 2.0 meters per second.

```
scenario = drivingScenario('SampleTime',0.1,'StopTime',1);
road1 = road(scenario,[-10 0 0; 45 -20 0]);
road2 = road(scenario,[-10 -10 0; 35 10 0]);
barrier(scenario,road1)
barrier(scenario,road1,'RoadEdge','left')
ped = actor(scenario,'ClassID',4,'Length',0.4,'Width',0.6,'Height',1.7);
car = vehicle(scenario,'ClassID',1);
pedspeed = 2.0;
carspeed = 12.0;
smoothTrajectory(ped,[15 -3 0; 15 3 0],pedspeed);
smoothTrajectory(car,[-10 -10 0; 35 10 0],carspeed);
```

Create an ego-centric chase plot for the vehicle.

```
chasePlot(car,'Centerline','on')
```

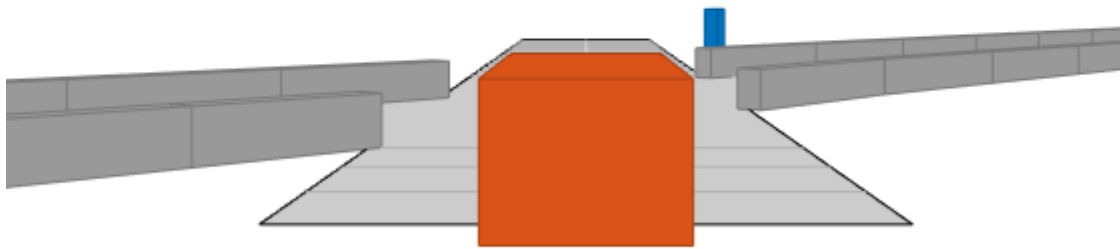

Create an empty bird's-eye plot and add an outline plotter and lane boundary plotter. Then, run the simulation. At each simulation step:

- Update the chase plot to display the road boundaries and target outlines.
- Update the bird's-eye plot to display the updated road boundaries and target outlines. The plot perspective is always with respect to the ego vehicle.

```
bepPlot = birdsEyePlot('XLim',[-50 50],'YLim',[-40 40]);
outlineplotter = outlinePlotter(bepPlot);
laneplotter = laneBoundaryPlotter(bepPlot);
legend('off')

while advance(scenario)
    rb = roadBoundaries(car);
    [position,yaw,length,width,originOffset,color] = targetOutlines(car);
    [bposition,byaw,blength,bwidth,boriginOffset,bcolor,barrierSegments] = targetOutlines(car,'B');
    plotLaneBoundary(laneplotter,rb)
    plotOutline(outlineplotter,position,yaw,length,width, ...
        'OriginOffset',originOffset,'Color',color)
    plotBarrierOutline(outlineplotter,barrierSegments,bposition,byaw,blength,bwidth, ...
        'OriginOffset',boriginOffset,'Color',bcolor)
    pause(0.01)
end
```

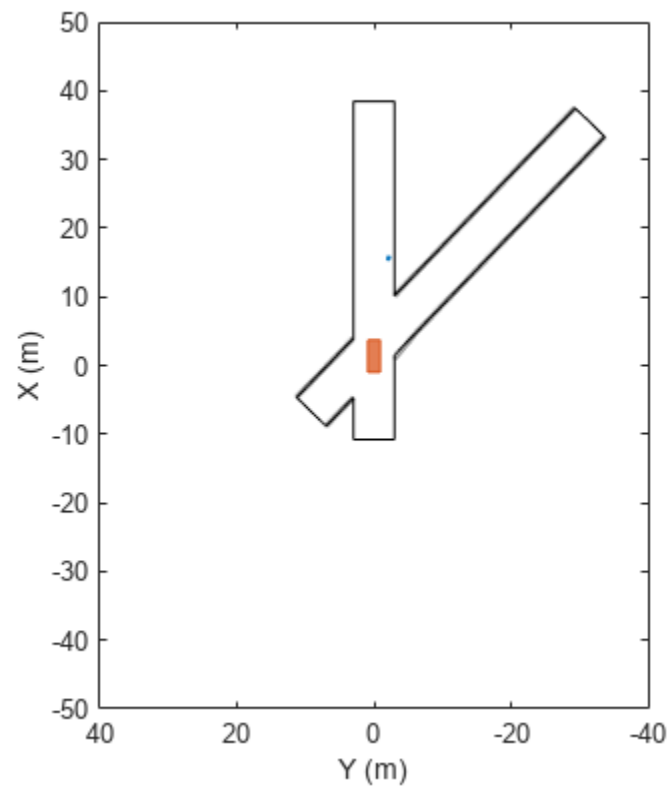

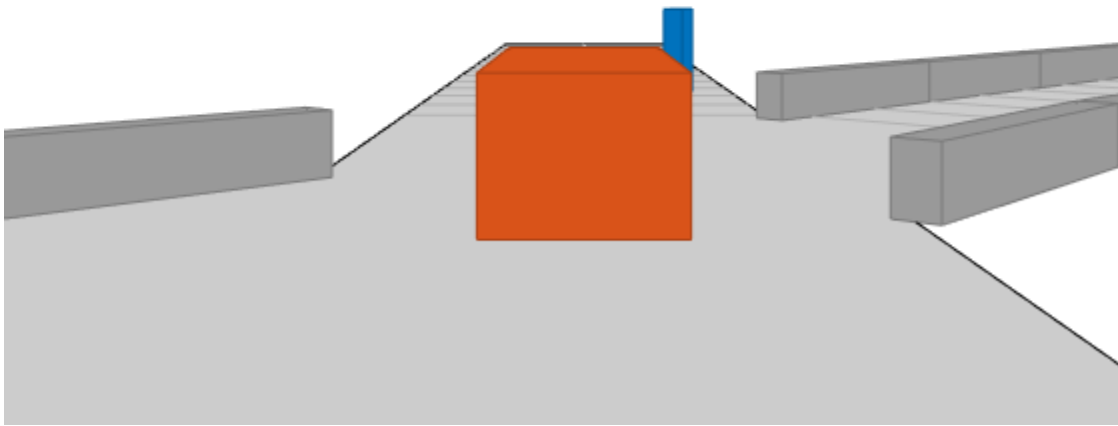

Simulate Car Traveling on S-Curve

Simulate a driving scenario with one car traveling on an S-curve. Create and plot the lane boundaries.

Create the driving scenario with one road having an S-curve.

```
scenario = drivingScenario('StopTime',3);
roadcenters = [-35 20 0; -20 -20 0; 0 0 0; 20 20 0; 35 -20 0];
```

Create the lanes and add them to the road.

```
lm = [laneMarking('Solid','Color','w'); ...
      laneMarking('Dashed','Color','y'); ...
      laneMarking('Dashed','Color','y'); ...
      laneMarking('Solid','Color','w')];
ls = lanespec(3,'Marking',lm);
road(scenario,roadcenters,'Lanes',ls);
```

Add an ego vehicle and specify its trajectory from its waypoints. By default, the car travels at a speed of 30 meters per second.

```
car = vehicle(scenario, ...
             'ClassID',1, ...
             'Position',[-35 20 0]);
```

```
waypoints = [-35 20 0; -20 -20 0; 0 0 0; 20 20 0; 35 -20 0];  
smoothTrajectory(car, waypoints);
```

Plot the scenario and corresponding chase plot.

```
plot(scenario)
```

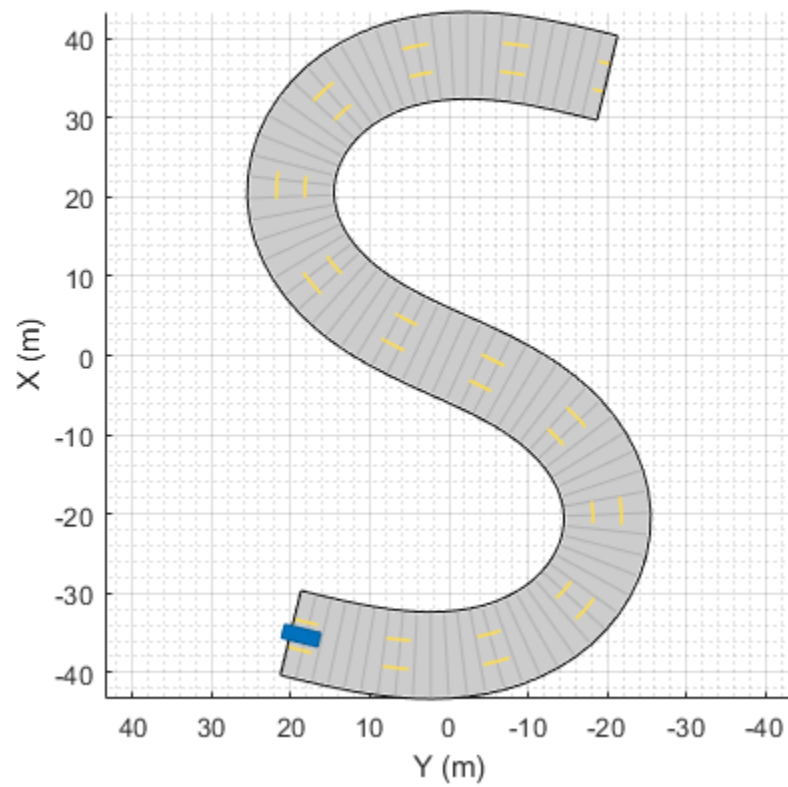

```
chasePlot(car)
```



Run the simulation loop.

- 1 Initialize a bird's-eye plot and create an outline plotter, left-lane and right-lane boundary plotters, and a road boundary plotter.
- 2 Obtain the road boundaries and rectangular outlines.
- 3 Obtain the lane boundaries to the left and right of the vehicle.
- 4 Advance the simulation and update the plotters.

```

bep = birdsEyePlot('XLim',[-40 40], 'YLim',[-30 30]);
olPlotter = outlinePlotter(bep);
lblPlotter = laneBoundaryPlotter(bep, 'Color', 'r', 'LineStyle', '-');
lbrPlotter = laneBoundaryPlotter(bep, 'Color', 'g', 'LineStyle', '-');
rbsEdgePlotter = laneBoundaryPlotter(bep);
legend('off');
while advance(scenario)
    rbs = roadBoundaries(car);
    [position, yaw, length, width, originOffset, color] = targetOutlines(car);
    lb = laneBoundaries(car, 'XDistance', 0:5:30, 'LocationType', 'Center', ...
        'AllBoundaries', false);
    plotLaneBoundary(rbsEdgePlotter, rbs)
    plotLaneBoundary(lblPlotter, {lb(1).Coordinates})
    plotLaneBoundary(lbrPlotter, {lb(2).Coordinates})
    plotOutline(olPlotter, position, yaw, length, width, ...
        'OriginOffset', originOffset, 'Color', color)
end

```

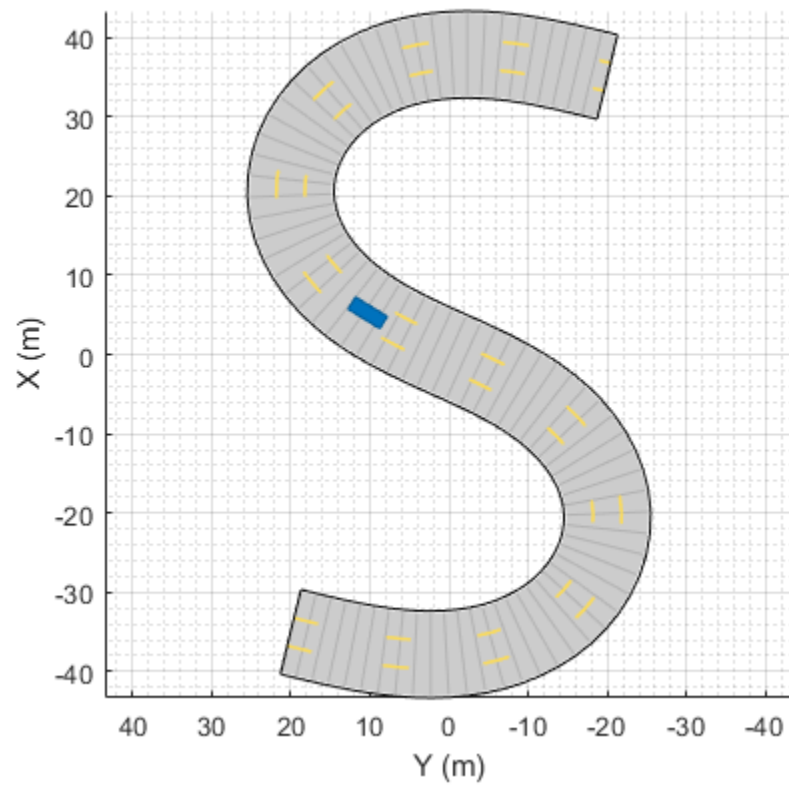

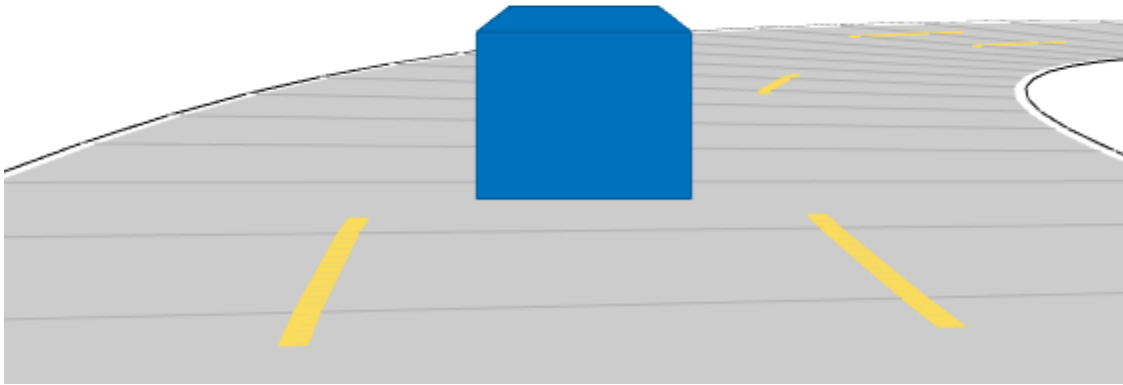

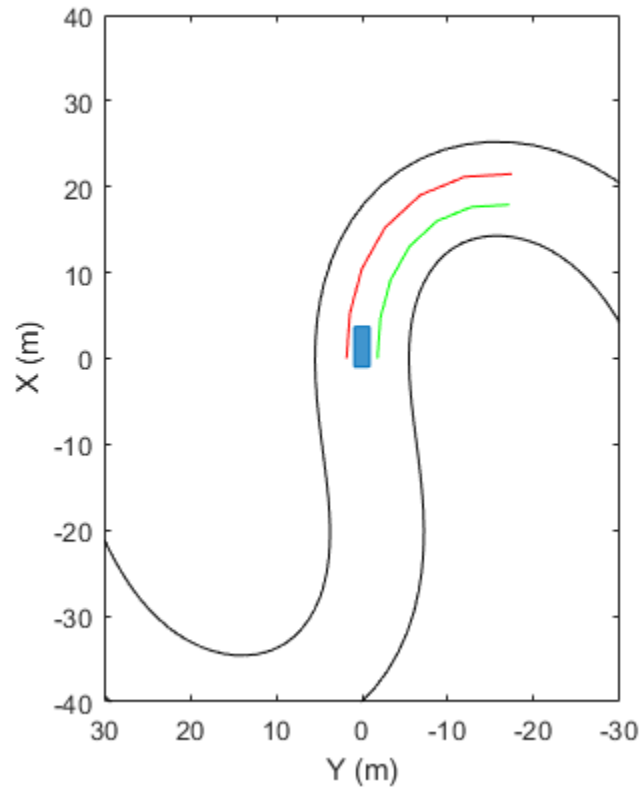
Input Arguments

scenario – Driving scenario

`drivingScenario` object

Driving scenario, specified as a `drivingScenario` object.

Output Arguments

`isRunning` – Run state of simulation

1 | 0

Run state of the simulation, returned as logical 1 (true) or 0 (false).

- If `isRunning` is 1, the simulation is running.
- If `isRunning` is 0, the simulation has stopped running.

A simulation runs until at least one of these conditions are met:

- The simulation time exceeds the simulation stop time. To specify the stop time, use the `StopTime` property of `scenario`.
- Any actor or vehicle reaches the end of its assigned trajectory. The assigned trajectory is specified by the most recent call to the trajectory function.

The `advance` function updates actors and vehicles only if they have an assigned trajectory. To update actors and vehicles that have no assigned trajectories, you can set the `Position`, `Velocity`, `Roll`, `Pitch`, `Yaw`, or `AngularVelocity` properties at any time during simulation.

Version History

Introduced in R2017a

See Also

Objects

`drivingScenario`

Functions

`chasePlot` | `plot` | `smoothTrajectory` | `restart` | `record`

Topics

“Create Driving Scenario Programmatically”

“Create Actor and Vehicle Trajectories Programmatically”

export

Export driving scenario to ASAM OpenDRIVE, ASAM OpenSCENARIO or RoadRunner HD Map file

Syntax

```
export(scenario,"OpenDRIVE",filename)
export(scenario,"OpenSCENARIO",filename)
export( ____,Name=Value)
export(scenario,"RoadRunner HD Map",filename)
```

Description

`export(scenario,"OpenDRIVE",filename)` exports the roads, lanes, junctions, and actors in a driving scenario to the ASAM OpenDRIVE file format, describing the static content of driving scenario. There may be variations between the original scenario and the exported scenario. For details, see "Limitations" on page 4-360.

The function supports exporting driving scenarios to OpenDRIVE file versions V1.4, V1.5, and ASAM OpenDRIVE file version V1.6.

`export(scenario,"OpenSCENARIO",filename)` exports the road network, actors, and trajectories in a driving scenario to the ASAM OpenSCENARIO file format, describing the dynamic content of driving scenario. Exporting to an ASAM OpenSCENARIO file also exports several data files. For more information, see "Data Files Exported with ASAM OpenSCENARIO File" on page 4-363. To know about the default actor parameters that the function exports, see "ASAM OpenSCENARIO Representations".

The function supports exporting driving scenarios to ASAM OpenSCENARIO file versions V1.0 and V1.1.

Note

- The function interpolates additional waypoints between the ones specified in the driving scenario, to generate smooth trajectories for exported actors in the output ASAM OpenSCENARIO file.
- The function does not support exporting reverse waypoints of actors to an ASAM OpenSCENARIO file.

`export(____,Name=Value)` specifies options using one or more name-value arguments and any of the input argument combinations from previous syntaxes. For example, `export(scenario,"OpenDRIVE",filename,OpenDRIVEVersion=1.5)` exports the driving scenario to V1.5 of the OpenDRIVE file format.

`export(scenario,"RoadRunner HD Map",filename)` exports the road network and static actors in a driving scenario to the RoadRunner HD Map file format, describing the static content of driving scenario. There may be variations between the original scenario and the exported scenario. For details, see "Limitations" on page 4-360.

Examples

Export OpenStreetMap Road Network to ASAM OpenDRIVE File

Create a driving scenario.

```
inputScenario = drivingScenario;
```

Import a OpenStreetMap® road network into the driving scenario. For more information about the osm file, see [1] on page 4-350.

```
fileName = "chicago.osm";  
roadNetwork(inputScenario, "OpenStreetMap", fileName);
```

Export to ASAM OpenDRIVE® file.

```
fileName = "chicago.xodr";  
export(inputScenario, "OpenDRIVE", fileName);
```

Warning: There may be minor variation between the actual driving scenario and the exported OpenDRIVE file.

Read the exported ASAM OpenDRIVE file by using the `roadNetwork` function.

```
scenario = drivingScenario;  
roadNetwork(scenario, "OpenDRIVE", fileName);
```

Plot the exported scenario. Notice that the display for the exported road network is flipped along the x and y dimensions and does not have the border lines.

```
figure  
plot(inputScenario)  
zoom(2);  
title("Actual Scenario")
```

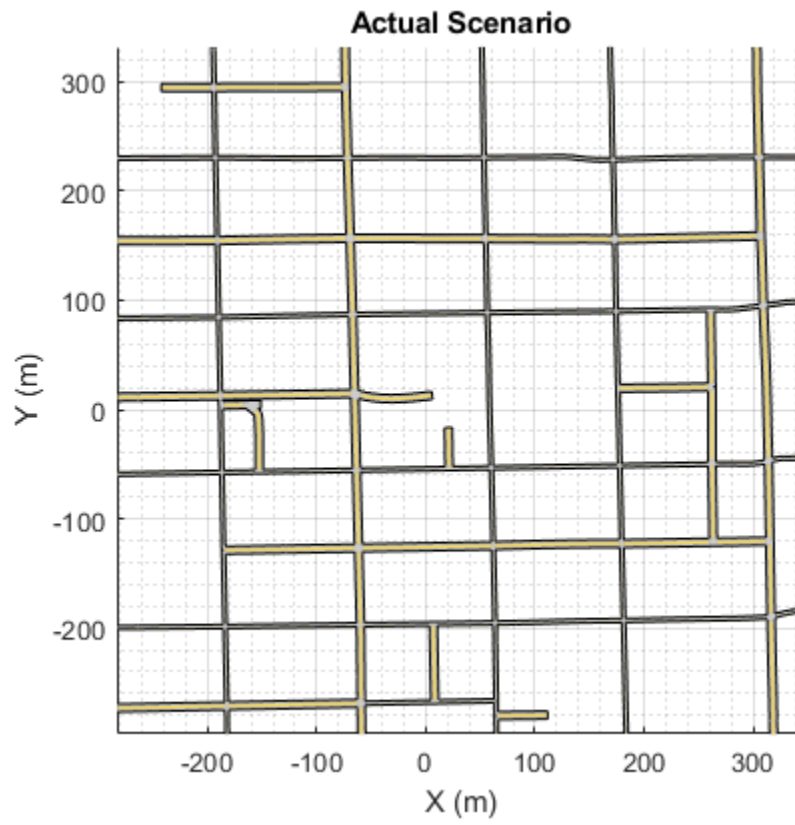

```
figure
plot(scenario)
zoom(2);
title("Exported Scenario")
```

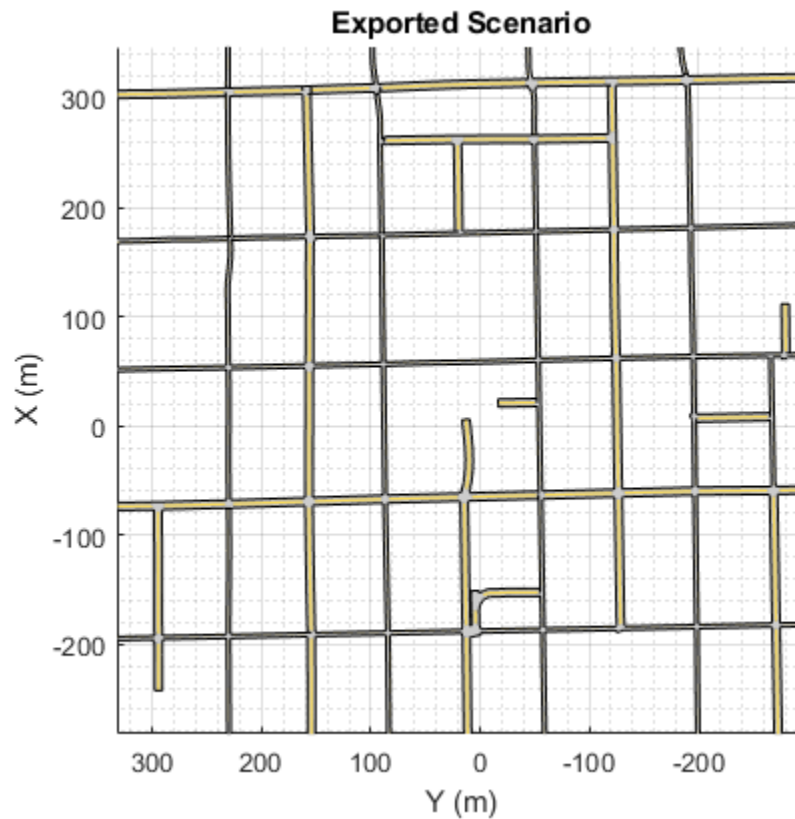

Appendix

[1] The osm file is downloaded from <https://www.openstreetmap.org>, which provides access to crowd-sourced map data all over the world. The data is licensed under the Open Data Commons Open Database License (ODbL), <https://opendatacommons.org/licenses/odbl/>.

Create S-Curve Road and Export to ASAM OpenDRIVE Format

Create the driving scenario with one road having an S-curve.

```
scenario = drivingScenario;
roadcenters = [-35 20 0; -20 -20 0; 0 0 0; 20 20 0; 35 -20 0];
```

Create the lanes and add them to the road.

```
lm = [laneMarking("Solid",Color="w") ...
      laneMarking("Dashed",Color="y") ...
      laneMarking("Dashed",Color="y") ...
      laneMarking("Solid",Color="w")];
ls = lanespec(3,Marking=lm);
road(scenario,roadcenters,"Lanes",ls);
```

Plot the scenario.

```
plot(scenario)
```

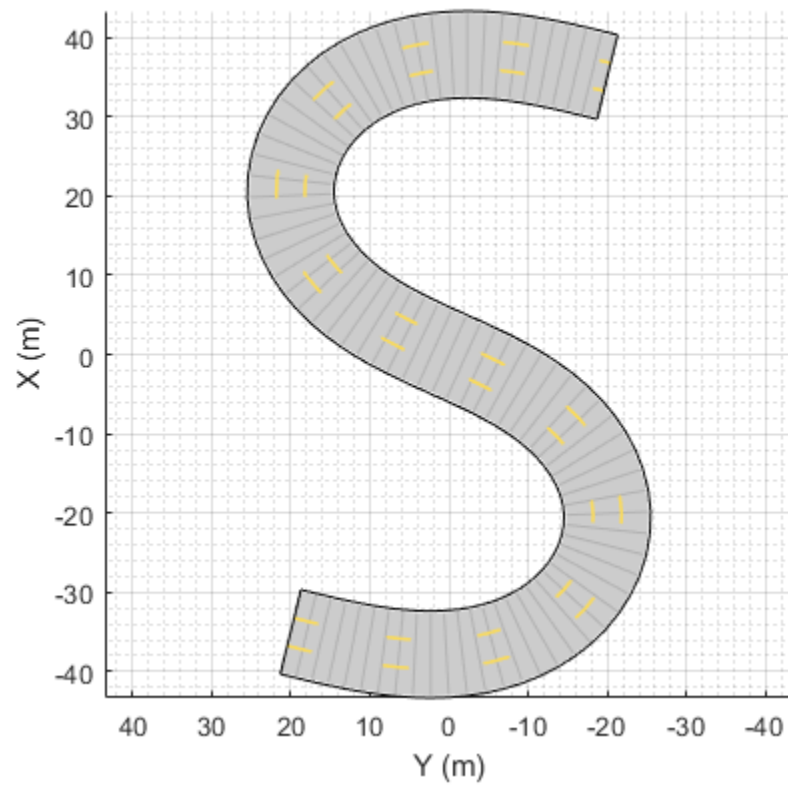

Export the road network in the scenario to ASAM OpenDRIVE® file.

```
fileName = "scurve.road.xodr";  
export(scenario, "OpenDRIVE", fileName, OpenDRIVEVersion=1.6)
```

Warning: There may be minor variation between the actual driving scenario and the exported OpenDRIVE file.

You can import the ASAM OpenDRIVE file to MATLAB® workspace by using the `roadNetwork` function.

```
scenario = drivingScenario;  
roadNetwork(scenario, "OpenDRIVE", fileName)  
plot(scenario)
```

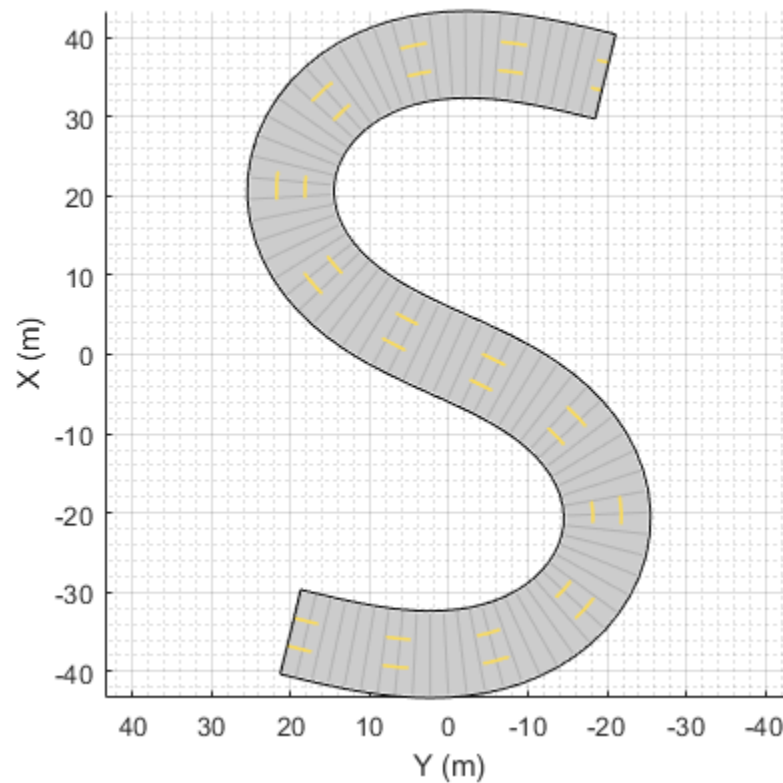

Copyright 2020-21 The MathWorks, Inc.

Export Driving Scenario to ASAM OpenSCENARIO File

Create a driving scenario.

```
scenario = drivingScenario(StopTime=6);
```

Import the road network from an ASAM OpenDRIVE® file into the scenario.

```
fileName = "parking.xodr";
roadNetwork(scenario, "OpenDRIVE", fileName);
```

Add an ego vehicle to the scenario. Set a trajectory in which the vehicle drives along the curve at varying speed.

```
egoVehicle = vehicle(scenario, ClassID=1);
waypoints = [-80 43; -34 29; -18 15; -10 -2; 4 -17; 38 -24; 52 -20];
speed = [50 20 20 20 20 50 50];
trajectory(egoVehicle, waypoints, speed);
```

Add a non-ego actor and set it to spawn during the simulation by specifying an entry time value. Generate a trajectory for the non-ego actor.

```
truck = vehicle(scenario, ClassID=2, Position=[4 -17 0], EntryTime=3);
waypoints = [4 -17; 20 -24; 38 -24; 60 -16];
```

```
speed = [40 40 40 40];  
trajectory(truck,waypoints,speed);
```

Plot the scenario and run the simulation. Observe how the vehicle slows down as it drives along the curve.

```
plot(scenario,Waypoints="on");  
while advance(scenario)  
    pause(0.01)  
end
```

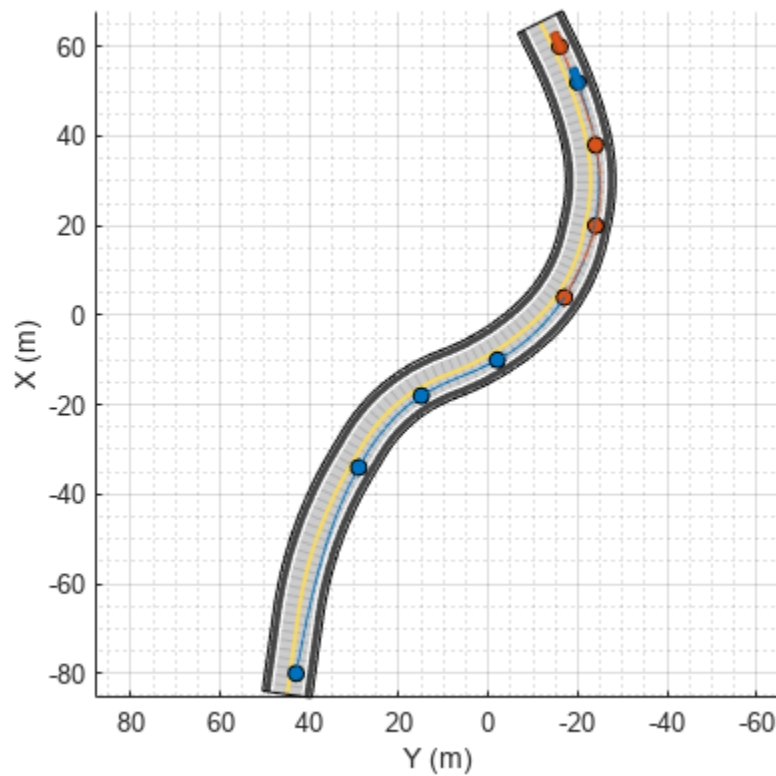

Export the scenario to an ASAM OpenSCENARIO® file.

```
export(scenario,"OpenSCENARIO","parking.xosc");
```

Export RoadRunner HD Map from Driving Scenario

Create a driving scenario object.

```
scenario = helperCreateDrivingScenario;
```

Plot the scenario.

```
plot(scenario)
```

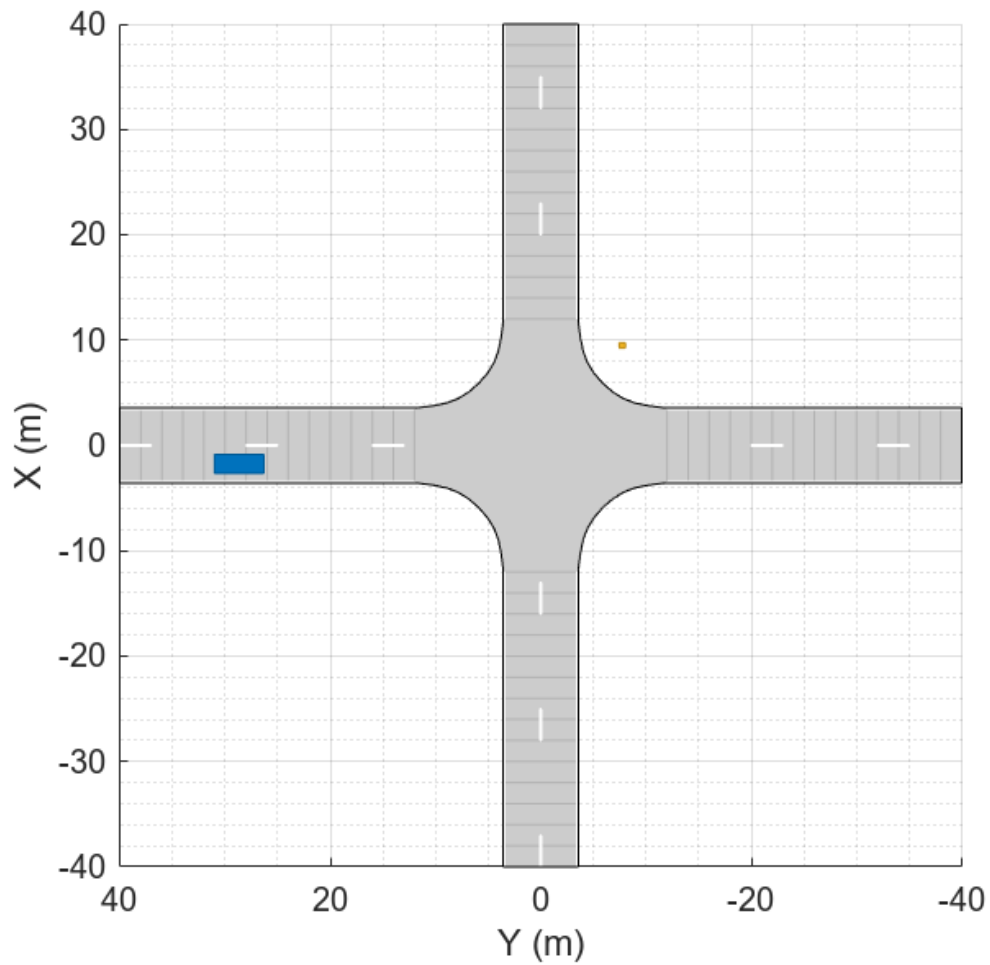

Export the driving scenario directly to a `.rrhd` binary file.

```
export(scenario, "RoadRunner HD Map", "directExportScenario.rrhd")
```

Alternatively, you can first get the RoadRunner HD Map object for the scenario and plot it.

```
rrMap = getRoadRunnerHDMAP(scenario);  
plot(rrMap)
```

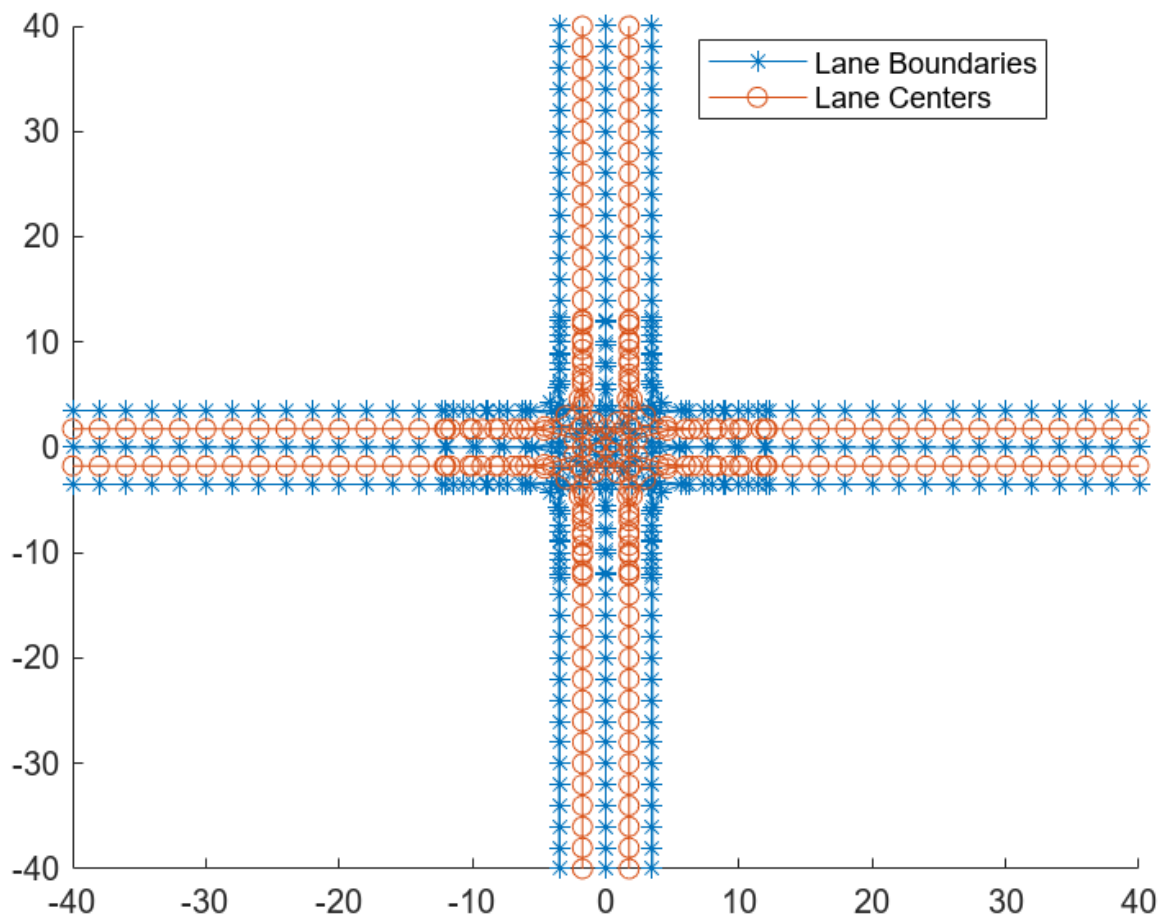

You can inspect it and make any desired modifications. Then, write the RoadRunner HD Map to a .rrhd binary file.

```
write(rrMap, '4wayIntersection.rrhd')
```

Import the map into RoadRunner.

```
rrApp = roadrunner("D:\RR\TestProjects");  
importScene(rrApp, fullfile(pwd, "4wayIntersection.rrhd"), "RoadRunner HD Map")
```

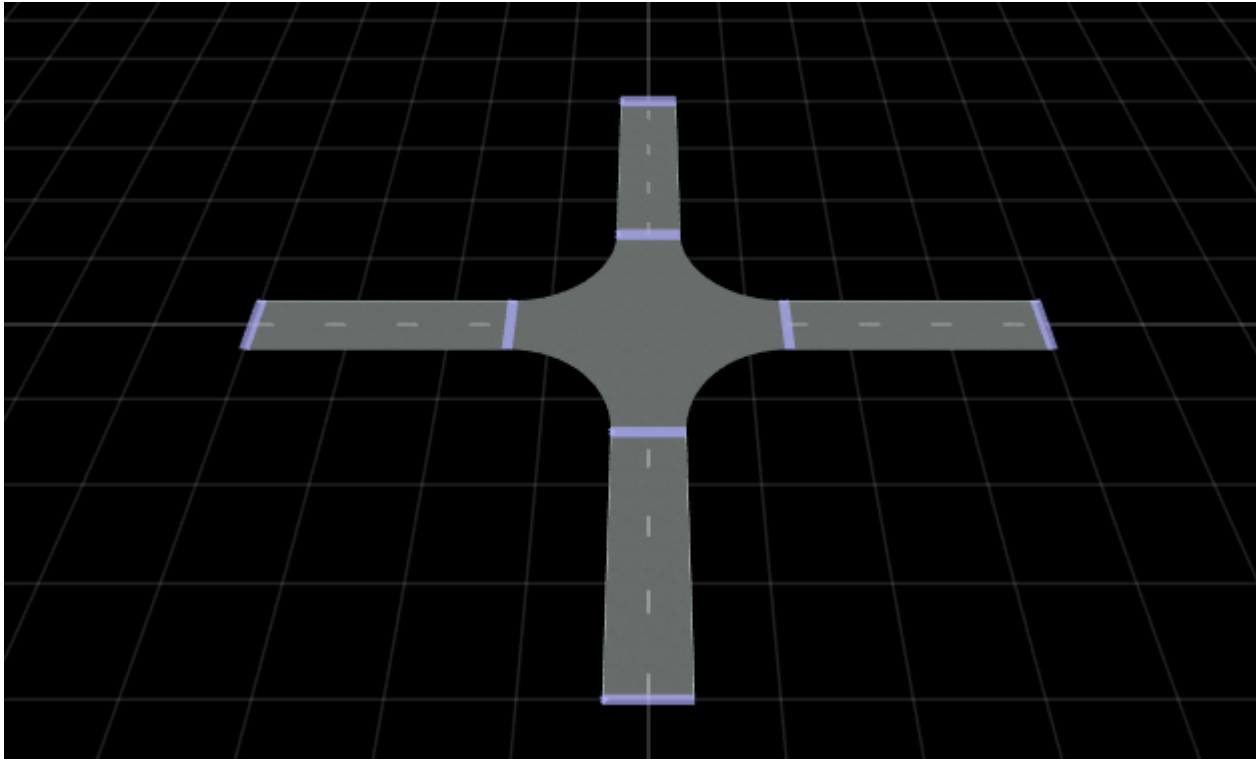

Helper Functions

`helperCreateDrivingScenario` creates a four way intersection driving scenario with an ego vehicle and a pedestrian.

```
function scenario = helperCreateDrivingScenario

% Create scenario and add roads
scenario = drivingScenario;
roadCenters = [0 40 0;
              0 -40 0];
marking = [laneMarking('Solid')
           laneMarking('Dashed')
           laneMarking('Solid')];
laneSpecification = lanespec(2, 'Width', 3.5, 'Marking', marking);
road(scenario, roadCenters, 'Lanes', laneSpecification, 'Name', 'Road');

roadCenters = [-40 0 0;
              40 0 0];
marking = [laneMarking('Solid')
           laneMarking('Dashed')
           laneMarking('Solid')];
laneSpecification = lanespec(2, 'Width', 3.5, 'Marking', marking);
road(scenario, roadCenters, 'Lanes', laneSpecification, 'Name', 'Road1');

roadCenters = [0 11.5 0;
              0.8753853761202 7.0991405278015 0;
              3.3682720163547 3.3682720163547 0];
```

```

    7.0991405278015 0.8753853761202 0;
    11.5 0 0];
marking = [laneMarking('Solid')
    laneMarking('Dashed')
    laneMarking('Solid')];
laneSpecification = lanespec(2, 'Width', 3.5, 'Marking', marking);
road(scenario, roadCenters, 'Lanes', laneSpecification, 'Name', 'Road2');

roadCenters = [0 -11.5 0;
    0.8753853761202 -7.0991405278015 0;
    3.3682720163547 -3.3682720163547 0;
    7.0991405278015 -0.8753853761202 0;
    11.5 0 0];
marking = [laneMarking('Solid')
    laneMarking('Dashed')
    laneMarking('Solid')];
laneSpecification = lanespec(2, 'Width', 3.5, 'Marking', marking);
road(scenario, roadCenters, 'Lanes', laneSpecification, 'Name', 'Road3');

roadCenters = [0 -11.5 0;
    -0.8753853761202 -7.0991405278015 0;
    -3.3682720163547 -3.3682720163547 0;
    -7.0991405278015 -0.8753853761202 0;
    -11.5 0 0];
marking = [laneMarking('Solid')
    laneMarking('Dashed')
    laneMarking('Solid')];
laneSpecification = lanespec(2, 'Width', 3.5, 'Marking', marking);
road(scenario, roadCenters, 'Lanes', laneSpecification, 'Name', 'Road4');

roadCenters = [0 11.5 0;
    -0.8753853761202 7.0991405278015 0;
    -3.3682720163547 3.3682720163547 0;
    -7.0991405278015 0.8753853761202 0;
    -11.5 0 0];
marking = [laneMarking('Solid')
    laneMarking('Dashed')
    laneMarking('Solid')];
laneSpecification = lanespec(2, 'Width', 3.5, 'Marking', marking);
road(scenario, roadCenters, 'Lanes', laneSpecification, 'Name', 'Road5');

% Add ego vehicle
egoVehicle = vehicle(scenario, ...
    'ClassID', 1, ...
    'Position', [-1.75 30 0], ...
    'FrontOverhang', 0.9, ...
    'Wheelbase', 2.8, ...
    'Mesh', driving.scenario.carMesh, ...
    'Name', 'Vehicle Under Test');
waypoints = [-1.75 30 0;
    -1.75 10.629767723813 0;
    -0.980075893866154 4.2738387109925 0;
    4.2738387109925 -0.980075893866154 0;
    10.629767723813 -1.75 0;
    30 -1.75 0];
speed = 2.777777777777778;
yaw = [-90; -90; -69.38; -20.62; 0; 0];
smoothTrajectory(egoVehicle, waypoints, speed, 'Yaw', yaw);

```

```

% Add the non-ego actors
euroncappedestriantarget = actor(scenario, ...
    'ClassID', 4, ...
    'Length', 0.6, ...
    'Width', 0.5, ...
    'Height', 1.8, ...
    'Position', [9.5 -7.75 0], ...
    'PlotColor', [237 177 32] / 255, ...
    'Name', 'Euro NCAP Pedestrian Target');
waypoints = [9.5 -7.75 0;
    9.5 -6.75 0;
    9.5 10 0];
speed = [0;1.388888888888889;1.388888888888889];
waittime = [7.82;0;0];
trajectory(euroncappedestriantarget, waypoints, speed, waittime);
end

```

Input Arguments

scenario — Driving scenario

drivingScenario object

Driving scenario, specified as a `drivingScenario` object. The driving scenario must contain one or more road networks in order to export it to the ASAM OpenDRIVE file format.

The driving scenario must contain one or more actors to export it to the ASAM OpenSCENARIO file format.

If the driving scenario does not have lane specifications, then the `export` function assigns a default lane specification while exporting the road network to the ASAM OpenDRIVE or ASAM OpenSCENARIO file format.

filename — Name of destination file

character vector | string scalar

Name of the destination file, specified as a character vector or string scalar. You can specify the file name with or without the file extension. If you choose to specify a file extension, the file extension must be one of these:

- ASAM OpenDRIVE File — `.xodr` (default) or `.xml`
- ASAM OpenSCENARIO File — `.xosc` (default) or `.xml`
- RoadRunner

HD Map File — `.rrhd`

If the specified file name, including the file extension, already exists, then the function overwrites the data in the existing file with the driving scenario specified in the `scenario` argument.

Data Types: `char` | `string`

Name-Value Arguments

Specify optional pairs of arguments as `Name1=Value1, ..., NameN=ValueN`, where `Name` is the argument name and `Value` is the corresponding value. Name-value arguments must appear after other arguments, but the order of the pairs does not matter.

Example: `export(scenario, "OpenDRIVE", "newfile.xodr", OpenDRIVEVersion=1.6)` exports a driving scenario to ASAM OpenDRIVE file version V1.6.

OpenDRIVEVersion — Version of OpenDRIVE file

1.4 (default) | 1.5 | 1.6

Version of the OpenDRIVE file, specified as 1.4, 1.5, or 1.6. The function exports the driving scenario to the specified version of OpenDRIVE file.

Data Types: `single` | `double`

ExportActors — Export actors flag

`true` or `1` (default) | `false` or `0`

Export actors flag, specified as a logical `1` (`true`) or logical `0` (`false`).

- `true` or `1` — Export actors from the driving scenario to the ASAM OpenDRIVE file.
- `false` or `0` — Do not export actors from the driving scenario to the ASAM OpenDRIVE file.

Data Types: `logical`

OpenSCENARIOVersion — Version of ASAM OpenSCENARIO file

1.0 (default) | 1.1

Version of the ASAM OpenSCENARIO file, specified as 1.0 or 1.1. The function exports the driving scenario to the specified version of ASAM OpenSCENARIO file.

Data Types: `single` | `double`

TimeReference — Export TimeReference element flag

`false` or `0` (default) | `true` or `1`

Export TimeReference element flag, specified as a logical `1` (`true`) or logical `0` (`false`).

- `true` or `1` — Export TimeReference element of the FollowTrajectoryAction with Timing property to ASAM OpenSCENARIO file. The function exports absolute time domain values of actor waypoints without any scaling and offset from the driving scenario to the Trajectory element within the Init section of the output ASAM OpenSCENARIO file. This option specifies that you should consider the time information of exported actor trajectories that completely specify the motion of actors, including their speed and wait times. As such, the Story element of the exported file does not contain any SpeedAction element. The Story element of the exported file can contain VisibilityAction elements if you specify valid EntryTime and ExitTime parameters for an actor.
- `false` or `0` — Export empty TimeReference element of the FollowTrajectoryAction. This option specifies that you should not consider the time information contained in the Trajectory element within the Init section of the output ASAM OpenSCENARIO file. The exported actor trajectories do not specify speed along the path. So, the function separately exports speed of an actor using the SpeedAction elements within the Story element of the exported file. The Story element of the exported file can also contain VisibilityAction actions if you specify valid EntryTime and ExitTime parameters for an actor.

Data Types: `logical`

Limitations

ASAM OpenDRIVE Export Limitations

Roads

- The cubic polynomial and the parametric cubic polynomial geometry types in the scenario are exported as spiral geometry types. This causes some variations in the exported road geometry if the road is a curved road. For example, in the figure below, notice that the sharp corners in the input road became relatively smooth when exported to the ASAM OpenDRIVE format.

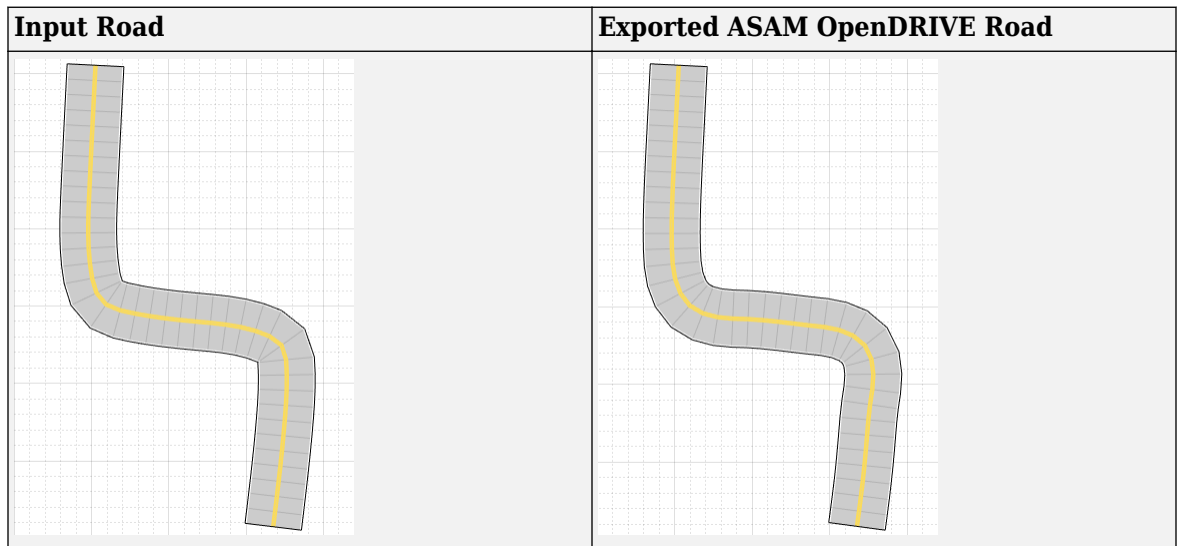

- When segments of adjacent roads overlap with each other, the function does not export the overlapping segments of the roads.

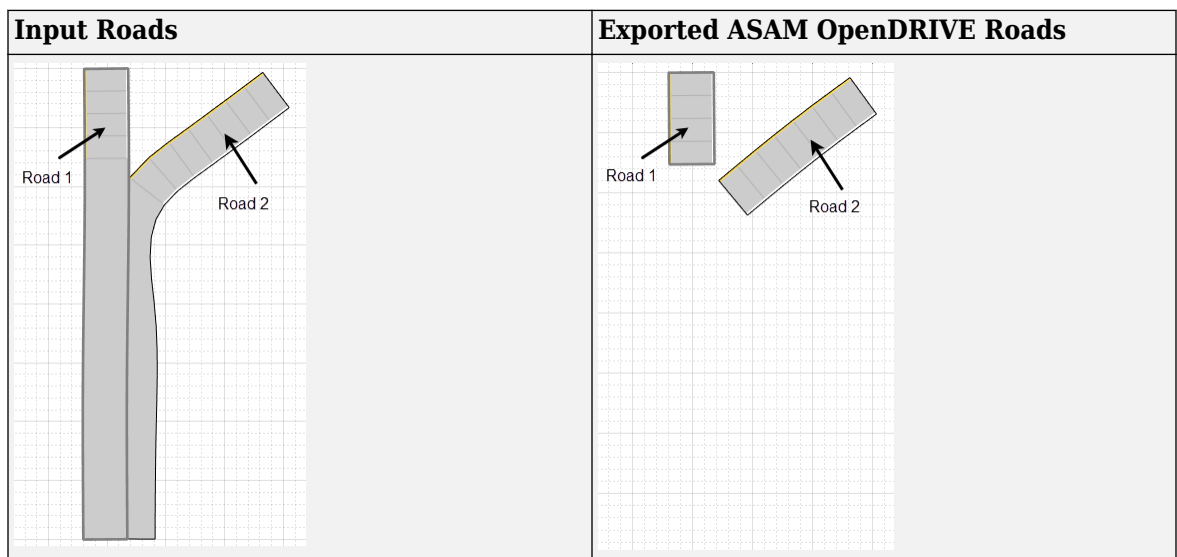

Lanes

- When a road with multiple lane specifications contains a taper between two road segments, the function exports the road without taper.

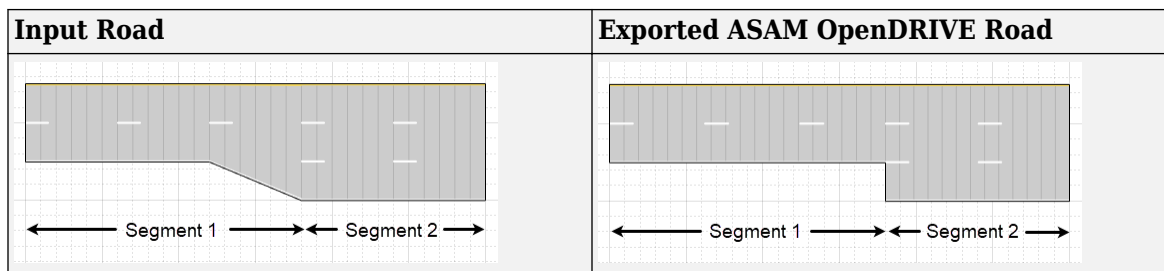

- When a road consisting of multiple segments is connected to a junction, the function does not export the road.

Junctions

- The junctions of the road network are processed without lane connection information, so the junction shapes may not be accurate in the exported scenario.

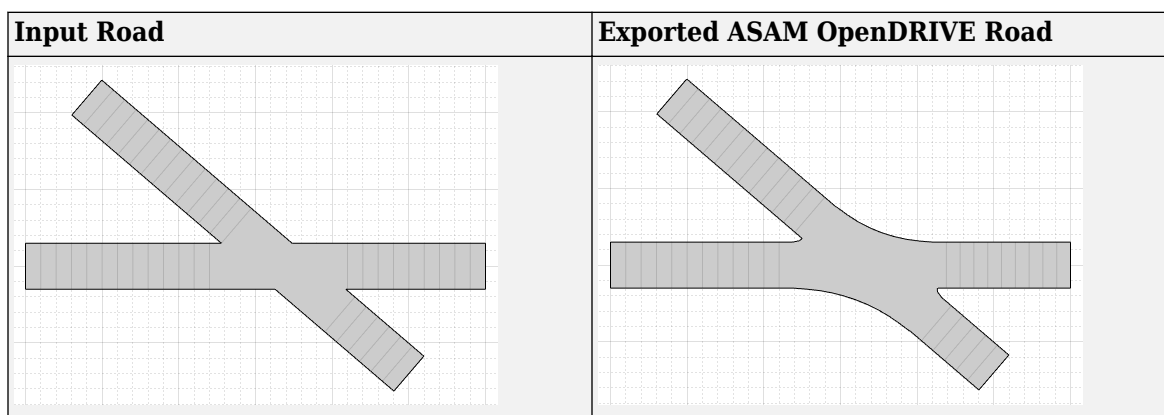

- When a junction is not connected to any road, the function does not export such junction.

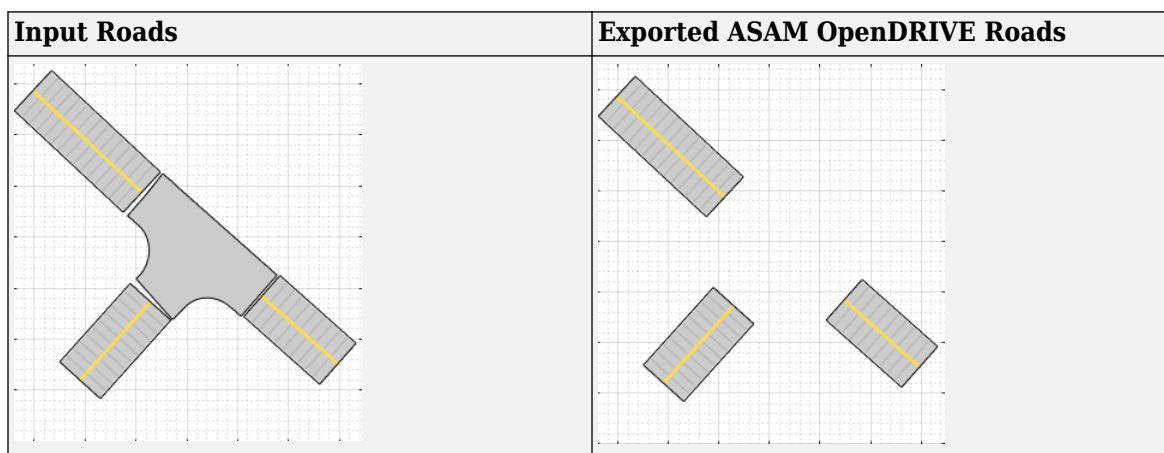

To export a detached junction to an ASAM OpenDRIVE file, you can manually drag incoming or outgoing roads and attach them to the junction.

Actors

- The export function does not export any actor that is present either on a junction or on a road with multiple road segments.

- While exporting a user-defined actor, the function sets the type of object to 'none'.

ASAM OpenDRIVE Import

- When you export a driving scenario object that contains an imported ASAM OpenDRIVE scenario, the limitations of ASAM OpenDRIVE import apply to ASAM OpenDRIVE export. You can import an ASAM OpenDRIVE scenario to a `drivingScenario` object by using the `roadNetwork` function. For information on the limitations of ASAM OpenDRIVE import, see `roadNetwork`.

RoadRunner HD Map Export Limitations

A RoadRunner Scene Builder license is required to build a scene from the HD map file. Without a RoadRunner Scene Builder license, you can import the HD map file and only view the map as nodes and links in RoadRunner.

Composite Lane Specifications

- Roads that use composite lane specifications (`compositeLaneSpec`) and form loops or intersect with themselves are not supported.
- Composite lane specifications for creating roads with varying widths are not supported

Lane Markings and Lane Type

- For lane markings created using the `laneMarking` object and lane types created using the `laneType` object, only `Color` name-value argument is supported. Only white and yellow colors are supported.
- For roads that form loops, multiple lane marking styles are not supported.

Parking Lot

- Driving scenarios containing parking lots added using the `parkingLot` function are not supported.

Barriers

- Barriers with gaps between segments created using the `barrier` function with `SegmentGap` name-value argument, are not supported. Such barriers will be laid out without any gaps in the RoadRunner HD map representation.
- For barriers, setting the `SegmentLength`, `Width`, and `Height` properties are not supported. These properties are calculated automatically based on the asset size during import to RoadRunner.

Junctions

- Only single 4-way intersection and merge/exit junction are supported.

Static Actors

- Static actors such as pedestrians and bicycles are not supported. To represent these actors in RoadRunner, you can either download a cuboid FBX and place it under `Assets/Vehicles/` or edit the map to point to their own assets.

Road Groups and Road Networks

- Road junctions and intersections added using the `roadGroup` function are not supported.
- Road networks created using the `roadNetwork` function are not supported.

More About

Data Files Exported with ASAM OpenSCENARIO File

While exporting a driving scenario to an ASAM OpenSCENARIO file, the function also exports additional data files. Each data file describes information about a specific element, such as a vehicle or pedestrian. The name of each data file has the prefix *filename_*, where the *filename* is the name specified in `filename` argument, excluding the extension.

Data File	Element of Scenario
<i>filename_</i> OpenDRIVE.xodr	Road network and barriers in the scenario
<i>filename_</i> VehicleCatalog.xosc	Properties of vehicles
<i>filename_</i> PedestrianCatalog.xosc	Properties of pedestrians

Note

- The function exports data files based on the contents of the scenario. For example, if the scenario does not contain any pedestrians, then the data file *filename_*PedestrianCatalog.xosc is not exported.
- As of R2021b, the function exports actor routes to the primary ASAM OpenSCENARIO file using instances of the `Trajectory` element. In R2021a, the routes of actors are exported separately using a `RouteCatalog` file that contains instances of the `Route` element.
- When a driving scenario contains a road network, the limitations of ASAM OpenDRIVE export apply to the exported `OpenDRIVE.xodr` data file.

Version History

Introduced in R2020b

See Also

Objects

`drivingScenario`

Functions

`roadNetwork` | `actor` | `vehicle`

Topics

“Export Driving Scenario to ASAM OpenDRIVE File”

“Export Driving Scenario to ASAM OpenSCENARIO File”

“Import ASAM OpenDRIVE Roads into Driving Scenario”

plot

Plot driving scenario

Syntax

```
plot(scenario)
plot(scenario,Name,Value)
```

Description

`plot(scenario)` creates a 3-D plot with orthonormal perspective, as seen from immediately above the driving scenario, `scenario`.

`plot(scenario,Name,Value)` specifies options using one or more name-value pairs. For example, you can use these options to display road centers and actor waypoints on the plot.

Examples

Create and Display Road Boundaries

Create a driving scenario containing a figure-8 road specified in the world coordinates of the scenario. Convert the world coordinates of the scenario to the coordinate system of the ego vehicle.

Create an empty driving scenario.

```
scenario = drivingScenario;
```

Add a figure-8 road to the scenario. Display the scenario.

```
roadCenters = [0  0  1
               20 -20 1
               20  20 1
              -20 -20 1
              -20  20 1
               0  0  1];

roadWidth = 3;
bankAngle = [0 15 15 -15 -15 0];
road(scenario,roadCenters,roadWidth,bankAngle);
plot(scenario)
```

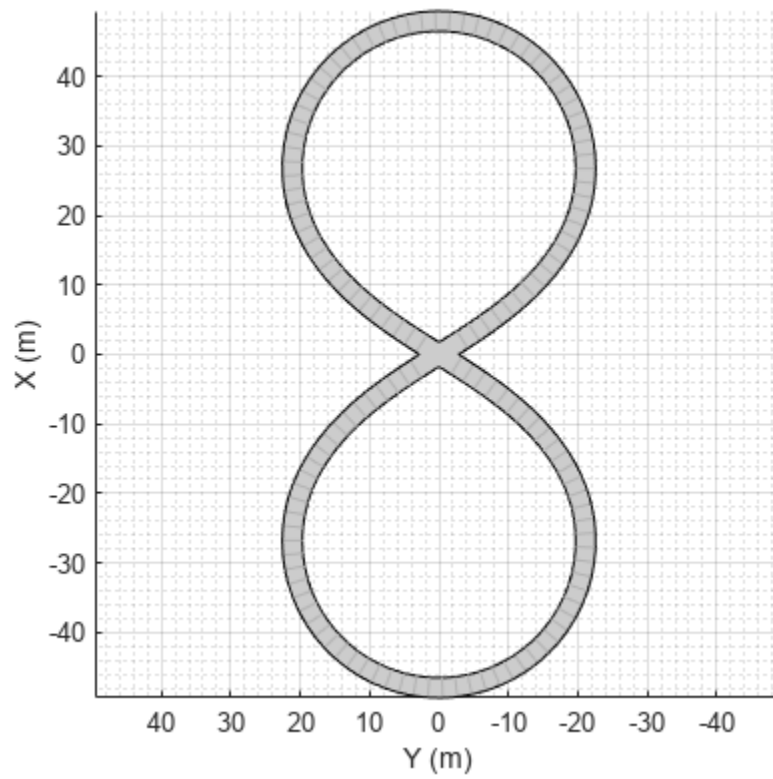

Add an ego vehicle to the scenario. Position the vehicle at world coordinates (20, -20) and orient it at a -15 degree yaw angle.

```
ego = actor(scenario, 'ClassID', 1, 'Position', [20 -20 0], 'Yaw', -15);
```

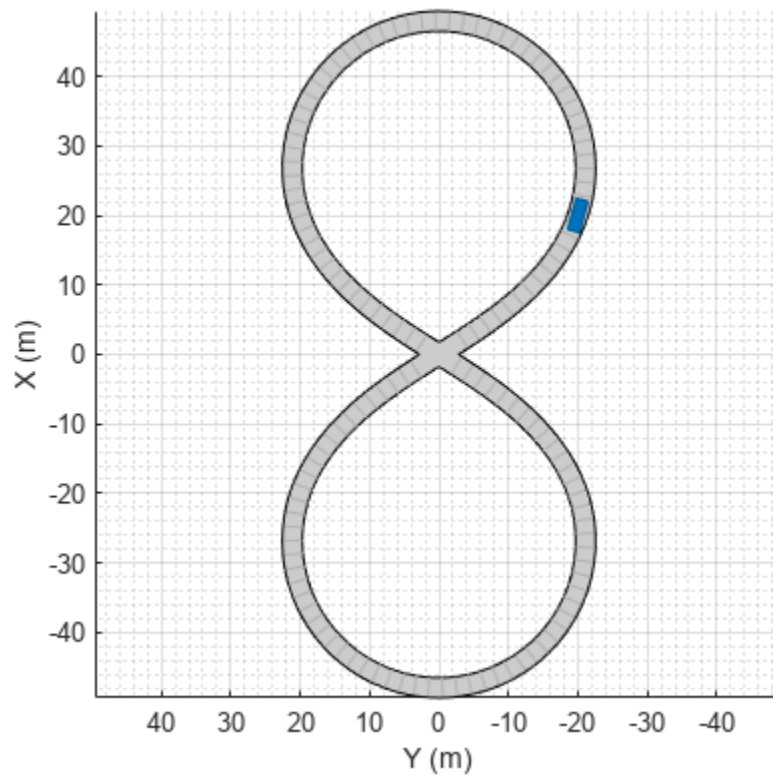

Obtain the road boundaries in ego vehicle coordinates by using the `roadBoundaries` function. Specify the ego vehicle as the input argument.

```
rbEgo1 = roadBoundaries(ego);
```

Display the result on a bird's-eye plot.

```
bep = birdsEyePlot;  
lbp = laneBoundaryPlotter(bep, 'DisplayName', 'Road');  
plotLaneBoundary(lbp, rbEgo1)
```

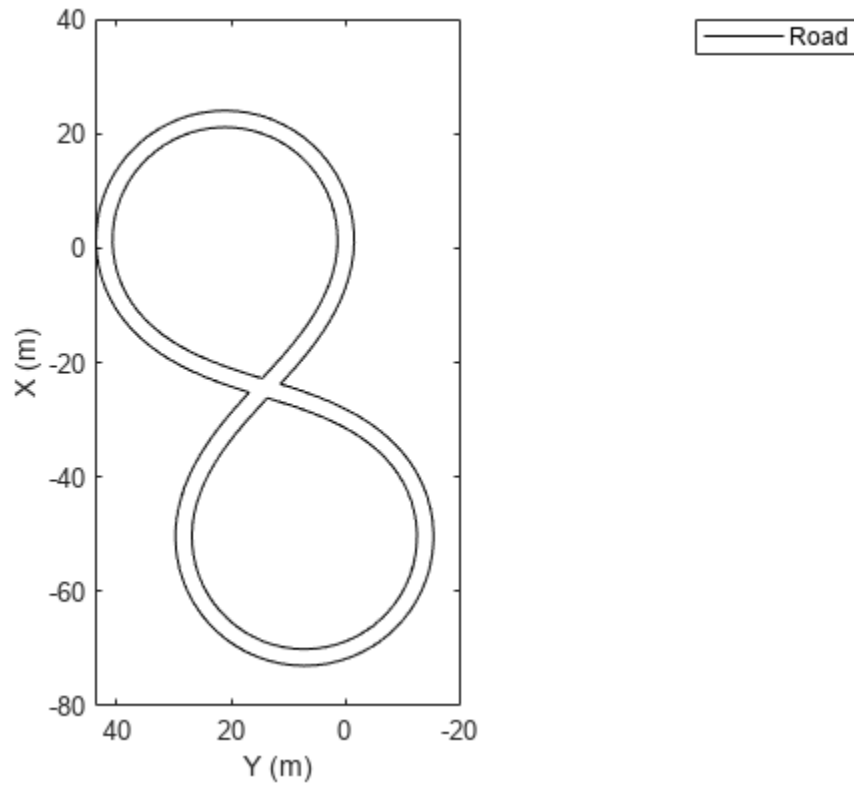
Obtain the road boundaries in world coordinates by using the `roadBoundaries` function. Specify the scenario as the input argument.

```
rbScenario = roadBoundaries(scenario);
```

Obtain the road boundaries in ego vehicle coordinates by using the `driving.scenario.roadBoundariesToEgo` function.

```
rbEgo2 = driving.scenario.roadBoundariesToEgo(rbScenario, ego);
```

Display the road boundaries on a bird's-eye plot.

```
bep = birdsEyePlot;  
lbp = laneBoundaryPlotter(bep, 'DisplayName', 'Road boundaries');  
plotLaneBoundary(lbp, {rbEgo2})
```

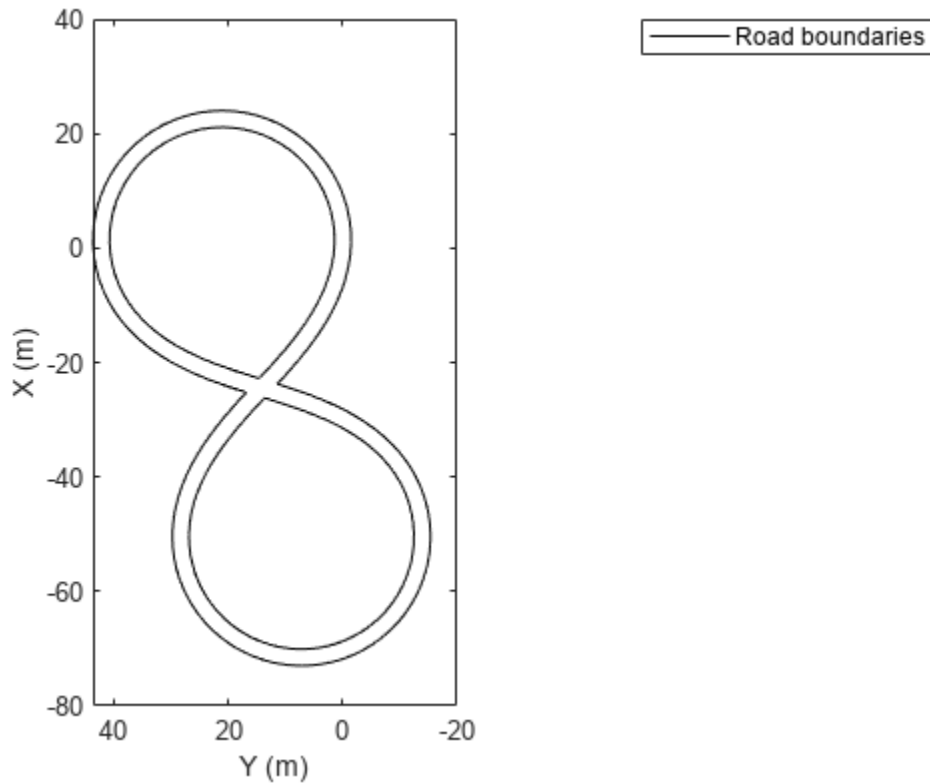

Create Driving Scenario with Multiple Actors and Roads

Create a driving scenario containing a curved road, two straight roads, and two actors: a car and a bicycle. Both actors move along the road for 60 seconds.

Create the driving scenario object.

```
scenario = drivingScenario('SampleTime',0.1,'StopTime',60);
```

Create the curved road using road center points following the arc of a circle with an 800-meter radius. The arc starts at 0°, ends at 90°, and is sampled at 5° increments.

```
angs = [0:5:90]';
R = 800;
roadcenters = R*[cosd(angs) sind(angs) zeros(size(angs))];
roadwidth = 10;
cr = road(scenario,roadcenters,roadwidth);
```

Add two straight roads with the default width, using road center points at each end. To the first straight road add barriers on both road edges.

```
roadcenters = [700 0 0; 100 0 0];
sr1 = road(scenario,roadcenters);
barrier(scenario,sr1)
barrier(scenario,sr1,'RoadEdge','left')
```

```
roadcenters = [400 400 0; 0 0 0];
road(scenario,roadcenters);
```

Get the road boundaries.

```
rbdry = roadBoundaries(scenario);
```

Add a car and a bicycle to the scenario. Position the car at the beginning of the first straight road.

```
car = vehicle(scenario,'ClassID',1,'Position',[700 0 0], ...
    'Length',3,'Width',2,'Height',1.6);
```

Position the bicycle farther down the road.

```
bicycle = actor(scenario,'ClassID',3,'Position',[706 376 0]', ...
    'Length',2,'Width',0.45,'Height',1.5);
```

Plot the scenario.

```
plot(scenario,'Centerline','on','RoadCenters','on');
title('Scenario');
```

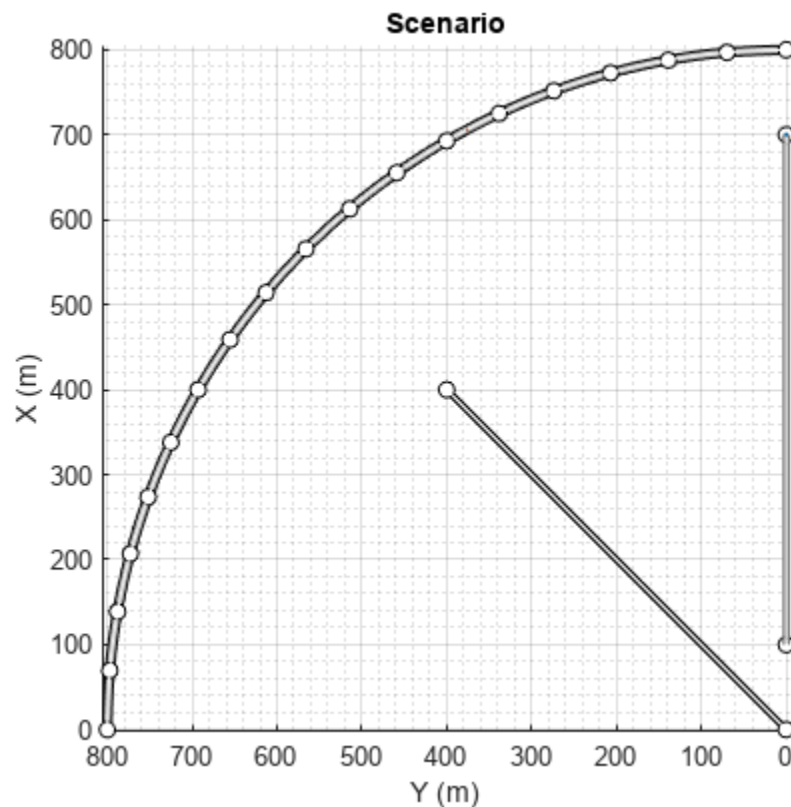

Display the actor poses and profiles.

```
allActorPoses = actorPoses(scenario)
```

```
allActorPoses=242x1 struct array with fields:
    ActorID
```

```
Position
Velocity
Roll
Pitch
Yaw
AngularVelocity
```

```
allActorProfiles = actorProfiles(scenario)
```

```
allActorProfiles=242×1 struct array with fields:
```

```
ActorID
ClassID
Length
Width
Height
OriginOffset
MeshVertices
MeshFaces
RCSPattern
RCSAzimuthAngles
RCSElevationAngles
```

Because there are barriers in this scenario, and each barrier segment is considered an actor, `actorPoses` and `actorProfiles` functions return the poses of all stationary and non-stationary actors. To only obtain the poses and profiles of non-stationary actors such as vehicles and bicycles, first obtain their corresponding actor IDs using the `scenario.actors.ActorID` property.

```
movableActorIDs = [scenario.actors.ActorID];
```

Then, use those IDs to filter only non-stationary actor poses and profiles.

```
movableActorPoseIndices = ismember([allActorPoses.ActorID],movableActorIDs);
```

```
movableActorPoses = allActorPoses(movableActorPoseIndices)
```

```
movableActorPoses=2×1 struct array with fields:
```

```
ActorID
Position
Velocity
Roll
Pitch
Yaw
AngularVelocity
```

```
movableActorProfiles = allActorProfiles(movableActorPoseIndices)
```

```
movableActorProfiles=2×1 struct array with fields:
```

```
ActorID
ClassID
Length
Width
Height
OriginOffset
MeshVertices
MeshFaces
RCSPattern
```

RCSAzimuthAngles
RCSElevationAngles

Input Arguments

scenario — Driving scenario

`drivingScenario` object

Driving scenario, specified as a `drivingScenario` object.

Name-Value Pair Arguments

Specify optional pairs of arguments as `Name1=Value1, ..., NameN=ValueN`, where `Name` is the argument name and `Value` is the corresponding value. Name-value arguments must appear after other arguments, but the order of the pairs does not matter.

Before R2021a, use commas to separate each name and value, and enclose `Name` in quotes.

Example: `plot(sc, 'Centerline', 'on', 'RoadCenters', 'on')` displays the center line and road centers of each road segment.

Parent — Axes in which to draw plot

Axes object

Axes in which to draw the plot, specified as the comma-separated pair consisting of `'Parent'` and an Axes object. If you do not specify `Parent`, a new figure is created.

Centerline — Display center line of roads

`'off'` (default) | `'on'`

Display the center line of roads, specified as the comma-separated pair consisting of `'Centerline'` and `'off'` or `'on'`. The center line follows the middle of each road segment. Center lines are discontinuous through areas such as intersections or road splits.

RoadCenters — Display road centers

`'off'` (default) | `'on'`

Display road centers, specified as the comma-separated pair consisting of `'RoadCenters'` and `'off'` or `'on'`. The road centers define the roads shown in the plot.

Waypoints — Display actor waypoints

`'off'` (default) | `'on'`

Display actor waypoints, specified as the comma-separated pair consisting of `'Waypoints'` and `'off'` or `'on'`. Waypoints define the trajectory of the actor.

Meshes — Display actor meshes

`'off'` (default) | `'on'`

Display actor meshes instead of cuboids, specified as the comma-separated pair consisting of `'Meshes'` and `'off'` or `'on'`.

ActorIndicators – Actors around which to draw indicator

[] (default) | vector of ActorID integers

Actors around which to draw indicators, specified as the comma-separated pair consisting of 'ActorIndicators' and a vector of ActorID integers. The driving scenario plot draws circles around the actors that have the specified ActorID values. Each circle is the same color as the actor that it surrounds. The circles are not sensor coverage areas.

Use this name-value pair to highlight the ego vehicle in driving scenarios that contain several vehicles.

ParkingLotEdges – Display parking lot edge numbers

'off' (default) | 'on'

Display parking lot edge numbers, specified as the comma-separated pair consisting of 'ParkingLotEdges' and 'off' or 'on'. The order of the edge numbers is based on the order of the vertices defined in each parking lot.

Tips

- To rotate any plot, in the figure window, select **View > Camera Toolbar**.

Version History

Introduced in R2017a

See Also**Objects**

drivingScenario

Functions

chasePlot | smoothTrajectory | actor | vehicle | road

Topics

“Create Driving Scenario Programmatically”

“Create Actor and Vehicle Trajectories Programmatically”

“Define Road Layouts Programmatically”

record

Run driving scenario and record actor states

Syntax

```
rec = record(scenario)
```

Description

`rec = record(scenario)` returns a recording, `rec`, of the states of actors in a driving scenario simulation, `scenario`. To record a scenario, you must define the trajectory of at least one actor.

Examples

Record Actor Poses from Driving Scenario

Create a driving scenario in which one car passes a stationary car on a two-lane road.

```
scenario = drivingScenario;
road(scenario,[0 0; 10 0; 53 -20], 'lanes',lanespec(2));
plot(scenario,'Waypoints','on');
stationaryCar = vehicle(scenario,'ClassID',1,'Position',[25 -5.5 0],'Yaw',-22);

passingCar = vehicle(scenario,'ClassID',1);
waypoints = [1 -1.5; 16.36 -2.5; 17.35 -2.765; ...
            23.83 -2.01; 24.9 -2.4; 50.5 -16.7];
speed = 15; % m/s
smoothTrajectory(passingCar,waypoints,speed);
```

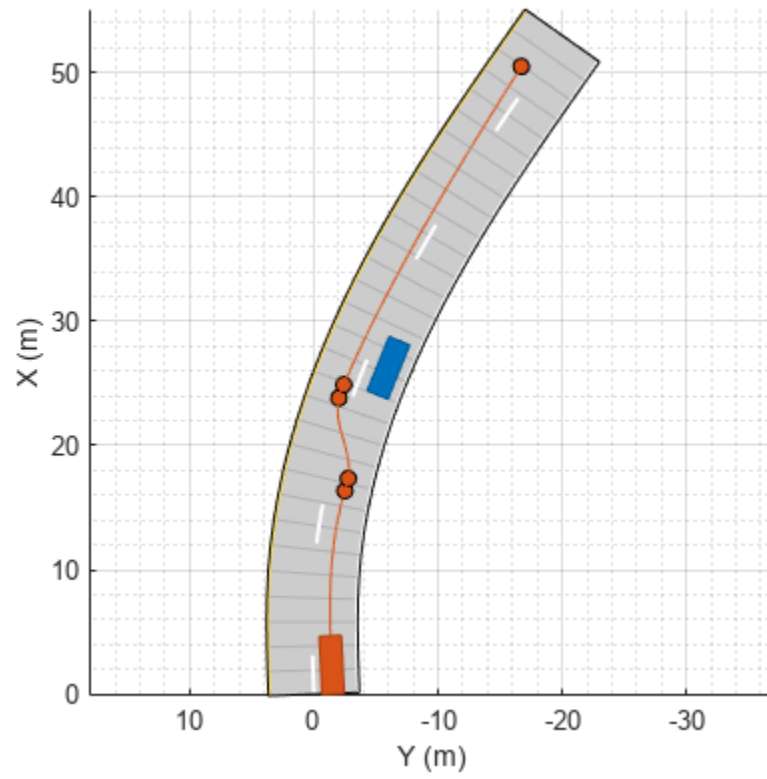

Record the driving scenario simulation.

```
rec = record(scenario);
```

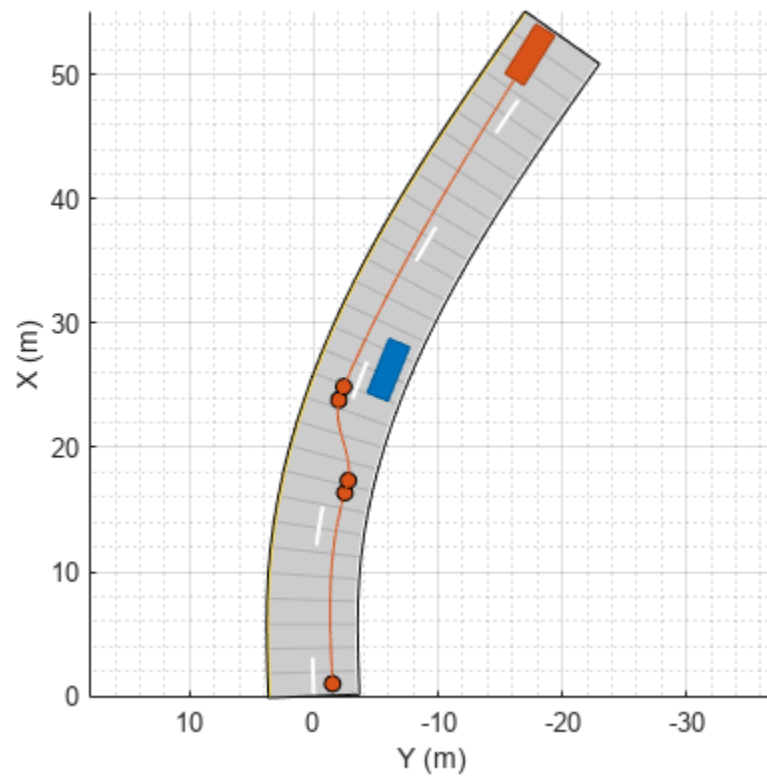
Compare the recorded poses of the passing car at the start and end of the simulation.

```
rec(1).ActorPoses(2)
```

```
ans = struct with fields:
  ActorID: 2
  Position: [1 -1.5000 0]
  Velocity: [14.9816 0.7423 0]
  Roll: 0
  Pitch: 0
  Yaw: 2.8367
  AngularVelocity: [0 0 1.2537e-05]
```

```
rec(end).ActorPoses(2)
```

```
ans = struct with fields:
  ActorID: 2
  Position: [50.4717 -16.6823 0]
  Velocity: [12.7171 -7.9546 0]
  Roll: 0
  Pitch: 0
  Yaw: -32.0261
  AngularVelocity: [0 0 -0.0099]
```

Input Arguments

scenario — Driving scenario

`drivingScenario` object

Driving scenario, specified as a `drivingScenario` object.

Output Arguments

rec — Recording of actor states during simulation

M -by-1 vector of structures

Recording of actor states during simulation, returned as an M -by-1 vector of structures. M is the number of time steps in the simulation. Each structure corresponds to a simulation time step.

The `rec` structure has these fields:

Field	Description	Type
<code>SimulationTime</code>	Simulation time at each time step	Real scalar
<code>ActorPoses</code>	Actor poses in scenario coordinates	N -by-1 vector of <code>ActorPoses</code> structures, where N is the number of actors, including vehicles.

Each `ActorPoses` structure has these fields.

Field	Description
<code>ActorID</code>	Scenario-defined actor identifier, specified as a positive integer.
<code>Position</code>	Position of actor, specified as a real-valued vector of the form $[x \ y \ z]$. Units are in meters.
<code>Velocity</code>	Velocity (v) of actor in the x - y -, and z -directions, specified as a real-valued vector of the form $[v_x \ v_y \ v_z]$. Units are in meters per second.
<code>Roll</code>	Roll angle of actor, specified as a real-valued scalar. Units are in degrees.
<code>Pitch</code>	Pitch angle of actor, specified as a real-valued scalar. Units are in degrees.
<code>Yaw</code>	Yaw angle of actor, specified as a real-valued scalar. Units are in degrees.
<code>AngularVelocity</code>	Angular velocity (ω) of actor in the x -, y -, and z -directions, specified as a real-valued vector of the form $[\omega_x \ \omega_y \ \omega_z]$. Units are in degrees per second.

For full definitions of these structure fields, see the `actor` and `vehicle` functions.

Data Types: `struct`

Version History

Introduced in R2017a

See Also

Objects

drivingScenario

Functions

restart | vehicle | actor | advance | actorPoses

Topics

“Create Driving Scenario Programmatically”

restart

Restart driving scenario simulation from beginning

Syntax

```
restart(scenario)
```

Description

`restart(scenario)` restarts the simulation of the driving scenario, `scenario`, from the beginning. The function sets the `SimulationTime` property of the driving scenario to 0.

Examples

Restart Driving Scenario Simulation

Create a driving scenario in which a vehicle travels down a straight, 25-meter road at 20 meters per second. Plot the scenario.

```
scenario = drivingScenario('SampleTime',0.1);
```

```
roadcenters= [0 0 0; 25 0 0];  
road(scenario,roadcenters)
```

```
ans =  
  Road with properties:  
  
      Name: ""  
   RoadID: 1  
RoadCenters: [2x3 double]  
  RoadWidth: 6  
  BankAngle: [2x1 double]  
   Heading: [2x1 double]
```

```
v = vehicle(scenario,'ClassID',1);
```

```
waypoints = [5 0 0; 20 0 0];  
speed = 20; % m/s  
smoothTrajectory(v,waypoints,speed)
```

```
plot(scenario)
```

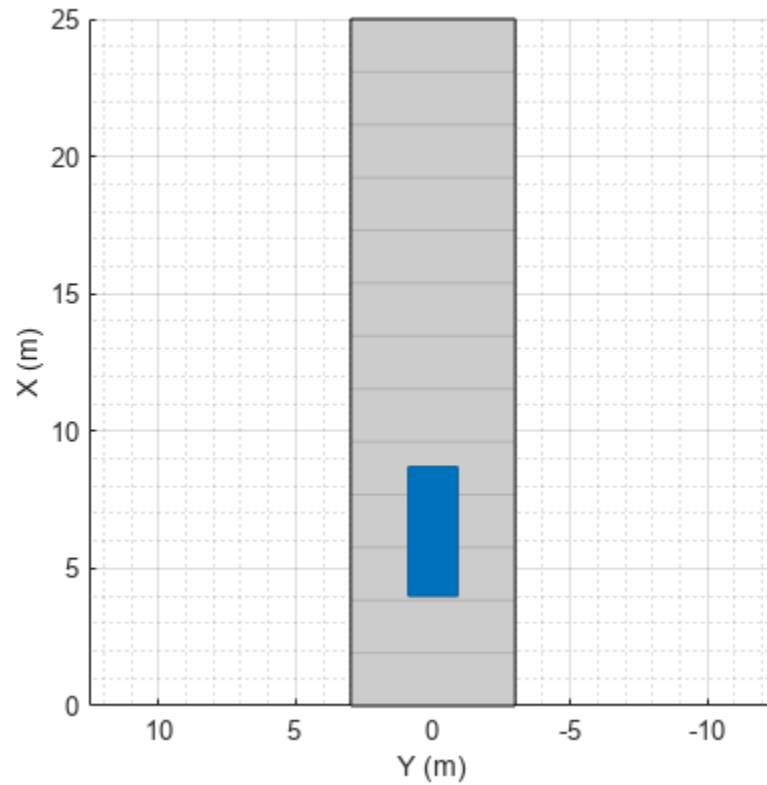

Run the simulation and display the location of the vehicle at each time step.

```
while advance(scenario)
    fprintf('Vehicle location: %0.2f meters at t = %0.0f ms\n', ...
        v.Position(1), ...
        scenario.SimulationTime * 1000)
end
```

```
Vehicle location: 7.00 meters at t = 100 ms
Vehicle location: 9.00 meters at t = 200 ms
Vehicle location: 11.00 meters at t = 300 ms
Vehicle location: 13.00 meters at t = 400 ms
Vehicle location: 15.00 meters at t = 500 ms
Vehicle location: 17.00 meters at t = 600 ms
Vehicle location: 19.00 meters at t = 700 ms
```

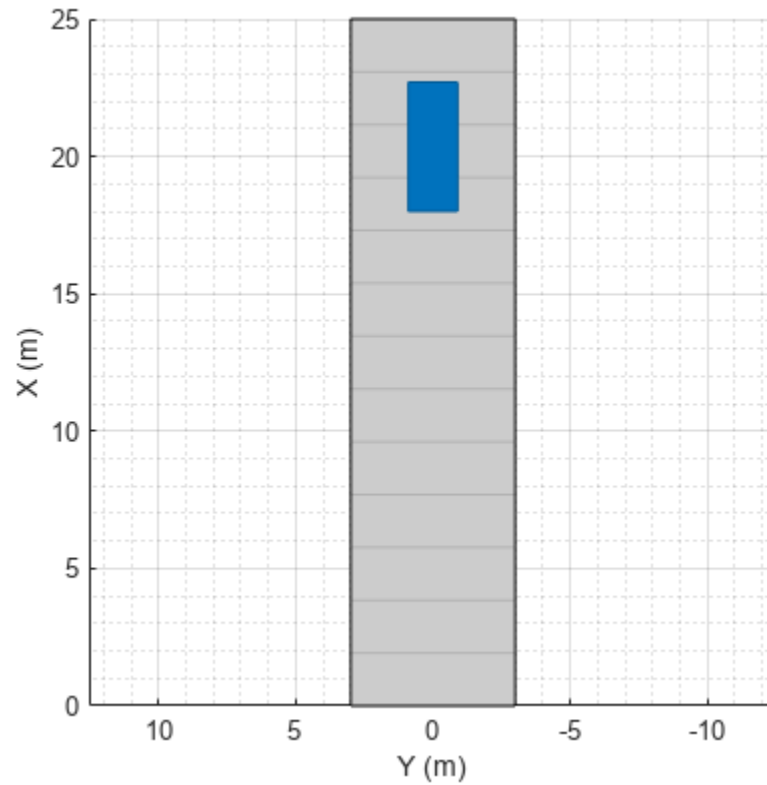

Restart the simulation. Increase the sample time and rerun the simulation.

```
restart(scenario);
scenario.SampleTime = 0.2;

while advance(scenario)
    fprintf('Vehicle location: %0.2f meters at t = %0.0f ms\n', ...
        v.Position(1), ...
        scenario.SimulationTime * 1000)
end
```

```
Vehicle location: 9.00 meters at t = 200 ms
Vehicle location: 13.00 meters at t = 400 ms
Vehicle location: 17.00 meters at t = 600 ms
```

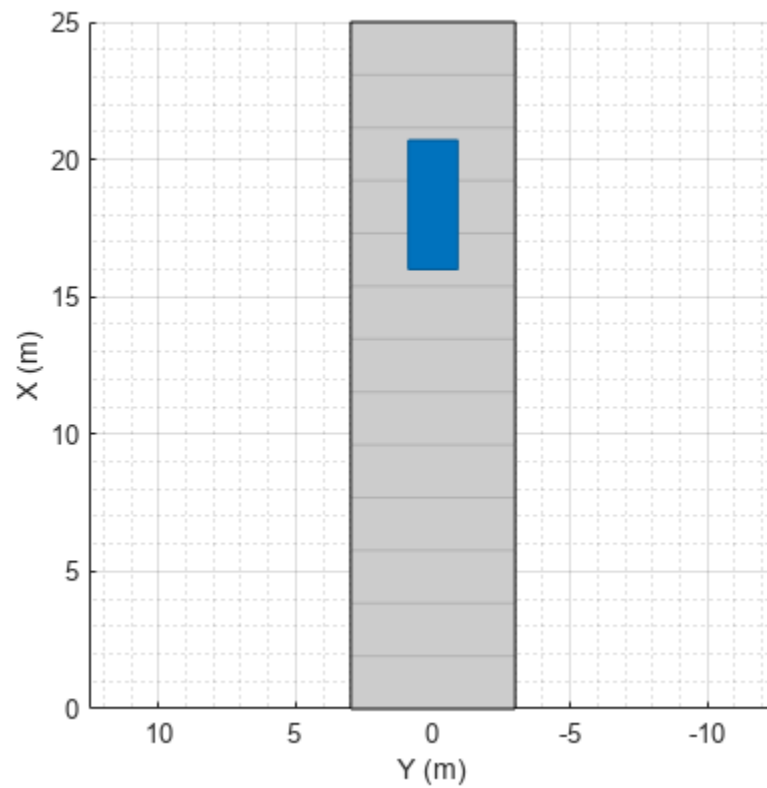

Input Arguments

scenario – Driving scenario

`drivingScenario` object

Driving scenario, specified as a `drivingScenario` object.

Version History

Introduced in R2017a

See Also

Objects

`drivingScenario`

Functions

`advance` | `record`

Topics

“Create Driving Scenario Programmatically”

updatePlots

Update driving scenario plots

Syntax

```
updatePlots(scenario)
```

Description

`updatePlots(scenario)` updates the display of all existing plots for the driving scenario, `scenario`. Driving scenario plots are automatically updated every time you call the `advance` function to advance the simulation. Use `updatePlots` after you update any actor properties and want to refresh the plot without having to call `advance`.

Examples

Update Driving Scenario Plots

Update driving scenario plots after changing aspects of the scenario.

Create a driving scenario containing a vehicle on a straight, 25-meter road segment. Plot the scenario.

```
scenario = drivingScenario;  
roadcenters = [0 0 0; 25 0 0];  
road(scenario,roadcenters);  
  
v = vehicle(scenario,'ClassID',1);  
v.Position = [1 0 0];  
  
plot(scenario)
```

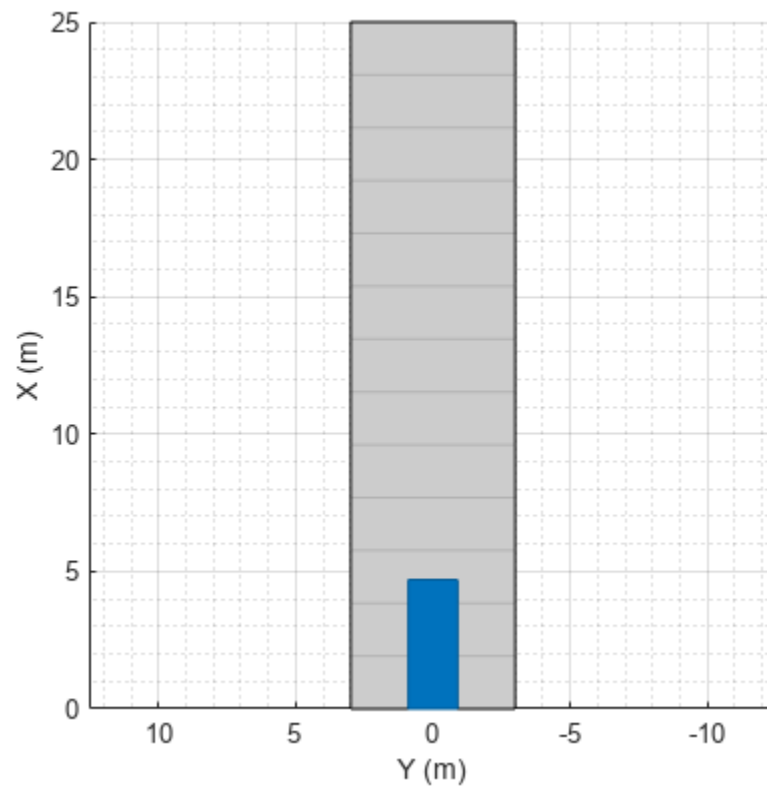
Use a chase plot to plot the scenario from the perspective of the vehicle.

`chasePlot(v)`



Set a new position for the vehicle.

```
v.Position = [12 0 0];
```

Update both plots to show the new position of the vehicle.

```
updatePlots(scenario)
```

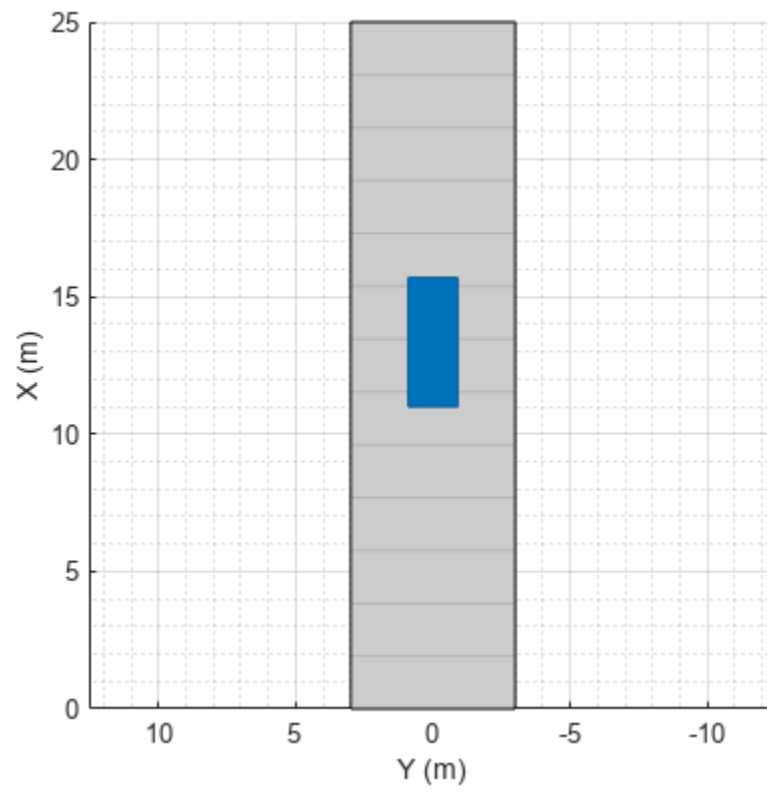

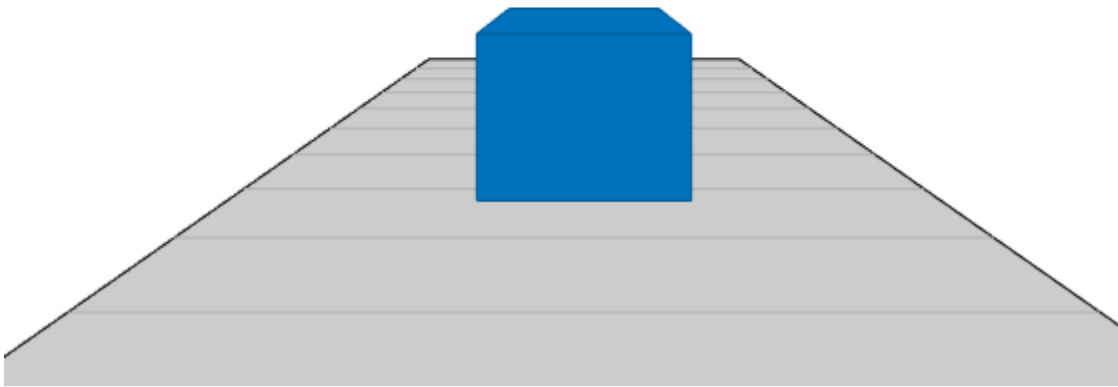

Input Arguments

scenario – Driving scenario
`drivingScenario` object

Driving scenario, specified as a `drivingScenario` object.

Version History

Introduced in R2017a

See Also

Objects
`drivingScenario`

Functions
`advance` | `plot` | `chasePlot`

Topics
“Create Driving Scenario Programmatically”

actor

Package:

Add actor to driving scenario

Syntax

```
ac = actor(scenario)
ac = actor(scenario,Name,Value)
```

Description

`ac = actor(scenario)` adds an Actor object, `ac`, to the driving scenario, `scenario`. The actor has default property values.

Actors are cuboids (box shapes) that represent objects in motion, such as cars, pedestrians, and bicycles. Actors can also represent stationary obstacles that can influence the motion of other actors, such as barriers. For more details about how actors are defined, see “Actor and Vehicle Positions and Dimensions” on page 4-399.

`ac = actor(scenario,Name,Value)` sets actor properties using one or more name-value pair arguments. For example, you can set the position, velocity, dimensions, and orientation of the actor. You can also set a time for the actor to spawn or despawn in the scenario.

Note You can configure the actors in a driving scenario to spawn and despawn, and then import the associated `drivingScenario` object into the **Driving Scenario Designer** app. The app considers the first actor created in the driving scenario to be the ego actor and does not allow the ego actor to either spawn or despawn in the scenario.

Examples

Create Driving Scenario with Multiple Actors and Roads

Create a driving scenario containing a curved road, two straight roads, and two actors: a car and a bicycle. Both actors move along the road for 60 seconds.

Create the driving scenario object.

```
scenario = drivingScenario('SampleTime',0.1,'StopTime',60);
```

Create the curved road using road center points following the arc of a circle with an 800-meter radius. The arc starts at 0°, ends at 90°, and is sampled at 5° increments.

```
angs = [0:5:90]';
R = 800;
roadcenters = R*[cosd(angs) sind(angs) zeros(size(angs))];
roadwidth = 10;
cr = road(scenario,roadcenters,roadwidth);
```

Add two straight roads with the default width, using road center points at each end. To the first straight road add barriers on both road edges.

```
roadcenters = [700 0 0; 100 0 0];
sr1 = road(scenario,roadcenters);
barrier(scenario,sr1)
barrier(scenario,sr1,'RoadEdge','left')
roadcenters = [400 400 0; 0 0 0];
road(scenario,roadcenters);
```

Get the road boundaries.

```
rbdry = roadBoundaries(scenario);
```

Add a car and a bicycle to the scenario. Position the car at the beginning of the first straight road.

```
car = vehicle(scenario,'ClassID',1,'Position',[700 0 0], ...
    'Length',3,'Width',2,'Height',1.6);
```

Position the bicycle farther down the road.

```
bicycle = actor(scenario,'ClassID',3,'Position',[706 376 0]', ...
    'Length',2,'Width',0.45,'Height',1.5);
```

Plot the scenario.

```
plot(scenario,'Centerline','on','RoadCenters','on');
title('Scenario');
```

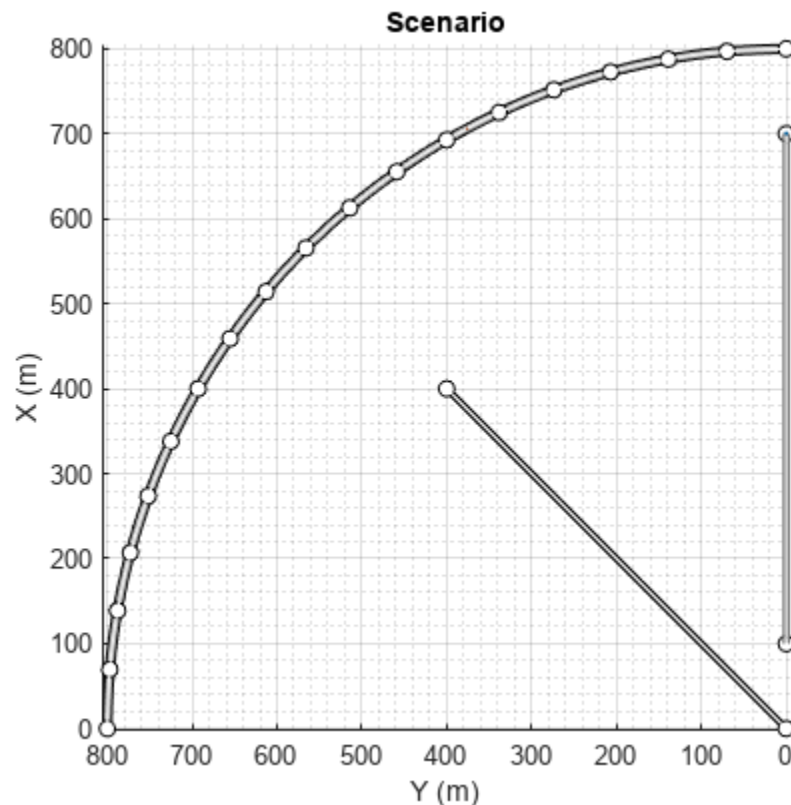

Display the actor poses and profiles.

```
allActorPoses = actorPoses(scenario)
```

```
allActorPoses=242x1 struct array with fields:
```

```
ActorID
Position
Velocity
Roll
Pitch
Yaw
AngularVelocity
```

```
allActorProfiles = actorProfiles(scenario)
```

```
allActorProfiles=242x1 struct array with fields:
```

```
ActorID
ClassID
Length
Width
Height
OriginOffset
MeshVertices
MeshFaces
RCSPattern
RCSAzimuthAngles
RCSElevationAngles
```

Because there are barriers in this scenario, and each barrier segment is considered an actor, `actorPoses` and `actorProfiles` functions return the poses of all stationary and non-stationary actors. To only obtain the poses and profiles of non-stationary actors such as vehicles and bicycles, first obtain their corresponding actor IDs using the `scenario.actors.ActorID` property.

```
movableActorIDs = [scenario.actors.ActorID];
```

Then, use those IDs to filter only non-stationary actor poses and profiles.

```
movableActorPoseIndices = ismember([allActorPoses.ActorID],movableActorIDs);
```

```
movableActorPoses = allActorPoses(movableActorPoseIndices)
```

```
movableActorPoses=2x1 struct array with fields:
```

```
ActorID
Position
Velocity
Roll
Pitch
Yaw
AngularVelocity
```

```
movableActorProfiles = allActorProfiles(movableActorPoseIndices)
```

```
movableActorProfiles=2x1 struct array with fields:
```

```
ActorID
ClassID
Length
```

```
Width
Height
OriginOffset
MeshVertices
MeshFaces
RCSPattern
RCSAzimuthAngles
RCSElevationAngles
```

Spawn and Despawn Actors in Scenario During Simulation

Create a driving scenario. Set the stop time for the scenario to 3 seconds.

```
scenario = drivingScenario('StopTime',3);
```

Add a two-lane road to the scenario.

```
roadCenters = [0 1 0; 53 1 0];
laneSpecification = lanespec([1 1]);
road(scenario,roadCenters,'Lanes',laneSpecification);
```

Add another road that intersects the first road at a right angle to form a T-shape.

```
roadCenters = [20.3 38.4 0; 20 3 0];
laneSpecification = lanespec(2);
road(scenario,roadCenters,'Lanes',laneSpecification)
```

```
ans =
```

```
  Road with properties:
```

```
      Name: ""
     RoadID: 2
RoadCenters: [2x3 double]
RoadWidth: 7.3500
BankAngle: [2x1 double]
   Heading: [2x1 double]
```

Add the ego vehicle to the scenario and define its waypoints. Set the ego vehicle speed to 20 m/s and generate the trajectories for the ego vehicle.

```
egoVehicle = vehicle(scenario,'ClassID',1, ...
                    'Position',[1.5 2.5 0]);
waypoints = [2 3 0; 13 3 0;
            21 3 0; 31 3 0;
            43 3 0; 47 3 0];
speed = 20;
trajectory(egoVehicle,waypoints,speed)
```

Add a non-ego actor to the scenario. Set the non-ego actor to spawn and despawn two times during the simulation by specifying vectors for entry time and exit time. Notice that each entry time value is less than the corresponding exit time value.

```
nonEgoactor1 = actor(scenario, 'ClassID',1, ...
    'Position',[22 30 0], 'EntryTime',[0.2 1.4], 'ExitTime',[1.0 2.0]);
```

Define the waypoints for the non-ego actor. Set the non-ego actor speed to 30 m/s and generate its trajectories.

```
waypoints = [22 35 0; 22 23 0;
    22 13 0; 22 7 0;
    18 -0.3 0; 12 -0.8 0; 3 -0.8 0];
speed = 30;
trajectory(nonEgoactor1, waypoints, speed)
```

Add another non-ego actor to the scenario. Set the second non-ego actor to spawn once during the simulation by specifying an entry time as a positive scalar. Since you do not specify an exit time, this actor will remain in the scenario until the scenario ends.

```
nonEgoactor2 = actor(scenario, 'ClassID',1, ...
    'Position',[48 -1 0], 'EntryTime',2);
```

Define the waypoints for the second non-ego actor. Set the actor speed to 50 m/s and generate its trajectories.

```
waypoints = [48 -1 0; 42 -1 0; 28 -1 0;
    16 -1 0; 12 -1 0];
speed = 50;
trajectory(nonEgoactor2, waypoints, speed)
```

Create a custom figure window to plot the scenario.

```
fig = figure;
set(fig, 'Position',[0 0 600 600])
movegui(fig, 'center')
hViewPnl = uipanel(fig, 'Position',[0 0 1 1], 'Title', 'Actor Spawn and Despawn');
hPlt = axes(hViewPnl);
```

Plot the scenario and run the simulation. Observe how the non-ego actors spawn and despawn in the scenario while simulation is running.

```
plot(scenario, 'Waypoints', 'on', 'Parent', hPlt)
while advance(scenario)
    pause(0.1)
end
```

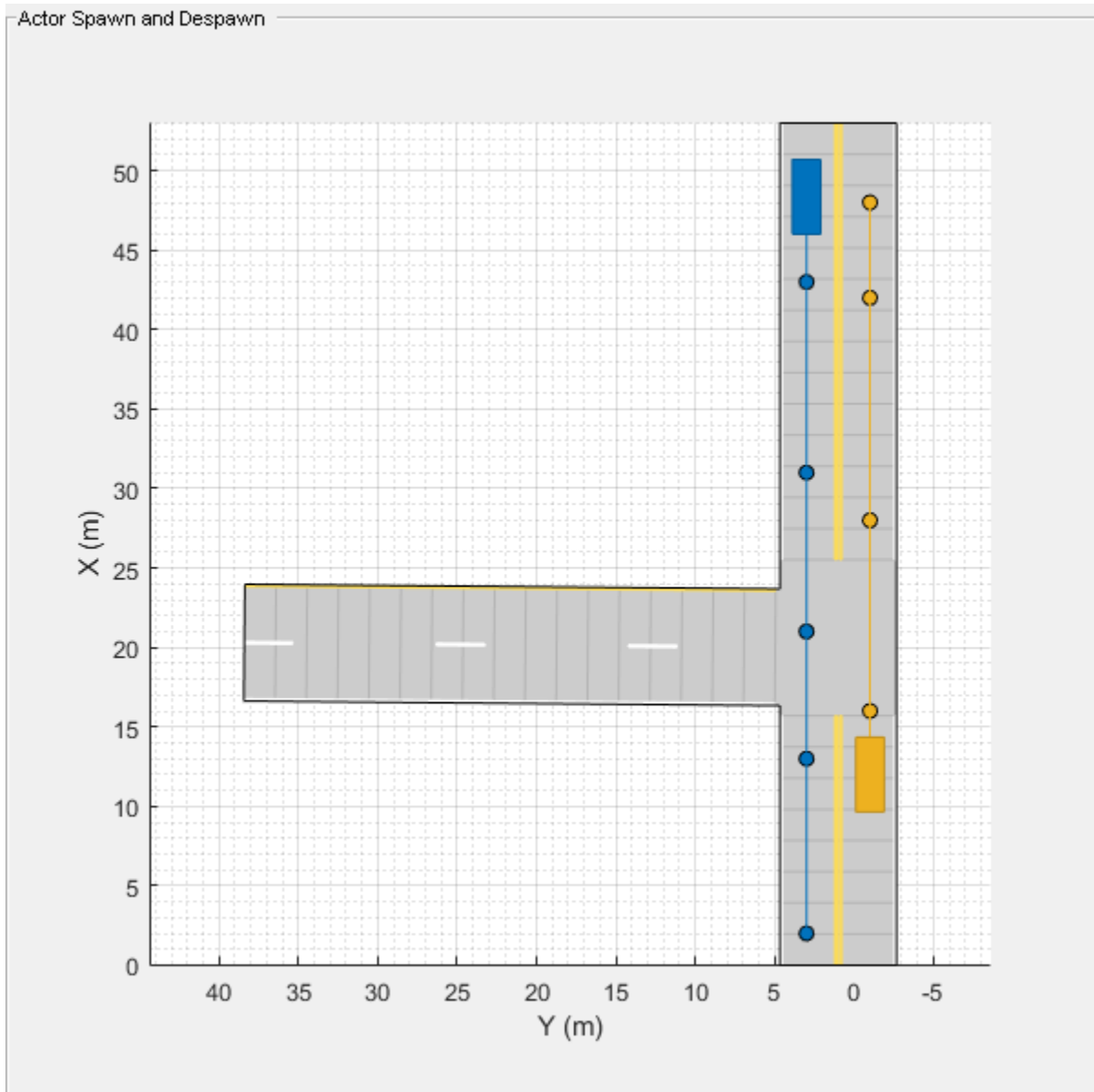

Input Arguments

scenario — Driving scenario

`drivingScenario` object

Driving scenario, specified as a `drivingScenario` object.

Name-Value Pair Arguments

Specify optional pairs of arguments as `Name1=Value1, ..., NameN=ValueN`, where `Name` is the argument name and `Value` is the corresponding value. Name-value arguments must appear after other arguments, but the order of the pairs does not matter.

Before R2021a, use commas to separate each name and value, and enclose Name in quotes.

Example: 'Height',1.7 sets the height of the actor to 1.7 meters upon creation.

ClassID — Classification identifier

0 (default) | nonnegative integer

Classification identifier of actor, specified as the comma-separated pair consisting of 'ClassID' and a nonnegative integer.

Specify ClassID values to group together actors that have similar dimensions, radar cross-section (RCS) patterns, or other properties. As a best practice, before adding actors to a `drivingScenario` object, determine the actor classification scheme you want to use. Then, when creating the actors, specify the ClassID name-value pair to set classification identifiers according to the actor classification scheme.

Suppose you want to create a scenario containing these actors:

- Two cars, one of which is the ego vehicle
- A truck
- A bicycle
- A jersey barrier along a road

The code shows a sample classification scheme for this scenario, where 1 refers to cars, 2 refers to trucks, 3 refers to bicycles and 5 refers to jersey barriers. The cars have default vehicle properties. The truck and bicycle have the dimensions of a typical truck and bicycle, respectively.

```
scenario = drivingScenario;
ego = vehicle(scenario,'ClassID',1);
car = vehicle(scenario,'ClassID',1);
truck = vehicle(scenario,'ClassID',2,'Length',8.2,'Width',2.5,'Height',3.5);
bicycle = actor(scenario,'ClassID',3,'Length',1.7,'Width',0.45,'Height',1.7);
mainRoad = road(scenario,[0 0 0;10 0 0]);
barrier(scenario,mainRoad,'ClassID',5);
```

The default ClassID of 0 is reserved for an object of an unknown or unassigned class. If you plan to import `drivingScenario` objects into the **Driving Scenario Designer** app, do not leave the ClassID property of actors set to 0. The app does not recognize a ClassID of 0 for actors and returns an error. Instead, set ClassID values of actors according to the actor classification scheme used in the app.

ClassID	Class Name
1	Car
2	Truck
3	Bicycle
4	Pedestrian
5	Jersey Barrier
6	Guardrail

Name — Name of actor

"" (default) | character vector | string scalar

Name of the actor, specified as the comma-separated pair consisting of 'Name' and a character vector or string scalar.

Example: 'Name', 'Actor1'

Example: "Name", "Actor1"

Data Types: char | string

EntryTime — Entry time for actor to spawn

0 (default) | positive scalar | vector of positive values

Entry time for an actor to spawn in the driving scenario, specified as the comma-separated pair consisting of 'EntryTime' and a positive scalar or a vector of positive values. Units are in seconds, measured from the start time of the scenario.

Specify this name-value pair argument to add or make an actor appear in the driving scenario at the specified time while the simulation is running.

- To spawn an actor only once, specify entry time as a scalar.
- To spawn an actor multiple times, specify entry time as a vector.
 - Arrange the elements of the vector in ascending order.
 - The length of the vector must match the length of the exit time vector.
- If the actor has an associated exit time, then each entry time value must be less than the corresponding exit time value.
- Each entry time value must be less than the stop time of the scenario. You can set the stop time for the scenario by specifying a value for the 'StopTime' property of the `drivingScenario` object.

Example: 'EntryTime', 2

Example: 'EntryTime', [2 4]

Data Types: single | double | int8 | int16 | int32 | int64 | uint8 | uint16 | uint32 | uint64

ExitTime — Exit time for actor to despawn

Inf (default) | positive scalar | vector of positive values

Exit time for an actor to despawn from the driving scenario, specified as the comma-separated pair consisting of 'ExitTime' and a positive scalar or a vector of positive values. Units are in seconds, measured from the start time of the scenario.

Specify this name-value pair argument to remove or make an actor disappear from the scenario at a specified time while the simulation is running.

- To despawn an actor only once, specify exit time as a scalar.
- To despawn an actor multiple times, specify exit time as a vector.
 - Arrange the elements of the vector in ascending order.
 - The length of the vector must match the length of the entry time vector.
- If the actor has an associated entry time, then each exit time value must be greater than the corresponding entry time value.
- Each exit time value must be less than the stop time of the scenario. You can set the stop time for the scenario by specifying a value for the 'StopTime' property of the `drivingScenario` object.

Example: 'ExitTime',3

Example: 'ExitTime',[3 6]

Data Types: single | double | int8 | int16 | int32 | int64 | uint8 | uint16 | uint32 | uint64

PlotColor — Display color of actor

RGB triplet | hexadecimal color code | color name | short color name

Display color of actor, specified as the comma-separated pair consisting of 'PlotColor' and an RGB triplet, hexadecimal color code, color name, or short color name.







The actor appears in the specified color in all programmatic scenario visualizations, including the `plot` function, `chasePlot` function, and plotting functions of `birdsEyePlot` objects. If you import the scenario into the **Driving Scenario Designer** app, then the actor appears in this color in all app visualizations. If you import the scenario into Simulink, then the actor appears in this color in the **Bird's-Eye Scope**.

If you do not specify a color for the actor, the function assigns one based on the default color order of Axes objects. For more details, see the `ColorOrder` property for Axes objects.

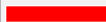
For a custom color, specify an RGB triplet or a hexadecimal color code.



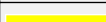

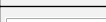

- An RGB triplet is a three-element row vector whose elements specify the intensities of the red, green, and blue components of the color. The intensities must be in the range $[0, 1]$, for example, $[0.4 \ 0.6 \ 0.7]$.
- A hexadecimal color code is a string scalar or character vector that starts with a hash symbol (#) followed by three or six hexadecimal digits, which can range from 0 to F. The values are not case sensitive. Therefore, the color codes "#FF8800", "#ff8800", "#F80", and "#f80" are equivalent.

Alternatively, you can specify some common colors by name. This table lists the named color options, the equivalent RGB triplets, and hexadecimal color codes.

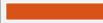
Color Name	Short Name	RGB Triplet	Hexadecimal Color Code	Appearance
"red"	"r"	[1 0 0]	"#FF0000"	
"green"	"g"	[0 1 0]	"#00FF00"	
"blue"	"b"	[0 0 1]	"#0000FF"	
"cyan"	"c"	[0 1 1]	"#00FFFF"	
"magenta"	"m"	[1 0 1]	"#FF00FF"	
"yellow"	"y"	[1 1 0]	"#FFFF00"	
"black"	"k"	[0 0 0]	"#000000"	
"white"	"w"	[1 1 1]	"#FFFFFF"	

Here are the RGB triplets and hexadecimal color codes for the default colors MATLAB uses in many types of plots.

RGB Triplet	Hexadecimal Color Code	Appearance
[0 0.4470 0.7410]	"#0072BD"	

RGB Triplet	Hexadecimal Color Code	Appearance
[0.8500 0.3250 0.0980]	"#D95319"	
[0.9290 0.6940 0.1250]	"#EDB120"	
[0.4940 0.1840 0.5560]	"#7E2F8E"	
[0.4660 0.6740 0.1880]	"#77AC30"	
[0.3010 0.7450 0.9330]	"#4DBEEE"	
[0.6350 0.0780 0.1840]	"#A2142F"	

Position — Position of actor center

[0 0 0] (default) | [x y z] real-valued vector

Position of the actor center, specified as the comma-separated pair consisting of 'Position' and an [x y z] real-valued vector.

The center of the actor is [L/2 W/2 b], where:

- L/2 is the midpoint of actor length L.
- W/2 is the midpoint of actor width W.
- b is the bottom of the cuboid.

Units are in meters.

Example: [10;50;0]

Velocity — Velocity of actor center

[0 0 0] (default) | [v_x v_y v_z] real-valued vector

Velocity (v) of the actor center in the x-, y- and z-directions, specified as the comma-separated pair consisting of 'Velocity' and a [v_x v_y v_z] real-valued vector. The 'Position' name-value pair specifies the actor center. Units are in meters per second.

Example: [-4;7;10]

Yaw — Yaw angle of actor

0 (default) | real scalar

Yaw angle of the actor, specified as the comma-separated pair consisting of 'Yaw' and a real scalar. Yaw is the angle of rotation of the actor around the z-axis. Yaw is clockwise-positive when looking in the forward direction of the axis, which points up from the ground. Therefore, when viewing actors from the top down, such as on a bird's-eye plot, yaw is counterclockwise-positive. Angle values are wrapped to the range [-180, 180]. Units are in degrees.

Example: -0.4

Pitch — Pitch angle of actor

0 (default) | real scalar

Pitch angle of the actor, specified as the comma-separated pair consisting of 'Pitch' and a real scalar. Pitch is the angle of rotation of the actor around the y-axis and is clockwise-positive when looking in the forward direction of the axis. Angle values are wrapped to the range [-180, 180]. Units are in degrees.

Example: 5.8

Roll — Roll angle of actor 0 (default) | real scalar

Roll angle of the actor, specified as the comma-separated pair consisting of 'Roll' and a real scalar. Roll is the angle of rotation of the actor around the x-axis and is clockwise-positive when looking in the forward direction of the axis. Angle values are wrapped to the range [-180, 180]. Units are in degrees.

Example: -10

AngularVelocity — Angular velocity of actor $[0\ 0\ 0]$ (default) | $[\omega_x\ \omega_y\ \omega_z]$ real-valued vector

Angular velocity (ω) of the actor, in world coordinates, specified as the comma-separated pair consisting of 'AngularVelocity' and a $[\omega_x\ \omega_y\ \omega_z]$ real-valued vector. Units are in degrees per second.

Example: [20 40 20]

Length — Length of actor

4.7 (default) | positive real scalar

Length of the actor, specified as the comma-separated pair consisting of 'Length' and a positive real scalar. Units are in meters.

Example: 5.5

Width — Width of actor

1.8 (default) | positive real scalar

Width of the actor, specified as the comma-separated pair consisting of 'Width' and a positive real scalar. Units are in meters.

Example: 3.0

Height — Height of actor

1.4 (default) | positive real scalar

Height of the actor, specified as the comma-separated pair consisting of 'Height' and a positive real scalar. Units are meters.

Example: 2.1

Mesh — Extended object mesh

extendedObjectMesh object

Extended object mesh, specified as an extendedObjectMesh object.

RCSPattern — Radar cross-section pattern of actor $[10\ 10; 10\ 10]$ (default) | Q -by- P real-valued matrix

Radar cross-section (RCS) pattern of actor, specified as the comma-separated pair consisting of 'RCSPattern' and a Q -by- P real-valued matrix. RCS is a function of the azimuth and elevation angles, where:

- Q is the number of elevation angles specified by the 'RCSElevationAngles' name-value pair.

- P is the number of azimuth angles specified by the 'RCSAzimuthAngles' name-value pair.

Units are in decibels per square meter (dBsm).

Example: 5.8

RCSAzimuthAngles — Azimuth angles of actor's RCS pattern

`[-180 180]` (default) | P -element real-valued vector

Azimuth angles of the actor's RCS pattern, specified as the comma-separated pair consisting of 'RCSAzimuthAngles' and a P -element real-valued vector. P is the number of azimuth angles. Values are in the range $[-180^\circ, 180^\circ]$.

Each element of RCSAzimuthAngles defines the azimuth angle of the corresponding column of the 'RCSPattern' name-value pair. Units are in degrees.

Example: `[-90:90]`

RCSElevationAngles — Elevation angles of actor's RCS pattern

`[-90 90]` (default) | Q -element real-valued vector

Elevation angles of the actor's RCS pattern, specified as the comma-separated pair consisting of 'RCSElevationAngles' and a Q -element real-valued vector. Q is the number of elevation angles. Values are in the range $[-90^\circ, 90^\circ]$.

Each element of RCSElevationAngles defines the elevation angle of the corresponding row of the RCSPattern property. Units are in degrees.

Example: `[0:90]`

Output Arguments

ac — Driving scenario actor

Actor object

Driving scenario actor, returned as an Actor object belonging to the driving scenario specified by scenario.

You can modify the Actor object by changing its property values. The property names correspond to the name-value pair arguments used to create the object. The only property that you cannot modify is ActorID, which is a positive integer indicating the unique, scenario-defined ID of the actor.

To specify or visualize actor motion, use these functions:

trajectory	Create actor or vehicle trajectory in driving scenario
smoothTrajectory	Create smooth, jerk-limited actor or vehicle trajectory in driving scenario
chasePlot	Ego-centric projective perspective plot

To get information about actor characteristics, use these functions:

actorPoses	Positions, velocities, and orientations of actors in driving scenario
------------	---

<code>actorProfiles</code>	Physical and radar characteristics of actors in driving scenario
<code>targetOutlines</code>	Outlines of targets viewed by actor
<code>targetPoses</code>	Target positions and orientations relative to ego vehicle
<code>driving.scenario.targetsToEgo</code>	Convert actor poses to ego vehicle coordinates
<code>driving.scenario.targetsToScenario</code>	Convert target actor poses from ego vehicle coordinates to world coordinates of scenario

To get information about the roads and lanes that the actor is on, use these functions:

<code>roadBoundaries</code>	Get road boundaries
<code>driving.scenario.roadBoundariesToEgo</code>	Convert road boundaries to ego vehicle coordinates
<code>currentLane</code>	Get current lane of actor
<code>laneBoundaries</code>	Get lane boundaries of actor lane
<code>laneMarkingVertices</code>	Lane marking vertices and faces in driving scenario
<code>roadMesh</code>	Mesh representation of an actor's nearest roads in driving scenario.

More About

Actor and Vehicle Positions and Dimensions

In driving scenarios, an actor is a cuboid (box-shaped) object with a specific length, width, and height. Actors also have a radar cross-section (RCS) pattern, specified in dBsm, which you can refine by setting angular azimuth and elevation coordinates. The position of an actor is defined as the center of its bottom face. This center point is used as the actor's rotational center, its point of contact with the ground, and its origin in its local coordinate system. In this coordinate system:

- The X-axis points forward from the actor.
- The Y-axis points left from the actor.
- The Z-axis points up from the ground.

Roll, pitch, and yaw are clockwise-positive when looking in the forward direction of the X-, Y-, and Z-axes, respectively.

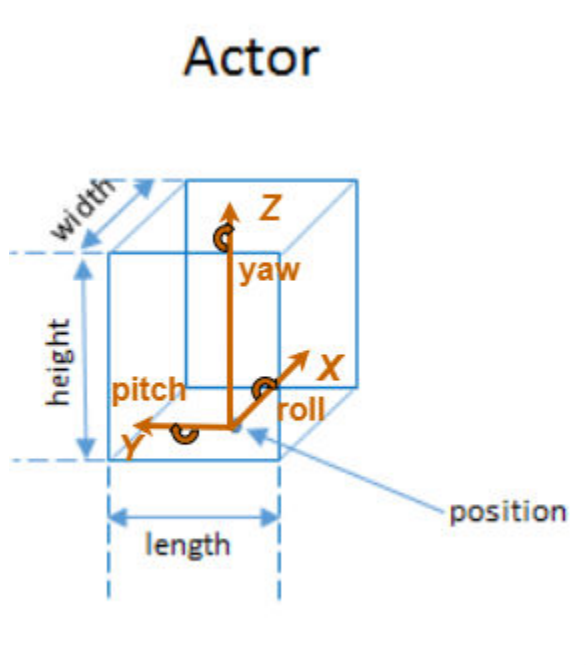

A vehicle is an actor that moves on wheels. Vehicles have three extra properties that govern the placement of their front and rear axle.

- Wheelbase — Distance between the front and rear axles
- Front overhang — Distance between the front of the vehicle and the front axle
- Rear overhang — Distance between the rear axle and the rear of the vehicle

Unlike other types of actors, the position of a vehicle is defined by the point on the ground that is below the center of its rear axle. This point corresponds to the natural center of rotation of the vehicle. As with nonvehicle actors, this point is the origin in the local coordinate system of the vehicle, where:

- The X-axis points forward from the vehicle.
- The Y-axis points left from the vehicle.
- The Z-axis points up from the ground.

Roll, pitch, and yaw are clockwise-positive when looking in the forward direction of the X-, Y-, and Z-axes, respectively.

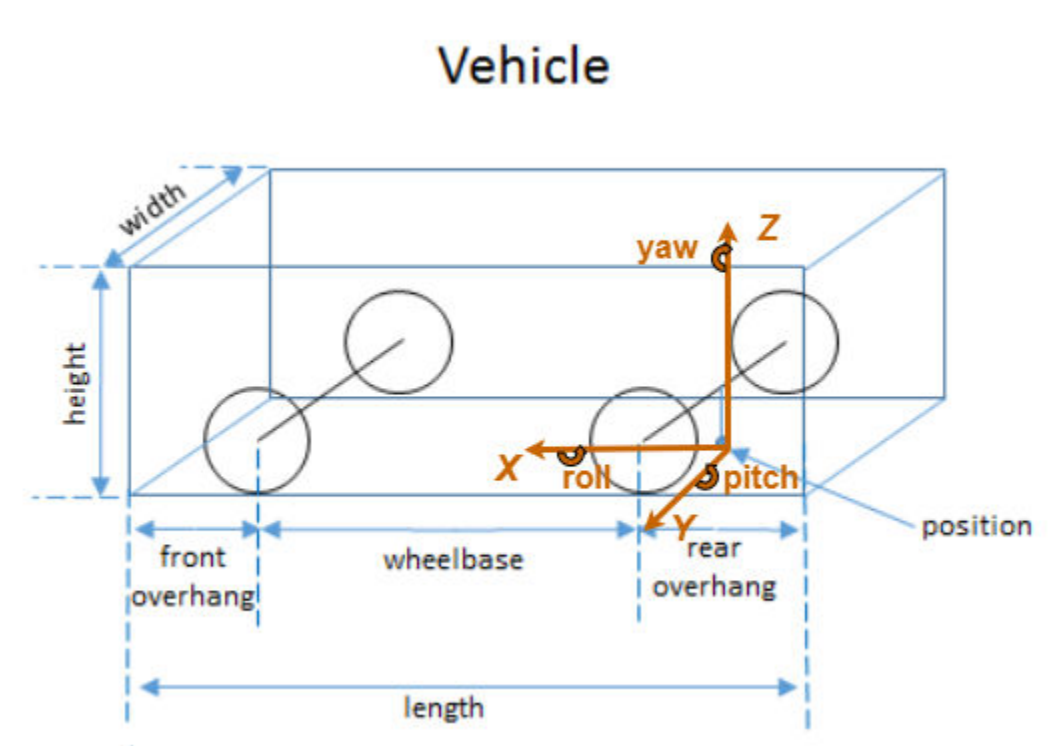

This table shows a list of common actors and their dimensions. To specify these values in Actor and Vehicle objects, set the corresponding properties shown.

Actor Classification	Actor Object	Actor Properties						
		Length	Width	Height	FrontOverhang	RearOverhang	Wheelbase	RCSPattern
Pedestrian	Actor	0.24 m	0.45 m	1.7 m	N/A	N/A	N/A	-8 dBsm
Car	Vehicle	4.7 m	1.8 m	1.4 m	0.9 m	1.0 m	2.8 m	10 dBsm
Motorcycle	Vehicle	2.2 m	0.6 m	1.5 m	0.37 m	0.32 m	1.51 m	0 dBsm

Version History

Introduced in R2017a

See Also

[drivingScenario](#) | [vehicle](#) | [barrier](#)

Topics

“Create Driving Scenario Programmatically”

“Create Actor and Vehicle Trajectories Programmatically”

vehicle

Package:

Add vehicle to driving scenario

Syntax

```
vc = vehicle(scenario)
vc = vehicle(scenario,Name,Value)
```

Description

`vc = vehicle(scenario)` adds a `Vehicle` object, `vc`, to the driving scenario, `scenario`. The vehicle has default property values.

Vehicles are a specialized type of actor cuboid (box-shaped) object that has four wheels. For more details about how vehicles are defined, see “Actor and Vehicle Positions and Dimensions” on page 4-416.

`vc = vehicle(scenario,Name,Value)` sets vehicle properties using one or more name-value pairs. For example, you can set the position, velocity, dimensions, orientation, and wheelbase of the vehicle. You can also set a time for the vehicle to spawn or despawn in the scenario.

Note You can configure the vehicles in a driving scenario to spawn and despawn, and then import the associated `drivingScenario` object into the **Driving Scenario Designer** app. The app considers the first vehicle created in the driving scenario to be the ego vehicle and does not allow the ego vehicle to either spawn or despawn in the scenario.

Examples

Create Driving Scenario with Multiple Actors and Roads

Create a driving scenario containing a curved road, two straight roads, and two actors: a car and a bicycle. Both actors move along the road for 60 seconds.

Create the driving scenario object.

```
scenario = drivingScenario('SampleTime',0.1,'StopTime',60);
```

Create the curved road using road center points following the arc of a circle with an 800-meter radius. The arc starts at 0°, ends at 90°, and is sampled at 5° increments.

```
angs = [0:5:90]';
R = 800;
roadcenters = R*[cosd(angs) sind(angs) zeros(size(angs))];
roadwidth = 10;
cr = road(scenario,roadcenters,roadwidth);
```

Add two straight roads with the default width, using road center points at each end. To the first straight road add barriers on both road edges.

```
roadcenters = [700 0 0; 100 0 0];
sr1 = road(scenario,roadcenters);
barrier(scenario,sr1)
barrier(scenario,sr1,'RoadEdge','left')
roadcenters = [400 400 0; 0 0 0];
road(scenario,roadcenters);
```

Get the road boundaries.

```
rbdry = roadBoundaries(scenario);
```

Add a car and a bicycle to the scenario. Position the car at the beginning of the first straight road.

```
car = vehicle(scenario,'ClassID',1,'Position',[700 0 0], ...
    'Length',3,'Width',2,'Height',1.6);
```

Position the bicycle farther down the road.

```
bicycle = actor(scenario,'ClassID',3,'Position',[706 376 0]', ...
    'Length',2,'Width',0.45,'Height',1.5);
```

Plot the scenario.

```
plot(scenario,'Centerline','on','RoadCenters','on');
title('Scenario');
```

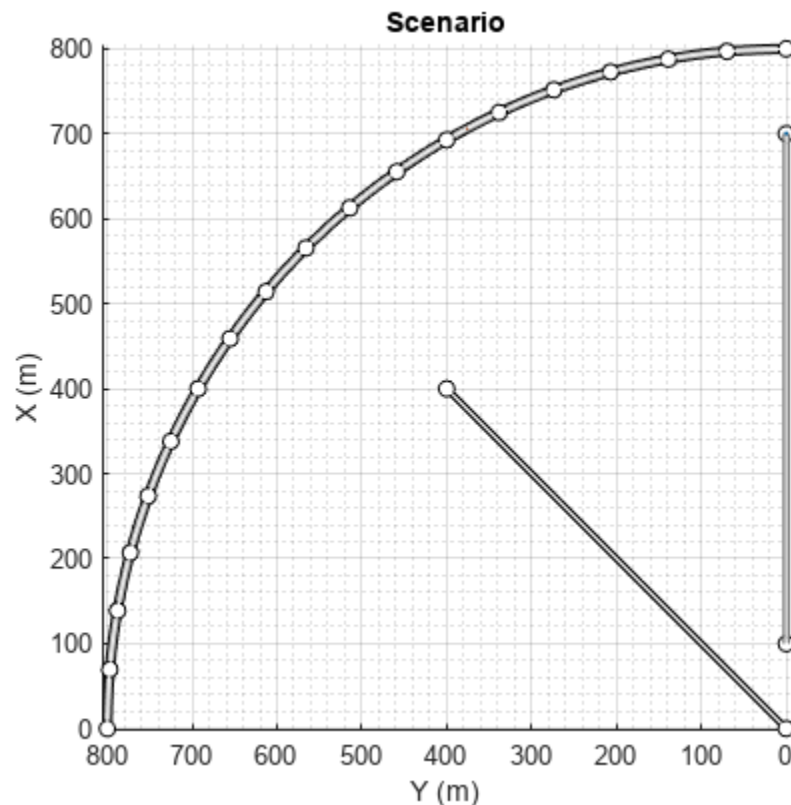

Display the actor poses and profiles.

```
allActorPoses = actorPoses(scenario)
```

```
allActorPoses=242×1 struct array with fields:
```

```
ActorID  
Position  
Velocity  
Roll  
Pitch  
Yaw  
AngularVelocity
```

```
allActorProfiles = actorProfiles(scenario)
```

```
allActorProfiles=242×1 struct array with fields:
```

```
ActorID  
ClassID  
Length  
Width  
Height  
OriginOffset  
MeshVertices  
MeshFaces  
RCSPattern  
RCSAzimuthAngles  
RCSElevationAngles
```

Because there are barriers in this scenario, and each barrier segment is considered an actor, `actorPoses` and `actorProfiles` functions return the poses of all stationary and non-stationary actors. To only obtain the poses and profiles of non-stationary actors such as vehicles and bicycles, first obtain their corresponding actor IDs using the `scenario.actors.ActorID` property.

```
movableActorIDs = [scenario.actors.ActorID];
```

Then, use those IDs to filter only non-stationary actor poses and profiles.

```
movableActorPoseIndices = ismember([allActorPoses.ActorID],movableActorIDs);
```

```
movableActorPoses = allActorPoses(movableActorPoseIndices)
```

```
movableActorPoses=2×1 struct array with fields:
```

```
ActorID  
Position  
Velocity  
Roll  
Pitch  
Yaw  
AngularVelocity
```

```
movableActorProfiles = allActorProfiles(movableActorPoseIndices)
```

```
movableActorProfiles=2×1 struct array with fields:
```

```
ActorID  
ClassID  
Length
```

```

Width
Height
OriginOffset
MeshVertices
MeshFaces
RCSPattern
RCSAzimuthAngles
RCSElevationAngles

```

Spawn and Despawn Vehicles in Scenario During Simulation

Create a driving scenario. Set the stop time for the scenario to 3 seconds.

```
scenario = drivingScenario('StopTime',3);
```

Add a two-lane road to the scenario.

```
roadCenters = [0 1 0; 53 1 0];
laneSpecification = lanespec([1 1]);
road(scenario,roadCenters,'Lanes',laneSpecification);
```

Add another road that intersects the first road at a right angle to form a T-shape.

```
roadCenters = [20.3 38.4 0; 20 3 0];
laneSpecification = lanespec(2);
road(scenario,roadCenters,'Lanes',laneSpecification)
```

```
ans =
```

```
Road with properties:
```

```

    Name: ""
   RoadID: 2
 RoadCenters: [2x3 double]
 RoadWidth: 7.3500
 BankAngle: [2x1 double]
   Heading: [2x1 double]

```

Add the ego vehicle to the scenario and define its waypoints. Set the ego vehicle speed to 20 m/s and generate the trajectories for the ego vehicle.

```
egoVehicle = vehicle(scenario,'ClassID',1, ...
    'Position',[1.5 2.5 0]);
waypoints = [2 3 0; 13 3 0;
            21 3 0; 31 3 0;
            43 3 0; 47 3 0];
speed = 20;
smoothTrajectory(egoVehicle,waypoints,speed)
```

Add a non-ego vehicle to the scenario. Set the non-ego vehicle to spawn and despawn two times during the simulation by specifying vectors for entry time and exit time. Notice that each entry time value is less than the corresponding exit time value.

```
nonEgovehicle1 = vehicle(scenario,'ClassID',1, ...  
    'Position',[22 30 0],'EntryTime',[0.2 1.4],'ExitTime',[1.0 2.0]);
```

Define the waypoints for the non-ego vehicle. Set the non-ego vehicle speed to 30 m/s and generate its trajectories.

```
waypoints = [22 35 0; 22 23 0;  
            22 13 0; 22 7 0;  
            18 -0.3 0; 12 -0.8 0; 5 -0.8 0];  
speed = 30;  
smoothTrajectory(nonEgovehicle1,waypoints,speed)
```

Add another non-ego vehicle to the scenario. Set the second non-ego vehicle to spawn once during the simulation by specifying an entry time as a positive scalar. Since you do not specify an exit time, this vehicle will remain in the scenario until the scenario ends.

```
nonEgovehicle2 = vehicle(scenario,'ClassID',1, ...  
    'Position',[48 -1 0],'EntryTime',2);
```

Define the waypoints for the second non-ego vehicle. Set the vehicle speed to 50 m/s and generate its trajectories.

```
waypoints = [48 -1 0; 42 -1 0; 28 -1 0;  
            16 -1 0; 12 -1 0];  
speed = 50;  
smoothTrajectory(nonEgovehicle2,waypoints,speed)
```

Create a custom figure window to plot the scenario.

```
fig = figure;  
set(fig,'Position',[0 0 600 600])  
movegui(fig,'center')  
hViewPnl = uipanel(fig,'Position',[0 0 1 1],'Title','Vehicle Spawn and Despawn');  
hPlt = axes(hViewPnl);
```

Plot the scenario and run the simulation. Observe how the non-ego vehicles spawn and despawn in the scenario while simulation is running.

```
plot(scenario,'Waypoints','on','Parent',hPlt)  
while advance(scenario)  
    pause(0.1)  
end
```

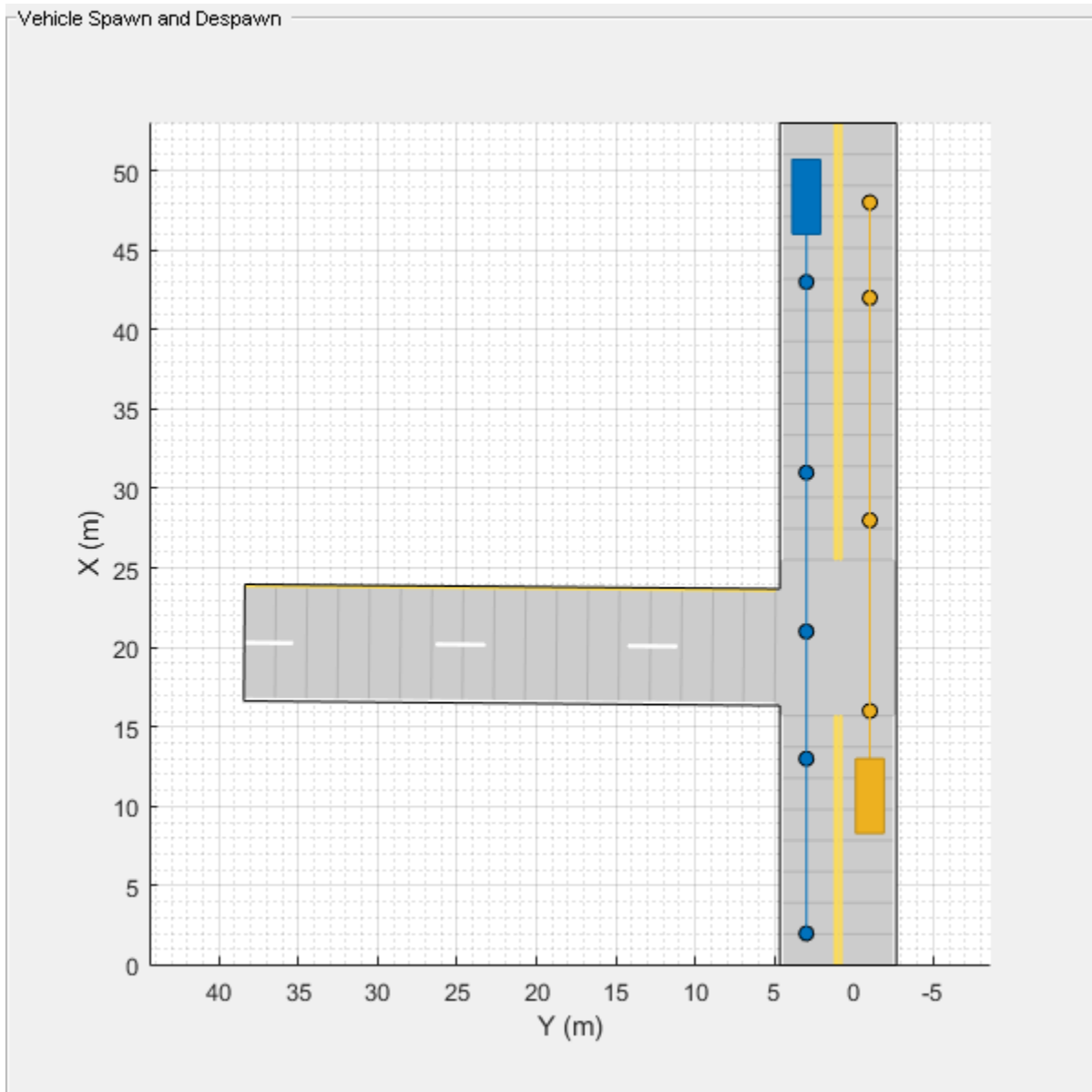
Input Arguments

scenario – Driving scenario

`drivingScenario` object

Driving scenario, specified as a `drivingScenario` object.

Name-Value Pair Arguments

Specify optional pairs of arguments as `Name1=Value1, ..., NameN=ValueN`, where `Name` is the argument name and `Value` is the corresponding value. Name-value arguments must appear after other arguments, but the order of the pairs does not matter.

Before R2021a, use commas to separate each name and value, and enclose Name in quotes.

Example: `vehicle('Length',2.2,'Width',0.6,'Height',1.5)` creates a vehicle that has the dimensions of a motorcycle. Units are in meters.

ClassID — Classification identifier

0 (default) | nonnegative integer

Classification identifier of actor, specified as the comma-separated pair consisting of 'ClassID' and a nonnegative integer.

Specify ClassID values to group together actors that have similar dimensions, radar cross-section (RCS) patterns, or other properties. As a best practice, before adding actors to a `drivingScenario` object, determine the actor classification scheme you want to use. Then, when creating the actors, specify the ClassID name-value pair to set classification identifiers according to the actor classification scheme.

Suppose you want to create a scenario containing these actors:

- Two cars, one of which is the ego vehicle
- A truck
- A bicycle
- A jersey barrier along a road

The code shows a sample classification scheme for this scenario, where 1 refers to cars, 2 refers to trucks, 3 refers to bicycles and 5 refers to jersey barriers. The cars have default vehicle properties. The truck and bicycle have the dimensions of a typical truck and bicycle, respectively.

```
scenario = drivingScenario;
ego = vehicle(scenario,'ClassID',1);
car = vehicle(scenario,'ClassID',1);
truck = vehicle(scenario,'ClassID',2,'Length',8.2,'Width',2.5,'Height',3.5);
bicycle = actor(scenario,'ClassID',3,'Length',1.7,'Width',0.45,'Height',1.7);
mainRoad = road(scenario,[0 0 0;10 0 0]);
barrier(scenario,mainRoad,'ClassID',5);
```

The default ClassID of 0 is reserved for an object of an unknown or unassigned class. If you plan to import `drivingScenario` objects into the **Driving Scenario Designer** app, do not leave the ClassID property of actors set to 0. The app does not recognize a ClassID of 0 for actors and returns an error. Instead, set ClassID values of actors according to the actor classification scheme used in the app.

ClassID	Class Name
1	Car
2	Truck
3	Bicycle
4	Pedestrian
5	Jersey Barrier
6	Guardrail

Name — Name of vehicle

"" (default) | character vector | string scalar

Name of the vehicle, specified as the comma-separated pair consisting of 'Name' and a character vector or string scalar.

Example: 'Name', 'Vehicle1'

Example: "Name", "Vehicle1"

Data Types: char | string

EntryTime — Entry time for vehicle to spawn

0 (default) | positive scalar

Entry time for a vehicle to spawn in the driving scenario, specified as the comma-separated pair consisting of 'EntryTime' and a positive scalar or a vector of positive values. Units are in seconds, measured from the start time of the scenario.

Specify this name-value pair argument to add or make a vehicle appear in the driving scenario at the specified time while the simulation is running.

- To spawn a vehicle only once, specify entry time as a scalar.
- To spawn a vehicle multiple times, specify entry time as a vector.
 - Arrange the elements of the vector in ascending order.
 - The length of the vector must match the length of the exit time vector.
- If the vehicle has an associated exit time, then each entry time value must be less than the corresponding exit time value.
- Each entry time value must be less than the stop time of the scenario. You can set the stop time for the scenario by specifying a value for the 'StopTime' property of the `drivingScenario` object.

Example: 'EntryTime', 2

Example: 'EntryTime', [2 4]

Data Types: single | double | int8 | int16 | int32 | int64 | uint8 | uint16 | uint32 | uint64

ExitTime — Exit time for vehicle to despawn

Inf (default) | positive scalar

Exit time for a vehicle to despawn from the driving scenario, specified as the comma-separated pair consisting of 'ExitTime' and a positive scalar or a vector of positive values. Units are in seconds, measured from the start time of the scenario.

Specify this name-value pair argument to remove or make a vehicle disappear from the scenario at a specified time while the simulation is running.

- To despawn a vehicle only once, specify exit time as a scalar.
- To despawn a vehicle multiple times, specify exit time as a vector.
 - Arrange the elements of the vector in ascending order.
 - The length of the vector must match the length of the entry time vector.
- If the vehicle has an associated entry time, then each exit time value must be greater than the corresponding entry time value.
- Each exit time value must be less than the stop time of the scenario. You can set the stop time for the scenario by specifying a value for the 'StopTime' property of the `drivingScenario` object.

Example: 'ExitTime',3

Example: 'ExitTime',[3 6]

Data Types: single | double | int8 | int16 | int32 | int64 | uint8 | uint16 | uint32 | uint64

PlotColor — Display color of vehicle

RGB triplet | hexadecimal color code | color name | short color name

Display color of vehicle, specified as the comma-separated pair consisting of 'PlotColor' and an RGB triplet, hexadecimal color code, color name, or short color name.







The vehicle appears in the specified color in all programmatic scenario visualizations, including the `plot` function, `chasePlot` function, and plotting functions of `birdsEyePlot` objects. If you import the scenario into the **Driving Scenario Designer** app, then the vehicle appears in this color in all app visualizations. If you import the scenario into Simulink, then the vehicle appears in this color in the **Bird's-Eye Scope**.

If you do not specify a color for the vehicle, the function assigns one based on the default color order of `Axes` objects. For more details, see the `ColorOrder` property for `Axes` objects.

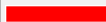
For a custom color, specify an RGB triplet or a hexadecimal color code.



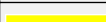

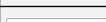

- An RGB triplet is a three-element row vector whose elements specify the intensities of the red, green, and blue components of the color. The intensities must be in the range $[0, 1]$, for example, $[0.4 \ 0.6 \ 0.7]$.
- A hexadecimal color code is a string scalar or character vector that starts with a hash symbol (#) followed by three or six hexadecimal digits, which can range from 0 to F. The values are not case sensitive. Therefore, the color codes "#FF8800", "#ff8800", "#F80", and "#f80" are equivalent.

Alternatively, you can specify some common colors by name. This table lists the named color options, the equivalent RGB triplets, and hexadecimal color codes.

Color Name	Short Name	RGB Triplet	Hexadecimal Color Code	Appearance
"red"	"r"	[1 0 0]	"#FF0000"	
"green"	"g"	[0 1 0]	"#00FF00"	
"blue"	"b"	[0 0 1]	"#0000FF"	
"cyan"	"c"	[0 1 1]	"#00FFFF"	
"magenta"	"m"	[1 0 1]	"#FF00FF"	
"yellow"	"y"	[1 1 0]	"#FFFF00"	
"black"	"k"	[0 0 0]	"#000000"	
"white"	"w"	[1 1 1]	"#FFFFFF"	

Here are the RGB triplets and hexadecimal color codes for the default colors MATLAB uses in many types of plots.

RGB Triplet	Hexadecimal Color Code	Appearance
[0 0.4470 0.7410]	"#0072BD"	

RGB Triplet	Hexadecimal Color Code	Appearance
[0.8500 0.3250 0.0980]	"#D95319"	
[0.9290 0.6940 0.1250]	"#EDB120"	
[0.4940 0.1840 0.5560]	"#7E2F8E"	
[0.4660 0.6740 0.1880]	"#77AC30"	
[0.3010 0.7450 0.9330]	"#4DBEEE"	
[0.6350 0.0780 0.1840]	"#A2142F"	

Position — Position of vehicle center

[0 0 0] (default) | [x y z] real-valued vector

Position of the rotational center of the vehicle, specified as the comma-separated pair consisting of 'Position' and an [x y z] real-valued vector.

The rotational center of a vehicle is the midpoint of its rear axle. The vehicle extends rearward by a distance equal to the rear overhang. The vehicle extends forward by a distance equal to the sum of the wheelbase and forward overhang. Units are in meters.

Example: [10;50;0]

Velocity — Velocity of vehicle center

[0 0 0] (default) | [v_x v_y v_z] real-valued vector

Velocity (*v*) of the vehicle center in the *x*-, *y*- and *z*-directions, specified as the comma-separated pair consisting of 'Velocity' and a [v_x v_y v_z] real-valued vector. The 'Position' name-value pair specifies the vehicle center. Units are in meters per second.

Example: [-4;7;10]

Yaw — Yaw angle of vehicle

0 (default) | real scalar

Yaw angle of the vehicle, specified as the comma-separated pair consisting of 'Yaw' and a real scalar. Yaw is the angle of rotation of the vehicle around the *z*-axis. Yaw is clockwise-positive when looking in the forward direction of the axis, which points up from the ground. Therefore, when viewing vehicles from the top down, such as on a bird's-eye plot, yaw is counterclockwise-positive. Angle values are wrapped to the range [-180, 180]. Units are in degrees.

Example: -0.4

Pitch — Pitch angle of vehicle

0 (default) | real scalar

Pitch angle of the vehicle, specified as the comma-separated pair consisting of 'Pitch' and a real scalar. Pitch is the angle of rotation of the vehicle around the *y*-axis and is clockwise-positive when looking in the forward direction of the axis. Angle values are wrapped to the range [-180, 180]. Units are in degrees.

Example: 5.8

Roll — Roll angle of vehicle

0 (default) | real scalar

Roll angle of the vehicle, specified as the comma-separated pair consisting of 'Roll' and a real scalar. Roll is the angle of rotation of the vehicle around the x-axis and is clockwise-positive when looking in the forward direction of the axis. Angle values are wrapped to the range [-180, 180]. Units are in degrees.

Example: -10

AngularVelocity – Angular velocity of vehicle

[0 0 0] (default) | [ω_x ω_y ω_z] real-valued vector

Angular velocity (ω) of the vehicle, in world coordinates, specified as the comma-separated pair consisting of 'AngularVelocity' and a [ω_x ω_y ω_z] real-valued vector. Units are in degrees per second.

Example: [20 40 20]

Length – Length of vehicle

4.7 (default) | positive real scalar

Length of the vehicle, specified as the comma-separated pair consisting of 'Length' and a positive real scalar. Units are in meters.

In `Vehicle` objects, this equation defines the values of the `Length`, `FrontOverhang`, `Wheelbase`, and `RearOverhang` properties:

$$\text{Length} = \text{FrontOverhang} + \text{Wheelbase} + \text{RearOverhang}$$

- If you update the `Length`, `RearOverhang`, or `Wheelbase` property, to maintain the equation, the `Vehicle` object increases or decreases the `FrontOverhang` property and keeps the other properties constant.
- If you update the `FrontOverhang` property, to maintain this equation, the `Vehicle` object increases or decreases the `Wheelbase` property and keeps the other properties constant.

When setting both the `FrontOverhang` and `RearOverhang` properties, to prevent the `Vehicle` object from overriding the `FrontOverhang` value, set `RearOverhang` first, followed by `FrontOverhang`. The object calculates the new `Wheelbase` property value automatically.

Example: 5.5

Width – Width of vehicle

1.8 (default) | positive real scalar

Width of the vehicle, specified as the comma-separated pair consisting of 'Width' and a positive real scalar. Units are in meters.

Example: 2.0

Height – Height of vehicle

1.4 (default) | positive real scalar

Height of the vehicle, specified as the comma-separated pair consisting of 'Height' and a positive real scalar. Units are in meters.

Example: 2.1

Mesh – Extended object mesh

`extendedObjectMesh` object

Extended object mesh, specified as an `extendedObjectMesh` object.

RCSPattern — Radar cross-section pattern of vehicle

`[10 10; 10 10]` (default) | Q -by- P real-valued matrix

Radar cross-section (RCS) pattern of the vehicle, specified as the comma-separated pair consisting of 'RCSPattern' and a Q -by- P real-valued matrix. RCS is a function of the azimuth and elevation angles, where:

- Q is the number of elevation angles specified by the 'RCSElevationAngles' name-value pair.
- P is the number of azimuth angles specified by the 'RCSAzimuthAngles' name-value pair.

Units are in decibels per square meter (dBsm).

Example: 5.8

RCSAzimuthAngles — Azimuth angles of vehicle's RCS pattern

`[-180 180]` (default) | P -element real-valued vector

Azimuth angles of the vehicle's RCS pattern, specified as the comma-separated pair consisting of 'RCSAzimuthAngles' and a P -element real-valued vector. P is the number of azimuth angles. Values are in the range $[-180^\circ, 180^\circ]$.

Each element of `RCSAzimuthAngles` defines the azimuth angle of the corresponding column of the 'RCSPattern' name-value pair. Units are in degrees.

Example: `[-90:90]`

RCSElevationAngles — Elevation angles of vehicle's RCS pattern

`[-90 90]` (default) | Q -element real-valued vector

Elevation angles of the vehicle's RCS pattern, specified as the comma-separated pair consisting of 'RCSElevationAngles' and a Q -element real-valued vector. Q is the number of elevation angles. Values are in the range $[-90^\circ, 90^\circ]$.

Each element of `RCSElevationAngles` defines the elevation angle of the corresponding row of the 'RCSPattern' name-value pair. Units are in degrees.

Example: `[0:90]`

FrontOverhang — Front overhang of vehicle

`0.9` (default) | real scalar

Front overhang of the vehicle, specified as the comma-separated pair consisting of 'FrontOverhang' and a real scalar. The front overhang is the distance that the vehicle extends beyond the front axle. If the vehicle does not extend past the front axle, then the front overhang is negative. Units are in meters.

In `Vehicle` objects, this equation defines the values of the `Length`, `FrontOverhang`, `Wheelbase`, and `RearOverhang` properties:

$$\text{Length} = \text{FrontOverhang} + \text{Wheelbase} + \text{RearOverhang}$$

- If you update the `Length`, `RearOverhang`, or `Wheelbase` property, to maintain the equation, the `Vehicle` object increases or decreases the `FrontOverhang` property and keeps the other properties constant.

- If you update the `FrontOverhang` property, to maintain this equation, the `Vehicle` object increases or decreases the `Wheelbase` property and keeps the other properties constant.

When setting both the `FrontOverhang` and `RearOverhang` properties, to prevent the `Vehicle` object from overriding the `FrontOverhang` value, set `RearOverhang` first, followed by `FrontOverhang`. The object calculates the new `Wheelbase` property value automatically.

Example: 0.37

RearOverhang — Rear overhang of vehicle

1.0 (default) | real scalar

Rear overhang of the vehicle, specified as the comma-separated pair consisting of '`RearOverhang`' and a real scalar. The rear overhang is the distance that the vehicle extends beyond the rear axle. If the vehicle does not extend past the rear axle, then the rear overhang is negative. Negative rear overhang is common in semitrailer trucks, where the cab of the truck does not overhang the rear wheel. Units are in meters.

In `Vehicle` objects, this equation defines the values of the `Length`, `FrontOverhang`, `Wheelbase`, and `RearOverhang` properties:

$\text{Length} = \text{FrontOverhang} + \text{Wheelbase} + \text{RearOverhang}$

- If you update the `Length`, `RearOverhang`, or `Wheelbase` property, to maintain the equation, the `Vehicle` object increases or decreases the `FrontOverhang` property and keeps the other properties constant.
- If you update the `FrontOverhang` property, to maintain this equation, the `Vehicle` object increases or decreases the `Wheelbase` property and keeps the other properties constant.

When setting both the `FrontOverhang` and `RearOverhang` properties, to prevent the `Vehicle` object from overriding the `FrontOverhang` value, set `RearOverhang` first, followed by `FrontOverhang`. The object calculates the new `Wheelbase` property value automatically.

Example: 0.32

Wheelbase — Distance between vehicle axles

2.8 (default) | positive real scalar

Distance between the front and rear axles of a vehicle, specified as the comma-separated pair consisting of '`Wheelbase`' and a positive real scalar. Units are in meters.

In `Vehicle` objects, this equation defines the values of the `Length`, `FrontOverhang`, `Wheelbase`, and `RearOverhang` properties:

$\text{Length} = \text{FrontOverhang} + \text{Wheelbase} + \text{RearOverhang}$

- If you update the `Length`, `RearOverhang`, or `Wheelbase` property, to maintain the equation, the `Vehicle` object increases or decreases the `FrontOverhang` property and keeps the other properties constant.
- If you update the `FrontOverhang` property, to maintain this equation, the `Vehicle` object increases or decreases the `Wheelbase` property and keeps the other properties constant.

When setting both the `FrontOverhang` and `RearOverhang` properties, to prevent the `Vehicle` object from overriding the `FrontOverhang` value, set `RearOverhang` first, followed by `FrontOverhang`. The object calculates the new `Wheelbase` property value automatically.

Example: 1.51

Output Arguments

vc — Driving scenario vehicle

Vehicle object

Driving scenario vehicle, returned as a `Vehicle` object belonging to the driving scenario specified in `scenario`.

You can modify the `Vehicle` object by changing its property values. The property names correspond to the name-value pair arguments used to create the object.

The only property that you cannot modify is `ActorID`, which is a positive integer indicating the unique, scenario-defined ID of the vehicle.

To specify and visualize vehicle motion, use these functions:

<code>trajectory</code>	Create actor or vehicle trajectory in driving scenario
<code>smoothTrajectory</code>	Create smooth, jerk-limited actor or vehicle trajectory in driving scenario
<code>chasePlot</code>	Ego-centric projective perspective plot

To get information about vehicle characteristics, use these functions:

<code>actorPoses</code>	Positions, velocities, and orientations of actors in driving scenario
<code>actorProfiles</code>	Physical and radar characteristics of actors in driving scenario
<code>targetOutlines</code>	Outlines of targets viewed by actor
<code>targetPoses</code>	Target positions and orientations relative to ego vehicle
<code>driving.scenario.targetsToEgo</code>	Convert target actor poses from world coordinates of scenario to ego vehicle coordinates
<code>driving.scenario.targetsToScenario</code>	Convert target actor poses from ego vehicle coordinates to world coordinates of scenario

To get information about the roads and lanes that the vehicle is on, use these functions:

<code>roadBoundaries</code>	Get road boundaries
<code>driving.scenario.roadBoundariesToEgo</code>	Convert road boundaries to ego vehicle coordinates
<code>currentLane</code>	Get current lane of actor
<code>laneBoundaries</code>	Get lane boundaries of actor lane
<code>laneMarkingVertices</code>	Lane marking vertices and faces in driving scenario

roadMesh	Mesh representation of an actor's nearest roads in driving scenario.
----------	--

More About

Actor and Vehicle Positions and Dimensions

In driving scenarios, an actor is a cuboid (box-shaped) object with a specific length, width, and height. Actors also have a radar cross-section (RCS) pattern, specified in dBsm, which you can refine by setting angular azimuth and elevation coordinates. The position of an actor is defined as the center of its bottom face. This center point is used as the actor's rotational center, its point of contact with the ground, and its origin in its local coordinate system. In this coordinate system:

- The X-axis points forward from the actor.
- The Y-axis points left from the actor.
- The Z-axis points up from the ground.

Roll, pitch, and yaw are clockwise-positive when looking in the forward direction of the X-, Y-, and Z-axes, respectively.

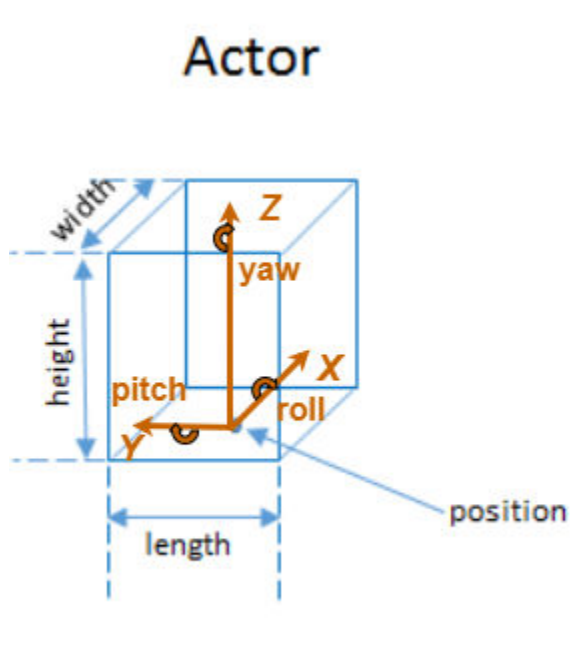

A vehicle is an actor that moves on wheels. Vehicles have three extra properties that govern the placement of their front and rear axle.

- Wheelbase — Distance between the front and rear axles
- Front overhang — Distance between the front of the vehicle and the front axle
- Rear overhang — Distance between the rear axle and the rear of the vehicle

Unlike other types of actors, the position of a vehicle is defined by the point on the ground that is below the center of its rear axle. This point corresponds to the natural center of rotation of the

vehicle. As with nonvehicle actors, this point is the origin in the local coordinate system of the vehicle, where:

- The X-axis points forward from the vehicle.
- The Y-axis points left from the vehicle.
- The Z-axis points up from the ground.

Roll, pitch, and yaw are clockwise-positive when looking in the forward direction of the X-, Y-, and Z-axes, respectively.

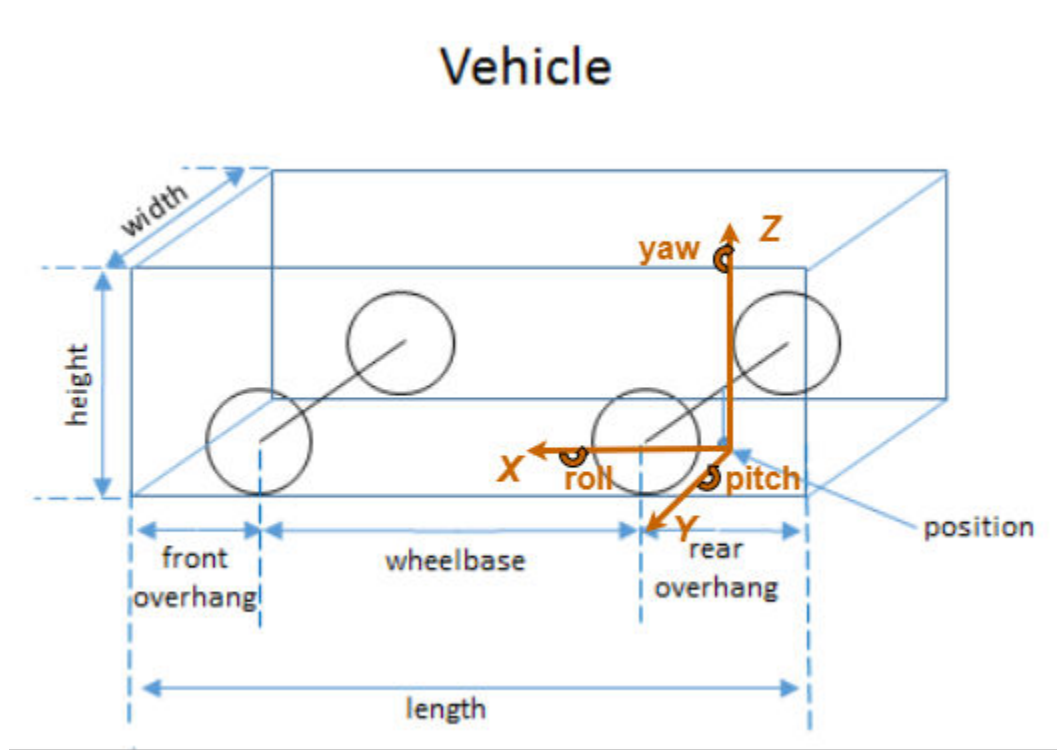

This table shows a list of common actors and their dimensions. To specify these values in Actor and Vehicle objects, set the corresponding properties shown.

Actor Classification	Actor Object	Actor Properties						
		Length	Width	Height	FrontOverhang	RearOverhang	Wheelbase	RCSPattern
Pedestrian	Actor	0.24 m	0.45 m	1.7 m	N/A	N/A	N/A	-8 dBsm
Car	Vehicle	4.7 m	1.8 m	1.4 m	0.9 m	1.0 m	2.8 m	10 dBsm
Motorcycle	Vehicle	2.2 m	0.6 m	1.5 m	0.37 m	0.32 m	1.51 m	0 dBsm

Version History

Introduced in R2017a

See Also

actor | drivingScenario

Topics

“Create Driving Scenario Programmatically”

“Create Actor and Vehicle Trajectories Programmatically”

state

Package:

Inertial ground-truth state of actor

Syntax

```
gTruth = state(ac)
```

Description

`gTruth = state(ac)` returns the inertial ground-truth state of an actor. Use this data as the input ground truth for an `insSensor` System object.

This function is supported only for actors that have trajectories created by using the `smoothTrajectory` function.

Examples

Generate INS Measurements from Driving Scenario

Generate measurements from an INS sensor that is mounted to a vehicle in a driving scenario. Plot the INS measurements against the ground truth state of the vehicle and visualize the velocity and acceleration profile of the vehicle.

Create Driving Scenario

Load the geographic data for a driving route at the MathWorks® Apple Hill campus in Natick, MA.

```
data = load('ahroute.mat');
latIn = data.latitude;
lonIn = data.longitude;
```

Convert the latitude and longitude coordinates of the route to Cartesian coordinates. Set the origin to the first coordinate in the driving route. For simplicity, assume an altitude of 0 for the route.

```
alt = 0;
origin = [latIn(1), lonIn(1), alt];
[xEast, yNorth, zUp] = latlon2local(latIn, lonIn, alt, origin);
```

Create a driving scenario. Set the origin of the converted route as the geographic reference point.

```
scenario = drivingScenario('GeoReference', origin);
```

Create a road based on the Cartesian coordinates of the route.

```
roadCenters = [xEast, yNorth, zUp];
road(scenario, roadCenters);
```

Create a vehicle that follows the center line of the road. The vehicle travels between 4 and 5 meters per second (9 to 11 miles per hour), slowing down at the curves in the road. To create the trajectory,

use the `smoothTrajectory` function. The computed trajectory minimizes jerk and avoids discontinuities in acceleration, which is a requirement for modeling INS sensors.

```
egoVehicle = vehicle(scenario, 'ClassID', 1);  
egoPath = roadCenters;  
egoSpeed = [5 5 5 4 4 4 5 4 4 4 4 5 5 5 5];  
smoothTrajectory(egoVehicle, egoPath, egoSpeed);
```

Plot the scenario and show a 3-D view from behind the ego vehicle.

```
plot(scenario)  
chasePlot(egoVehicle)
```

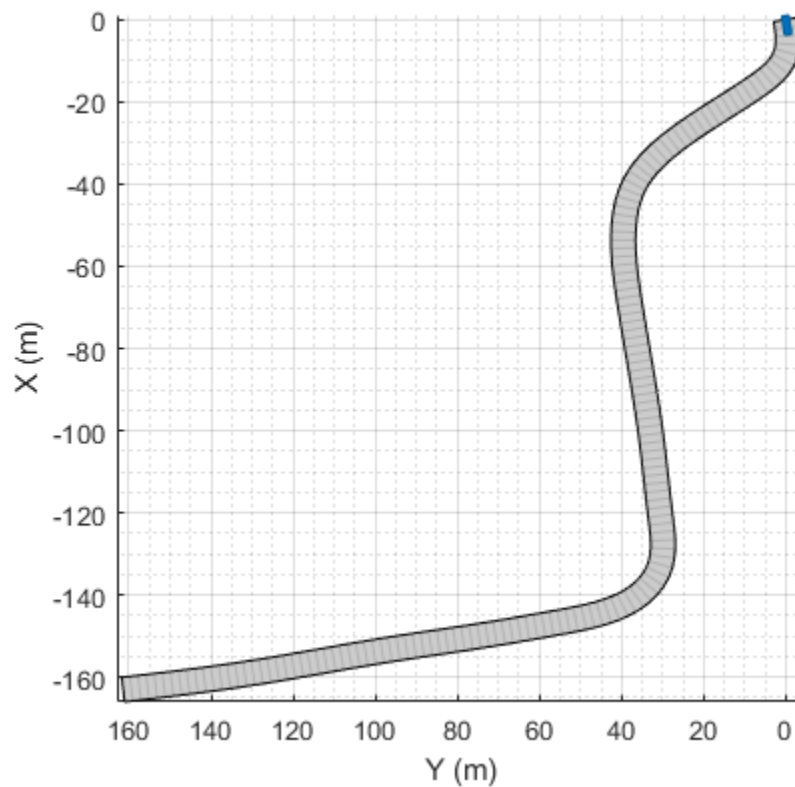

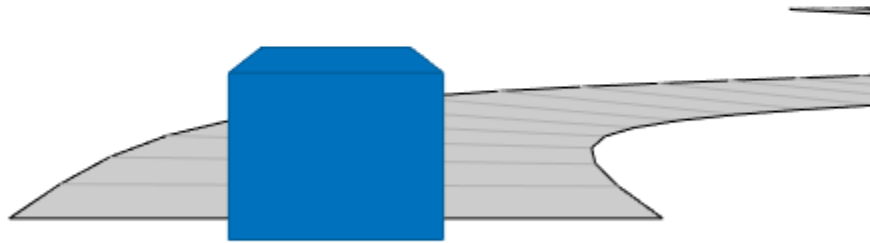

Create INS Sensor

Create an INS sensor that accepts the input of simulation times. Introduce noise into the sensor measurements by setting the standard deviation of velocity and accuracy measurements to 0.1 and 0.05, respectively.

```
INS = insSensor('TimeInput',true, ...  
               'VelocityAccuracy',0.1, ...  
               'AccelerationAccuracy',0.05);
```

Visualize INS Measurements

Initialize a geographic player for displaying the INS measurements and the actor ground truth. Configure the player to display its last 10 positions and set the zoom level to 17.

```
zoomLevel = 17;  
player = geoplayer(latIn(1),lonIn(1),zoomLevel, ...  
                  'HistoryDepth',10,'HistoryStyle','line');
```

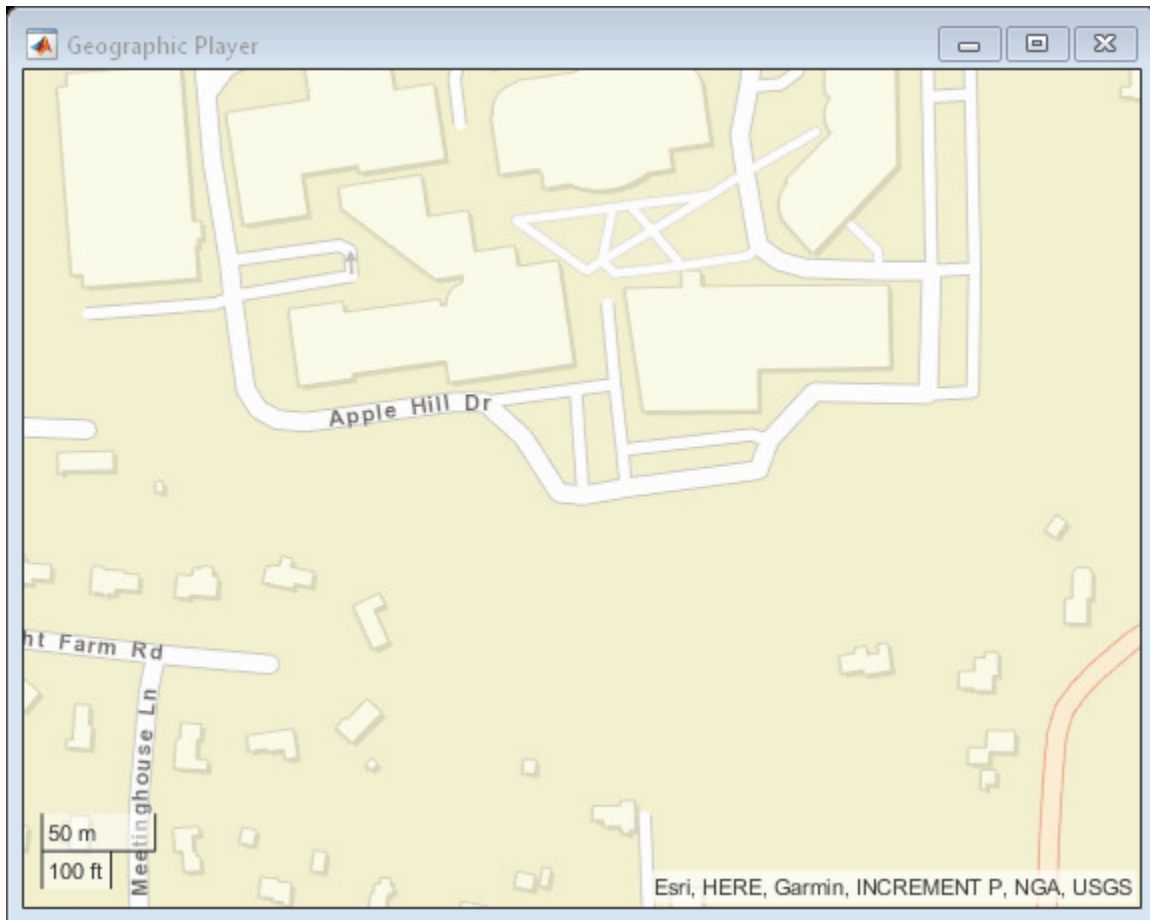

Pre-allocate space for the simulation times, velocity measurements, and acceleration measurements that are captured during simulation.

```
numWaypoints = length(latIn);
times = zeros(numWaypoints,1);
gTruthVelocities = zeros(numWaypoints,1);
gTruthAccelerations = zeros(numWaypoints,1);
sensorVelocities = zeros(numWaypoints,1);
sensorAccelerations = zeros(numWaypoints,1);
```

Simulate the scenario. During the simulation loop, obtain the ground truth state of the ego vehicle and an INS measurement of that state. Convert these readings to geographic coordinates, and at each waypoint, visualize the ground truth and INS readings on the geographic player. Also capture the velocity and acceleration data for plotting the velocity and acceleration profiles.

```
nextWaypoint = 2;
while advance(scenario)

    % Obtain ground truth state of ego vehicle.
    gTruth = state(egoVehicle);

    % Obtain INS sensor measurement.
    measurement = INS(gTruth,scenario.SimulationTime);

    % Convert readings to geographic coordinates.
```



```

[latOut,lonOut] = local2latlon(measurement.Position(1), ...
                              measurement.Position(2), ...
                              measurement.Position(3),origin);

% Plot differences between ground truth locations and locations reported by sensor.
reachedWaypoint = sum(abs(roadCenters(nextWaypoint,:) - gTruth.Position)) < 1;
if reachedWaypoint
    plotPosition(player,latIn(nextWaypoint),lonIn(nextWaypoint),'TrackID',1)
    plotPosition(player,latOut,lonOut,'TrackID',2,'Label','INS')

    % Capture simulation times, velocities, and accelerations.
    times(nextWaypoint,1) = scenario.SimulationTime;
    gTruthVelocities(nextWaypoint,1) = gTruth.Velocity(2);
    gTruthAccelerations(nextWaypoint,1) = gTruth.Acceleration(2);
    sensorVelocities(nextWaypoint,1) = measurement.Velocity(2);
    sensorAccelerations(nextWaypoint,1) = measurement.Acceleration(2);

    nextWaypoint = nextWaypoint + 1;
end

if nextWaypoint > numWaypoints
    break
end
end

```

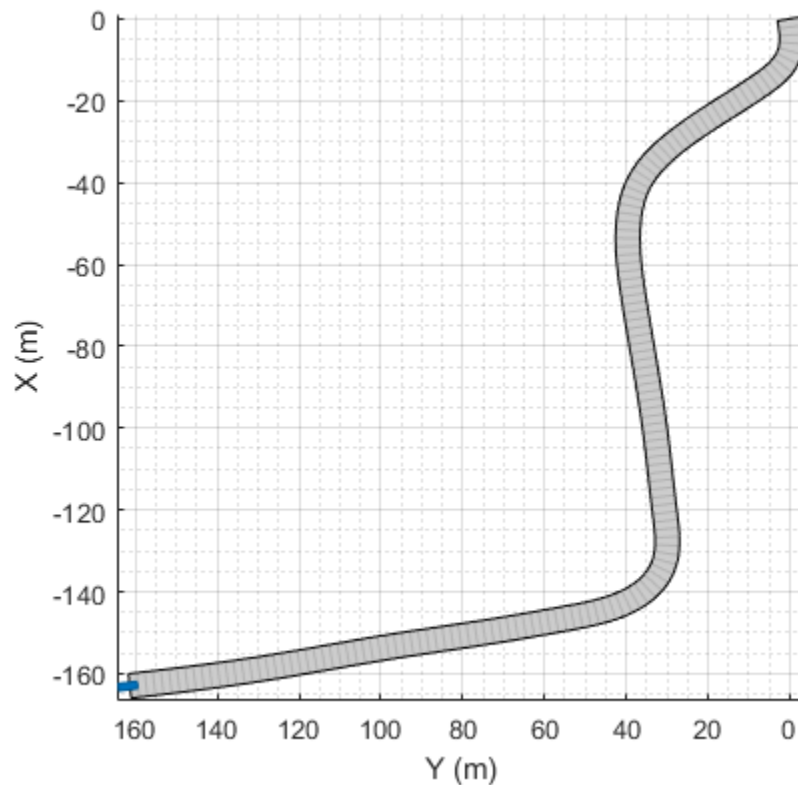

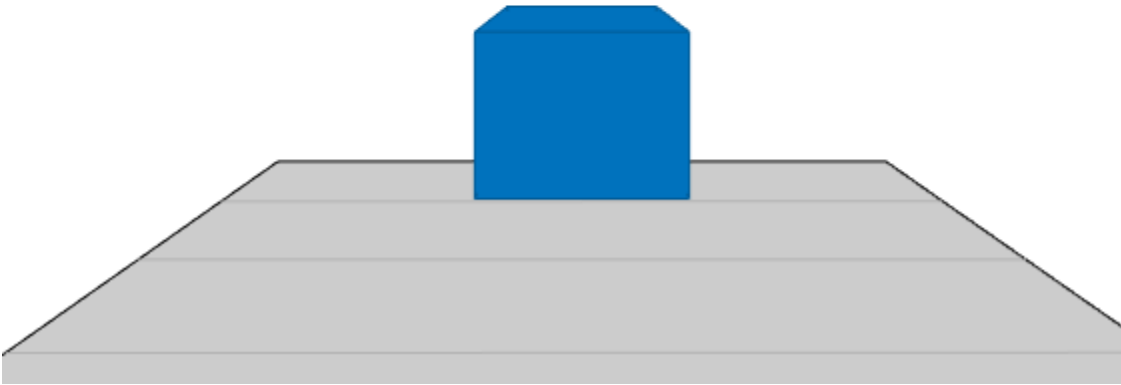

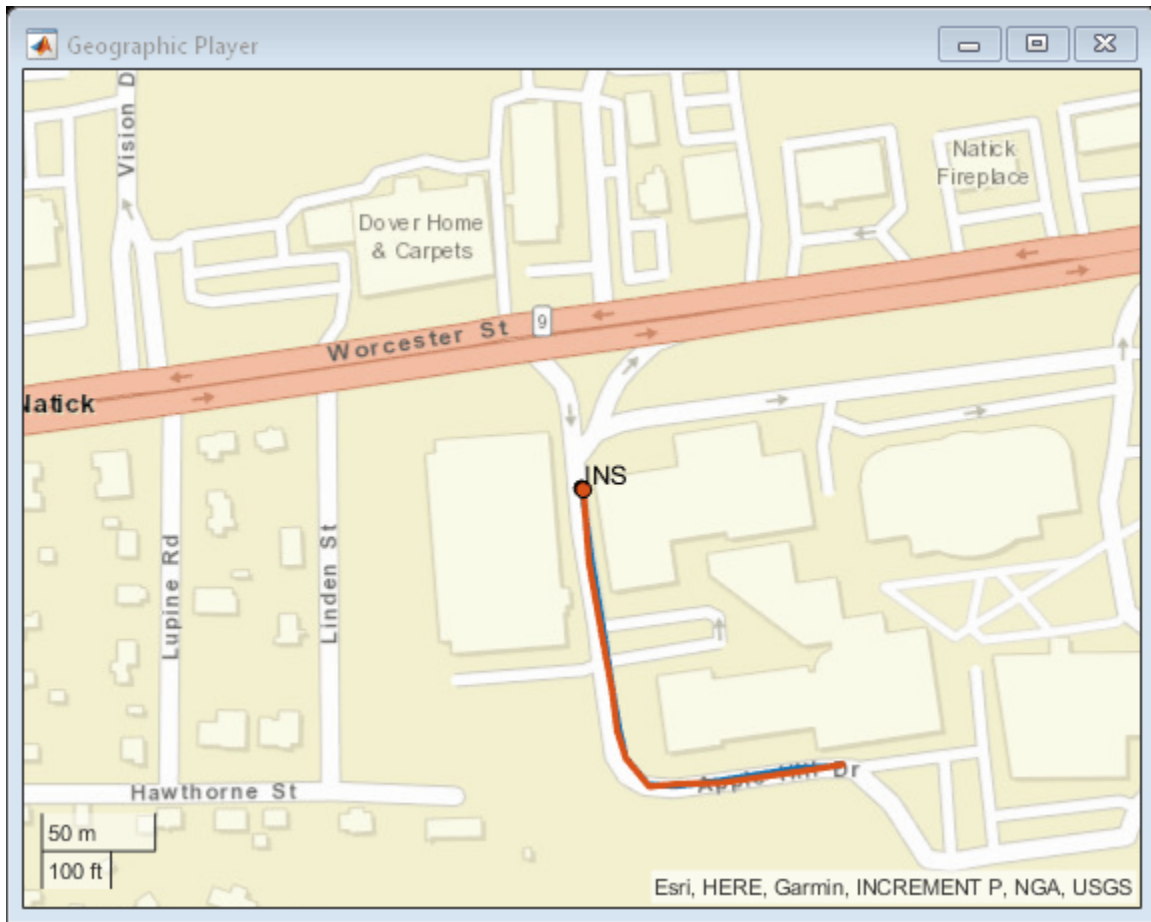

Plot Velocity Profile

Compare the ground truth longitudinal velocity of the vehicle over time against the velocity measurements captured by the INS sensor.

Remove zeros from the time vector and velocity vectors.

```
times(times == 0) = [];
gTruthVelocities(gTruthVelocities == 0) = [];
sensorVelocities(sensorVelocities == 0) = [];
```

```
figure
hold on
plot(times,gTruthVelocities)
plot(times,sensorVelocities)
title('Longitudinal Velocity Profile')
xlabel('Time (s)')
ylabel('Velocity (m/s)')
legend('Ground truth','INS')
hold off
```

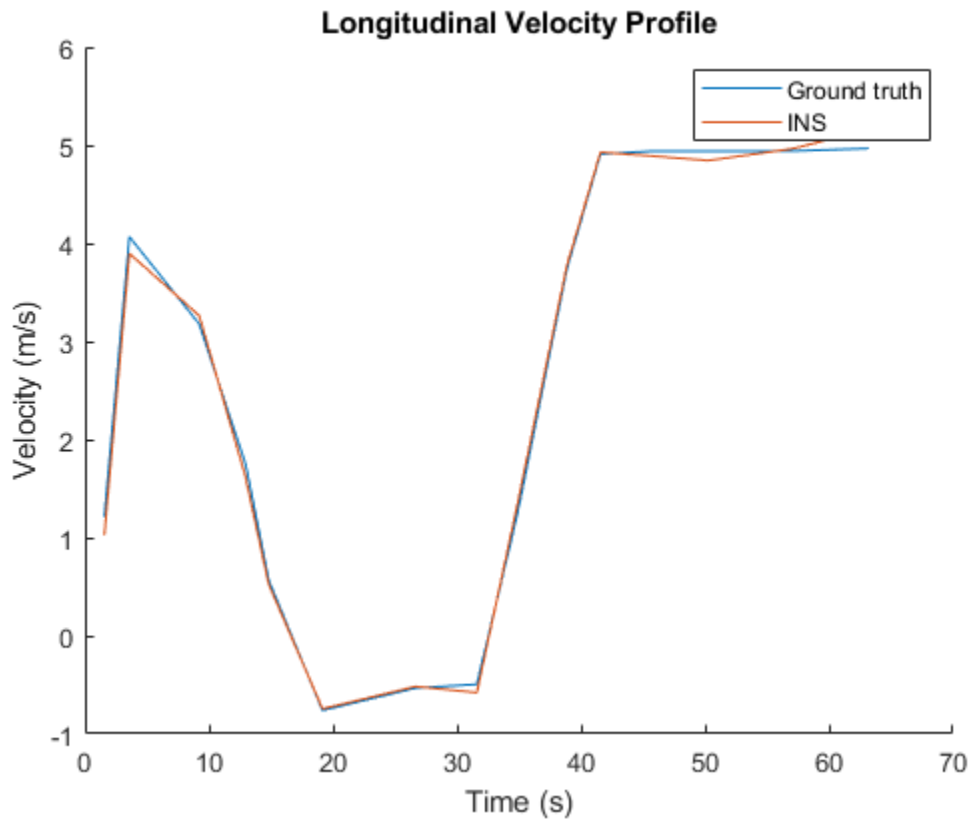

Plot Acceleration Profile

Compare the ground truth longitudinal acceleration of the vehicle over time against the acceleration measurements captured by the INS sensor.

```
gTruthAccelerations(gTruthAccelerations == 0) = [];  
sensorAccelerations(sensorAccelerations == 0) = [];
```

```
figure  
hold on  
plot(times,gTruthAccelerations)  
plot(times,sensorAccelerations)  
title('Longitudinal Acceleration Profile')  
xlabel('Time (s)')  
ylabel('Acceleration (m/s^2)')  
legend('Ground truth','INS')  
hold off
```

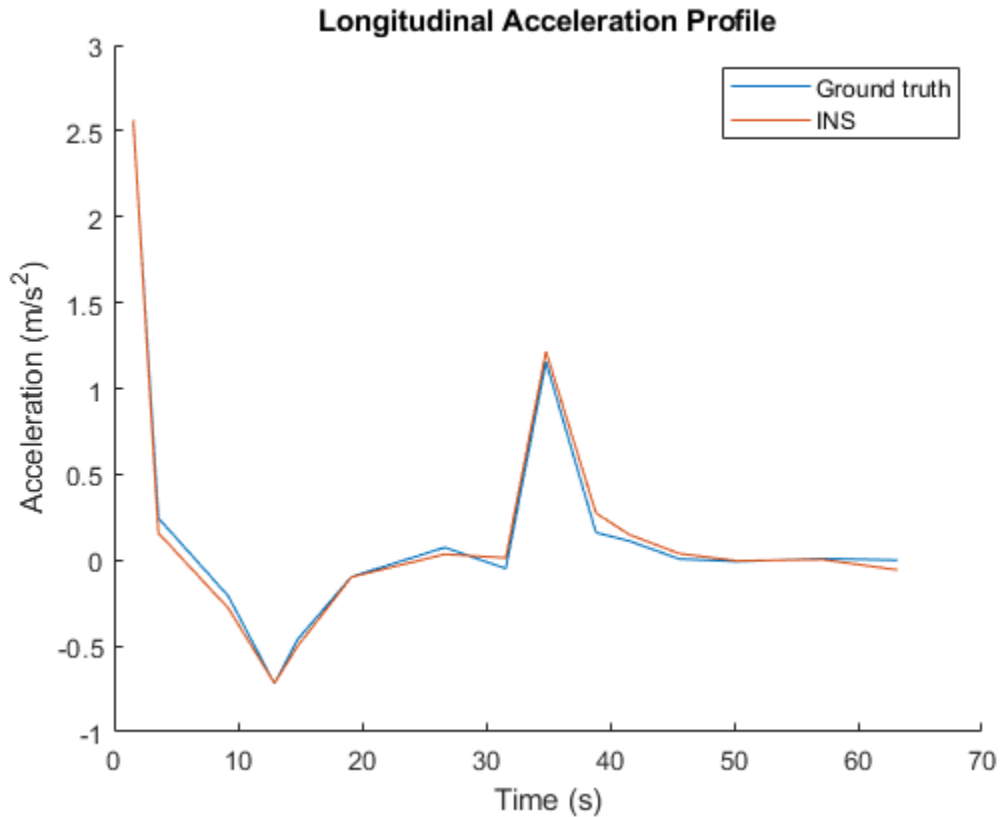

Input Arguments

ac – Actor

Actor object | Vehicle object

Actor belonging to a `drivingScenario` object, specified as an `Actor` or `Vehicle` object. To create these objects, use the `actor` and `vehicle` functions, respectively.

Output Arguments

gTruth – Inertial ground-truth state

structure

Inertial ground-truth state of the actor, in local Cartesian coordinates, returned as a structure containing these fields:

Field	Description
'Position'	Position, in meters, specified as a real, finite N -by-3 matrix of $[x \ y \ z]$ vectors. N is the number of samples in the current frame.
'Velocity'	Velocity (v), in meters per second, specified as a real, finite N -by-3 matrix of $[v_x \ v_y \ v_z]$ vector. N is the number of samples in the current frame.

Field	Description
'Orientation'	<p>Orientation with respect to the local Cartesian coordinate system, specified as one of these options:</p> <ul style="list-style-type: none"> • N-element column vector of quaternion objects • 3-by-3-by-N array of rotation matrices • N-by-3 matrix of $[x_{\text{roll}} y_{\text{pitch}} z_{\text{yaw}}]$ angles in degrees <p>Each quaternion or rotation matrix is a frame rotation from the local Cartesian coordinate system to the current sensor body coordinate system. N is the number of samples in the current frame.</p>
'Acceleration'	<p>Acceleration (a), in meters per second squared, specified as a real, finite N-by-3 matrix of $[a_x a_y a_z]$ vectors. N is the number of samples in the current frame.</p>
'AngularVelocity'	<p>Angular velocity (ω), in degrees per second squared, specified as a real, finite N-by-3 matrix of $[\omega_x \omega_y \omega_z]$ vectors. N is the number of samples in the current frame.</p>

The returned field values are of type double.

Version History

Introduced in R2021a

See Also

insSensor | drivingScenario | actor | vehicle | smoothTrajectory

actorPoses

Positions, velocities, and orientations of actors in driving scenario

Syntax

```
poses = actorPoses(scenario)
```

Description

`poses = actorPoses(scenario)` returns the current poses (positions, velocities, and orientations) for all actors in the driving scenario, `scenario`. Actors include `Actor` objects, `Vehicle` objects, and `Barrier` segments, which you can create using the `actor`, `vehicle` and `barrier` functions, respectively. Actor poses are in scenario coordinates.

Examples

Create Driving Scenario with Multiple Actors and Roads

Create a driving scenario containing a curved road, two straight roads, and two actors: a car and a bicycle. Both actors move along the road for 60 seconds.

Create the driving scenario object.

```
scenario = drivingScenario('SampleTime',0.1,'StopTime',60);
```

Create the curved road using road center points following the arc of a circle with an 800-meter radius. The arc starts at 0°, ends at 90°, and is sampled at 5° increments.

```
angs = [0:5:90]';
R = 800;
roadcenters = R*[cosd(angs) sind(angs) zeros(size(angs))];
roadwidth = 10;
cr = road(scenario,roadcenters,roadwidth);
```

Add two straight roads with the default width, using road center points at each end. To the first straight road add barriers on both road edges.

```
roadcenters = [700 0 0; 100 0 0];
sr1 = road(scenario,roadcenters);
barrier(scenario,sr1)
barrier(scenario,sr1,'RoadEdge','left')
roadcenters = [400 400 0; 0 0 0];
road(scenario,roadcenters);
```

Get the road boundaries.

```
rbdry = roadBoundaries(scenario);
```

Add a car and a bicycle to the scenario. Position the car at the beginning of the first straight road.

```
car = vehicle(scenario,'ClassID',1,'Position',[700 0 0], ...
    'Length',3,'Width',2,'Height',1.6);
```

Position the bicycle farther down the road.

```
bicycle = actor(scenario,'ClassID',3,'Position',[706 376 0]', ...
    'Length',2,'Width',0.45,'Height',1.5);
```

Plot the scenario.

```
plot(scenario,'Centerline','on','RoadCenters','on');
title('Scenario');
```

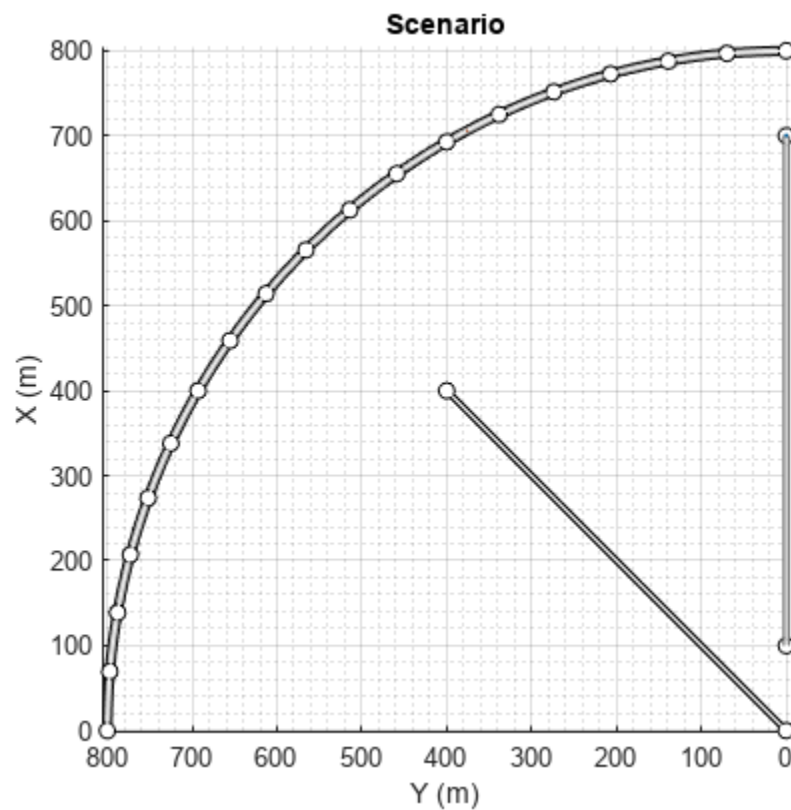

Display the actor poses and profiles.

```
allActorPoses = actorPoses(scenario)
```

```
allActorPoses=242x1 struct array with fields:
```

```
ActorID
Position
Velocity
Roll
Pitch
Yaw
AngularVelocity
```

```
allActorProfiles = actorProfiles(scenario)
```

`allActorProfiles=242x1 struct array with fields:`

```

ActorID
ClassID
Length
Width
Height
OriginOffset
MeshVertices
MeshFaces
RCSPattern
RCSAzimuthAngles
RCSElevationAngles

```

Because there are barriers in this scenario, and each barrier segment is considered an actor, `actorPoses` and `actorProfiles` functions return the poses of all stationary and non-stationary actors. To only obtain the poses and profiles of non-stationary actors such as vehicles and bicycles, first obtain their corresponding actor IDs using the `scenario.actors.ActorID` property.

```
movableActorIDs = [scenario.actors.ActorID];
```

Then, use those IDs to filter only non-stationary actor poses and profiles.

```
movableActorPoseIndices = ismember([allActorPoses.ActorID],movableActorIDs);
```

```
movableActorPoses = allActorPoses(movableActorPoseIndices)
```

`movableActorPoses=2x1 struct array with fields:`

```

ActorID
Position
Velocity
Roll
Pitch
Yaw
AngularVelocity

```

```
movableActorProfiles = allActorProfiles(movableActorPoseIndices)
```

`movableActorProfiles=2x1 struct array with fields:`

```

ActorID
ClassID
Length
Width
Height
OriginOffset
MeshVertices
MeshFaces
RCSPattern
RCSAzimuthAngles
RCSElevationAngles

```

Input Arguments

scenario — Driving scenario

`drivingScenario` object

Driving scenario, specified as a `drivingScenario` object.

Output Arguments

poses — Actor poses

structures | array of structures

Actor poses, in scenario coordinates, returned as a structure or an array of structures. Poses are the positions, velocities, and orientations of actors.

Each structure in `poses` has these fields.

Field	Description
ActorID	Scenario-defined actor identifier, specified as a positive integer.
Position	Position of actor, specified as a real-valued vector of the form $[x \ y \ z]$. Units are in meters.
Velocity	Velocity (v) of actor in the x - y -, and z -directions, specified as a real-valued vector of the form $[v_x \ v_y \ v_z]$. Units are in meters per second.
Roll	Roll angle of actor, specified as a real-valued scalar. Units are in degrees.
Pitch	Pitch angle of actor, specified as a real-valued scalar. Units are in degrees.
Yaw	Yaw angle of actor, specified as a real-valued scalar. Units are in degrees.
AngularVelocity	Angular velocity (ω) of actor in the x -, y -, and z -directions, specified as a real-valued vector of the form $[\omega_x \ \omega_y \ \omega_z]$. Units are in degrees per second.

For full definitions of these structure fields, see the `actor`, `vehicle` and `barrier` functions.

Version History

Introduced in R2017a

See Also

Objects

`drivingScenario` | `drivingRadarDataGenerator` | `visionDetectionGenerator` | `lidarPointCloudGenerator`

Functions

`actorProfiles` | `targetPoses` | `targetOutlines` | `actor` | `vehicle` | `barrier`

Topics

“Create Driving Scenario Programmatically”

actorProfiles

Physical and radar characteristics of actors in driving scenario

Syntax

```
profiles = actorProfiles(scenario)
```

Description

`profiles = actorProfiles(scenario)` returns the physical and radar characteristics, `profiles`, for all actors in a driving scenario, `scenario`. Actors include `Actor` objects, `Vehicle` objects and `Barrier` segments, which you can create using the `actor`, `vehicle` and `barrier` functions, respectively.

You can use actor profiles as inputs to radar, vision, and lidar sensors, such as `drivingRadarDataGenerator`, `visionDetectionGenerator`, `lidarPointCloudGenerator` and `ultrasonicDetectionGenerator` objects.

Examples

Create Driving Scenario with Multiple Actors and Roads

Create a driving scenario containing a curved road, two straight roads, and two actors: a car and a bicycle. Both actors move along the road for 60 seconds.

Create the driving scenario object.

```
scenario = drivingScenario('SampleTime',0.1,'StopTime',60);
```

Create the curved road using road center points following the arc of a circle with an 800-meter radius. The arc starts at 0°, ends at 90°, and is sampled at 5° increments.

```
angs = [0:5:90]';
R = 800;
roadcenters = R*[cosd(angs) sind(angs) zeros(size(angs))];
roadwidth = 10;
cr = road(scenario,roadcenters,roadwidth);
```

Add two straight roads with the default width, using road center points at each end. To the first straight road add barriers on both road edges.

```
roadcenters = [700 0 0; 100 0 0];
sr1 = road(scenario,roadcenters);
barrier(scenario,sr1)
barrier(scenario,sr1,'RoadEdge','left')
roadcenters = [400 400 0; 0 0 0];
road(scenario,roadcenters);
```

Get the road boundaries.

```
rbdry = roadBoundaries(scenario);
```

Add a car and a bicycle to the scenario. Position the car at the beginning of the first straight road.

```
car = vehicle(scenario,'ClassID',1,'Position',[700 0 0], ...
    'Length',3,'Width',2,'Height',1.6);
```

Position the bicycle farther down the road.

```
bicycle = actor(scenario,'ClassID',3,'Position',[706 376 0]', ...
    'Length',2,'Width',0.45,'Height',1.5);
```

Plot the scenario.

```
plot(scenario,'Centerline','on','RoadCenters','on');
title('Scenario');
```

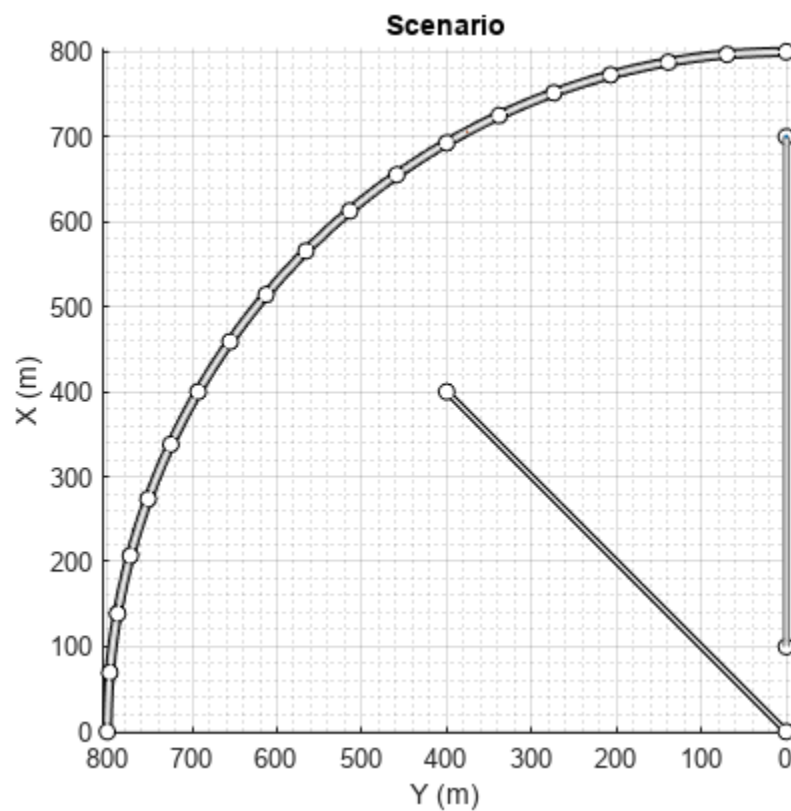

Display the actor poses and profiles.

```
allActorPoses = actorPoses(scenario)
```

```
allActorPoses=242x1 struct array with fields:
```

```
ActorID
Position
Velocity
Roll
Pitch
Yaw
AngularVelocity
```

```
allActorProfiles = actorProfiles(scenario)
```

```
allActorProfiles=242×1 struct array with fields:
```

```
ActorID  
ClassID  
Length  
Width  
Height  
OriginOffset  
MeshVertices  
MeshFaces  
RCSPattern  
RCSAzimuthAngles  
RCSElevationAngles
```

Because there are barriers in this scenario, and each barrier segment is considered an actor, `actorPoses` and `actorProfiles` functions return the poses of all stationary and non-stationary actors. To only obtain the poses and profiles of non-stationary actors such as vehicles and bicycles, first obtain their corresponding actor IDs using the `scenario.actors.ActorID` property.

```
movableActorIDs = [scenario.actors.ActorID];
```

Then, use those IDs to filter only non-stationary actor poses and profiles.

```
movableActorPoseIndices = ismember([allActorPoses.ActorID],movableActorIDs);
```

```
movableActorPoses = allActorPoses(movableActorPoseIndices)
```

```
movableActorPoses=2×1 struct array with fields:
```

```
ActorID  
Position  
Velocity  
Roll  
Pitch  
Yaw  
AngularVelocity
```

```
movableActorProfiles = allActorProfiles(movableActorPoseIndices)
```

```
movableActorProfiles=2×1 struct array with fields:
```

```
ActorID  
ClassID  
Length  
Width  
Height  
OriginOffset  
MeshVertices  
MeshFaces  
RCSPattern  
RCSAzimuthAngles  
RCSElevationAngles
```

Input Arguments

scenario — Driving scenario

drivingScenario object

Driving scenario, specified as a drivingScenario object.

Output Arguments

profiles — Actor profiles

structure | array of structures

Actor profiles, returned as a structure or as an array of structures. Each structure contains the physical and radar characteristics of an actor.

The actor profile structures have these fields.

Field	Description
ActorID	Scenario-defined actor identifier, specified as a positive integer.
ClassID	Classification identifier, specified as a nonnegative integer. 0 represents an object of an unknown or unassigned class.
Length	Length of actor, specified as a positive real-valued scalar. Units are in meters.
Width	Width of actor, specified as a positive real-valued scalar. Units are in meters.
Height	Height of actor, specified as a positive real-valued scalar. Units are in meters.
OriginOffset	Offset of actor's rotational center from its geometric center, specified as a real-valued vector of the form $[x, y, z]$. The rotational center, or origin, is located at the bottom center of the actor. For vehicles, the rotational center is the point on the ground beneath the center of the rear axle. Units are in meters.
MeshVertices	Mesh vertices of actor, specified as an n -by-3 real-valued matrix of vertices. Each row in the matrix defines a point in 3-D space.
MeshFaces	Mesh faces of actor, specified as an m -by-3 matrix of integers. Each row of MeshFaces represents a triangle defined by the vertex IDs, which are the row numbers of vertices.
RCSPattern	Radar cross-section (RCS) pattern of actor, specified as a $\text{numel}(\text{RCSElevationAngles})$ -by- $\text{numel}(\text{RCSAzimuthAngles})$ real-valued matrix. Units are in decibels per square meter.

Field	Description
RCSAzimuthAngles	Azimuth angles corresponding to rows of RCSPattern, specified as a vector of values in the range [-180, 180]. Units are in degrees.
RCSElevationAngles	Elevation angles corresponding to rows of RCSPattern, specified as a vector of values in the range [-90, 90]. Units are in degrees.

For full definitions of these structure fields, see the `actor`, `vehicle` and `barrier` functions.

Version History

Introduced in R2017a

See Also

Objects

`drivingScenario` | `visionDetectionGenerator` | `drivingRadarDataGenerator` | `lidarPointCloudGenerator` | `ultrasonicDetectionGenerator`

Functions

`actorPoses` | `actor` | `vehicle` | `barrier` | `targetPoses` | `targetOutlines`

barrier

Package:

Add a barrier to a driving scenario

Syntax

```
barrier(scenario, rd)
barrier(scenario, rd, 'RoadEdge', 'left')
barrier(scenario, barrierCenters)
barrier(scenario, barrierCenters, bankAngle)
barrier( ____, Name, Value)
```

Description

`barrier(scenario, rd)` adds a barrier along the entire length of the road object `rd`. By default, the barrier is placed along the right edge and each segment lies on the surface of road.

`barrier(scenario, rd, 'RoadEdge', 'left')` adds a barrier along the left edge of the road object `rd`.

`barrier(scenario, barrierCenters)` adds a barrier along a piecewise, clothoid curve that smoothly connects the specified barrier centers. This approach is useful when adding barriers to edges of roads that intersect or overlap.

`barrier(scenario, barrierCenters, bankAngle)` specifies the angle by which the barrier tilts when traversing the barrier centers.

`barrier(____, Name, Value)` sets barrier properties using one or more name-value pair arguments, in addition to any combination of input arguments from previous syntaxes.

Barriers are composed of individual elements called barrier segments. Use name-value pair arguments such as 'SegmentLength', 'SegmentGap', 'Width' and 'Height' to tune the properties of individual barrier segments. Jersey barriers and guardrails are the two types of barriers that you can add to a scenario. Specify the appropriate 'Mesh' and 'ClassID' arguments to represent the barrier as a guardrail or a jersey barrier.

Examples

Add Barriers Along Road Edges in Driving Scenario

Create a driving scenario and add a curved road.

```
scenario = drivingScenario;
roadCenters = [-14.1 -4.3; 9 -10; 37 -8; 60 3.9; 81.2 29.4; 83.4 57.9];
road1 = road(scenario, roadCenters);
```

Add a barrier along the right edge of the road.

```
barrier(scenario, road1)
```

Add another barrier along the left edge of the road with a lateral offset of 1 m from the edge. Specify a gap of 1 m between individual barrier segments.

```
barrier(scenario, road1, 'RoadEdge', "left", 'SegmentGap', 1, 'RoadEdgeOffset', 1)
```

Plot the scenario.

```
plot(scenario)
```

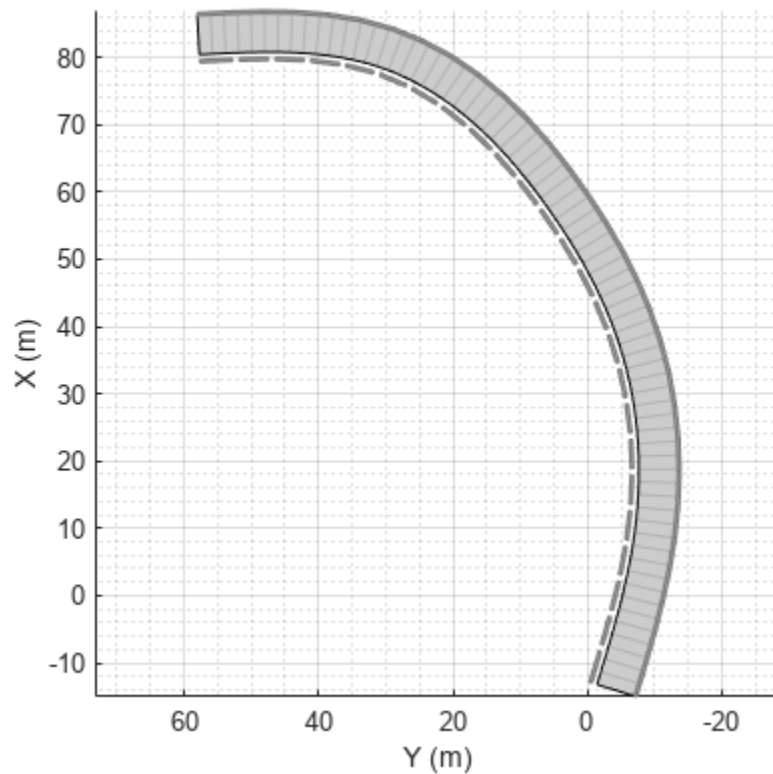

Add Barriers to Driving Scenario at Specific Points

Create a driving scenario and add a straight road.

```
scenario2 = drivingScenario;
roadCenters = [0 0; 20 0];
rr = road(scenario2, roadCenters);
```

Specify appropriate barrier centers and add a barrier on the road, covering the entire width of the road.

```
barrierCenters = [20 3; 20 0; 20 -3];
barrier(scenario2, barrierCenters, 'SegmentGap', 0.2)
```

Add two barriers on the road, each covering half the width of the road.

```

barrierCenters1 = [12 3; 12 0];
barrierCenters2 = [6 -3; 6 0];
barrier(scenario2,barrierCenters1,'SegmentGap',0.2)
barrier(scenario2,barrierCenters2,'SegmentGap',0.2)

```

Plot the scenario.

```
plot(scenario2)
```

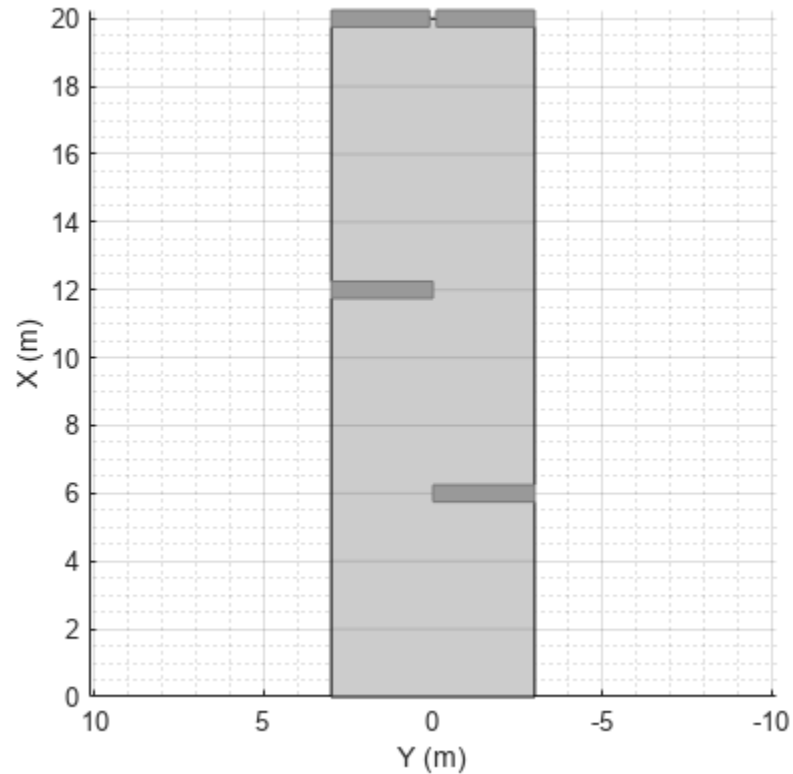

Input Arguments

scenario – Driving scenario

drivingScenario object

Driving scenario, specified as a drivingScenario object.

rd – Road to add a barrier along

road object

Road to add a barrier along, specified as a road object.

barrierCenters – Barrier center coordinates

real-valued N -by-3 matrix | real-valued N -by-2 matrix

Barrier center coordinates, specified as an N -by-3 or N -by-2 matrix.

- If `barrierCenters` is an N -by-3 matrix, then each matrix row represents the (x, y, z) coordinates of a barrier center.
- If `barrierCenters` is an N -by-2 matrix, then each matrix row represents the (x, y) coordinates of a barrier center. The z -coordinate of each barrier center is zero.

The function connects the coordinates along a smooth, piecewise, clothoid curve, and adds a barrier with the curve as its center line. Units are in meters.

bankAngle — Banking angle of barrier

0 (default) | scalar | real-valued N -by-1 vector

Banking angle of barrier, specified as a real-valued N -by-1 vector. N is the number of barrier centers. The *bankAngle* is the roll angle of the barrier along the direction of the curve formed by the barrier centers. Units are in degrees.

Name-Value Pair Arguments

Specify optional pairs of arguments as `Name1=Value1, ..., NameN=ValueN`, where `Name` is the argument name and `Value` is the corresponding value. Name-value arguments must appear after other arguments, but the order of the pairs does not matter.

Before R2021a, use commas to separate each name and value, and enclose Name in quotes.

Example: `'RoadEdge', 'left'` adds a barrier along the left edge of the road.

RoadEdge — Edge of road along which to place a barrier

'right' (default) | 'left'

Edge of the road along which to place a barrier, specified as the comma-separated pair consisting of 'RoadEdge' and 'right' or 'left'. Use 'RoadEdge' only when you specify a road object to add a barrier along.

RoadEdgeOffset — Lateral offset from road edge

scalar | real-valued N -by-1 vector

Lateral offset from road edge, specified as the comma-separated pair consisting of 'RoadEdgeOffset' and a scalar or real-valued N -by-1 vector. N is the number of barrier centers. A positive offset value moves the barrier away from the road and a negative offset value moves the barrier into the road. Units are in meters. 'RoadEdgeOffset' is valid only when you specify a road object and 'RoadEdge' argument.

SegmentLength — Length of each barrier segment

5 (default) | positive real scalar

Length of each barrier segment, specified as the comma-separated pair consisting of 'SegmentLength' and a positive real scalar. Units are in meters.

SegmentGap — Distance between consecutive barrier segments

0 (default) | positive real scalar

Distance between consecutive barrier segments, specified as the comma-separated pair consisting of 'SegmentGap' and a positive real scalar. Units are in meters.

Width — Width of each barrier segment

0.5 (default) | positive real scalar

Width of each barrier segment, specified as the comma-separated pair consisting of 'Width' and a positive real scalar. Units are in meters.

Height — Height of each barrier segment

0.75 (default) | positive real scalar

Height of each barrier segment, specified as the comma-separated pair consisting of 'Height' and a positive real scalar. Units are in meters.

Mesh — Mesh representation of barrier

extendedObjectMesh object

Mesh representation of the barrier, specified as the comma-separated pair consisting of 'Mesh' and a valid extendedObjectMesh object. The available meshes for barrier are `driving.scenario.jerseyBarrierMesh`, representing a Jersey barrier and `driving.scenario.guardrailMesh`, representing a guardrail. The `lidarPointCloudGenerator` system object uses this mesh to generate detections.

PlotColor — Display color of barrier

[0.6 0.6 0.6] (default) | RGB triplet | hexadecimal color code | color name | short color name





Display color of barrier, specified as the comma-separated pair consisting of 'PlotColor' and an RGB triplet, hexadecimal color code, color name, or short color name.

The barrier appears in the specified color in all programmatic scenario visualizations, including the `plot` function, `chasePlot` function, and plotting functions of `birdsEyePlot` objects. If you import the scenario into the **Driving Scenario Designer** app, then the barrier appears in this color in all app visualizations. If you import the scenario into Simulink, then the barrier appears in this color in the **Bird's-Eye Scope**.

For a custom color, specify an RGB triplet or a hexadecimal color code.

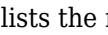

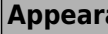
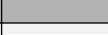

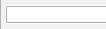

- An RGB triplet is a three-element row vector whose elements specify the intensities of the red, green, and blue components of the color. The intensities must be in the range [0, 1], for example, [0.4 0.6 0.7].
- A hexadecimal color code is a string scalar or character vector that starts with a hash symbol (#) followed by three or six hexadecimal digits, which can range from 0 to F. The values are not case sensitive. Therefore, the color codes "#FF8800", "#ff8800", "#F80", and "#f80" are equivalent.

Alternatively, you can specify some common colors by name. This table lists the named color options, the equivalent RGB triplets, and hexadecimal color codes.

Color Name	Short Name	RGB Triplet	Hexadecimal Color Code	Appearance
"red"	"r"	[1 0 0]	"#FF0000"	
"green"	"g"	[0 1 0]	"#00FF00"	
"blue"	"b"	[0 0 1]	"#0000FF"	
"cyan"	"c"	[0 1 1]	"#00FFFF"	
"magenta"	"m"	[1 0 1]	"#FF00FF"	
"yellow"	"y"	[1 1 0]	"#FFFF00"	

Color Name	Short Name	RGB Triplet	Hexadecimal Color Code	Appearance
"black"	"k"	[0 0 0]	"#000000"	
"white"	"w"	[1 1 1]	"#FFFFFF"	

Here are the RGB triplets and hexadecimal color codes for the default colors MATLAB uses in many types of plots.

RGB Triplet	Hexadecimal Color Code	Appearance
[0 0.4470 0.7410]	"#0072BD"	
[0.8500 0.3250 0.0980]	"#D95319"	
[0.9290 0.6940 0.1250]	"#EDB120"	
[0.4940 0.1840 0.5560]	"#7E2F8E"	
[0.4660 0.6740 0.1880]	"#77AC30"	
[0.3010 0.7450 0.9330]	"#4DBEEE"	
[0.6350 0.0780 0.1840]	"#A2142F"	

RCSPattern — Radar cross-section pattern of barrier

[10 10; 10 10] (default) | Q -by- P real-valued matrix

Radar cross-section (RCS) pattern of the barrier, specified as the comma-separated pair consisting of 'RCSPattern' and a Q -by- P real-valued matrix. The RCS is a function of the azimuth and elevation angles, where:

- Q is the number of elevation angles specified by the 'RCSElevationAngles' name-value pair argument.
- P is the number of azimuth angles specified by the 'RCSAzimuthAngles' name-value pair argument.

Units are in decibels per square meter (dBsm).

Example: 5.8

RCSAzimuthAngles — Azimuth angles of RCS pattern of barrier

[-180 180] (default) | P -element real-valued vector

Azimuth angles of RCS pattern of barrier, specified as the comma-separated pair consisting of 'RCSAzimuthAngles' and a P -element real-valued vector. P is the number of azimuth angles. Values are in the range $[-180^\circ, 180^\circ]$.

Each element of 'RCSAzimuthAngles' defines the azimuth angle of the corresponding column of the 'RCSPattern' name-value pair argument. Units are in degrees.

Example: [-90:90]

RCSElevationAngles — Elevation angles of RCS pattern of barrier

[-90 90] (default) | Q -element real-valued vector

Elevation angles of RCS pattern of barrier, specified as the comma-separated pair consisting of 'RCSElevationAngles' and a Q -element real-valued vector. Q is the number of elevation angles. Values are in the range $[-90^\circ, 90^\circ]$.

Each element of 'RCSElevationAngles' defines the elevation angle of the corresponding row of the 'RCSPattern' name-value pair argument. Units are in degrees.

Example: [0:90]

ClassID — Classification identifier

0 (default) | 5 | 6

Classification identifier of the barrier, specified as the comma-separated pair consisting of 'ClassID' and a nonnegative integer value of 5 or 6. The values 5 and 6 correspond to Jersey barriers and guardrails, respectively. Specify the appropriate Class ID for each barrier before importing the scenario into the **Driving Scenario Designer** app. For more information about the Class ID values for different actors, refer to the description of the 'ClassID' name-value pair argument.

Limitations

- Road networks added using the `roadNetwork` function do not support barriers.

Tips

- For faster simulations, specify the input argument range for the `targetPoses` function in the scenario advance loop.

Version History

Introduced in R2021a

See Also

`actor` | `vehicle` | `lanespec` | `roadGroup`

Topics

"Sensor Fusion Using Synthetic Radar and Vision Data"

chasePlot

Package:

Ego-centric projective perspective plot

Syntax

```
chasePlot(ac)
chasePlot(ac,Name,Value)
```

Description

`chasePlot(ac)` plots a driving scenario from the perspective of actor `ac`. This plot is called a chase plot and has an ego-centric projective perspective, where the view is positioned immediately behind the actor.

`chasePlot(ac,Name,Value)` specifies options using one or more name-value pairs. For example, you can display road centers and actor waypoints on the plot.

Examples

Simulate Car Traveling on S-Curve

Simulate a driving scenario with one car traveling on an S-curve. Create and plot the lane boundaries.

Create the driving scenario with one road having an S-curve.

```
scenario = drivingScenario('StopTime',3);
roadcenters = [-35 20 0; -20 -20 0; 0 0 0; 20 20 0; 35 -20 0];
```

Create the lanes and add them to the road.

```
lm = [laneMarking('Solid','Color','w'); ...
      laneMarking('Dashed','Color','y'); ...
      laneMarking('Dashed','Color','y'); ...
      laneMarking('Solid','Color','w')];
ls = lanespec(3,'Marking',lm);
road(scenario,roadcenters,'Lanes',ls);
```

Add an ego vehicle and specify its trajectory from its waypoints. By default, the car travels at a speed of 30 meters per second.

```
car = vehicle(scenario, ...
             'ClassID',1, ...
             'Position',[-35 20 0]);
waypoints = [-35 20 0; -20 -20 0; 0 0 0; 20 20 0; 35 -20 0];
smoothTrajectory(car,waypoints);
```

Plot the scenario and corresponding chase plot.

```
plot(scenario)
```

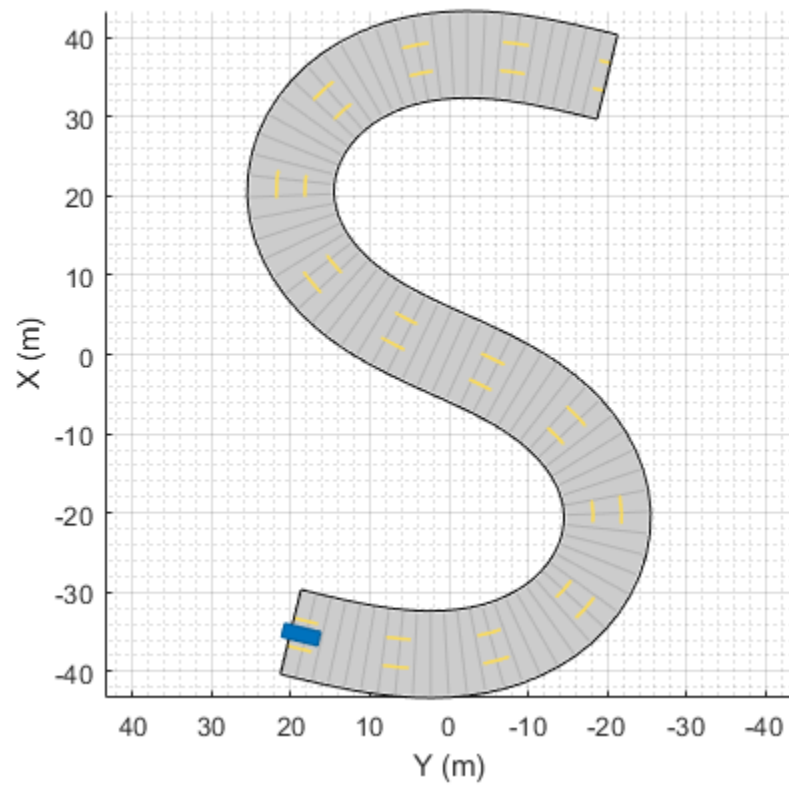

```
chasePlot(car)
```



Run the simulation loop.

- 1 Initialize a bird's-eye plot and create an outline plotter, left-lane and right-lane boundary plotters, and a road boundary plotter.
- 2 Obtain the road boundaries and rectangular outlines.
- 3 Obtain the lane boundaries to the left and right of the vehicle.
- 4 Advance the simulation and update the plotters.

```

bep = birdsEyePlot('XLim',[-40 40], 'YLim',[-30 30]);
olPlotter = outlinePlotter(bep);
lblPlotter = laneBoundaryPlotter(bep, 'Color', 'r', 'LineStyle', '-');
lbrPlotter = laneBoundaryPlotter(bep, 'Color', 'g', 'LineStyle', '-');
rbsEdgePlotter = laneBoundaryPlotter(bep);
legend('off');
while advance(scenario)
    rbs = roadBoundaries(car);
    [position, yaw, length, width, originOffset, color] = targetOutlines(car);
    lb = laneBoundaries(car, 'XDistance', 0:5:30, 'LocationType', 'Center', ...
        'AllBoundaries', false);
    plotLaneBoundary(rbsEdgePlotter, rbs)
    plotLaneBoundary(lblPlotter, {lb(1).Coordinates})
    plotLaneBoundary(lbrPlotter, {lb(2).Coordinates})
    plotOutline(olPlotter, position, yaw, length, width, ...
        'OriginOffset', originOffset, 'Color', color)
end

```

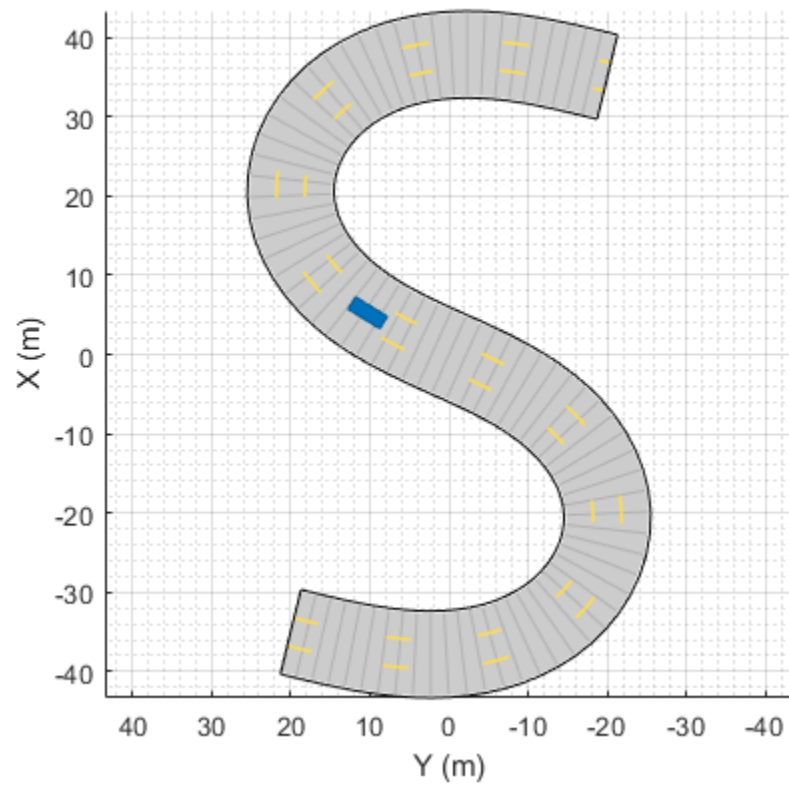

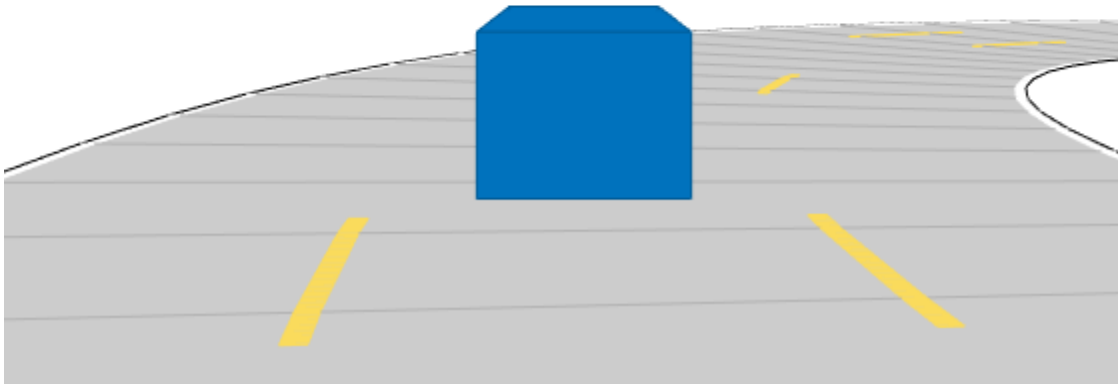

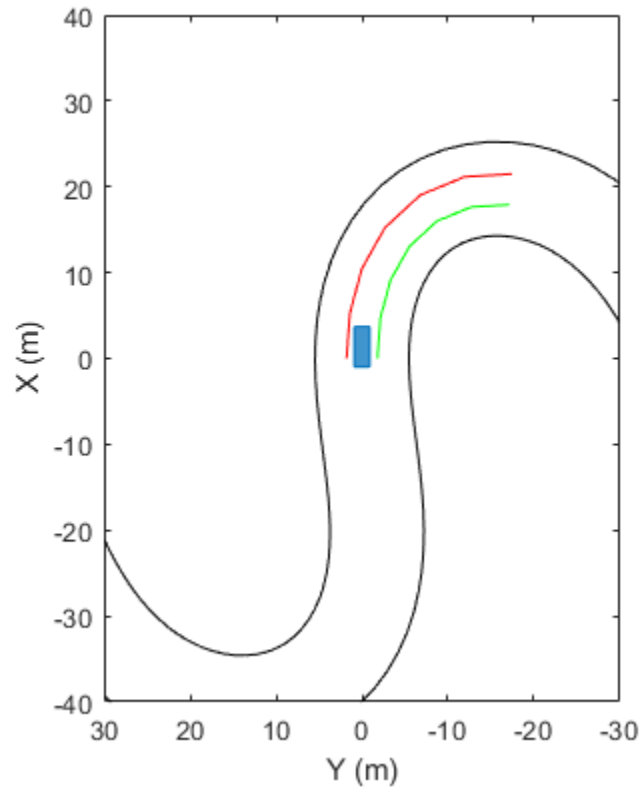

Show Target Outlines in Driving Scenario Simulation

Create a driving scenario and show how target outlines change as the simulation advances.

Create a driving scenario consisting of two intersecting straight roads. The first road segment is 45 meters long. The second straight road is 32 meters long with jersey barriers along both its edges, and intersects the first road. A car traveling at 12.0 meters per second along the first road approaches a running pedestrian crossing the intersection at 2.0 meters per second.

```
scenario = drivingScenario('SampleTime',0.1,'StopTime',1);
road1 = road(scenario,[-10 0 0; 45 -20 0]);
road2 = road(scenario,[-10 -10 0; 35 10 0]);
barrier(scenario,road1)
barrier(scenario,road1,'RoadEdge','left')
ped = actor(scenario,'ClassID',4,'Length',0.4,'Width',0.6,'Height',1.7);
car = vehicle(scenario,'ClassID',1);
pedspeed = 2.0;
carspeed = 12.0;
smoothTrajectory(ped,[15 -3 0; 15 3 0],pedspeed);
smoothTrajectory(car,[-10 -10 0; 35 10 0],carspeed);
```

Create an ego-centric chase plot for the vehicle.

```
chasePlot(car,'Centerline','on')
```

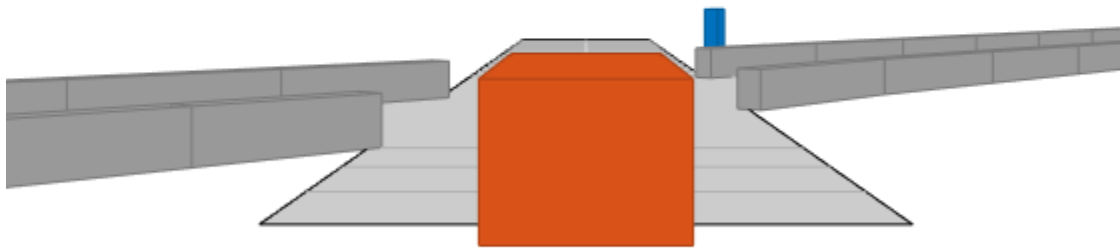

Create an empty bird's-eye plot and add an outline plotter and lane boundary plotter. Then, run the simulation. At each simulation step:

- Update the chase plot to display the road boundaries and target outlines.
- Update the bird's-eye plot to display the updated road boundaries and target outlines. The plot perspective is always with respect to the ego vehicle.

```
bepPlot = birdsEyePlot('XLim',[-50 50],'YLim',[-40 40]);
outlineplotter = outlinePlotter(bepPlot);
laneplotter = laneBoundaryPlotter(bepPlot);
legend('off')

while advance(scenario)
    rb = roadBoundaries(car);
    [position,yaw,length,width,originOffset,color] = targetOutlines(car);
    [bposition,byaw,blength,bwidth,boriginOffset,bcolor,barrierSegments] = targetOutlines(car,'B');
    plotLaneBoundary(laneplotter,rb)
    plotOutline(outlineplotter,position,yaw,length,width, ...
        'OriginOffset',originOffset,'Color',color)
    plotBarrierOutline(outlineplotter,barrierSegments,bposition,byaw,blength,bwidth, ...
        'OriginOffset',boriginOffset,'Color',bcolor)
    pause(0.01)
end
```

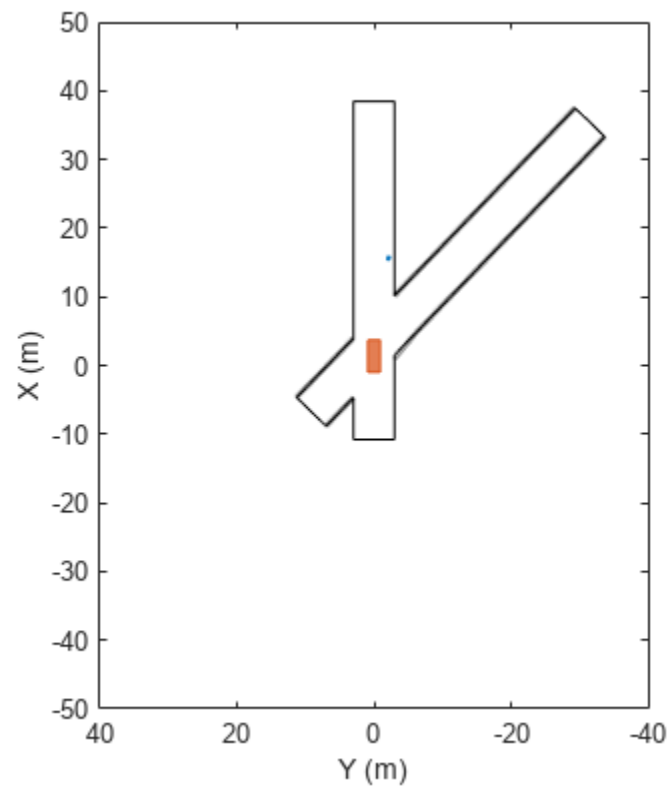

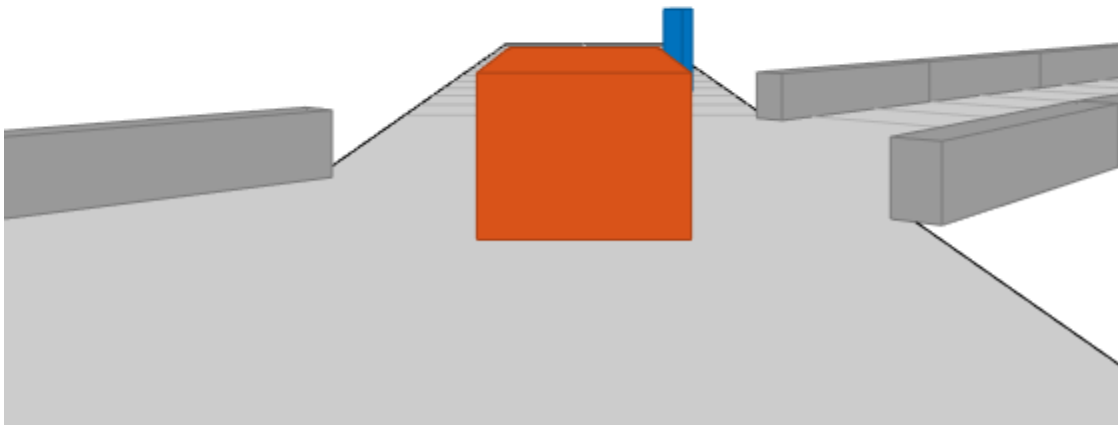

Input Arguments

ac — Actor

Actor object | Vehicle object

Actor belonging to a `drivingScenario` object, specified as an `Actor` or `Vehicle` object. To create these objects, use the `actor` and `vehicle` functions, respectively.

Name-Value Pair Arguments

Specify optional pairs of arguments as `Name1=Value1, ..., NameN=ValueN`, where `Name` is the argument name and `Value` is the corresponding value. Name-value arguments must appear after other arguments, but the order of the pairs does not matter.

Before R2021a, use commas to separate each name and value, and enclose Name in quotes.

Example: `chasePlot(ac, 'Centerline', 'on', 'RoadCenters', 'on')` displays the center line and road centers of each road segment.

Parent — Axes in which to draw plot

Axes object

Axes in which to draw the plot, specified as the comma-separated pair consisting of 'Parent' and an Axes object. If you do not specify Parent, a new figure is created.

CenterLine — Display center line of roads

'off' (default) | 'on'

Display the center line of roads, specified as the comma-separated pair consisting of 'CenterLine' and 'off' or 'on'. The center line follows the middle of each road segment. Center lines are discontinuous through areas such as intersections or road splits.

RoadCenters — Display road centers

'off' (default) | 'on'

Display road centers, specified as the comma-separated pair consisting of 'RoadCenters' and 'off' or 'on'. The road centers define the roads shown in the plot.

Waypoints — Display actor waypoints

'off' (default) | 'on'

Display actor waypoints, specified as the comma-separated pair consisting of 'Waypoints' and 'off' or 'on'. Waypoints define the trajectory of the actor.

Meshes — Display actor meshes

'off' (default) | 'on'

Display actor meshes instead of cuboids, specified as the comma-separated pair consisting of 'Meshes' and 'off' or 'on'.

ViewHeight — Height of plot viewpoint

1.5 × actor height (default) | positive real scalar

Height of the plot viewpoint, specified as the comma-separated pair consisting of 'ViewHeight' and a positive real scalar. The height is with respect to the bottom of the actor. Units are in meters.

ViewLocation — Location of plot viewpoint

2.5 × actor length (default) | [x, y] real-valued vector

Location of the plot viewpoint, specified as the comma-separated pair consisting of 'ViewLocation' and an [x, y] real-valued vector. The location is with respect to the cuboid center in the coordinate system of the actor. The default location of the viewpoint is behind the cuboid center, [2.5*actor.Length 0]. Units are in meters.

ViewRoll — Roll angle orientation of plot viewpoint

0 (default) | real scalar

Roll angle orientation of the plot viewpoint, specified as the comma-separated pair consisting of 'ViewRoll' and a real scalar. Units are in degrees.

ViewPitch — Pitch angle orientation of plot viewpoint

0 (default) | real scalar

Pitch angle orientation of the plot viewpoint, specified as the comma-separated pair consisting of 'ViewPitch' and a real scalar. Units are in degrees.

ViewYaw — Yaw angle orientation of plot viewpoint

0 (default) | real scalar

Yaw angle orientation of the plot viewpoint, specified as the comma-separated pair consisting of 'ViewYaw' and a real scalar. Units are in degrees.

Version History

Introduced in R2017a

See Also

Objects

drivingScenario

Functions

plot | actor | vehicle | smoothTrajectory | road

Topics

“Create Driving Scenario Programmatically”

smoothTrajectory

Package:

Create smooth, jerk-limited actor trajectory in driving scenario

Syntax

```
smoothTrajectory(ac,waypoints)
smoothTrajectory(ac,waypoints,speed)
smoothTrajectory(ac,waypoints,speed,waittime)
smoothTrajectory( ___,Name,Value)
```

Description

The `smoothTrajectory` function creates a smooth, jerk-limited trajectory for an actor in a driving scenario. The generated trajectory features a smooth transition of accelerations between waypoints, making it compatible for generating synthetic inertial navigation system (INS) and global navigation satellite system (GNSS) measurements from an `insSensorSystem` object. For more details on how `smoothTrajectory` generates trajectories, see “Algorithms” on page 4-472.

`smoothTrajectory(ac,waypoints)` creates a smooth trajectory for an actor or vehicle, `ac`, to follow from a set of waypoints. The actor travels at a constant speed of 30 meters per second.

`smoothTrajectory(ac,waypoints,speed)` also specifies the speed at which the actor or vehicle travels along the trajectory, in either forward or reverse motion.

`smoothTrajectory(ac,waypoints,speed,waittime)` also specifies wait times for an actor or vehicle. Use this syntax to pause the actor or vehicle at specific waypoints.

`smoothTrajectory(___,Name,Value)` specifies options using one or more name-value pairs and any of the input argument combinations from previous syntaxes. For example, you can specify the yaw orientation angle of the actor or vehicle at each waypoint or the maximum amount of jerk in the trajectory.

Examples

Create Trajectory with Varying Speeds

Create a driving scenario containing a curved two-lane road.

```
scenario = drivingScenario('SampleTime',0.05);
roadcenters = [0 0; 24.2 27.7; 50 30];
lspec = lanespec(2);
road(scenario,roadcenters,'Lanes',lspec);
```

Add a vehicle to the scenario. Set a trajectory in which the vehicle slows down as it enters the curve.

```
v = vehicle(scenario,'ClassID',1);
waypoints = [2.6 1.0; 23.6 24.9; 45.5 28.6];
```

```
speed = [9 8 9];
smoothTrajectory(v,waypoints,speed)
```

Plot the scenario and run the simulation.

```
plot(scenario,'Waypoints','on','RoadCenters','on')
while advance(scenario)
    pause(scenario.SampleTime)
end
```

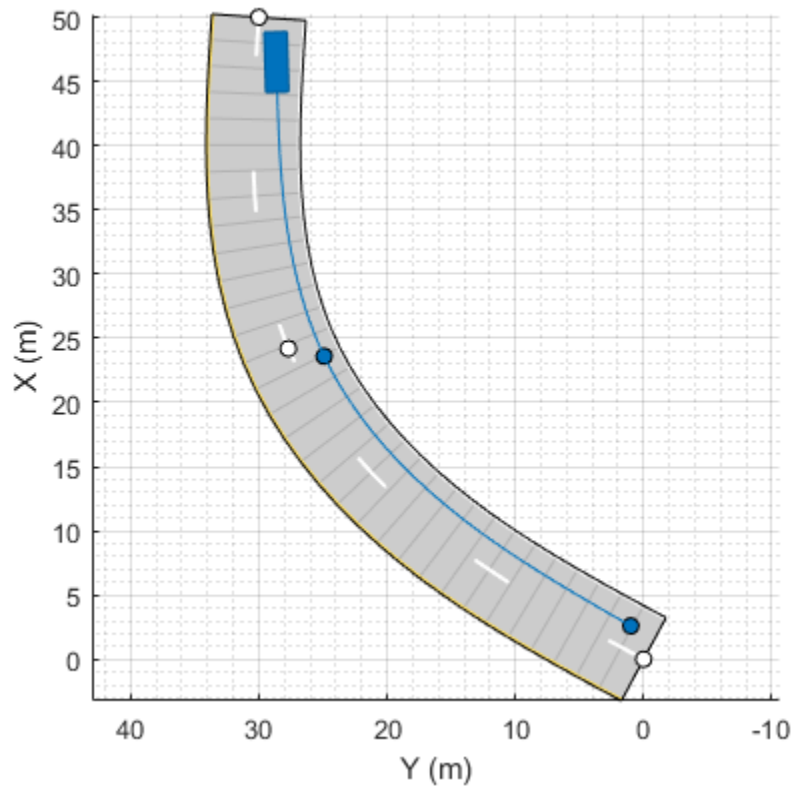

Create Trajectory with Wait Time at Intersection

Create a driving scenario containing a four-way intersection.

```
scenario = drivingScenario('SampleTime',0.02,'StopTime',20);
```

```
roadCenters = [0 0; 50 0];
laneSpecification = lanespec([1 1]);
road(scenario,roadCenters,'Lanes',laneSpecification);
```

```
roadCenters = [25 25; 25 -25];
road(scenario,roadCenters,'Lanes',laneSpecification);
```

Add the ego vehicle, which travels north but waits for one second at the intersection.

```
ego = vehicle(scenario,'ClassID',1,'Position',[2 -2 0]);
waypoints = [2 -2; 17.5 -2; 45 -2];
```

```

speed = [5 0 5];
waittime = [0 1 0];
smoothTrajectory(ego,waypoints,speed,waittime);

```

Add a bicyclist that travels east through the intersection at a constant speed without stopping.

```

bicycle = actor(scenario, ...
    'ClassID',3, ...
    'Length',1.7, ...
    'Width',0.45, ...
    'Height',1.7, ...
    'Position',[23 23 0]);
waypoints = [23 23; 23 -23];
speed = 4;
smoothTrajectory(bicycle,waypoints,speed);

```

Plot the scenario. The vehicle stops at the intersection for one second, then resumes driving after the bicyclist crosses the intersection.

```

plot(scenario)
while advance(scenario)
    pause(scenario.SampleTime)
end

```

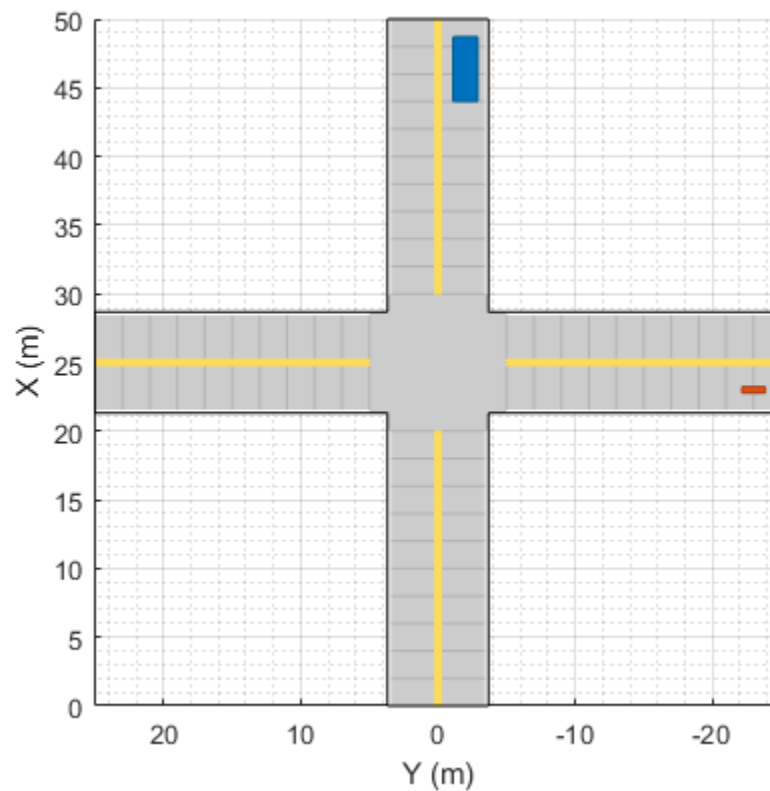

Simulate Car Backing into Parking Space

Simulate a driving scenario in which a car drives in reverse to back into a parking space.

Create a driving scenario containing a parking lot.

```
scenario = drivingScenario;
vertices = [0 9; 18 9; 18 -9; 0 -9];
parkingLot(scenario,vertices,ParkingSpace=parkingSpace);
```

Create a car and define its trajectory. The car drives forward, stops, and then drives in reverse to back into the parking space. As the car enters the parking space, it has a yaw orientation angle that is 90 degrees counterclockwise from where it started.

```
car = vehicle(scenario,ClassID=1);
waypoints = [9 -5; 9 5; 6 -1.3; 2 -1.3];
speed = [3; 0; -2; 0];
yaw = [90 90 180 180];
smoothTrajectory(car,waypoints,speed,Yaw=yaw)
```

Plot the driving scenario and display the waypoints of the trajectory.

```
plot(scenario,Waypoints="on")
while advance(scenario)
    pause(0.001)
end
```

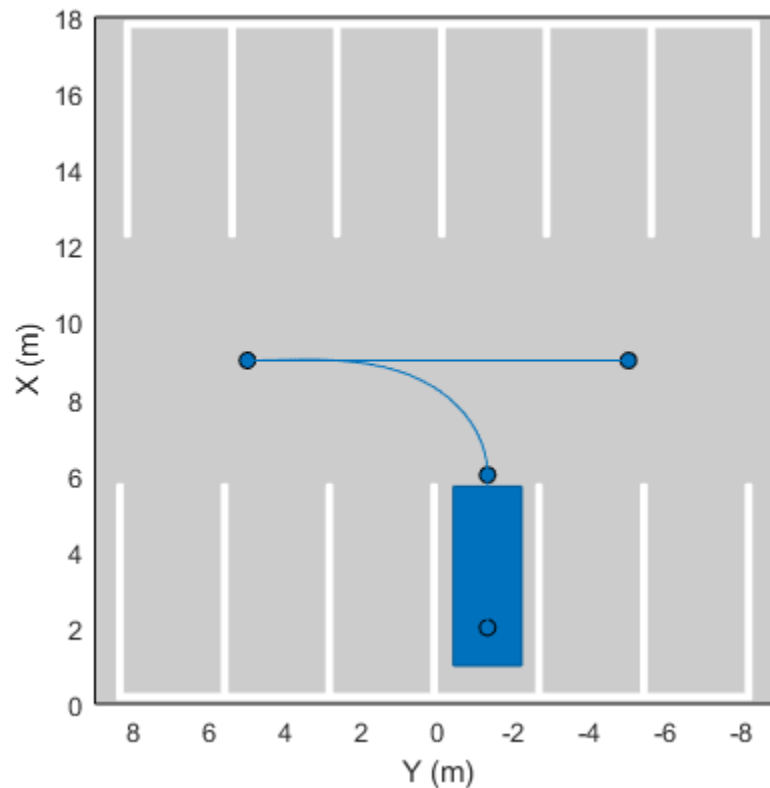

Create Pedestrian Trajectory

Create the trajectory of a pedestrian who takes a sharp right turn at an intersection.

Create a driving scenario. Add road segments that define an intersection.

```
scenario = drivingScenario;
roadCenters = [0 10; 0 -10];
road(scenario,roadCenters);
road(scenario,flip(roadCenters,2));
```

Add a pedestrian actor to the scenario.

```
pedestrian = actor(scenario, ...
    'ClassID',4, ...
    'Length',0.24, ...
    'Width',0.45, ...
    'Height',1.7, ...
    'Position',[-9 0 0], ...
    'RCSPattern',[-8 -8; -8 -8], ...
    'Mesh',driving.scenario.pedestrianMesh, ...
    'Name','Pedestrian');
```

Define the trajectory of the pedestrian. The pedestrian approaches the intersection, pauses briefly, and then takes a sharp right turn at the intersection. To define the sharp right turn, specify two waypoints at the intersection that are close together. For these waypoints, specify the yaw orientation angle of the second waypoint at a 90-degree angle from the first waypoint.

```
waypoints = [-9 0; -0.25 0; 0 -0.25; 0 -9];
speed = [1.5; 0; 0.5; 1.5];
yaw = [0; 0; -90; -90];
waittime = [0; 0.2; 0; 0];
smoothTrajectory(pedestrian,waypoints,speed,waittime,'Yaw',yaw);
```

Plot the driving scenario and display the waypoints of the pedestrian.

```
plot(scenario,'Waypoints','on')
while advance(scenario)
    pause(0.001)
end
```

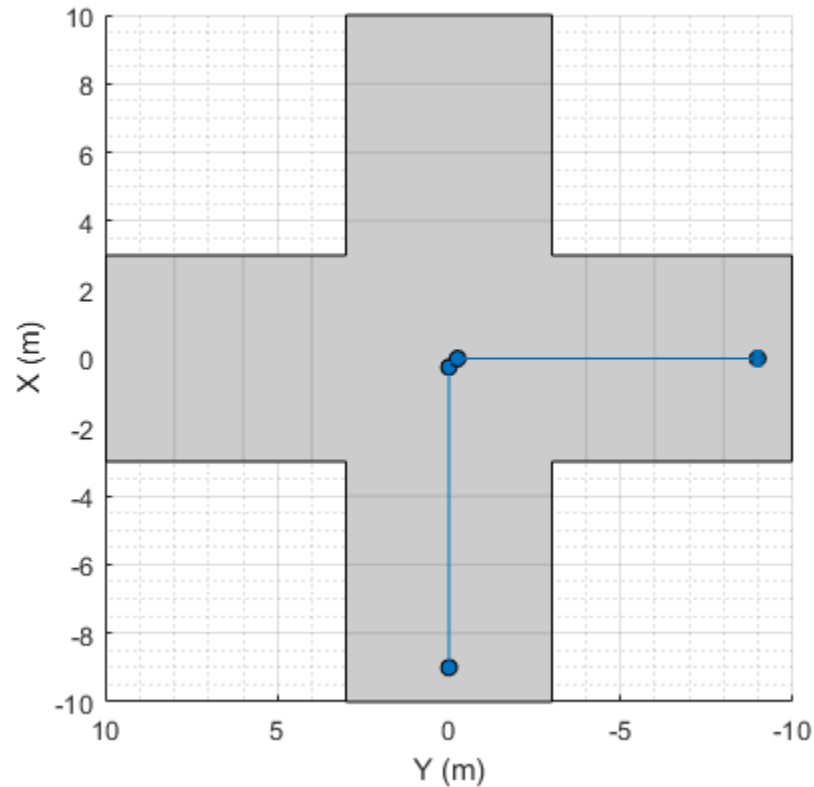

Generate INS Measurements from Driving Scenario

Generate measurements from an INS sensor that is mounted to a vehicle in a driving scenario. Plot the INS measurements against the ground truth state of the vehicle and visualize the velocity and acceleration profile of the vehicle.

Create Driving Scenario

Load the geographic data for a driving route at the MathWorks® Apple Hill campus in Natick, MA.

```
data = load('ahroute.mat');
latIn = data.latitude;
lonIn = data.longitude;
```

Convert the latitude and longitude coordinates of the route to Cartesian coordinates. Set the origin to the first coordinate in the driving route. For simplicity, assume an altitude of 0 for the route.

```
alt = 0;
origin = [latIn(1), lonIn(1), alt];
[xEast, yNorth, zUp] = latlon2local(latIn, lonIn, alt, origin);
```

Create a driving scenario. Set the origin of the converted route as the geographic reference point.

```
scenario = drivingScenario('GeoReference', origin);
```

Create a road based on the Cartesian coordinates of the route.



```
roadCenters = [xEast,yNorth,zUp];  
road(scenario,roadCenters);
```

Create a vehicle that follows the center line of the road. The vehicle travels between 4 and 5 meters per second (9 to 11 miles per hour), slowing down at the curves in the road. To create the trajectory, use the `smoothTrajectory` function. The computed trajectory minimizes jerk and avoids discontinuities in acceleration, which is a requirement for modeling INS sensors.

```
egoVehicle = vehicle(scenario,'ClassID',1);  
egoPath = roadCenters;  
egoSpeed = [5 5 5 4 4 4 5 4 4 4 4 5 5 5 5];  
smoothTrajectory(egoVehicle,egoPath,egoSpeed);
```

Plot the scenario and show a 3-D view from behind the ego vehicle.

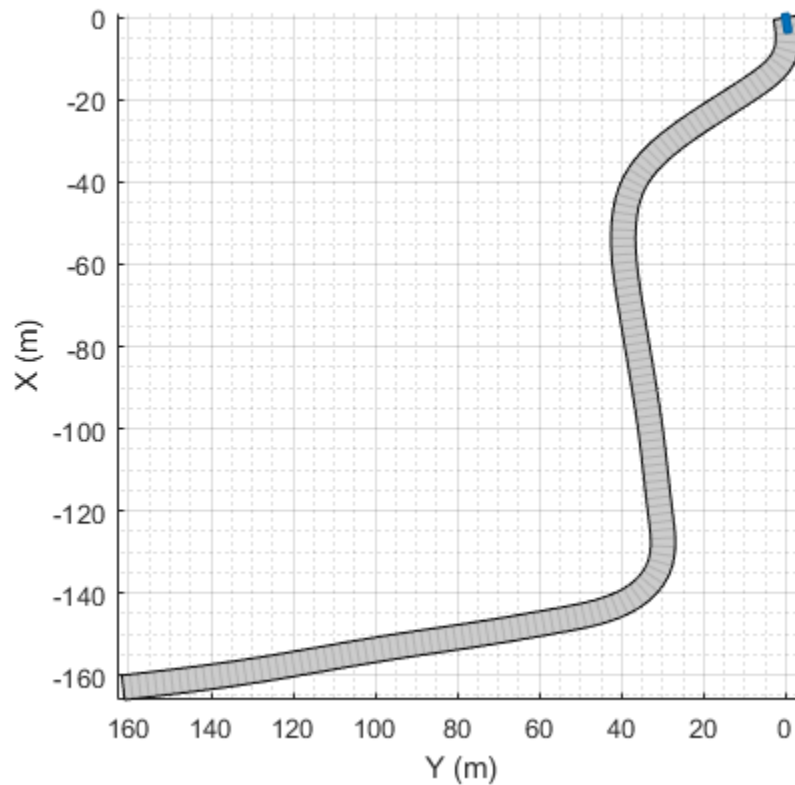
```
plot(scenario)  
chasePlot(egoVehicle)
```



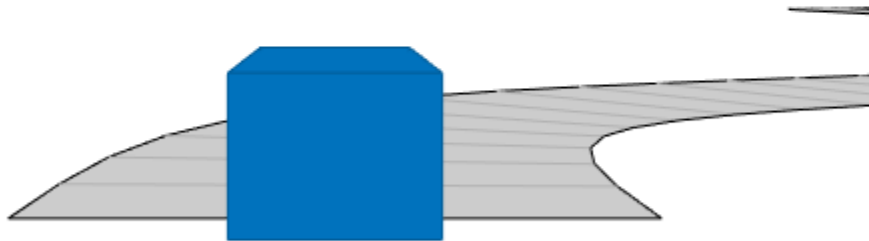

Create INS Sensor

Create an INS sensor that accepts the input of simulation times. Introduce noise into the sensor measurements by setting the standard deviation of velocity and accuracy measurements to 0.1 and 0.05, respectively.

```
INS = insSensor('TimeInput',true, ...  
               'VelocityAccuracy',0.1, ...  
               'AccelerationAccuracy',0.05);
```

Visualize INS Measurements

Initialize a geographic player for displaying the INS measurements and the actor ground truth. Configure the player to display its last 10 positions and set the zoom level to 17.

```
zoomLevel = 17;  
player = geoplayer(latIn(1),lonIn(1),zoomLevel, ...  
                  'HistoryDepth',10,'HistoryStyle','line');
```

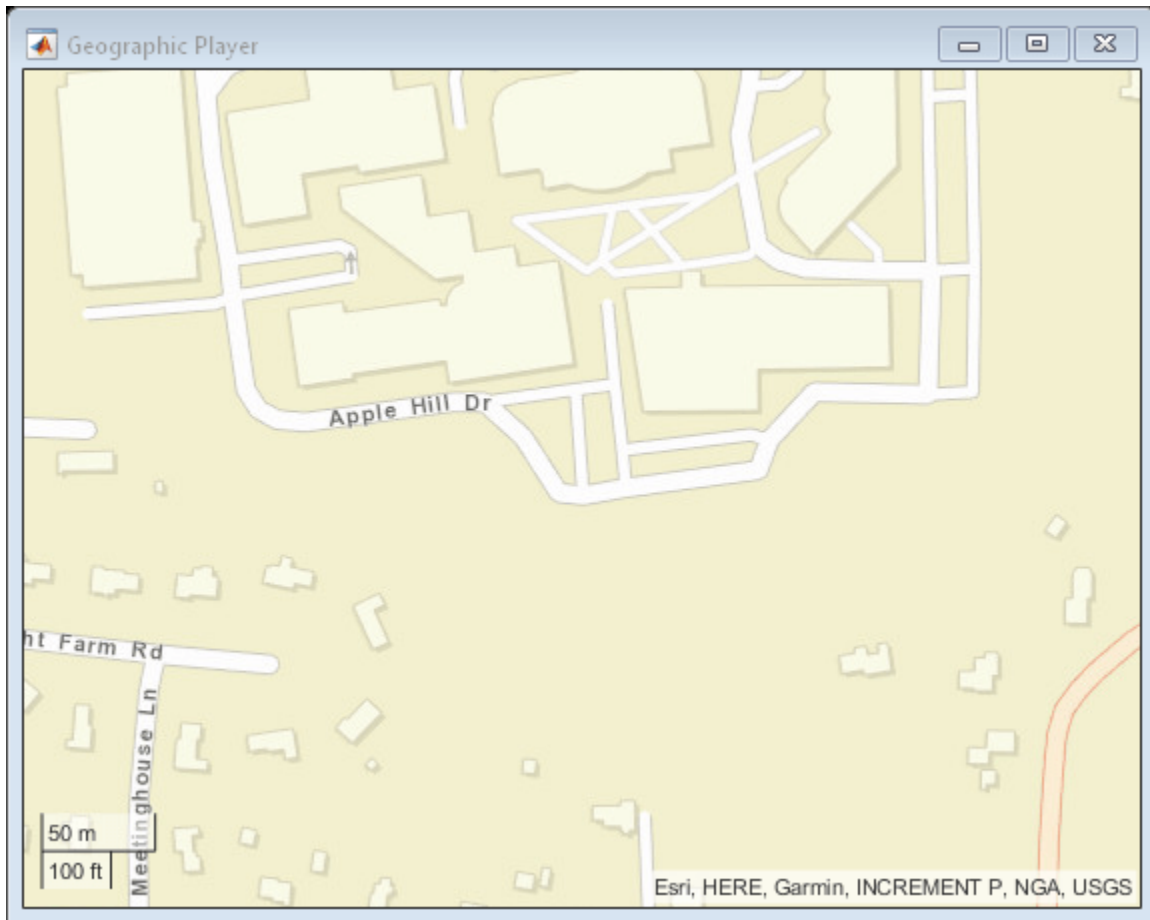

Pre-allocate space for the simulation times, velocity measurements, and acceleration measurements that are captured during simulation.

```
numWaypoints = length(latIn);
times = zeros(numWaypoints,1);
gTruthVelocities = zeros(numWaypoints,1);
gTruthAccelerations = zeros(numWaypoints,1);
sensorVelocities = zeros(numWaypoints,1);
sensorAccelerations = zeros(numWaypoints,1);
```

Simulate the scenario. During the simulation loop, obtain the ground truth state of the ego vehicle and an INS measurement of that state. Convert these readings to geographic coordinates, and at each waypoint, visualize the ground truth and INS readings on the geographic player. Also capture the velocity and acceleration data for plotting the velocity and acceleration profiles.

```
nextWaypoint = 2;
while advance(scenario)

    % Obtain ground truth state of ego vehicle.
    gTruth = state(egoVehicle);

    % Obtain INS sensor measurement.
    measurement = INS(gTruth,scenario.SimulationTime);

    % Convert readings to geographic coordinates.
```

```

[latOut,lonOut] = local2latlon(measurement.Position(1), ...
                             measurement.Position(2), ...
                             measurement.Position(3),origin);

% Plot differences between ground truth locations and locations reported by sensor.
reachedWaypoint = sum(abs(roadCenters(nextWaypoint,:) - gTruth.Position)) < 1;
if reachedWaypoint
    plotPosition(player,latIn(nextWaypoint),lonIn(nextWaypoint),'TrackID',1)
    plotPosition(player,latOut,lonOut,'TrackID',2,'Label','INS')

    % Capture simulation times, velocities, and accelerations.
    times(nextWaypoint,1) = scenario.SimulationTime;
    gTruthVelocities(nextWaypoint,1) = gTruth.Velocity(2);
    gTruthAccelerations(nextWaypoint,1) = gTruth.Acceleration(2);
    sensorVelocities(nextWaypoint,1) = measurement.Velocity(2);
    sensorAccelerations(nextWaypoint,1) = measurement.Acceleration(2);

    nextWaypoint = nextWaypoint + 1;
end

if nextWaypoint > numWaypoints
    break
end
end

```

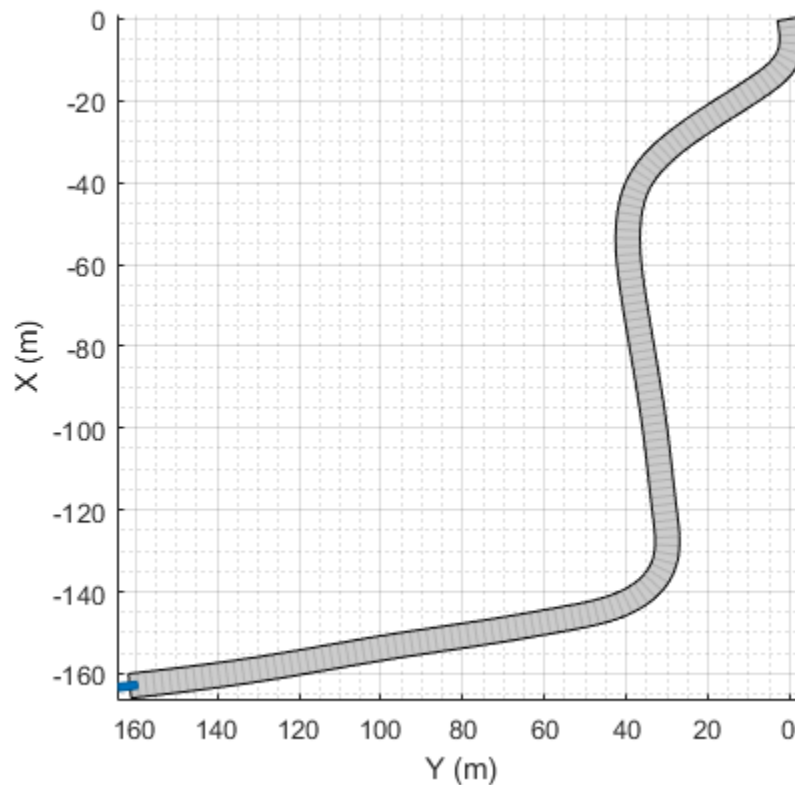

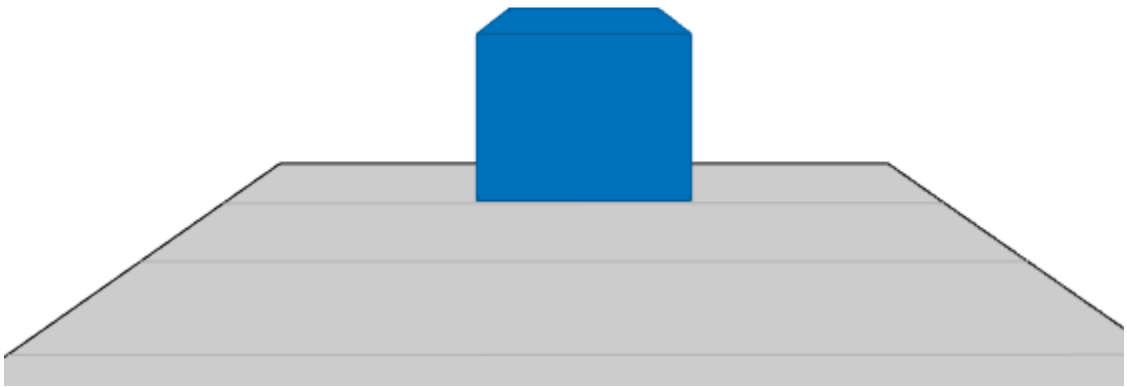

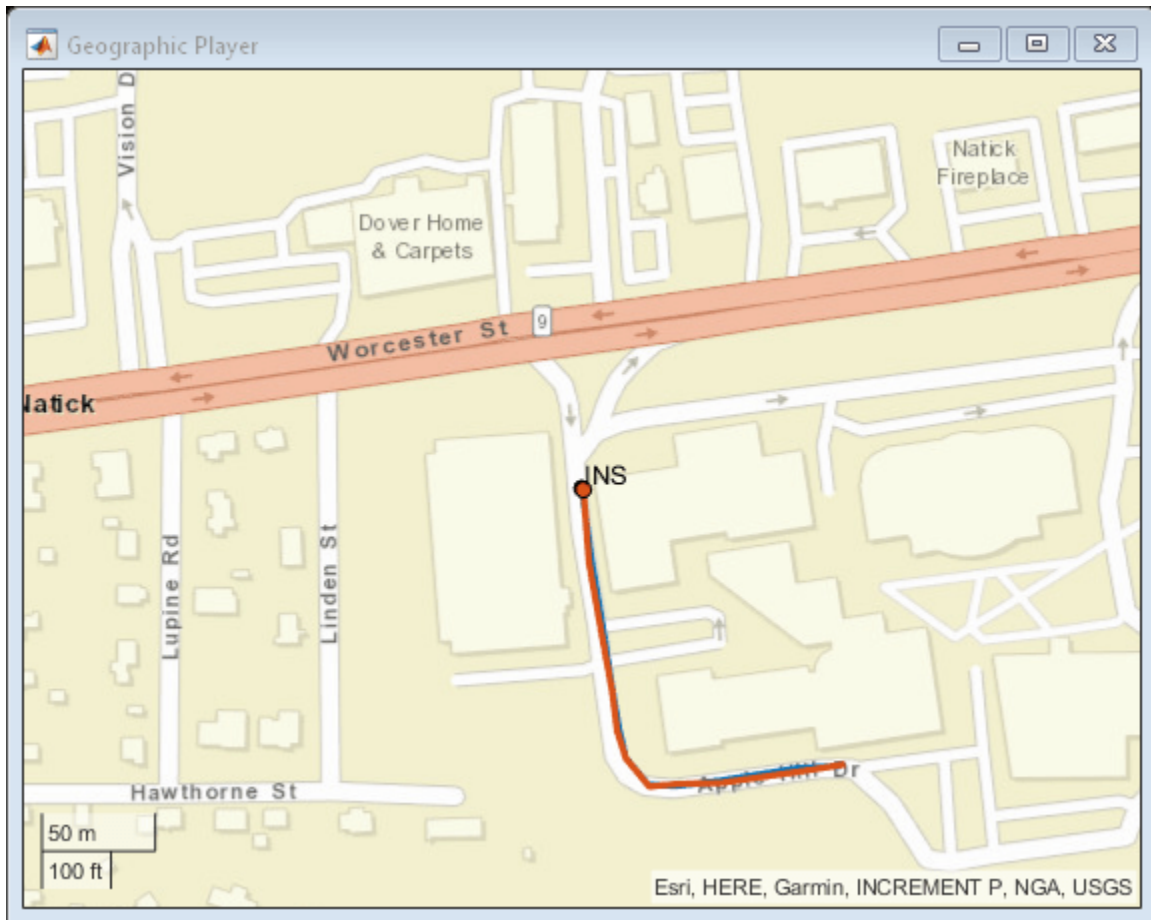

Plot Velocity Profile

Compare the ground truth longitudinal velocity of the vehicle over time against the velocity measurements captured by the INS sensor.

Remove zeros from the time vector and velocity vectors.

```
times(times == 0) = [];
gTruthVelocities(gTruthVelocities == 0) = [];
sensorVelocities(sensorVelocities == 0) = [];
```

```
figure
hold on
plot(times,gTruthVelocities)
plot(times,sensorVelocities)
title('Longitudinal Velocity Profile')
xlabel('Time (s)')
ylabel('Velocity (m/s)')
legend('Ground truth','INS')
hold off
```

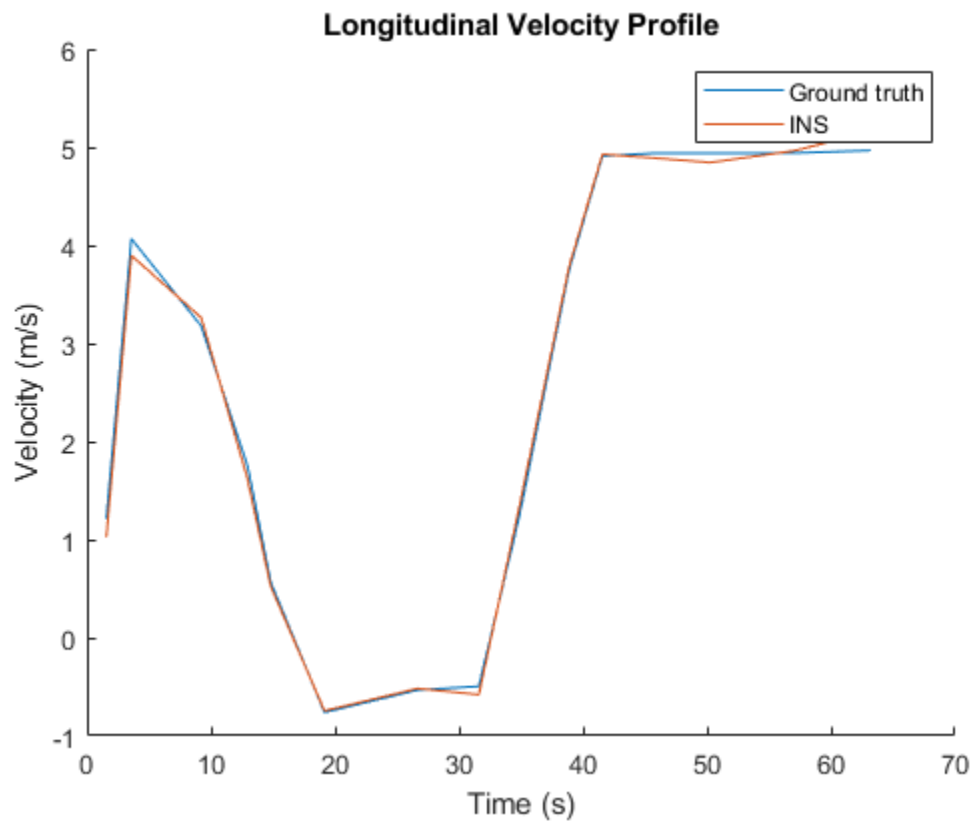

Plot Acceleration Profile

Compare the ground truth longitudinal acceleration of the vehicle over time against the acceleration measurements captured by the INS sensor.

```
gTruthAccelerations(gTruthAccelerations == 0) = [];  
sensorAccelerations(sensorAccelerations == 0) = [];
```

```
figure  
hold on  
plot(times,gTruthAccelerations)  
plot(times,sensorAccelerations)  
title('Longitudinal Acceleration Profile')  
xlabel('Time (s)')  
ylabel('Acceleration (m/s^2)')  
legend('Ground truth','INS')  
hold off
```

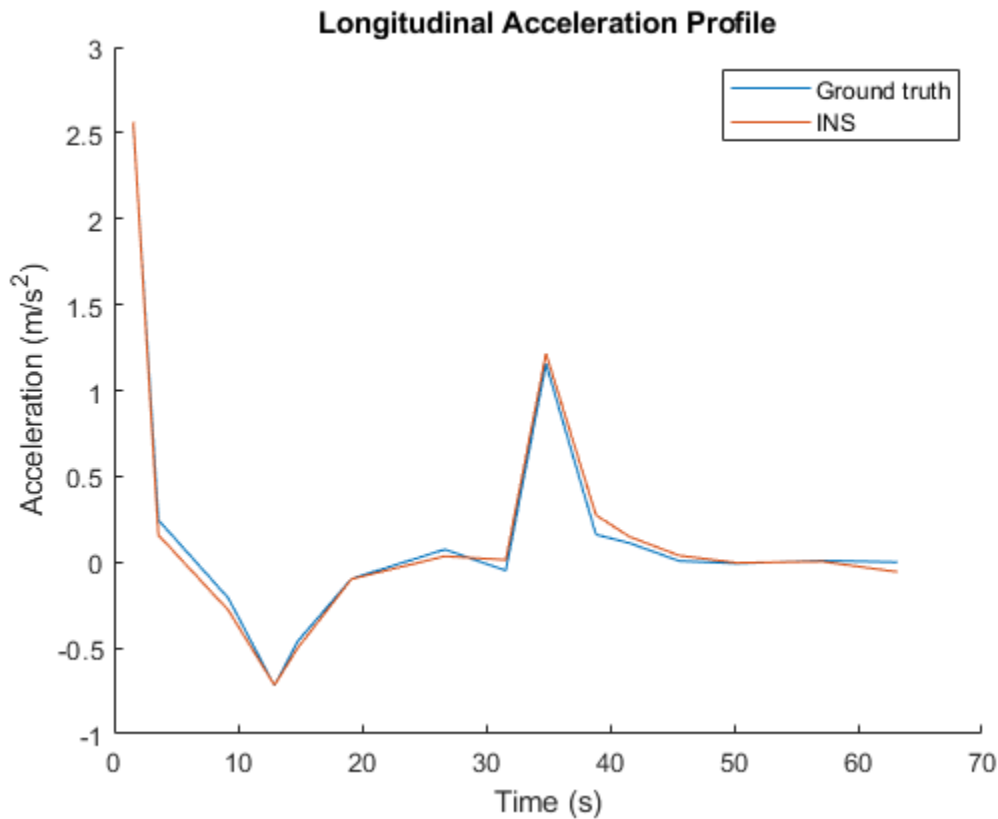

Input Arguments

ac – Actor

Actor object | Vehicle object

Actor belonging to a `drivingScenario` object, specified as an `Actor` or `Vehicle` object. To create these objects, use the `actor` and `vehicle` functions, respectively.

waypoints – Trajectory waypoints

real-valued N -by-2 matrix | real-valued N -by-3 matrix

Trajectory waypoints, in meters, specified as a real-valued N -by-2 or N -by-3 matrix. N is the number of waypoints.

- If `waypoints` is an N -by-2 matrix, then each matrix row represents the (x, y) coordinates of a waypoint. The z -coordinate of each waypoint is zero.
- If `waypoints` is an N -by-3 matrix, then each matrix row represents the (x, y, z) coordinates of a waypoint.

Each of the $N - 1$ segments between the waypoints defines a curve whose curvature varies linearly with length. If the first and last waypoint are identical, then the trajectory forms a loop.

Waypoints are in the world coordinate system.

Example: `[1 0 0; 2 7 7; 3 8 8]`

Data Types: `single` | `double`

speed — Speed of actor

`30.0` (default) | real-valued scalar | N -element real-valued vector

Speed of the actor at each waypoint, in meters per second, specified as a real-valued scalar or N -element real-valued vector. N is the number of waypoints specified by `waypoints`.

- When `speed` is a scalar, the speed is constant throughout the actor motion.
- When `speed` is a vector, the vector values specify the speed at each waypoint. For forward motion, specify positive speed values. For reverse motion, specify negative speed values. To change motion directions, separate the positive and negative speeds by a waypoint with `0` speed.

Speeds are interpolated between waypoints. You can specify `speed` values as `0` at any waypoint but you cannot specify `0` speed at two consecutive waypoints.

If you do not specify `speed`, then by default, the actor travels at a constant speed of 30 m/s.

Example: `[10 8 9]` specifies speeds of 10 m/s, 8 m/s, and 9 m/s.

Example: `[10 0 -10]` specifies a speed of 10 m/s in forward motion, a pause for changing directions, and a speed of 10 m/s in reverse.

Data Types: `single` | `double`

waittime — Wait time of actor

`0` (default) | N -element vector real-valued vector

Wait time of the actor at each waypoint, in seconds, specified as an N -element real-valued vector. N is the number of waypoints specified by `waypoints`.

When you specify a nonnegative wait time for the actor at a waypoint, the actor pauses at that waypoint for the specified number of seconds. When you specify a nonnegative wait time, you must set the corresponding `speed` value to `0`. You can set the `waittime` to `0` at any waypoint, but you cannot set `waittime` at two consecutive waypoints to nonzero values.

Example: `[0 0 5 0]` pauses the actor for five seconds when it reaches the third waypoint.

Data Types: `single` | `double`

Name-Value Pair Arguments

Specify optional pairs of arguments as `Name1=Value1, ..., NameN=ValueN`, where `Name` is the argument name and `Value` is the corresponding value. Name-value arguments must appear after other arguments, but the order of the pairs does not matter.

Before R2021a, use commas to separate each name and value, and enclose `Name` in quotes.

Example: `'Yaw',[0 90 90 0], 'Jerk',0.9`

Yaw — Yaw orientation angle of actor

N -element real-valued vector

Yaw orientation angle of the actor at each waypoint, in degrees, specified as the comma-separated pair consisting of `'Yaw'` and an N -element real-valued vector. N is the number of waypoints specified by `waypoints`. Angles are positive in the counterclockwise direction.

If you do not specify `yaw`, then the yaw at each waypoint is NaN, meaning that the yaw has no constraints.

Example: `[0 90]` specifies an actor at a 0-degree angle at the first waypoint and a 90-degree angle at the second waypoint.

Example: `[0 NaN]` specifies an actor at a 0-degree angle at the first waypoint. The actor has no constraints on its yaw at the second waypoint.

Data Types: `single` | `double`

Jerk — Maximum longitudinal jerk of actor

0.6 (default) | real-valued scalar greater than or equal to 0.1

Maximum longitudinal jerk of the actor, in meters per second cubed, specified as the comma-separated pair consisting of 'Jerk' and a real-valued scalar greater than or equal to 0.1.

To limit jerk to a range that creates comfortable trajectories for human passengers, set 'Jerk' in the range from 0.3 to 0.9 [1].

Data Types: `single` | `double`

Tips

- If the `smoothTrajectory` function is unable to compute a smooth, jerk-limited trajectory given the input parameters, try making these adjustments to the scenario:
 - Extend the distances between waypoints to give the vehicle more time to accelerate to the specified speeds.
 - Lower the speeds at each waypoint. Try converting the speed values from meters per second to miles per hour to see if the speeds are realistic given the scenario. For example, it is unlikely that the algorithm can compute a smooth trajectory for a sharp turn that is taken at a speed of 30 m/s (about 67 mph).
 - Increase the maximum jerk. Increasing the jerk maximum enables the algorithm to compute more possible trajectories at the expense of reduced human passenger comfort.

Algorithms

The `smoothTrajectory` function creates a jerk-limited trajectory using a trapezoidal acceleration profile. This trajectory has smooth acceleration transitions between waypoints, resulting in a comfortable ride for human passengers. The function calculates a separate trapezoidal acceleration profile for each of the $N - 1$ segments between trajectory waypoints.

Consider a simple scenario in which a car travels a distance of 50 meters along a 100-meter road. The trajectory consists of one 50-meter segment in which the car must increase its speed from 5 m/s to 10 m/s by the end of the segment. The trajectory has an additional constraint in which the maximum longitudinal jerk must not exceed 0.5 m/s³.

```
scenario = drivingScenario;
car = vehicle(scenario);
road(scenario,[0 -25; 0 75]); % m
waypoints = [0 0; 0 50]; % m

speed = [5 10]; % m/s
```

```
jerk = 0.5; % m/s^3  
smoothTrajectory(car, waypoints, speed, 'Jerk', jerk)
```

Given the distance, speed, and jerk constraints of this waypoint segment, the `smoothTrajectory` function generates a three-phase trapezoidal acceleration profile:

- 1** Increase acceleration linearly. Hold jerk constant at a value no greater than `jerk`.
- 2** Hold acceleration constant. Decrease jerk to 0.
- 3** Decrease acceleration linearly. Hold jerk constant at a value no less than `-jerk`.

These plots visualize the distance, speed, acceleration, and jerk profile along this waypoint segment over time. The three phases of the acceleration profile form a trapezoidal shape.

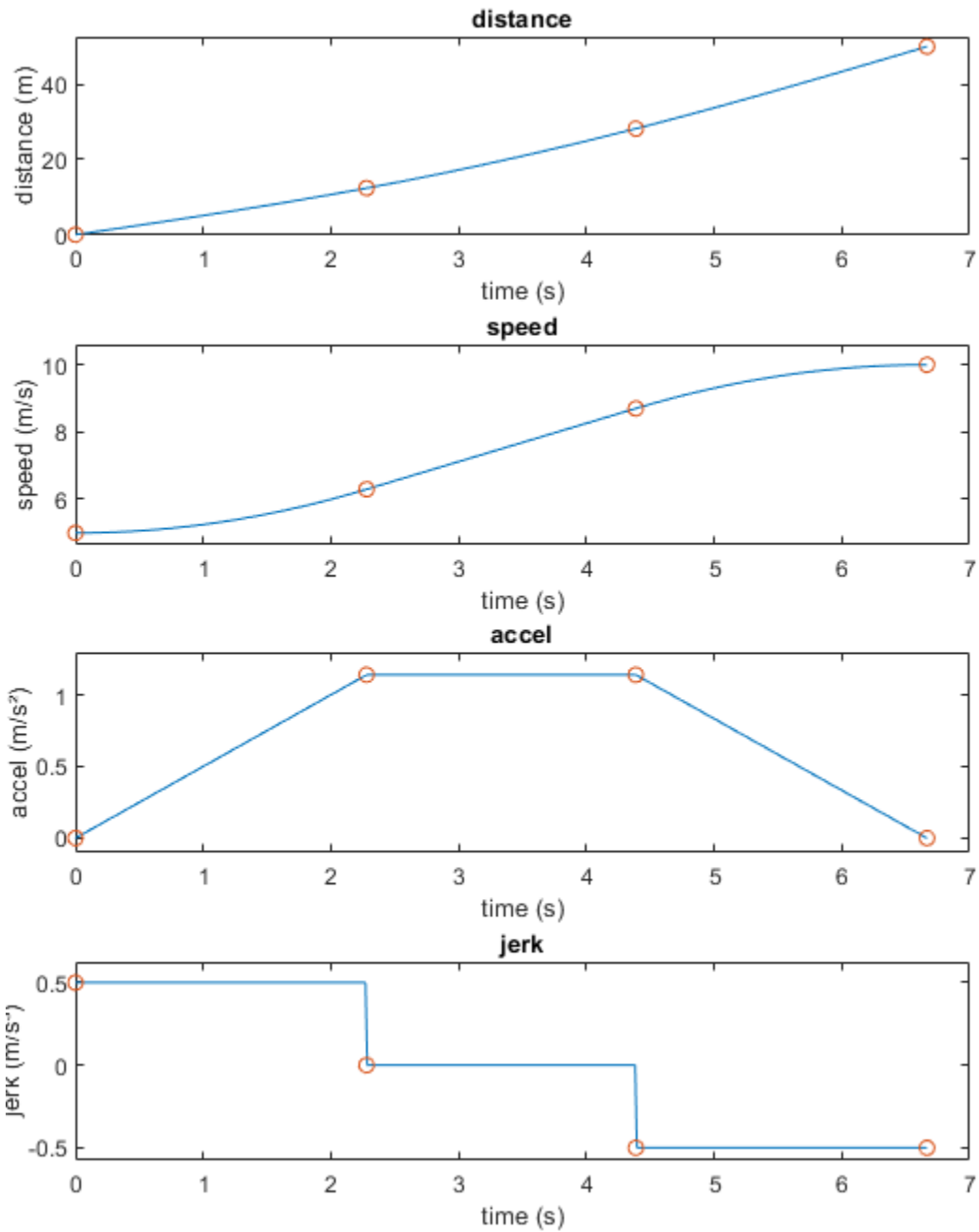

When speed decreases between waypoints, the `smoothTrajectory` function generates the three-phase trapezoidal acceleration profile in reverse order. In the decreased speed case, the shape of the acceleration profile is the inverse of the one shown in the previous plot.

Version History

Introduced in R2021a

References

- [1] Bae, Il, Jaeyoung Moon, and Jeongseok Seo. "Toward a Comfortable Driving Experience for a Self-Driving Shuttle Bus." *Electronics* 8, no. 9 (August 27, 2019): 943. <https://doi.org/10.3390/electronics8090943>.

See Also

Objects

drivingScenario | insSensor

Functions

road | actor | vehicle | state

Topics

"Create Actor and Vehicle Trajectories Programmatically"

trajectory

Package:

Create actor or vehicle trajectory in driving scenario

Syntax

```
trajectory(ac,waypoints)
trajectory(ac,waypoints,speed)
trajectory(ac,waypoints,speed,waittime)
trajectory( ____, 'Yaw', yaw)
```

Description

`trajectory(ac,waypoints)` creates a trajectory for an actor or vehicle, `ac`, from a set of waypoints.

Note The trajectory function generates trajectories that have discontinuities in acceleration between waypoints, resulting in high amounts of jerk. To generate a smooth, jerk-limited trajectory, use the `smoothTrajectory` function instead.

`trajectory(ac,waypoints,speed)` also specifies the speed with which the actor or vehicle travels along the trajectory, in either forward or reverse motion.

`trajectory(ac,waypoints,speed,waittime)` specifies the wait time for an actor or vehicle in addition to the input arguments in the previous syntax. Use this syntax to generate stop-and-go driving scenarios by pausing an actor or vehicle actors at specific waypoints.

`trajectory(____, 'Yaw', yaw)` specifies the yaw orientation angle of the actor or vehicle at each waypoint, in addition to any of the input argument combinations from preceding syntaxes.

Examples

Simulate Vehicle with Trajectory of Varying Speeds

Create a driving scenario and add a curved two-lane road to it.

```
scenario = drivingScenario('SampleTime',0.05);
roadcenters = [5 0; 30 10; 35 25];
lspec = lanespec(2);
road(scenario,roadcenters,'Lanes',lspec);
```

Add a vehicle to the scenario. Set a trajectory in which the vehicle drives around the curve at varying speeds.

```
v = vehicle(scenario,'ClassID',1);
waypoints = [6 2; 18 4; 25 7; 28 10; 31 15; 33 22];
```

```
speeds = [30 10 5 5 10 30];
trajectory(v,waypoints,speeds)
```

Plot the scenario and run the simulation. Observe how the vehicle slows down as it drives along the curve.

```
plot(scenario,'Waypoints','on','RoadCenters','on')
while advance(scenario)
    pause(0.1)
end
```

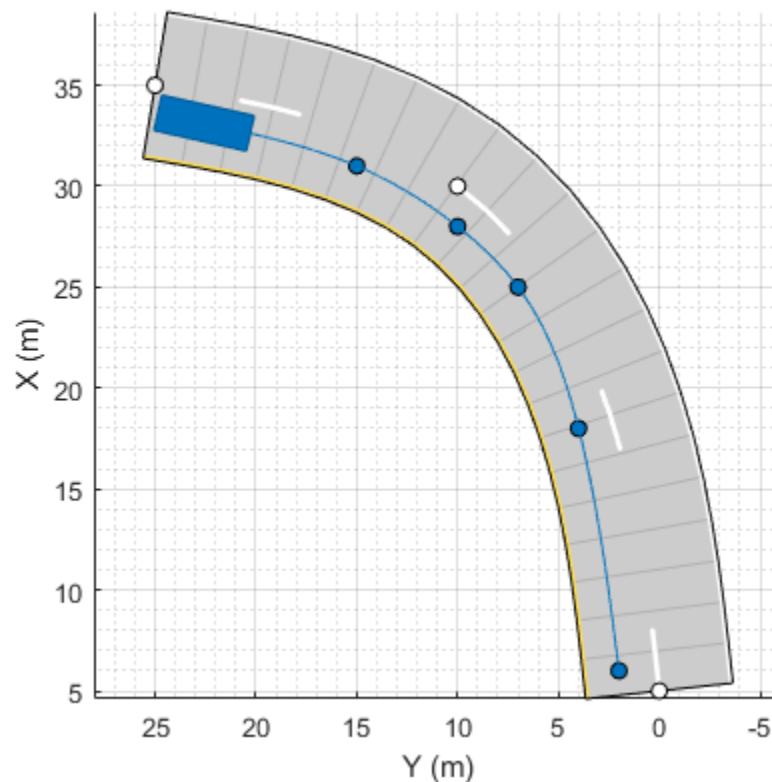

Generate Stop-and-Go Driving Scenario

Create a driving scenario consisting of two, two-lane roads that intersect at a right angle.

```
scenario = drivingScenario('StopTime',2.75);
roadCenters = [50 1 0; 2 0.9 0];
laneSpecification = lanespec(2,'Width',4);
road(scenario,roadCenters,'Lanes',laneSpecification);
roadCenters = [27 24 0; 27 -21 0];
road(scenario,roadCenters,'Lanes',laneSpecification);
```

Add an ego vehicle to the scenario. Specify the waypoints and the speed values for the vehicle at each waypoint. Set a wait time for the vehicle at the second waypoint. Generate a trajectory in which the ego vehicle travels through the specified waypoints at the specified speed.

```
egoVehicle = vehicle(scenario, 'ClassID',1, 'Position', [5 -1 0]);  
waypoints = [5 -1 0; 16 -1 0; 40 -1 0];  
speed = [30; 0; 30];  
waittime = [0; 0.3; 0];  
trajectory(egoVehicle, waypoints, speed, waittime);
```

Add a car to the scenario. Specify the waypoints and the speed values for the car at each waypoint. Set a wait time for the car at the second waypoint. Generate a trajectory in which the car travels through the specified waypoints at the specified speed.

```
car = vehicle(scenario, 'ClassID',1, 'Position', [48 4 0], 'PlotColor', [0.494 0.184 0.556], 'Name', 'N');  
waypoints = [47 3 0; 38 3 0; 10 3 0];  
speed = [30; 0; 30];  
waittime = [0; 0.3; 0];  
trajectory(car, waypoints, speed, waittime);
```

Add an ambulance to the scenario. Generate a trajectory in which the ambulance travels through the specified waypoints at a constant speed.

```
ambulance = vehicle(scenario, 'ClassID',6, 'Position', [25 22 0], 'PlotColor', [0.466 0.674 0.188], 'Name', 'N');  
waypoints = [25 22 0; 25 13 0; 25 6 0; 26 2 0; 33 -1 0; 45 -1 0];  
speed = 25;  
trajectory(ambulance, waypoints, speed);
```

Create a custom figure window to plot the scenario.

```
fig = figure;  
set(fig, 'Position', [0,0,800,600]);  
movegui(fig, 'center');  
hViewPnl = uipanel(fig, 'Position', [0 0 1 1], 'Title', 'Stop-and-Go Scenario');  
hPlt = axes(hViewPnl);
```

Plot the scenario and run the simulation. The ego vehicle and the car pause for their specified wait times to avoid collision with the ambulance.

```
plot(scenario, 'Waypoints', 'on', 'RoadCenters', 'on', 'Parent', hPlt)  
while advance(scenario)  
    pause(0.1)  
end
```

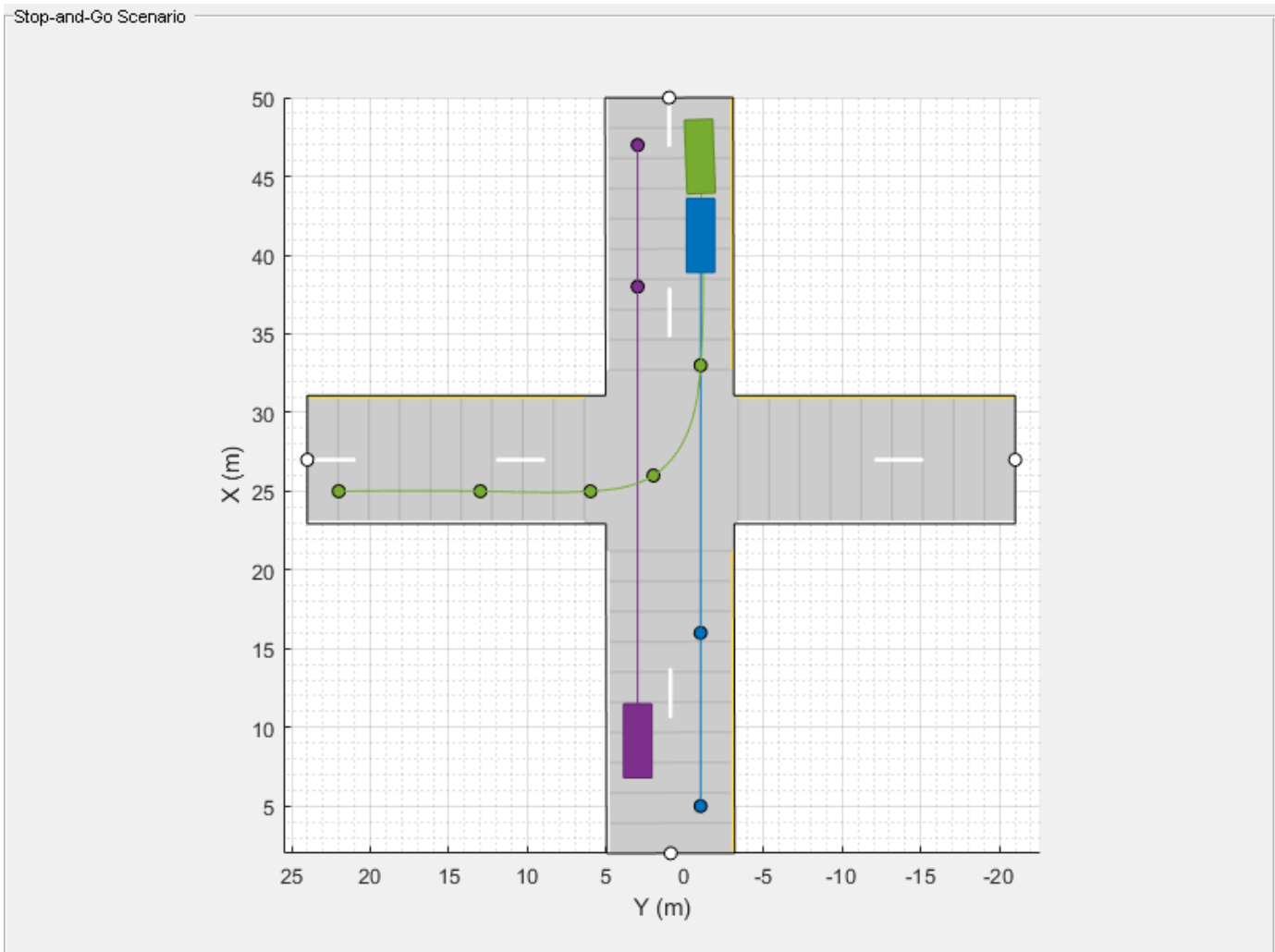
Simulate Car Backing into Parking Space

Simulate a driving scenario in which a car drives in reverse to back into a parking space.

Create a driving scenario containing a parking lot.

```
scenario = drivingScenario;
vertices = [0 9; 18 9; 18 -9; 0 -9];
parkingLot(scenario,vertices,ParkingSpace=parkingSpace);
```

Create a car and define its trajectory. The car drives forward, stops, and then drives in reverse to back into the parking space. As the car enters the parking space, it has a yaw orientation angle that is 90 degrees counterclockwise from where it started.

```
car = vehicle(scenario,ClassID=1);
waypoints = [9 -5; 9 5; 6 -1.3; 2 -1.3];
speed = [3; 0; -2; 0];
```

```
yaw = [90 90 180 180];
smoothTrajectory(car,waypoints,speed,Yaw=yaw)
```

Plot the driving scenario and display the waypoints of the trajectory.

```
plot(scenario,Waypoints="on")
while advance(scenario)
    pause(0.001)
end
```

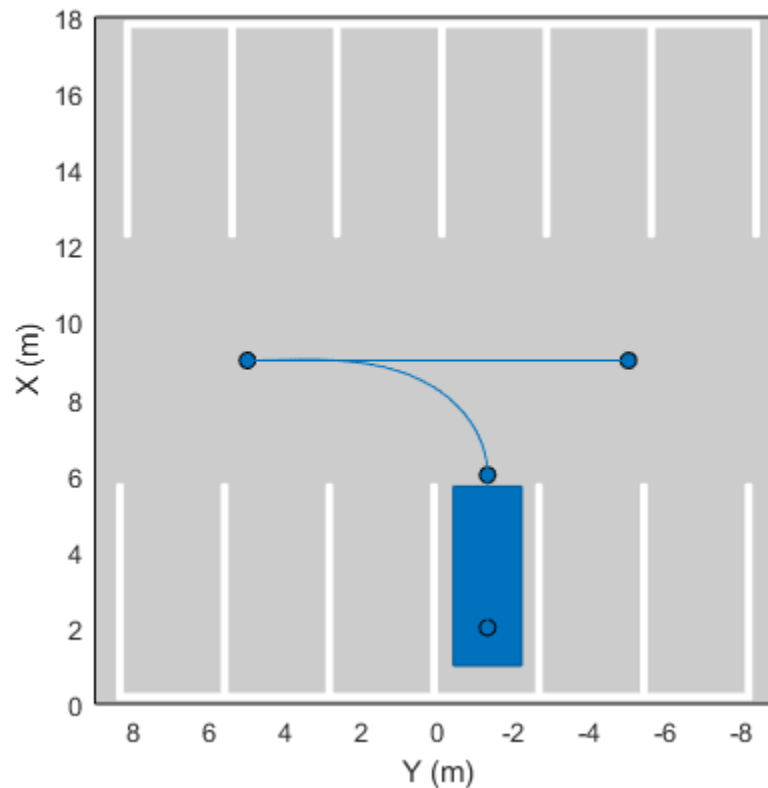

Define Trajectory of Pedestrian

Define the trajectory of a pedestrian who takes a sharp right turn at an intersection.

Create a driving scenario. Add road segments that define an intersection.

```
scenario = drivingScenario;
roadCenters = [0 10; 0 -10];
road(scenario,roadCenters);
road(scenario,flip(roadCenters,2));
```

Add a pedestrian actor to the scenario.

```
pedestrian = actor(scenario, ...
    'ClassID',4, ...
    'Length',0.24, ...
```

```
'Width',0.45, ...
'Height',1.7, ...
'Position',[-9 0 0], ...
'RCSPattern',[-8 -8; -8 -8], ...
'Mesh', driving.scenario.pedestrianMesh, ...
'Name','Pedestrian');
```

Define the trajectory of the pedestrian. The pedestrian approaches the intersection, pauses briefly, and then takes a sharp right turn at the intersection. To define the sharp right turn, specify two waypoints at the intersection that are close together. For these waypoints, specify the yaw orientation angle of the second waypoint at a 90-degree angle from the first waypoint.

```
waypoints = [-9 0; -0.25 0; 0 -0.25; 0 -9];
speed = [1.5; 0; 0.5; 1.5];
yaw = [0; 0; -90; -90];
waittime = [0; 0.2; 0; 0];
trajectory(pedestrian,waypoints,speed,waittime,'Yaw', yaw);
```

Plot the driving scenario and display the waypoints of the pedestrian.

```
plot(scenario,'Waypoints','on')
while advance(scenario)
    pause(0.001)
end
```

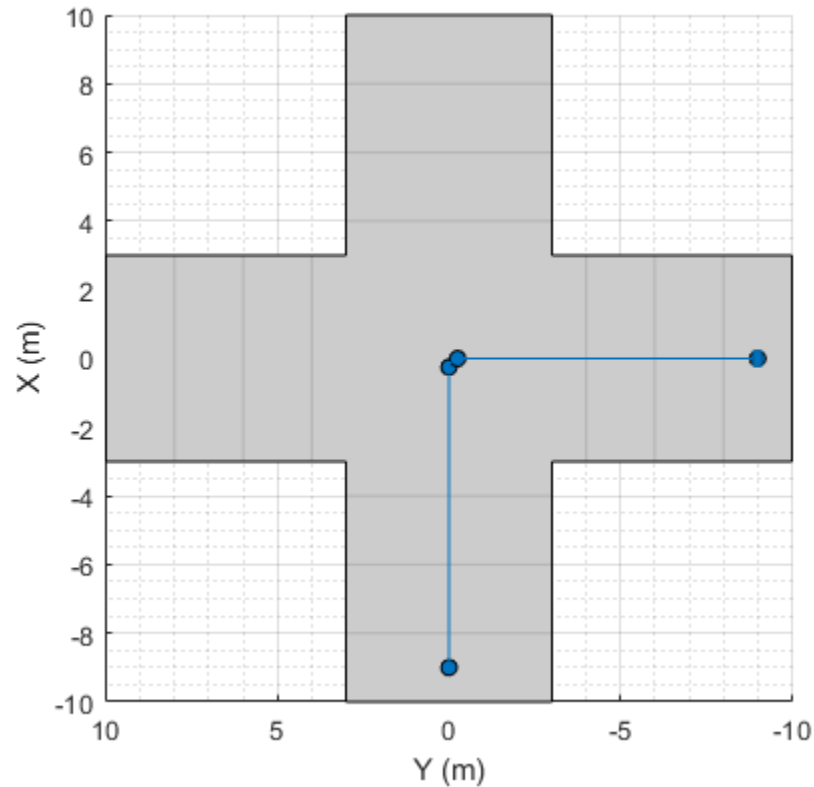

Input Arguments

ac – Actor

Actor object | Vehicle object

Actor belonging to a `drivingScenario` object, specified as an `Actor` or `Vehicle` object. To create these objects, use the `actor` and `vehicle` functions, respectively.

waypoints – Trajectory waypoints

real-valued N -by-2 matrix | real-valued N -by-3 matrix

Trajectory waypoints, specified as a real-valued N -by-2 or N -by-3 matrix, where N is the number of waypoints.

- If `waypoints` is an N -by-2 matrix, then each matrix row represents the (x, y) coordinates of a waypoint. The z -coordinate of each waypoint is zero.
- If `waypoints` is an N -by-3 matrix, then each matrix row represents the (x, y, z) coordinates of a waypoint.

Waypoints are in the world coordinate system. Units are in meters.

Example: `[1 0 0; 2 7 7; 3 8 8]`

Data Types: `single` | `double`

speed — Actor speed

30.0 | real-valued scalar | N -element real-valued vector

Actor speed at each waypoint in `waypoints`, specified as a real-valued scalar or N -element real-valued vector. N is the number of waypoints.

- When `speed` is a scalar, the speed is constant throughout the actor motion.
- When `speed` is a vector, the vector values specify the speed at each waypoint. For forward motion, specify positive speed values. For reverse motion, specify negative speed values. To change motion directions, separate the positive speeds and negative speeds by a waypoint with 0 speed.

Speeds are interpolated between waypoints. `speed` can be zero at any waypoint but cannot be zero at two consecutive waypoints. Units are in meters per second.

Example: [10 8 9] specifies speeds of 10 m/s, 8 m/s, and 9 m/s.

Example: [10 0 -10] specifies a speed of 10 m/s in forward motion, followed by a pause, followed by a speed of 10 m/s in reverse.

Data Types: single | double | int8 | int16 | int32 | int64 | uint8 | uint16 | uint32 | uint64

waittime — Pause time for actor

0 (default) | N -element vector of nonnegative values

Pause time for the actor, specified as an N -element vector of nonnegative values. N is the number of waypoints. When you specify a pause time for the actor at a particular waypoint, you must set the corresponding speed value to 0. You can set the `waittime` to 0 at any waypoint, but you cannot set `waittime` at two consecutive waypoints to non-zero values. Units are in seconds.

Data Types: single | double

yaw — Yaw orientation angle of actor

N -element real-valued vector

Yaw orientation angle of the actor at each waypoint, specified as an N -element real-valued vector, where N is the number of waypoints. Units are in degrees and angles are positive in the counterclockwise direction.

If you do not specify `yaw`, then the yaw at each waypoint is NaN, meaning that the yaw has no constraints.

Example: [0 90] specifies an actor at a 0-degree angle at the first waypoint and a 90-degree angle at the second waypoint.

Example: [0 NaN] specifies an actor at a 0-degree angle at the first waypoint. The actor has no constraints on its yaw at the second waypoint.

Data Types: single | double

Algorithms

The `trajectory` function creates a trajectory for an actor to follow in a scenario. A trajectory consists of the path followed by an object and its speed along the path. You specify the path using N two-dimensional or three-dimensional waypoints. Each of the $N - 1$ segments between waypoints defines a curve whose curvature varies linearly with distance along the segment. The function fits a piecewise clothoid curve to the (x, y) coordinates of the waypoints by matching the curvature on both

sides of the waypoint. For a nonclosed curve, the curvature at the first and last waypoint is zero. If the first and last waypoints coincide, then the curvatures before and after the endpoints are matched. The z-coordinates of the trajectory are interpolated using a shape-preserving piecewise cubic curve.

The generated trajectory results in a piecewise constant-acceleration profile for each segment between waypoints. These segments have acceleration discontinuities between them. To avoid discontinuities in acceleration, use the `smoothTrajectory` function to generate trajectories instead.

Version History

Introduced in R2018a

See Also

Objects

`drivingScenario`

Functions

`road` | `actor` | `vehicle` | `smoothTrajectory`

Topics

“Scenario Generation from Recorded Vehicle Data”

“Create Actor and Vehicle Trajectories Programmatically”

“Create Driving Scenario Programmatically”

targetMeshes

Package:

Mesh vertices and faces relative to specific actor

Syntax

```
[vertices,faces] = targetMeshes(ac)
[vertices,faces,colors] = targetMeshes(ac)
```

Description

`[vertices,faces] = targetMeshes(ac)` returns the mesh vertices and faces of all actors in a driving scenario relative to the specified actor, `ac`. When displaying meshes on page 4-489 by using a `birdsEyePlot` object, you can use the output mesh information as inputs to the `plotMesh` function.

`[vertices,faces,colors] = targetMeshes(ac)` also returns the color of the mesh faces for each actor.

Examples

Display Actor Meshes in Driving Scenario

Display actors in a driving scenario by using their mesh representations instead of their cuboid representations.

Create a driving scenario, and add a 25-meter straight road to the scenario.

```
scenario = drivingScenario;
roadcenters = [0 0 0; 25 0 0];
road(scenario,roadcenters);
```

Add a pedestrian and a vehicle to the scenario. Specify the mesh dimensions of the actors using prebuilt meshes.

- Specify the pedestrian mesh as a `driving.scenario.pedestrianMesh` object.
- Specify the vehicle mesh as a `driving.scenario.carMesh` object.

```
p = actor(scenario,'ClassID',4, ...
          'Length',0.2,'Width',0.4, ...
          'Height',1.7,'Mesh',driving.scenario.pedestrianMesh);
v = vehicle(scenario,'ClassID',1, ...
            'Mesh',driving.scenario.carMesh);
```

Add trajectories for the pedestrian and vehicle.

- Specify for the pedestrian to cross the road at 1 meter per second.
- Specify for the vehicle to follow the road at 10 meters per second.

```
waypointsP = [15 -3 0; 15 3 0];
speedP = 1;
smoothTrajectory(p,waypointsP,speedP);
```

```
wayPointsV = [v.RearOverhang 0 0; (25 - v.Length + v.RearOverhang) 0 0];
speedV = 10;
smoothTrajectory(v,wayPointsV,speedV)
```

Add an egocentric plot for the vehicle. Turn the display of meshes on.

```
chasePlot(v, 'Meshes', 'on')
```

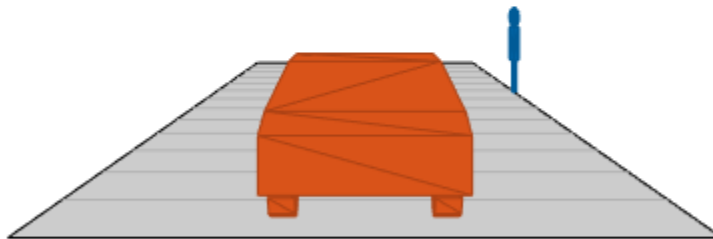

Create a bird's-eye plot in which to display the meshes. Also create a mesh plotter and lane boundary plotter. Then run the simulation loop.

- 1 Obtain the road boundaries of the road the vehicle is on.
- 2 Obtain the mesh vertices, faces, and colors of the actor meshes, with positions relative to the vehicle.
- 3 Plot the road boundaries and actor meshes on the bird's-eye plot.
- 4 Pause the scenario to allow time for the plots to update. The chase plot updates every time you advance the scenario.

```
bep = birdsEyePlot('XLim',[-25 25], 'YLim',[-10 10]);
mPlotter = meshPlotter(bep);
lbPlotter = laneBoundaryPlotter(bep);
legend('off')
```



```
while advance(scenario)
    rb = roadBoundaries(v);
    [vertices,faces,colors] = targetMeshes(v);
    plotLaneBoundary(lbPlotter,rb)
    plotMesh(mPlotter,vertices,faces,'Color',colors)
    pause(0.01)
end
```

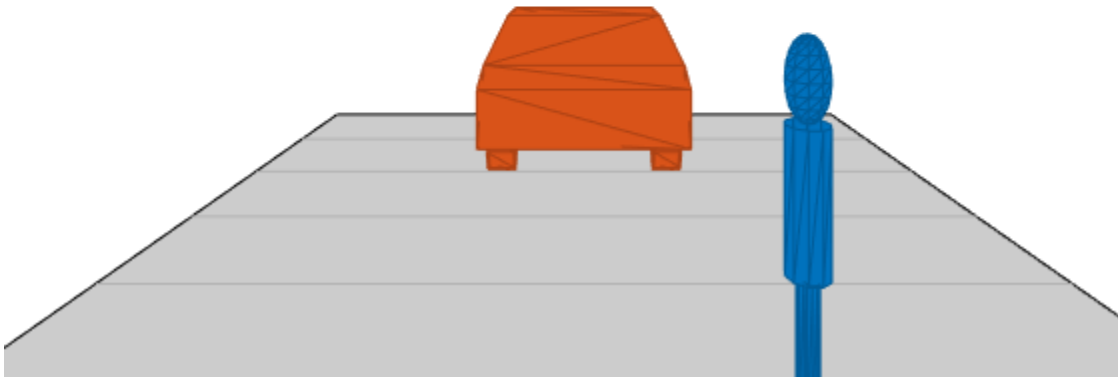

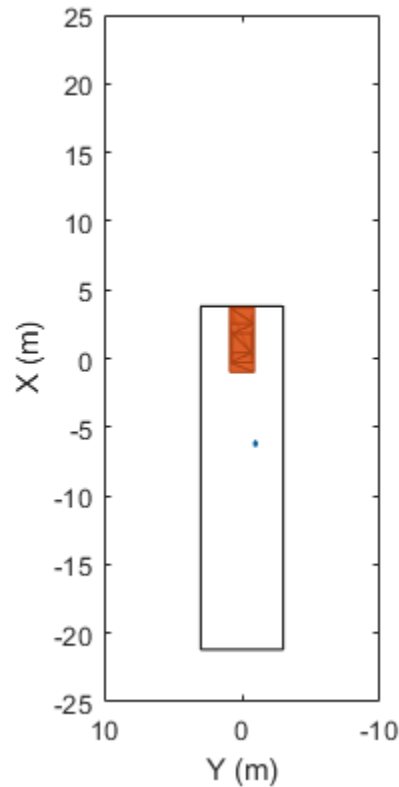

Input Arguments

ac – Actor

Actor object | Vehicle object

Actor belonging to a `drivingScenario` object, specified as an `Actor` or `Vehicle` object. To create these objects, use the `actor` and `vehicle` functions, respectively.

Output Arguments

vertices – Mesh vertices of each actor

N-element cell array

Mesh vertices of each actor, returned as an *N*-element cell array, where *N* is the number of actors.

Each element in `vertices` must be a *V*-by-3 real-valued matrix containing the vertices of an actor, where:

- *V* is the number of vertices.
- Each row defines the 3-D (*x,y,z*) position of a vertex. The vertex positions are relative to the position of the input actor `ac`. Units are in meters.

faces – Mesh faces of each actor

N-element cell array

Mesh faces of each actor, returned as an N -element cell array, where N is the number of actors.

Each element in `faces` must be an F -by-3 integer-valued matrix containing the faces of an actor, where:

- F is the number of faces.
- Each row defines a triangle of vertex IDs that make up the face. The vertex IDs correspond to row numbers within `vertices`.

Suppose the first face of the i th element of `faces` has these vertex IDs.

```
faces{i}(1,:)
```

```
ans =
```

```
     1     2     3
```

In the i th element of `vertices`, rows 1, 2, and 3 contain the (x , y , z) positions of the vertices that make up this face.

```
vertices{i}(1:3,:)
```

```
ans =
```

```
    3.7000    0.9000    0.8574
    3.7000   -0.9000    0.8574
    3.7000   -0.9000    0.3149
```

colors — Color of mesh faces for each actor

N -by-3 matrix of N RGB triplets

Color of the mesh faces for each actor, returned as an N -by-3 matrix of RGB triplets. N is the number of actors and is equal to the number of elements in `vertices` and `faces`.

The i th row of `colors` is the RGB color value of the faces in the i th element of `faces`. The function applies the same color to all mesh faces of an actor.



An RGB triplet is a three-element row vector whose elements specify the intensities of the red, green, and blue components of the color. The intensities must be in the range $[0, 1]$. For example, $[0.4 \ 0.6 \ 0.7]$.

More About

Meshes

In driving scenarios, a mesh is a triangle-based 3-D representation of an object. Mesh representations of objects are more detailed than the default cuboid (box-shaped) representations of objects. Meshes are useful for generating synthetic point cloud data from a driving scenario.

This table shows the difference between a cuboid representation and a mesh representation of a vehicle in a driving scenario.

Cuboid	Mesh
	

Version History

Introduced in R2020b

See Also

Objects

[birdsEyePlot](#) | [drivingScenario](#)

Functions

[actor](#) | [vehicle](#) | [actorPoses](#) | [targetOutlines](#) | [targetPoses](#)

targetPoses

Package:

Target positions and orientations relative to host vehicle

Syntax

```
poses = targetPoses(ac)
poses = targetPoses(ac, range)
poses = targetPoses(scenario, sensorID)
```

Description

`poses = targetPoses(ac)` returns the poses of all targets in a driving scenario with respect to the ego vehicle actor, `ac`. See “Ego Vehicle and Targets” on page 4-502 for more details.

`poses = targetPoses(ac, range)` returns the poses of targets that are within a specified range around the ego vehicle actor.

`poses = targetPoses(scenario, sensorID)` returns the poses of targets that are in the range of the sensor corresponding to the unique ID `sensorID`, with respect to its host vehicle actor in the driving scenario, `scenario`.

Examples

Convert Target Poses Between Ego Vehicle and Scenario Coordinates

In a simple driving scenario, obtain the poses of target vehicles in the coordinate system of the ego vehicle. Then convert these poses back to the world coordinates of the driving scenario.

Create a driving scenario.

```
scenario = drivingScenario;
```

Create target actors.

```
actor(scenario, 'ClassID', 1, ...
    'Position', [10 20 30], ...
    'Velocity', [12 113 14], ...
    'Yaw', 54, ...
    'Pitch', 25, ...
    'Roll', 22, ...
    'AngularVelocity', [24 42 27]);

actor(scenario, 'ClassID', 1, ...
    'Position', [17 22 12], ...
    'Velocity', [19 13 15], ...
    'Yaw', 45, ...
    'Pitch', 52, ...
    'Roll', 2, ...
    'AngularVelocity', [42 24 29]);
```

Add an ego vehicle actor.

```
egoActor = actor(scenario, 'ClassID',1, ...
    'Position',[1 2 3], ...
    'Velocity',[1.2 1.3 1.4], ...
    'Yaw',4, ...
    'Pitch',5, ...
    'Roll',2, ...
    'AngularVelocity',[4 2 7]);
```

Use the `actorPoses` function to return the poses of all actors in the scenario. Pose properties (position, velocity, and orientation) are in the world coordinates of the driving scenario. Save the target actors to a separate variable and inspect the pose of the first target actor.

```
allPoses = actorPoses(scenario);
targetPosesScenarioCoords = allPoses(1:2);
targetPosesScenarioCoords(1)
```

```
ans = struct with fields:
    ActorID: 1
    Position: [10 20 30]
    Velocity: [12 113 14]
    Roll: 22
    Pitch: 25
    Yaw: 54
    AngularVelocity: [24 42 27]
```

Use the `driving.scenario.targetsToEgo` function to convert the target poses to the ego-centric coordinates of the ego actor. Inspect the pose of the first actor.

```
targetPosesEgoCoords = driving.scenario.targetsToEgo(targetPosesScenarioCoords,egoActor);
targetPosesEgoCoords(1)
```

```
ans = struct with fields:
    ActorID: 1
    Position: [7.8415 18.2876 27.1675]
    Velocity: [18.6826 112.0403 9.2960]
    Roll: 16.4327
    Pitch: 23.2186
    Yaw: 47.8114
    AngularVelocity: [-3.3744 47.3021 18.2569]
```

Alternatively, use the `targetPoses` function to obtain all target actor poses in ego vehicle coordinates. Display the first target pose, which matches the previously calculated pose.

```
targetPosesEgoCoords = targetPoses(egoActor);
targetPosesEgoCoords(1)
```

```
ans = struct with fields:
    ActorID: 1
    ClassID: 1
    Position: [7.8415 18.2876 27.1675]
    Velocity: [18.6826 112.0403 9.2960]
    Roll: 16.4327
    Pitch: 23.2186
    Yaw: 47.8114
```

```
AngularVelocity: [-3.3744 47.3021 18.2569]
```

Use the `driving.scenario.targetsToScenario` to convert the target poses back to the world coordinates of the scenario. Display the first target pose, which matches the original target pose.

```
targetPosesScenarioCoords = driving.scenario.targetsToScenario(targetPosesEgoCoords,egoActor);
targetPosesScenarioCoords(1)
```

```
ans = struct with fields:
    ActorID: 1
    ClassID: 1
    Position: [10.0000 20.0000 30.0000]
    Velocity: [12.0000 113.0000 14.0000]
    Roll: 22
    Pitch: 25.0000
    Yaw: 54
    AngularVelocity: [24.0000 42.0000 27.0000]
```

Obtain Target Poses Within Sensor Range

Obtain the poses of targets that are within the maximum range of a sensor mounted to the ego vehicle.

Create a driving scenario. The scenario contains a 75-meter straight road, an ego vehicle, and two target vehicles.

- The nearest target vehicle is 45 meters away and in the same lane as the ego vehicle.
- The farthest target vehicle is 65 meters away and in the opposite lane of the ego vehicle.

Plot the driving scenario.

```
scenario = drivingScenario;

roadCenters = [0 0 0; 75 0 0];
laneSpecification = lanespec([1 1]);
road(scenario,roadCenters,'Lanes',laneSpecification,'Name','Road');

egoVehicle = vehicle(scenario, ...
    'ClassID',1, ...
    'Position',[4 -2 0], ...
    'Name','Ego');

vehicle(scenario, ...
    'ClassID',1, ...
    'Position',[45 -1.7 0], ...
    'Name','Near Target');

vehicle(scenario, ...
    'ClassID',1, ...
    'Position',[65 2 0], ...
    'Yaw',-180, ...
    'Name','Far Target');
```

```
plot(scenario)
```

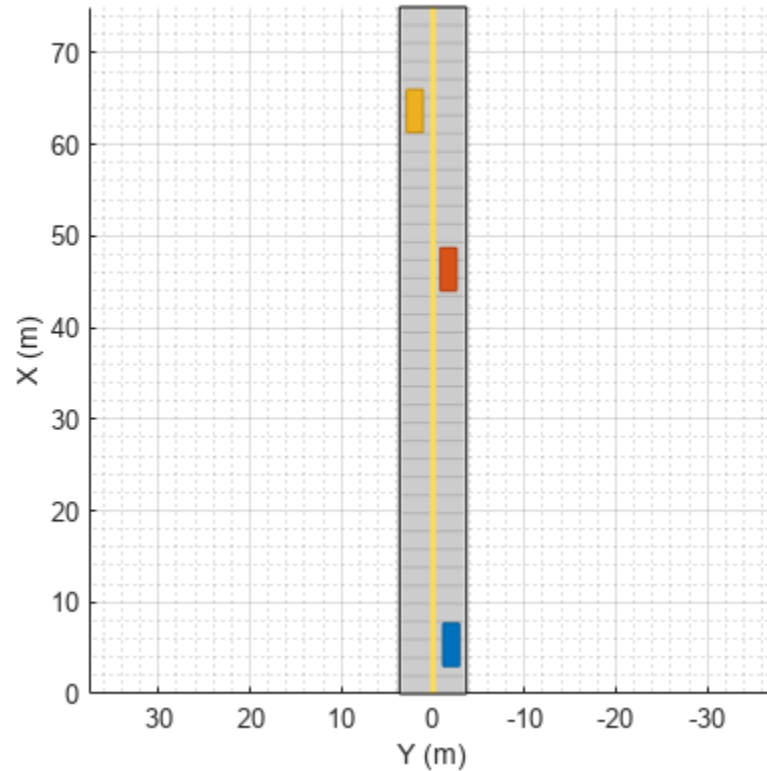

Create a vision sensor mounted to the front bumper of the ego vehicle. Configure the sensor to have a maximum detection range of 50 meters.

```
sensor = visionDetectionGenerator('SensorIndex',1, ...
    'SensorLocation',[3.7 0], ...
    'MaxRange',50);
```

Plot the outlines of the vehicles and the coverage area of the sensor. The nearest target vehicle is within range of the sensor but the farthest target vehicle is not.

```
bep = birdsEyePlot;

olPlotter = outlinePlotter(bep);
[position,yaw,length,width,originOffset,color] = targetOutlines(egoVehicle);
plotOutline(olPlotter,position,yaw,length,width, ...
    'OriginOffset',originOffset,'Color',color)

caPlotter = coverageAreaPlotter(bep,'DisplayName','Coverage area','FaceColor','blue');
mountPosition = sensor.SensorLocation;
range = sensor.MaxRange;
orientation = sensor.Yaw;
fieldOfView = sensor.FieldOfView(1);
plotCoverageArea(caPlotter,mountPosition,range,orientation,fieldOfView);
```

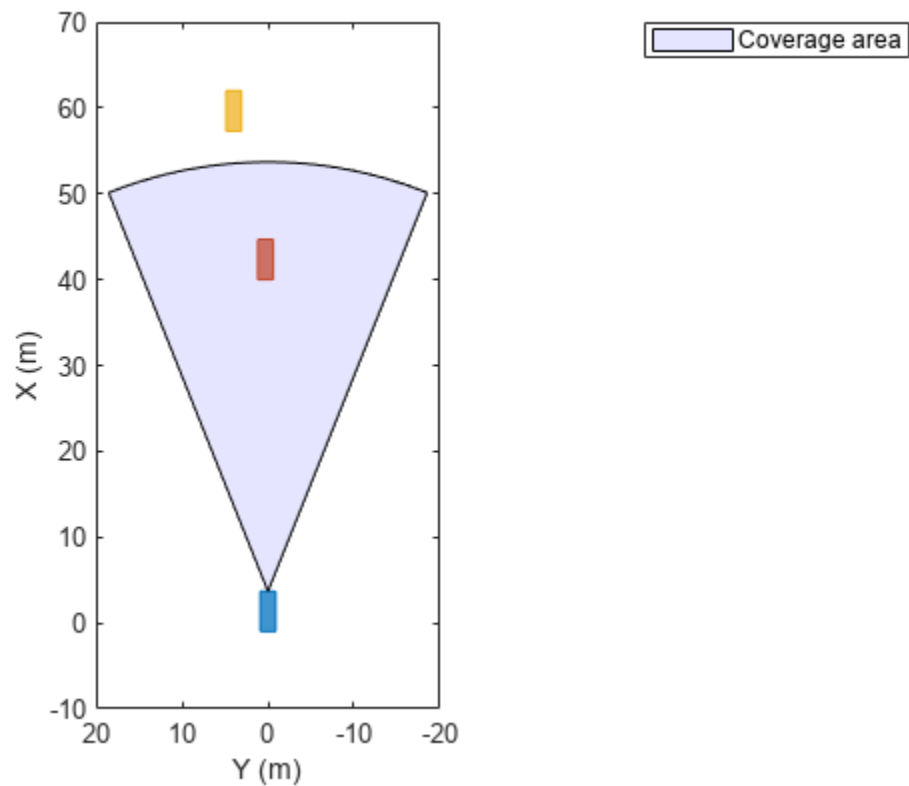
Obtain the poses of targets that are within the range of the sensor. The output structure contains the pose of only the nearest target, which is under 50 meters away from the ego vehicle.

```
poses = targetPoses(egoVehicle,range)
```

```
poses = struct with fields:
    ActorID: 2
    ClassID: 1
    Position: [41 0.3000 0]
    Velocity: [0 0 0]
    Roll: 0
    Pitch: 0
    Yaw: 0
    AngularVelocity: [0 0 0]
```

Add Sensors to Driving Scenario and Get Target Poses Using Sensor Input

In this example, you will add sensors to a driving scenario using the `addSensors` function and get ground-truth target poses based on the individual sensor inputs. Then, you process the ground-truth target poses into detections and visualize them.

Set Up Driving Scenario and Bird's-Eye-Plot

Create a driving scenario with an ego vehicle and two target vehicles. One target vehicle is in the front and the other is to the left of the ego-vehicle.

```
[scenario, egovehicle] = helperCreateDrivingScenario;
```

Configure a vision sensor to be mounted at the front of the ego vehicle.

```
visionSensor = visionDetectionGenerator(SensorIndex=1,SensorLocation=[4.0 0],Height=1.1,Pitch=1.0);
```

Configure an ultrasonic sensor to be mounted at the left side of the ego-vehicle.

```
leftUltrasonic = ultrasonicDetectionGenerator(SensorIndex=2,MountingLocation=[0.5 1 0.2],MountingAngle=90);
```

Create a bird's-eye-plot to visualize the driving scenario.

```
[detPlotter, lmPlotter, olPlotter, lulrdPlotter, luldetPlotter, bepAxes] = helperCreateBEP(visionSensor, leftUltrasonic, scenario, egovehicle);
```

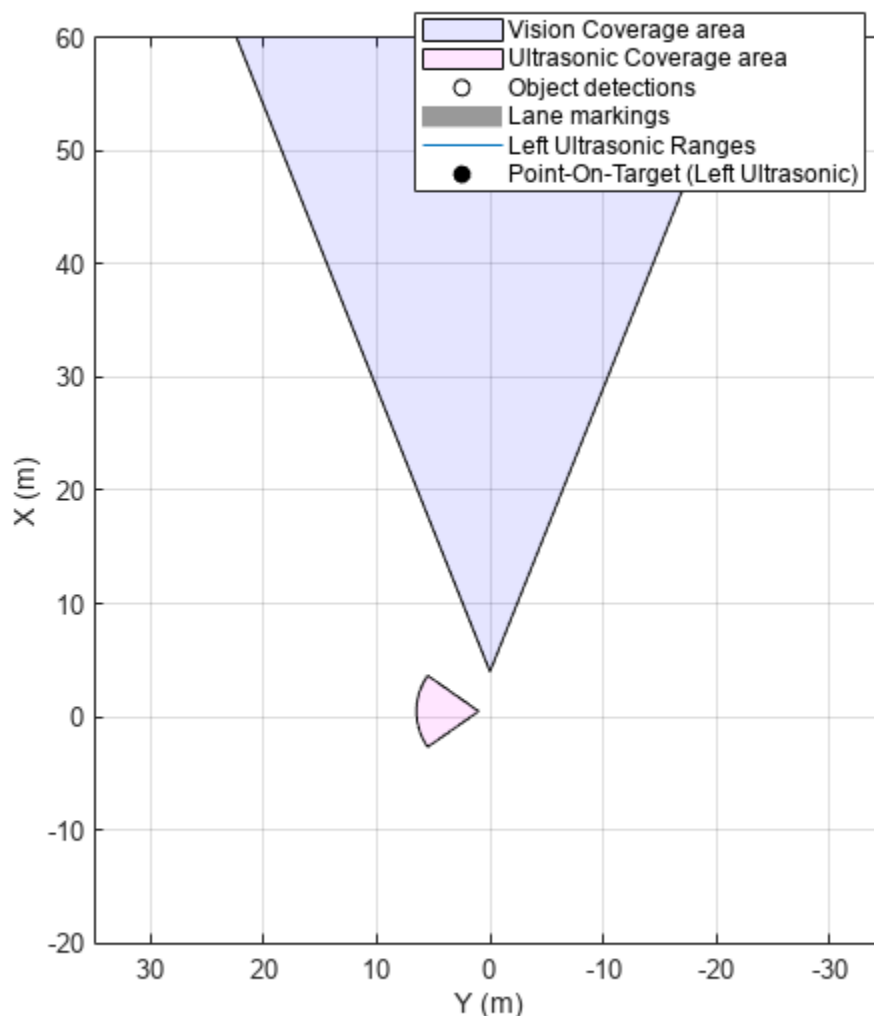

Add Sensors and Simulate Driving Scenario

Add both vision and ultrasonic sensors to the driving scenario using the `addSensors` function. You can add sensors to any vehicle in the driving scenario using the `addSensors` function by specifying the actor ID of the desired vehicle. In this example, specify the ego-vehicle actor ID.

```
addSensors(scenario, {visionSensor, leftUltrasonic}, egovehicle.ActorID);
```

Simulate the driving scenario. Note that you get separate target poses based on individual sensors by specifying their respective sensor IDs as inputs to the `targetPoses` function. This syntax returns the ground-truth poses of targets only within the range of the specified sensor. You then pass the ground-truth poses to their respective sensor models to generate detections and visualize them.

```
legend(bepAxes, 'show')
lookaheadDistance = 0:0.5:60;
while advance(scenario)

    lb = laneBoundaries(egovehicle, 'XDistance', lookaheadDistance, 'LocationType', 'inner');
    [lmv, lmf] = laneMarkingVertices(egovehicle);

    % Get ground-truth poses of targets in the range of vision and ultrasonic sensors separately
    tgtposeVision = targetPoses(scenario, visionSensor.SensorIndex);
    tgtposeUltrasonic = targetPoses(scenario, leftUltrasonic.SensorIndex);

    % Obtain detections based on targets only in range
    [obdets, obValid] = visionSensor(tgtposeVision, scenario.SimulationTime);
    [lobdets, lobValid] = leftUltrasonic(tgtposeUltrasonic, scenario.SimulationTime);

    helperPlotBEPVision(egovehicle, lmv, lmf, obdets, obValid, detPlotter, lmPlotter, olPlotter)
    helperPlotBEPUltrasonic(lobdets, lobValid, leftUltrasonic, lulrdPlotter, luldetPlotter)
end
```

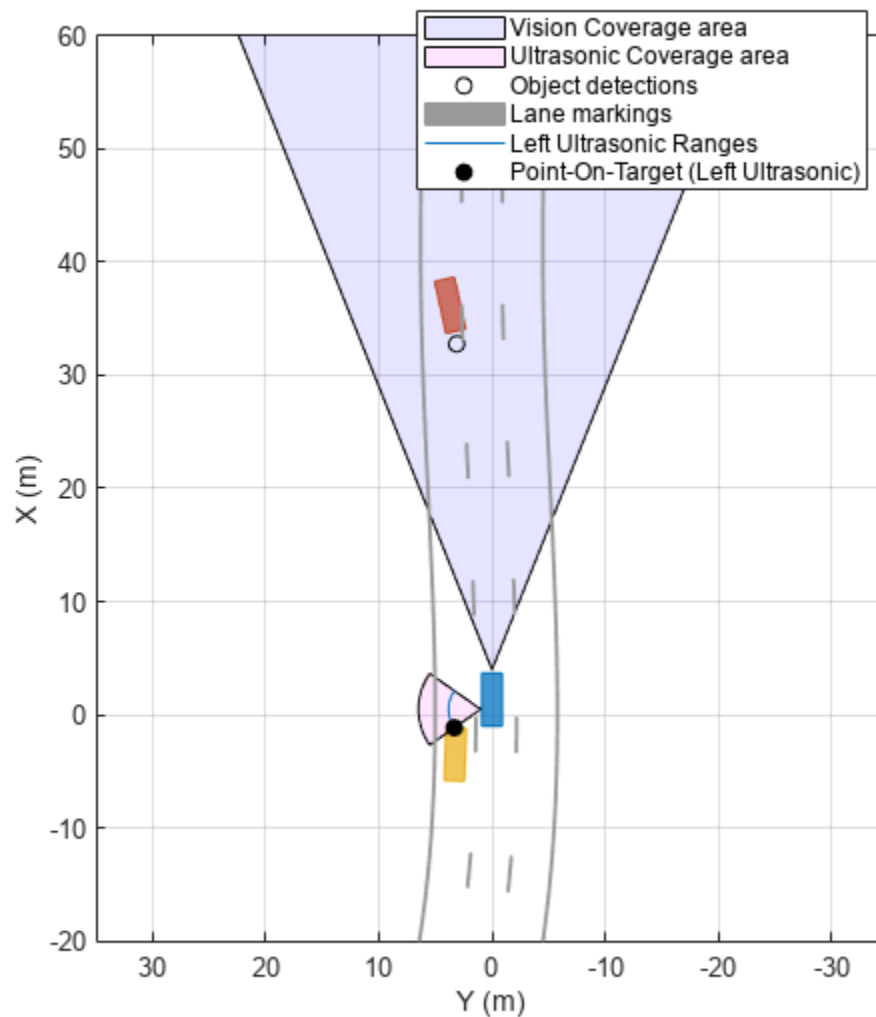

Helper Functions

`helperCreateDrivingScenario` creates a driving scenario by specifying the road and vehicle properties.

```
function [scenario, egovehicle] = helperCreateDrivingScenario
    scenario = drivingScenario;
    roadCenters = [-120 30 0; -60 0 0; 0 0 0; 60 0 0; 120 30 0; 180 60 0];
    lspc = lanespec(3);
    road(scenario, roadCenters, Lanes=lspc);

    % Create an ego vehicle that travels in the center lane at a velocity of 30 m/s.
    egovehicle = vehicle(scenario, ClassID=1);
    egopath = [1.5 0 0; 60 0 0; 111 25 0];
```

```

egospeed = 30;
smoothTrajectory(egovehicle, egopath, egospeed);

% Add a target vehicle that travels ahead of the ego vehicle at 30.5 m/s in the right lane,
ftargetcar = vehicle(scenario, ClassID=1);
ftargetpath = [8 2; 60 -3.2; 120 33];
ftargetspeed = 40;
smoothTrajectory(ftargetcar, ftargetpath, ftargetspeed);

% Add a second target vehicle that travels in the left lane at 32m/s.
ltargetcar = vehicle(scenario, ClassID=1);
ltargetpath = [-5.0 3.5 0; 60 3.5 0; 111 28.5 0];
ltargetspeed = 30;
smoothTrajectory(ltargetcar, ltargetpath, ltargetspeed);
end

```

helperCreateBEP creates a bird's-eye-plot for visualizing the driving scenario simulation.

```

function [detPlotter, lmPlotter, olPlotter, lulrdPlotter, luldetPlotter, bepAxes] = helperCreateBEP(scenario, egoVehicle, egoPath, egoSpeed, targetCar, targetPath, targetSpeed, secondTargetCar, secondTargetPath, secondTargetSpeed)
    figureName = "BEP";
    Figure = findobj('Type', 'Figure', Name=figureName);
    if isempty(Figure)
        screenSize = double(get(groot, 'ScreenSize'));
        Figure = figure(Name=figureName);
        Figure.Position = [screenSize(3)*0.17 screenSize(4)*0.15 screenSize(3)*0.4 screenSize(4)*0.4];
        Figure.NumberTitle = 'off';
        Figure.MenuBar = 'none';
        Figure.ToolBar = 'none';
    end
    clf(Figure);
    bepAxes = axes(Figure);
    grid(bepAxes, 'on');
    legend(bepAxes, 'hide');

    bep = birdsEyePlot(Parent=bepAxes, XLim=[-20 60], YLim=[-35 35]);
    caPlotterV = coverageAreaPlotter(bep, DisplayName="Vision Coverage area", FaceColor="b");
    caPlotterU = coverageAreaPlotter(bep, DisplayName="Ultrasonic Coverage area", FaceColor="m");
    detPlotter = detectionPlotter(bep, DisplayName="Object detections");
    lmPlotter = laneMarkingPlotter(bep, DisplayName="Lane markings");
    olPlotter = outlinePlotter(bep);
    plotCoverageArea(caPlotterV, visionSensor.SensorLocation, ...
        visionSensor.MaxRange, visionSensor.Yaw, ...
        visionSensor.FieldOfView(1));
    plotCoverageArea(caPlotterU, leftUltrasonic.MountingLocation(1:2), ...
        leftUltrasonic.DetectionRange(3), leftUltrasonic.MountingAngles(1), ...
        leftUltrasonic.FieldOfView(1));

    lulrdPlotter = rangeDetectionPlotter(bep, DisplayName="Left Ultrasonic Ranges", LineStyle="-");
    luldetPlotter = detectionPlotter(bep, DisplayName="Point-On-Target (Left Ultrasonic)", MarkerFaceColor="r");
end

```

helperPlotBEPVision plots ego vehicle outlines, lanes and vision detections on the bird's-eye-plot.

```

function helperPlotBEPVision(egovehicle, lmv, lmf, obdets, obValid, detPlotter, lmPlotter, olPlotter)
    plotLaneMarking(lmPlotter, lmv, lmf)

    [objposition, objyaw, objlength, objwidth, objoriginOffset, color] = targetOutlines(egovehicle);
    plotOutline(olPlotter, objposition, objyaw, objlength, objwidth, ...

```

```

        OriginOffset=objoriginOffset,Color=color)
    if obValid
        detPos = cellfun(@(d)d.Measurement(1:2),obdets,UniformOutput=false);
        detPos = vertcat(zeros(0,2),cell2mat(detPos'))';
        plotDetection(detPlotter,detPos)
    end
end

helperPlotBEPUltrasonic plots ultrasonic range measurements and points on targets.

function helperPlotBEPUltrasonic(lobdets,lobValid,leftUltrasonic,lulrdPlotter,luldetPlotter)
    if ~isempty(lobdets) && lobValid
        lranges = lobdets{1}.Measurement;
        plotRangeDetection(lulrdPlotter,lranges,leftUltrasonic.FieldOfView(1),leftUltrasonic.Mour
        plotDetection(luldetPlotter,lobdets{1}.ObjectAttributes{1}.PointOnTarget(1:2)')
    end
end

```

Input Arguments

Obtain target poses based on ego-vehicle actor

ac — Actor

Actor object | Vehicle object

Actor belonging to a drivingScenario object, specified as an Actor or Vehicle object. To create these objects, use the actor and vehicle functions, respectively.

range — Circular range around ego vehicle

nonnegative real scalar

Circular range around the ego vehicle actor, specified as a nonnegative real scalar. The targetPoses function returns only the poses of targets that lie within this range. Units are in meters.

Obtain target poses based on sensor range

scenario — Driving scenario

drivingScenario object

Driving scenario, specified as a drivingScenario object.

sensorID — Unique sensor identifier

1 (default) | positive integer

Unique sensor identifier, specified as a positive integer. This property distinguishes sensors in a multisensor system.

Example: 5

Data Types: double

Output Arguments

poses — Target poses

structure | array of structures

Target poses, in ego vehicle coordinates, returned as a structure or as an array of structures. The pose of the ego vehicle actor, `ac`, is not included.

A target pose defines the position, velocity, and orientation of a target in ego vehicle coordinates. Target poses also include the rates of change in actor position and orientation.

Each pose structure has these fields.

Field	Description
ActorID	Scenario-defined actor identifier, specified as a positive integer.
ClassID	Classification identifier, specified as a nonnegative integer. 0 represents an object of an unknown or unassigned class.
Position	Position of actor, specified as a real-valued vector of the form $[x \ y \ z]$. Units are in meters.
Velocity	Velocity (v) of actor in the x -, y -, and z -directions, specified as a real-valued vector of the form $[v_x \ v_y \ v_z]$. Units are in meters per second.
Roll	Roll angle of actor, specified as a real scalar. Units are in degrees.
Pitch	Pitch angle of actor, specified as a real scalar. Units are in degrees.
Yaw	Yaw angle of actor, specified as a real scalar. Units are in degrees.
AngularVelocity	Angular velocity (ω) of actor in the x -, y -, and z -directions, specified as a real-valued vector of the form $[\omega_x \ \omega_y \ \omega_z]$. Units are in degrees per second.

For full definitions of these structure fields, see the `actor` and `vehicle` functions.

More About

Ego Vehicle and Targets

In a driving scenario, you can specify one actor as the observer of all other actors, similar to how the driver of a car observes all other cars. The observer actor is called the ego actor or, more specifically, the ego vehicle. From the perspective of the ego vehicle, all other actors (such as vehicles and pedestrians) are the observed actors, called targets. Ego vehicle coordinates are centered and oriented with reference to the ego vehicle. The coordinates of the driving scenario are world coordinates.

Version History

Introduced in R2017a

See Also

Objects

drivingScenario

Functions

actor | vehicle | actorPoses | actorProfiles | addSensors

Topics

“Create Driving Scenario Programmatically”

targetOutlines

Package:

Outlines of targets viewed by actor

Syntax

```
[position,yaw,length,width,originOffset,color] = targetOutlines(ac)
[position,yaw,length,width,originOffset,color,numBarrierSegments] =
targetOutlines(ac,'Barriers')
```

Description

`[position,yaw,length,width,originOffset,color] = targetOutlines(ac)` returns the oriented rectangular outlines of all non-ego and non-barrier target actors in a driving scenario. The outlines are as viewed from a designated ego vehicle actor, `ac`. See “Ego Vehicle and Targets” on page 4-508 for more details.

A target outline is the projection of the target actor cuboid into the (x,y) plane of the local coordinate system of the ego vehicle. The target outline components are the `position`, `yaw`, `length`, `width`, `originOffset`, and `color` output arguments.

You can use the returned outlines as input arguments to the outline plotter of a `birdsEyePlot`. First, call the `outlinePlotter` function to create the plotter object. Then, use the `plotOutline` function to plot the outlines of all the actors in a bird's-eye plot.

`[position,yaw,length,width,originOffset,color,numBarrierSegments] = targetOutlines(ac,'Barriers')` returns only the oriented rectangular outlines of all barriers in a driving scenario. The additional output argument `numBarrierSegments` contains the number of segments present in each barrier.

You can use the returned barrier outlines as input arguments to the outline plotter of a `birdsEyePlot`. First, call the `outlinePlotter` function to create the plotter object. Then, use the `plotBarrierOutline` function to plot the outlines of all the barriers in a bird's-eye plot.

Examples

Show Target Outlines in Driving Scenario Simulation

Create a driving scenario and show how target outlines change as the simulation advances.

Create a driving scenario consisting of two intersecting straight roads. The first road segment is 45 meters long. The second straight road is 32 meters long with jersey barriers along both its edges, and intersects the first road. A car traveling at 12.0 meters per second along the first road approaches a running pedestrian crossing the intersection at 2.0 meters per second.

```
scenario = drivingScenario('SampleTime',0.1,'StopTime',1);
road1 = road(scenario,[-10 0 0; 45 -20 0]);
road2 = road(scenario,[-10 -10 0; 35 10 0]);
```

```

barrier(scenario,road1)
barrier(scenario,road1,'RoadEdge','left')
ped = actor(scenario,'ClassID',4,'Length',0.4,'Width',0.6,'Height',1.7);
car = vehicle(scenario,'ClassID',1);
pedspeed = 2.0;
carspeed = 12.0;
smoothTrajectory(ped,[15 -3 0; 15 3 0],pedspeed);
smoothTrajectory(car,[-10 -10 0; 35 10 0],carspeed);

```

Create an ego-centric chase plot for the vehicle.

```
chasePlot(car,'Centerline','on')
```

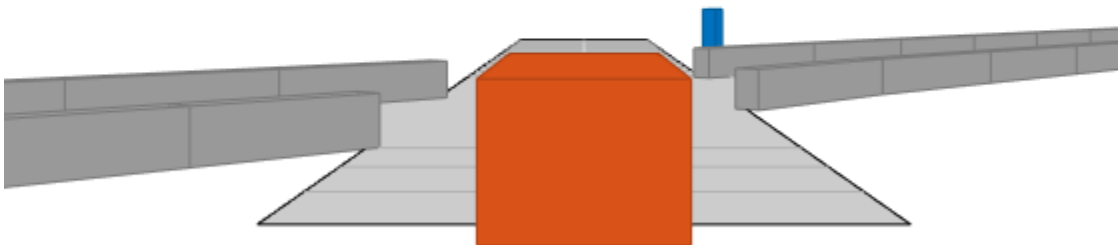

Create an empty bird's-eye plot and add an outline plotter and lane boundary plotter. Then, run the simulation. At each simulation step:

- Update the chase plot to display the road boundaries and target outlines.
- Update the bird's-eye plot to display the updated road boundaries and target outlines. The plot perspective is always with respect to the ego vehicle.

```

bepPlot = birdsEyePlot('XLim',[-50 50],'YLim',[-40 40]);
outlineplotter = outlinePlotter(bepPlot);
laneplotter = laneBoundaryPlotter(bepPlot);
legend('off')

```

```

while advance(scenario)
    rb = roadBoundaries(car);

```

```
[position,yaw,length,width,originOffset,color] = targetOutlines(car);  
[bposition,byaw,blength,bwidth,boriginOffset,bcolor,barrierSegments] = targetOutlines(car,'B');  
plotLaneBoundary(laneplotter,rb)  
plotOutline(outlineplotter,position,yaw,length,width, ...  
    'OriginOffset',originOffset,'Color',color)  
plotBarrierOutline(outlineplotter,barrierSegments,bposition,byaw,blength,bwidth, ...  
    'OriginOffset',boriginOffset,'Color',bcolor)  
pause(0.01)  
end
```

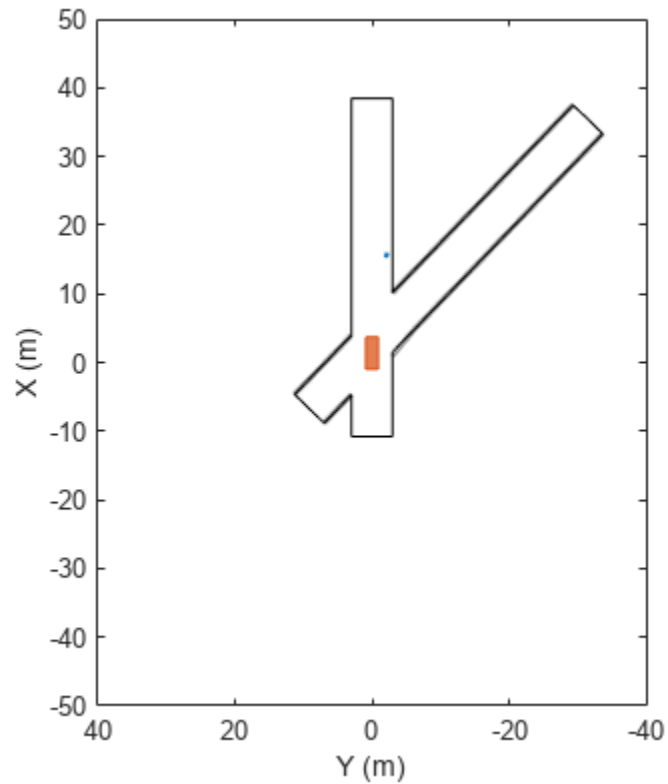

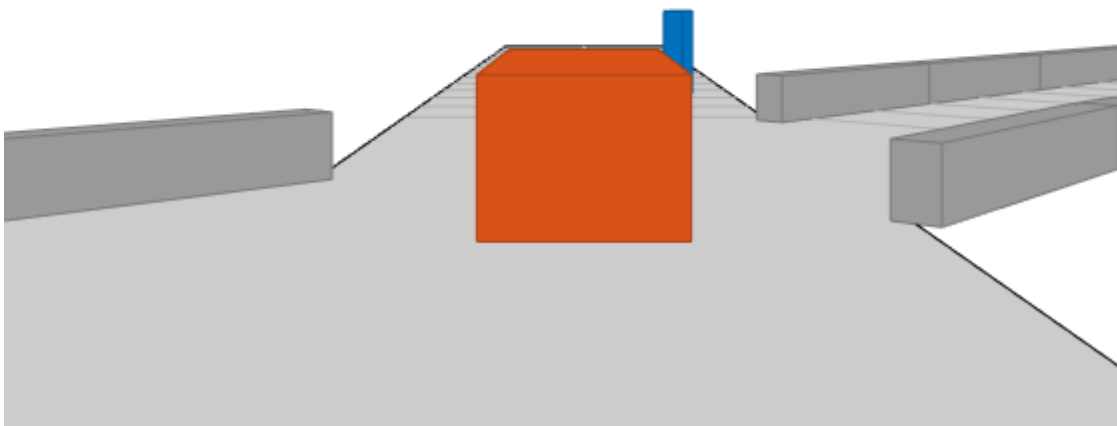

Input Arguments

ac — Actor

Actor object | Vehicle object

Actor belonging to a `drivingScenario` object, specified as an `Actor` or `Vehicle` object. To create these objects, use the `actor` and `vehicle` functions, respectively.

Output Arguments

position — Rotational centers of targets

real-valued N -by-2 matrix

Rotational centers of targets, returned as a real-valued N -by-2 matrix. N is the number of targets. Each row contains the x - and y -coordinates of the rotational center of a target. Units are in meters.

yaw — Yaw angles of targets

real-valued N -element vector

Yaw angles of targets about the rotational center, returned as a real-valued N -element vector. N is the number of targets. Yaw angles are measured in the counterclockwise direction, as seen from above. Units are in degrees.

length — Lengths of rectangular outlines of targetspositive, real-valued N -element vector

Lengths of rectangular outlines of targets, returned as a positive, real-valued N -element vector. N is the number of targets. Units are in meters.

width — Widths of rectangular outlines of targetspositive, real-valued N -element vector

Widths of rectangular outline of targets, returned as a positive, real-valued N -element vector. N is the number of targets. Units are in meters.

originOffset — Offsets of rotational centers from geometric centersreal-valued N -by-2 matrix

Offset of the rotational centers of targets from their geometric centers, returned as a real-valued N -by-2 matrix. N is the number of targets. Each row contains the x - and y -coordinates defining this offset. In vehicle targets, the rotational center, or origin, is located on the ground, directly beneath the center of the rear axle. Units are in meters.

color — RGB representation of target colorsnonnegative, real-valued N -by-3 matrix

RGB representation of target colors, returned as a nonnegative, real-valued N -by-3 matrix. N is the number of target actors.

numBarrierSegments — Number of barrier segments in each barriernonnegative, real-valued N -by-1 vector

Number of barrier segments in each barrier, returned as a nonnegative, real-valued N -by-1 vector. N is the number of barriers in the scenario. This argument is returned only when the 'Barriers' flag is provided as input.

More About

Ego Vehicle and Targets

In a driving scenario, you can specify one actor as the observer of all other actors, similar to how the driver of a car observes all other cars. The observer actor is called the ego actor or, more specifically, the ego vehicle. From the perspective of the ego vehicle, all other actors (such as vehicles and pedestrians) are the observed actors, called targets. Ego vehicle coordinates are centered and oriented with reference to the ego vehicle. The coordinates of the driving scenario are world coordinates.

Version History

Introduced in R2017a

See Also

Objects

drivingScenario | birdsEyePlot

Functions

targetPoses | plotOutline | plotBarrierOutline | actorPoses | actor | vehicle |
outlinePlotter

Topics

“Create Driving Scenario Programmatically”

driving.scenario.targetsToEgo

Convert target poses from scenario to ego coordinates

Syntax

```
targetPosesEgoCoords = driving.scenario.targetsToEgo(
targetPosesScenarioCoords,egoPose)
targetPosesEgoCoords = driving.scenario.targetsToEgo(
targetPosesScenarioCoords,egoActor)
```

Description

`targetPosesEgoCoords = driving.scenario.targetsToEgo(targetPosesScenarioCoords,egoPose)` converts the poses of target actors from the world coordinates of a driving scenario to the coordinate system relative to the pose of an ego actor. A pose is the position, velocity, and orientation of an actor. For more details on the coordinate systems of actors, see “Ego Vehicle and Targets” on page 4-514.

`targetPosesEgoCoords = driving.scenario.targetsToEgo(targetPosesScenarioCoords,egoActor)` converts target poses by using the pose of the specified ego actor.

Examples

Convert Target Poses Between Ego Vehicle and Scenario Coordinates

In a simple driving scenario, obtain the poses of target vehicles in the coordinate system of the ego vehicle. Then convert these poses back to the world coordinates of the driving scenario.

Create a driving scenario.

```
scenario = drivingScenario;
```

Create target actors.

```
actor(scenario, 'ClassID',1, ...
    'Position',[10 20 30], ...
    'Velocity',[12 113 14], ...
    'Yaw',54, ...
    'Pitch',25, ...
    'Roll',22, ...
    'AngularVelocity',[24 42 27]);

actor(scenario, 'ClassID',1, ...
    'Position',[17 22 12], ...
    'Velocity',[19 13 15], ...
    'Yaw',45, ...
    'Pitch',52, ...
    'Roll',2, ...
    'AngularVelocity',[42 24 29]);
```

Add an ego vehicle actor.

```
egoActor = actor(scenario, 'ClassID',1, ...
    'Position',[1 2 3], ...
    'Velocity',[1.2 1.3 1.4], ...
    'Yaw',4, ...
    'Pitch',5, ...
    'Roll',2, ...
    'AngularVelocity',[4 2 7]);
```

Use the `actorPoses` function to return the poses of all actors in the scenario. Pose properties (position, velocity, and orientation) are in the world coordinates of the driving scenario. Save the target actors to a separate variable and inspect the pose of the first target actor.

```
allPoses = actorPoses(scenario);
targetPosesScenarioCoords = allPoses(1:2);
targetPosesScenarioCoords(1)
```

```
ans = struct with fields:
    ActorID: 1
    Position: [10 20 30]
    Velocity: [12 113 14]
    Roll: 22
    Pitch: 25
    Yaw: 54
    AngularVelocity: [24 42 27]
```

Use the `driving.scenario.targetsToEgo` function to convert the target poses to the ego-centric coordinates of the ego actor. Inspect the pose of the first actor.

```
targetPosesEgoCoords = driving.scenario.targetsToEgo(targetPosesScenarioCoords,egoActor);
targetPosesEgoCoords(1)
```

```
ans = struct with fields:
    ActorID: 1
    Position: [7.8415 18.2876 27.1675]
    Velocity: [18.6826 112.0403 9.2960]
    Roll: 16.4327
    Pitch: 23.2186
    Yaw: 47.8114
    AngularVelocity: [-3.3744 47.3021 18.2569]
```

Alternatively, use the `targetPoses` function to obtain all target actor poses in ego vehicle coordinates. Display the first target pose, which matches the previously calculated pose.

```
targetPosesEgoCoords = targetPoses(egoActor);
targetPosesEgoCoords(1)
```

```
ans = struct with fields:
    ActorID: 1
    ClassID: 1
    Position: [7.8415 18.2876 27.1675]
    Velocity: [18.6826 112.0403 9.2960]
    Roll: 16.4327
    Pitch: 23.2186
    Yaw: 47.8114
```

```
AngularVelocity: [-3.3744 47.3021 18.2569]
```

Use the `driving.scenario.targetsToScenario` to convert the target poses back to the world coordinates of the scenario. Display the first target pose, which matches the original target pose.

```
targetPosesScenarioCoords = driving.scenario.targetsToScenario(targetPosesEgoCoords, egoActor);
targetPosesScenarioCoords(1)
```

```
ans = struct with fields:
    ActorID: 1
    ClassID: 1
    Position: [10.0000 20.0000 30.0000]
    Velocity: [12.0000 113.0000 14.0000]
    Roll: 22
    Pitch: 25.0000
    Yaw: 54
    AngularVelocity: [24.0000 42.0000 27.0000]
```

Input Arguments

targetPosesScenarioCoords — Target poses in world coordinates of scenario

structure | array of structures

Target poses in the world coordinates of a driving scenario, specified as a structure or an array of structures.

Each target pose structure must contain at least these fields.

Field	Description
ActorID	Scenario-defined actor identifier, specified as a positive integer.
Position	Position of actor, specified as a real-valued vector of the form $[x\ y\ z]$. Units are in meters.
Velocity	Velocity (v) of actor in the x -, y -, and z -directions, specified as a real-valued vector of the form $[v_x\ v_y\ v_z]$. Units are in meters per second.
Roll	Roll angle of actor, specified as a real-valued scalar. Units are in degrees.
Pitch	Pitch angle of actor, specified as a real-valued scalar. Units are in degrees.
Yaw	Yaw angle of actor, specified as a real-valued scalar. Units are in degrees.
AngularVelocity	Angular velocity (ω) of actor in the x -, y -, and z -directions, specified as a real-valued vector of the form $[\omega_x\ \omega_y\ \omega_z]$. Units are in degrees per second.

For full definitions of these structure fields, see the `actor` and `vehicle` functions.

egoPose — Ego actor pose

structure

Ego actor pose in the world coordinates of a driving scenario, specified as a structure.

The ego actor pose structure must contain at least these fields.

Field	Description
ActorID	Scenario-defined actor identifier, specified as a positive integer.
Position	Position of actor, specified as a real-valued vector of the form $[x\ y\ z]$. Units are in meters.
Velocity	Velocity (v) of actor in the x - y -, and z -directions, specified as a real-valued vector of the form $[v_x\ v_y\ v_z]$. Units are in meters per second.
Roll	Roll angle of actor, specified as a real-valued scalar. Units are in degrees.
Pitch	Pitch angle of actor, specified as a real-valued scalar. Units are in degrees.
Yaw	Yaw angle of actor, specified as a real-valued scalar. Units are in degrees.
AngularVelocity	Angular velocity (ω) of actor in the x -, y -, and z -directions, specified as a real-valued vector of the form $[\omega_x\ \omega_y\ \omega_z]$. Units are in degrees per second.

For full definitions of these structure fields, see the `actor` and `vehicle` functions.

egoActor — Ego actor

Actor object | Vehicle object

Ego actor in the world coordinates of a driving scenario, specified as an `Actor` or `Vehicle` object. The function converts the coordinates of target actors relative to the pose of `egoActor`. The pose information is stored in the `Position`, `Velocity`, `Roll`, `Pitch`, `Yaw`, and `AngularVelocity` properties of the ego actor.

For the full definitions of pose properties, see the `actor` and `vehicle` functions.

Output Arguments**targetPosesEgoCoords — Target poses in ego actor coordinates**

structure | array of structures

Target poses in ego vehicle coordinates, returned as a structure or an array of structures.

At a minimum, each returned target pose structure has these fields.

Field	Description
ActorID	Scenario-defined actor identifier, specified as a positive integer.

Field	Description
Position	Position of actor, specified as a real-valued vector of the form $[x\ y\ z]$. Units are in meters.
Velocity	Velocity (v) of actor in the x - y -, and z -directions, specified as a real-valued vector of the form $[v_x\ v_y\ v_z]$. Units are in meters per second.
Roll	Roll angle of actor, specified as a real-valued scalar. Units are in degrees.
Pitch	Pitch angle of actor, specified as a real-valued scalar. Units are in degrees.
Yaw	Yaw angle of actor, specified as a real-valued scalar. Units are in degrees.
AngularVelocity	Angular velocity (ω) of actor in the x -, y -, and z -directions, specified as a real-valued vector of the form $[\omega_x\ \omega_y\ \omega_z]$. Units are in degrees per second.

The returned `targetPosesEgoCoords` structures include the same fields as those in the input `targetPosesScenarioCoords` structures. For example, if the input structures include a `ClassID` field, then the returned structures also include `ClassID`.

For full definitions of these structure fields, see the `actor` and `vehicle` functions.

More About

Ego Vehicle and Targets

In a driving scenario, you can specify one actor as the observer of all other actors, similar to how the driver of a car observes all other cars. The observer actor is called the ego actor or, more specifically, the ego vehicle. From the perspective of the ego vehicle, all other actors (such as vehicles and pedestrians) are the observed actors, called targets. Ego vehicle coordinates are centered and oriented with reference to the ego vehicle. The coordinates of the driving scenario are world coordinates.

Version History

Introduced in R2017a

See Also

Objects

`drivingScenario`

Functions

`targetPoses` | `actorPoses` | `road` | `roadBoundaries` |
`driving.scenario.roadBoundariesToEgo` | `driving.scenario.targetsToScenario` |
`vehicle` | `actor`

driving.scenario.targetsToScenario

Convert target poses from ego to scenario coordinates

Syntax

```
targetPosesScenarioCoords = driving.scenario.targetsToScenario(
targetPosesEgoCoords,egoPose)
targetPosesScenarioCoords = driving.scenario.targetsToScenario(
targetPosesEgoCoords,egoActor)
```

Description

`targetPosesScenarioCoords = driving.scenario.targetsToScenario(targetPosesEgoCoords,egoPose)` converts the poses of target actors from coordinates relative to the pose of an ego actor to the world coordinates of a driving scenario. A pose is the position, velocity, and orientation of an actor. For more details on the coordinate systems of actors, see “Ego Vehicle and Targets” on page 4-519.

`targetPosesScenarioCoords = driving.scenario.targetsToScenario(targetPosesEgoCoords,egoActor)` converts target poses by using the pose of the specified ego actor.

Examples

Convert Target Poses Between Ego Vehicle and Scenario Coordinates

In a simple driving scenario, obtain the poses of target vehicles in the coordinate system of the ego vehicle. Then convert these poses back to the world coordinates of the driving scenario.

Create a driving scenario.

```
scenario = drivingScenario;
```

Create target actors.

```
actor(scenario, 'ClassID',1, ...
    'Position',[10 20 30], ...
    'Velocity',[12 113 14], ...
    'Yaw',54, ...
    'Pitch',25, ...
    'Roll',22, ...
    'AngularVelocity',[24 42 27]);

actor(scenario, 'ClassID',1, ...
    'Position',[17 22 12], ...
    'Velocity',[19 13 15], ...
    'Yaw',45, ...
    'Pitch',52, ...
    'Roll',2, ...
    'AngularVelocity',[42 24 29]);
```

Add an ego vehicle actor.

```
egoActor = actor(scenario, 'ClassID',1, ...
    'Position',[1 2 3], ...
    'Velocity',[1.2 1.3 1.4], ...
    'Yaw',4, ...
    'Pitch',5, ...
    'Roll',2, ...
    'AngularVelocity',[4 2 7]);
```

Use the `actorPoses` function to return the poses of all actors in the scenario. Pose properties (position, velocity, and orientation) are in the world coordinates of the driving scenario. Save the target actors to a separate variable and inspect the pose of the first target actor.

```
allPoses = actorPoses(scenario);
targetPosesScenarioCoords = allPoses(1:2);
targetPosesScenarioCoords(1)
```

```
ans = struct with fields:
    ActorID: 1
    Position: [10 20 30]
    Velocity: [12 113 14]
    Roll: 22
    Pitch: 25
    Yaw: 54
    AngularVelocity: [24 42 27]
```

Use the `driving.scenario.targetsToEgo` function to convert the target poses to the ego-centric coordinates of the ego actor. Inspect the pose of the first actor.

```
targetPosesEgoCoords = driving.scenario.targetsToEgo(targetPosesScenarioCoords,egoActor);
targetPosesEgoCoords(1)
```

```
ans = struct with fields:
    ActorID: 1
    Position: [7.8415 18.2876 27.1675]
    Velocity: [18.6826 112.0403 9.2960]
    Roll: 16.4327
    Pitch: 23.2186
    Yaw: 47.8114
    AngularVelocity: [-3.3744 47.3021 18.2569]
```

Alternatively, use the `targetPoses` function to obtain all target actor poses in ego vehicle coordinates. Display the first target pose, which matches the previously calculated pose.

```
targetPosesEgoCoords = targetPoses(egoActor);
targetPosesEgoCoords(1)
```

```
ans = struct with fields:
    ActorID: 1
    ClassID: 1
    Position: [7.8415 18.2876 27.1675]
    Velocity: [18.6826 112.0403 9.2960]
    Roll: 16.4327
    Pitch: 23.2186
    Yaw: 47.8114
```

```
AngularVelocity: [-3.3744 47.3021 18.2569]
```

Use the `driving.scenario.targetsToScenario` to convert the target poses back to the world coordinates of the scenario. Display the first target pose, which matches the original target pose.

```
targetPosesScenarioCoords = driving.scenario.targetsToScenario(targetPosesEgoCoords, egoActor);
targetPosesScenarioCoords(1)
```

```
ans = struct with fields:
    ActorID: 1
    ClassID: 1
    Position: [10.0000 20.0000 30.0000]
    Velocity: [12.0000 113.0000 14.0000]
    Roll: 22
    Pitch: 25.0000
    Yaw: 54
    AngularVelocity: [24.0000 42.0000 27.0000]
```

Input Arguments

targetPosesEgoCoords — Target poses in ego actor coordinates

structure | array of structures

Target poses in ego actor coordinates, specified as a structure or an array of structures.

Each target pose structure must contain at least these fields.

Field	Description
ActorID	Scenario-defined actor identifier, specified as a positive integer.
Position	Position of actor, specified as a real-valued vector of the form $[x\ y\ z]$. Units are in meters.
Velocity	Velocity (v) of actor in the x -, y -, and z -directions, specified as a real-valued vector of the form $[v_x\ v_y\ v_z]$. Units are in meters per second.
Roll	Roll angle of actor, specified as a real-valued scalar. Units are in degrees.
Pitch	Pitch angle of actor, specified as a real-valued scalar. Units are in degrees.
Yaw	Yaw angle of actor, specified as a real-valued scalar. Units are in degrees.
AngularVelocity	Angular velocity (ω) of actor in the x -, y -, and z -directions, specified as a real-valued vector of the form $[\omega_x\ \omega_y\ \omega_z]$. Units are in degrees per second.

For full definitions of these structure fields, see the `actor` and `vehicle` functions.

egoPose — Ego actor pose

structure

Ego actor pose in the world coordinates of a driving scenario, specified as a structure.

The ego actor pose structure must contain at least these fields.

Field	Description
ActorID	Scenario-defined actor identifier, specified as a positive integer.
Position	Position of actor, specified as a real-valued vector of the form $[x\ y\ z]$. Units are in meters.
Velocity	Velocity (v) of actor in the x - y -, and z -directions, specified as a real-valued vector of the form $[v_x\ v_y\ v_z]$. Units are in meters per second.
Roll	Roll angle of actor, specified as a real-valued scalar. Units are in degrees.
Pitch	Pitch angle of actor, specified as a real-valued scalar. Units are in degrees.
Yaw	Yaw angle of actor, specified as a real-valued scalar. Units are in degrees.
AngularVelocity	Angular velocity (ω) of actor in the x -, y -, and z -directions, specified as a real-valued vector of the form $[\omega_x\ \omega_y\ \omega_z]$. Units are in degrees per second.

For full definitions of these structure fields, see the `actor` and `vehicle` functions.

egoActor – Ego actor

Actor object | Vehicle object

Ego actor in the world coordinates of a driving scenario, specified as an Actor or Vehicle object. The function converts the coordinates of target actors relative to the pose of egoActor. The pose information is stored in the Position, Velocity, Roll, Pitch, Yaw, and AngularVelocity properties of the ego actor.

For the full definitions of pose properties, see the `actor` and `vehicle` functions.

Output Arguments

targetPosesScenarioCoords – Target poses in world coordinates of scenario

structure | array of structures

Target actor poses in the world coordinates of a driving scenario, returned as a structure or an array of structures.

At a minimum, each returned target pose structure has these fields.

Field	Description
ActorID	Scenario-defined actor identifier, specified as a positive integer.
Position	Position of actor, specified as a real-valued vector of the form $[x\ y\ z]$. Units are in meters.

Field	Description
Velocity	Velocity (v) of actor in the x - y -, and z -directions, specified as a real-valued vector of the form $[v_x v_y v_z]$. Units are in meters per second.
Roll	Roll angle of actor, specified as a real-valued scalar. Units are in degrees.
Pitch	Pitch angle of actor, specified as a real-valued scalar. Units are in degrees.
Yaw	Yaw angle of actor, specified as a real-valued scalar. Units are in degrees.
AngularVelocity	Angular velocity (ω) of actor in the x -, y -, and z -directions, specified as a real-valued vector of the form $[\omega_x \omega_y \omega_z]$. Units are in degrees per second.

The returned `targetPosesScenarioCoords` structures include the same fields as those in the input `targetPosesEgoCoords` structures. For example, if the input structures include a `ClassID` field, then the returned structures also include `ClassID`.

For full definitions of these structure fields, see the `actor` and `vehicle` functions.

More About

Ego Vehicle and Targets

In a driving scenario, you can specify one actor as the observer of all other actors, similar to how the driver of a car observes all other cars. The observer actor is called the ego actor or, more specifically, the ego vehicle. From the perspective of the ego vehicle, all other actors (such as vehicles and pedestrians) are the observed actors, called targets. Ego vehicle coordinates are centered and oriented with reference to the ego vehicle. The coordinates of the driving scenario are world coordinates.

Version History

Introduced in R2020a

See Also

Objects

`drivingScenario`

Functions

`targetPoses` | `actorPoses` | `road` | `roadBoundaries` | `driving.scenario.roadBoundariesToEgo` | `driving.scenario.targetsToEgo` | `actor` | `vehicle`

path

(To be removed) Create actor or vehicle path in driving scenario

Note path will be removed in a future release. Use `trajectory` instead.

Syntax

```
path(ac, waypoints)
path(ac, waypoints, speed)
```

Description

`path(ac, waypoints)` creates a path for an actor or vehicle, `ac`, using a set of waypoints. The actor follows the path at 30 m/s.

`path(ac, waypoints, speed)` also specifies the actor speed.

Input Arguments

ac — Actor

Actor object | Vehicle object

Actor belonging to a `drivingScenario` object, specified as an `Actor` or `Vehicle` object. To create these objects, use the `actor` and `vehicle` functions, respectively.

waypoints — Path waypoints

real-valued N -by-2 matrix | real-valued N -by-3 matrix

Path waypoints, specified as a real-valued N -by-2 or N -by-3 matrix, where N is the number of waypoints.

- If you specify the waypoints as an N -by-2 matrix, then each matrix row represents the (x,y) coordinates of a waypoint. The z -coordinate of each waypoint is zero.
- If you specify the waypoints as an N -by-3 matrix, then each matrix row represents the (x,y,z) coordinates of a waypoint.

All coordinates belong to the scenario coordinate system. Units are in meters.

Example: `[1 0 0; 2 7 7]`

speed — Actor speed

30.0 | positive real scalar | N -element vector of nonnegative values

Actor speed, specified as a positive real scalar or N -element vector of nonnegative values. N is the number of waypoints.

- When `speed` is a scalar, the speed is constant throughout the actor motion.
- When `speed` is a vector, the vector values specify the speed at each waypoint.

Speeds are interpolated between waypoints. `speed` can be zero at any waypoint but cannot be zero at two consecutive waypoints. Units are in meters per second.

Example: `[10,8,10,11]`

Algorithms

The `path` function creates a path for an actor to follow in a scenario. You specify the path using N two-dimensional or three-dimensional waypoints. Each of the $N - 1$ segments between waypoints defines a curve whose curvature varies linearly with distance along the segment. The function fits a piecewise clothoid curve to the (x,y) coordinates of the waypoints by matching the curvature on both sides of the waypoint. For a nonclosed curve, the curvature at the first and last waypoint is zero. If the first and last waypoints coincide, then the curvatures before and after the endpoints are matched. The z -coordinates of the path are interpolated using a shape-preserving piecewise cubic curve.

You can specify speed as a scalar or a vector. When speed is a scalar, the actor follows the path with constant speed. When speed is an N -element vector, speed is linearly interpolated between waypoints. Setting the speed to zero at two consecutive waypoints creates a stationary actor.

Version History

Introduced in R2017a

R2018a: path is not recommended

Not recommended starting in R2018a

`path` will be removed in a future release. Use `trajectory` instead.

Update Code

Replace all instances of `path` with `trajectory`. If you used `path` without specifying a speed, you must now specify one. The `trajectory` function does not include a syntax that assumes a default speed.

Discouraged Usage	Recommended Replacement
<pre>scenario = drivingScenario; road(scenario,[-10 0 0; 45 -20 0]); car = vehicle(scenario); waypoints = [-10 -10 0; 35 10 0]; path(car,waypoints) % default speed = 30 m/s</pre>	<pre>scenario = drivingScenario; road(scenario,[-10 0 0; 45 -20 0]); car = vehicle(scenario); waypoints = [-10 -10 0; 35 10 0]; speed = 30; trajectory(car,waypoints,speed)</pre>

See Also

`trajectory`

road

Add road to driving scenario or road group

Syntax

```
road(scenario, roadcenters)
road(scenario, roadcenters, roadwidth)
road(scenario, roadcenters, roadwidth, bankingangle)
road(scenario, roadcenters, 'Lanes', lspec)
road(scenario, roadcenters, bankingangle, 'Lanes', lspec)
road( ____, 'Heading', roadheadings)
road( ____, 'Name', name)
rd = road( ____ )

road(rg, roadcenters)
road(rg, roadcenters, roadwidth)
road(rg, roadcenters, roadwidth, bankingangle)
road(rg, roadcenters, 'Lanes', lspec)
road(rg, roadcenters, bankingangle, 'Lanes', lspec)
road( ____, 'Heading', roadheadings)
road( ____, 'Name', name)
```

Description

Add Roads To Driving Scenario

`road(scenario, roadcenters)` adds a road to a driving scenario, `scenario`. You specify the road shape and the orientation of a road in the 2-D plane by using a set of road centers, `roadcenters`, at discrete points. When you specify the number of lanes on a road, the lanes are numbered with respect to the road centers. For more information, see “Draw Direction of Road and Numbering of Lanes” on page 4-543.

`road(scenario, roadcenters, roadwidth)` adds a road with the specified width, `roadwidth`.

`road(scenario, roadcenters, roadwidth, bankingangle)` adds a road with the specified width and banking angle, `bankingangle`.

`road(scenario, roadcenters, 'Lanes', lspec)` adds a road with the specified lanes, `lspec`.

`road(scenario, roadcenters, bankingangle, 'Lanes', lspec)` adds a road with the specified banking angle and lanes.

`road(____, 'Heading', roadheadings)` adds a road with the specified heading angle `roadheadings`, using any of the input argument combinations from previous syntaxes.

`road(____, 'Name', name)` specifies the name of the road.

`rd = road(____)` returns a Road object that stores the properties of the created road.

Add Roads to Road Group

`road(rg, roadcenters)` adds a road segment to a road group, `rg`. Use a road group to create a road junction or intersection. You specify the shape and the orientation of the road segment in the 2-

D plane by using a set of road centers, `roadcenters`, at discrete points. When you specify the number of lanes on a road segment, the lanes are numbered with respect to the road centers. For more information, see “Draw Direction of Road and Numbering of Lanes” on page 4-543.

`road(rg, roadcenters, roadwidth)` adds a road segment with the specified width, `roadwidth`, to the road group.

`road(rg, roadcenters, roadwidth, bankingangle)` adds a road segment with the specified width and banking angle, `bankingangle`, to the road group.

`road(rg, roadcenters, 'Lanes', lspec)` adds a road segment with the specified lanes, `lspec`, to the road group.

`road(rg, roadcenters, bankingangle, 'Lanes', lspec)` adds a road segment with the specified banking angle and lanes to the road group.

`road(____, 'Heading', roadheadings)` adds a road segment with the specified heading angle `roadheadings` to the road group, using any of the input argument combinations from previous syntaxes.

`road(____, 'Name', name)` specifies the name of the road segment.

Examples

Create Driving Scenario with Multiple Actors and Roads

Create a driving scenario containing a curved road, two straight roads, and two actors: a car and a bicycle. Both actors move along the road for 60 seconds.

Create the driving scenario object.

```
scenario = drivingScenario('SampleTime',0.1,'StopTime',60);
```

Create the curved road using road center points following the arc of a circle with an 800-meter radius. The arc starts at 0°, ends at 90°, and is sampled at 5° increments.

```
angs = [0:5:90]';
R = 800;
roadcenters = R*[cosd(angs) sind(angs) zeros(size(angs))];
roadwidth = 10;
cr = road(scenario, roadcenters, roadwidth);
```

Add two straight roads with the default width, using road center points at each end. To the first straight road add barriers on both road edges.

```
roadcenters = [700 0 0; 100 0 0];
sr1 = road(scenario, roadcenters);
barrier(scenario, sr1)
barrier(scenario, sr1, 'RoadEdge', 'left')
roadcenters = [400 400 0; 0 0 0];
road(scenario, roadcenters);
```

Get the road boundaries.

```
rbdry = roadBoundaries(scenario);
```

Add a car and a bicycle to the scenario. Position the car at the beginning of the first straight road.

```
car = vehicle(scenario,'ClassID',1,'Position',[700 0 0], ...
    'Length',3,'Width',2,'Height',1.6);
```

Position the bicycle farther down the road.

```
bicycle = actor(scenario,'ClassID',3,'Position',[706 376 0]', ...
    'Length',2,'Width',0.45,'Height',1.5);
```

Plot the scenario.

```
plot(scenario,'Centerline','on','RoadCenters','on');
title('Scenario');
```

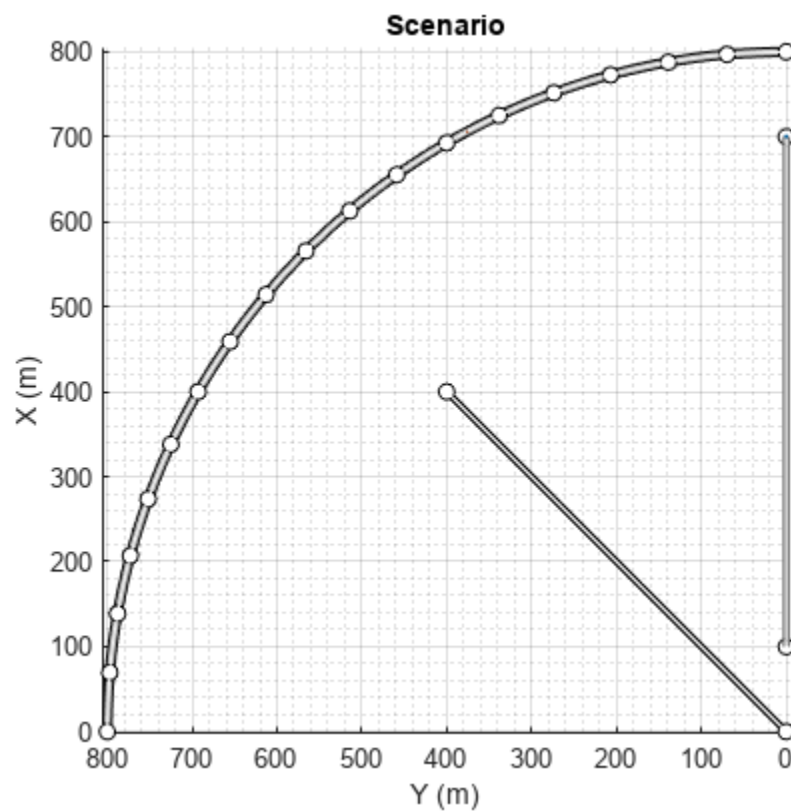

Display the actor poses and profiles.

```
allActorPoses = actorPoses(scenario)
```

```
allActorPoses=242x1 struct array with fields:
```

```
ActorID
Position
Velocity
Roll
Pitch
Yaw
AngularVelocity
```

```
allActorProfiles = actorProfiles(scenario)
```

```
allActorProfiles=242x1 struct array with fields:
```

```
ActorID
ClassID
Length
Width
Height
OriginOffset
MeshVertices
MeshFaces
RCSPattern
RCSAzimuthAngles
RCSElevationAngles
```

Because there are barriers in this scenario, and each barrier segment is considered an actor, `actorPoses` and `actorProfiles` functions return the poses of all stationary and non-stationary actors. To only obtain the poses and profiles of non-stationary actors such as vehicles and bicycles, first obtain their corresponding actor IDs using the `scenario.actors.ActorID` property.

```
movableActorIDs = [scenario.actors.ActorID];
```

Then, use those IDs to filter only non-stationary actor poses and profiles.

```
movableActorPoseIndices = ismember([allActorPoses.ActorID],movableActorIDs);
```

```
movableActorPoses = allActorPoses(movableActorPoseIndices)
```

```
movableActorPoses=2x1 struct array with fields:
```

```
ActorID
Position
Velocity
Roll
Pitch
Yaw
AngularVelocity
```

```
movableActorProfiles = allActorProfiles(movableActorPoseIndices)
```

```
movableActorProfiles=2x1 struct array with fields:
```

```
ActorID
ClassID
Length
Width
Height
OriginOffset
MeshVertices
MeshFaces
RCSPattern
RCSAzimuthAngles
RCSElevationAngles
```

Create and Display Road Boundaries

Create a driving scenario containing a figure-8 road specified in the world coordinates of the scenario. Convert the world coordinates of the scenario to the coordinate system of the ego vehicle.

Create an empty driving scenario.

```
scenario = drivingScenario;
```

Add a figure-8 road to the scenario. Display the scenario.

```
roadCenters = [0  0  1
               20 -20 1
               20  20 1
              -20 -20 1
              -20  20 1
               0  0  1];

roadWidth = 3;
bankAngle = [0 15 15 -15 -15 0];
road(scenario, roadCenters, roadWidth, bankAngle);
plot(scenario)
```

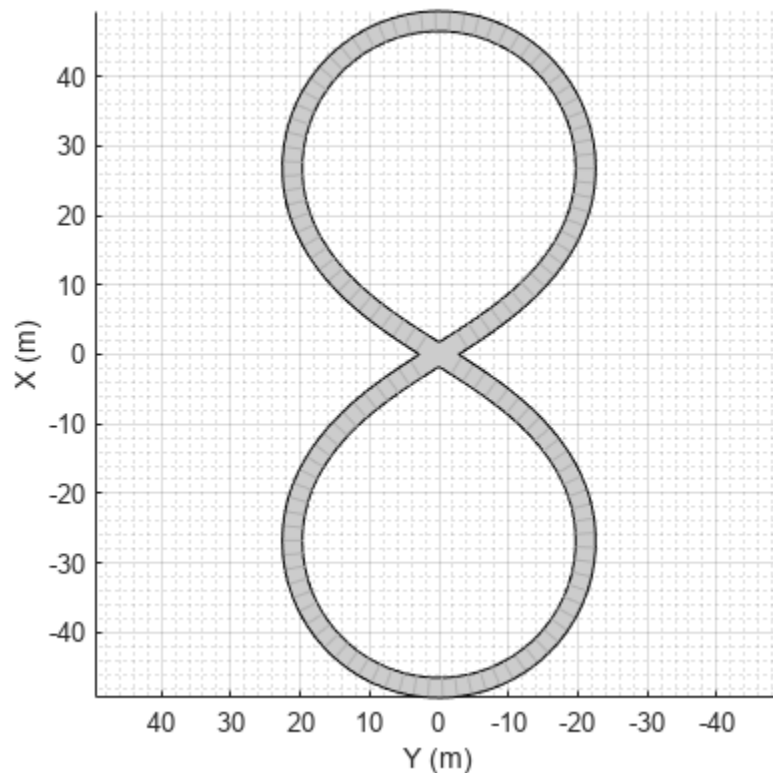

Add an ego vehicle to the scenario. Position the vehicle at world coordinates (20, -20) and orient it at a -15 degree yaw angle.

```
ego = actor(scenario, 'ClassID', 1, 'Position', [20 -20 0], 'Yaw', -15);
```

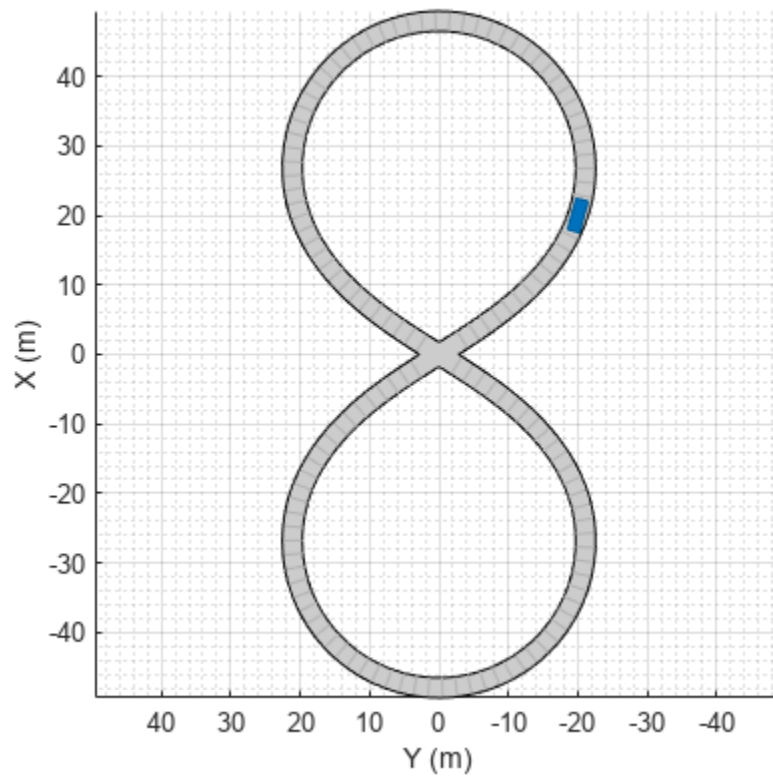



Obtain the road boundaries in ego vehicle coordinates by using the `roadBoundaries` function. Specify the ego vehicle as the input argument.

```
rbEgo1 = roadBoundaries(ego);
```

Display the result on a bird's-eye plot.

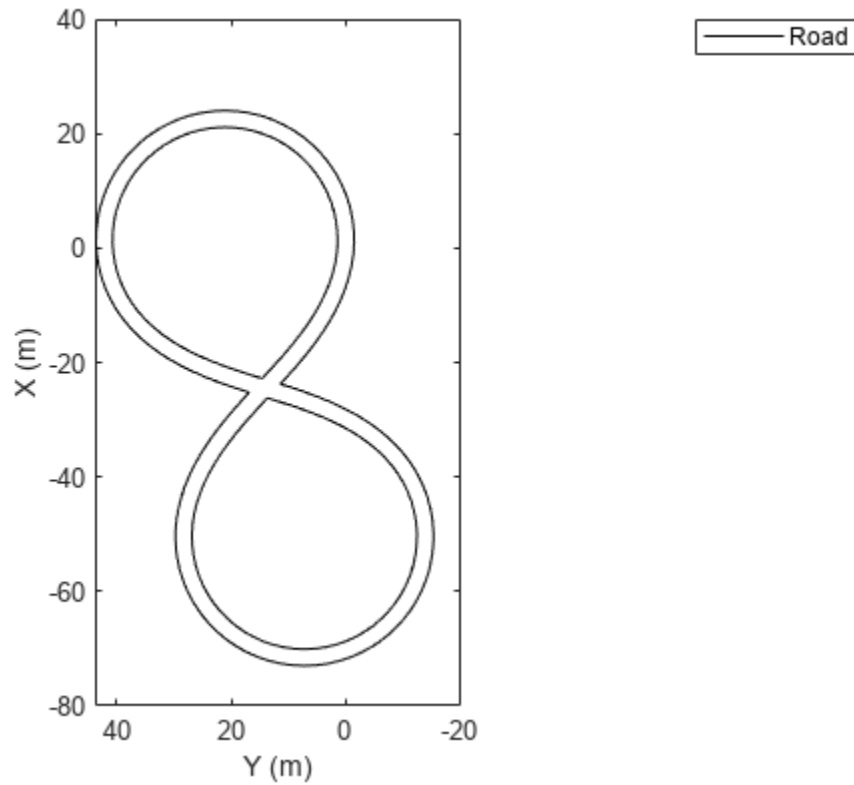
```
bep = birdsEyePlot;  
lbp = laneBoundaryPlotter(bep, 'DisplayName', 'Road');  
plotLaneBoundary(lbp, rbEgo1)
```



Obtain the road boundaries in world coordinates by using the `roadBoundaries` function. Specify the scenario as the input argument.

```
rbScenario = roadBoundaries(scenario);
```

Obtain the road boundaries in ego vehicle coordinates by using the `driving.scenario.roadBoundariesToEgo` function.

```
rbEgo2 = driving.scenario.roadBoundariesToEgo(rbScenario, ego);
```

Display the road boundaries on a bird's-eye plot.

```
bep = birdsEyePlot;  
lbp = laneBoundaryPlotter(bep, 'DisplayName', 'Road boundaries');  
plotLaneBoundary(lbp, {rbEgo2})
```

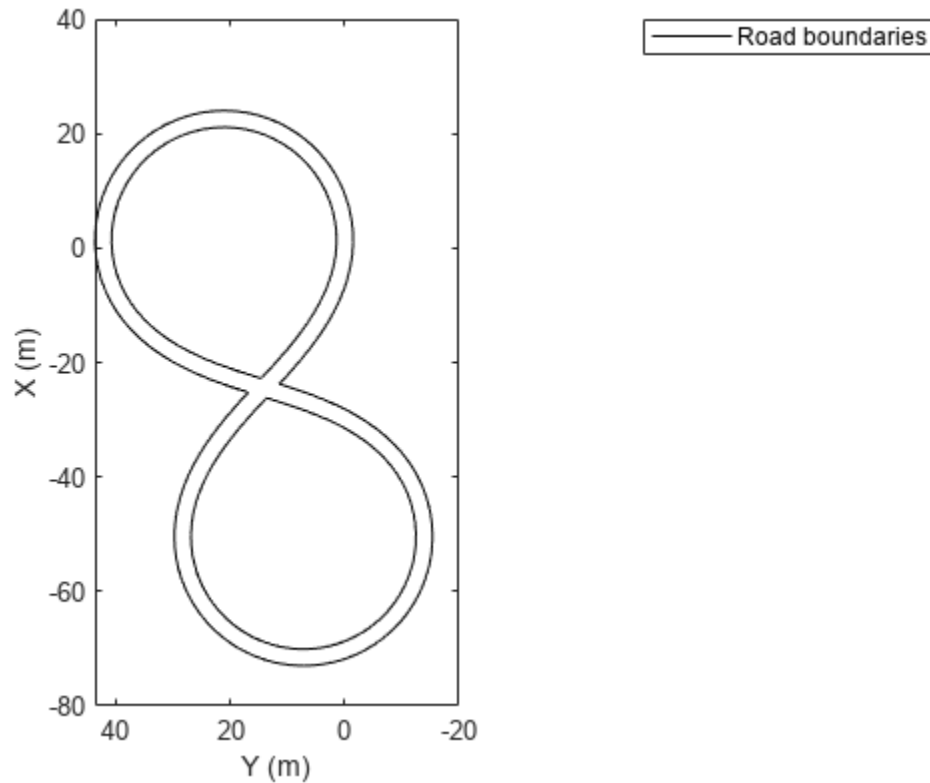

Display Lane Markings in Car and Pedestrian Scenario

Create a driving scenario containing a car and pedestrian on a straight road. Then, create and display the lane markings of the road on a bird's-eye plot.

Create an empty driving scenario.

```
scenario = drivingScenario;
```

Create a straight, 25-meter road segment with two travel lanes in one direction.

```
lm = [laneMarking('Solid')
      laneMarking('Dashed','Length',2,'Space',4)
      laneMarking('Solid')];
l = lanespec(2,'Marking',lm);
road(scenario,[0 0 0; 25 0 0],'Lanes',l);
```

Add to the driving scenario a pedestrian crossing the road at 1 meter per second and a car following the road at 10 meters per second.

```
ped = actor(scenario,'ClassID',4,'Length',0.2,'Width',0.4,'Height',1.7);
car = vehicle(scenario,'ClassID',1);
smoothTrajectory(ped,[15 -3 0; 15 3 0],1);
smoothTrajectory(car,[car.RearOverhang 0 0; 25-car.Length+car.RearOverhang 0 0],10);
```

Display the scenario and corresponding chase plot.

```
plot(scenario)
```

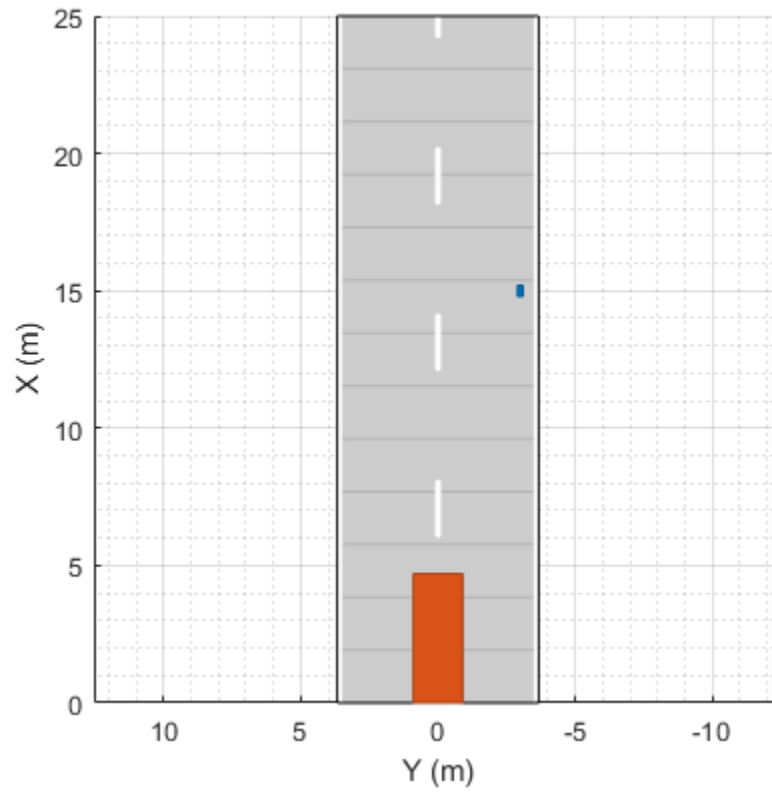

```
chasePlot(car)
```

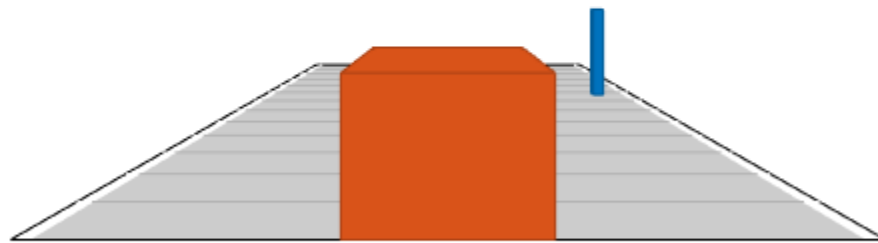

Run the simulation.

- 1 Create a bird's-eye plot.
- 2 Create an outline plotter, lane boundary plotter, and lane marking plotter for the bird's-eye plot.
- 3 Obtain the road boundaries and target outlines.
- 4 Obtain the lane marking vertices and faces.
- 5 Display the lane boundaries and lane markers.
- 6 Run the simulation loop.

```
bep = birdsEyePlot('XLim',[-25 25], 'YLim',[-10 10]);
olPlotter = outlinePlotter(bep);
lbPlotter = laneBoundaryPlotter(bep);
lmPlotter = laneMarkingPlotter(bep, 'DisplayName', 'Lanes');
legend('off');
while advance(scenario)
    rb = roadBoundaries(car);
    [position,yaw,length,width,originOffset,color] = targetOutlines(car);
    [lmv,lmf] = laneMarkingVertices(car);
    plotLaneBoundary(lbPlotter,rb);
    plotLaneMarking(lmPlotter,lmv,lmf);
    plotOutline(olPlotter,position,yaw,length,width, ...
        'OriginOffset',originOffset,'Color',color);
end
```

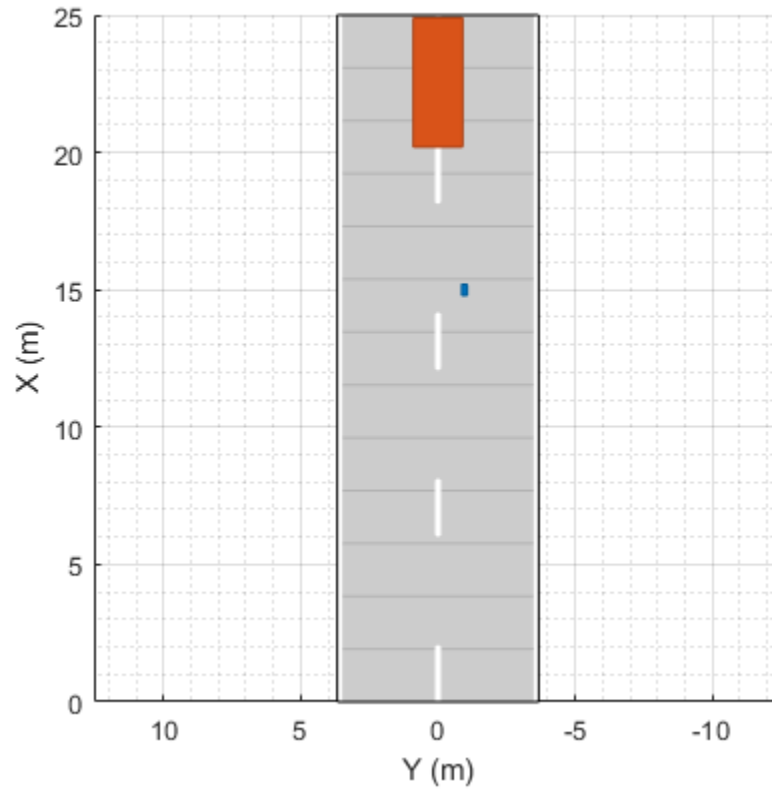

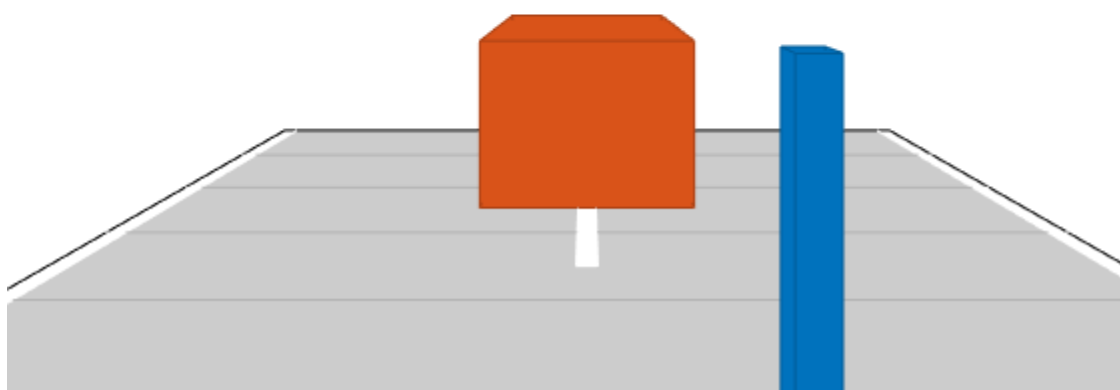

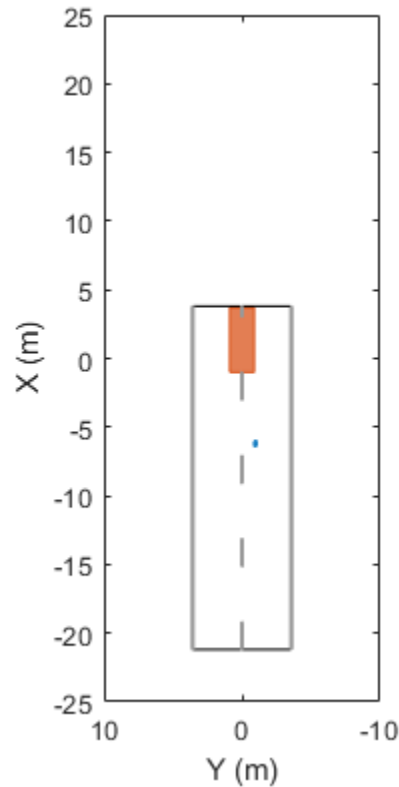

Connect Two Roads Using Heading Angles

Create a driving scenario containing two curved roads to connect. Specify the heading angles of each road center to fine-tune the shape of the road at the connecting region.

Create an empty driving scenario.

```
scenario = drivingScenario;
```

Add two roads to the driving scenario by defining their road centers and road heading angles.

```
% Add the first road
roadCenters = [-7 20; 0 0; 30 0; 30 -20; 10 -30];
roadHeadings = [-90; 0; NaN; NaN; -90];
laneMark = laneMarking('Solid');
laneSpecification = lanespec(2,Marking=laneMark);
road(scenario,roadCenters,'Lanes',laneSpecification, ...
    'Heading',roadHeadings,'Name','Road 1');

%Add the second road
roadCenters = [10 -30; 30 -40; 30 -60; 0 -60; -7 -80];
roadHeadings = [-90; NaN; NaN; 180; -90];
laneMark = laneMarking('Dashed');
laneSpecification = lanespec(2,Marking=laneMark);
road(scenario,roadCenters,'Lanes',laneSpecification, ...
    'Heading',roadHeadings,'Name','Road 2');
```

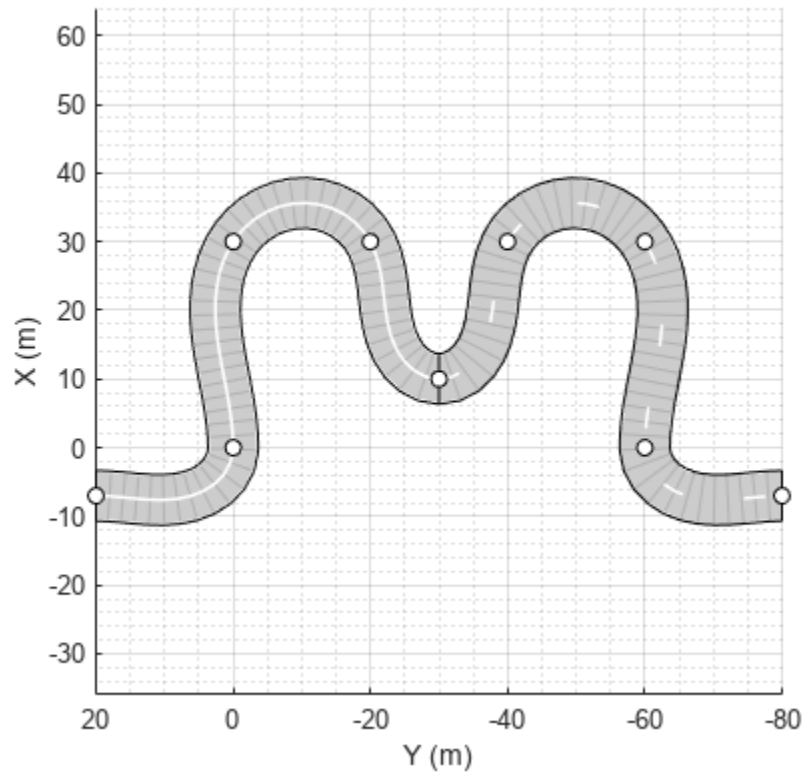

Plot the scenario.

```
plot(scenario, 'RoadCenters', 'on')
```

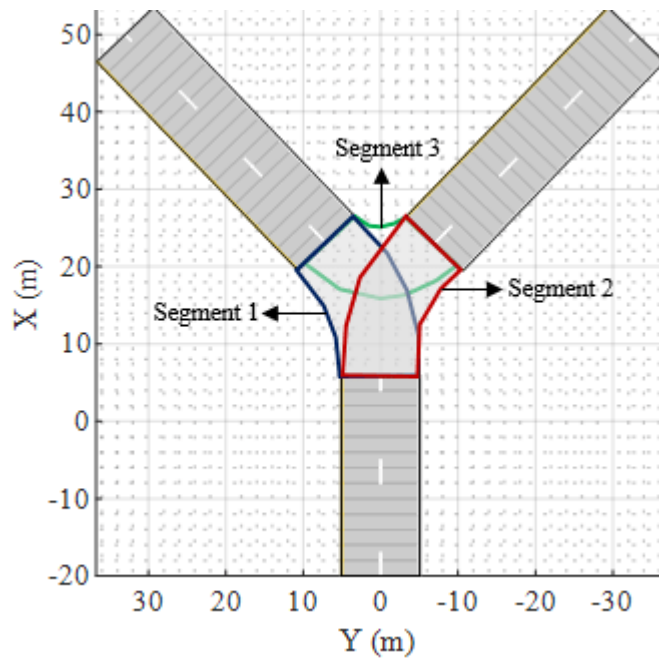

Create Road Network with Three-Way Intersection

A three-way intersection is a Y-junction in which two adjacent roads intersect the third road at an obtuse angle, as shown in this figure. To connect the three roads, you will create a Y-junction by adding three road segments.



Add Three Roads to Driving Scenario

Create an empty driving scenario.

```
scenario = drivingScenario;
```

Specify the number of lanes and the width of each lane in the roads.

```
ls = lanespec(2, 'Width', 5);
```

Define the road centers for three roads and add them to the driving scenario. The first road is diagonally oriented to the left of the scenario canvas, second road is diagonally oriented to the right of the scenario canvas, and the third road is oriented vertically.

```
% Add the first road
roadCenters = [-20 0; 6 0];
road(scenario, roadCenters, 'Name', 'Road 1', 'Lanes', ls);
```

```
% Add the second road
roadCenters = [23 7; 50 33];
road(scenario, roadCenters, 'Name', 'Road 2', 'Lanes', ls);
```

```
% Add the third road
roadCenters = [23 -7; 50 -33];
road(scenario, roadCenters, 'Name', 'Road 3', 'Lanes', ls);
```

Plot the scenario.

```
figure
plot(scenario)
```

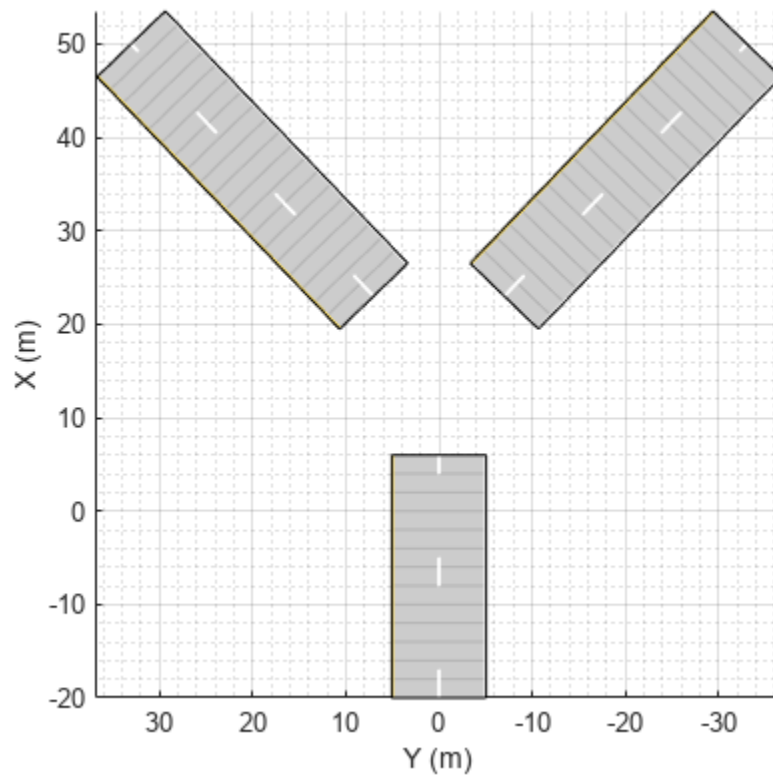

Create Y-Junction to Connect Roads

Create a RoadGroup object. Specify the width for each road segment that forms the Y-junction.

```
rg = driving.scenario.RoadGroup('Name', 'Y-Junction');
roadWidth = 10;
```

Specify the road centers for three road segments, and add these road segments to the RoadGroup object by using the road function. These road segments intersect with each other.

```
% Add the first road segment
roadCenters = [23 7; 14 1; 6 0];
road(rg, roadCenters, roadWidth, 'Name', 'Segment 1');
```

```
% Add the second road segment
roadCenters = [23 -7; 14 -1; 6 0];
road(rg, roadCenters, roadWidth, 'Name', 'Segment 2');
```

```
% Add the third road segment
roadCenters = [23 7; 21 4; 21 -4; 23 -7];
road(rg, roadCenters, roadWidth, 'Name', 'Segment 3');
```

Add Y-Junction to Driving Scenario

Add the road segments stored in the RoadGroup object to the driving scenario by using the roadGroup function. The road segments form a Y-junction that connects the three roads in the driving scenario.

```
roadGroup(scenario,rg);
```

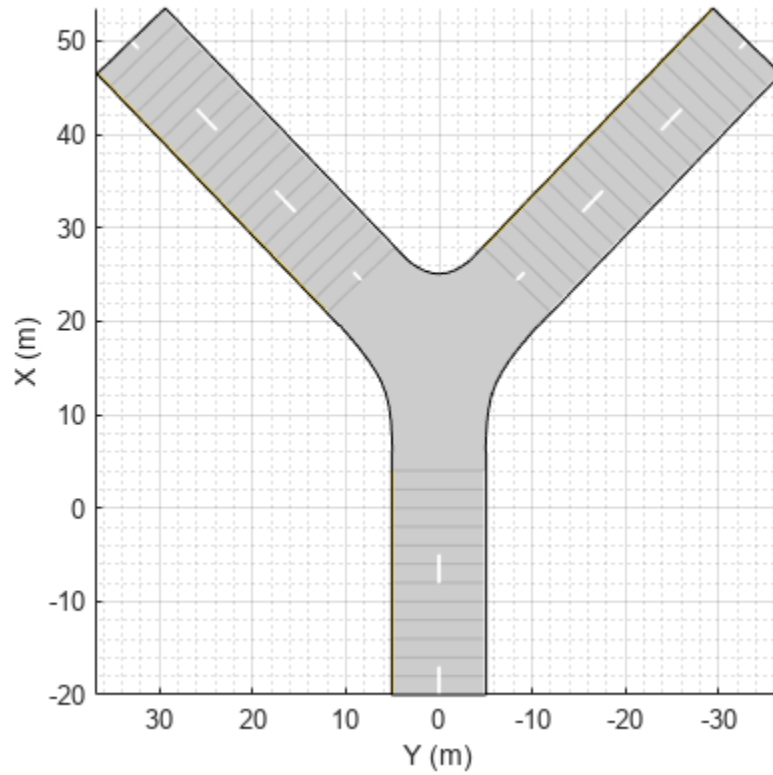

Create a Road Junction Using Heading Angles

Create a driving scenario with three roads, and use a road junction to connect them, as shown in this figure.

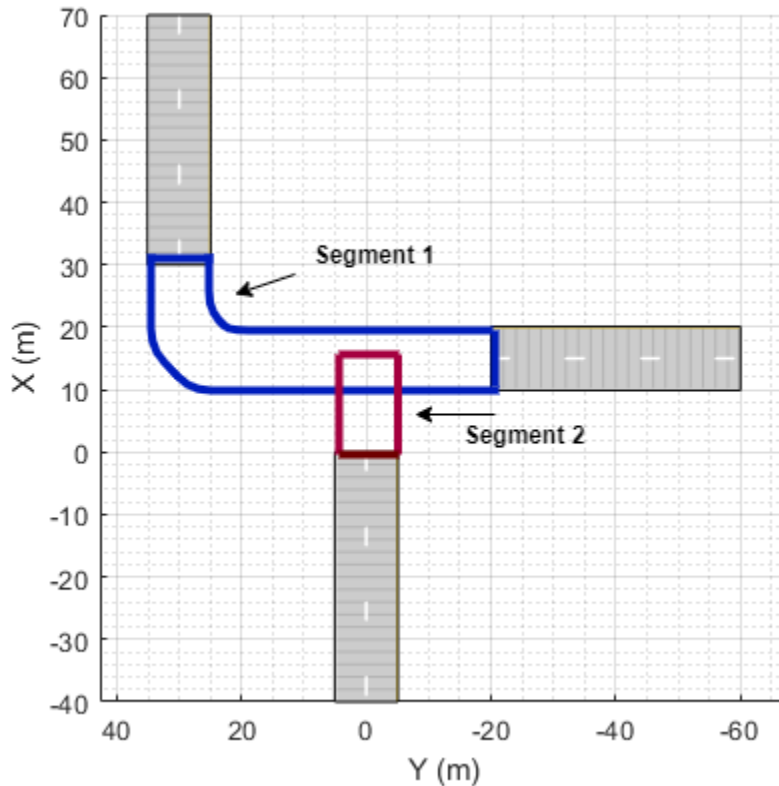

Add Three Roads to Driving Scenario

Create an empty driving scenario.

```
scenario = drivingScenario;
```

Specify the number of lanes and the width of each lane in the roads.

```
ls = lanespec(2, 'Width', 5);
```

Define the road centers for three roads and add them to the driving scenario. The first and second roads are vertically oriented, to the left and to the center of the scenario canvas respectively. The third road is horizontally oriented, to the right of the first two roads and between them vertically.

```
% Add the first road
roadCenters = [70 30; 30 30];
road(scenario, roadCenters, 'Name', 'Road 1', 'Lanes', ls);
```

```
% Add the second road
roadCenters = [0 0; -40 0];
road(scenario, roadCenters, 'Name', 'Road 2', 'Lanes', ls);
```

```
% Add the third road
roadCenters = [15 -20; 15 -60];
road(scenario, roadCenters, 'Name', 'Road 3', 'Lanes', ls);
```

Plot the scenario.

```
plot(scenario)
```

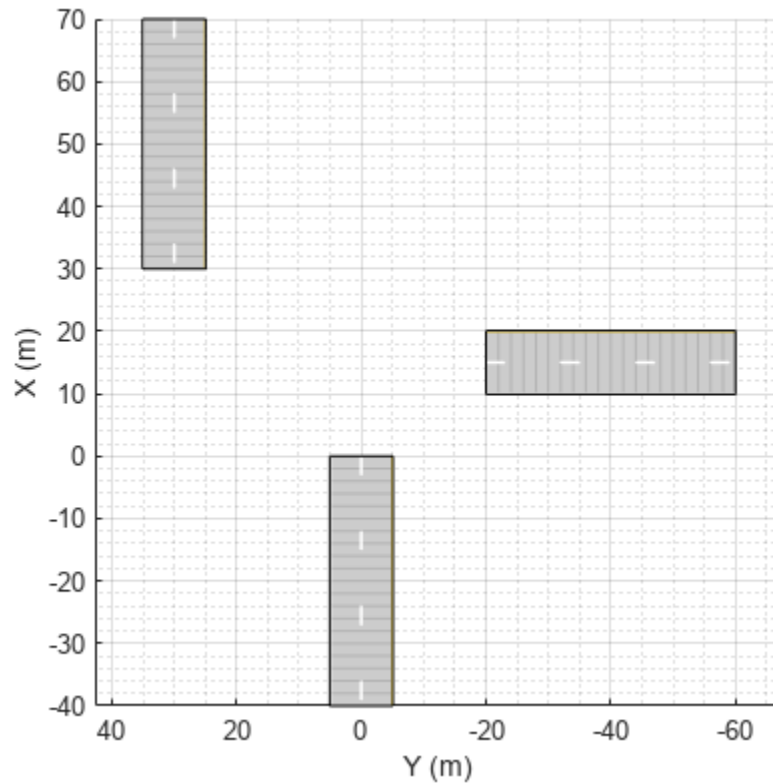

Create a Junction to Connect Roads

Create a RoadGroup object. Specify the width of each road segment that forms the junction.

```
rg = driving.scenario.RoadGroup('Name','Junction');
roadWidth = 10;
```

Specify the road centers for two road segments, and specify heading angles for the first road segment. Add these road segments to the RoadGroup object by using the road function. These road segments intersect each other.

```
%Add the first road segment and specify its heading angles
roadCenters = [31 30; 15 20; 15 -21];
roadHeadings = [180; -90; -90];
road(rg,roadCenters,roadWidth, ...
    'Name','Segment 1','Heading',roadHeadings);
```

```
% Add the second road segment
roadCenters = [15 0; -1 0];
road(rg,roadCenters,roadWidth, ...
    'Name','Segment 2');
```

Add Junction to Driving Scenario

Add the road segments stored in the RoadGroup object to the driving scenario by using the roadGroup function. The road segments form a junction that connects the three roads in the driving scenario.

```
roadGroup(scenario,rg);
```

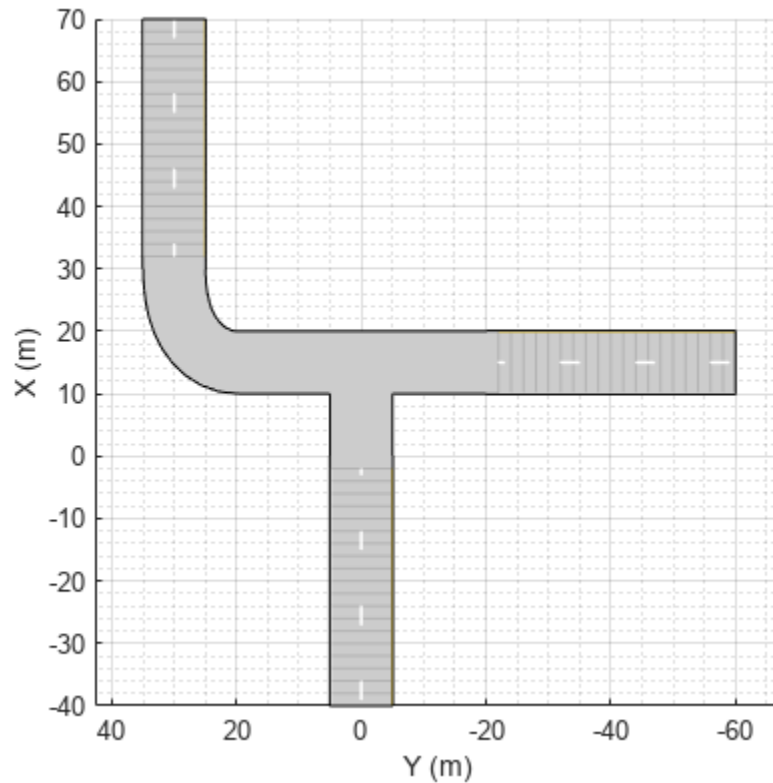

Input Arguments

scenario – Driving scenario

drivingScenario object

Driving scenario, specified as a *drivingScenario* object.

rg – Road group

RoadGroup object

Road group that defines a road junction or intersection, specified as a *RoadGroup* object.

roadcenters – Road centers used to define road

real-valued N -by-2 matrix | real-valued N -by-3 matrix

Road centers used to define a road, specified as a real-valued N -by-2 or N -by-3 matrix. Road centers determine the center line of the road at discrete points.

- If *roadcenters* is an N -by-2 matrix, then each matrix row represents the (x, y) coordinates of a road center. The z -coordinate of each road center is zero.
- If *roadcenters* is an N -by-3 matrix, then each matrix row represents the (x, y, z) coordinates of a road center.

If the first row of the matrix is the same as the last row, the road is a loop. Units are in meters.

Data Types: `double`

roadwidth — Width of road

6.0 (default) | positive real scalar | []

Width of road, specified as a positive real scalar. The width is constant along the entire road. Units are in meters.

To specify the `bankingangle` input but not `roadwidth`, specify `roadwidth` as an empty argument, [].

If you specify `roadwidth`, then you cannot specify the `lspec` input.

Data Types: `double`

bankingangle — Banking angle of road

0 (default) | real-valued N -by-1 vector

Banking angle of road, specified as a real-valued N -by-1 vector. N is the number of road centers. The banking angle is the roll angle of the road along the direction of the road. Units are in degrees.

lspec — Lane specification

`lanespec` object | `compositeLaneSpec` object

Lane specification, specified as a `lanespec` or `compositeLaneSpec` object. Use a `lanespec` object to create a road with a single lane specification. You can specify the number of lanes, the width of each lane, and the type of lane markings using the `lanespec` object. To specify the lane markings within `lanespec`, use the `laneMarking` function.

Use a `compositeLaneSpec` object to create a road with multiple road segments that have different lane specifications. For more details, see `compositeLaneSpec`.

If you specify `lspec`, then you cannot specify the `roadwidth` input.

Example: `'Lanes', lanespec(3)` specifies a three-lane road with default lane widths and lane markings.

name — Name of road

"" (default) | character vector | string scalar

Name of the road, specified as a character vector or string scalar.

Example: `'Name', 'Road1'`

Example: `"Name", "Road1"`

Data Types: `char` | `string`

roadheadings — Heading angle of road

real-valued N -by-1 vector

Heading angle of the road, specified as a real-valued N -by-1 vector of angles in the range $[-180, 180]$. N is the number of road centers. Units are in degrees.

The heading angles constrain the associated road centers. To avoid constraining the road center points, you must specify the corresponding elements of `roadheadings` as `NaN`. The `road` function automatically determines the heading angles for the unconstrained road centers. For more information, see “Heading Angle” on page 4-546.

Output Arguments

rd — Output road

Road object

Output road, returned as a Road object that has the properties described in this table. With the exception of RoadID, which is a scenario-generated property, the property names correspond to the input arguments used to create the road. All properties are read-only.

Property	Value
Name	Name of road, specified as a string scalar The name input argument sets this property. Even if you specify name as a character vector, the Name property value is a string scalar.
RoadID	Identifier of road, specified as a positive integer The scenario input argument generates a unique ID for each road in the driving scenario.
RoadCenters	Road centers used to define a road, specified as a real-valued N -by-2 or N -by-3 matrix, where N is the number of road centers The roadcenters input argument sets this property.
RoadWidth	Width of road, specified as a positive real scalar The roadwidth input argument sets this property.
BankAngle	Banking angle of road, specified as an N -by-1 real-valued vector, where N is the number of road centers in the road The bankingangle input argument sets this property.
Heading	Heading angle of road, specified as an N -by-1 real-valued vector, where N is the number of road centers in the road The roadheadings input argument sets this property.

More About

Draw Direction of Road and Numbering of Lanes

To create a road by using the road function, specify the road centers as a matrix input. The function creates a directed line that traverses the road centers, starting from the coordinates in the first row of the matrix and ending at the coordinates in the last row of the matrix. The coordinates in the first two rows of the matrix specify the draw direction of the road. These coordinates correspond to the

first two consecutive road centers. The draw direction is the direction in which the roads render in the scenario plot.

To create a road by using the **Driving Scenario Designer** app, you can either specify the **Road Centers** parameter or interactively draw on the **Scenario Canvas**. For a detailed example, see “Create a Driving Scenario” on page 1-14. In this case, the draw direction is the direction in which roads render in the **Scenario Canvas**.

- For a road with a top-to-bottom draw direction, the difference between the x-coordinates of the first two consecutive road centers is positive.
- For a road with a bottom-to-top draw direction, the difference between the x-coordinates of the first two consecutive road centers is negative.

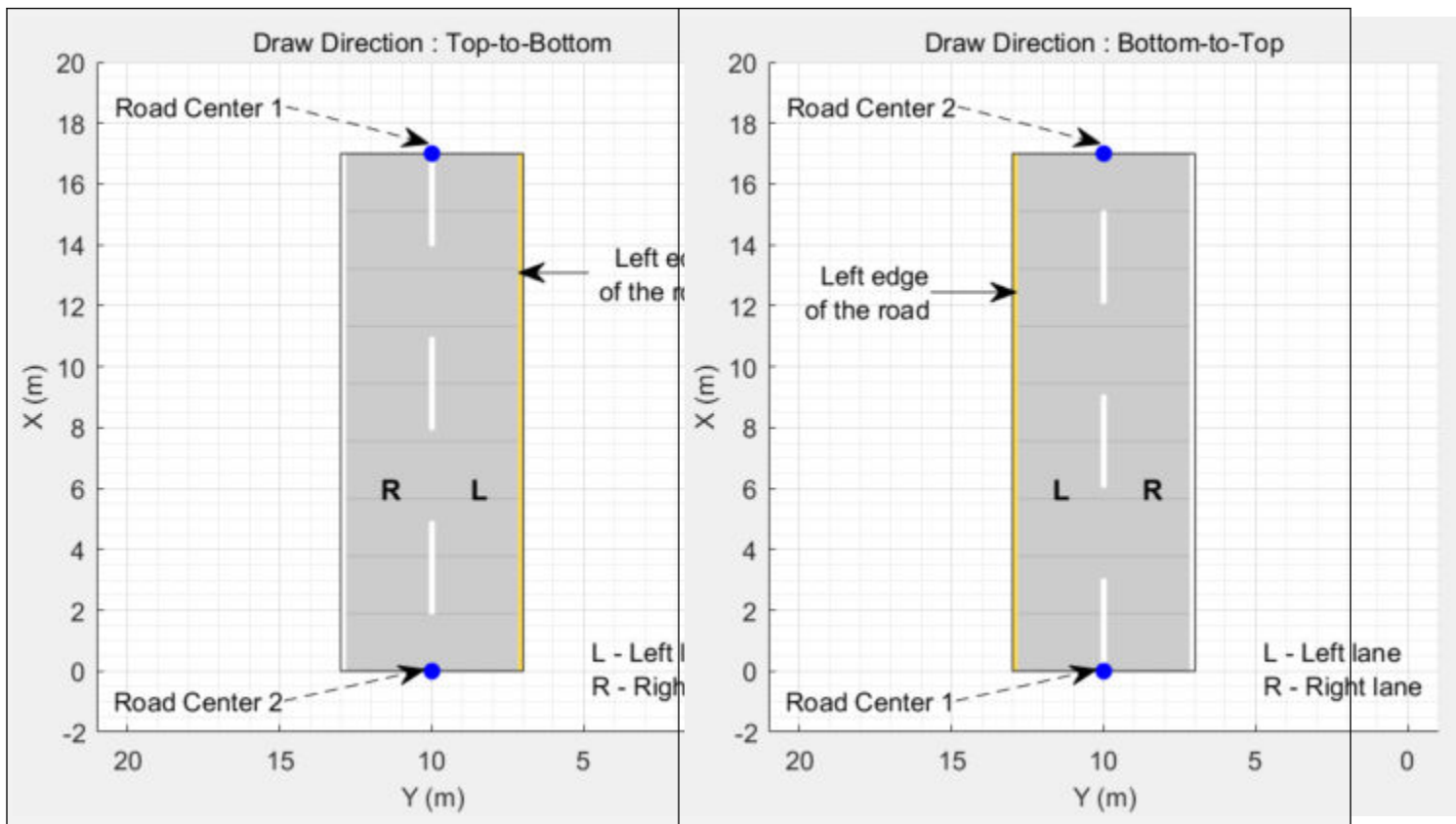

- For a road with a left-to-right draw direction, the difference between the y-coordinates of the first two consecutive road centers is positive.
- For a road with a right-to-left draw direction, the difference between the y-coordinates of the first two consecutive road centers is negative.

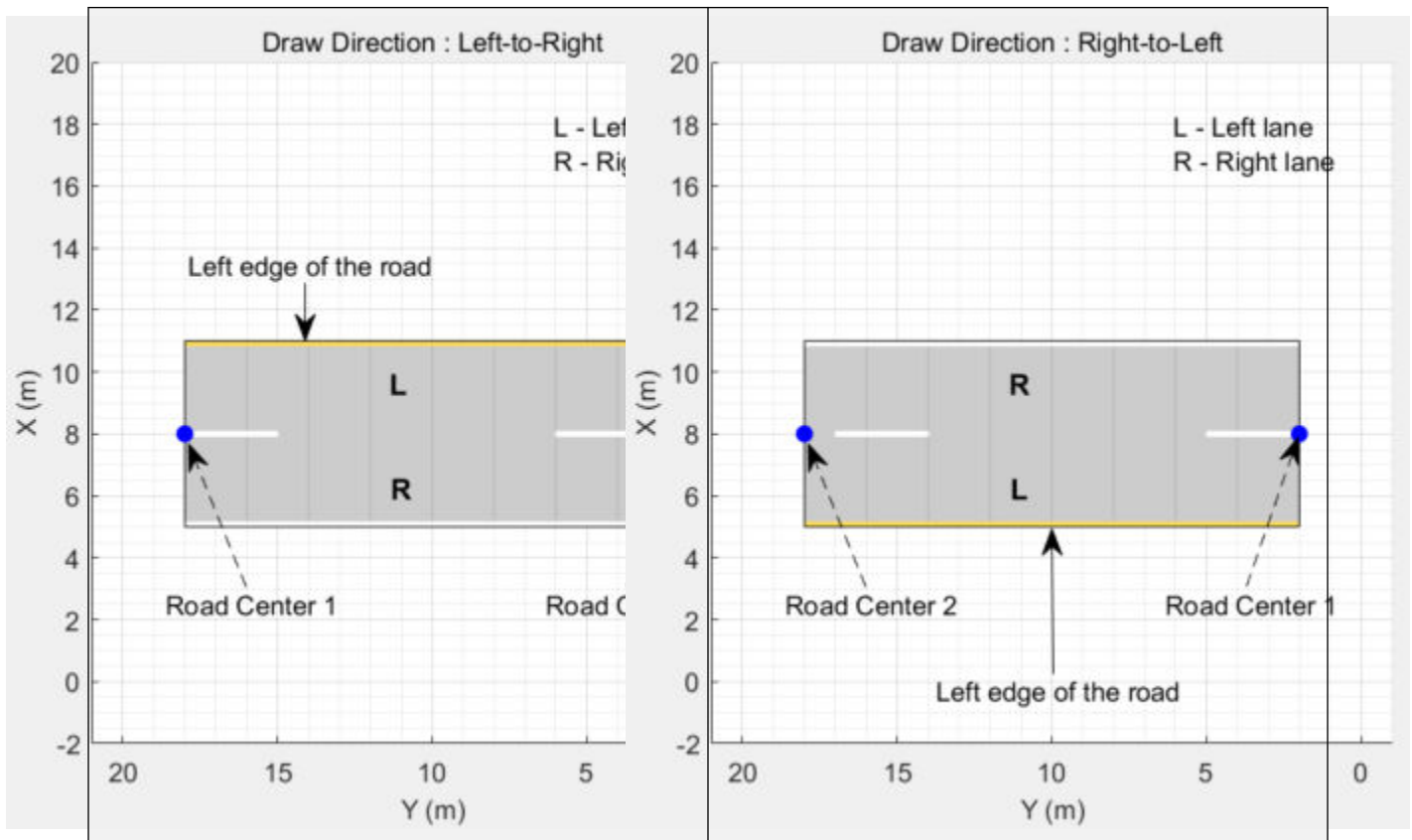

Numbering Lanes

Lanes must be numbered from left to right, with the left edge of the road defined relative to the draw direction of the road. For a one-way road, by default, the left edge of the road is a solid yellow marking which indicates the end of the road in transverse direction (direction perpendicular to draw direction). For a two-way road, by default, both edges are marked with solid white lines.

For example, these diagrams show how the lanes are numbered in a one-way and two-way road with a draw direction from top-to-bottom.

Numbering Lanes in a One-Way Road	Numbering Lanes in a Two-Way Road
-----------------------------------	-----------------------------------

Specify the number of lanes as a positive integer for a one-way road. If you set the integer value as 3, then the road has three lanes that travel in the same direction. The lanes are numbered starting from the left edge of the road.

1, 2, 3 denote the first, second, and third lanes of the road, respectively.

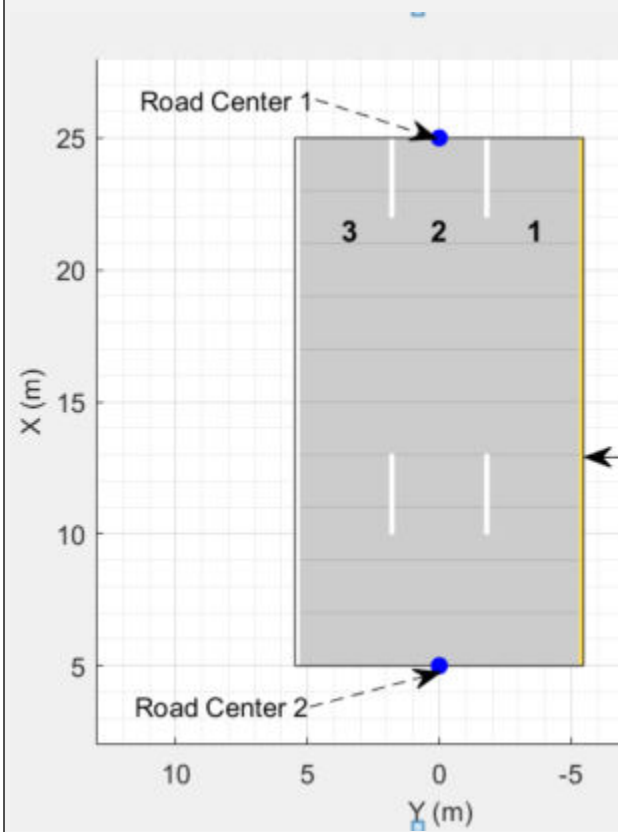

Specify the number of lanes as a two-element vector of positive integer for a two-way road. If you set the vector as [1 2], then the road has three lanes: two lanes traveling in one direction and one lane traveling in the opposite direction. Because of the draw direction, the road has one left lane and two right lanes. The lanes are numbered starting from the left edge of the road.

1L denote the only left lane of the road. **1R** and **2R** denote the first and second right lanes of the road, respectively.

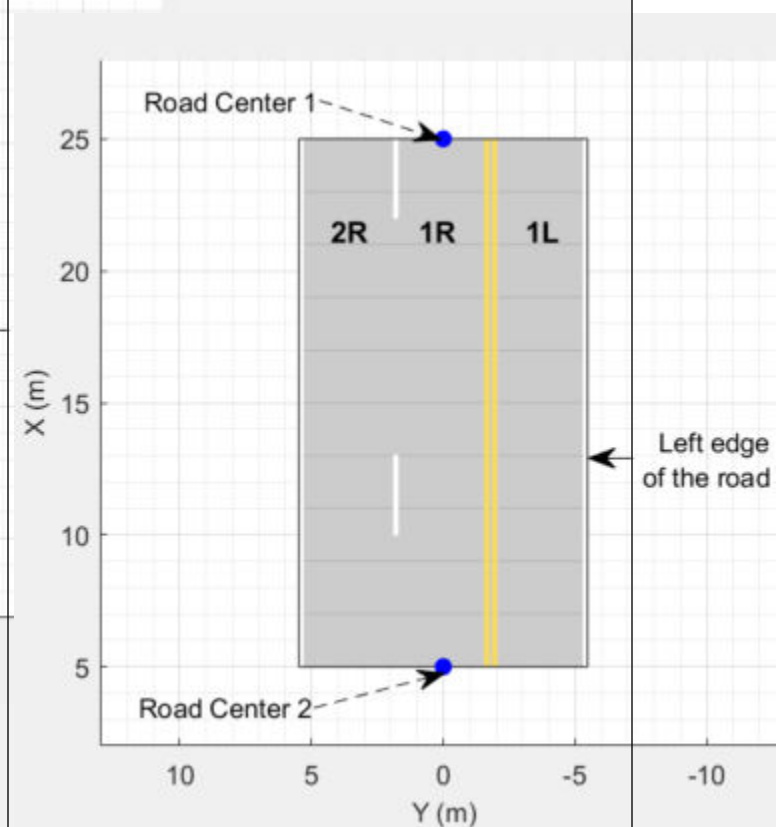

The lane specifications apply by the order in which the lanes are numbered.

Heading Angle

The heading angle refers to the angle of the road at a given road center point heading towards the next road center, measured counterclockwise with respect to the x-axis in the range [-180, 180] degrees.

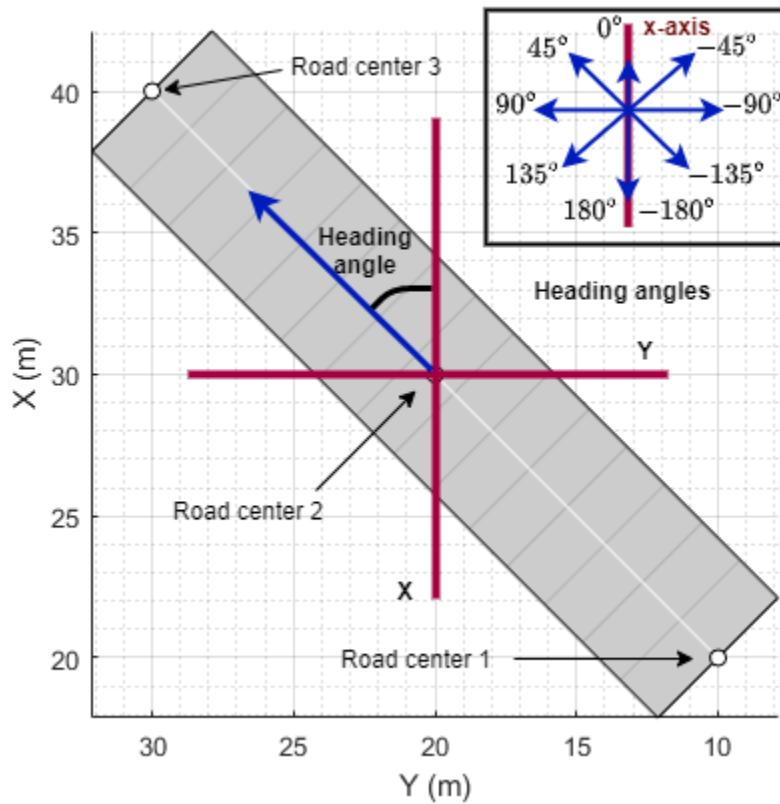

Specifying heading angles as a constraint to the road center points enables precise control over the shape and orientation of the roads.

For example, create a road by specifying its road centers. Plot the road

```
scenario = drivingScenario;
roadCenters = [0 35; 0 18; 15 10; 32 3; 32 -12];
roadHeadings = [NaN; NaN; 0; NaN; NaN];
road(scenario, roadCenters, 'Heading', roadHeadings);
plot(scenario, 'Centerline', 'on', 'RoadCenters', 'on')
```

This figure shows the road with one constrained road heading angle and its respective road center specified in this example. The other road centers are unconstrained and their heading angles are determined automatically by the road function.

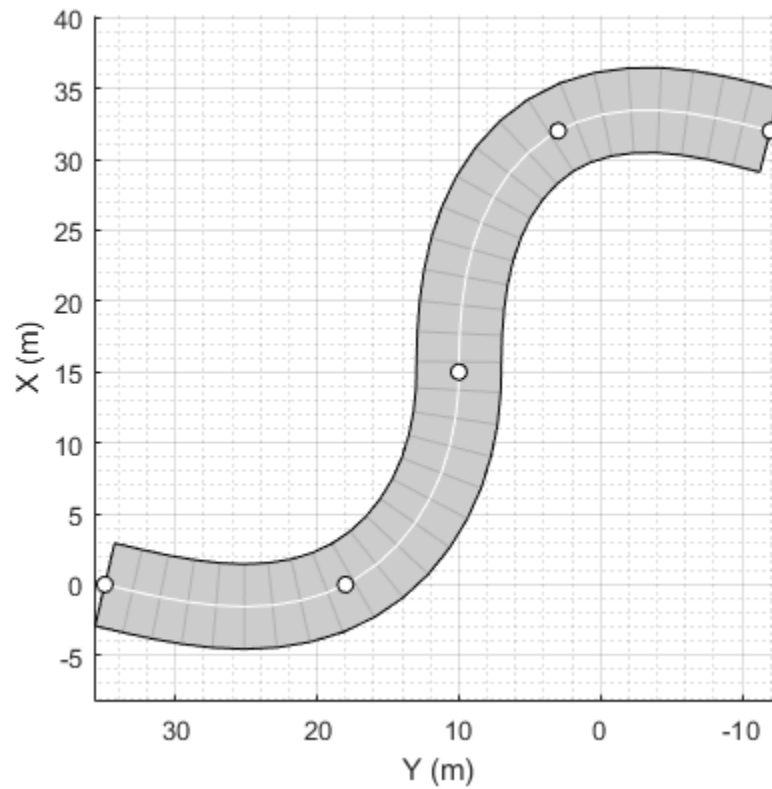

Now specify heading angles for each of the road center points in the road. Plot the new road.

```
scenario = drivingScenario;  
roadCenters = [0 35; 0 18; 15 10; 32 3; 32 -12];  
roadHeadings = [-90; -90; 0; -90; -90];  
road(scenario,roadCenters,'Heading',roadHeadings);  
plot(scenario,'Centerline','on','RoadCenters','on')
```

This figure shows the road with the road heading angles and their respective road centers specified in the example.

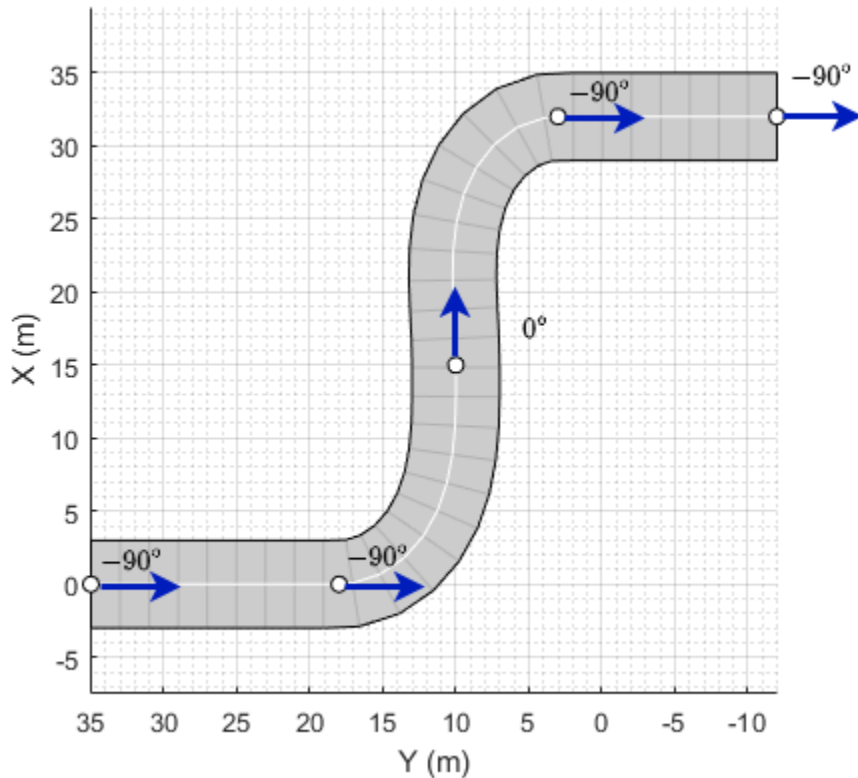

Algorithms

The road function creates a road for an actor to follow in a driving scenario. You specify the road using N two-dimensional or three-dimensional waypoints. Each of the $N - 1$ segments between waypoints defines a curve whose curvature varies linearly with distance along the segment. The function fits a piecewise clothoid curve to the (x, y) coordinates of the waypoints by matching the curvature on both sides of the waypoint. For a nonclosed curve, the curvature at the first and last waypoint is zero. If the first and last waypoints coincide, then the curvatures before and after the endpoints are matched. The z -coordinates of the road are interpolated using a shape-preserving piecewise cubic curve.

Version History

Introduced in R2017a

See Also

Objects

lanespec | drivingScenario | driving.scenario.RoadGroup | compositeLaneSpec

Functions

roadBoundaries | roadNetwork | laneMarking | roadGroup

Topics

“Define Road Layouts Programmatically”

“Create Driving Scenario Programmatically”

roadGroup

Add road junction or intersection to driving scenario

Syntax

```
roadGroup(scenario, rg)
```

Description

`roadGroup(scenario, rg)` creates a road junction or intersection from road segments and adds it to the driving scenario `scenario`. The `RoadGroup` object `rg` specifies the road segments that link the roads meeting at an intersection.

Examples

Create Road Network with Three-Way Intersection

A three-way intersection is a Y-Junction in which two adjacent roads intersect the third road at an obtuse angle, as shown in this figure. To connect the three roads, you will create a Y-Junction by adding three road segments.

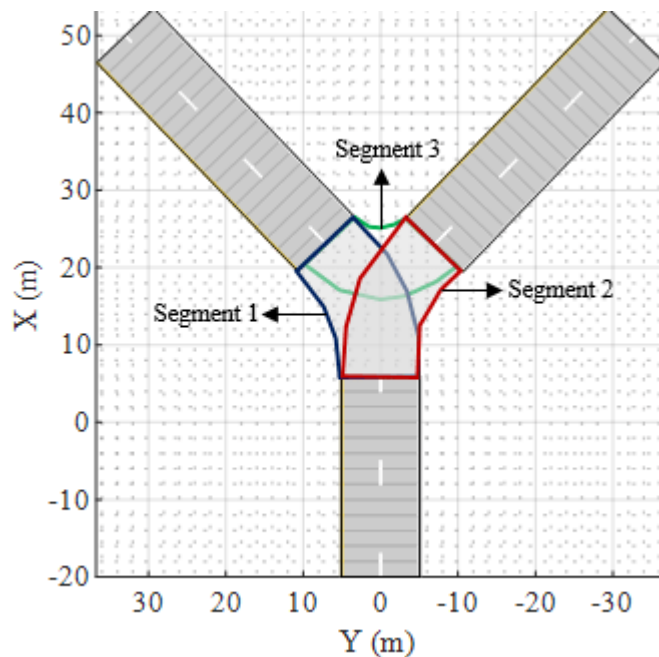

Add Three Roads to Driving Scenario

Create an empty driving scenario.

```
scenario = drivingScenario;
```

Specify the number of lanes and the width of each lane in the roads.

```
ls = lanespec(2,'Width',5);
```

Define the road centers for three roads and add them to the driving scenario. The first road is diagonally oriented to the left of the scenario canvas, second road is diagonally oriented to the right of the scenario canvas, and the third road is oriented vertically.

```
% Add the first road
roadCenters = [-20 0; 6 0];
road(scenario,roadCenters,'Name','Road 1','Lanes',ls);
```

```
% Add the second road
roadCenters = [23 7; 50 33];
road(scenario,roadCenters,'Name','Road 2','Lanes',ls);
```

```
% Add the third road
roadCenters = [23 -7; 50 -33];
road(scenario,roadCenters,'Name','Road 3','Lanes',ls);
```

Plot the scenario.

```
figure
plot(scenario)
```

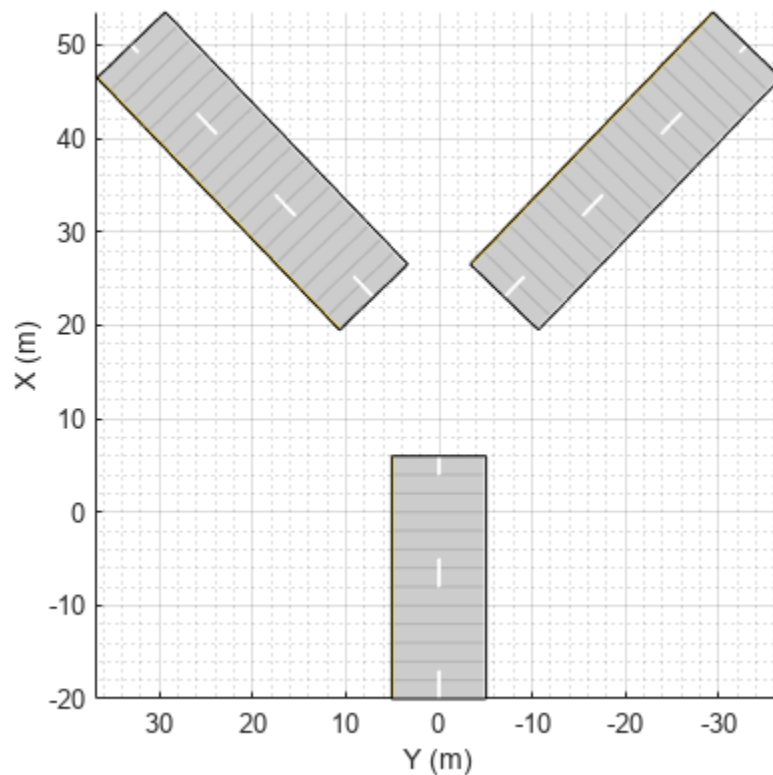

Create Y-Junction to Connect Roads

Create a RoadGroup object. Specify the width for each road segment that forms the Y-junction.

```
rg = driving.scenario.RoadGroup('Name', 'Y-Junction');  
roadWidth = 10;
```

Specify the road centers for three road segments, and add these road segments to the RoadGroup object by using the road function. These road segments intersect with each other.

```
% Add the first road segment  
roadCenters = [23 7; 14 1; 6 0];  
road(rg, roadCenters, roadWidth, 'Name', 'Segment 1');
```

```
% Add the second road segment  
roadCenters = [23 -7; 14 -1; 6 0];  
road(rg, roadCenters, roadWidth, 'Name', 'Segment 2');
```

```
% Add the third road segment  
roadCenters = [23 7; 21 4; 21 -4; 23 -7];  
road(rg, roadCenters, roadWidth, 'Name', 'Segment 3');
```

Add Y-junction to Driving Scenario

Add the road segments stored in the RoadGroup object to the driving scenario by using the roadGroup function. The road segments form a Y-junction that connects the three roads in the driving scenario.

```
roadGroup(scenario, rg);
```

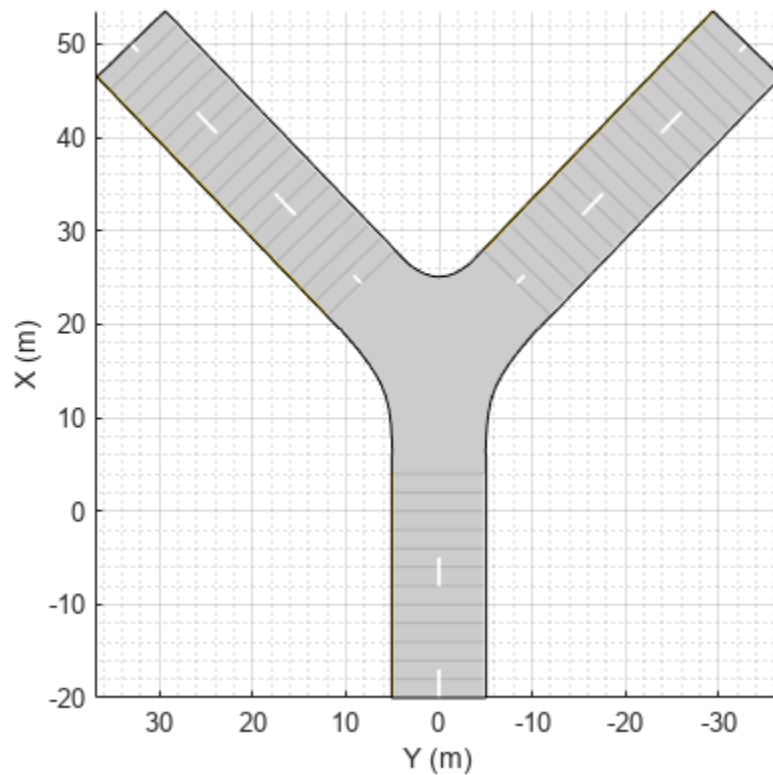

Input Arguments

scenario – Driving scenario

`drivingScenario` object

Driving scenario, specified as a `drivingScenario` object.

rg – Specifications for road segments

`RoadGroup` object

Specifications for road segments that form an intersection, specified as a `RoadGroup` object. Add separate road segments to connect each pair of incoming roads meeting at an intersection. Use the `road` function to add a road segment to the `RoadGroup` object.

Note

- You cannot alter the properties of road segments after adding them to the `RoadGroup` object.
-

Limitations

- The function does not support lane markings in intersections.
- The scenario plot does not display the road centers in the intersection.

Tips

- Add at least one road segment to the RoadGroup object to create an intersection using the roadGroup function.
- To create a smooth surface shape in an intersection, you must match the specifications (road centers, width, elevation and banking angle) of the road segments in the RoadGroup object to those of the incoming roads meeting at the intersection.
- The function considers only the first lane specification for each road segment while creating an intersection, so specify only a single lane specification for each road segment of the RoadGroup object .

Version History

Introduced in R2021a

See Also

Objects

drivingScenario | lanespec | driving.scenario.RoadGroup

Functions

road | actor | vehicle

Topics

“Create Driving Scenario Programmatically”

roadNetwork

Add road network to driving scenario

Syntax

```
roadNetwork(scenario, 'OpenDRIVE', filename)
roadNetwork(scenario, 'OpenDRIVE', filename, 'ShowLaneTypes', showLaneTypes)
```

```
roadNetwork(scenario, 'HEREHDLiveMap', lat, lon)
roadNetwork(scenario, 'HEREHDLiveMap', minLat, minLon, maxLat, maxLon)
```

```
roadNetwork(scenario, 'OpenStreetMap', filename)
```

```
roadNetwork(scenario, 'ZenrinJapanMap', lat, lon)
roadNetwork(scenario, 'ZenrinJapanMap', minLat, minLon, maxLat, maxLon)
```

Description

OpenDRIVE

`roadNetwork(scenario, 'OpenDRIVE', filename)` imports roads from an ASAM OpenDRIVE road network file into a driving scenario. The function supports importing road networks from OpenDRIVE file versions 1.4 and 1.5, as well as ASAM OpenDRIVE file version 1.6.

`roadNetwork(scenario, 'OpenDRIVE', filename, 'ShowLaneTypes', showLaneTypes)` uses the name-value pair 'ShowLaneTypes' to also import lane type information from the file and display it in the driving scenario.

Note As of R2021b, the ASAM OpenDRIVE import feature offers functional and visual improvements, as well as a few additional limitations.

- You can now import roads with multiple lane specifications.
- Imported roads show boundary lines that were not shown previously.
- Road centers always appear in the middle of imported roads. Previously, some roads were showing road centers on the road edges.
- Junctions are represented using a `RoadGroup` object that combines road segments within a junction. Previously, each road segment within a junction was represented separately. As a result, imported road networks now use a smaller number of roads.
- The road IDs, number of roads, junction IDs, and number of junctions in a driving scenario may not match those specified in the imported ASAM OpenDRIVE file.

HERE HD Live Map

`roadNetwork(scenario, 'HEREHDLiveMap', lat, lon)` imports roads from a HERE HD Live Map ⁷ (HERE HDLM) road network into a driving scenario. The function imports the roads that are nearest to the latitude and longitude coordinates specified in `lat` and `lon`, respectively.

`roadNetwork(scenario, 'HEREHDLiveMap', minLat, minLon, maxLat, maxLon)` imports HERE HDLM roads that are at least partially within the geographic bounding box specified by `minLat`, `minLon`, `maxLat`, and `maxLon`.

OpenStreetMap

`roadNetwork(scenario, 'OpenStreetMap', filename)` imports roads from an OpenStreetMap road network file into a driving scenario.

Zenrin Japan Map API 3.0 (Itsumo NAVI API 3.0)

`roadNetwork(scenario, 'ZenrinJapanMap', lat, lon)` imports roads from a Zenrin Japan Map API 3.0 (Itsumo NAVI API 3.0)⁸ road network into a driving scenario. The function imports the roads that are nearest to the latitude and longitude coordinates specified in `lat` and `lon`, respectively.

Importing roads from the Zenrin Japan Map API 3.0 (Itsumo NAVI API 3.0) service requires Automated Driving Toolbox Importer for Zenrin Japan Map API 3.0 (Itsumo NAVI API 3.0) Service.

`roadNetwork(scenario, 'ZenrinJapanMap', minLat, minLon, maxLat, maxLon)` imports Zenrin Japan Map API 3.0 (Itsumo NAVI API 3.0) roads that are at least partially within the geographic bounding box specified by `minLat`, `minLon`, `maxLat`, and `maxLon`.

Examples

Import ASAM OpenDRIVE Road Network into Driving Scenario

Create an empty driving scenario.

```
scenario = drivingScenario;
```

Import an ASAM OpenDRIVE road network into the scenario.

```
filePath = 'roundabout.xodr';
roadNetwork(scenario, 'OpenDRIVE', filePath);
```

Plot the scenario and zoom in on the road network by setting the axes limits.

```
plot(scenario)
xlim([-250 150])
ylim([-175 225])
```

⁷ You need to enter into a separate agreement with HERE in order to gain access to the HDLM services and to get the required credentials (`access_key_id` and `access_key_secret`) for using the HERE Service.

⁸ To gain access to the Zenrin Japan Map API 3.0 (Itsumo NAVI API 3.0) service and get the required credentials (a client ID and secret key), you must enter into a separate agreement with ZENRIN DataCom CO., LTD.

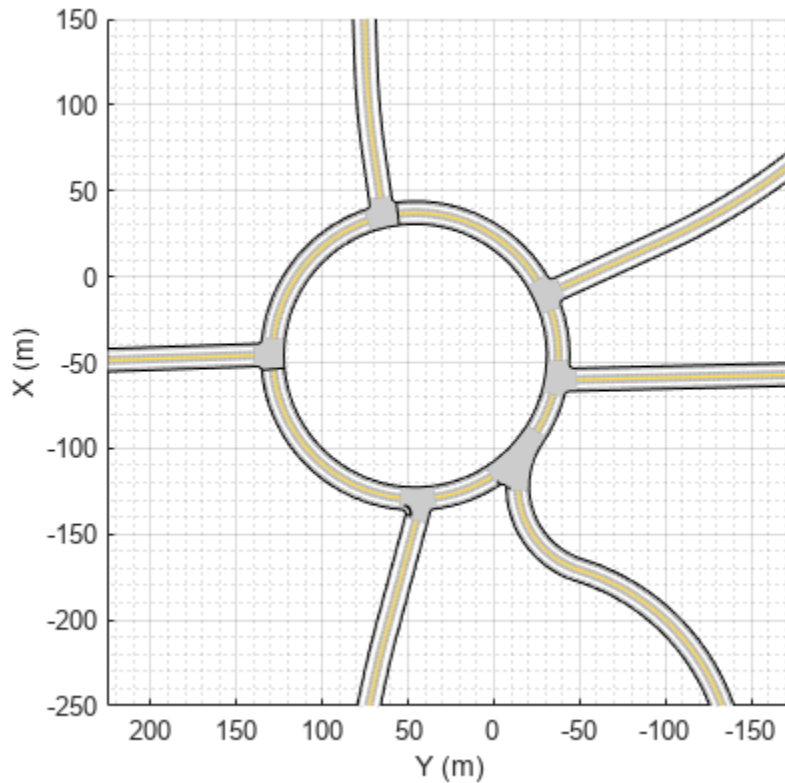

Import ASAM OpenDRIVE Road with Multiple Lane Types into Driving Scenario

Create an empty driving scenario.

```
scenario = drivingScenario;
```

Import an ASAM OpenDRIVE® road composed of driving and parking lanes into the scenario. By default, the function interprets the lane type information and imports the lanes into driving scenario without altering the lane type.

```
filePath = 'parking.xodr';  
roadNetwork(scenario, 'OpenDRIVE', filePath);
```

Plot the scenario.

```
plot(scenario)  
zoom(2)  
legend('Driving lane', 'Parking lane')
```

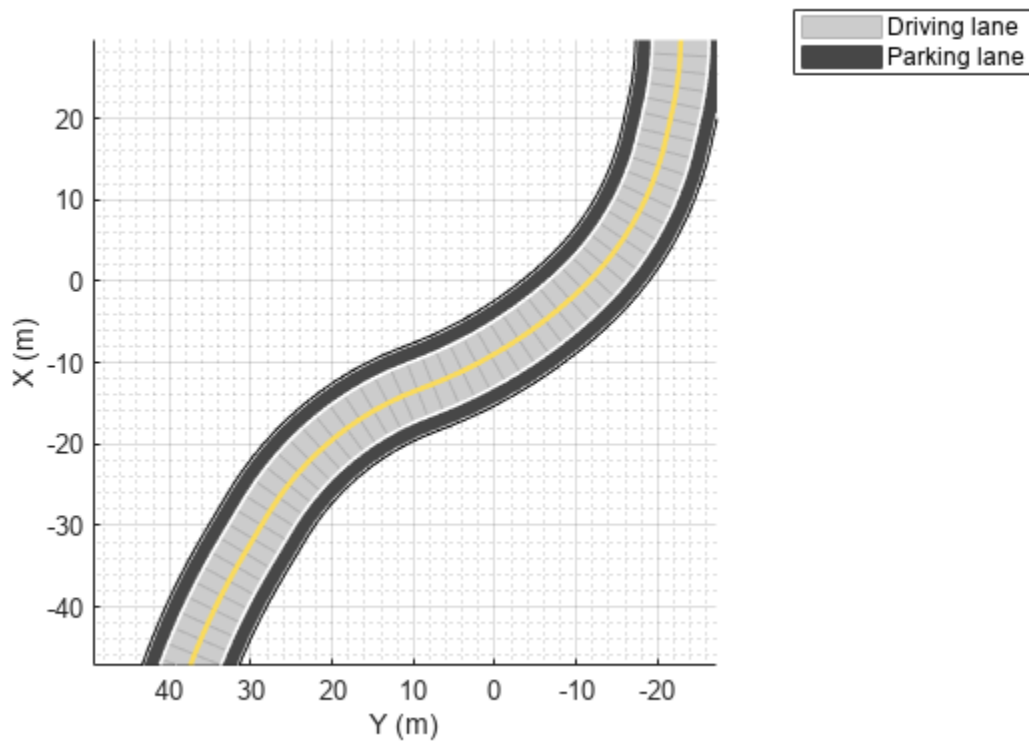
Import the ASAM OpenDRIVE road into the scenario. Set the 'ShowLaneTypes' value to false to suppress multiple lane types. The function ignores the lane type information and imports all the lanes as driving lanes.

```
scenario = drivingScenario;  
roadNetwork(scenario, 'OpenDRIVE', filePath, 'ShowLaneTypes', false);  
plot(scenario)  
zoom(2)
```

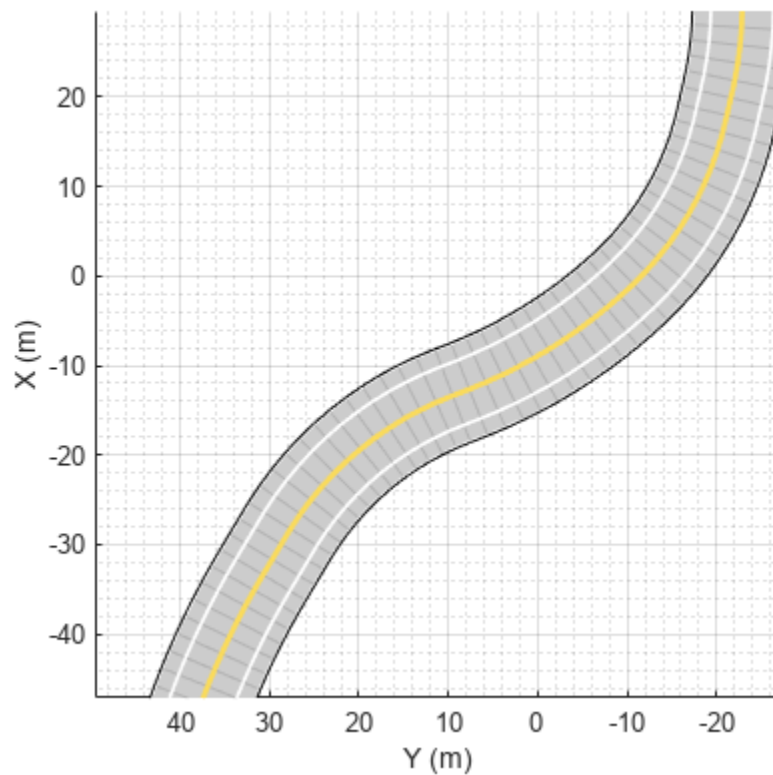

Import HERE HDLM Roads Using Specified Coordinates

Import HERE HDLM road network data that is nearest to the coordinates of a specified driving route into a driving scenario. Plot a vehicle following this route in the driving scenario.

Load a sequence of geographic coordinates that correspond to a driving route.

```
data = load('geoSequence.mat');
lat = data.latitude;
lon = data.longitude;
```

Display the route by streaming the coordinates on a geographic player. Set the zoom level to 14 and configure the player to display all points in its history. To speed up the streaming, plot only every tenth coordinate in the route.

```
zoomLevel = 14;
player = geoplayer(lat(1),lon(1),zoomLevel,'HistoryDepth',Inf);
timestep = 10;

for i = 1:timestep:length(lat)
    plotPosition(player,lat(i),lon(i));
end
```

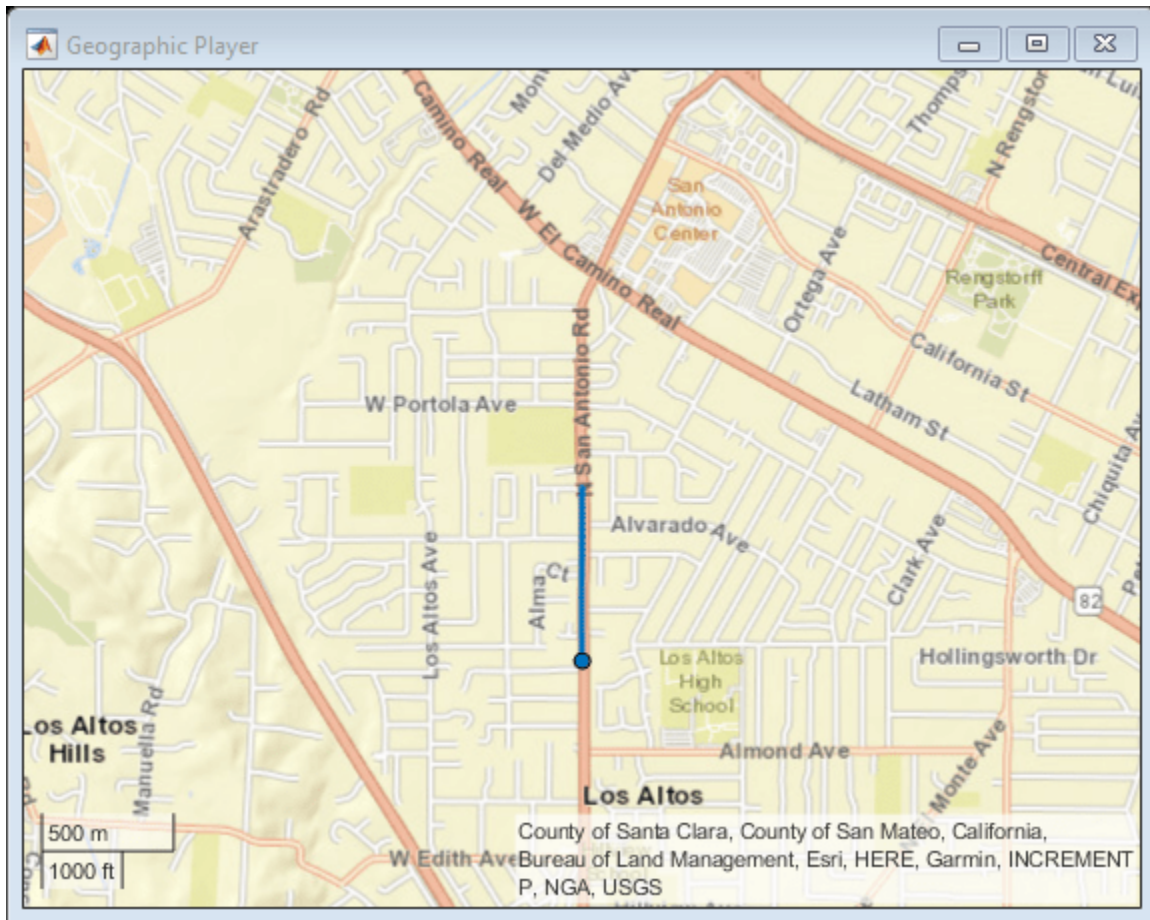

Create a driving scenario. Import the HERE HDLM road data that is nearest to the driving route into the scenario.

```
scenario = drivingScenario;
roadNetwork(scenario, 'HEREHDLiveMap', lat, lon);
```

Use the `latlon2local` function to convert the driving route from geographic coordinates to local east-north-up (ENU) Cartesian coordinates used in the driving scenario. For the origin of the ENU coordinate system, use the geographic road network origin stored in the `GeoReference` property of the scenario. The origin is the first coordinate specified in the driving route. Because the driving route contains only latitudinal and longitudinal data, set the altitude to 0.

```
alt = 0;
origin = scenario.GeoReference;
[xEast,yNorth,zUp] = latlon2local(lat,lon,alt,origin);
```

Add a vehicle to the driving scenario. Specify the converted driving route as the trajectory of the vehicle. Set a vehicle speed of 30 meters per second.

```
v = vehicle(scenario, 'ClassID', 1);
speed = 30;
smoothTrajectory(v, [xEast,yNorth,zUp], speed);
```

Plot the scenario and pause every 0.01 seconds to slow down the simulation. To maintain the same alignment with geographic coordinate displays, the X-axis is on the bottom and the Y-axis is on the

left. In driving scenarios not imported from maps, the X-axis is on the left and the Y-axis is on the bottom. This alignment is consistent with the Automated Driving Toolbox™ world coordinate system.

After a few seconds, the vehicle appears to drive underneath the road. This issue occurs because the converted trajectory contains no altitude data but the imported road network does. To avoid this issue, if you are specifying a driving route recorded from a GPS, include the altitude data.

```
plot(scenario)
while advance(scenario)
    pause(0.01)
end
```

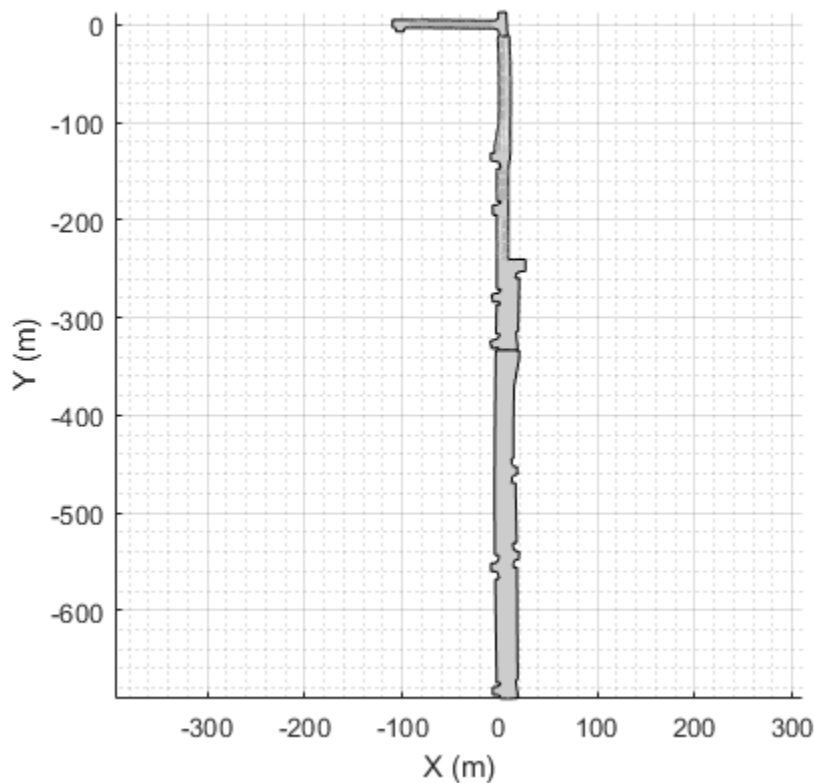

Import HERE HDLM Roads Using Specified Region

Import HERE HDLM road network data into driving scenario. Select this data from a region that is centered around a specified geographic coordinate.

Define a latitude and longitude coordinates corresponding to a roundabout.

```
latCenter = 42.302324;
lonCenter = -71.384970;
```

Specify the minimum and maximum latitudinal and longitudinal coordinates for a rectangular region around the roundabout. Display a bounding box corresponding to this region on a geographic plot.

```

offset = 5e-4;
minLat = latCenter - offset;
minLon = lonCenter - offset;
maxLat = latCenter + offset;
maxLon = lonCenter + offset;

gx = geoaxes;
LineStyle = '-k';
geoplot(gx, ...
    [minLat maxLat],[minLon minLon],LineStyle, ...
    [maxLat maxLat],[minLon maxLon],LineStyle, ...
    [maxLat minLat],[maxLon maxLon],LineStyle, ...
    [minLat minLat],[maxLon minLon],LineStyle)

```

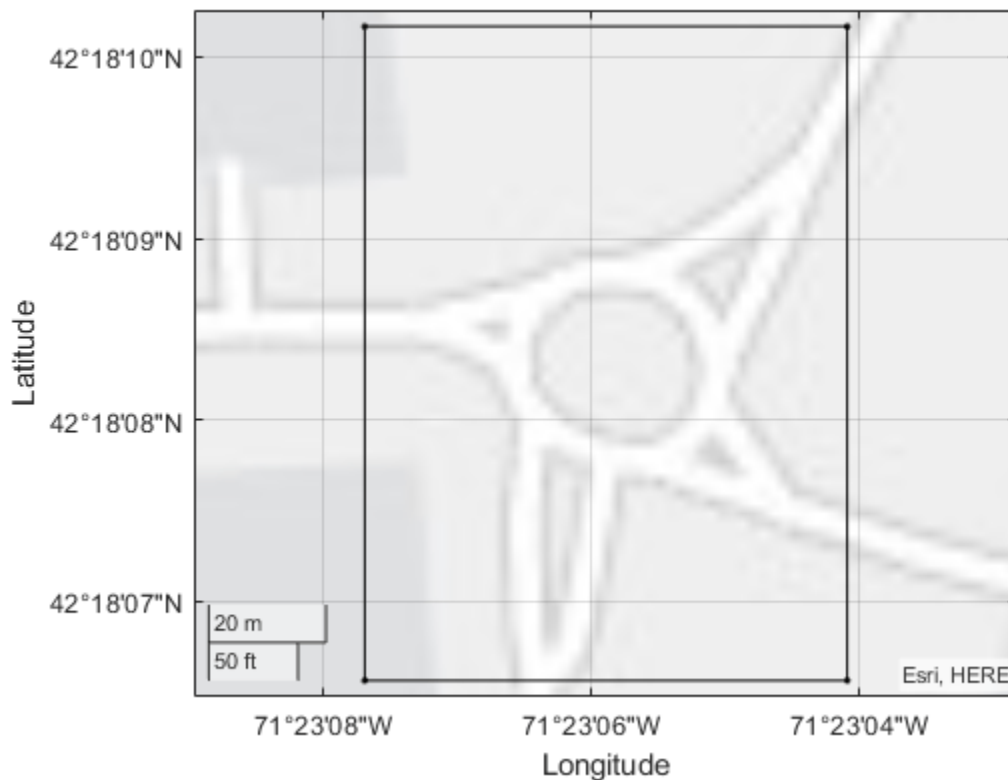

Create a driving scenario and import roads from the region by using the minimum and maximum coordinates. The `roadNetwork` function imports roads that are at least partially within this region.

```

scenario = drivingScenario;
roadNetwork(scenario, 'HEREHDLiveMap', minLat, minLon, maxLat, maxLon);

```

Plot the scenario. To maintain the same alignment with geographic coordinate displays, the *X*-axis is on the bottom and the *Y*-axis is on the left. In driving scenarios not imported from maps, the *X*-axis is on the left and the *Y*-axis is on the bottom. This alignment is consistent with the Automated Driving Toolbox™ world coordinate system.

```

plot(scenario)

```

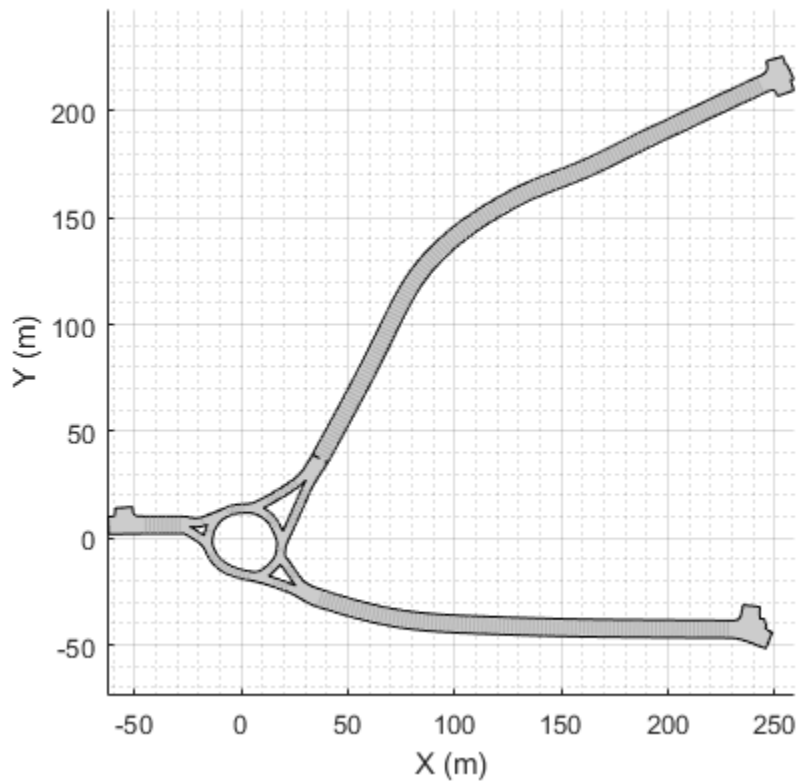

Import OpenStreetMap Road Network and Plot Route

Import roads from the OpenStreetMap® web service into a driving scenario. Then, plot a vehicle following a route in the imported road network.

Import a road network of the MathWorks® Apple Hill campus into an empty driving scenario. The file was downloaded from <https://www.openstreetmap.org>, which provides access to crowd-sourced map data all over the world. The data is licensed under the Open Data Commons Open Database License (ODbL), <https://opendatacommons.org/licenses/odbl/>.

Plot the imported road network. To maintain the same alignment with geographic coordinate displays, the X-axis is on the bottom and the Y-axis is on the left. In driving scenarios not imported from maps, the X-axis is on the left and the Y-axis is on the bottom. This alignment is consistent with the Automated Driving Toolbox™ world coordinate system.

```
scenario = drivingScenario;  
roadNetwork(scenario, 'OpenStreetMap', 'applehill.osm');  
plot(scenario)
```

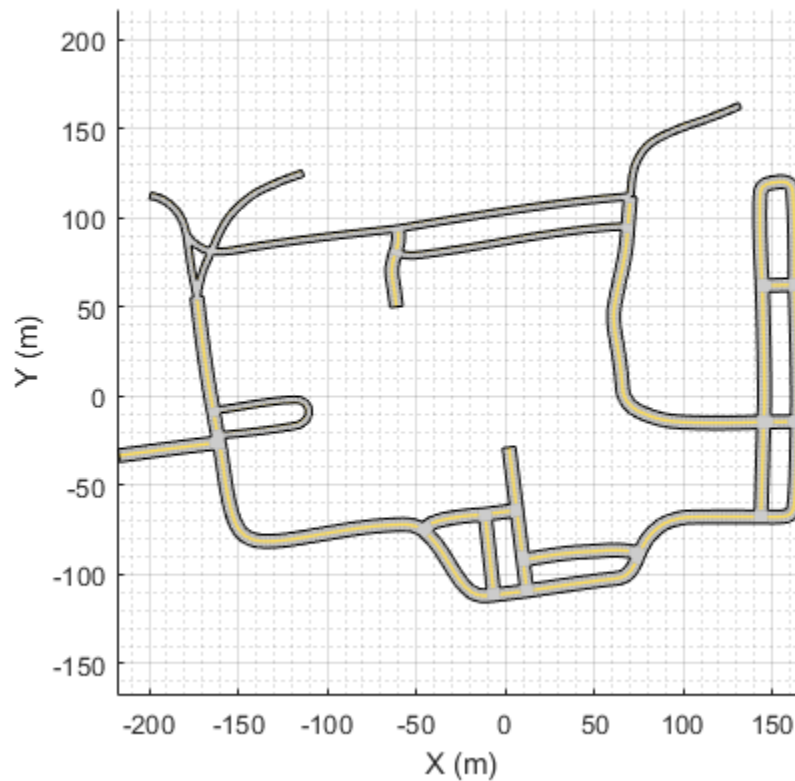

Load the latitude and longitude coordinates for a driving route in this road network.

```
data = load('geoRouteAH.mat');
lat = data.latitude;
lon = data.longitude;
```

Use the `latlon2local` function to convert the driving route from geographic coordinates to local east-north-up (ENU) Cartesian coordinates used in the driving scenario. For the origin of the ENU coordinate system, use the geographic road network origin stored in the `GeoReference` property of the scenario. The origin is the first coordinate specified in the driving route. Because the driving route contains only latitudinal and longitudinal data, set the altitude to 0.

```
alt = 0;
origin = scenario.GeoReference;
[xEast,yNorth,zUp] = latlon2local(lat,lon,alt,origin);
```

Add a vehicle to the driving scenario. Specify the converted driving route as the trajectory of the vehicle. Set a vehicle speed of 30 meters per second. Plot the vehicle trajectory and pause every 0.01 seconds to slow down the simulation.

```
v = vehicle(scenario, 'ClassID', 1);
speed = 30;
smoothTrajectory(v, [xEast,yNorth,zUp], speed);

while advance(scenario)
    pause(0.01)
end
```

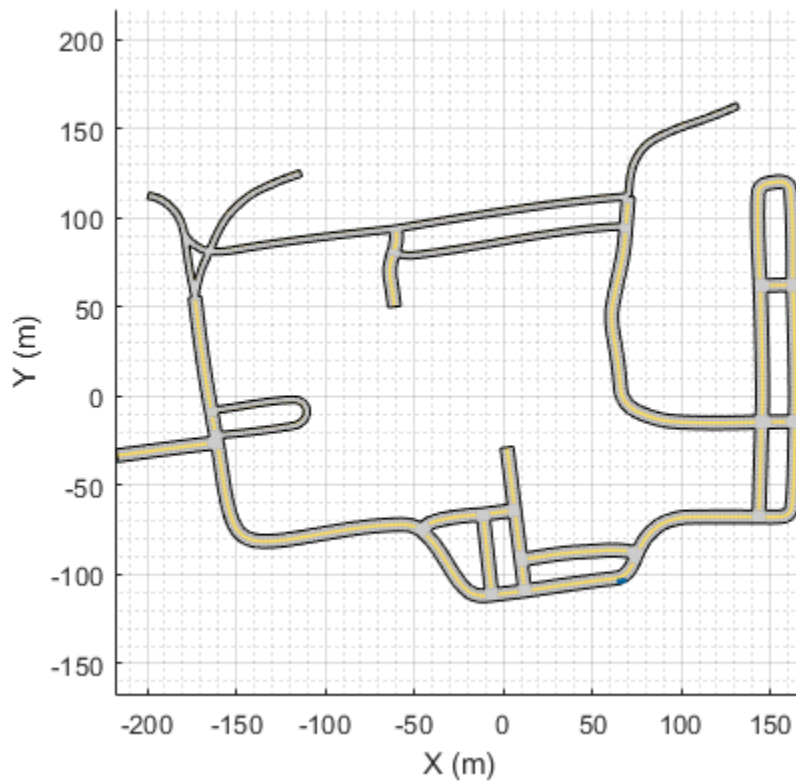

Import Zenrin Japan Map 3.0 (Itsumo NAVI API 3.0) Roads Using Specified Coordinates

Import Zenrin Japan Map 3.0 (Itsumo NAVI API 3.0) road network data that is nearest to the coordinates of a specified driving route into a driving scenario. Plot a vehicle following this route in the driving scenario.

Load a sequence of geographic coordinates that correspond to a driving route.

```
data = load('tokyoSequence.mat');  
lat = data.latitude;  
lon = data.longitude;
```

Display the route by streaming the coordinates on a geographic player. Set the zoom level to 17 and configure the player to display all points in its history. To speed up the streaming, plot only every tenth coordinate in the route.

```
zoomLevel = 17;  
player = geoplayer(lat(1),lon(1),zoomLevel,'HistoryDepth',Inf);  
timestep = 10;  
  
for i = 1:timestep:length(lat)  
    plotPosition(player,lat(i),lon(i));  
end
```

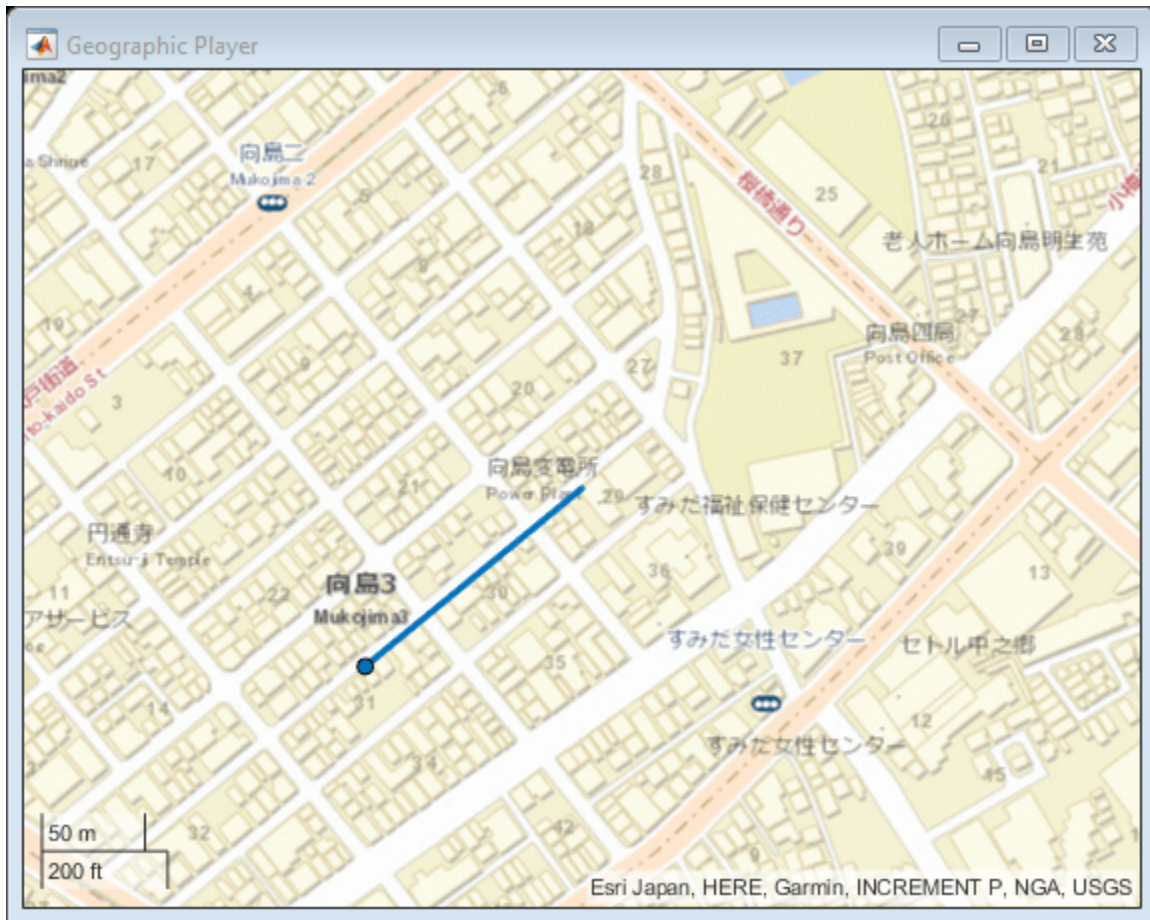
Create a driving scenario. Import the Zenrin Japan Map 3.0 (Itsumo NAVI API 3.0) road data that is nearest to the driving route into the scenario.

```
scenario = drivingScenario;
roadNetwork(scenario, 'ZenrinJapanMap', lat, lon)
```

Use the `latlon2local` function to convert the driving route from geographic coordinates to local east-north-up (ENU) Cartesian coordinates used in the driving scenario. For the origin of the ENU coordinate system, use the geographic road network origin stored in the `GeoReference` property of the scenario. The origin is the first coordinate specified in the driving route.

```
alt = 0;
origin = scenario.GeoReference;
[xEast,yNorth,zUp] = latlon2local(lat,lon,alt,origin);
```

Add a vehicle to the driving scenario. Specify the converted driving route as the trajectory of the vehicle. Set a vehicle speed of 30 meters per second.

```
v = vehicle(scenario, 'ClassID', 1);
speed = 30;
smoothTrajectory(v, [xEast,yNorth,zUp], speed);
```

Plot the scenario and pause every 0.01 seconds to slow down the simulation. To maintain the same alignment with geographic coordinate displays, the X-axis is on the bottom and the Y-axis is on the

left. In driving scenarios not imported from maps, the X-axis is on the left and the Y-axis is on the bottom. This alignment is consistent with the Automated Driving Toolbox™ world coordinate system.

```
figure
plot(scenario)
while advance(scenario)
    pause(0.01)
end
```

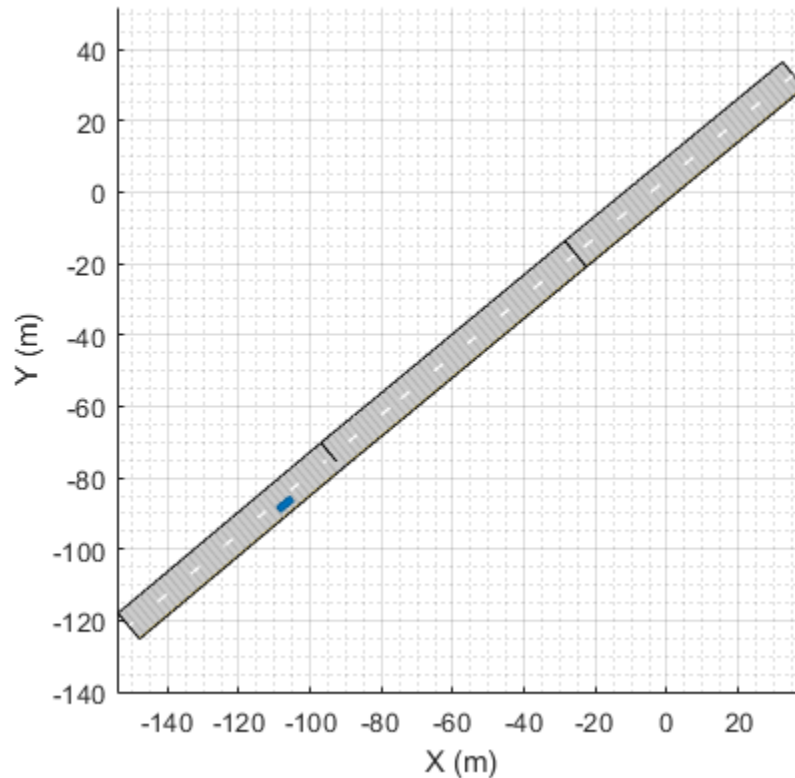

Import Zenrin Japan Map 3.0 (Itsumo NAVI API 3.0) Roads Using Specified Region

Import Zenrin Japan Map 3.0 (Itsumo NAVI API 3.0) road network data into a driving scenario. Select this data from a region that is centered around a specified geographic coordinate.

Define latitude and longitude coordinates corresponding to a park.

```
latCenter = 35.6889;
lonCenter = 139.8458;
```

Specify the minimum and maximum latitude and longitude coordinates for a rectangular region around the park. Display a bounding box corresponding to this region on a geographic plot.

```
offset = 0.0013;
minLat = latCenter - offset;
minLon = lonCenter - offset;
```

```

maxLat = latCenter + offset;
maxLon = lonCenter + offset;

figure
gx = geoaxes;
LineStyle = '-k';
geoplot(gx, ...
        [minLat maxLat],[minLon minLon],LineStyle, ...
        [maxLat maxLat],[minLon maxLon],LineStyle, ...
        [maxLat minLat],[maxLon maxLon],LineStyle, ...
        [minLat minLat],[maxLon minLon],LineStyle)

```

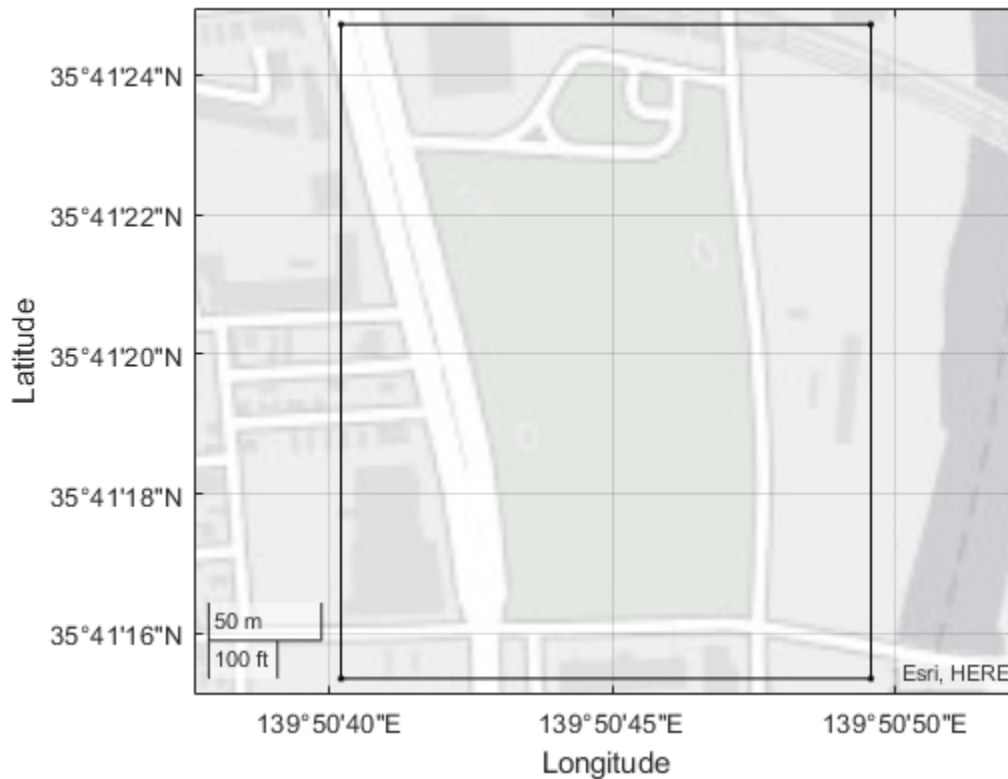

Create a driving scenario and import roads from the region by using the minimum and maximum coordinates. The `roadNetwork` function imports roads that are at least partially within this region.

```

scenario = drivingScenario;
roadNetwork(scenario, 'ZenrinJapanMap', minLat, minLon, maxLat, maxLon)

```

Plot the scenario. To maintain the same alignment with geographic coordinate displays, the X-axis is on the bottom and the Y-axis is on the left. In driving scenarios not imported from maps, the X-axis is on the left and the Y-axis is on the bottom. This alignment is consistent with the Automated Driving Toolbox™ world coordinate system.

```

figure
plot(scenario)

```

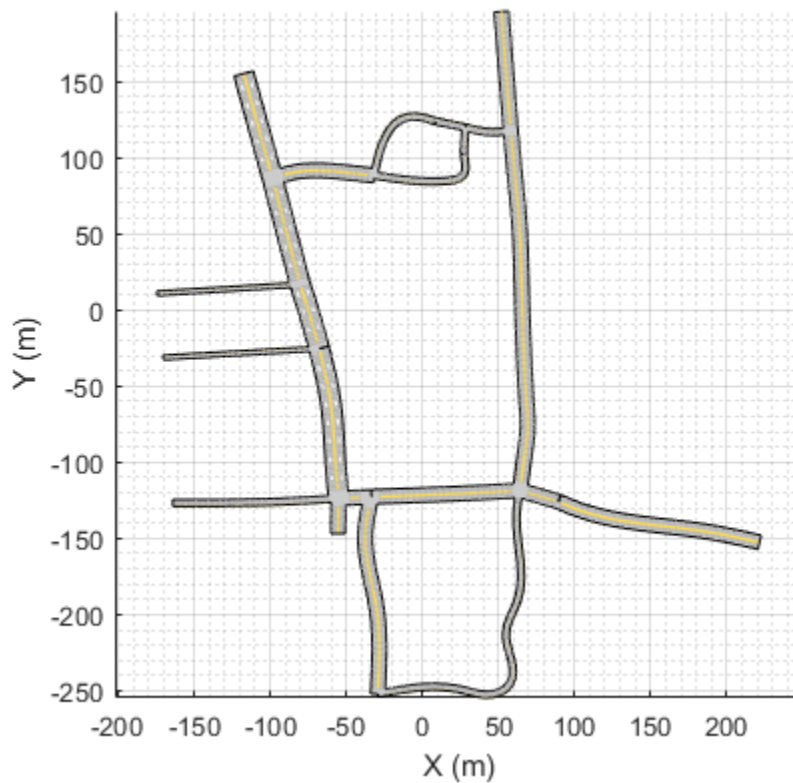

Input Arguments

scenario — Driving scenario

drivingScenario object

Driving scenario, specified as a `drivingScenario` object. `scenario` must contain no previously created or imported roads.

filename — Name of road network file

character vector | string scalar

Name of the road network file, specified as a character vector or string scalar.

`filename` must specify a file in the current folder, a file that is on the MATLAB search path, or a full or relative path to a file.

`filename` must end with a file extension that is valid for the source of the road network.

Road Network Source	Valid File Extensions	Sample Syntax
OpenDRIVE	.xodr .xml	<code>roadNetwork(scenario, ... 'OpenDRIVE', 'C:\Desktop\roads.xodr')</code>

Road Network Source	Valid File Extensions	Sample Syntax
OpenStreetMap	.osm .xml	roadNetwork(scenario, ... 'OpenStreetMap', 'C:\Desktop\map.osm





showLaneTypes — Import lane type information

true or 1 (default) | false or 0

Import lane type information from the OpenDRIVE road network file and display it in the driving scenario, specified as a comma-separated pair consisting of 'ShowLaneTypes' and one of these values:

- true or 1 — Import lane type information and render lane types.
- false or 0 — Ignore lane type information and import all lanes as driving lanes in the driving scenario.

The table summarized the supported lane types and their default appearance after importing them into the driving scenario.

Supported Lane Types	Description	Default Appearance
Driving lanes	Lanes for driving	
Border lanes	Lanes at the road borders	
Restricted lanes	Lanes reserved for high-occupancy vehicles	
Shoulder lanes	Lanes reserved for emergency stopping	
Parking lanes	Lanes alongside driving lanes, intended for parking vehicles	

Any other unsupported lane types are rendered as border lanes.

Example: 'ShowLaneTypes', false

lat — Latitude coordinates

vector of elements in range [-90, 90]

Latitude coordinates, specified as a vector of elements in the range [-90, 90]. lat must be the same size as lon. Units are in degrees.

lon — Longitude coordinates

vector of elements in range [-180, 180]

Longitude coordinates, specified as a vector of elements in the range [-180, 180]. `lon` must be the same size as `lat`. Units are in degrees.

minLat — Minimum latitude coordinate of bounding box

scalar in range [-90, 90]

Minimum latitude coordinate of the bounding box, specified as a scalar in the range [-90, 90]. `minLat` must be less than `maxLat`. Units are in degrees.

The `roadNetwork` function imports any roads that are at least partially within the bounding box specified by inputs `minLat`, `minLon`, `maxLat`, and `maxLon`. This diagram displays the relationship between these coordinates.

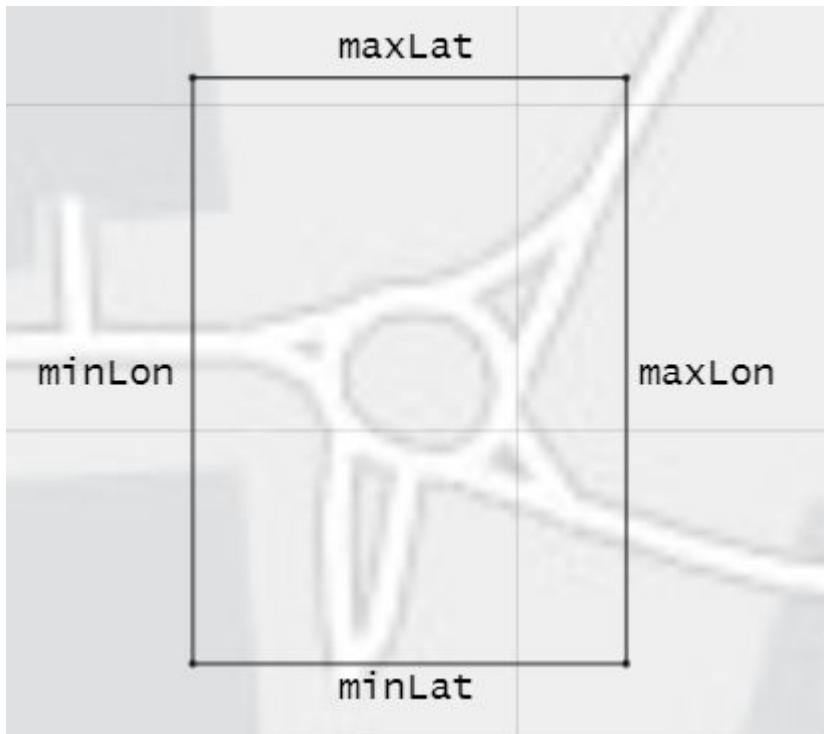
**minLon — Minimum longitude coordinate of bounding box**

scalar in range [-180, 180]

Minimum longitude coordinate of the bounding box, specified as a scalar in the range [-180, 180]. `minLon` must be less than `maxLon`. Units are in degrees.

The `roadNetwork` function imports any roads that are at least partially within the bounding box specified by inputs `minLat`, `minLon`, `maxLat`, and `maxLon`. This diagram displays the relationship between these coordinates.

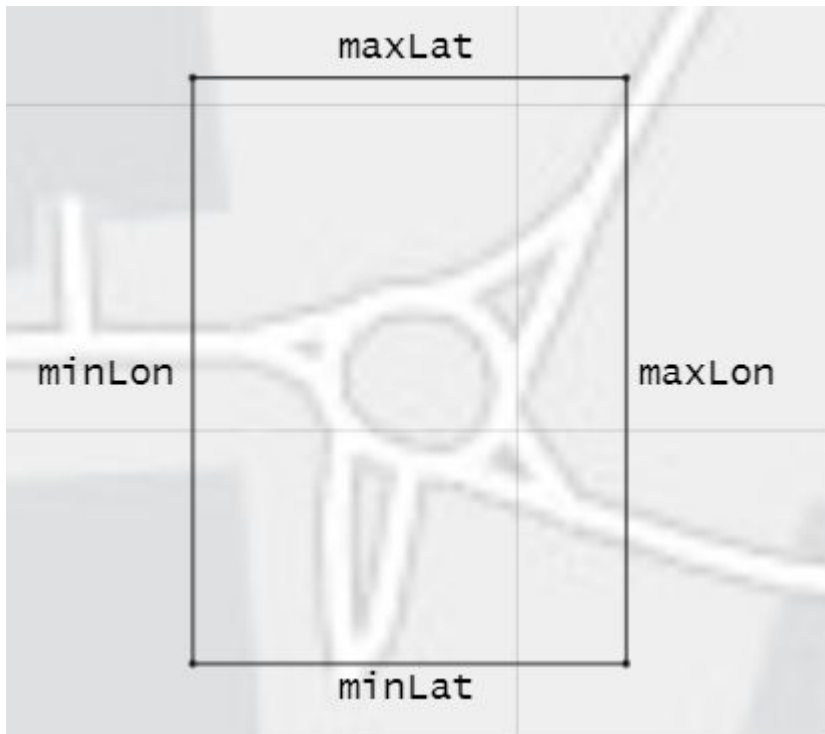
**maxLat — Maximum latitude coordinate of bounding box**

scalar in range [-90, 90]

Maximum latitude coordinate of the bounding box, specified as a scalar in the range [-90, 90]. **maxLat** must be greater than **minLat**. Units are in degrees.

The `roadNetwork` function imports any roads that are at least partially within the bounding box specified by inputs `minLat`, `minLon`, `maxLat`, and `maxLon`. This diagram displays the relationship between these coordinates.

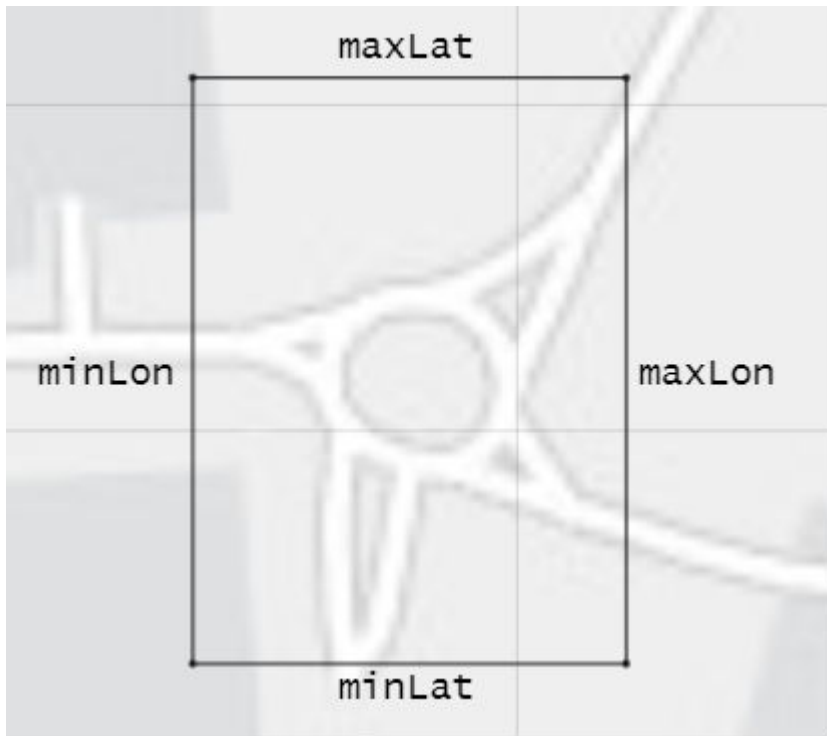

maxLon — Maximum longitude coordinate of bounding box
scalar in range [-180, 180]

Maximum longitude coordinate of the bounding box, specified as a scalar in the range [-180, 180]. maxLon must be greater than minLon. Units are in degrees.

The roadNetwork function imports any roads that are at least partially within the bounding box specified by inputs minLat, minLon, maxLat, and maxLon. This diagram displays the relationship between these coordinates.

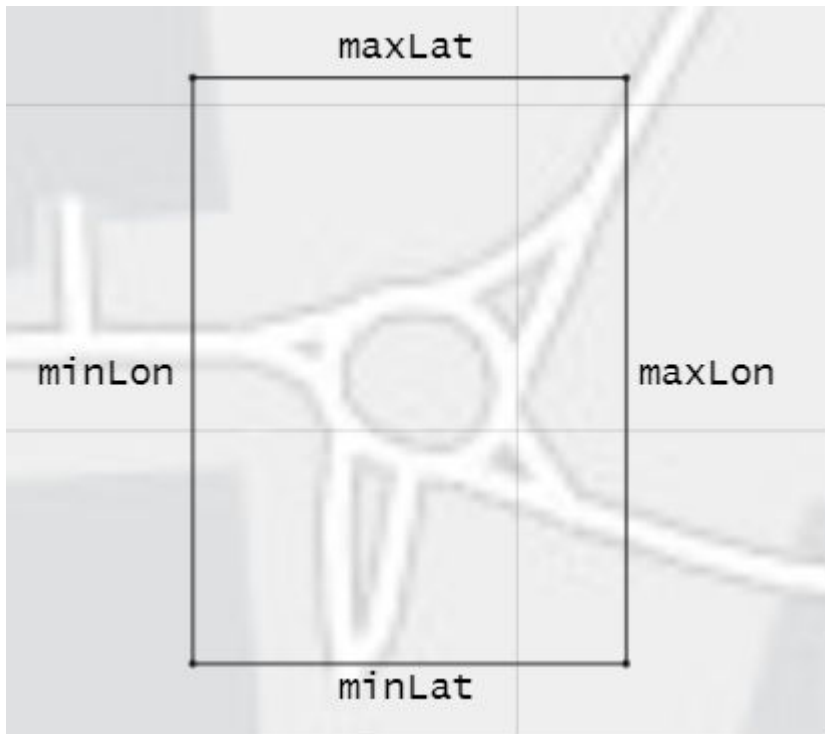

Limitations

OpenDRIVE Import Limitations

- You can import only lanes, lane type information, and roads. The import of road objects and traffic signals is not supported.
- ASAM OpenDRIVE files containing large road networks can take up to several minutes to load. Examples of large road networks include ones that model the roads of a city or ones with roads that are thousands of meters long.
- Lanes with variable widths are not supported. The width is set to the highest width found within that lane. For example, if a lane has a width that varies from 2 meters to 4 meters, the function sets the lane width to 4 meters throughout.
- When you import one-way roads with multiple lane specifications, the function supports only those segment taper positions that match the travel direction of lane. For example, the function supports importing only right taper position for the right lanes. Left or both types of taper position are not supported for right lanes.
- Roads with lane type information specified as `driving`, `border`, `restricted`, `shoulder`, and `parking` are supported. Lanes with any other lane type information are imported as border lanes.
- Lane marking styles `Bott Dots`, `Curbs`, and `Grass` are not supported. Lanes with these marking styles are imported as unmarked.

HERE HD Live Map Import Limitations

- Importing HERE HDLM roads with lanes of varying widths is not supported. In the generated road network, each lane is set to have the maximum width found along its entire length. Consider a HERE HDLM lane with a width that varies from 2 to 4 meters along its length. In the generated

road network, the lane width is 4 meters along its entire length. This modification to road networks can sometimes cause roads to overlap in the driving scenario.

- Some issues with the imported roads might be due to missing or inaccurate map data in the HERE HDLM service. For example, you might see black lines where roads and junctions meet. To check where the issue stems from in the map data, use the HERE HD Live Map Viewer to view the geometry of the HERE HDLM road network. This viewer requires a valid HERE license. For more details, see the HERE Technologies website.

OpenStreetMap Import Limitations

When importing OpenStreetMap data, road and lane features have these limitations:

- Lane-level information is not imported from OpenStreetMap roads. Lane specifications are based only on the direction of travel specified in the OpenStreetMap road network, where:
 - One-way roads are imported as single-lane roads with default lane specifications. These lanes are programmatically equivalent to `lanespec(1)`.
 - Two-way roads are imported as two-lane roads with bidirectional travel and default lane specifications. These lanes are programmatically equivalent to `lanespec([1 1])`.

The table shows these differences in the OpenStreetMap road network and the road network in the imported driving scenario.

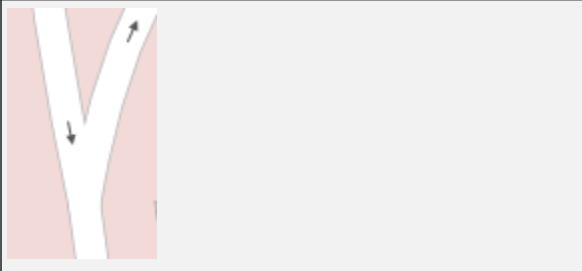
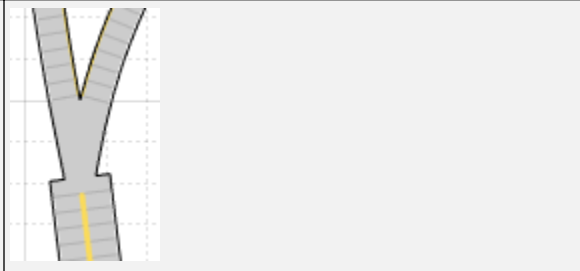
OpenStreetMap Road Network	Imported Driving Scenario
	

- When importing OpenStreetMap road networks that specify elevation data, if elevation data is not specified for all roads being imported, then the generated road network might contain inaccuracies and some roads might overlap.
- OpenStreetMap files containing large road networks can take a long time to load. In addition, these road networks can make some of the app options unusable. To avoid this limitation, import files that contain only an area of interest, typically smaller than 20 square kilometers.
- The basemap used in the app can have slight differences from the map used in the OpenStreetMap service. Some imported road issues might also be due to missing or inaccurate map data in the OpenStreetMap service. To check whether the data is missing or inaccurate due to the map service, consider viewing the map data on an external map viewer.

Zenrin Japan Map API 3.0 (Itsumo NAVI API 3.0) Import Limitations

When you import Zenrin Japan Map API 3.0 (Itsumo NAVI API 3.0) data, the generated road network has these limitations. As a result of these limitations, the generated network might contain inaccuracies and the roads might overlap.

- The generated road network uses road elevation data when the Zenrin Japan Map API 3.0 (Itsumo NAVI API 3.0) provides it. Otherwise, the generated network uses terrain elevation data provided by the service.

- When the Zenrin Japan Map API 3.0 (Itsumo NAVI API 3.0) service provides information using a range, such as by specifying a road with two to three lanes or a road between 3-5.5 meters wide, the generated road network uses scalar values instead. Consider a Zenrin Japan Map API 3.0 (Itsumo NAVI API 3.0) road that has two to three lanes. The generated road network has two lanes.
- Lanes within roads in the generated network have a uniform width. Consider a road that is 4.25 meters wide with two lanes. In the generated road network, each lane is 2.125 meters wide.
- Where possible, the generated road network uses road names provided by the Zenrin Japan Map API 3.0 (Itsumo NAVI API 3.0) service. Otherwise, the generated road network uses default names, such as Road1 and Road2.

Tips

- If the roads that you import do not look as expected, consider importing them by using the Driving Scenario Designer app. The app can make the process of troubleshooting and correcting roads easier than trying to troubleshoot and correct them by using the roadNetwork function.

Version History

Introduced in R2018b

See Also

Apps

Driving Scenario Designer

Objects

drivingScenario

Functions

actor | vehicle | export

Topics

“Import ASAM OpenDRIVE Roads into Driving Scenario”

“Import HERE HD Live Map Roads into Driving Scenario”

“Import OpenStreetMap Data into Driving Scenario”

“Import Zenrin Japan Map API 3.0 (Itsumo NAVI API 3.0) into Driving Scenario”

“Scenario Generation from Recorded Vehicle Data”

“Export Driving Scenario to ASAM OpenSCENARIO File”

“Export Driving Scenario to ASAM OpenDRIVE File”

External Websites

ASAM OpenDRIVE

HERE Technologies

openstreetmap.org

ZENRIN DataCom CO., LTD.

roadBoundaries

Package:

Get road boundaries

Syntax

```
rbdry = roadBoundaries(scenario)
rbdry = roadBoundaries(ac)
```

Description

`rbdry = roadBoundaries(scenario)` returns the road boundaries, `rbdry`, of a driving scenario, `scenario`.

`rbdry = roadBoundaries(ac)` returns the road boundaries that the actor, `ac`, follows in a driving scenario.

Examples

Create Driving Scenario with Multiple Actors and Roads

Create a driving scenario containing a curved road, two straight roads, and two actors: a car and a bicycle. Both actors move along the road for 60 seconds.

Create the driving scenario object.

```
scenario = drivingScenario('SampleTime',0.1,'StopTime',60);
```

Create the curved road using road center points following the arc of a circle with an 800-meter radius. The arc starts at 0°, ends at 90°, and is sampled at 5° increments.

```
angs = [0:5:90]';
R = 800;
roadcenters = R*[cosd(angs) sind(angs) zeros(size(angs))];
roadwidth = 10;
cr = road(scenario,roadcenters,roadwidth);
```

Add two straight roads with the default width, using road center points at each end. To the first straight road add barriers on both road edges.

```
roadcenters = [700 0 0; 100 0 0];
sr1 = road(scenario,roadcenters);
barrier(scenario,sr1)
barrier(scenario,sr1,'RoadEdge','left')
roadcenters = [400 400 0; 0 0 0];
road(scenario,roadcenters);
```

Get the road boundaries.

```
rbdry = roadBoundaries(scenario);
```

Add a car and a bicycle to the scenario. Position the car at the beginning of the first straight road.

```
car = vehicle(scenario, 'ClassID', 1, 'Position', [700 0 0], ...
    'Length', 3, 'Width', 2, 'Height', 1.6);
```

Position the bicycle farther down the road.

```
bicycle = actor(scenario, 'ClassID', 3, 'Position', [706 376 0]', ...
    'Length', 2, 'Width', 0.45, 'Height', 1.5);
```

Plot the scenario.

```
plot(scenario, 'Centerline', 'on', 'RoadCenters', 'on');
title('Scenario');
```

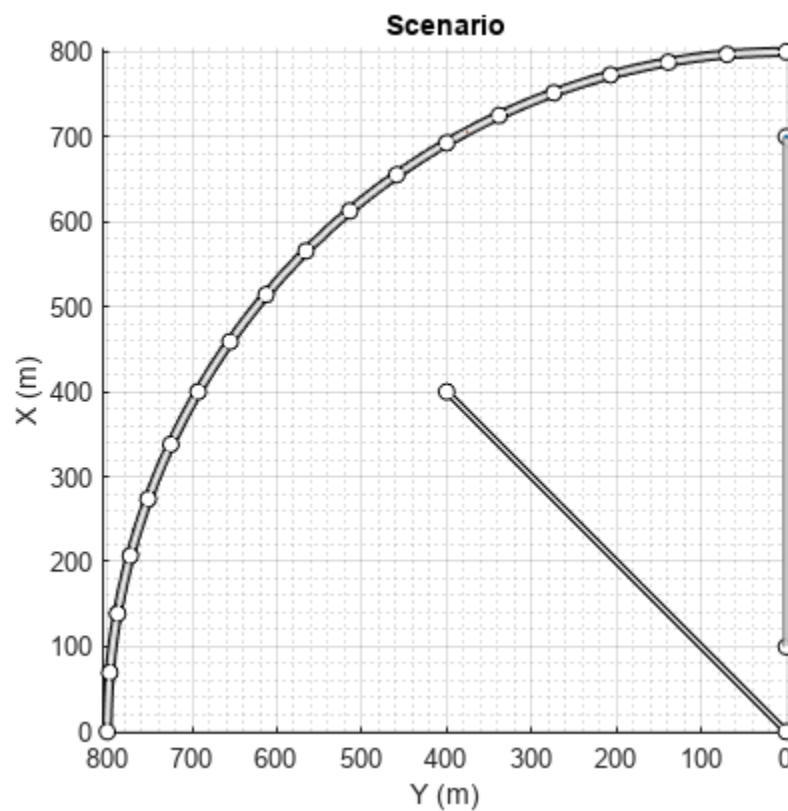

Display the actor poses and profiles.

```
allActorPoses = actorPoses(scenario)
```

```
allActorPoses=242x1 struct array with fields:
```

```
ActorID
Position
Velocity
Roll
Pitch
Yaw
AngularVelocity
```

```
allActorProfiles = actorProfiles(scenario)

allActorProfiles=242x1 struct array with fields:
    ActorID
    ClassID
    Length
    Width
    Height
    OriginOffset
    MeshVertices
    MeshFaces
    RCSPattern
    RCSAzimuthAngles
    RCSElevationAngles
```

Because there are barriers in this scenario, and each barrier segment is considered an actor, `actorPoses` and `actorProfiles` functions return the poses of all stationary and non-stationary actors. To only obtain the poses and profiles of non-stationary actors such as vehicles and bicycles, first obtain their corresponding actor IDs using the `scenario.actors.ActorID` property.

```
movableActorIDs = [scenario.actors.ActorID];
```

Then, use those IDs to filter only non-stationary actor poses and profiles.

```
movableActorPoseIndices = ismember([allActorPoses.ActorID],movableActorIDs);
```

```
movableActorPoses = allActorPoses(movableActorPoseIndices)
```

```
movableActorPoses=2x1 struct array with fields:
    ActorID
    Position
    Velocity
    Roll
    Pitch
    Yaw
    AngularVelocity
```

```
movableActorProfiles = allActorProfiles(movableActorPoseIndices)
```

```
movableActorProfiles=2x1 struct array with fields:
    ActorID
    ClassID
    Length
    Width
    Height
    OriginOffset
    MeshVertices
    MeshFaces
    RCSPattern
    RCSAzimuthAngles
    RCSElevationAngles
```

Create and Display Road Boundaries

Create a driving scenario containing a figure-8 road specified in the world coordinates of the scenario. Convert the world coordinates of the scenario to the coordinate system of the ego vehicle.

Create an empty driving scenario.

```
scenario = drivingScenario;
```

Add a figure-8 road to the scenario. Display the scenario.

```
roadCenters = [0  0  1
               20 -20 1
               20  20 1
              -20 -20 1
              -20  20 1
               0  0  1];

roadWidth = 3;
bankAngle = [0 15 15 -15 -15 0];
road(scenario, roadCenters, roadWidth, bankAngle);
plot(scenario)
```

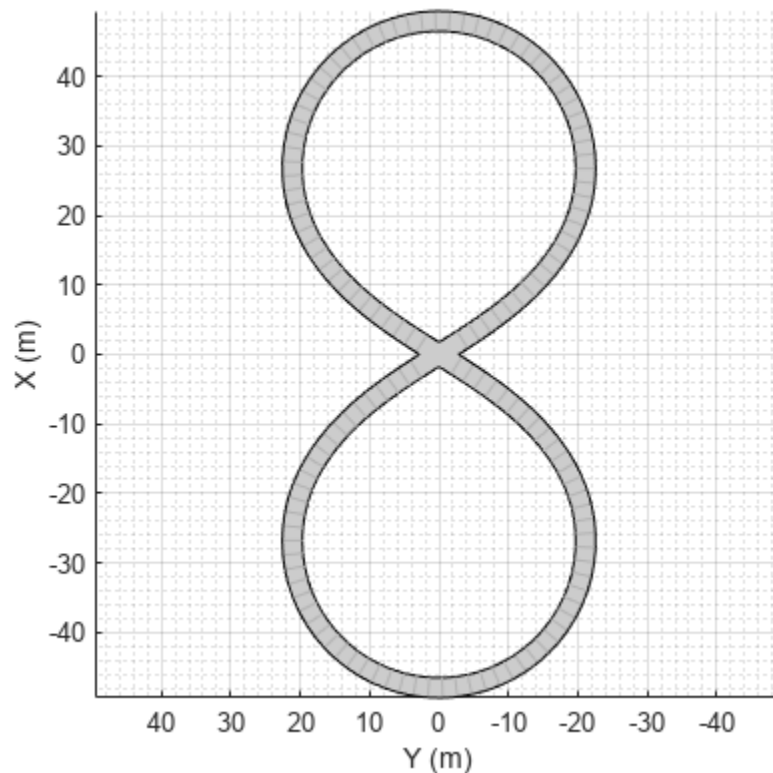

Add an ego vehicle to the scenario. Position the vehicle at world coordinates (20, -20) and orient it at a -15 degree yaw angle.

```
ego = actor(scenario, 'ClassID', 1, 'Position', [20 -20 0], 'Yaw', -15);
```

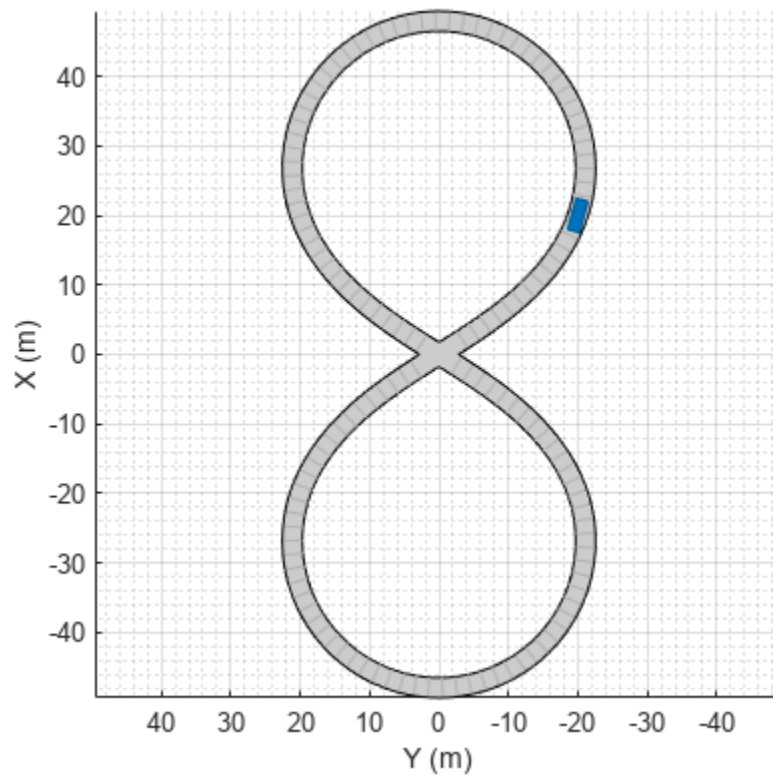

Obtain the road boundaries in ego vehicle coordinates by using the `roadBoundaries` function. Specify the ego vehicle as the input argument.

```
rbEgo1 = roadBoundaries(ego);
```

Display the result on a bird's-eye plot.

```
bep = birdsEyePlot;  
lbp = laneBoundaryPlotter(bep, 'DisplayName', 'Road');  
plotLaneBoundary(lbp, rbEgo1)
```

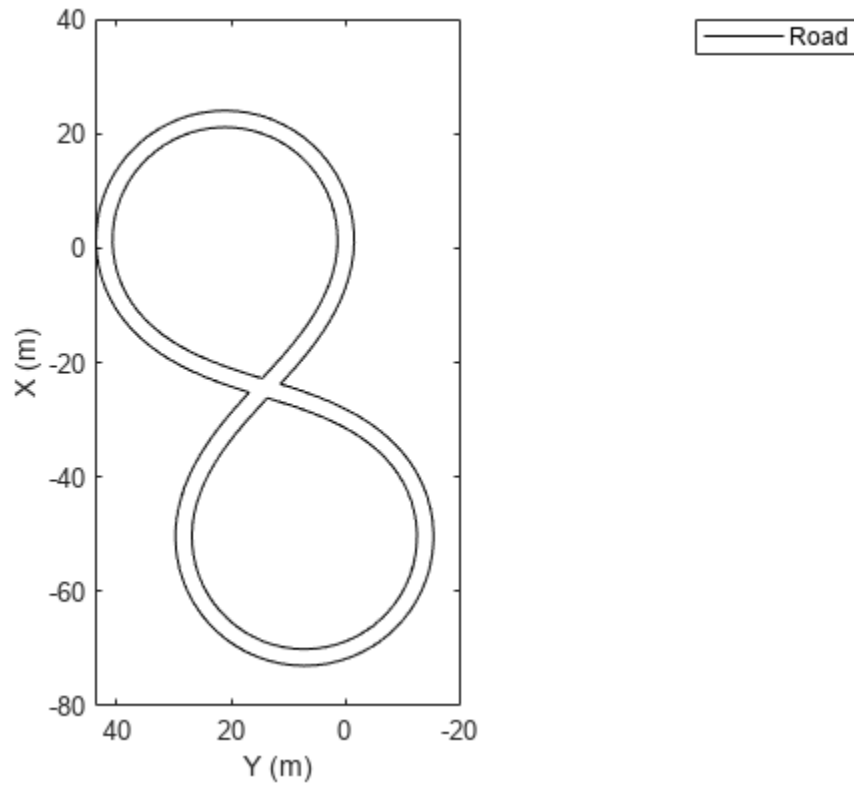
Obtain the road boundaries in world coordinates by using the `roadBoundaries` function. Specify the scenario as the input argument.

```
rbScenario = roadBoundaries(scenario);
```

Obtain the road boundaries in ego vehicle coordinates by using the `driving.scenario.roadBoundariesToEgo` function.

```
rbEgo2 = driving.scenario.roadBoundariesToEgo(rbScenario,ego);
```

Display the road boundaries on a bird's-eye plot.

```
bep = birdsEyePlot;  
lbp = laneBoundaryPlotter(bep, 'DisplayName', 'Road boundaries');  
plotLaneBoundary(lbp, {rbEgo2})
```

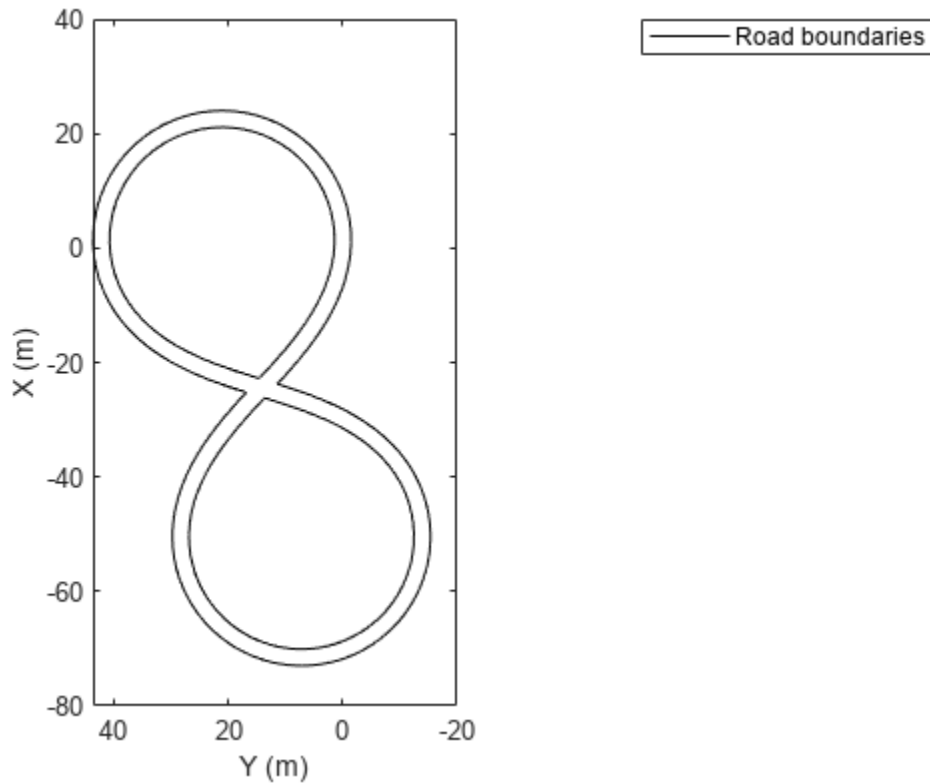

Input Arguments

scenario – Driving scenario

`drivingScenario` object

Driving scenario, specified as a `drivingScenario` object.

ac – Actor

Actor object | Vehicle object

Actor belonging to a `drivingScenario` object, specified as an `Actor` or `Vehicle` object. To create these objects, use the `actor` and `vehicle` functions, respectively.

Output Arguments

rbdry – Road boundaries

cell array

Road boundaries, returned as a cell array. Each cell in the cell array contains a real-valued N -by-3 matrix representing a road boundary in the scenario, where N is the number of road boundaries. Each row of the matrix corresponds to the (x, y, z) coordinates of a road boundary vertex.

When the input argument is a driving scenario, the road coordinates are with respect to the world coordinates of the driving scenario. When the input argument is an actor, the road coordinates are with respect to the actor coordinate system.

The figures show the number of road boundaries that rbdry contains for various road types.

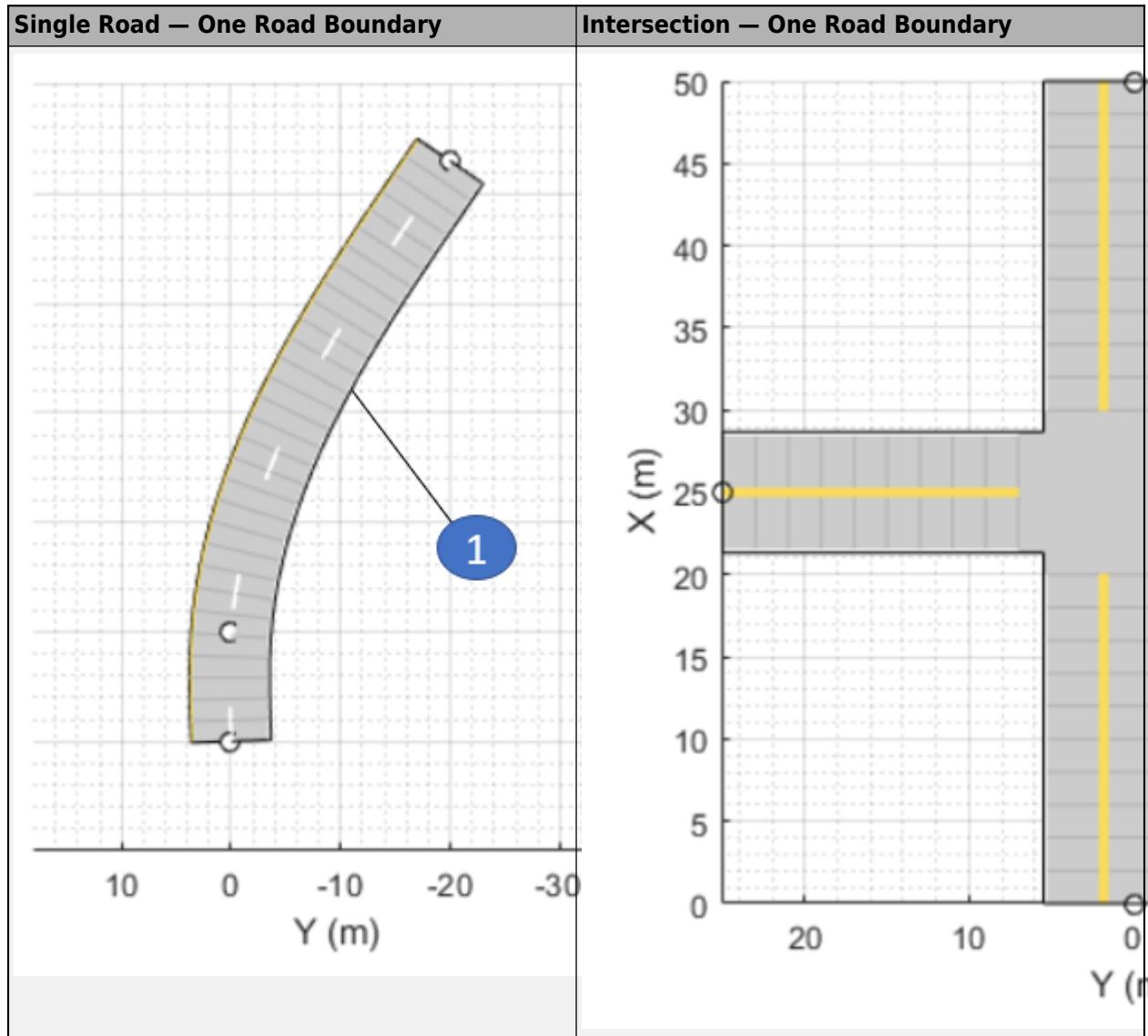

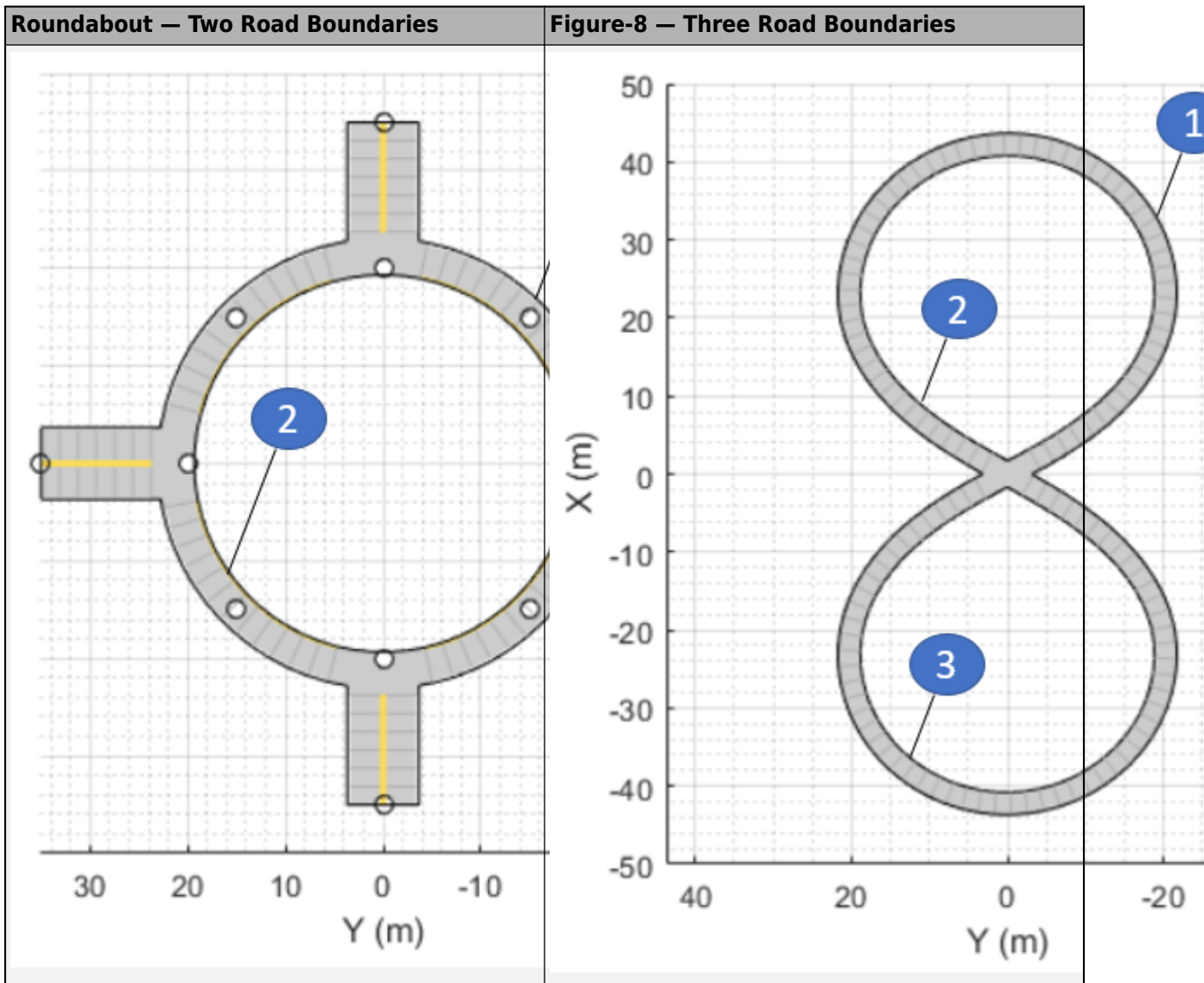

Version History

Introduced in R2017a

See Also

Objects

drivingScenario

Functions

road | actor | vehicle

Topics

“Create Driving Scenario Programmatically”

driving.scenario.roadBoundariesToEgo

Convert road boundaries to ego vehicle coordinates

Syntax

```
egoRoadBoundaries = driving.scenario.roadBoundariesToEgo(
scenarioRoadBoundaries,ego)
egoRoadBoundaries = driving.scenario.roadBoundariesToEgo(
scenarioRoadBoundaries,egoPose)
```

Description

`egoRoadBoundaries = driving.scenario.roadBoundariesToEgo(scenarioRoadBoundaries,ego)` converts road boundaries from the world coordinates of a driving scenario to the coordinate system of the ego vehicle, `ego`.

`egoRoadBoundaries = driving.scenario.roadBoundariesToEgo(scenarioRoadBoundaries,egoPose)` converts road boundaries from world coordinates to vehicle coordinates using the pose of the ego vehicle, `egoPose`.

Examples

Create and Display Road Boundaries

Create a driving scenario containing a figure-8 road specified in the world coordinates of the scenario. Convert the world coordinates of the scenario to the coordinate system of the ego vehicle.

Create an empty driving scenario.

```
scenario = drivingScenario;
```

Add a figure-8 road to the scenario. Display the scenario.

```
roadCenters = [0  0  1
               20 -20 1
               20  20 1
              -20 -20 1
              -20  20 1
               0  0  1];

roadWidth = 3;
bankAngle = [0 15 15 -15 -15 0];
road(scenario,roadCenters,roadWidth,bankAngle);
plot(scenario)
```

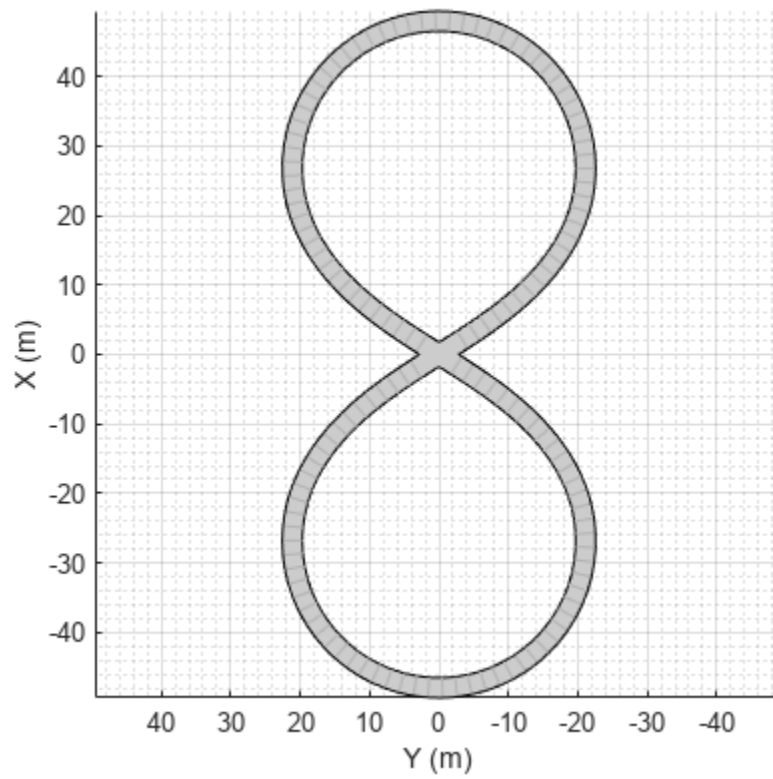

Add an ego vehicle to the scenario. Position the vehicle at world coordinates (20, -20) and orient it at a -15 degree yaw angle.

```
ego = actor(scenario, 'ClassID', 1, 'Position', [20 -20 0], 'Yaw', -15);
```

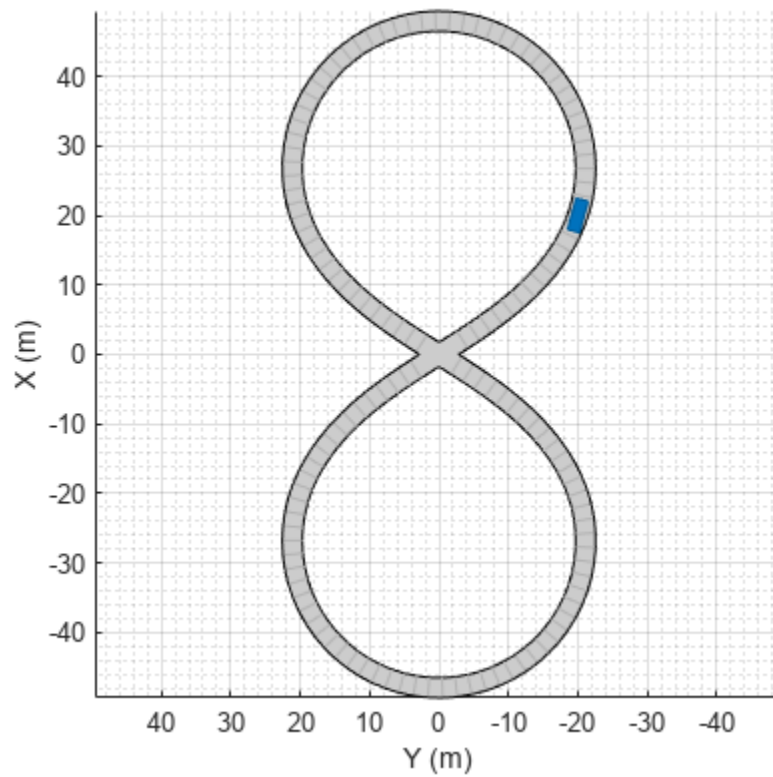

Obtain the road boundaries in ego vehicle coordinates by using the `roadBoundaries` function. Specify the ego vehicle as the input argument.

```
rbEgo1 = roadBoundaries(ego);
```

Display the result on a bird's-eye plot.

```
bep = birdsEyePlot;  
lbp = laneBoundaryPlotter(bep, 'DisplayName', 'Road');  
plotLaneBoundary(lbp, rbEgo1)
```

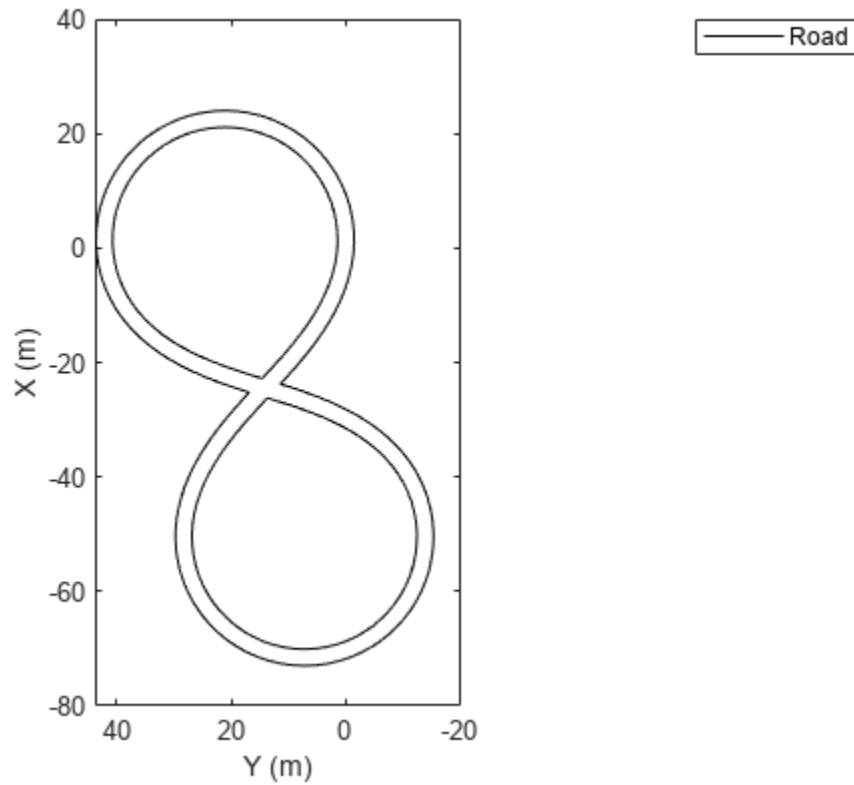

Obtain the road boundaries in world coordinates by using the `roadBoundaries` function. Specify the scenario as the input argument.

```
rbScenario = roadBoundaries(scenario);
```

Obtain the road boundaries in ego vehicle coordinates by using the `driving.scenario.roadBoundariesToEgo` function.

```
rbEgo2 = driving.scenario.roadBoundariesToEgo(rbScenario, ego);
```

Display the road boundaries on a bird's-eye plot.

```
bep = birdsEyePlot;  
lbp = laneBoundaryPlotter(bep, 'DisplayName', 'Road boundaries');  
plotLaneBoundary(lbp, {rbEgo2})
```

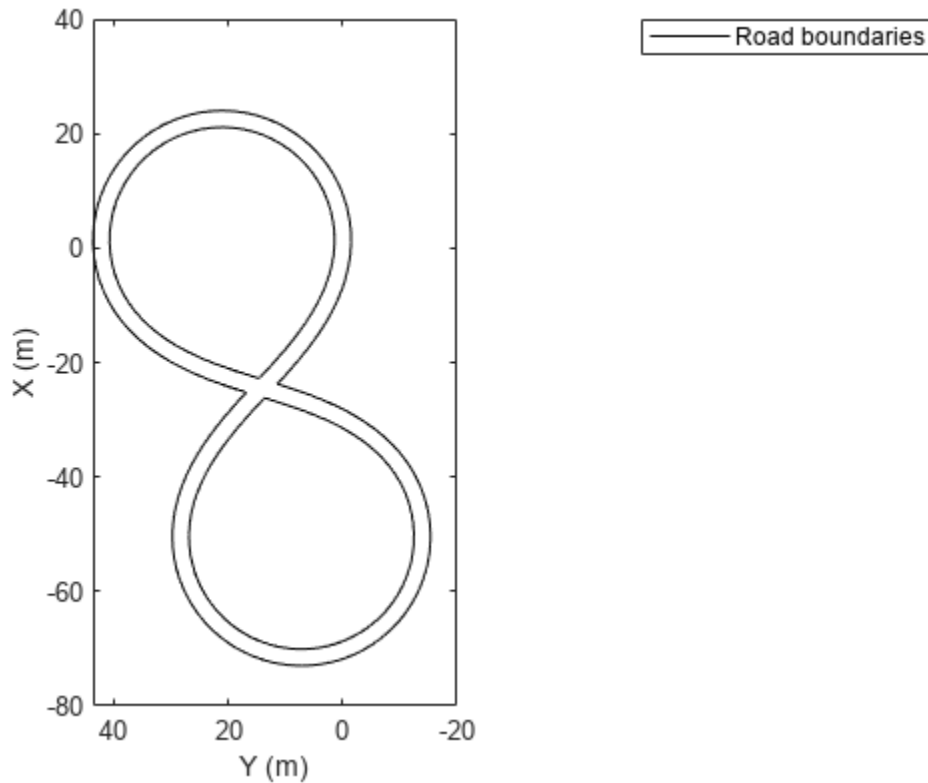
Input Arguments

scenarioRoadBoundaries — Road boundaries of scenario in world coordinates

1-by- N cell array

Road boundaries of the scenario in world coordinates, specified as a 1-by- N cell array. N is the number of road boundaries within the scenario. Each cell corresponds to a road and contains the (x, y, z) coordinates of the road boundaries in a real-valued P -by-3 matrix. P is the number of boundaries and varies from cell to cell. Units are in meters.

ego — Ego vehicle

Actor object | Vehicle object

Ego vehicle, specified as an Actor or Vehicle object. To create these objects, use the `actor` and `vehicle` functions, respectively.

egoPose — Ego actor pose

structure

Ego actor pose in the world coordinates of a driving scenario, specified as a structure.

The ego actor pose structure must contain at least these fields.

Field	Description
ActorID	Scenario-defined actor identifier, specified as a positive integer.
Position	Position of actor, specified as a real-valued vector of the form $[x \ y \ z]$. Units are in meters.
Velocity	Velocity (v) of actor in the x - y -, and z -directions, specified as a real-valued vector of the form $[v_x \ v_y \ v_z]$. Units are in meters per second.
Roll	Roll angle of actor, specified as a real-valued scalar. Units are in degrees.
Pitch	Pitch angle of actor, specified as a real-valued scalar. Units are in degrees.
Yaw	Yaw angle of actor, specified as a real-valued scalar. Units are in degrees.
AngularVelocity	Angular velocity (ω) of actor in the x -, y -, and z -directions, specified as a real-valued vector of the form $[\omega_x \ \omega_y \ \omega_z]$. Units are in degrees per second.

For full definitions of these structure fields, see the `actor` and `vehicle` functions.

Output Arguments

egoRoadBoundaries — Road boundaries in ego vehicle coordinates

real-valued Q -by-3 matrix

Road boundaries in ego vehicle coordinates, returned as a real-valued Q -by-3 matrix. Q is the number of road boundary point coordinates of the form (x, y, z) .

All road boundaries are contained in the same matrix, with a row of NaN values separating points in different road boundaries. For example, if the input has three road boundaries of length P_1 , P_2 , and P_3 , then $Q = P_1 + P_2 + P_3 + 2$. Units are in meters.

Version History

Introduced in R2017a

See Also

Objects

`drivingScenario`

Functions

`targetPoses` | `vehicle` | `actor` | `actorPoses` | `road` | `roadBoundaries` | `driving.scenario.targetsToEgo` | `driving.scenario.targetsToScenario`

currentLane

Package:

Get current lane of actor

Syntax

```
cl = currentLane(ac)
[cl,numlanes] = currentLane(ac)
```

Description

`cl = currentLane(ac)` returns the current lane, `cl`, of an actor, `ac`.

`[cl,numlanes] = currentLane(ac)` also returns the number of road lanes, `numlanes`.

Examples

Find Current Lanes of Two Cars

Obtain the current lane boundaries of cars during a driving scenario simulation.

Create a driving scenario containing a straight, three-lane road.

```
scenario = drivingScenario;
roadCenters = [0 0; 80 0];
road(scenario,roadCenters,'Lanes',lanespec([1 2],'Width',3));
```

Add an ego vehicle moving at 20 meters per second and a target vehicle moving at 10 meters per second.

```
ego = vehicle(scenario,'ClassID',1,'Position',[5 0 0], ...
    'Length',3,'Width',2,'Height',1.6);
smoothTrajectory(ego,[1 0 0; 20 0 0; 30 0 0;50 0 0],20);

target = vehicle(scenario,'ClassID',1,'Position',[5 0 0], ...
    'Length',3,'Width',2,'Height',1.6);
smoothTrajectory(target,[5 -3 0; 20 -3 0; 30 -3 0;50 -3 0],10);
```

Plot the scenario.

```
plot(scenario)
```

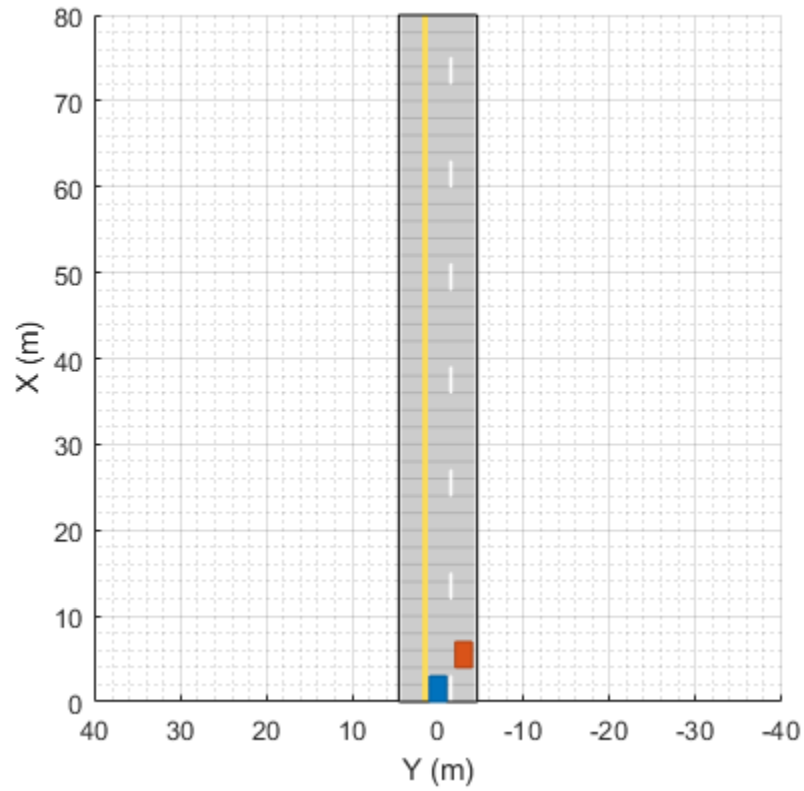

Run the simulation loop.

```
while advance(scenario)
    [cl1,numlanes] = currentLane(ego);
    [cl2,numlanes] = currentLane(target);
end
```

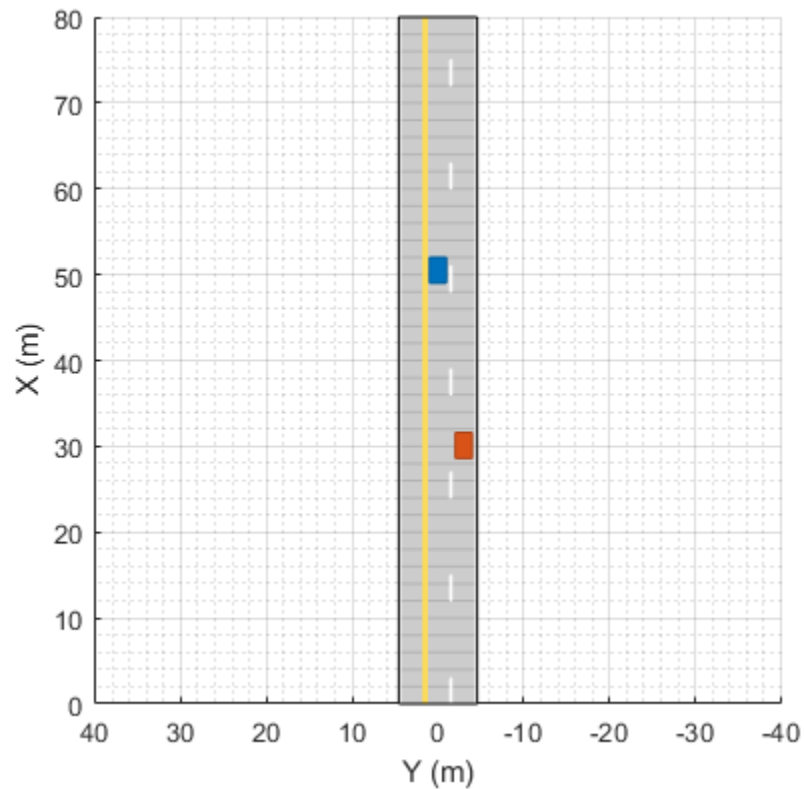

Display the current lane of each vehicle.

```
disp(c1)
disp(c2)

    2

    3
```

Input Arguments

ac – Actor

Actor object | Vehicle object

Actor belonging to a `drivingScenario` object, specified as an `Actor` or `Vehicle` object. To create these objects, use the `actor` and `vehicle` functions, respectively.

Output Arguments

c1 – Current lane of actor

positive integer | []

Current lane of the actor, returned as a positive integer. Lanes are numbered from left to right, relative to the actor, starting from 1. When the actor is not on a road or is on a road without any lanes specified, `c1` is returned as empty, [].

numLanes — Number of lanes on road

positive integer | []

Number of lanes on the road that the actor is traveling on, returned as a positive integer. When the actor is not on a road or is on a road without any lanes specified, numLanes is returned as empty, [].

Version History

Introduced in R2018a

See Also

Objects

drivingScenario | lanespec

Functions

laneBoundaries | actor | vehicle

lanespec

Create road lane specifications

Description

The `lanespec` object defines the lane specifications of a road that was added to a `drivingScenario` object using the `road` function. For more details, see “Lane Specifications” on page 4-609.

Creation

Syntax

```
lanspec = lanespec(numlanes)
lanspec = lanespec(numlanes,Name,Value)
```

Description

`lanspec = lanespec(numlanes)` creates lane specifications for a road having `numlanes` lanes. `numlanes` sets the `NumLanes` property of the `lanespec` object. The order for numbering the lanes on a road depend on the orientation of the road. For more details, see “Draw Direction of Road and Numbering of Lanes” on page 4-606.

`lanspec = lanespec(numlanes,Name,Value)` sets properties on page 4-597 using one or more name-value pairs. For example, `lanespec(3, 'Width', [2.25 3.5 2.25])` specifies a three-lane road with widths from left to right of 2.25 meters, 3.5 meters, and 2.25 meters. For more information on the geometrical properties of a lane, see “Lane Specifications” on page 4-609.

Properties

NumLanes — Number of lanes in road

positive integer | two-element vector of positive integers

This property is read-only.

Number of lanes in the road, specified as a positive integer or two-element vector of positive integers, $[N_L, N_R]$. When `NumLanes` is a positive integer, all lanes flow in the same direction. When `NumLanes` is a vector:

- N_L is the number of left lanes, all flowing in one direction.
- N_R is the number of right lanes, all flowing in the opposite direction.

The total number of lanes in the road is the sum of these vector values: $N = N_L + N_R$.

You can set this property when you create the object. After you create the object, this property is read-only.

Example: `[2 2]` specifies two left lanes and two right lanes.

Width — Lane widths3.6 (default) | positive real scalar | 1-by- N vector of positive real scalars

Lane widths, specified as a positive real scalar or 1-by- N vector of positive real scalars, where N is the number of lanes in the road. N must be equal to `numLanes` and the corresponding value set in the `NumLanes` property.

When `Width` is a scalar, the same value is applied to all lanes. When `Width` is a vector, the vector elements apply to lanes from left to right. Units are in meters.

Example: [3.5 3.7 3.7 3.5]

Data Types: double

Marking — Lane markingsLaneMarking object (default) | SolidMarking object | DashedMarking object | CompoundMarking object | 1-by- M array of lane marking objects

Lane markings of road, specified as one of these values:

- LaneMarking object. This is the default.
- SolidMarking object
- DashedMarking object
- CompoundMarking object
- 1-by- M array of lane marking objects.

M is the number of lane markings. For a road with N lanes, $M = N + 1$.

To create lane marking objects, use the `laneMarking` function and specify the type of lane marking.

'Unmarked'	'Solid'	'Dashed'	'DoubleSolid'	'DoubleDashed'	'SolidDashed'	'DashedSolid'
No lane marking	Solid line	Dashed line	Two solid lines	Two dashed lines	Solid line on left, dashed line on right	Dashed line on left, solid line on right

'Unmarked'	'Solid'	'Dashed'	'DoubleSolid'	'DoubleDashed'	'SolidDashed'	'DashedSolid'

By default, for a one-way road, the rightmost and center lane markings are white and the leftmost lane marking is yellow. For two-way roads, the color of the dividing lane marking is yellow.

Example: `[laneMarking('Solid') laneMarking('DoubleDashed') laneMarking('Solid')]` specifies lane markings for a two-lane road. The leftmost and rightmost lane markings are solid lines, and the dividing lane marking is a double-dashed line.

Type – Lane types

DrivingLaneType object (default) | RestrictedLaneType object | ShoulderLaneType object | ParkingLaneType object | 1-by-*M* array of lane type objects

Lane types of road, specified as a homogeneous lane type object or a 1-by-*M* array of lane type objects. *M* is the number of lane types.

To create lane type objects, use the `laneType` function and specify the type of lane.

'Driving'	'Border'	'Restricted'	'Shoulder'	'Parking'

Example: `[laneType('Shoulder') laneType('Driving')]` specifies the lane types for a two-lane road. The leftmost lane is the shoulder lane and the rightmost lane is the driving lane.

Examples

Create Straight Four-Lane Road

Create a driving scenario and the road centers for a straight, 80-meter road.

```
scenario = drivingScenario;
roadCenters = [0 0; 80 0];
```

Create a lanespec object for a four-lane road. Use the laneMarking function to specify its five lane markings. The center line is double-solid and double yellow. The outermost lines are solid and white. The inner lines are dashed and white.

```
solidW = laneMarking('Solid','Width',0.3);
dashW = laneMarking('Dashed','Space',5);
doubleY = laneMarking('DoubleSolid','Color','yellow');
lspec = lanespec([2 2],'Width',[5 5 5 5], ...
    'Marking',[solidW dashW doubleY dashW solidW]);
```

Add the road to the driving scenario. Display the road.

```
road(scenario,roadCenters,'Lanes',lspec);
plot(scenario)
```

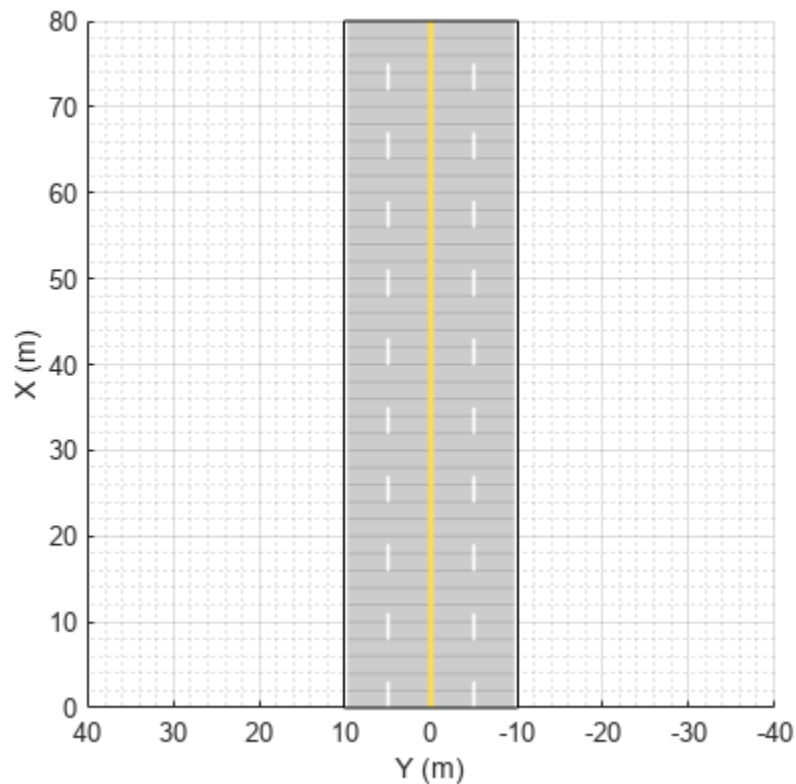

Simulate Car Traveling on S-Curve

Simulate a driving scenario with one car traveling on an S-curve. Create and plot the lane boundaries.

Create the driving scenario with one road having an S-curve.

```
scenario = drivingScenario('StopTime',3);
roadcenters = [-35 20 0; -20 -20 0; 0 0 0; 20 20 0; 35 -20 0];
```

Create the lanes and add them to the road.

```
lm = [laneMarking('Solid','Color','w'); ...
      laneMarking('Dashed','Color','y'); ...
      laneMarking('Dashed','Color','y'); ...
      laneMarking('Solid','Color','w')];
ls = lanespec(3,'Marking',lm);
road(scenario,roadcenters,'Lanes',ls);
```

Add an ego vehicle and specify its trajectory from its waypoints. By default, the car travels at a speed of 30 meters per second.

```
car = vehicle(scenario, ...
             'ClassID',1, ...
             'Position',[-35 20 0]);
waypoints = [-35 20 0; -20 -20 0; 0 0 0; 20 20 0; 35 -20 0];
smoothTrajectory(car,waypoints);
```

Plot the scenario and corresponding chase plot.

```
plot(scenario)
```

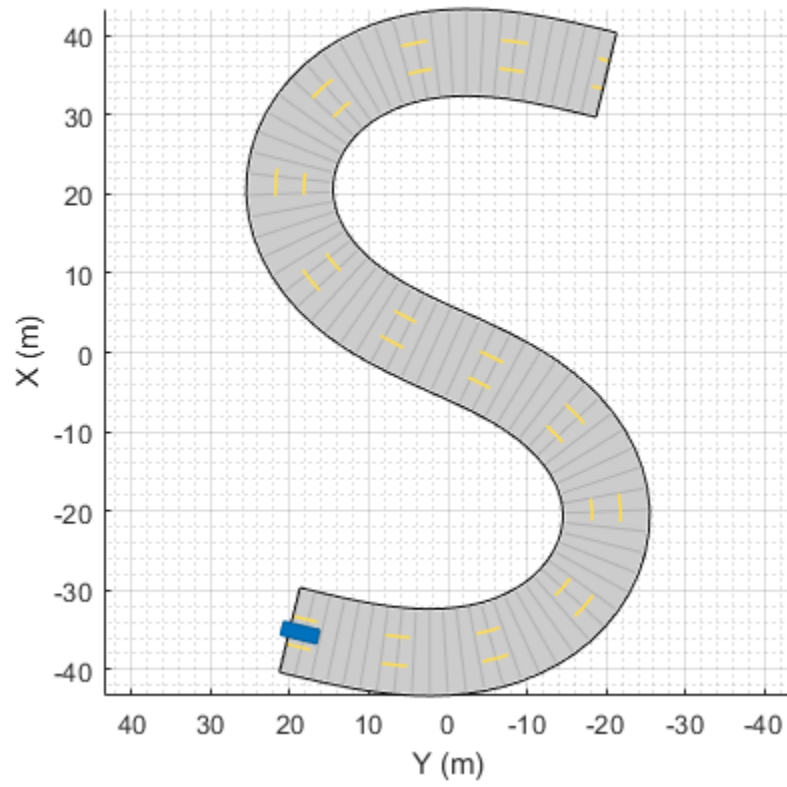

chasePlot(car)



Run the simulation loop.

- 1 Initialize a bird's-eye plot and create an outline plotter, left-lane and right-lane boundary plotters, and a road boundary plotter.
- 2 Obtain the road boundaries and rectangular outlines.
- 3 Obtain the lane boundaries to the left and right of the vehicle.
- 4 Advance the simulation and update the plotters.

```

bep = birdsEyePlot('XLim',[-40 40], 'YLim',[-30 30]);
olPlotter = outlinePlotter(bep);
lblPlotter = laneBoundaryPlotter(bep, 'Color', 'r', 'LineStyle', '-');
lbrPlotter = laneBoundaryPlotter(bep, 'Color', 'g', 'LineStyle', '-');
rbsEdgePlotter = laneBoundaryPlotter(bep);
legend('off');
while advance(scenario)
    rbs = roadBoundaries(car);
    [position, yaw, length, width, originOffset, color] = targetOutlines(car);
    lb = laneBoundaries(car, 'XDistance', 0:5:30, 'LocationType', 'Center', ...
        'AllBoundaries', false);
    plotLaneBoundary(rbsEdgePlotter, rbs)
    plotLaneBoundary(lblPlotter, {lb(1).Coordinates})
    plotLaneBoundary(lbrPlotter, {lb(2).Coordinates})
    plotOutline(olPlotter, position, yaw, length, width, ...
        'OriginOffset', originOffset, 'Color', color)
end

```

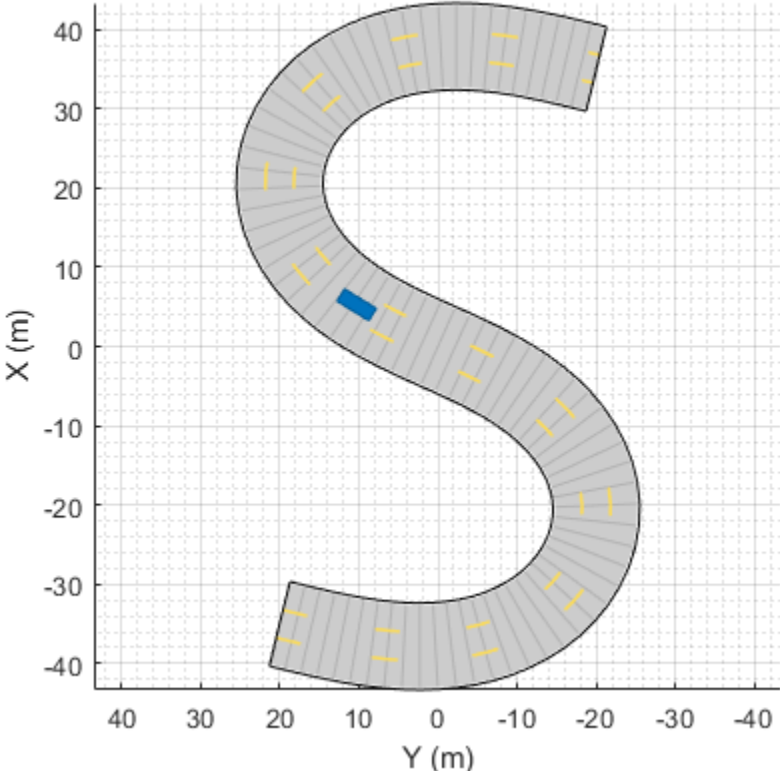

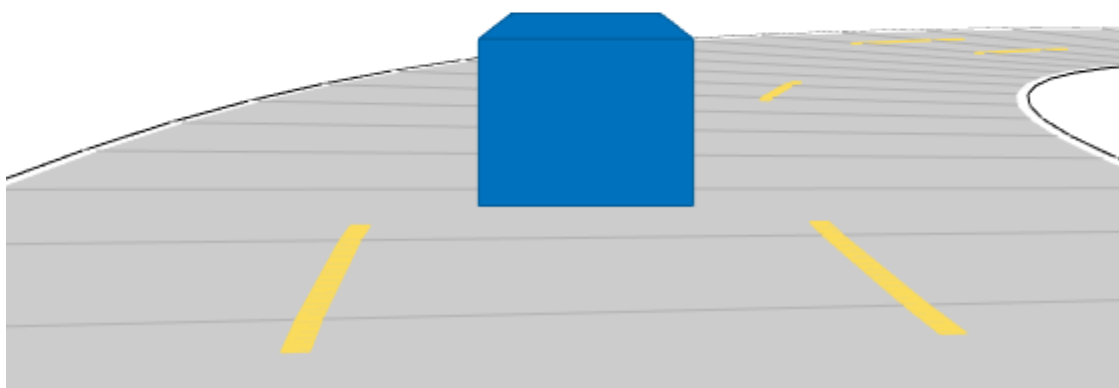

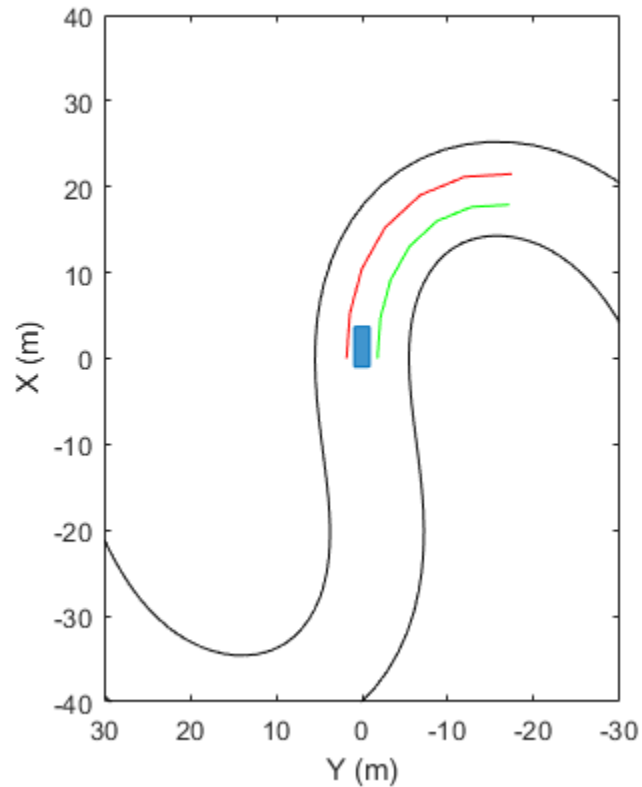

Limitations

- Lane markings in intersections are not supported.
- The number of lanes for a road is fixed. You cannot change lane specifications for a road during a simulation.

More About

Draw Direction of Road and Numbering of Lanes

To create a road by using the road function, specify the road centers as a matrix input. The function creates a directed line that traverses the road centers, starting from the coordinates in the first row of the matrix and ending at the coordinates in the last row of the matrix. The coordinates in the first two rows of the matrix specify the draw direction of the road. These coordinates correspond to the first two consecutive road centers. The draw direction is the direction in which the roads render in the scenario plot.

To create a road by using the **Driving Scenario Designer** app, you can either specify the **Road Centers** parameter or interactively draw on the **Scenario Canvas**. For a detailed example, see “Create a Driving Scenario” on page 1-14. In this case, the draw direction is the direction in which roads render in the **Scenario Canvas**.

- For a road with a top-to-bottom draw direction, the difference between the x-coordinates of the first two consecutive road centers is positive.

- For a road with a bottom-to-top draw direction, the difference between the x-coordinates of the first two consecutive road centers is negative.

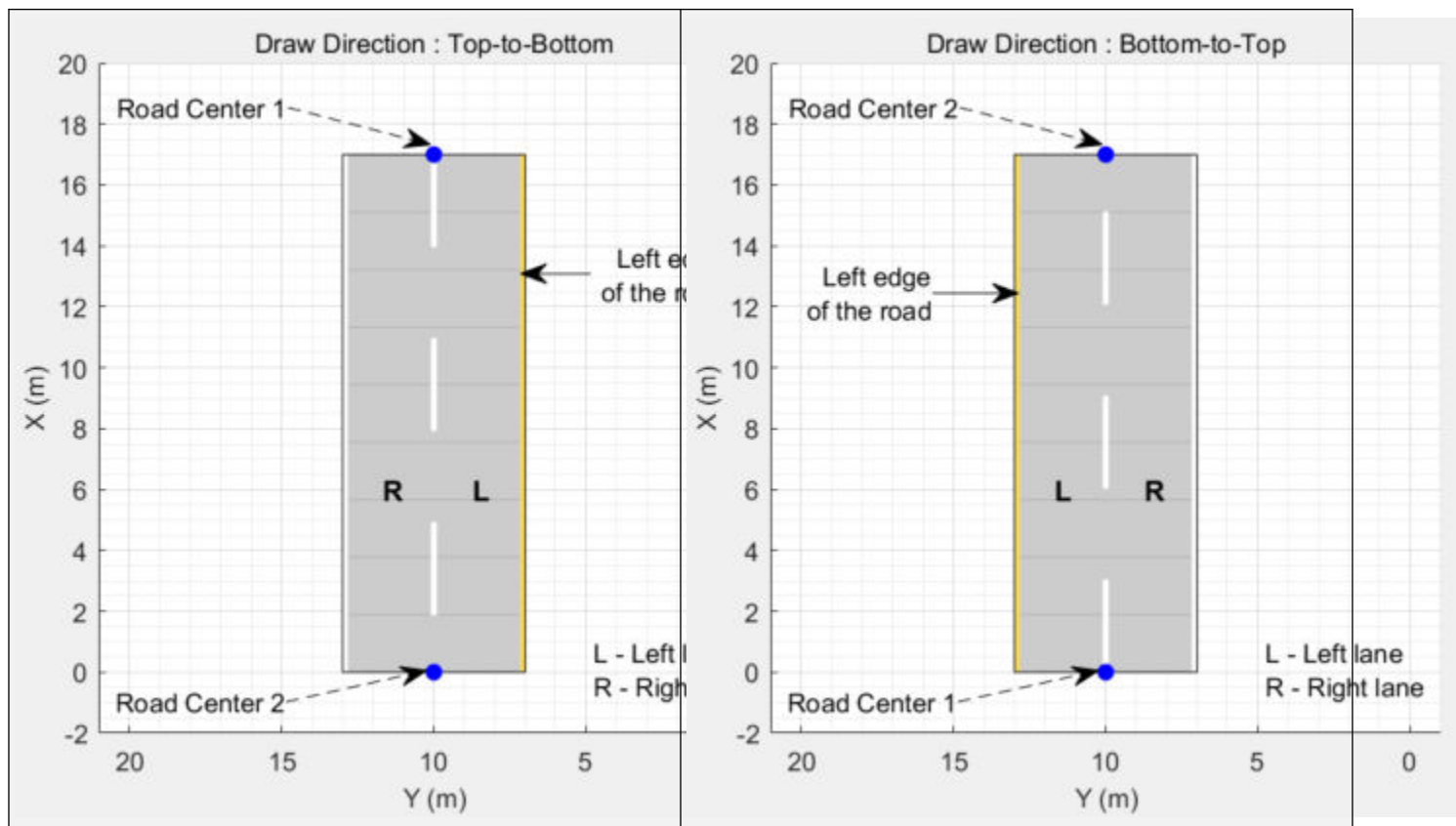

- For a road with a left-to-right draw direction, the difference between the y-coordinates of the first two consecutive road centers is positive.
- For a road with a right-to-left draw direction, the difference between the y-coordinates of the first two consecutive road centers is negative.

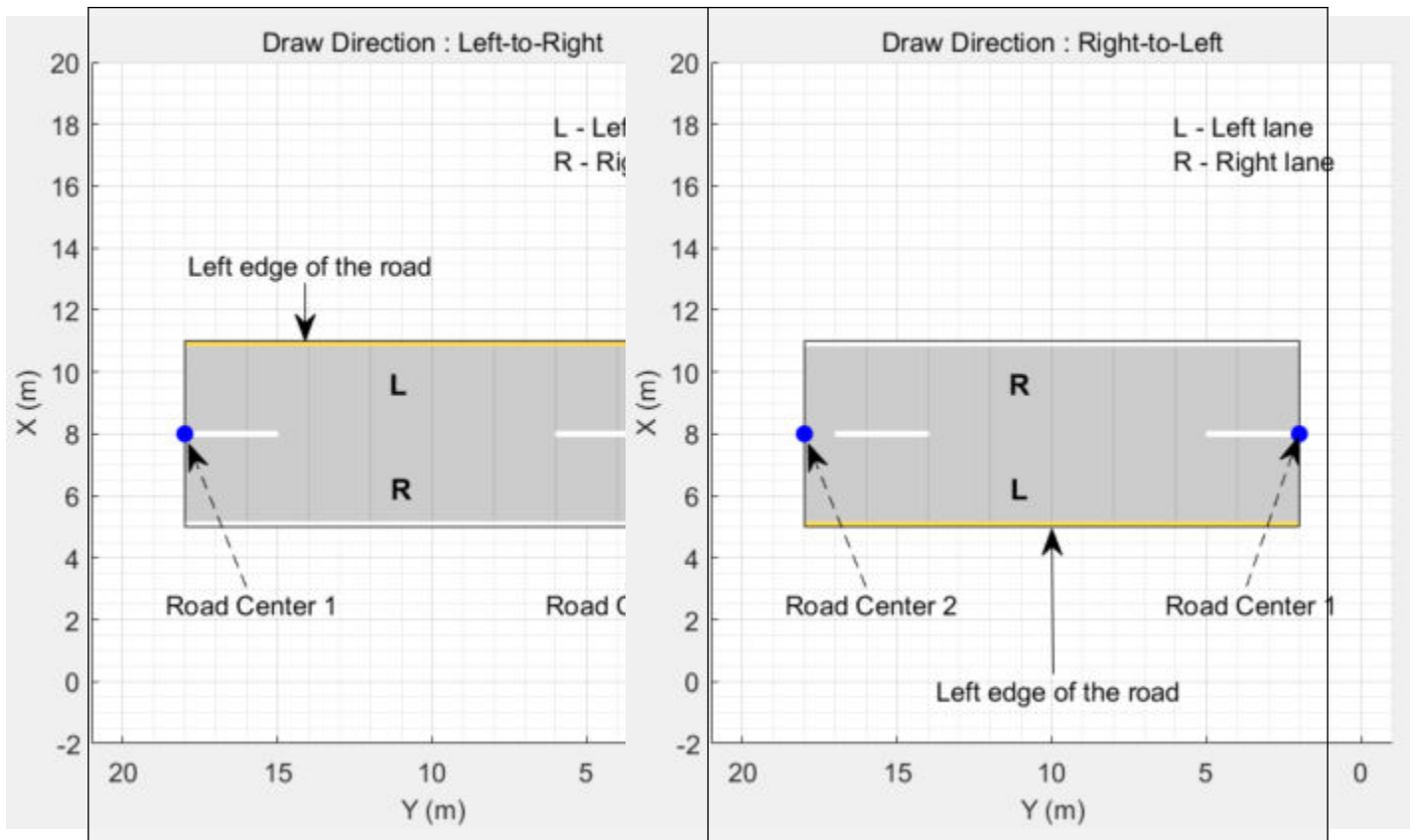

Numbering Lanes

Lanes must be numbered from left to right, with the left edge of the road defined relative to the draw direction of the road. For a one-way road, by default, the left edge of the road is a solid yellow marking which indicates the end of the road in transverse direction (direction perpendicular to draw direction). For a two-way road, by default, both edges are marked with solid white lines.

For example, these diagrams show how the lanes are numbered in a one-way and two-way road with a draw direction from top-to-bottom.

Numbering Lanes in a One-Way Road	Numbering Lanes in a Two-Way Road
--	--

Specify the number of lanes as a positive integer for a one-way road. If you set the integer value as 3, then the road has three lanes that travel in the same direction. The lanes are numbered starting from the left edge of the road.

1, 2, 3 denote the first, second, and third lanes of the road, respectively.

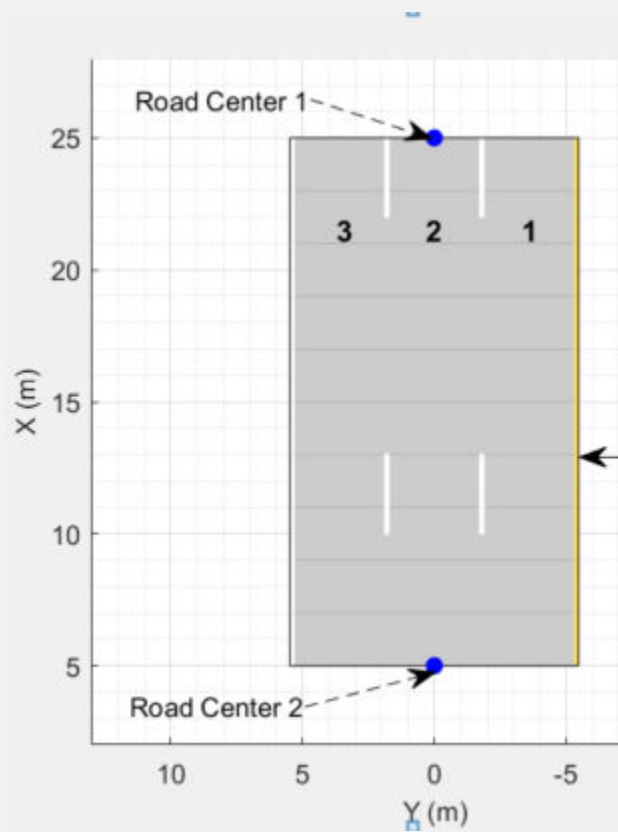

Specify the number of lanes as a two-element vector of positive integer for a two-way road. If you set the vector as [1 2], then the road has three lanes: two lanes traveling in one direction and one lane traveling in the opposite direction. Because of the draw direction, the road has one left lane and two right lanes. The lanes are numbered starting from the left edge of the road.

1L denote the only left lane of the road. **1R** and **2R** denote the first and second right lanes of the road, respectively.

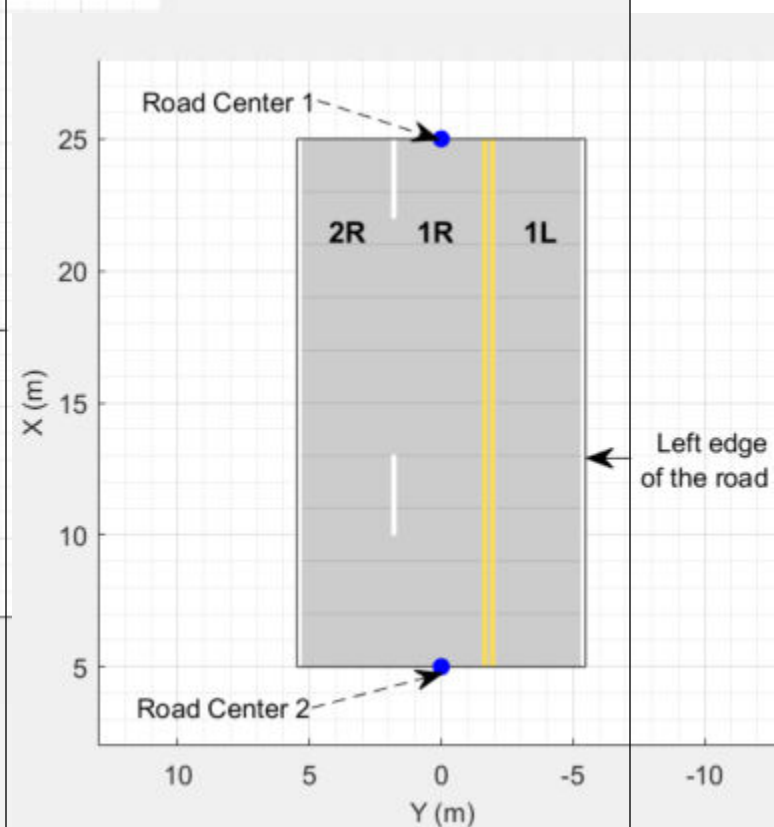

The lane specifications apply by the order in which the lanes are numbered.

Lane Specifications

The diagram shows the components and geometric properties of roads, lanes, and lane markings.

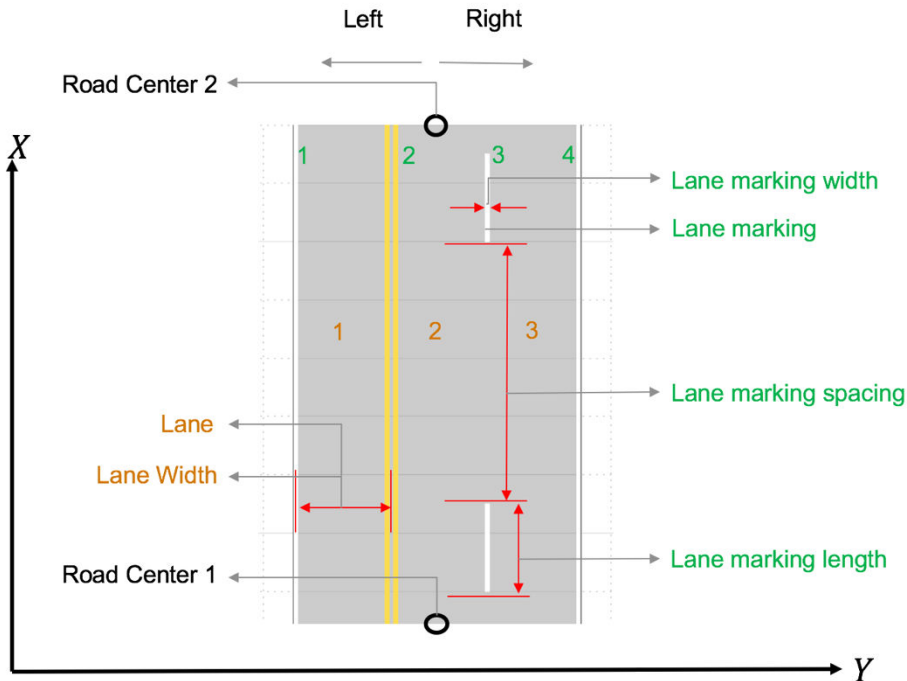

The lane specification object, `lanespec`, defines the road lanes.

- The `NumLanes` property specifies the number of lanes. You must specify the number of lanes when you create this object.
- The `Width` property specifies the width of each lane.
- The `Marking` property contains the specifications of each lane marking in the road. `Marking` is an array of lane marking objects, with one object per lane. To create these objects, use the `laneMarking` function. Lane marking specifications include:
 - `Type` — Type of lane marking (solid, dashed, and so on)
 - `Width` — Lane marking width
 - `Color` — Lane marking color
 - `Strength` — Saturation value for lane marking color
 - `Length` — For dashed lanes, the length of each dashed line
 - `Space` — For dashed lanes, the spacing between dashes
 - `SegmentRange` — For composite lane marking, the normalized length of each marker segment
- The `Type` property contains the lane type specifications of each lane in the road. `Type` can be a homogeneous lane type object or a heterogeneous lane type array.
 - Homogeneous lane type object contains the lane type specifications of all the lanes in the road.
 - Heterogeneous lane type array contains an array of lane type objects, with one object per lane.

To create these objects, use the `laneType` function. Lane type specifications include:

- `Type` — Type of lane (driving, border, and so on)
- `Color` — Lane color

- Strength — Strength of the lane color

Version History

Introduced in R2018a

See Also

Objects

`drivingScenario` | `compositeLaneSpec` | `laneSpecConnector`

Functions

`laneBoundaryPlotter` | `laneMarkingPlotter` | `plotLaneBoundary` | `plotLaneMarking` | `road` | `laneMarking` | `laneMarkingVertices` | `laneType`

compositeLaneSpec

Create multiple lane specifications for road

Description

The `compositeLaneSpec` object combines an array of `lanespec` objects to create a road with multiple road segments that have different lane specifications.

Creation

To define composite lane specifications, follow these steps:

- 1 Create an array of `lanespec` objects. The number of `lanespec` objects defines the number of road segments in a road. Each `lanespec` object contains the lane specifications for one road segment.
- 2 Create a composite lane specification object, `compositeLaneSpec`, to combine the lane specifications, using one of the syntaxes shown here. By default, the function assumes each road segment is of equal range.
- 3 To vary the range for each road segment, use the `SegmentRange` property of the `compositeLaneSpec` object.
- 4 To define the connection between two road segments, use the `Connector` property of the `compositeLanespec` object.
- 5 Add the `compositeLaneSpec` object to the driving scenario using the `road` function.

Syntax

```
clspec = compositeLaneSpec(lsArray)
clspec = compositeLaneSpec(lsArray,Name,Value)
```

Description

`clspec = compositeLaneSpec(lsArray)` creates a composite lane specification for a road using an array of lane specification objects, `lsArray`.

For example, create a composite lane specification object, `compositeLaneSpec`, to combine the lane specifications of two road segments with two and three lanes, respectively.

```
lsArray = [lanespec(2) lanespec(3)];
clspec = compositeLaneSpec(lsArray);
```

The order for numbering the lanes and segments of a road depends on the orientation of the road. For more details, see “Draw Direction of Road and Numbering of Lanes” on page 4-620 and “Composite Lane Specification” on page 4-623.

`clspec = compositeLaneSpec(lsArray,Name,Value)` sets properties using one or more name-value arguments. For example, `'SegmentRange',[0.6 0.4]` specifies that the normalized ranges of two road segments are 0.6 and 0.4, respectively.

Properties

LaneSpecification — Lane specifications of road segments

1-by- N array of `lanespec` objects

This property is read-only.

Lane specifications of road segments, specified as a 1-by- N array of `lanespec` objects. N is the number of lane specifications. You must specify at least two `lanespec` objects to create a road with multiple lane specifications. Each `lanespec` object represents a distinct road segment. As such, the number of `lanespec` objects defines the number of road segments in a road.

You must set this property using the `lsArray` input argument when you create the object. To create lane specification objects, use the `lanespec` function.

Example: `[lanespec(2) lanespec(3)]` defines the lane specifications for a road with two segments. The first road segment has two lanes and the second segment has three lanes.

SegmentRange — Range of each road segment

N -element numeric vector

Range of each road segment, specified as an N -element numeric vector with normalized values in the range (0, 1). N is the number of `lanespec` objects in the `LaneSpecification` property. The sum of the elements of the vector must be equal to 1.

The default range value of each road segment is $1/N$. For example, if the `LaneSpecification` property defines the lane specifications for two road segments, then the default range value for each road segment is $1/2$, meaning that `SegmentRange = [0.5 0.5]`.

Example: `[0.4 0.3 0.3]`

Data Types: `single` | `double`

Connector — Road segment connectors

`laneSpecConnector` object | 1-by- M array of `laneSpecConnector` objects

Road segment connectors, specified as a `laneSpecConnector` object or 1-by- M array of `laneSpecConnector` objects. M is the number of road segment connectors. For a road with N segments, $M = N - 1$. When specified as only one object, the same specifications apply to all M connectors of the road.

The `laneSpecConnector` object specifies these properties for connecting a pair of road segments. You can specify the properties to the `laneSpecConnector` creation function as name-value arguments.

- **TaperShape** — Specifies the shape of a taper connecting two road segments as either `'Linear'` or `'None'`. Specify `'None'` when you want a step change while adding or dropping lanes between road segments. The default value of `TaperShape` is `'Linear'`.
- **TaperLength** — Specifies the length of a taper in meters. The default value of `TaperLength` is the smaller of 241 meters or 75 percent of the length of the road segment containing the taper.
- **Position** — Specifies the edge of the road from which to add or drop lanes. You can specify the connector position as `'Right'`, `'Left'`, or `'Both'`.

Example: `[laneSpecConnector('Position','Left')
laneSpecConnector('TaperLength',20)]`

Note

- The taper is part of the lower numbered road segment within the pair. For more information about the order for numbering the road segments, see “Composite Lane Specification” on page 4-623.
 - Road segment connector specifications must conform with lane specifications and segment range values. Otherwise, the function resets the connector specifications with valid values. For example, if you specify a `TaperLength` larger than the length of the corresponding road segment, the function resets the taper length with a value that is 75 percent of the length of the corresponding road segment.
-

Examples**Drop Right Lane from Two-Way Road**

Create a driving scenario with merging traffic. The road in the driving scenario has two lane specifications and the traffic merges to the left as the right lane ends.

Create Road with Two Lane Specifications

Create a driving scenario. Specify the road centers with draw directions from bottom-to-top.

```
scenario = drivingScenario('StopTime',5);  
roadCenters = [0 20; 100 20];
```

Define the lane specifications for a pair of two-way road segments. The first road segment has five lanes and the second road segment has four lanes. Notice that the rightmost lane drops from the second lane specification.

```
ls1 = lanespec([2 3], 'Width',4);  
ls2 = lanespec([2 2], 'Width',4);  
lsArray = [ls1 ls2];
```

Create a composite lane specification object and add the road to the driving scenario. The composite lane specification object determines the position at which the lane drops from the `lsArray` input argument. The object defaults to the linear taper shape and a taper length of 75% of the length of the first road segment.

```
clspec = compositeLaneSpec(lsArray);  
road(scenario,roadCenters,'Lanes',clspec);
```

Plot the driving scenario. The scenario renders the road segments in the draw direction of the road, from bottom-to-top.

```
figMark = figure;  
set(figMark,'Position',[0 0 600 600])  
hPlot = axes(figMark);  
plot(scenario,'Parent',hPlot)  
title('Two-way Road Dropping Rightmost Lane')
```

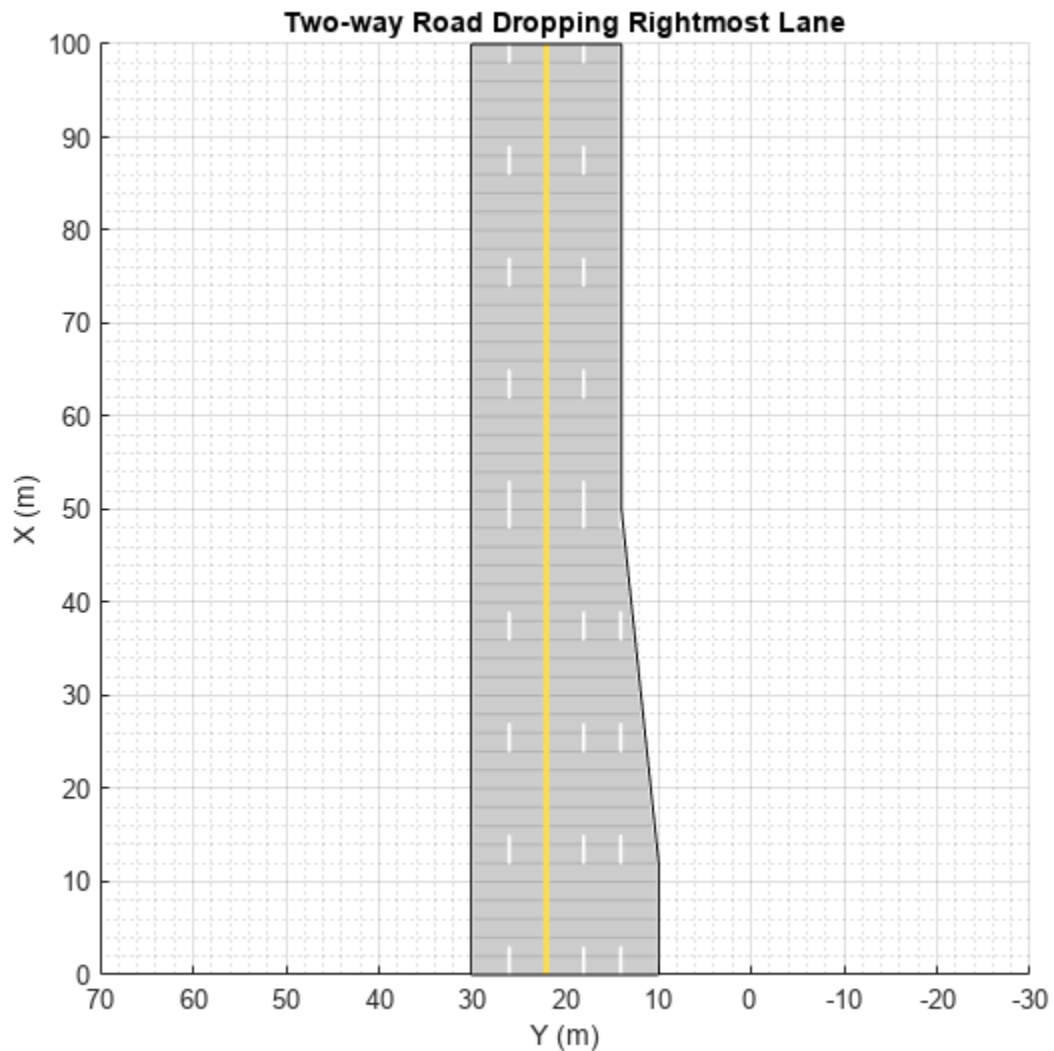
Simulate Vehicle Lane Change

Add an ego vehicle to the scenario. Specify waypoints and a constant speed value to set its trajectory along the middle forward lane.

```
egoVehicle = vehicle(scenario, 'ClassID', 1, 'Position', [2 16 0]);
waypoints = [2 16; 20 16; 95 16];
speed = 30;
smoothTrajectory(egoVehicle, waypoints, speed)
```

Add another vehicle to the scenario. Set the trajectory for the vehicle such that it travels in the rightmost lane and then merges to the left before the lane ends.

```
car = vehicle(scenario, 'ClassID', 1, 'Position', [2 12 0]);
waypoints = [2 12; 12 12; 30 14; 42 16; 58 16; 85 16];
```

```
speed = 20;  
smoothTrajectory(car,waypoints,speed)
```

Create a custom figure window and plot the scenario.

```
close all  
figScene = figure;  
set(figScene,'Position',[0 0 600 600])  
hPanel = uipanel(figScene);  
hPlot = axes(hPanel);  
plot(scenario,'Waypoints','on','Parent',hPlot)  
title('Merge Left as Right Lane Ends')  
  
while advance(scenario)  
    pause(0.01)  
end
```

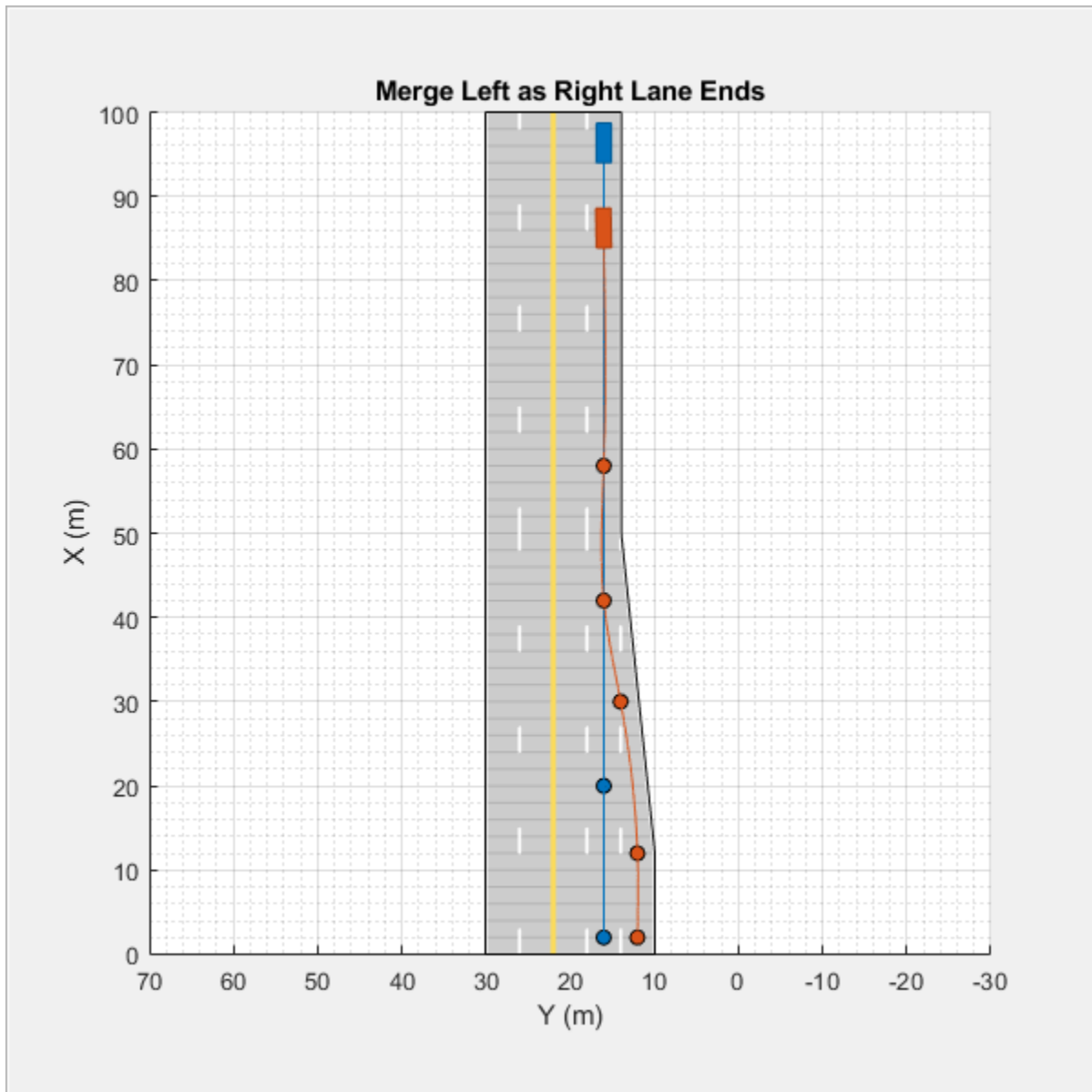

Add Lane to One-Way Road

Create a road with multiple lane specifications and add one lane to the left of a one-way road.

Create a driving scenario. Specify the road centers for a straight, 100-meter road with draw direction from left-to-right.

```
scenario = drivingScenario;
roadCenters = [20 100; 20 0];
```

Define an array of lane specifications for two one-way road segments. The first road segment has two lanes and the second road segment has three lanes.

```
lsArray = [lanespec(2) lanespec(3)];
```

Define a road segment connector object. To add the third lane to the left side of the second road segment, specify the position property. Specify a taper length less than the length of the first road segment. Both the road segments are 50 meters long since, by default, the total road length of 100 meters is divided equally between the specified road segments.

```
lc = laneSpecConnector('Position','Left','TaperLength',30);
```

Create a composite lane specification object.

```
clspec = compositeLaneSpec(lsArray,'Connector',lc);
```

Add a road to the driving scenario and display the road. The scenario renders the road segments in the draw direction of the road, from left-to-right.

```
road(scenario,roadCenters,'Lanes',clspec);
plot(scenario)
title('Road with Multiple Lane Specifications')
```

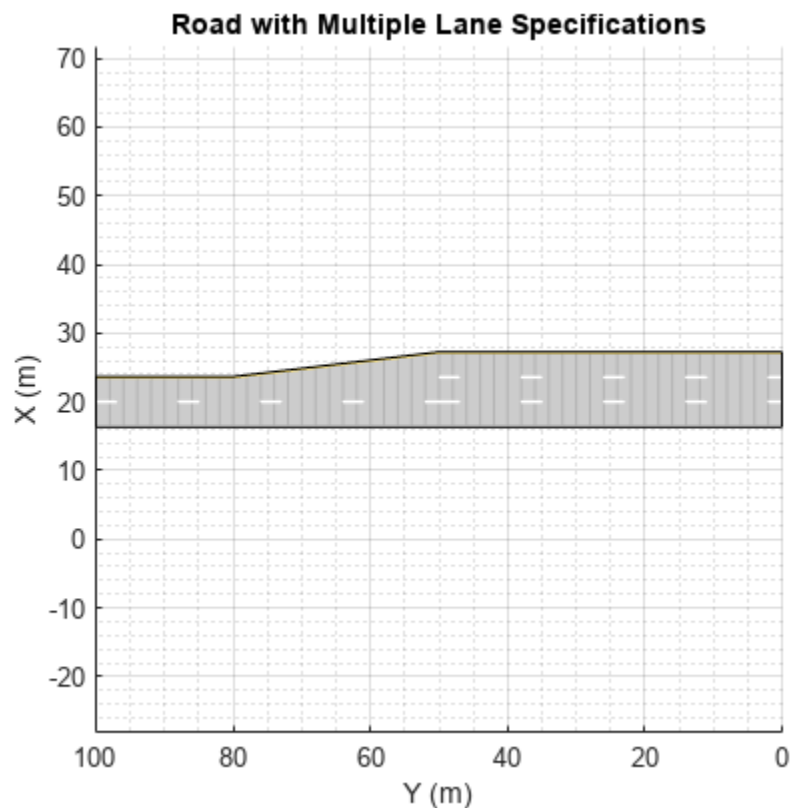

Vary Lane Width Along Curve

Create an empty driving scenario. Specify the road centers for a curved road.

```
scenario = drivingScenario;
roadCenters = [-20 22; 0 22; 18.8 15.8; 22 0; 22 -20];
```

Define the lane specifications for three two-way road segments. Notice that all the road segments have the same number of lanes. However, the second road segment has a greater lane width (4.6 meters) to widen the road along the curve. The other two road segments have the default lane width of 3.6 meters.

```
lsArray = [lanespec([1 1]) lanespec([1 1], 'Width', 4.6) lanespec([1 1])];
```

Define normalized lengths for each road segment. Notice that the sum of normalized lengths is 1, and the length of the vector matches the number of lane specification objects.

```
range = [0.25 0.65 0.1];
```

Create a road segment connector object. Since the same specifications apply to both segment connectors for the three road segments, create only one `laneSpecConnector` object. Since you are neither adding nor dropping lanes, do not define the position property of the road segment connector.

```
lc = laneSpecConnector('TaperLength', 14);
```

Create a composite lane specification object and add the road to the driving scenario.

```
clspec = compositeLaneSpec(lsArray, 'Connector', lc, 'SegmentRange', range);
road(scenario, roadCenters, 'Lanes', clspec);
```

Plot the driving scenario.

```
plot(scenario, 'RoadCenters', 'on')
title('Lane Widening Along a Curve')
```

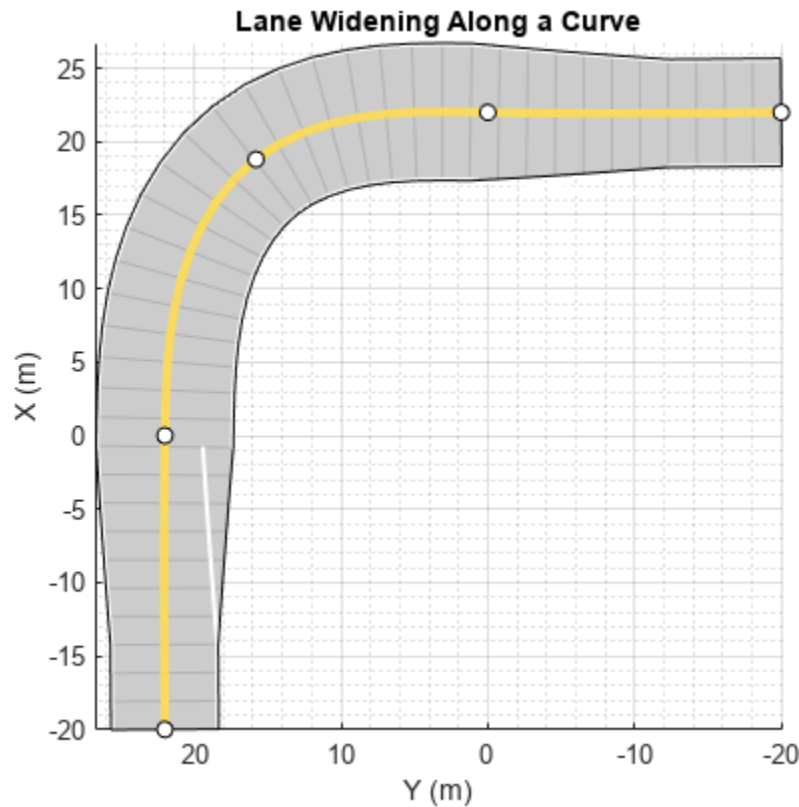

Limitations

- Lane marking spacing is not consistent during transitions from one road segment to another.

More About

Draw Direction of Road and Numbering of Lanes

To create a road by using the road function, specify the road centers as a matrix input. The function creates a directed line that traverses the road centers, starting from the coordinates in the first row of the matrix and ending at the coordinates in the last row of the matrix. The coordinates in the first two rows of the matrix specify the draw direction of the road. These coordinates correspond to the first two consecutive road centers. The draw direction is the direction in which the roads render in the scenario plot.

To create a road by using the **Driving Scenario Designer** app, you can either specify the **Road Centers** parameter or interactively draw on the **Scenario Canvas**. For a detailed example, see “Create a Driving Scenario” on page 1-14. In this case, the draw direction is the direction in which roads render in the **Scenario Canvas**.

- For a road with a top-to-bottom draw direction, the difference between the x-coordinates of the first two consecutive road centers is positive.
- For a road with a bottom-to-top draw direction, the difference between the x-coordinates of the first two consecutive road centers is negative.

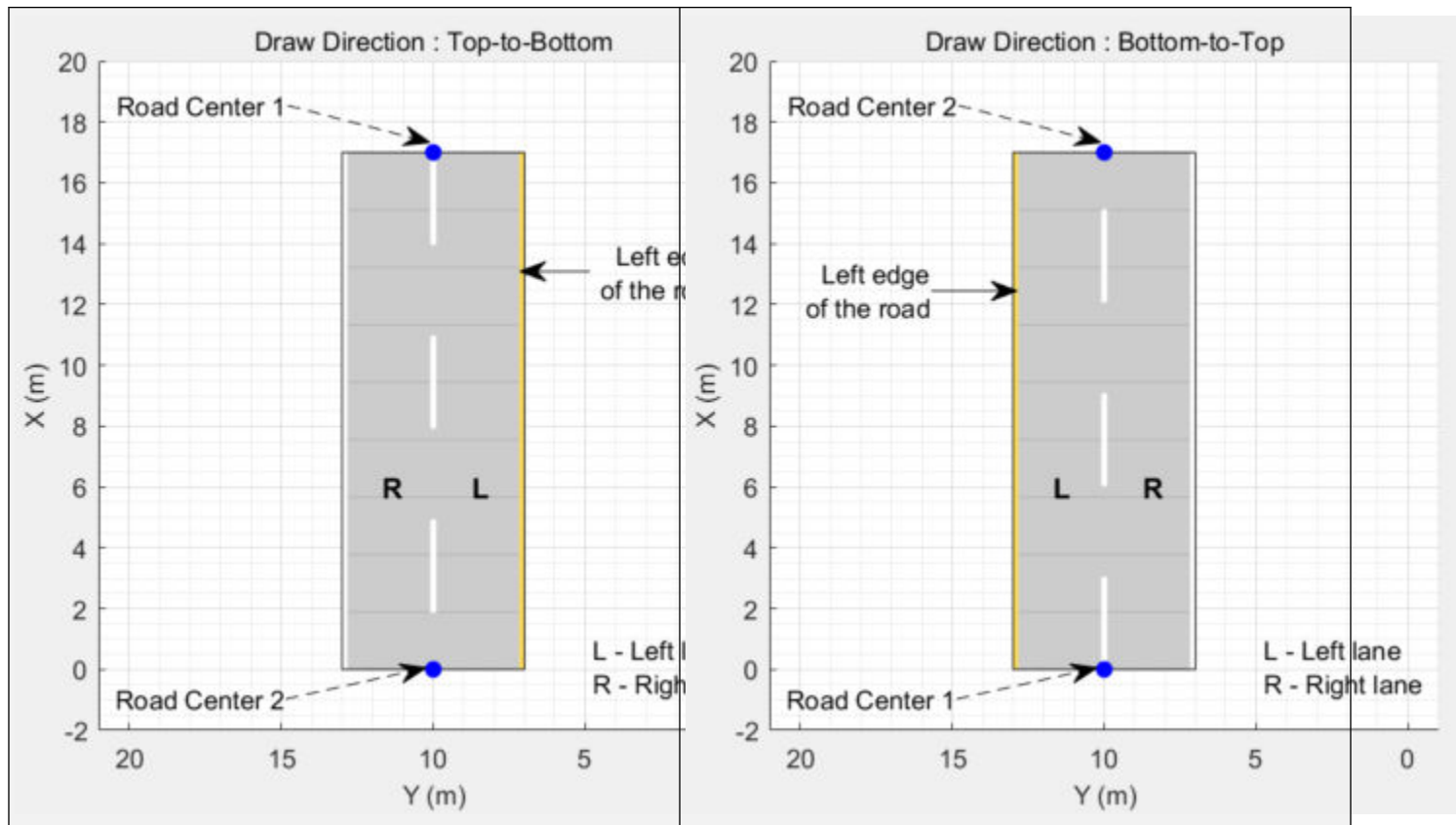

- For a road with a left-to-right draw direction, the difference between the y-coordinates of the first two consecutive road centers is positive.
- For a road with a right-to-left draw direction, the difference between the y-coordinates of the first two consecutive road centers is negative.

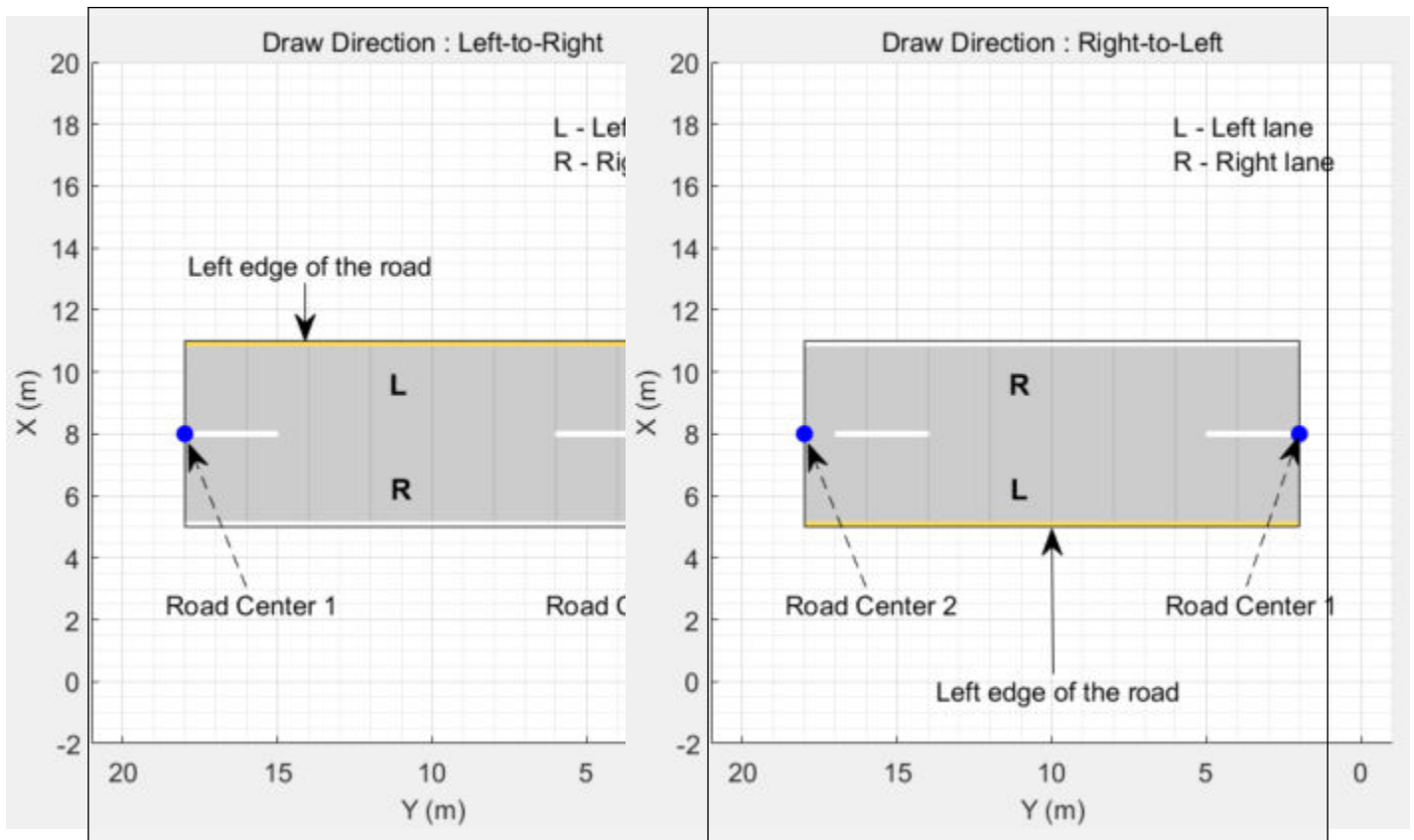

Numbering Lanes

Lanes must be numbered from left to right, with the left edge of the road defined relative to the draw direction of the road. For a one-way road, by default, the left edge of the road is a solid yellow marking which indicates the end of the road in transverse direction (direction perpendicular to draw direction). For a two-way road, by default, both edges are marked with solid white lines.

For example, these diagrams show how the lanes are numbered in a one-way and two-way road with a draw direction from top-to-bottom.

Numbering Lanes in a One-Way Road	Numbering Lanes in a Two-Way Road
--	--

Specify the number of lanes as a positive integer for a one-way road. If you set the integer value as 3, then the road has three lanes that travel in the same direction. The lanes are numbered starting from the left edge of the road.

1, 2, 3 denote the first, second, and third lanes of the road, respectively.

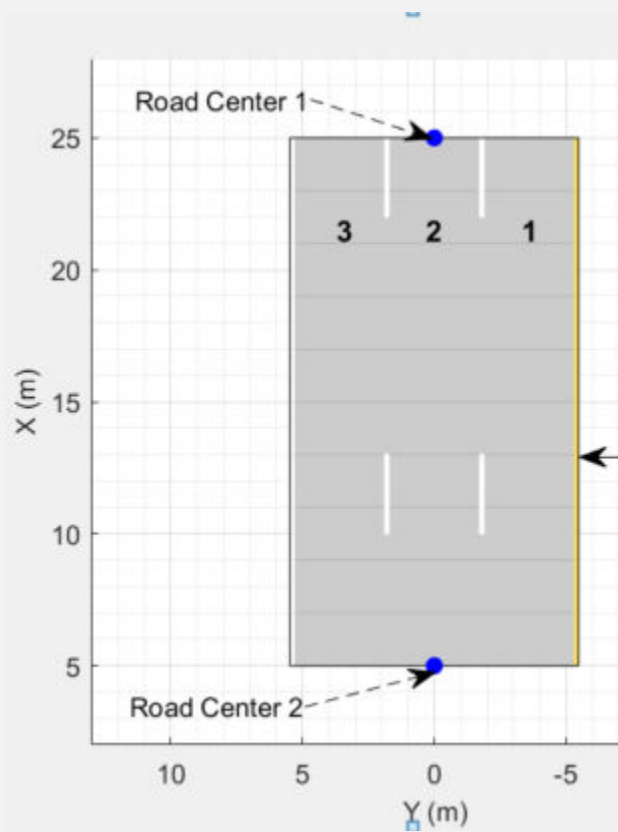

Specify the number of lanes as a two-element vector of positive integer for a two-way road. If you set the vector as [1 2], then the road has three lanes: two lanes traveling in one direction and one lane traveling in the opposite direction. Because of the draw direction, the road has one left lane and two right lanes. The lanes are numbered starting from the left edge of the road.

1L denote the only left lane of the road. **1R** and **2R** denote the first and second right lanes of the road, respectively.

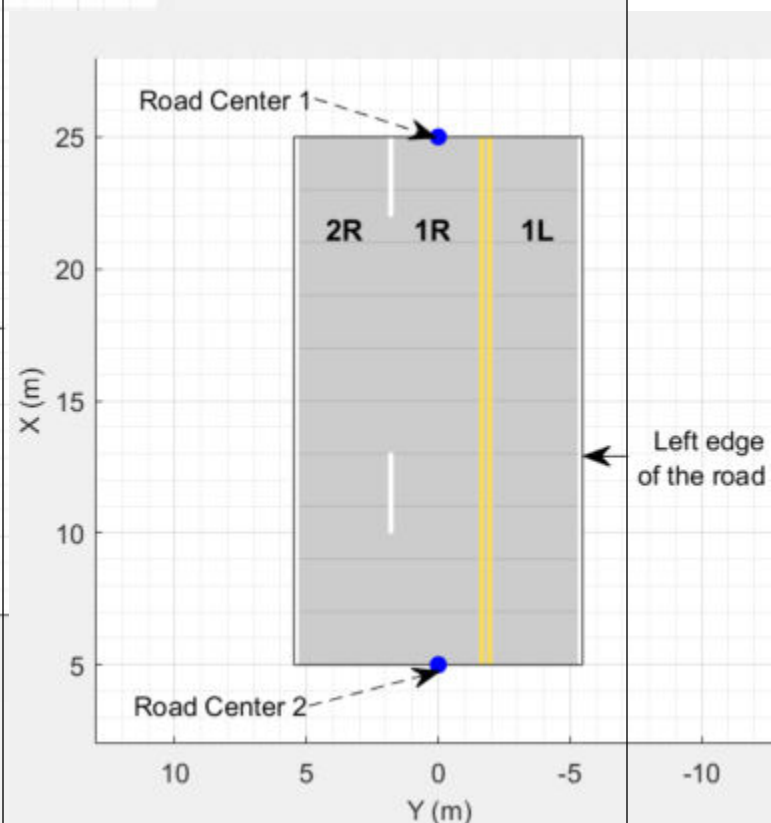

The lane specifications apply by the order in which the lanes are numbered.

Composite Lane Specification

A *composite lane specification* consists of an array of two or more lane specifications for a single road. Each lane specification defines a *road segment*, which is a section of the road with independent geometric properties, normalized range, and taper.

Each road segment is a directed segment that moves toward the final road center, with the first segment beginning at the first road center, the second segment starting where the first ends, and so on. The range of each road segment is a normalized distance that specifies a proportion of the total length of the road. When a road segment adds or drops lanes from a previous segment, the preceding segment tapers along a specified distance to accommodate the change in number of lanes.

When you render a road with composite lane specifications, the road segments render in the draw direction of the road. For example, consider a one-way road with two road segments and a default normalized range of 0.5 for each road segment. The first road segment contains four lanes and the second segment contains only two lanes. The first segment tapers from four lanes to two lanes, dropping one lane from each side, as it approaches the halfway point of the road, which is the start point of the second segment. These diagrams show the direction in which the road segments render, and how the taper applies to the road, for both the left-to-right and right-to-left draw directions.

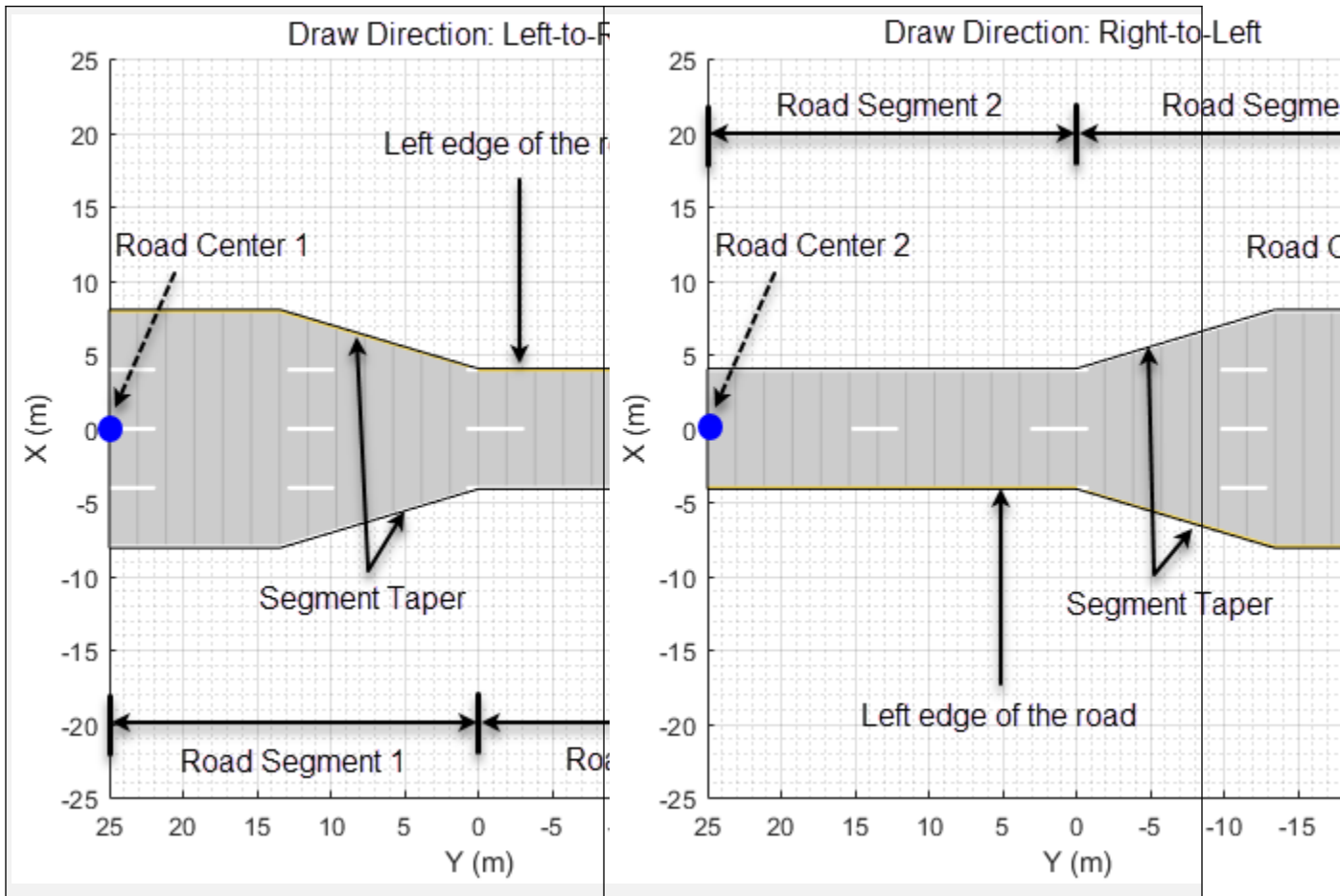

For information on the geometric properties of lanes, see “Lane Specifications” on page 4-656.

Lane Specifications

The diagram shows the components and geometric properties of roads, lanes, and lane markings.

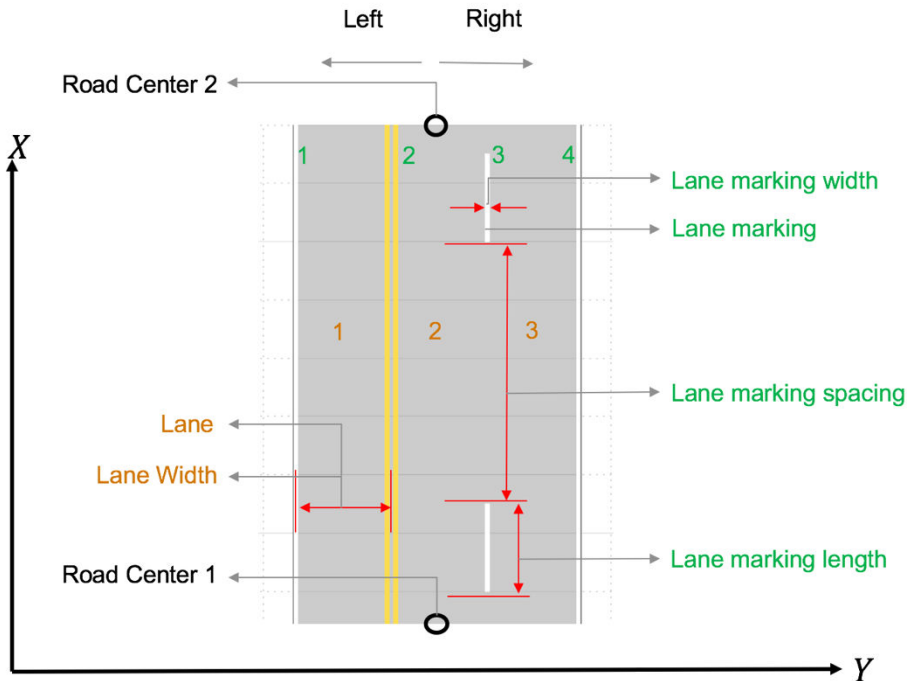

The lane specification object, `lanespec`, defines the road lanes.

- The `NumLanes` property specifies the number of lanes. You must specify the number of lanes when you create this object.
- The `Width` property specifies the width of each lane.
- The `Marking` property contains the specifications of each lane marking in the road. `Marking` is an array of lane marking objects, with one object per lane. To create these objects, use the `laneMarking` function. Lane marking specifications include:
 - `Type` — Type of lane marking (solid, dashed, and so on)
 - `Width` — Lane marking width
 - `Color` — Lane marking color
 - `Strength` — Saturation value for lane marking color
 - `Length` — For dashed lanes, the length of each dashed line
 - `Space` — For dashed lanes, the spacing between dashes
 - `SegmentRange` — For composite lane marking, the normalized length of each marker segment
- The `Type` property contains the lane type specifications of each lane in the road. `Type` can be a homogeneous lane type object or a heterogeneous lane type array.
 - Homogeneous lane type object contains the lane type specifications of all the lanes in the road.
 - Heterogeneous lane type array contains an array of lane type objects, with one object per lane.

To create these objects, use the `laneType` function. Lane type specifications include:

- `Type` — Type of lane (driving, border, and so on)
- `Color` — Lane color

- Strength — Strength of the lane color

Version History

Introduced in R2021a

See Also

Objects

drivingScenario | laneSpecConnector | lanespec

Functions

road | roadNetwork | roadGroup | laneMarking | laneType | vehicle | actor | smoothTrajectory

Topics

“Create Roads with Multiple Lane Specifications Using Driving Scenario Designer”

laneSpecConnector

Define road segment connector specifications

Description

The `laneSpecConnector` object defines specifications for connecting two road segments with different lane specifications. See `compositeLaneSpec` for more details on creating a road with multiple lane specifications.

Creation

Syntax

```
lc = laneSpecConnector
lc = laneSpecConnector(Name, Value)
```

Description

`lc = laneSpecConnector` creates a road segment connector object to connect two road segments with different lane specifications. Specify road segment connector objects as inputs to a `compositeLaneSpec` object to create a road with multiple lane specifications.

`lc = laneSpecConnector(Name, Value)` sets properties using one or more name-value arguments. For example, `'TaperLength', 20` specifies a taper length of 20 meters. For more information on the geometric properties of taper and road segments, see “Composite Lane Specification” on page 4-635.

Properties

TaperShape — Shape of taper

'Linear' (default) | 'None' | character vector | string scalar

Shape of the taper connecting two road segments, specified as a character vector or string scalar that partially or fully matches a `ConnectorTaperShape` enumeration member name. While creating the object, specify this property as a character vector or a string scalar that must partially or fully match one of the these enumeration member names.

Enumeration Member Name	Enumerated Value	Description	Example (Using Left-To-Right Road)

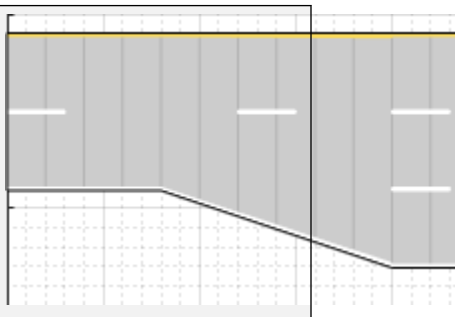
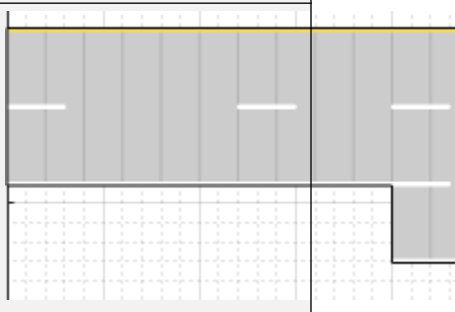
'Linear'	0	Current segment tapers linearly while adding or dropping lanes for the next segment.	
'None'	1	Segment does not taper, changing abruptly while adding or dropping lanes.	

Example: 'TaperShape', 'None'

TaperLength – Length of taper

real positive scalar

Length of the taper connecting two road segments, specified as a real positive scalar. Units are in meters. The default taper length is the smaller of 241 meters or 75 percent of the length of the road segment containing the taper.

Note

- Taper length must be less than the corresponding road segment length. Otherwise, the function resets it to a value that is 75 percent of the length of the corresponding road segment.
- Do not specify taper length when the taper shape is set to 'None'. The function will ignore the specified input.

Example: 'TaperLength', 20

Data Types: double

Position – Road segment connector position

'Right' (default) | 'Left' | 'Both' | character vector | string scalar

Road segment connector position, specified as a character vector or string scalar that partially or fully matches a `ConnectorPosition` enumeration member name. This property specifies the edge of the road from which to add or drop lanes. While creating the object, specify this property as a character vector or a string scalar that must partially or fully match one of these enumeration member names.

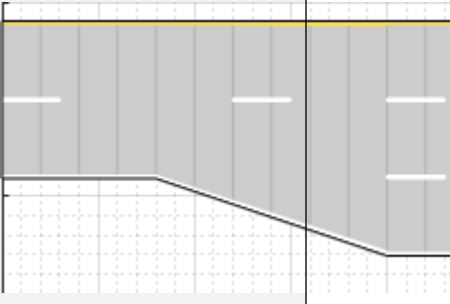
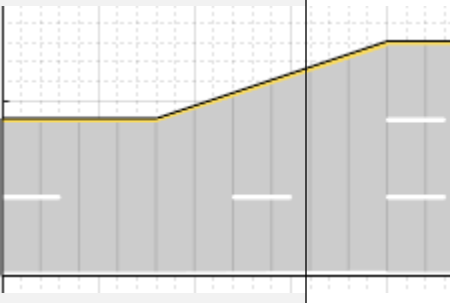
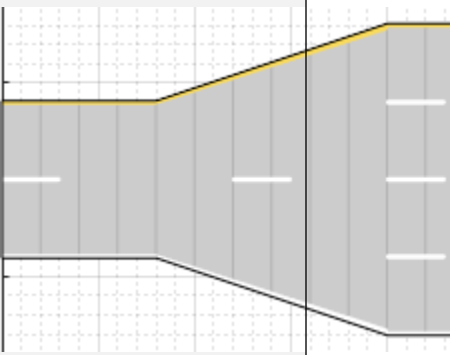
Enumeration Member Name	Enumerated Value	Description	Example (Using Left-To-Right Road)
'Right'	0	Add or drop lanes from the right edge of the road.	
'Left'	1	Add or drop lanes from the left edge of the road.	
'Both'	2	Add or drop lanes from both edges of the road.	

Use this property only when connecting two one-way road segments with different number of lanes. To add or drop lanes from both the edges of a one-way road, the number of lanes of the road segments must differ by an even number.

Do not specify this property when connecting road segments that are not one-way because the `compositeLaneSpec` object ignores this property.

- To connect two-way road segments, the `compositeLaneSpec` object determines the connector position from the number of lanes defined by the corresponding lane specification objects. For example, if the number of lanes of two-way road segments are [1 1] and [2 1], the `compositeLaneSpec` object applies the 'Left' position.
- To connect one-way and two-way road segments, the `compositeLaneSpec` object adds or drops the left (backward) lanes from the left edge of the road. The object applies the 'Left' position when the number of right (forward) lanes matches between both road segments. Otherwise, the connector position is set to 'Both'. For example, if the lane specifications of two road segments are [1 2] and 2, the `compositeLaneSpec` object applies the 'Left' position. In contrast, if the lane specifications of two road segments are [1 2] and 1, the `compositeLaneSpec` object sets the position property to 'Both'.

Note

- A driving scenario considers all the lanes in a one-way road to be right (forward) lanes, which assumes that traffic flows in the same direction as the draw direction of the road. For more information about the draw direction of roads, see “Draw Direction of Road and Numbering of Lanes” on page 4-632.
 - The `TaperShape` and `TaperLength` properties apply when either the number of lanes or the segment width changes between road segments. However, the `Position` property applies, only when adding or dropping lanes between road segments.
-

Example: `'Position','Both'`

Examples

Add Lane to One-Way Road

Create a road with multiple lane specifications and add one lane to the left of a one-way road.

Create a driving scenario. Specify the road centers for a straight, 100-meter road with draw direction from left-to-right.

```
scenario = drivingScenario;  
roadCenters = [20 100; 20 0];
```

Define an array of lane specifications for two one-way road segments. The first road segment has two lanes and the second road segment has three lanes.

```
lsArray = [lanespec(2) lanespec(3)];
```

Define a road segment connector object. To add the third lane to the left side of the second road segment, specify the `position` property. Specify a taper length less than the length of the first road segment. Both the road segments are 50 meters long since, by default, the total road length of 100 meters is divided equally between the specified road segments.

```
lc = laneSpecConnector('Position','Left','TaperLength',30);
```

Create a composite lane specification object.

```
clspec = compositeLaneSpec(lsArray,'Connector',lc);
```

Add a road to the driving scenario and display the road. The scenario renders the road segments in the draw direction of the road, from left-to-right.

```
road(scenario,roadCenters,'Lanes',clspec);  
plot(scenario)  
title('Road with Multiple Lane Specifications')
```

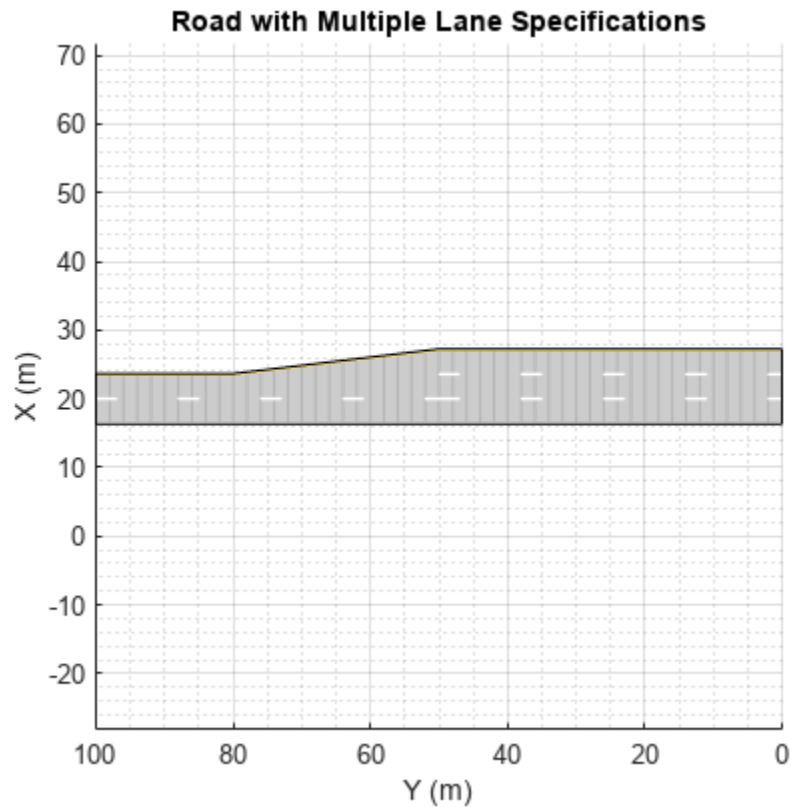
Vary Lane Width Along Curve

Create an empty driving scenario. Specify the road centers for a curved road.

```
scenario = drivingScenario;
roadCenters = [-20 22; 0 22; 18.8 15.8; 22 0; 22 -20];
```

Define the lane specifications for three two-way road segments. Notice that all the road segments have the same number of lanes. However, the second road segment has a greater lane width (4.6 meters) to widen the road along the curve. The other two road segments have the default lane width of 3.6 meters.

```
lsArray = [lanespec([1 1]) lanespec([1 1], 'Width', 4.6) lanespec([1 1])];
```

Define normalized lengths for each road segment. Notice that the sum of normalized lengths is 1, and the length of the vector matches the number of lane specification objects.

```
range = [0.25 0.65 0.1];
```

Create a road segment connector object. Since the same specifications apply to both segment connectors for the three road segments, create only one `laneSpecConnector` object. Since you are neither adding nor dropping lanes, do not define the position property of the road segment connector.

```
lc = laneSpecConnector('TaperLength', 14);
```

Create a composite lane specification object and add the road to the driving scenario.

```
clspec = compositeLaneSpec(lsArray, 'Connector', lc, 'SegmentRange', range);
road(scenario, roadCenters, 'Lanes', clspec);
```

Plot the driving scenario.

```
plot(scenario, 'RoadCenters', 'on')
title('Lane Widening Along a Curve')
```

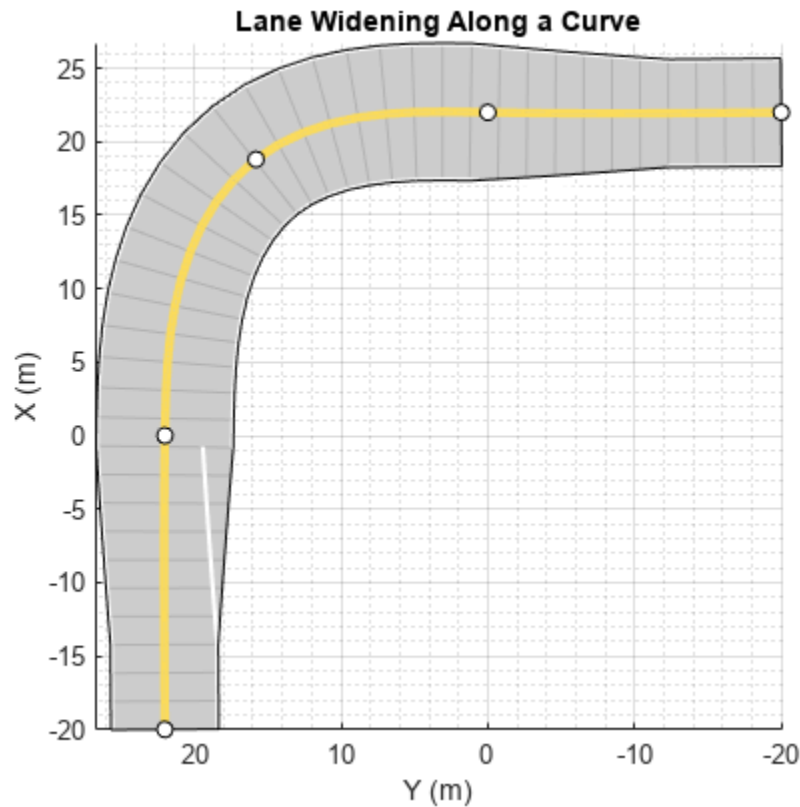

More About

Draw Direction of Road and Numbering of Lanes

To create a road by using the `road` function, specify the road centers as a matrix input. The function creates a directed line that traverses the road centers, starting from the coordinates in the first row of the matrix and ending at the coordinates in the last row of the matrix. The coordinates in the first two rows of the matrix specify the draw direction of the road. These coordinates correspond to the first two consecutive road centers. The draw direction is the direction in which the roads render in the scenario plot.

To create a road by using the **Driving Scenario Designer** app, you can either specify the **Road Centers** parameter or interactively draw on the **Scenario Canvas**. For a detailed example, see “Create a Driving Scenario” on page 1-14. In this case, the draw direction is the direction in which roads render in the **Scenario Canvas**.

- For a road with a top-to-bottom draw direction, the difference between the x-coordinates of the first two consecutive road centers is positive.
- For a road with a bottom-to-top draw direction, the difference between the x-coordinates of the first two consecutive road centers is negative.

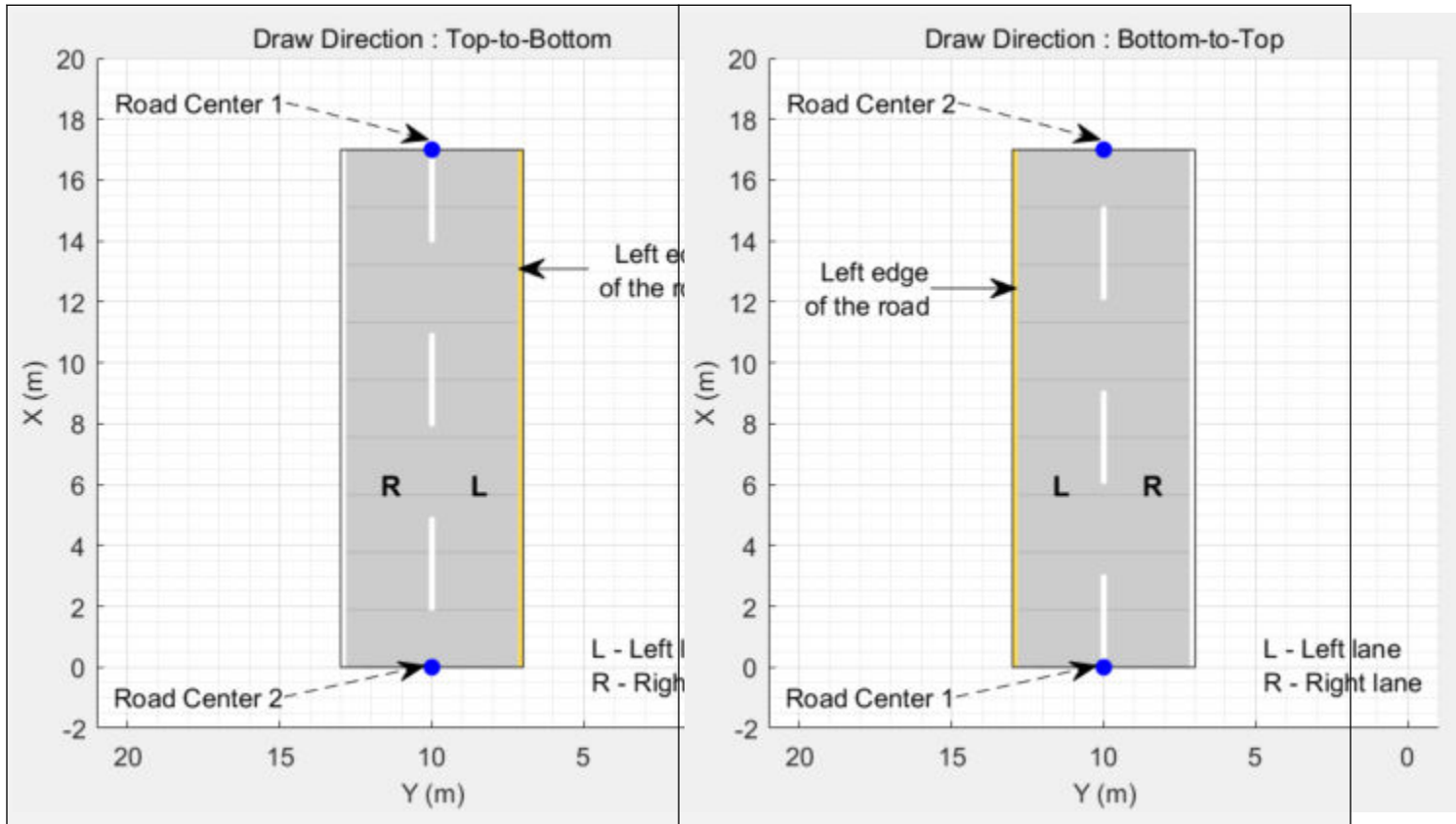

- For a road with a left-to-right draw direction, the difference between the y-coordinates of the first two consecutive road centers is positive.
- For a road with a right-to-left draw direction, the difference between the y-coordinates of the first two consecutive road centers is negative.

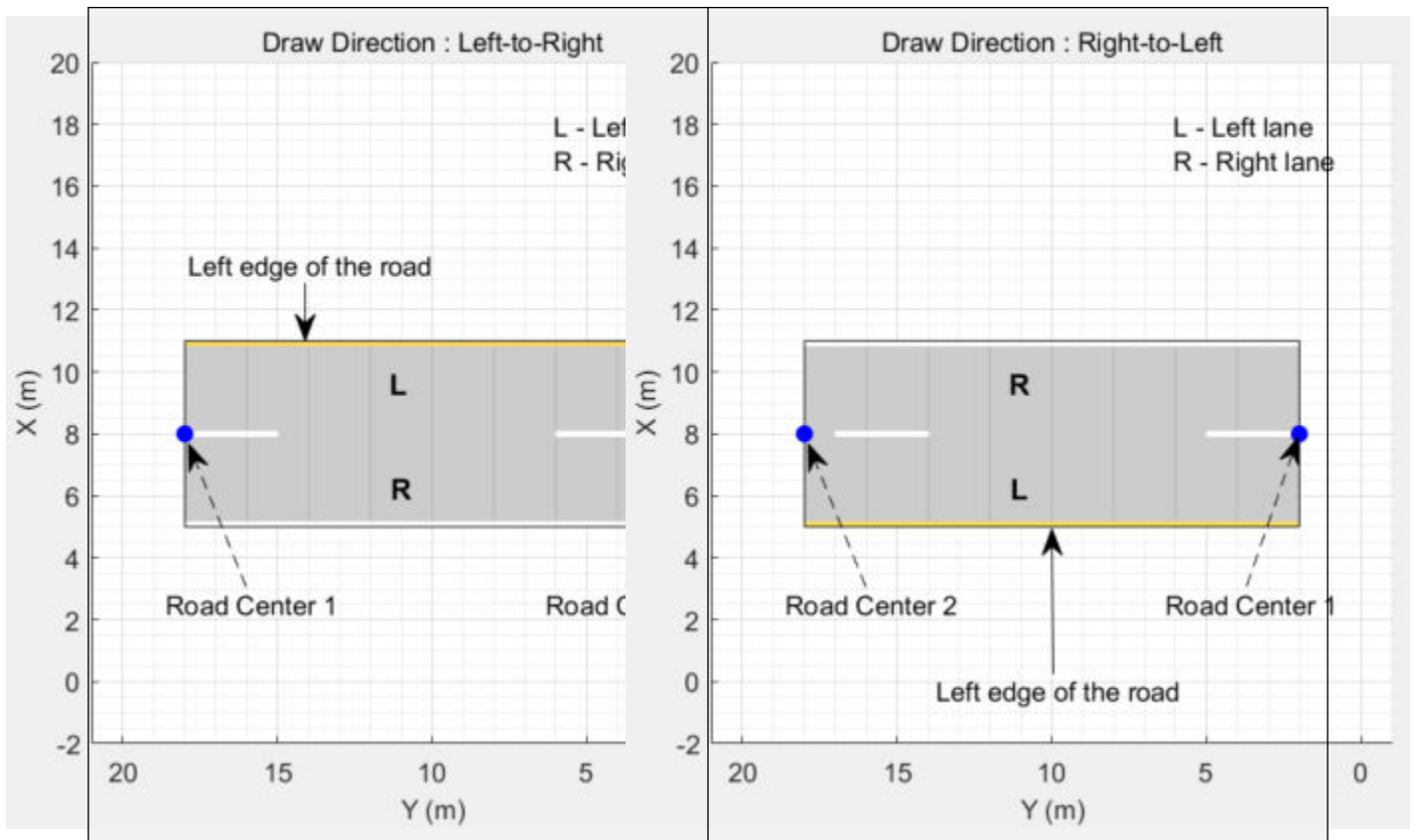

Numbering Lanes

Lanes must be numbered from left to right, with the left edge of the road defined relative to the draw direction of the road. For a one-way road, by default, the left edge of the road is a solid yellow marking which indicates the end of the road in transverse direction (direction perpendicular to draw direction). For a two-way road, by default, both edges are marked with solid white lines.

For example, these diagrams show how the lanes are numbered in a one-way and two-way road with a draw direction from top-to-bottom.

Numbering Lanes in a One-Way Road	Numbering Lanes in a Two-Way Road
--	--

Specify the number of lanes as a positive integer for a one-way road. If you set the integer value as 3, then the road has three lanes that travel in the same direction. The lanes are numbered starting from the left edge of the road.

1, 2, 3 denote the first, second, and third lanes of the road, respectively.

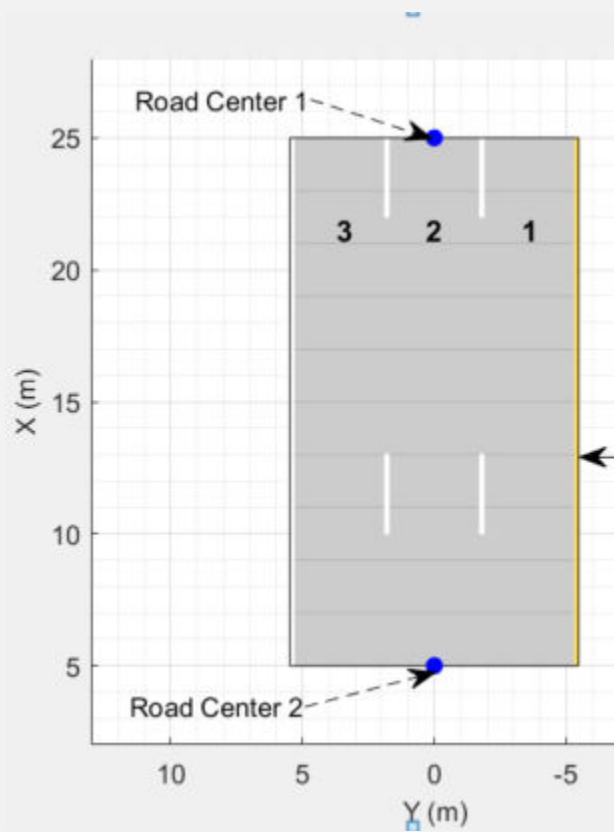

Specify the number of lanes as a two-element vector of positive integer for a two-way road. If you set the vector as [1 2], then the road has three lanes: two lanes traveling in one direction and one lane traveling in the opposite direction. Because of the draw direction, the road has one left lane and two right lanes. The lanes are numbered starting from the left edge of the road.

1L denote the only left lane of the road. **1R** and **2R** denote the first and second right lanes of the road, respectively.

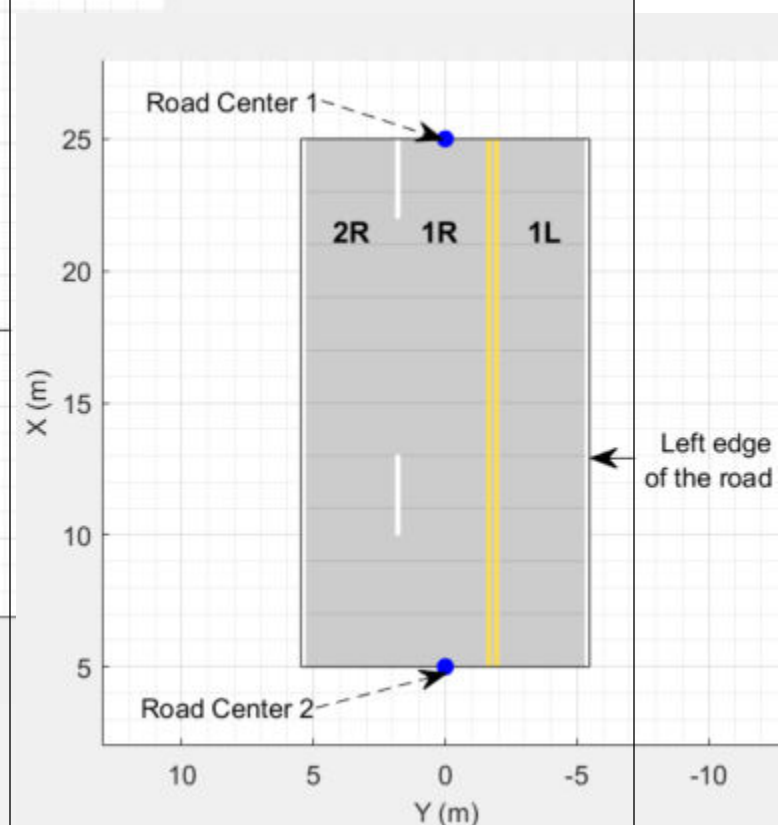

The lane specifications apply by the order in which the lanes are numbered.

Composite Lane Specification

A *composite lane specification* consists of an array of two or more lane specifications for a single road. Each lane specification defines a *road segment*, which is a section of the road with independent geometric properties, normalized range, and taper.

Each road segment is a directed segment that moves toward the final road center, with the first segment beginning at the first road center, the second segment starting where the first ends, and so on. The range of each road segment is a normalized distance that specifies a proportion of the total length of the road. When a road segment adds or drops lanes from a previous segment, the preceding segment tapers along a specified distance to accommodate the change in number of lanes.

When you render a road with composite lane specifications, the road segments render in the draw direction of the road. For example, consider a one-way road with two road segments and a default normalized range of 0.5 for each road segment. The first road segment contains four lanes and the second segment contains only two lanes. The first segment tapers from four lanes to two lanes, dropping one lane from each side, as it approaches the halfway point of the road, which is the start point of the second segment. These diagrams show the direction in which the road segments render, and how the taper applies to the road, for both the left-to-right and right-to-left draw directions.

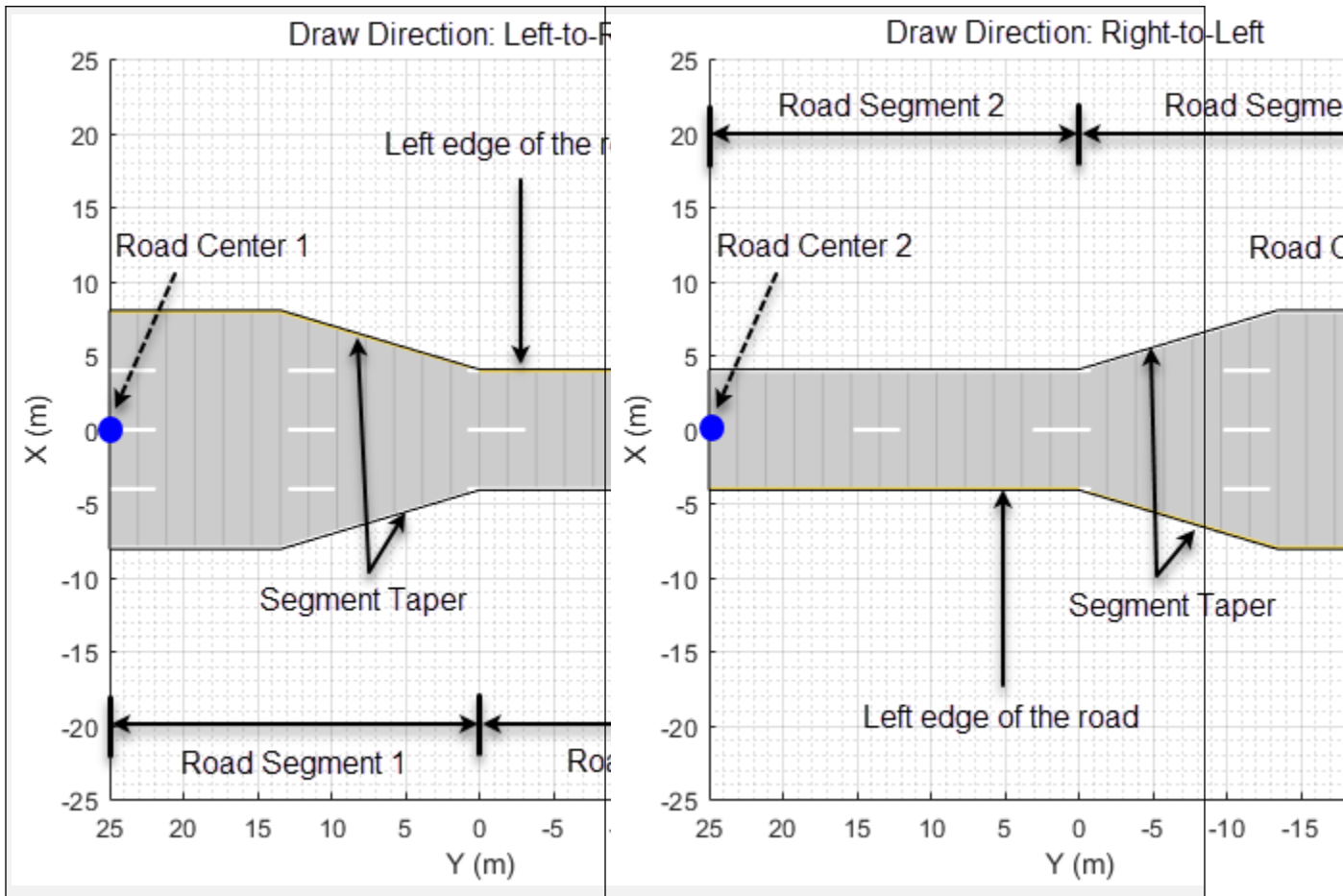

For information on the geometric properties of lanes, see “Lane Specifications” on page 4-656.

Version History

Introduced in R2021a

See Also

Objects

`drivingScenario` | `compositeLaneSpec` | `lanespec`

Functions

`road` | `roadNetwork` | `roadGroup` | `laneMarking` | `laneType`

Topics

“Create Roads with Multiple Lane Specifications Using Driving Scenario Designer”

laneMarking

Create road lane marking object

Syntax

```
lm = laneMarking(type)
lm = laneMarking(type,Name,Value)

cm = laneMarking(lmArray)
cm = laneMarking(lmArray, 'SegmentRange', range)
```

Description

Single Marking Type Along Lane

`lm = laneMarking(type)` creates a default lane marking object of the specified type (solid lane, dashed lane, and so on). This object defines the characteristics of a lane boundary marking on a road. When creating roads in a driving scenario, you can use lane marking objects as inputs to the `lanespec` object.

`lm = laneMarking(type,Name,Value)` set the properties of the lane marking object using one or more name-value pairs. For example, `laneMarking('Solid','Color','yellow')` creates a solid yellow lane marking.

Multiple Marking Types Along Lane

`cm = laneMarking(lmArray)` creates a composite lane marking object from an array of lane marking objects, `lmArray`. Use this syntax to generate lane markings that contain multiple marker types.

For example, create a lane boundary marking that has both solid and dashed marking types by defining `lmArray`.

```
lmArray = [laneMarking('Solid') laneMarking('Dashed')]
cm = laneMarking(lmArray)
```

The order in which the marking types occur depend on the draw direction of the road. For more information, see [Draw Direction of Road and Numbering of Lanes](#) on page 4-652 and [Composite Lane Marking](#) on page 4-655.

`cm = laneMarking(lmArray, 'SegmentRange', range)` specifies the range for each marker type in the composite lane marking by using the name-value pair argument `'SegmentRange', range`.

Examples

Create Straight Four-Lane Road

Create a driving scenario and the road centers for a straight, 80-meter road.

```
scenario = drivingScenario;
roadCenters = [0 0; 80 0];
```

Create a `lanespec` object for a four-lane road. Use the `laneMarking` function to specify its five lane markings. The center line is double-solid and double yellow. The outermost lines are solid and white. The inner lines are dashed and white.

```
solidW = laneMarking('Solid','Width',0.3);
dashW = laneMarking('Dashed','Space',5);
doubleY = laneMarking('DoubleSolid','Color','yellow');
lspec = lanespec([2 2],'Width',[5 5 5 5], ...
    'Marking',[solidW dashW doubleY dashW solidW]);
```

Add the road to the driving scenario. Display the road.

```
road(scenario,roadCenters,'Lanes',lspec);
plot(scenario)
```

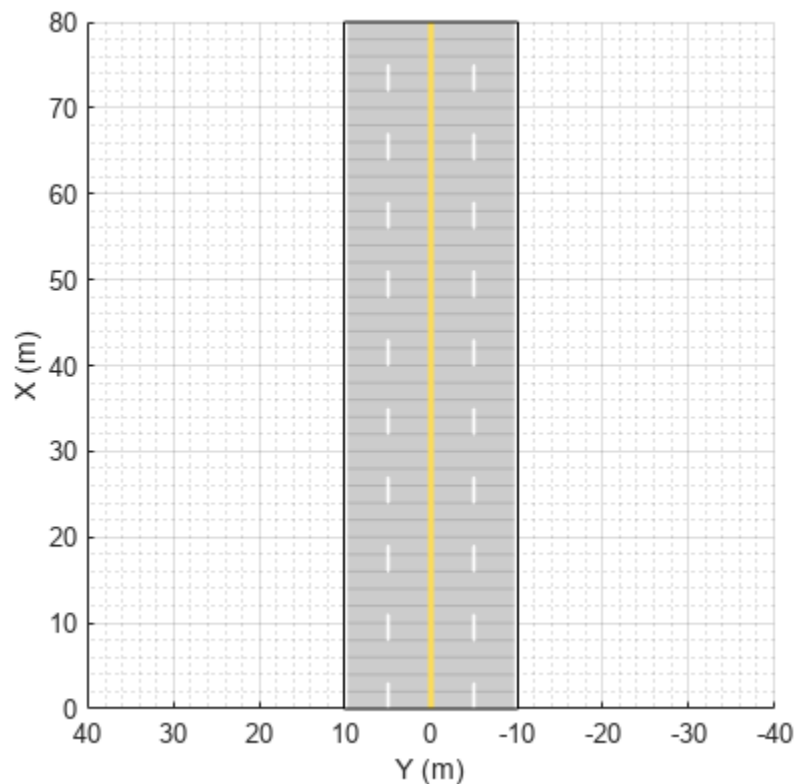

Simulate Car Traveling on S-Curve

Simulate a driving scenario with one car traveling on an S-curve. Create and plot the lane boundaries.

Create the driving scenario with one road having an S-curve.

```
scenario = drivingScenario('StopTime',3);
roadcenters = [-35 20 0; -20 -20 0; 0 0 0; 20 20 0; 35 -20 0];
```

Create the lanes and add them to the road.

```
lm = [laneMarking('Solid','Color','w'); ...
      laneMarking('Dashed','Color','y'); ...
      laneMarking('Dashed','Color','y'); ...
      laneMarking('Solid','Color','w')];
ls = lanespec(3,'Marking',lm);
road(scenario,roadcenters,'Lanes',ls);
```

Add an ego vehicle and specify its trajectory from its waypoints. By default, the car travels at a speed of 30 meters per second.

```
car = vehicle(scenario, ...
              'ClassID',1, ...
              'Position',[-35 20 0]);
waypoints = [-35 20 0; -20 -20 0; 0 0 0; 20 20 0; 35 -20 0];
smoothTrajectory(car,waypoints);
```

Plot the scenario and corresponding chase plot.

```
plot(scenario)
```

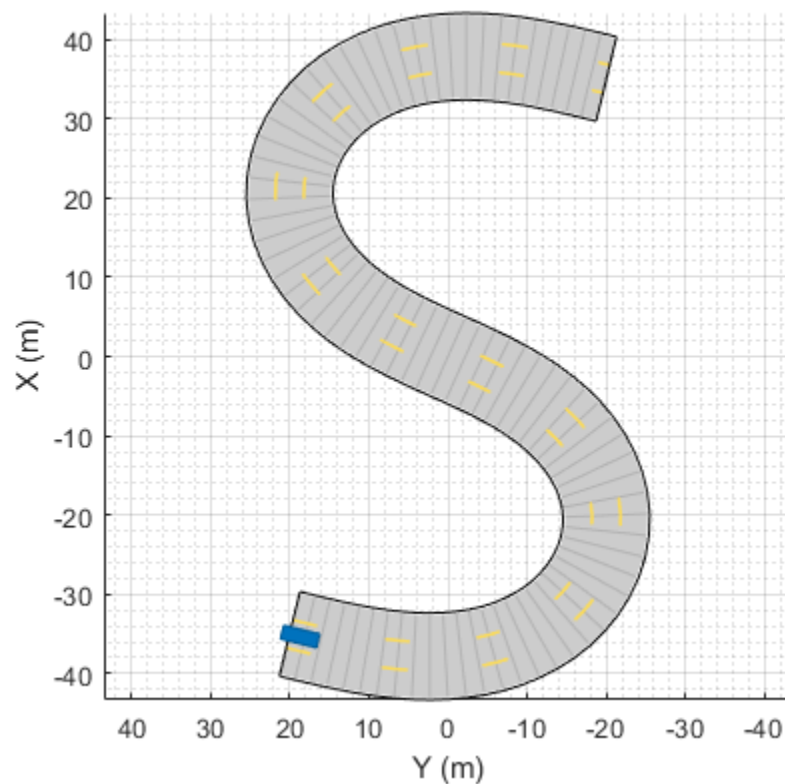

```
chasePlot(car)
```



Run the simulation loop.

- 1 Initialize a bird's-eye plot and create an outline plotter, left-lane and right-lane boundary plotters, and a road boundary plotter.
- 2 Obtain the road boundaries and rectangular outlines.
- 3 Obtain the lane boundaries to the left and right of the vehicle.
- 4 Advance the simulation and update the plotters.

```

bep = birdsEyePlot('XLim',[-40 40], 'YLim',[-30 30]);
olPlotter = outlinePlotter(bep);
lblPlotter = laneBoundaryPlotter(bep, 'Color', 'r', 'LineStyle', '-');
lbrPlotter = laneBoundaryPlotter(bep, 'Color', 'g', 'LineStyle', '-');
rbsEdgePlotter = laneBoundaryPlotter(bep);
legend('off');
while advance(scenario)
    rbs = roadBoundaries(car);
    [position, yaw, length, width, originOffset, color] = targetOutlines(car);
    lb = laneBoundaries(car, 'XDistance', 0:5:30, 'LocationType', 'Center', ...
        'AllBoundaries', false);
    plotLaneBoundary(rbsEdgePlotter, rbs)
    plotLaneBoundary(lblPlotter, {lb(1).Coordinates})
    plotLaneBoundary(lbrPlotter, {lb(2).Coordinates})
    plotOutline(olPlotter, position, yaw, length, width, ...
        'OriginOffset', originOffset, 'Color', color)
end

```

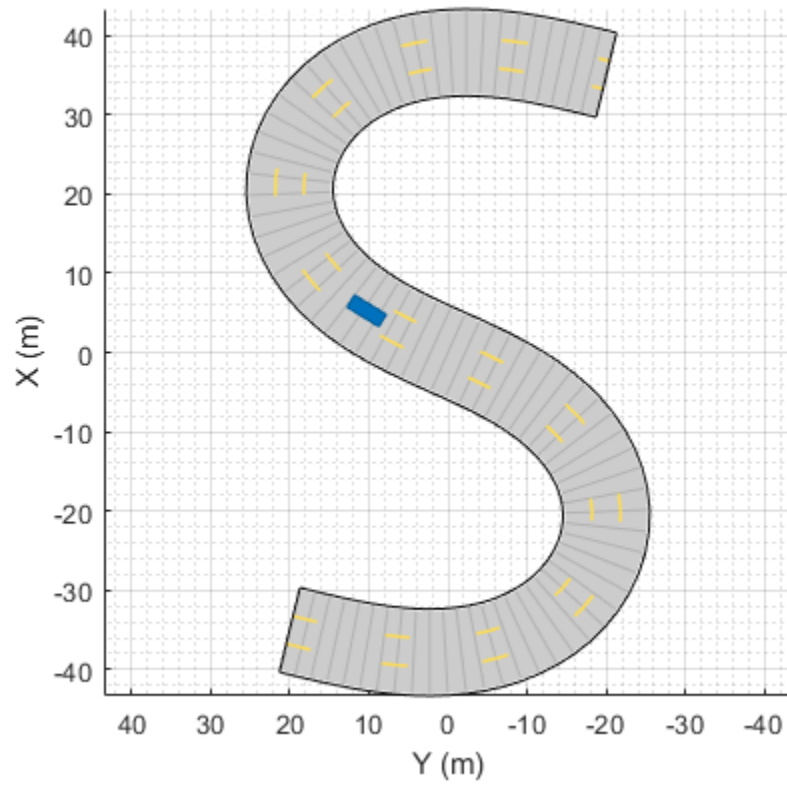

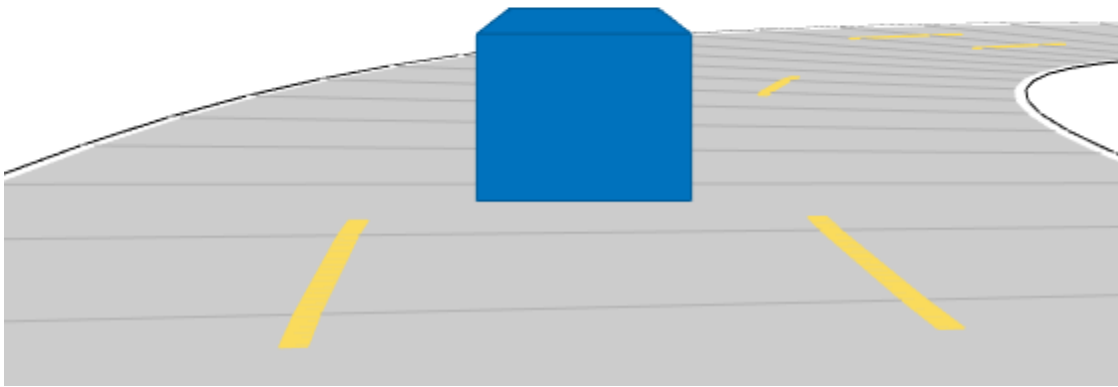

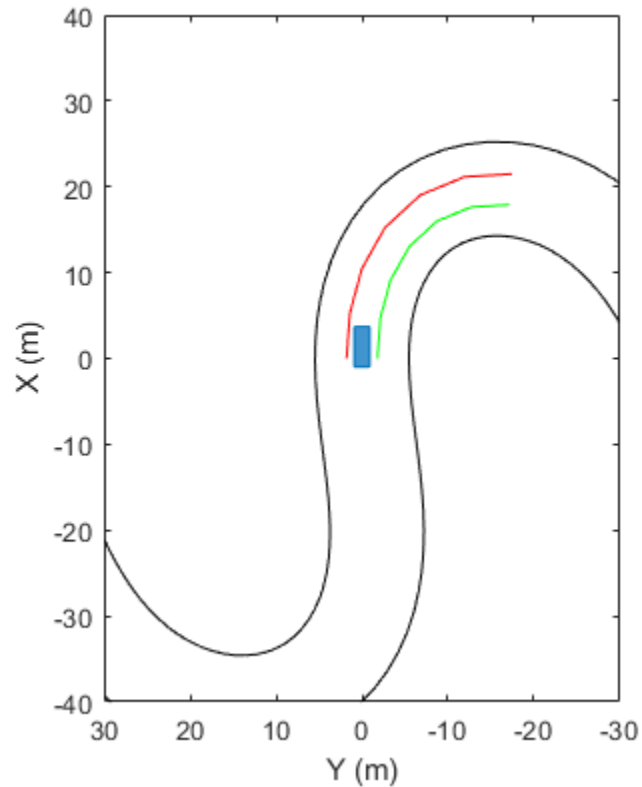

Driving Scenario for Changing Lanes and Passing Vehicles

This example shows how to create a driving scenario for maneuvers such as changing lanes and passing other vehicles. You create roads with passing zones and add vehicles to the scenario. Then, define the trajectories for these vehicles to simulate vehicle lane change in passing zones.

Create Road with Passing Zones by Using Composite Lane Marking

Create a driving scenario. Specify the road centers and the number of lanes to add a two-way, two-lane straight road of 54 meters with draw direction from top-to-bottom.

```
scenario = drivingScenario('StopTime',10);
roadCenters = [50 0; -4 0];
numLanes = [1 1];
```

Typically, the number of lane markings is equal to number of lanes plus one. A two-way, two-lane road has 3 lane markings and the outermost lane markings at both the edges are solid white lines.

Create a solid marking object of marking width 0.25 meters, to constitute the outermost lane markings for the two-way road.

```
outerLM = laneMarking('Solid','Width',0.25);
```

Create a lane marking array of `SolidMarking` and `DashedMarking` objects that contain the properties for solid and dashed double yellow lines.

```
lmArray = [laneMarking('DoubleSolid', 'Color', 'Yellow', 'Width', 0.25)
           laneMarking('DashedSolid', 'Color', 'Yellow', 'Length', 1, 'Space', 1.5, 'Width', 0.25)
           laneMarking('DoubleSolid', 'Color', 'Yellow', 'Width', 0.25)
           laneMarking('SolidDashed', 'Color', 'Yellow', 'Length', 1, 'Space', 1.5, 'Width', 0.25)];
```

Create a composite lane marking object for the center lane marking by using the lane marking array. Specify the normalized length for each marking object.

```
centerLM = laneMarking(lmArray, 'SegmentRange', [0.1 0.25 0.2 0.35]);
```

Create a vector of the outermost and the center lane marking objects. Pass the vector as input to the `lanespec` function in order to define the lane specifications of the road.

```
marking = [outerLM centerLM outerLM];
ls = lanespec(numLanes, 'Width', 7, 'Marking', marking);
```

Add the road to the driving scenario. Plot the driving scenario. Since the draw direction of the road is from top-to-bottom, the marking types in the composite lane marking also occur in top-to-bottom order.

```
road(scenario, roadCenters, 'Lanes', ls);
figMark = figure;
set(figMark, 'Position', [0 0 600 600]);
hPlot = axes(figMark);
plot(scenario, 'Parent', hPlot);
title('Composite Marking: Road with Passing Zones')
```

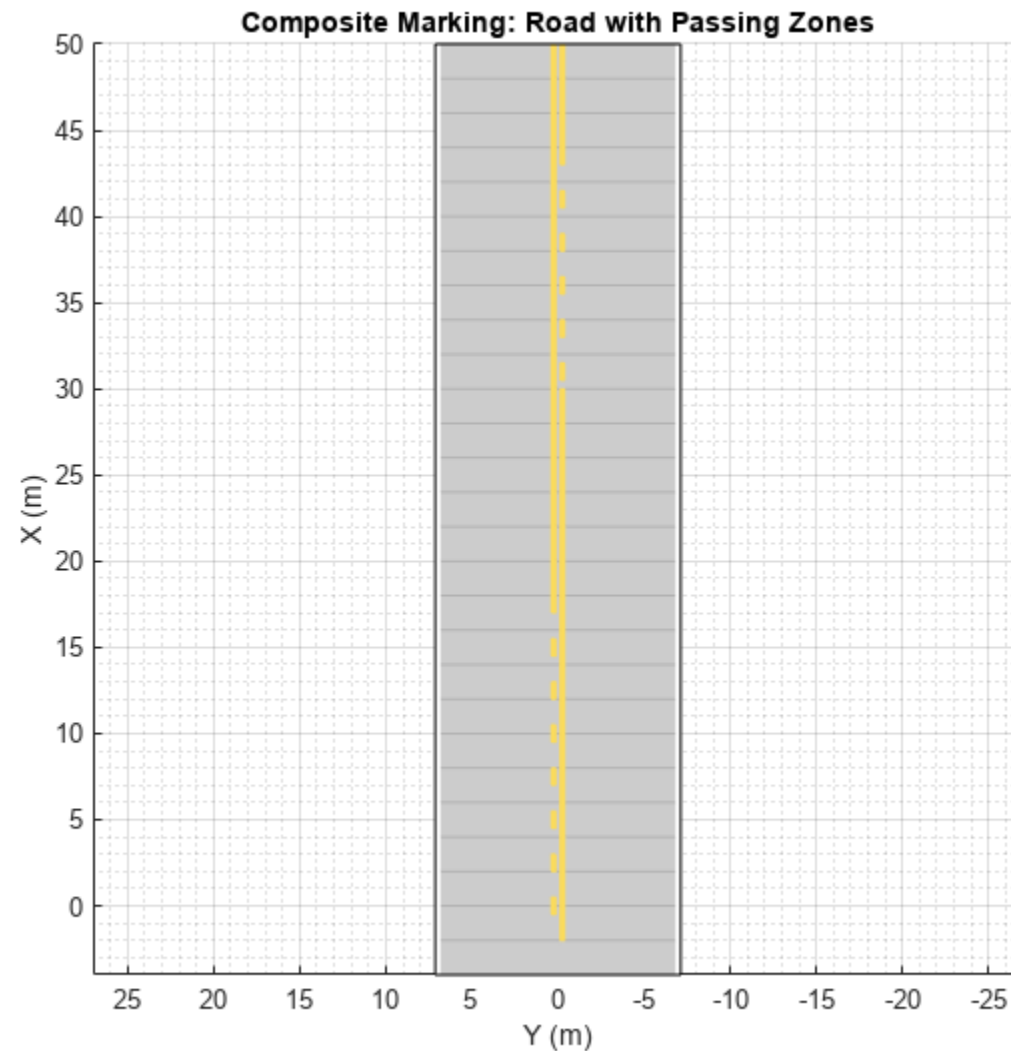

Simulate Vehicle Lane Change in Passing Zones

Add a slow moving vehicle (SMV) to the scenario. Specify the waypoints and speed value to set the trajectory for the SMV.

```
slowVehicle = vehicle(scenario, 'ClassID', 1, 'Position', [37 -3 0]);
waypoints = [37 -3; 12 -3];
speed = 2;
smoothTrajectory(slowVehicle, waypoints, speed);
```

Add another vehicle to the scenario. Set the trajectory for the vehicle in such a way that it passes the SMV in front of it by changing lanes at the passing zones.

```
passingVehicle = vehicle(scenario, 'ClassID', 1, 'Position', [49 -3 0]);
waypoints = [49 -3; 45 -3; 40 -3; 35 0];
```



```
        30 3; 26 3; 22 3; 18 3;  
        8 0; 5 -2; 2 -3; 1 -3];  
speed = 6;  
smoothTrajectory(passingVehicle,waypoints,speed);
```

Create a custom figure window and plot the scenario.

```
close all;  
figScene = figure;  
set(figScene,'Position',[0 0 600 600]);  
hPanel = uipanel(figScene);  
hPlot = axes(hPanel);  
plot(scenario,'Parent',hPlot);  
title('Passing Zone: Change Lane and Pass Other Vehicle')  
  
% Run the simulation  
while advance(scenario)  
    pause(0.01)  
end
```

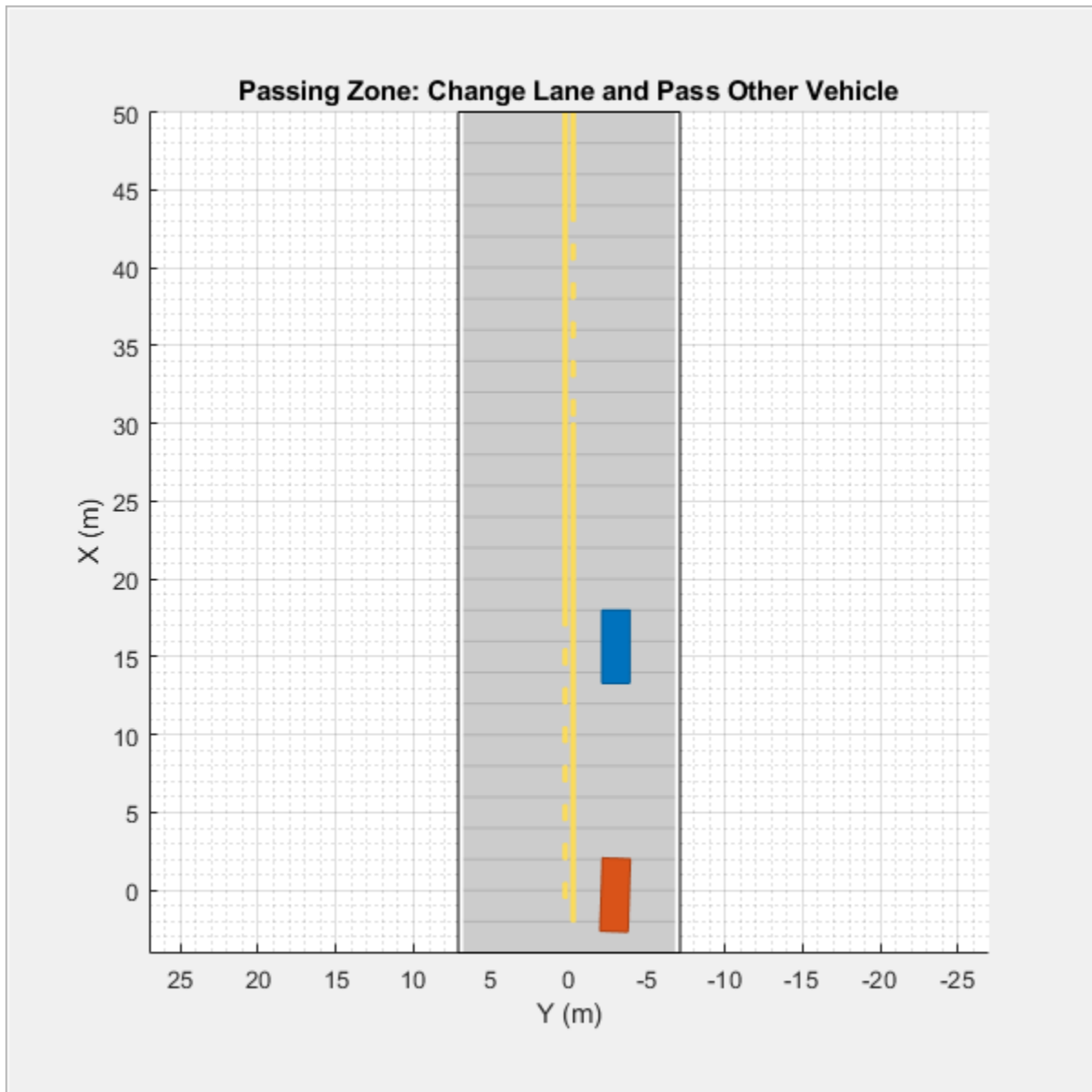





Input Arguments

type — Type of lane marking

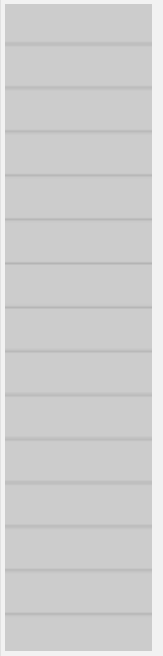
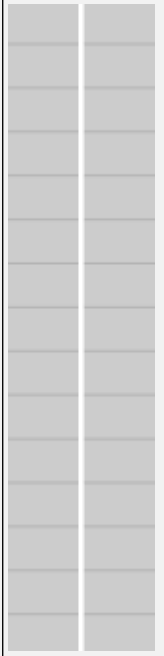
'Unmarked' | 'Solid' | 'Dashed' | 'DoubleSolid' | 'DoubleDashed' | 'SolidDashed' | 'DashedSolid'

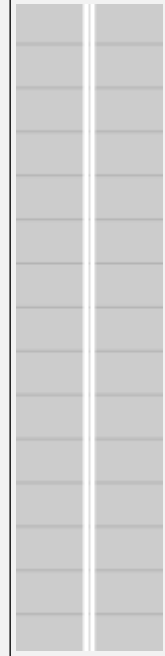
Type of lane marking, specified as one of these values.

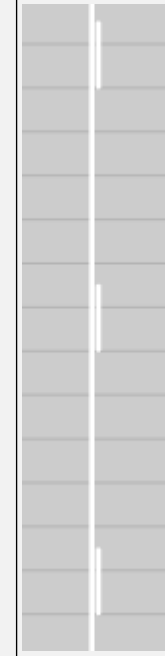
'Unmarked'	'Solid'	'Dashed'	'DoubleSolid'	'DoubleDashed'	'SolidDashed'	'DashedSolid'
No lane marking	Solid line	Dashed line	Two solid lines	Two dashed lines	Solid line on left, dashed line on right	Dashed line on left, solid line on right
						

The type of lane marking is stored in `Type`, a read-only property of the returned lane marking object.

lmArray — 1-D array of lane marking objects

LaneMarking object | SolidMarking object | DashedMarking object

1-D array of lane marking objects, specified as

- LaneMarking object for 'Unmarked' type of lane marking.
- SolidMarking object for 'Solid' and 'DoubleSolid' types of lane marking.
- DashedMarking object for 'Dashed', 'DoubleDashed', 'SolidDashed', and 'DashedSolid' types of lane marking.

Example: `lmArray = [laneMarking('Solid') laneMarking('Dashed')]`

range — Range for each marking type

vector

Range for each marking type, specified as a vector with normalized values in the interval [0, 1]. The length of the vector must be same as the number of marking types specified in the input array `lmArray`.

The default range value for each marking type in the lane is the inverse of the number of marking types specified in `lmArray`.

For example, if the input lane marking array contains three lane marking objects, such as `lmArray = [laneMarking('Solid') laneMarking('Dashed') laneMarking('Solid')]`, then the default range value for each marking type is 1/3, that is `range = [0.3330 0.3330 0.3330]`.

Name-Value Pair Arguments

Specify optional pairs of arguments as `Name1=Value1, ..., NameN=ValueN`, where `Name` is the argument name and `Value` is the corresponding value. Name-value arguments must appear after other arguments, but the order of the pairs does not matter.

Before R2021a, use commas to separate each name and value, and enclose Name in quotes.

Example: `laneMarking('Dashed', 'Width', 0.25, 'Length', 5.0)` creates a lane with dashes that are 0.25 meters wide and spaced 5 meters apart.

Width — Lane marking widths

0.15 (default) | positive real scalar

Lane marking widths, specified as the comma-separated pair consisting of `'Width'` and a positive real scalar. For a double lane marker, the same width is used for both lines. Units are in meters.

The width of the lane marking must be less than the width of its enclosing lane. The *enclosing lane* is the lane directly to the left of the lane marking.

Example: 0.20

Color — Color of lane marking



[1 1 1] (white) (default) | RGB triplet | hexadecimal color code | color name | short color name



Color of lane marking, specified as the comma-separated pair consisting of `'Color'` and an RGB triplet, a hexadecimal color code, a color name, or a short color name. For a double lane marker, the same color is used for both lines.

For a custom color, specify an RGB triplet or a hexadecimal color code.

- An RGB triplet is a three-element row vector whose elements specify the intensities of the red, green, and blue components of the color. The intensities must be in the range $[0, 1]$, for example, `[0.4 0.6 0.7]`.
- A hexadecimal color code is a string scalar or character vector that starts with a hash symbol (`#`) followed by three or six hexadecimal digits, which can range from 0 to F. The values are not case sensitive. Therefore, the color codes `"#FF8800"`, `"#ff8800"`, `"#F80"`, and `"#f80"` are equivalent.

Alternatively, you can specify some common colors by name. This table lists the named color options, the equivalent RGB triplets, and hexadecimal color codes.

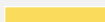
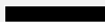
Color Name	Short Name	RGB Triplet	Hexadecimal Color Code	Appearance
'red'	'r'	[1 0 0]	'#FF0000'	
'green'	'g'	[0 1 0]	'#00FF00'	
'blue'	'b'	[0 0 1]	'#0000FF'	
'cyan'	'c'	[0 1 1]	'#00FFFF'	

Color Name	Short Name	RGB Triplet	Hexadecimal Color Code	Appearance
'magenta'	'm'	[1 0 1]	'#FF00FF'	
'yellow'	'y'	[0.98 0.86 0.36]	'#FADB5C'	
'black'	'k'	[0 0 0]	'#000000'	
'white'	'w'	[1 1 1]	'#FFFFFF'	

Example: [0.8 0.8 0.8]

Strength — Saturation strength of lane marking color

1 (default) | real scalar in the range [0, 1]

Saturation strength of lane marking color, specified as the comma-separated pair consisting of 'Strength' and a real scalar in the range [0, 1]. A value of 0 corresponds to a marking whose color is fully unsaturated. The marking is gray. A value of 1 corresponds to a marking whose color is fully saturated. For a double lane marking, the same strength is used for both lines.

Example: 0.20

Length — Length of dash in dashed lines

3.0 (default) | positive real scalar

Length of dash in dashed lines, specified as the comma-separated pair consisting of 'Length' and a positive real scalar. For a double lane marking, the same length is used for both lines. The dash is the visible part of a dashed line. Units are in meters.

Example: 2.0

Space — Length of space between dashes in dashed lines

9.0 (default) | positive real scalar

Length of space between the end of one dash and the beginning of the next dash, specified as the comma-separated pair consisting of 'Space' and a positive real scalar. For a double lane marking, the same length is used for both lines. Units are in meters.

Example: 2.0

Output Arguments

lm — Lane marking

LaneMarking object | SolidMarking object | DashedMarking object

Lane marking, returned as a LaneMarking object, SolidMarking object, or DashedMarking object. The type of returned object depends on the type of input lane marking specified for the type input.

Input Type	Output Lane Marking	Lane Marking Properties
'Unmarked'	LaneMarking object	• Type
'Solid'	SolidMarking object	• Color • Width

Input Type	Output Lane Marking	Lane Marking Properties
'DoubleSolid'		<ul style="list-style-type: none"> • Strength • Type
'Dashed'	DashedMarking object	• Length
'DashedSolid'		• Space
'SolidDashed'		• Color
'DoubleDashed'		• Width
		<ul style="list-style-type: none"> • Strength • Type

You can set these properties when you create the lane marking object by using the corresponding name-value pairs of the `laneMarking` function. To update these properties after creation, use dot notation. For example:

```
lm = laneMarking('Solid');
lm.Width = 0.2;
```

You can set all properties after creation except `Type`, which is read-only. For details on the geometric properties of the `SolidMarking` and `DashedMarking` objects, see Lane Specifications on page 4-656.

cm — Composite lane marking

`CompositeMarking` object

Composite lane marking, returned as a `CompositeMarking` object with properties `Markings` and `SegmentRange`.

Composite Lane Marking Properties	Description
Markings	This property is an array of lane marking objects that defines the multiple marking types comprising the composite lane marking. The part of the lane marking defined by each lane marking object is a marker segment. This property is read-only.
SegmentRange	This property specifies the normalized range for each marker segment in the composite lane marking. This property is read-only.

Use this object to specify multiple marking types along a lane. For more details on how to specify composite lane markings and the order of marker segments along the lane, see “Composite Lane Marking” on page 4-655.

More About

Draw Direction of Road and Numbering of Lanes

To create a road by using the `road` function, specify the road centers as a matrix input. The function creates a directed line that traverses the road centers, starting from the coordinates in the first row of the matrix and ending at the coordinates in the last row of the matrix. The coordinates in the first two rows of the matrix specify the draw direction of the road. These coordinates correspond to the

first two consecutive road centers. The draw direction is the direction in which the roads render in the scenario plot.

To create a road by using the **Driving Scenario Designer** app, you can either specify the **Road Centers** parameter or interactively draw on the **Scenario Canvas**. For a detailed example, see “Create a Driving Scenario” on page 1-14. In this case, the draw direction is the direction in which roads render in the **Scenario Canvas**.

- For a road with a top-to-bottom draw direction, the difference between the x-coordinates of the first two consecutive road centers is positive.
- For a road with a bottom-to-top draw direction, the difference between the x-coordinates of the first two consecutive road centers is negative.

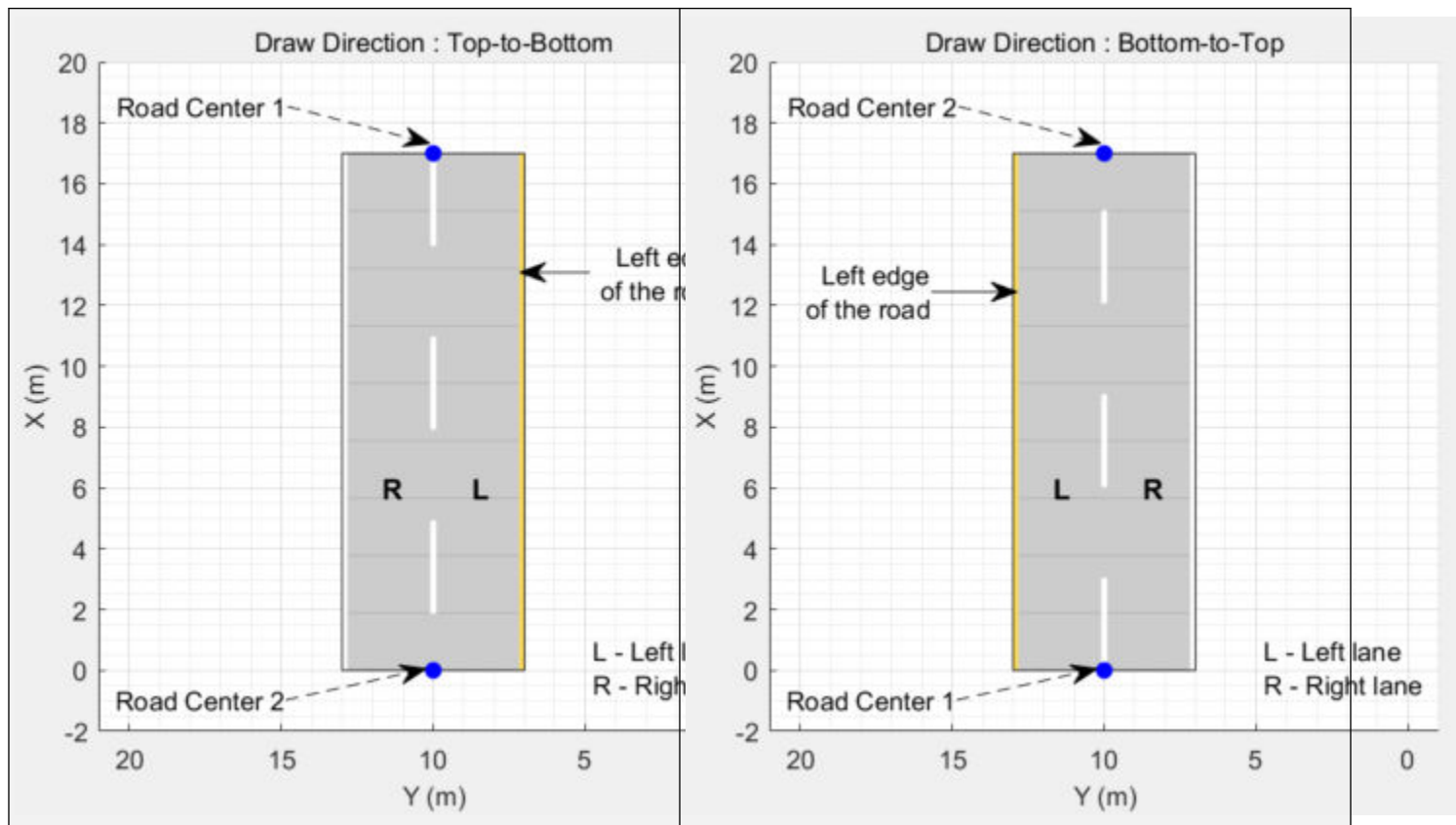

- For a road with a left-to-right draw direction, the difference between the y-coordinates of the first two consecutive road centers is positive.
- For a road with a right-to-left draw direction, the difference between the y-coordinates of the first two consecutive road centers is negative.

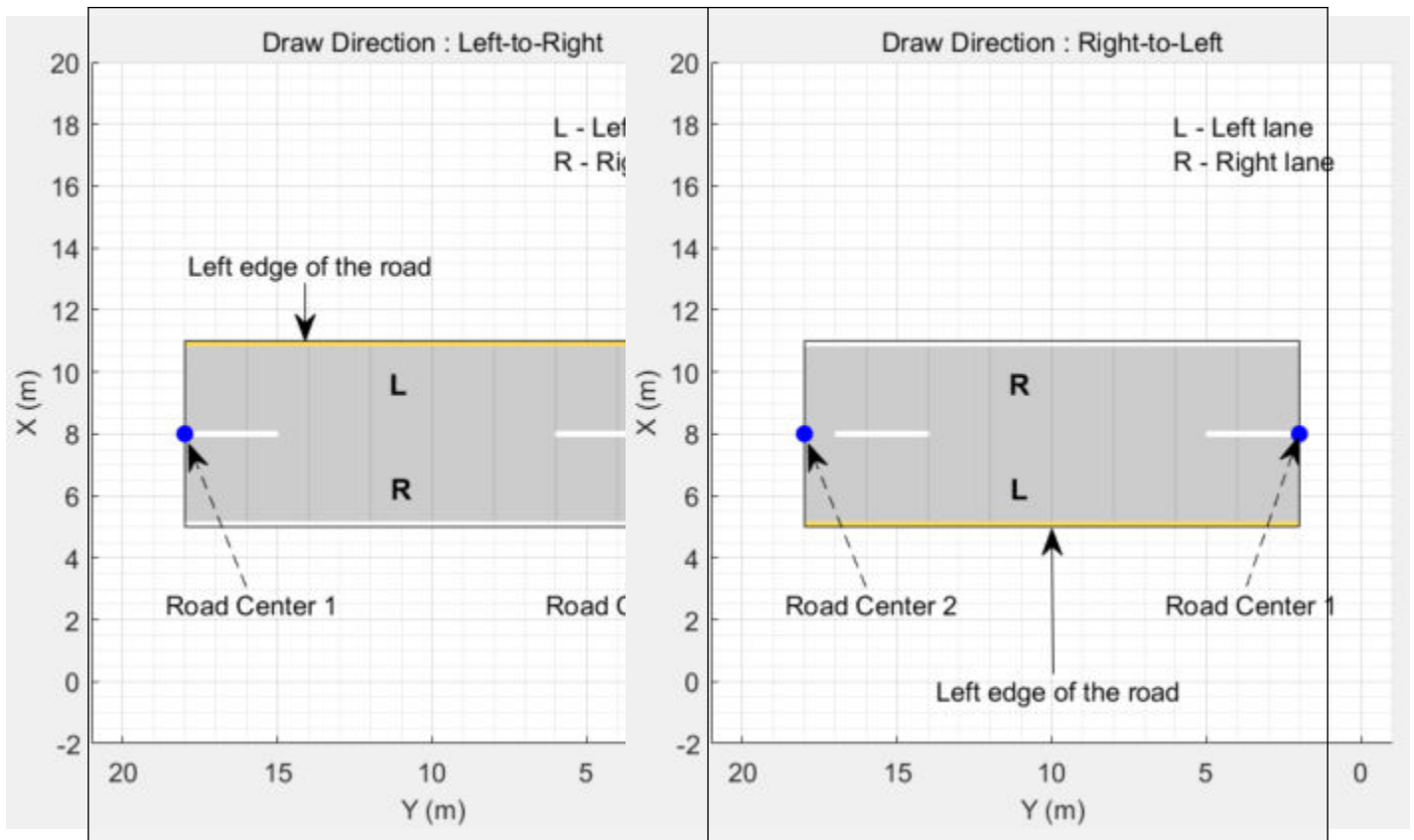

Numbering Lanes

Lanes must be numbered from left to right, with the left edge of the road defined relative to the draw direction of the road. For a one-way road, by default, the left edge of the road is a solid yellow marking which indicates the end of the road in transverse direction (direction perpendicular to draw direction). For a two-way road, by default, both edges are marked with solid white lines.

For example, these diagrams show how the lanes are numbered in a one-way and two-way road with a draw direction from top-to-bottom.

Numbering Lanes in a One-Way Road	Numbering Lanes in a Two-Way Road
--	--

Specify the number of lanes as a positive integer for a one-way road. If you set the integer value as 3, then the road has three lanes that travel in the same direction. The lanes are numbered starting from the left edge of the road.

1, 2, 3 denote the first, second, and third lanes of the road, respectively.

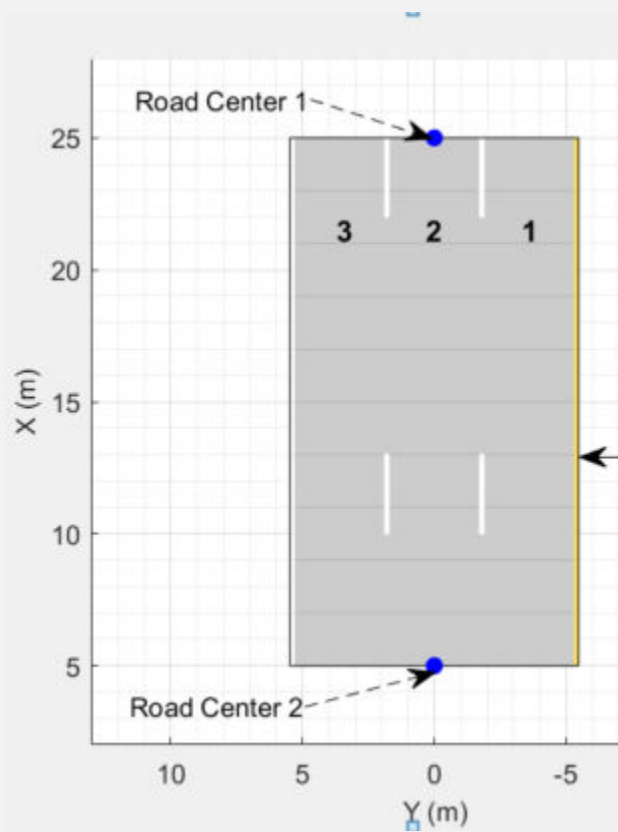

Specify the number of lanes as a two-element vector of positive integer for a two-way road. If you set the vector as [1 2], then the road has three lanes: two lanes traveling in one direction and one lane traveling in the opposite direction. Because of the draw direction, the road has one left lane and two right lanes. The lanes are numbered starting from the left edge of the road.

1L denote the only left lane of the road. **1R** and **2R** denote the first and second right lanes of the road, respectively.

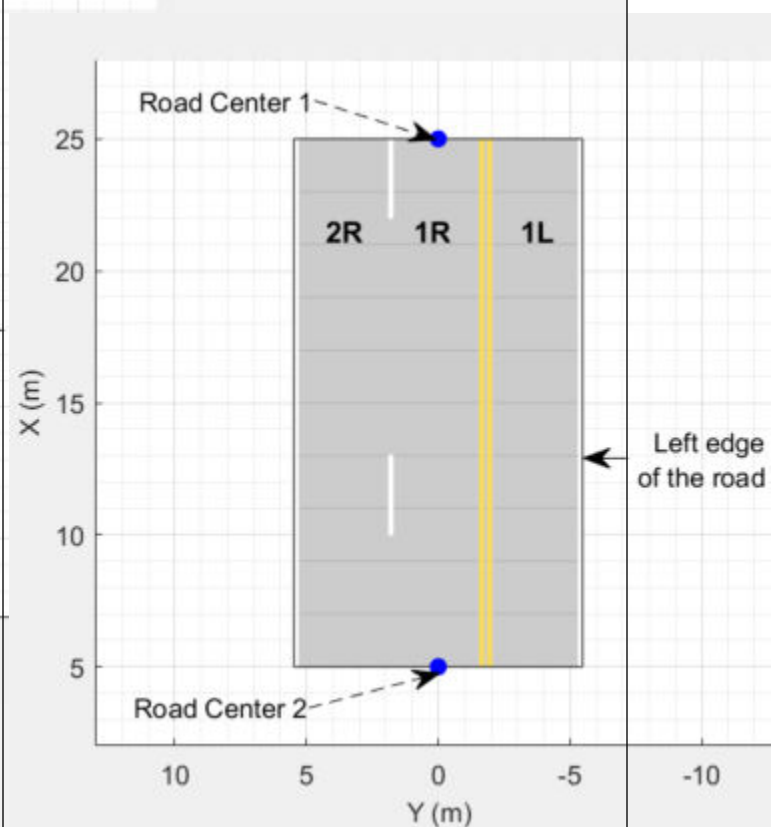

The lane specifications apply by the order in which the lanes are numbered.

Composite Lane Marking

A composite lane marking comprises two or more marker segments that define multiple marking types along a lane. The geometric properties for a composite lane marking include the geometric properties of each marking type and the normalized lengths of the marker segments.

The order in which the specified marker segments occur in a composite lane marking depends on the draw direction of the road. Each marker segment is a directed segment with a start point and moves towards the last road center. The first marker segment starts from the first road center and moves towards the last road center for a specified length. The second marker segment starts from the end point of the first marker segment and moves towards the last road center for a specified length. The

same process applies for each marker segment that you specify for the composite lane marking. You can set the normalized length for each of these marker segments by specifying the range input argument.

For example, consider a one-way road with two lanes. The second lane marking from the left edge of the road is a composite lane marking with marking types `Solid` and `Dashed`. The normalized range for each marking type is 0.5. The first marker segment is a solid marking and the second marker segment is a dashed marking. These diagrams show the order in which the marker segments apply for left-to-right and right-to-left draw directions of the road.

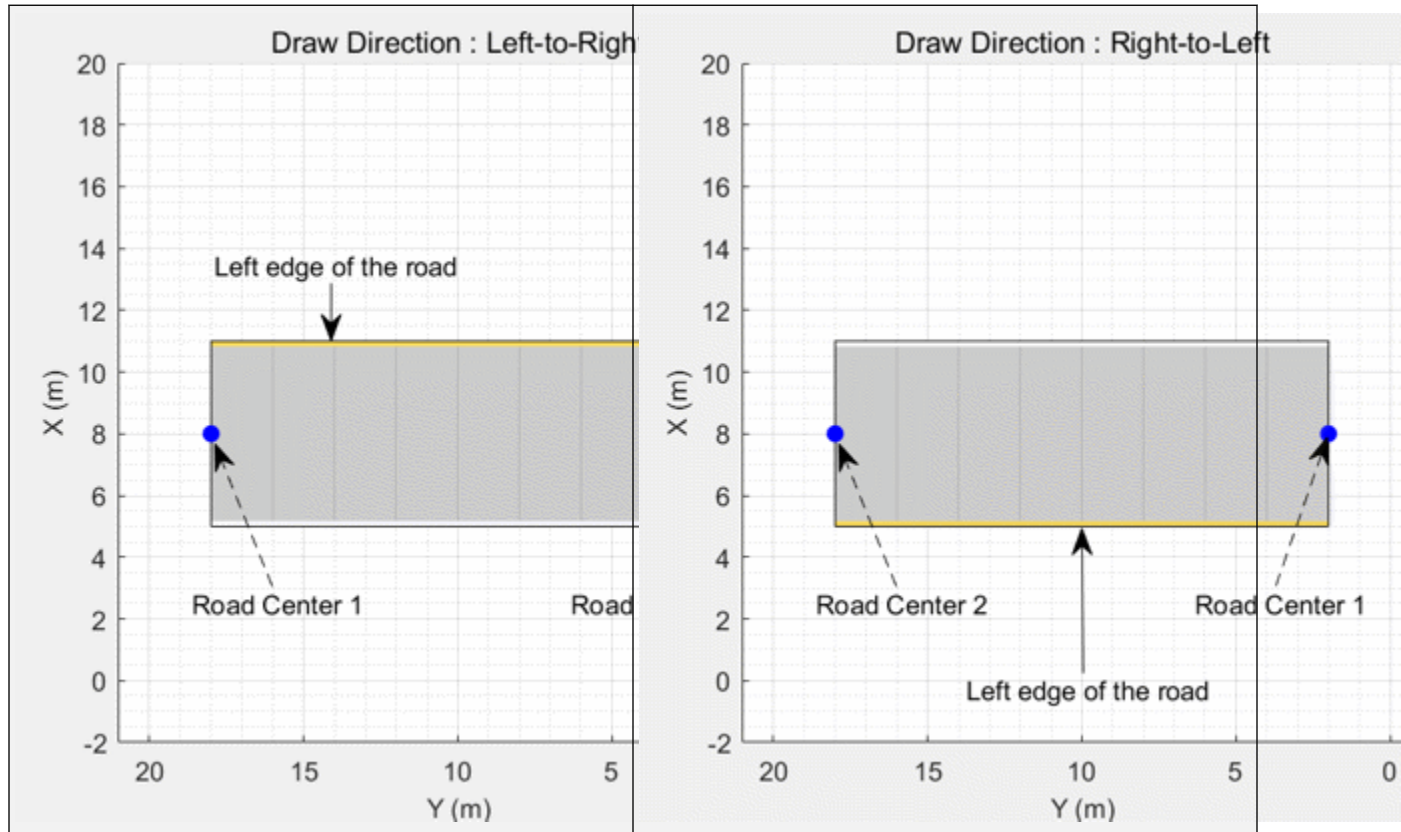

For information on the geometric properties of lane markings, see “Lane Specifications” on page 4-656.

Lane Specifications

The diagram shows the components and geometric properties of roads, lanes, and lane markings.

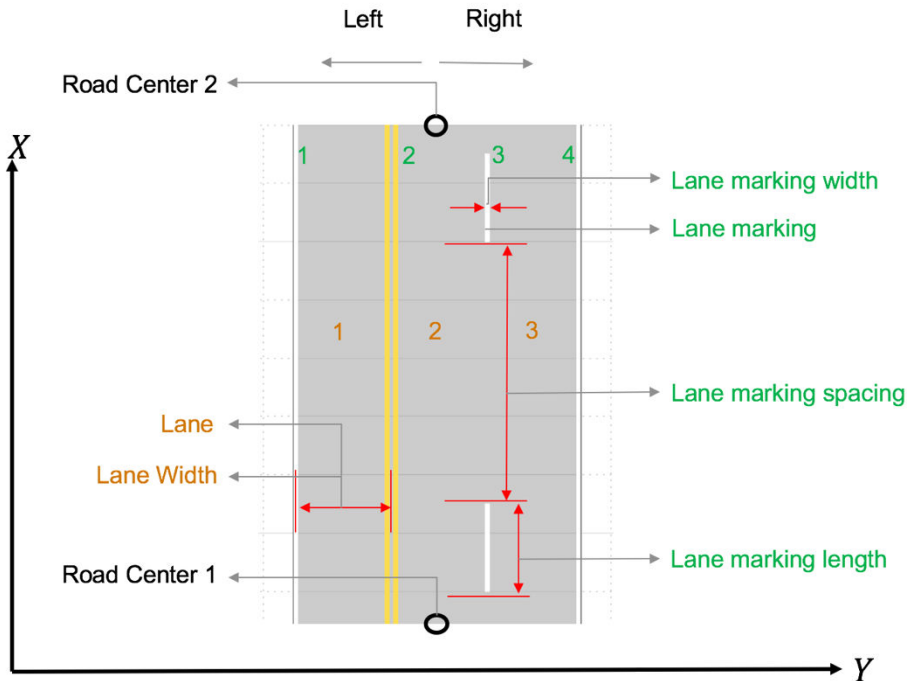

The lane specification object, `lanespec`, defines the road lanes.

- The `NumLanes` property specifies the number of lanes. You must specify the number of lanes when you create this object.
- The `Width` property specifies the width of each lane.
- The `Marking` property contains the specifications of each lane marking in the road. `Marking` is an array of lane marking objects, with one object per lane. To create these objects, use the `laneMarking` function. Lane marking specifications include:
 - `Type` — Type of lane marking (solid, dashed, and so on)
 - `Width` — Lane marking width
 - `Color` — Lane marking color
 - `Strength` — Saturation value for lane marking color
 - `Length` — For dashed lanes, the length of each dashed line
 - `Space` — For dashed lanes, the spacing between dashes
 - `SegmentRange` — For composite lane marking, the normalized length of each marker segment
- The `Type` property contains the lane type specifications of each lane in the road. `Type` can be a homogeneous lane type object or a heterogeneous lane type array.
 - Homogeneous lane type object contains the lane type specifications of all the lanes in the road.
 - Heterogeneous lane type array contains an array of lane type objects, with one object per lane.

To create these objects, use the `laneType` function. Lane type specifications include:

- `Type` — Type of lane (driving, border, and so on)
- `Color` — Lane color

- Strength — Strength of the lane color

Version History

Introduced in R2018a

See Also

Objects

`drivingScenario` | `lanespec` | `compositeLaneSpec`

Functions

`plotLaneBoundary` | `laneMarkingPlotter` | `laneBoundaryPlotter` | `plotLaneMarking` | `road` | `laneMarkingVertices`

laneType

Create road lane type object

Syntax

```
lt = laneType(type)
lt = laneType(type,Name,Value)
```

Description

`lt = laneType(type)` returns a road lane type object with properties `Type`, `Color`, and `Strength` to define different lane types for a road.

You can use this object to create driving scenarios with roads that have driving lanes, border lanes, restricted lanes, shoulder lanes, and parking lanes. You can also load this scenario into the **Driving Scenario Designer** app.

For details on the steps involved in using `laneType` function with the `drivingScenario` object and the **Driving Scenario Designer** app, see “More About” on page 4-666.

`lt = laneType(type,Name,Value)` sets the properties of the output lane type object by using one or more name-value pairs.

Examples

Add Roads That Have Different Lane Types to Driving Scenario

This example shows how to define lane types and simulate a driving scenario for a four-lane road that has different lane types.

Create a driving lane object with default property values.

```
drivingLane = laneType('Driving')
drivingLane =
    DrivingLaneType with properties:
        Type: Driving
        Color: [0.8000 0.8000 0.8000]
        Strength: 1
```

Create a parking lane type object. Specify the color and the strength property values.

```
parkingLane = laneType('Parking','Color',[1 0 0],'Strength',0.1)
parkingLane =
    ParkingLaneType with properties:
        Type: Parking
        Color: [1 0 0]
```

```
Strength: 0.1000
```

Create a three-element, heterogeneous lane type array by concatenating the driving and the parking lane type objects. The lane type array contains lane types for a four-lane road.

```
lt = [parkingLane drivingLane drivingLane parkingLane];
```

Create lane specification for a four-lane road. Add the lane type array to the lane specification.

```
ls = lanespec([2 2], 'Type', lt);
```

Create a driving scenario object. Add the four-lane road with lane specifications `ls` to the driving scenario.

```
scenario = drivingScenario;  
roadCenters = [0 0 0; 40 0 0];  
road(scenario, roadCenters, 'Lanes', ls)
```

```
ans =
```

```
  Road with properties:
```

```
      Name: ""  
     RoadID: 1  
RoadCenters: [2x3 double]  
  RoadWidth: 14.5500  
  BankAngle: [2x1 double]  
    Heading: [2x1 double]
```

Plot the scenario. The scenario contains the four-lane road that has two parking lanes and two driving lanes.

```
plot(scenario)  
legend('Driving Lane', 'Parking Lane')
```

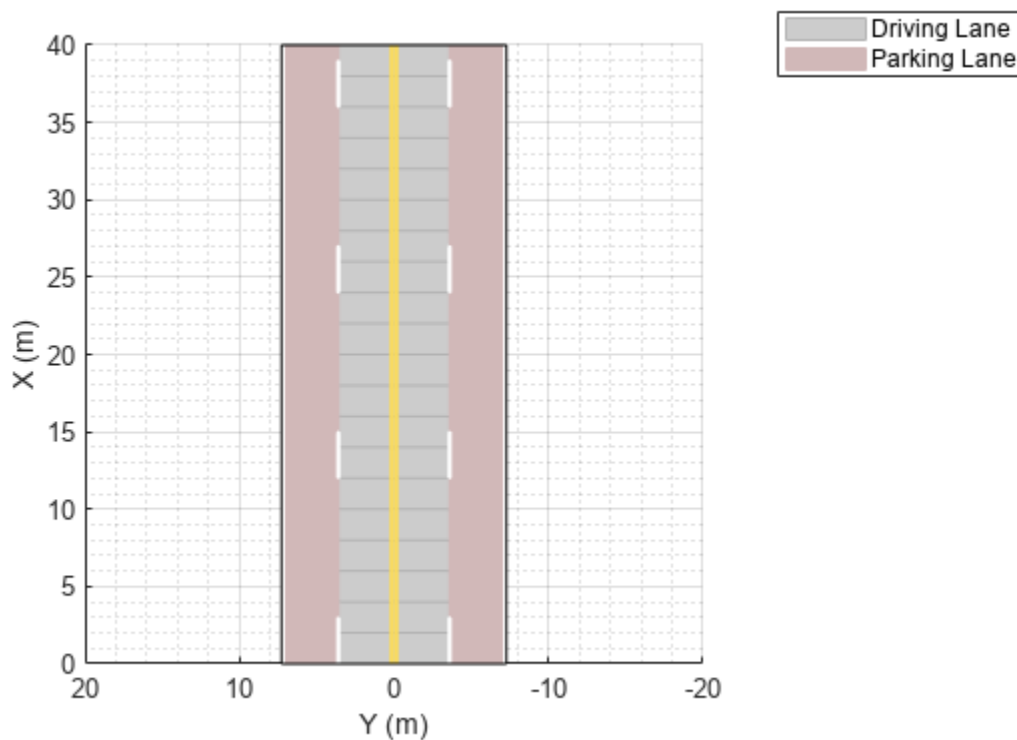

Simulate Vehicles Traveling on Road That Has Multiple Lane Types

Create a heterogeneous lane type object array to define driving, shoulder, and border lane types for a four-lane road.

```
lt = [laneType('Shoulder') laneType('Driving') laneType('Driving') laneType('Border','Color',[0.5
```

Display the lane type object array.

```
lt
```

```
lt=1x4 object
```

```
1x4 heterogeneous LaneType (ShoulderLaneType, DrivingLaneType, BorderLaneType) array with properties
```

```
Type
Color
Strength
```

Inspect the property values.

```
c = [{lt.Type}' {lt.Color}' {lt.Strength}'];
cell2table(c,'VariableNames',{'Type','Color','Strength'})
```

```
ans=4x3 table
```

```
    Type    Color    Strength
```

Shoulder	0.59	0.59	0.59	1
Driving	0.8	0.8	0.8	1
Driving	0.8	0.8	0.8	1
Border	0.5	0	1	0.1

Pass the lane type object array as input to the `lanespec` function, and then create a lane specification object for the four-lane road.

```
lspec = lanespec([2 2], 'Type', lt);
```

Define the road centers.

```
roadCenters = [0 0 0; 40 0 0];
```

To add roads, create a driving scenario object.

```
scenario = drivingScenario('StopTime', 8);
```

Add roads with the specified road centers and lane types to the driving scenario.

```
road(scenario, roadCenters, 'Lanes', lspec);
```

Add two vehicles to the scenario. Position the vehicles on the driving lane.

```
vehicle1 = vehicle(scenario, 'ClassID', 1, 'Position', [5 2 0]);
vehicle2 = vehicle(scenario, 'ClassID', 1, 'Position', [35 -2 0]);
```

Define the vehicle trajectories by using waypoints. Set the vehicle trajectory speeds.

```
waypoints1 = [5 2; 10 2; 20 2; 25 2; 30 5; 34 5.5];
smoothTrajectory(vehicle1, waypoints1, 10)
waypoints2 = [35 -2; 20 -2; 10 -2; 5 -2];
smoothTrajectory(vehicle2, waypoints2, 5)
```

Plot the scenario. To advance the simulation one time step at a time, call the `advance` function in a loop. Pause every 0.01 second to observe the motion of the vehicles on the plot. The first vehicle travels along the trajectory in the driving lane. It drifts to the shoulder lane for emergency stopping.

```
% Create a custom figure window and define an axes object
```

```
fig = figure;
```

```
movegui(fig, 'center');
```

```
hView = uipanel(fig, 'Position', [0 0 1 1], 'Title', 'Scenario with Shoulder, Driving, and Border Lane');
```

```
hPlt = axes(hView);
```

```
% Plot the generated driving scenario along with the waypoints.
```

```
plot(scenario, 'Waypoints', 'on', 'Parent', hPlt);
```

```
while advance(scenario)
```

```
    pause(0.01)
```

```
end
```

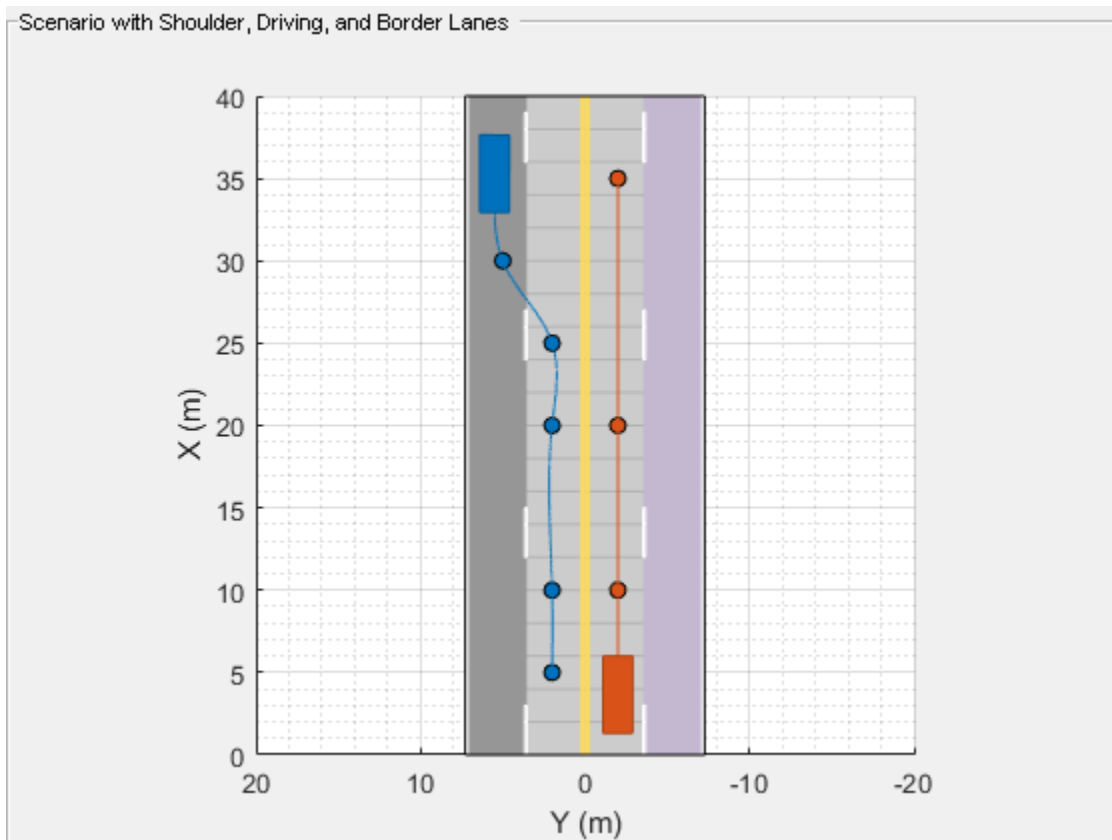
Input Arguments

type – Lane type

'Driving' | 'Border' | 'Restricted' | 'Shoulder' | 'Parking'

Lane type, specified as 'Driving', 'Border', 'Restricted', 'Shoulder', or 'Parking'.

Lane Type	Description
'Driving'	Lanes for driving
'Border'	Lanes at the road borders
'Restricted'	Lanes reserved for high occupancy vehicles
'Shoulder'	Lanes reserved for emergency stopping
'Parking'	Lanes alongside driving lanes, intended for parking vehicles

Note The lane type input sets the Type property of the output lane type object.

Data Types: char | string

Name-Value Pair Arguments

Specify optional pairs of arguments as `Name1=Value1, ..., NameN=ValueN`, where `Name` is the argument name and `Value` is the corresponding value. Name-value arguments must appear after other arguments, but the order of the pairs does not matter.

Before R2021a, use commas to separate each name and value, and enclose `Name` in quotes.



Example: `laneType('Driving','Color','r')`

Color — Lane color



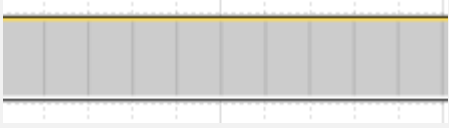

RGB triplet | color name

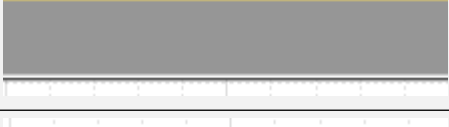
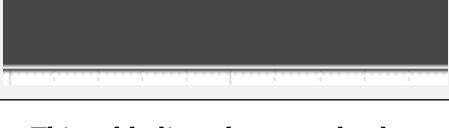

Lane color, specified as the comma-separated pair consisting of `'Color'` and an RGB triplet or color name.

Specify the RGB triplet as a three-element row vector containing the intensities of the red, green, and blue components of the color. The intensities must be in the range `[0,1]`, for example, `[0.4 0.6 0.7]`. This table lists the RGB triplet values that specify the default colors for different lane types.

Lane Type	RGB Triplet (Default values)	Appearance
'Driving'	[0.8 0.8 0.8]	
'Border'	[0.72 0.72 0.72]	
'Restricted'	[0.59 0.56 0.62]	
'Shoulder'	[0.59 0.59 0.59]	
'Parking'	[0.28 0.28 0.28]	

Alternatively, you can specify some common colors by name. This table lists the named color options and the equivalent RGB triplet values.

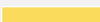
Color Name	RGB Triplet	Appearance
'red'	[1 0 0]	
'green'	[0 1 0]	
'blue'	[0 0 1]	
'cyan'	[0 1 1]	

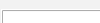
Color Name	RGB Triplet	Appearance
'magenta'	[1 0 1]	
'yellow'	[0.98 0.86 0.36]	
'black'	[0 0 0]	
'white'	[1 1 1]	

Note Use the lane color name-value pair to set the `Color` property of the output lane type object.

Data Types: `single` | `double` | `int8` | `int16` | `int32` | `int64` | `uint8` | `uint16` | `uint32` | `uint64` | `char` | `string`

Strength — Strength of lane color

1 (default) | real scalar in the range [0, 1]

Strength of lane color, specified as a comma-separated pair consisting of 'Strength' and a real scalar in the range [0, 1]. A value of 0 desaturates the color and the lane color appears gray. A value of 1 fully saturates the color and the lane color is the pure color. You can vary the strength value to modify the level of saturation.

Note Use the strength of lane color name-value pair to set the `Strength` property of the lane type object.

Data Types: `single` | `double` | `int8` | `int16` | `int32` | `int64` | `uint8` | `uint16` | `uint32` | `uint64`

Output Arguments

lt — Lane type

`DrivingLaneType` object | `BorderLaneType` object | `RestrictedLaneType` object | `ShoulderLaneType` object | `ParkingLaneType` object

Lane type, returned as a

- `DrivingLaneType` object
- `BorderLaneType` object
- `RestrictedLaneType` object
- `ShoulderLaneType` object
- `ParkingLaneType` object

The returned object `lt` depends on the value of the input type.

type	lt
'Driving'	<code>DrivingLaneType</code> object
'Border'	<code>BorderLaneType</code> object
'Restricted'	<code>RestrictedLaneType</code> object
'Shoulder'	<code>ShoulderLaneType</code> object

'Parking'	ParkingLaneType object
-----------	------------------------

You can create a heterogeneous LaneType array by concatenating these different lane type objects.

More About

Create Driving Scenario With Roads That Have Multiple Lane Types

You can add roads that have multiple lane types to the driving scenario by following these steps

- 1 Create an empty `drivingScenario` object.
- 2 Create a lane type object that defines different lane types on the road by using `laneType`.
- 3 Use lane type object as input to the `lanespec` object and define lane specifications for the road.
- 4 Use `lanespec` object as input to the `road` function and add roads that have the specified lane types to the driving scenario.

You can use the `plot` function to visualize the driving scenario.

You can also import a driving scenario containing roads that have different lane types into the **Driving Scenario Designer** app. To import a `drivingScenario` object named `scenario` into the app, use the syntax `drivingScenarioDesigner(scenario)`. In the scenarios, you can:

- Add or edit the road centers.
- Add actors and define actor trajectories.
- Mount sensors on the ego vehicle and simulate detection of actors and lane boundaries.

Note Editing the lane parameters resets all the lanes in the imported road to lane type 'Driving' with the default property values.

Version History

Introduced in R2019b

See Also

Functions

`roadNetwork` | `road`

Objects

`drivingScenario` | `lanespec` | `compositeLaneSpec`

RoadGroup

Store specifications for road junction or intersection

Description

The RoadGroup object stores the specifications of road segments that combine to form a road junction or intersection.

Creation

To create a RoadGroup object, use the `driving.scenario.RoadGroup` creation function. Then, create a road junction or intersection by following these steps:

- 1 Define the road segments and add them to the RoadGroup object by using the `road` function.
- 2 Combine the road segments to form a junction or intersection and add it to a driving scenario by using the `roadGroup` function.

```
rg = driving.scenario.RoadGroup
rg = driving.scenario.RoadGroup('Name', name)
```

Description

`rg = driving.scenario.RoadGroup` creates a RoadGroup object with properties `Name` and `Roads`.

`rg = driving.scenario.RoadGroup('Name', name)` additionally specifies the name, `name` for the road junction, where `name` is a character vector or string scalar. `name` sets the `Name` property.

Properties

Name — Name of road junction or intersection

' ' (default) | string scalar

This property is read-only.

Name of the road junction or intersection, stored as a string scalar. The `name` argument sets this property value.

Example: `driving.scenario.RoadGroup('Name', 'junction1')` creates a RoadGroup object with a `Name` property of "junction1".

Data Types: `string`

Roads — Specifications of road segments

cell array of structures

This property is read-only.

Specifications of road segments in the road group, stored as a cell array of structures. Each structure contains these fields, and their values are set by the road function:

Field	Value
Width	A positive real scalar specifying the width of the road. Units are in meters.
Lanes	A <code>lanespec</code> object specifying the properties of lanes in the road.
Name	A string scalar specifying the name of the road.
Centers	An N -by-2 or N -by-3 matrix of real values specifying the centers in the road. N is the number of centers in the road.
BankAngle	An N -element vector of real values specifying the banking values for the road. N is the number of centers in the road.

Data Types: `struct`

Examples

Create Road Network with Three-Way Intersection

A three-way intersection is a Y-Junction in which two adjacent roads intersect the third road at an obtuse angle, as shown in this figure. To connect the three roads, you will create a Y-Junction by adding three road segments.

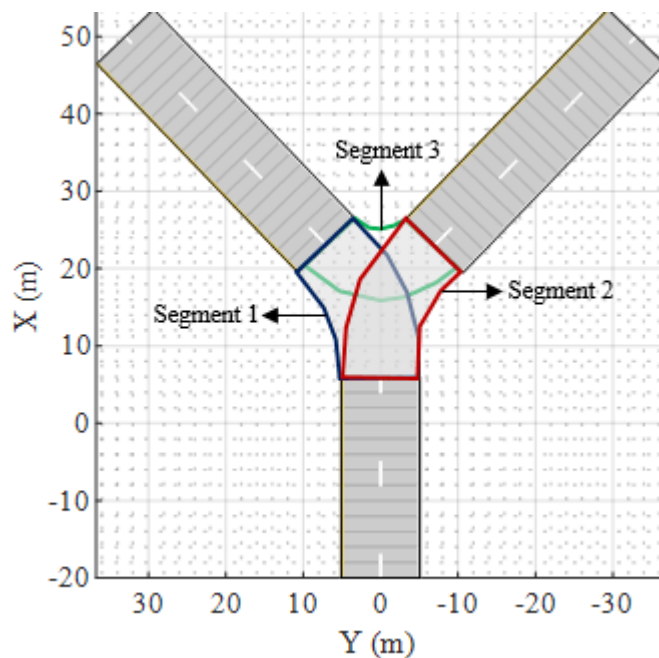

Add Three Roads to Driving Scenario

Create an empty driving scenario.

```
scenario = drivingScenario;
```

Specify the number of lanes and the width of each lane in the roads.

```
ls = lanespec(2,'Width',5);
```

Define the road centers for three roads and add them to the driving scenario. The first road is diagonally oriented to the left of the scenario canvas, second road is diagonally oriented to the right of the scenario canvas, and the third road is oriented vertically.

```
% Add the first road
```

```
roadCenters = [-20 0; 6 0];
```

```
road(scenario,roadCenters,'Name','Road 1','Lanes',ls);
```

```
% Add the second road
```

```
roadCenters = [23 7; 50 33];
```

```
road(scenario,roadCenters,'Name','Road 2','Lanes',ls);
```

```
% Add the third road
```

```
roadCenters = [23 -7; 50 -33];
```

```
road(scenario,roadCenters,'Name','Road 3','Lanes',ls);
```

Plot the scenario.

```
figure  
plot(scenario)
```

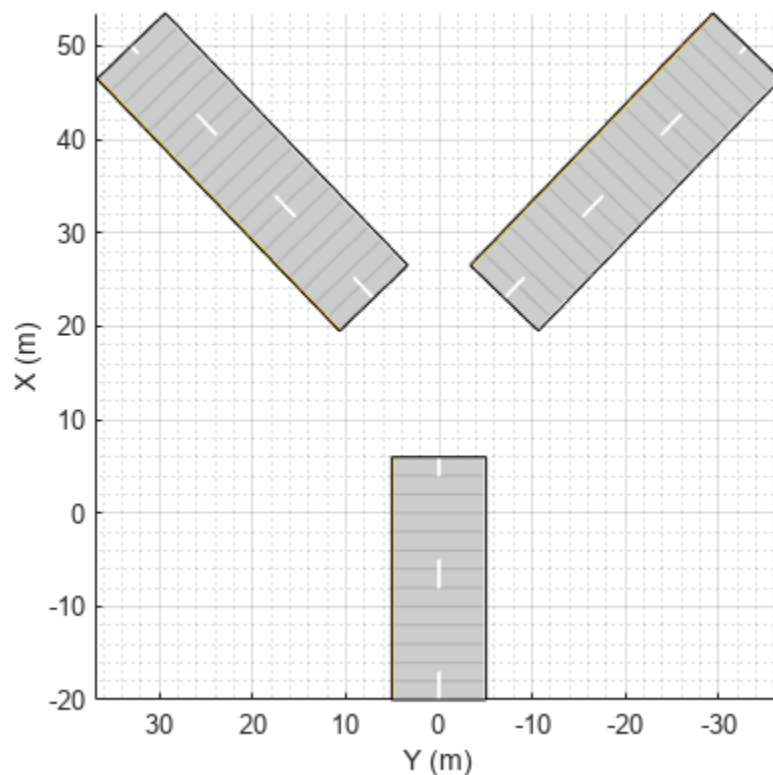

Create Y-Junction to Connect Roads

Create a RoadGroup object. Specify the width for each road segment that forms the Y-junction.

```
rg = driving.scenario.RoadGroup('Name', 'Y-Junction');  
roadWidth = 10;
```

Specify the road centers for three road segments, and add these road segments to the RoadGroup object by using the road function. These road segments intersect with each other.

```
% Add the first road segment  
roadCenters = [23 7; 14 1; 6 0];  
road(rg, roadCenters, roadWidth, 'Name', 'Segment 1');
```

```
% Add the second road segment  
roadCenters = [23 -7; 14 -1; 6 0];  
road(rg, roadCenters, roadWidth, 'Name', 'Segment 2');
```

```
% Add the third road segment  
roadCenters = [23 7; 21 4; 21 -4; 23 -7];  
road(rg, roadCenters, roadWidth, 'Name', 'Segment 3');
```

Add Y-Junction to Driving Scenario

Add the road segments stored in the RoadGroup object to the driving scenario by using the roadGroup function. The road segments form a Y-junction that connects the three roads in the driving scenario.

```
roadGroup(scenario, rg);
```

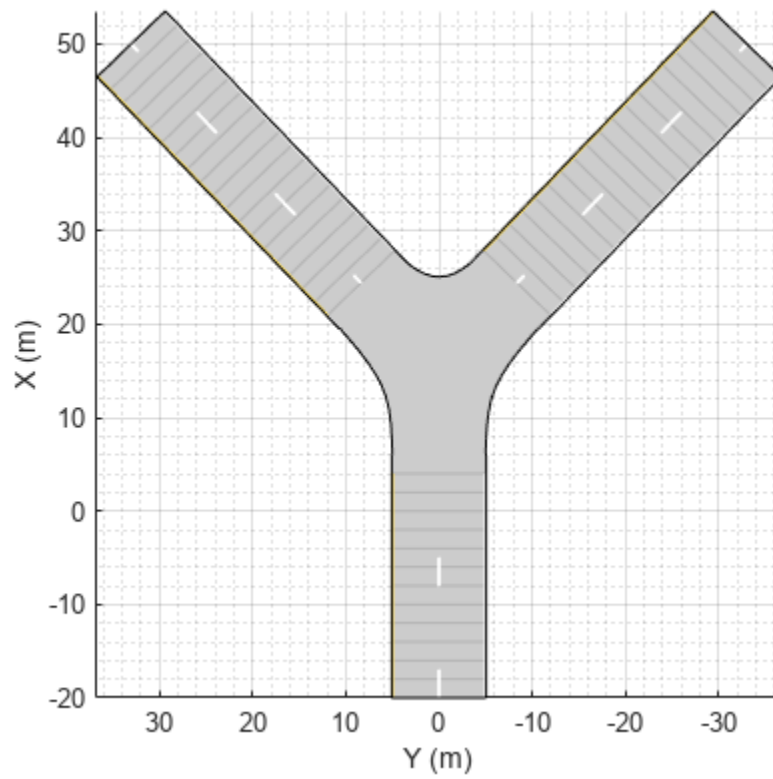
Version History

Introduced in R2021a

See Also

Objects

`drivingScenario` | `lanespec`

Functions

`road` | `roadGroup` | `actor` | `vehicle`

laneMarkingVertices

Package:

Lane marking vertices and faces in driving scenario

Syntax

```
[lmv,lmf] = laneMarkingVertices(scenario)
[lmv,lmf] = laneMarkingVertices(ac)
```

Description

`[lmv,lmf] = laneMarkingVertices(scenario)` returns the lane marking vertices, `lmv`, and lane marking faces, `lmf`, contained in driving scenario `scenario`. The `lmf` and `lmv` outputs are in the world coordinates of `scenario`. Use lane marking vertices and faces to display lane markings using the `laneMarkingPlotter` function with a bird's-eye plot.

`[lmv,lmf] = laneMarkingVertices(ac)` returns lane marking vertices and faces in the coordinates of driving scenario actor `ac`.

Examples

Display Lane Markings in Car and Pedestrian Scenario

Create a driving scenario containing a car and pedestrian on a straight road. Then, create and display the lane markings of the road on a bird's-eye plot.

Create an empty driving scenario.

```
scenario = drivingScenario;
```

Create a straight, 25-meter road segment with two travel lanes in one direction.

```
lm = [laneMarking('Solid')
      laneMarking('Dashed','Length',2,'Space',4)
      laneMarking('Solid')];
l = lanespec(2,'Marking',lm);
road(scenario,[0 0 0; 25 0 0],'Lanes',l);
```

Add to the driving scenario a pedestrian crossing the road at 1 meter per second and a car following the road at 10 meters per second.

```
ped = actor(scenario,'ClassID',4,'Length',0.2,'Width',0.4,'Height',1.7);
car = vehicle(scenario,'ClassID',1);
smoothTrajectory(ped,[15 -3 0; 15 3 0],1);
smoothTrajectory(car,[car.RearOverhang 0 0; 25-car.Length+car.RearOverhang 0 0],10);
```

Display the scenario and corresponding chase plot.

```
plot(scenario)
```

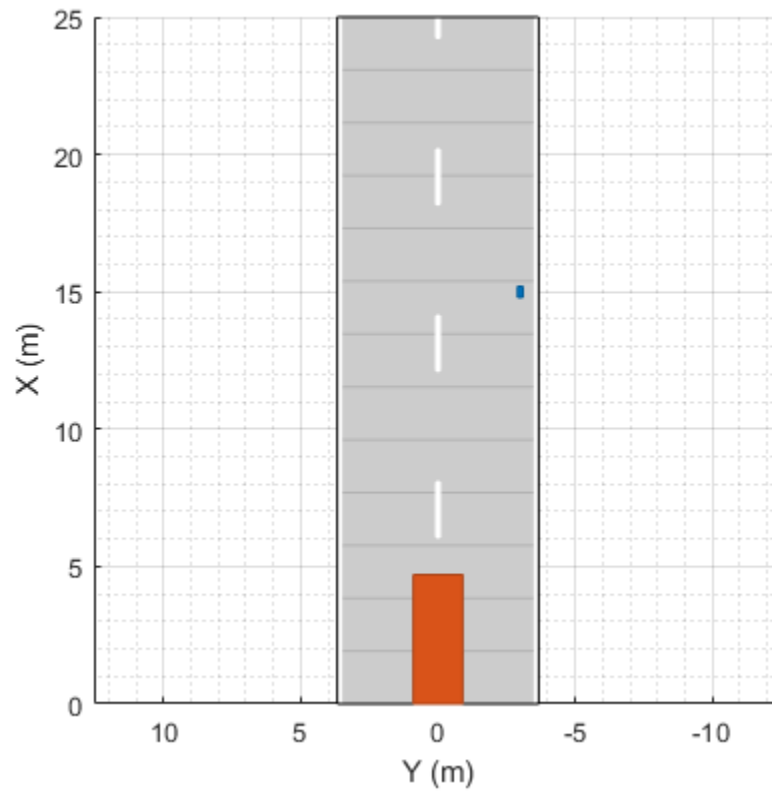

chasePlot(car)

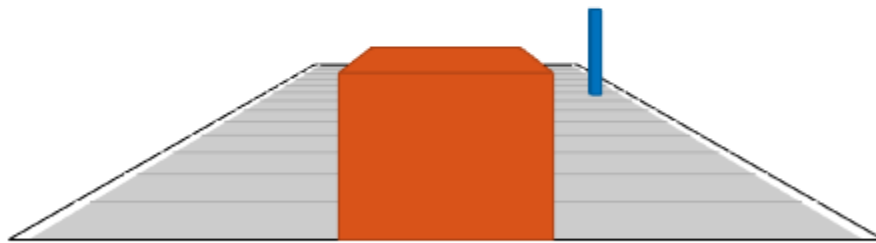

Run the simulation.

- 1 Create a bird's-eye plot.
- 2 Create an outline plotter, lane boundary plotter, and lane marking plotter for the bird's-eye plot.
- 3 Obtain the road boundaries and target outlines.
- 4 Obtain the lane marking vertices and faces.
- 5 Display the lane boundaries and lane markers.
- 6 Run the simulation loop.

```
bep = birdsEyePlot('XLim',[-25 25], 'YLim',[-10 10]);
olPlotter = outlinePlotter(bep);
lbPlotter = laneBoundaryPlotter(bep);
lmPlotter = laneMarkingPlotter(bep, 'DisplayName', 'Lanes');
legend('off');
while advance(scenario)
    rb = roadBoundaries(car);
    [position,yaw,length,width,originOffset,color] = targetOutlines(car);
    [lmv,lmf] = laneMarkingVertices(car);
    plotLaneBoundary(lbPlotter,rb);
    plotLaneMarking(lmPlotter,lmv,lmf);
    plotOutline(olPlotter,position,yaw,length,width, ...
        'OriginOffset',originOffset,'Color',color);
end
```

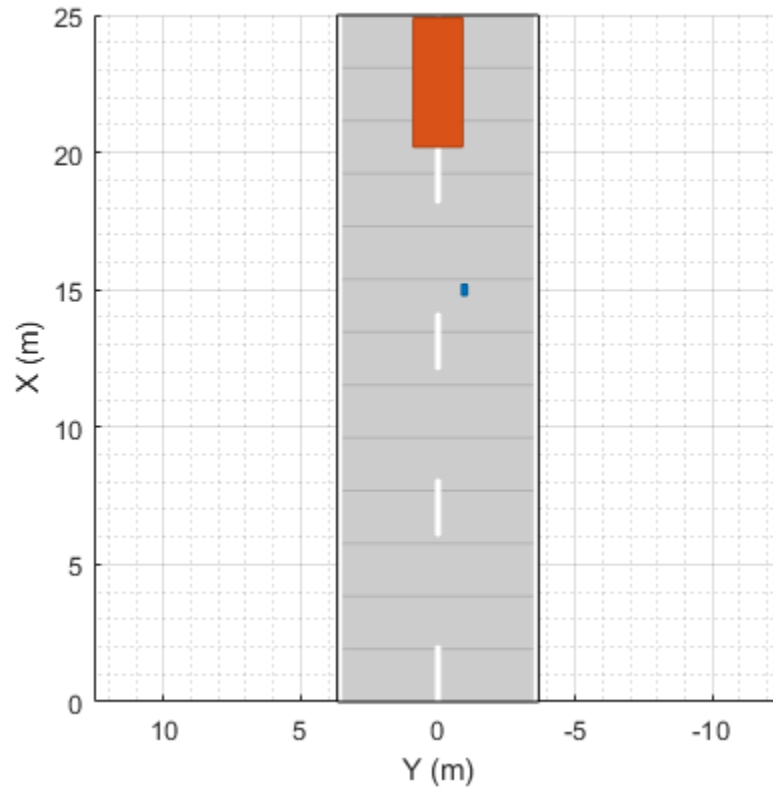

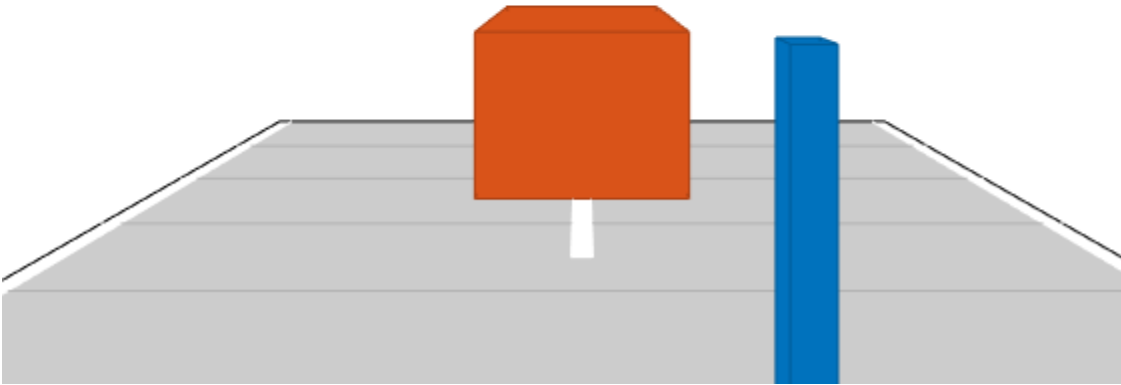

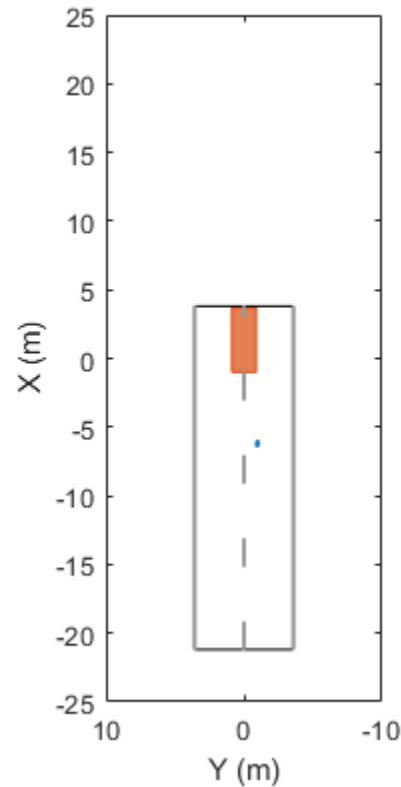

Input Arguments

scenario – Driving scenario

`drivingScenario` object

Driving scenario, specified as a `drivingScenario` object.

ac – Actor

Actor object | Vehicle object

Actor belonging to a `drivingScenario` object, specified as an Actor or Vehicle object. To create these objects, use the `actor` and `vehicle` functions, respectively.

Output Arguments

lmv – Lane marking vertices

real-valued matrix

Lane marking vertices, returned as a real-valued matrix. Each row of the matrix represents the (x, y, z) coordinates of a vertex.

lmf – Lane marking faces

integer-valued matrix

Lane marking faces, returned as a integer-valued matrix. Each row of the matrix contains the vertex connections that define a face for one lane marking. For more details, see “Faces”.

Algorithms

This function uses the `patch` function to define lane marking vertices and faces.

Version History

Introduced in R2018a

See Also

Objects

`drivingScenario`

Functions

`actor` | `laneMarkingPlotter` | `vehicle` | `patch` | `road` | `plotLaneMarking` | `laneMarking` | `parkingLaneMarkingVertices`

parkingLaneMarkingVertices

Package:

Parking lane marking vertices and faces in driving scenario

Syntax

```
[plmv,plmf] = parkingLaneMarkingVertices(scenario)
[plmv,plmf] = parkingLaneMarkingVertices(ac)
```

Description

`[plmv,plmf] = parkingLaneMarkingVertices(scenario)` returns the parking lane marking vertices `plmv` and parking lane marking faces `plmf` contained in driving scenario `scenario`. The `plmf` and `plmv` outputs are in the world coordinates of `scenario`. Use parking lane marking vertices and faces to display lane markings using the `laneMarkingPlotter` function with a bird's-eye plot.

`[plmv,plmf] = parkingLaneMarkingVertices(ac)` returns all lane marking vertices and faces contained in the driving scenario in the coordinates of actor `ac`.

Examples

Generate Detections of Cars in Parking Lot

Generate detections of cars parked in a parking lot, and plot the detections on a bird's-eye plot.

Create a driving scenario containing a road and parking lot.

```
scenario = drivingScenario;
roadcenters = [10 40; 10 -40];
road(scenario,roadcenters);
vertices = [0 20; 20 20; 20 -20; 0 -20];
parkingLot(scenario,vertices,ParkingSpace=parkingSpace);
```

Add an ego vehicle and specify a trajectory in which the vehicle drives through the parking lot.

```
ego = vehicle(scenario);
waypoints = [10 35 0; 10 10 0];
speed = 5; % m/s
smoothTrajectory(ego,waypoints,speed)
```

Create parked cars in several parking spaces. Plot the scenario.

```
parkedCar1 = vehicle(scenario,Position=[15.8 12.4 0]);
parkedCar2 = vehicle(scenario,Position=[15.8 -12.4 0]);
parkedCar3 = vehicle(scenario,Position=[2 -9.7 0]);
parkedCar4 = vehicle(scenario,Position=[2 9.7 0]);
plot(scenario)
```

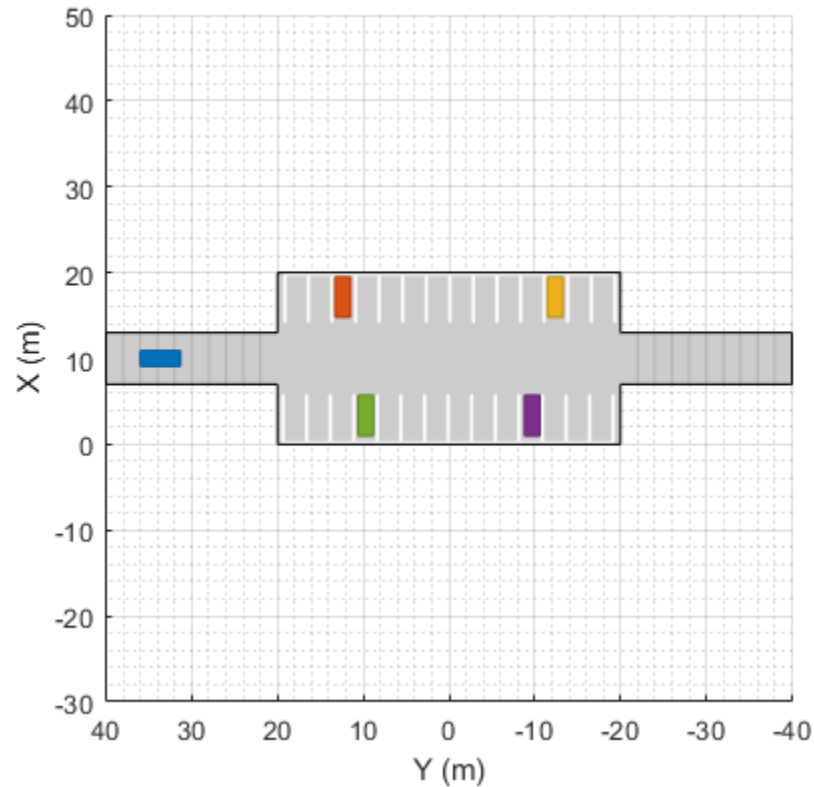

Create a vision sensor for generating the detections. By default, the sensor is mounted to the front bumper of the ego vehicle.

```
sensor = visionDetectionGenerator;
```

Create a bird's-eye plot and plotters for visualizing the target outlines, road boundaries, parking lane markings, sensor coverage area, and detections. Then, simulate the scenario and generate the detections.

```
bep = birdsEyePlot(XLim=[-40 40],YLim=[-30 30]);
olPlotter = outlinePlotter(bep);
lbPlotter = laneBoundaryPlotter(bep);
lmPlotter = laneMarkingPlotter(bep,DisplayName="Parking lanes");
caPlotter = coverageAreaPlotter(bep,DisplayName="Coverage area");
detPlotter = detectionPlotter(bep,DisplayName="Detections");

while advance(scenario)

    % Plot target outlines.
    [position,yaw,length,width,originOffset,color] = targetOutlines(ego);
    plotOutline(olPlotter,position,yaw,length,width)

    % Plot lane boundaries of ego vehicle.
    rbEgo = roadBoundaries(ego);
    plotLaneBoundary(lbPlotter,rbEgo)

    % Plot parking lane markings.
```

```

[plmv,plmf] = parkingLaneMarkingVertices(ego);
plotParkingLaneMarking(lmPlotter,plmv,plmf)

% Plot sensor coverage area.
mountPosition = sensor.SensorLocation;
range = sensor.MaxRange;
orientation = sensor.Yaw;
fieldOfView = sensor.FieldOfView(1);
plotCoverageArea(caPlotter,mountPosition,range,orientation,fieldOfView)

% Generate and plot detections.
actors = targetPoses(ego);
time = scenario.SimulationTime;
[dets,isValidTime] = sensor(actors,time);
if isValidTime
    positions = cell2mat(cellfun(@(x)([x.Measurement(1) x.Measurement(2)]), ...
        dets,UniformOutput=false));
    plotDetection(detPlotter,positions)
end
end

```

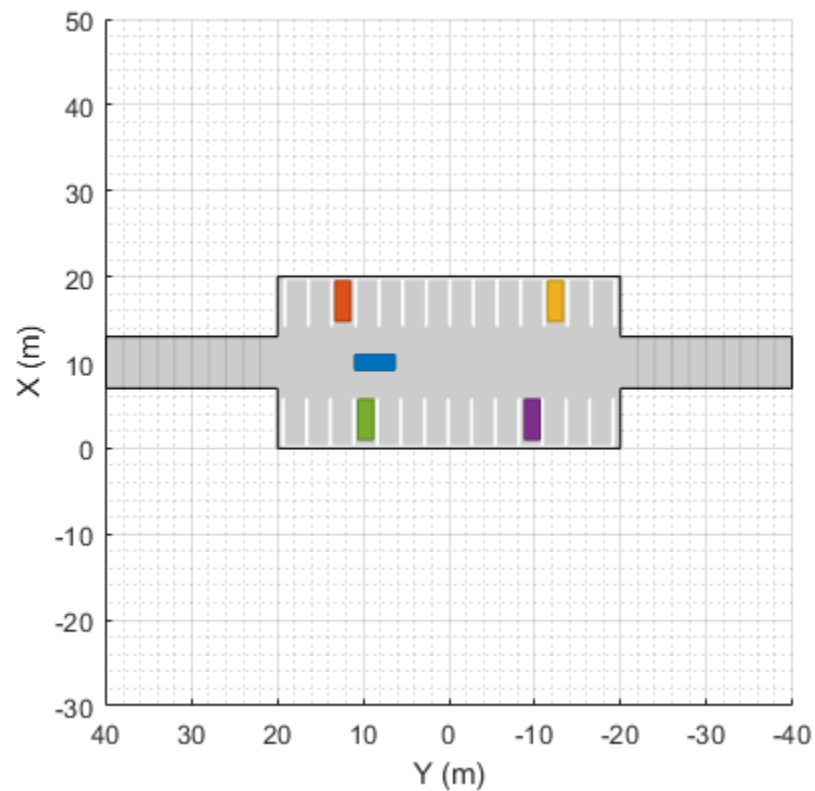

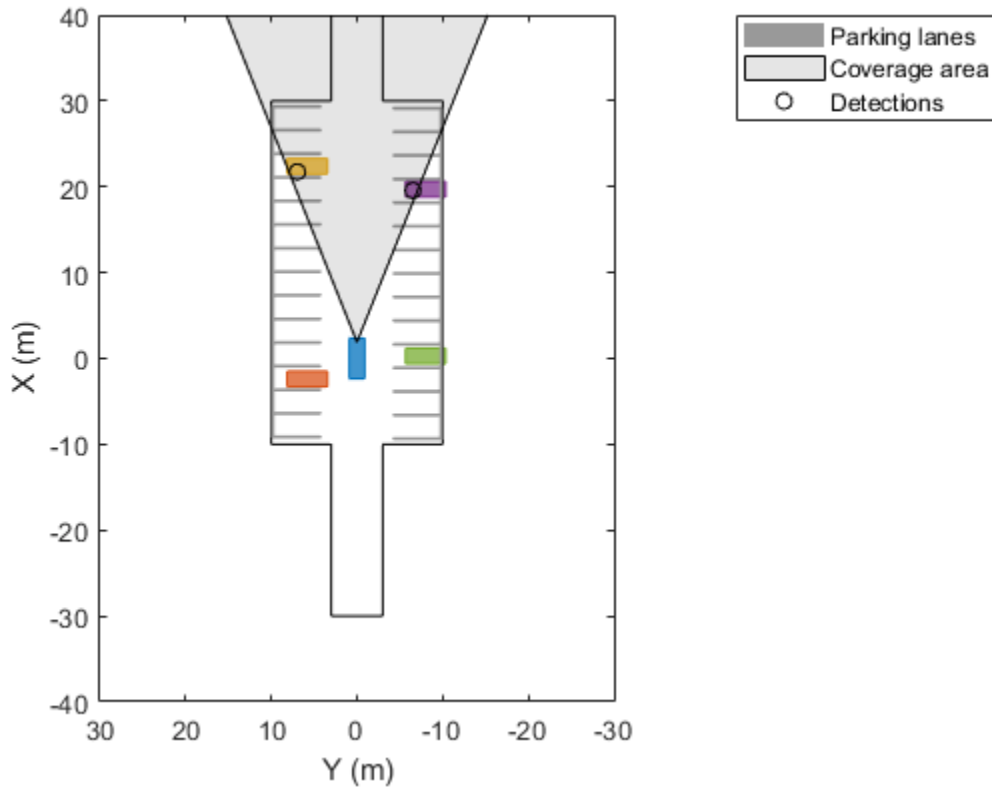

Input Arguments

scenario – Driving scenario

`drivingScenario` object

Driving scenario, specified as a `drivingScenario` object.

ac – Actor

Actor object | Vehicle object

Actor belonging to a `drivingScenario` object, specified as an Actor or Vehicle object. To create these objects, use the `actor` and `vehicle` functions, respectively.

Output Arguments

p_{lmv} – Parking lane marking vertices

V -by-3 real-valued matrix

Parking lane marking vertices, returned as a V -by-3 real-valued matrix. Each row of the matrix represents the (x, y, z) coordinates of a vertex. V is the number of vertices in the marking.

p_{lmf} – Parking lane marking faces

matrix of integers

Parking lane marking faces, returned as a matrix of integers. Each row of the matrix contains the vertex connections that define a face for one lane marking. For more details, see “Faces”.

Algorithms

This function uses the `patch` function to define lane marking vertices and faces.

Version History

Introduced in R2021b

See Also

Objects

`drivingScenario` | `birdsEyePlot`

Functions

`patch` | `parkingLot` | `plotParkingLaneMarking`

Topics

“Simulate Vehicle Parking Maneuver in Driving Scenario”

laneBoundaries

Package:

Get lane boundaries of actor lane

Syntax

```
lbdry = laneBoundaries(ac)
lbdry = laneBoundaries(ac,Name,Value)
```

Description

`lbdry = laneBoundaries(ac)` returns the lane boundaries, `lbdry`, of the lane in which the ego vehicle actor, `ac`, is traveling. The lane boundaries are in the coordinate system of the ego vehicle.

`lbdry = laneBoundaries(ac,Name,Value)` specifies options using one or more name-value pairs. For example, `laneBoundaries(ac,'AllLaneBoundaries',true)` returns all lane boundaries of the road on which the ego vehicle actor is traveling.

Examples

Simulate Car Traveling on S-Curve

Simulate a driving scenario with one car traveling on an S-curve. Create and plot the lane boundaries.

Create the driving scenario with one road having an S-curve.

```
scenario = drivingScenario('StopTime',3);
roadcenters = [-35 20 0; -20 -20 0; 0 0 0; 20 20 0; 35 -20 0];
```

Create the lanes and add them to the road.

```
lm = [laneMarking('Solid','Color','w'); ...
      laneMarking('Dashed','Color','y'); ...
      laneMarking('Dashed','Color','y'); ...
      laneMarking('Solid','Color','w')];
ls = lanespec(3,'Marking',lm);
road(scenario,roadcenters,'Lanes',ls);
```

Add an ego vehicle and specify its trajectory from its waypoints. By default, the car travels at a speed of 30 meters per second.

```
car = vehicle(scenario, ...
             'ClassID',1, ...
             'Position',[-35 20 0]);
waypoints = [-35 20 0; -20 -20 0; 0 0 0; 20 20 0; 35 -20 0];
smoothTrajectory(car,waypoints);
```

Plot the scenario and corresponding chase plot.

```
plot(scenario)
```

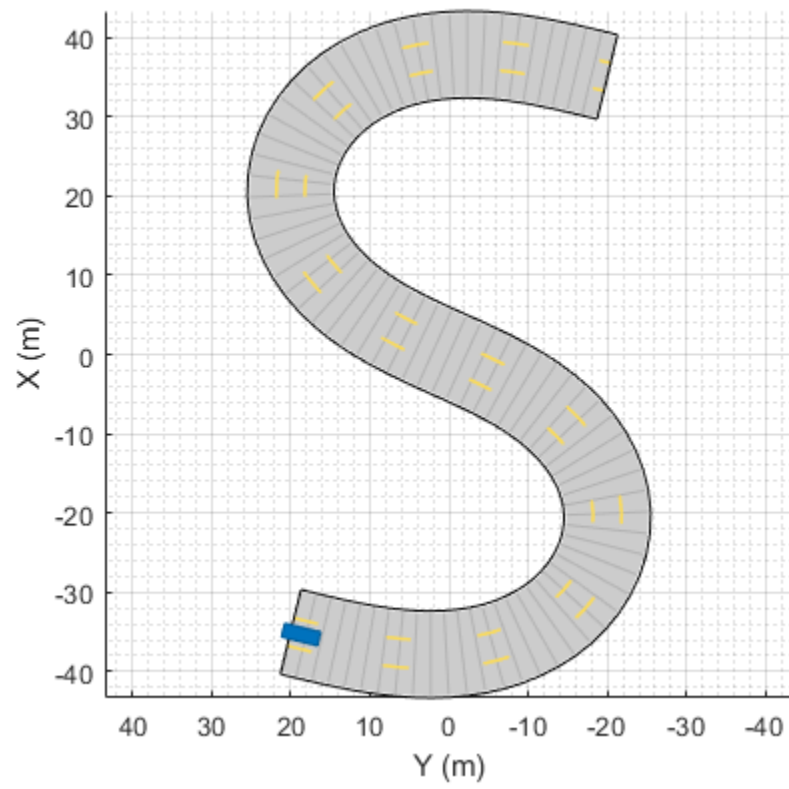

```
chasePlot(car)
```



Run the simulation loop.

- 1 Initialize a bird's-eye plot and create an outline plotter, left-lane and right-lane boundary plotters, and a road boundary plotter.
- 2 Obtain the road boundaries and rectangular outlines.
- 3 Obtain the lane boundaries to the left and right of the vehicle.
- 4 Advance the simulation and update the plotters.

```

bep = birdsEyePlot('XLim',[-40 40], 'YLim',[-30 30]);
olPlotter = outlinePlotter(bep);
lblPlotter = laneBoundaryPlotter(bep, 'Color', 'r', 'LineStyle', '-');
lbrPlotter = laneBoundaryPlotter(bep, 'Color', 'g', 'LineStyle', '-');
rbsEdgePlotter = laneBoundaryPlotter(bep);
legend('off');
while advance(scenario)
    rbs = roadBoundaries(car);
    [position, yaw, length, width, originOffset, color] = targetOutlines(car);
    lb = laneBoundaries(car, 'XDistance', 0:5:30, 'LocationType', 'Center', ...
        'AllBoundaries', false);
    plotLaneBoundary(rbsEdgePlotter, rbs)
    plotLaneBoundary(lblPlotter, {lb(1).Coordinates})
    plotLaneBoundary(lbrPlotter, {lb(2).Coordinates})
    plotOutline(olPlotter, position, yaw, length, width, ...
        'OriginOffset', originOffset, 'Color', color)
end

```

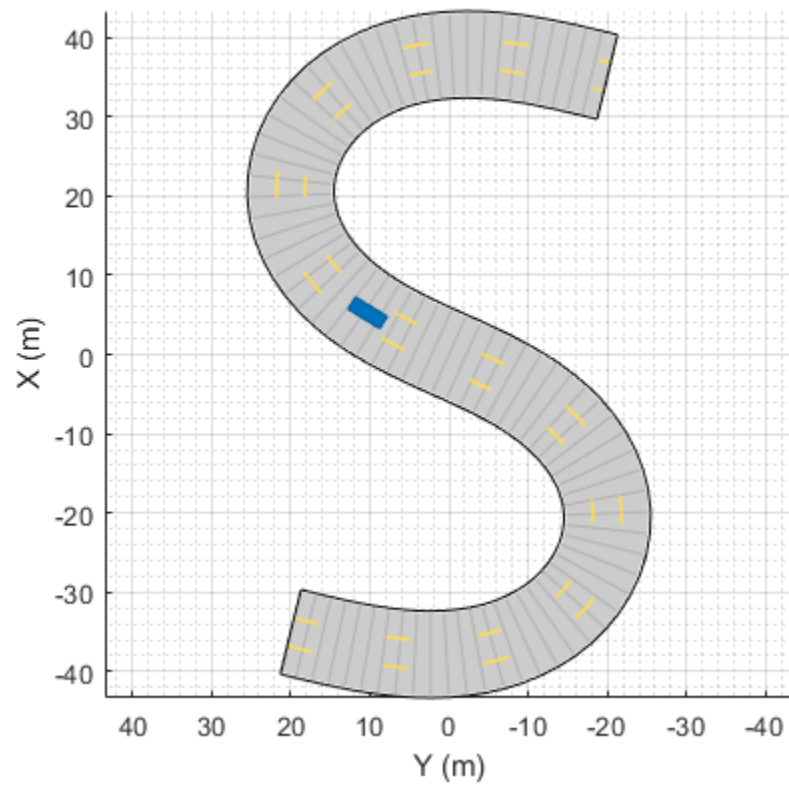

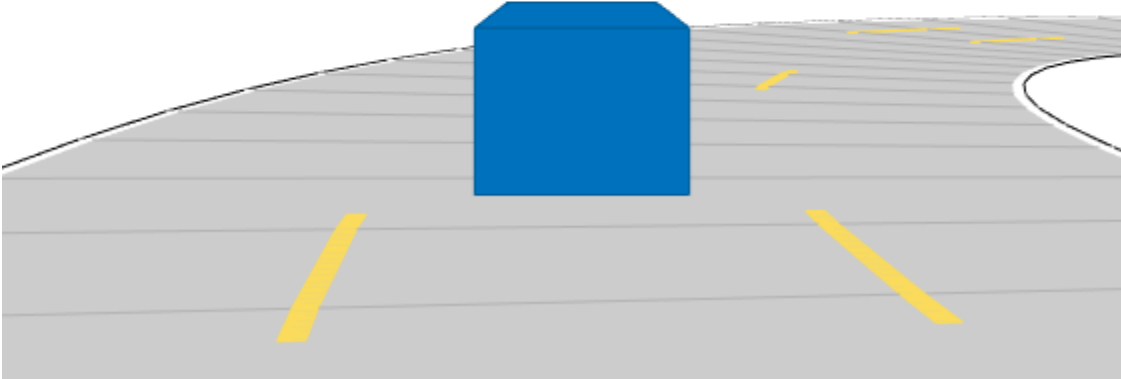

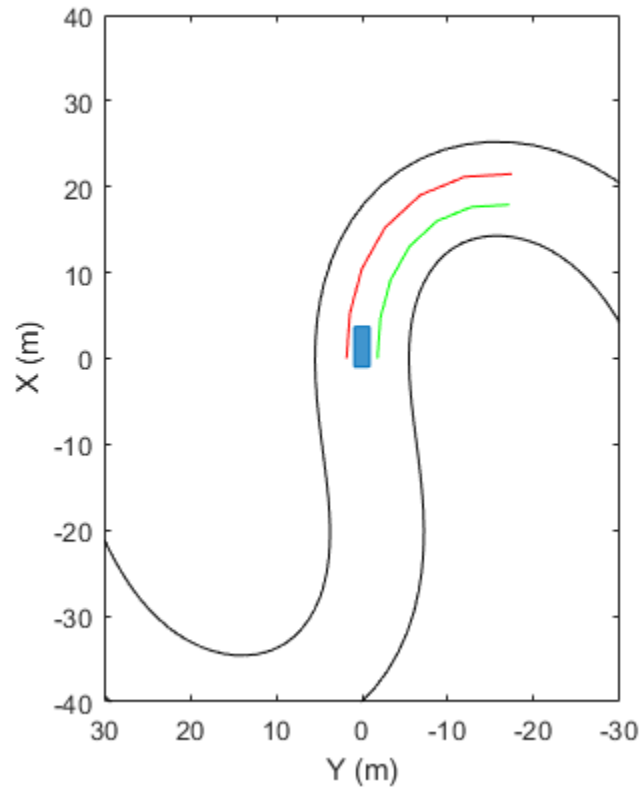
Input Arguments

ac — Actor

Actor object | Vehicle object

Actor belonging to a `drivingScenario` object, specified as an `Actor` or `Vehicle` object. To create these objects, use the `actor` and `vehicle` functions, respectively.

Name-Value Pair Arguments

Specify optional pairs of arguments as `Name1=Value1, ..., NameN=ValueN`, where `Name` is the argument name and `Value` is the corresponding value. Name-value arguments must appear after other arguments, but the order of the pairs does not matter.

Before R2021a, use commas to separate each name and value, and enclose Name in quotes.

Example: `'LocationType', 'center'` specifies that lane boundaries are centered on the lane markings.

XDistance — Distances from ego vehicle at which to compute lane boundaries

0 (default) | N-element real-valued vector

Distances from the ego vehicle at which to compute the lane boundaries, specified as the comma-separated pair consisting of `'XDistance'` and an `N`-element real-valued vector. `N` is the number of distance values. When detecting lanes from rear-facing cameras, specify negative distances. When detecting lanes from front-facing cameras, specify positive distances. Units are in meters.

By default, the function computes the lane boundaries at a distance of 0 from the ego vehicle, which are the boundaries to the left and right of the ego-vehicle origin.

Example: `1:0.1:10` computes a lane boundary every 0.1 meters over the range from 1 to 10 meters ahead of the ego vehicle.

Example: `linspace(-150,150,101)` computes 101 lane boundaries over the range from 150 meters behind the ego vehicle to 150 meters ahead of the ego vehicle. These distances are linearly spaced 3 meters apart.

LocationType — Lane boundary location

'Center' (default) | 'Inner'

Lane boundary location on the lane markings, specified as the comma-separated pair consisting of 'LocationType' and one of the options in this table.

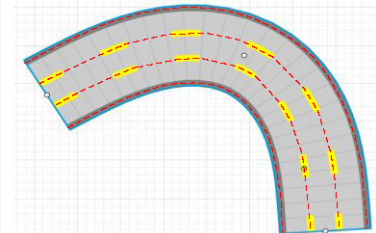
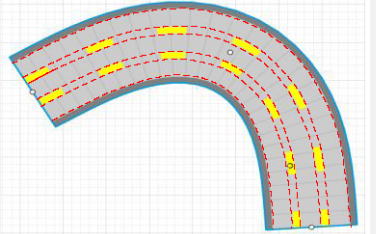
Lane Boundary Location	Description	Example
'Center'	Lane boundaries are centered on the lane markings.	A three-lane road has four lane boundaries: one per lane marking. 
'Inner'	Lane boundaries are placed at the inner edges of the lane markings.	A three-lane road has six lane boundaries: two per lane. 

AllBoundaries — Return all lane boundaries on road

false (default) | true

Return all lane boundaries on which the ego vehicle is traveling, specified as the comma-separated pair consisting of 'Value' and false or true.

Lane boundaries are returned from left to right relative to the ego vehicle. When 'AllBoundaries' is false, only the lane boundaries to the left and right of the ego vehicle are returned.

Output Arguments

lbdry — Lane boundaries

array of lane boundary structures

Lane boundaries, returned as an array of lane boundary structures. This table shows the fields for each structure.

Field	Description
Coordinates	<p>Lane boundary coordinates, specified as a real-valued N-by-3 matrix, where N is the number of lane boundary coordinates. Lane boundary coordinates define the position of points on the boundary at specified longitudinal distances away from the ego vehicle, along the center of the road.</p> <ul style="list-style-type: none"> • In MATLAB, specify these distances by using the 'XDistance' name-value pair argument of the laneBoundaries function. • In Simulink, specify these distances by using the Distances from ego vehicle for computing boundaries (m) parameter of the Scenario Reader block or the Distance from parent for computing lane boundaries parameter of the Simulation 3D Vision Detection Generator block. <p>This matrix also includes the boundary coordinates at zero distance from the ego vehicle. These coordinates are to the left and right of the ego-vehicle origin, which is located under the center of the rear axle. Units are in meters.</p>
Curvature	<p>Lane boundary curvature at each row of the Coordinates matrix, specified as a real-valued N-by-1 vector. N is the number of lane boundary coordinates. Units are in radians per meter.</p>
CurvatureDerivative	<p>Derivative of lane boundary curvature at each row of the Coordinates matrix, specified as a real-valued N-by-1 vector. N is the number of lane boundary coordinates. Units are in radians per square meter.</p>
HeadingAngle	<p>Initial lane boundary heading angle, specified as a real scalar. The heading angle of the lane boundary is relative to the ego vehicle heading. Units are in degrees.</p>

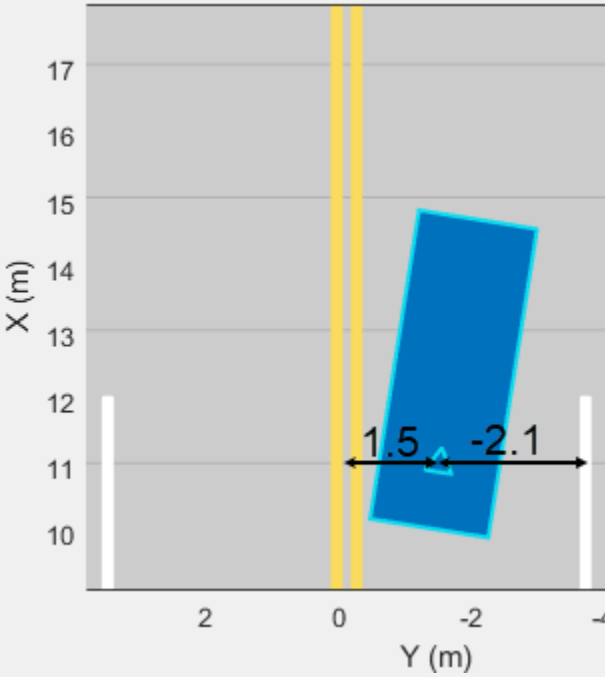
LateralOffset	<p>Lateral offset of the ego vehicle position from the lane boundary, specified as a real scalar. An offset to a lane boundary to the left of the ego vehicle is positive. An offset to the right of the ego vehicle is negative. Units are in meters. In this image, the ego vehicle is offset 1.5 meters from the left lane and 2.1 meters from the right lane.</p> 
BoundaryType	<p>Type of lane boundary marking, specified as one of these values:</p> <ul style="list-style-type: none"> • 'Unmarked' — No physical lane marker exists • 'Solid' — Single unbroken line • 'Dashed' — Single line of dashed lane markers • 'DoubleSolid' — Two unbroken lines • 'DoubleDashed' — Two dashed lines • 'SolidDashed' — Solid line on the left and a dashed line on the right • 'DashedSolid' — Dashed line on the left and a solid line on the right

Strength	Saturation strength of the lane boundary marking, specified as a real scalar from 0 to 1. A value of 0 corresponds to a marking whose color is fully unsaturated. The marking is gray. A value of 1 corresponds to a marking whose color is fully saturated.
Width	Lane boundary width, specified as a positive real scalar. In a double-line lane marker, the same width is used for both lines and for the space between lines. Units are in meters.
Length	Length of dash in dashed lines, specified as a positive real scalar. In a double-line lane marker, the same length is used for both lines.
Space	Length of space between dashes in dashed lines, specified as a positive real scalar. In a dashed double-line lane marker, the same space is used for both lines.

Version History

Introduced in R2018a

See Also

Objects

drivingScenario | lanespec

Functions

plotLaneBoundary | laneBoundaryPlotter | laneMarkingPlotter | laneMarking | plotLaneMarking | road

clothoidLaneBoundary

Clothoid-shaped lane boundary model

Description

A `clothoidLaneBoundary` object contains information about a clothoid-shaped lane boundary model. A clothoid is a type of curve whose rate of change of curvature varies linearly with distance.

Creation

Syntax

```
bdry = clothoidLaneBoundary  
bdry = clothoidLaneBoundary(Name, Value)
```

Description

`bdry = clothoidLaneBoundary` creates a clothoid lane boundary model, `bdry` with default property values.

`bdry = clothoidLaneBoundary(Name, Value)` sets properties using one or more name-value pairs. For example, `clothoidLaneBoundary('BoundaryType', 'Solid')` creates a clothoid lane boundary model with solid lane boundaries. Enclose each property name in quotes.

Properties

Curvature — Lane boundary curvature

0 (default) | real scalar

Lane boundary curvature, specified as a real scalar. This property represents the rate of change of lane boundary direction with respect to distance. Units are in degrees per meter.

Example: `-1.0`

Data Types: `single` | `double`

CurvatureDerivative — Derivative of lane boundary curvature

0 (default) | real scalar

Derivative of lane boundary curvature, specified as a real scalar. This property represents the rate of change of lane curvature with respect to distance. Units are in degrees per meter squared.

Example: `-0.01`

Data Types: `single` | `double`

CurveLength — Length of lane boundary along road

0 (default) | nonnegative real scalar

Length of the lane boundary along the road, specified as a nonnegative real scalar. Units are in meters.

Example: 25

Data Types: single | double

HeadingAngle — Initial lane boundary heading

θ (default) | real scalar

Initial lane boundary heading, specified as a real scalar. The heading angle of the lane boundary is relative to the heading of the ego vehicle. Units are in degrees.

Example: 10

Data Types: single | double

LateralOffset — Lateral offset of ego vehicle position from lane boundary

θ (default) | real scalar

Lateral offset of the ego vehicle position from the lane boundary, specified as a real scalar. An offset to a lane boundary to the left of the ego vehicle is positive. An offset to the right of the ego vehicle is negative. Units are in meters. In this image, the ego vehicle is offset 1.5 meters from the left lane and 2.1 meters from the right lane.

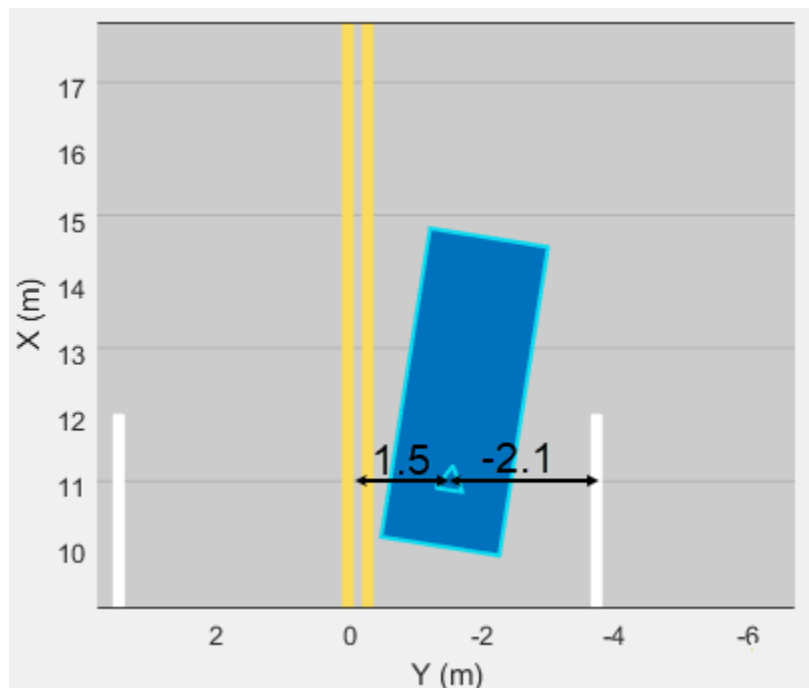





Example: -1.2

Data Types: single | double

BoundaryType — Type of lane boundary marking

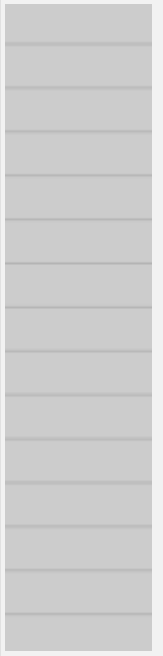
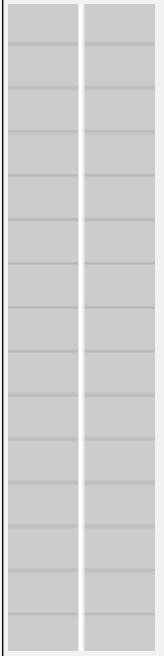
'Unmarked' (default) | 'Solid' | 'Dashed' | 'DoubleSolid' | 'DoubleDashed' | 'SolidDashed' | 'DashedSolid'

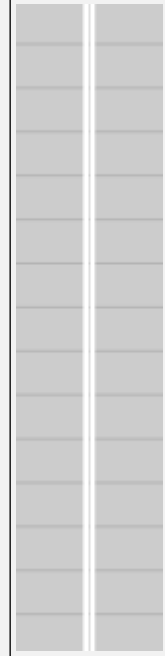
Type of lane boundary marking, specified as one of these values.

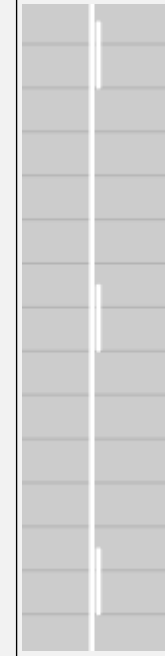
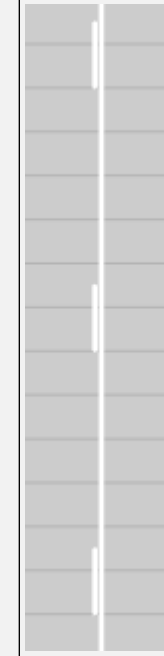
'Unmarked'	'Solid'	'Dashed'	'DoubleSolid'	'DoubleDashed'	'SolidDashed'	'DashedSolid'
No lane marking	Solid line	Dashed line	Two solid lines	Two dashed lines	Solid line on left, dashed line on right	Dashed line on left, solid line on right
						

Strength — Visibility of lane boundary marking

1 (default) | real scalar in the range [0, 1]

Visibility of lane marking, specified as a real scalar in the range [0, 1]. A value of 0 corresponds to a marking that is not visible. A value of 1 corresponds to a marking that is completely visible. For a double lane marking, the same strength is used for both lines.

Example: 0.9

Data Types: single | double

XExtent — Extent of lane boundary marking along X-axis

[0 Inf] (default) | real-valued vector of the form [X_{min} X_{max}]

Extent of the lane boundary marking along the X-axis, specified as a real-valued vector of the form [X_{min} X_{max}]. Units are in meters. The X-axis runs vertically and is positive in the forward direction of the ego vehicle.

Example: [0 100]

Data Types: single | double

Width — Width of lane boundary marking

0 (default) | nonnegative real scalar

Width of lane boundary marking, specified as a nonnegative real scalar. For a double lane marking, this value applies to the width of each lane marking and to the distance between those markings. Units are in meters.

Example: 0.15

Data Types: single | double

Object Functions

computeBoundaryModel Compute lane boundary points from clothoid lane boundary model

Examples

Create Clothoid Lane Boundaries

Create clothoid curves to represent left and right lane boundaries. Then, plot the curves.

Create the left boundary.

```
lb = clothoidLaneBoundary('BoundaryType','Solid', ...
    'Strength',1,'Width',0.2,'CurveLength',40, ...
    'Curvature',-0.8,'LateralOffset',2,'HeadingAngle',10);
```

Create the right boundary with almost identical properties.

```
rb = lb;
rb.LateralOffset = -2;
```

Create a bird's-eye plot. Then, create the lane boundary plotters and plot the boundaries.

```
bep = birdsEyePlot('XLimits',[0 50],'YLimits',[-10 10]);
lbPlotter = laneBoundaryPlotter(bep,'DisplayName','Left-lane boundary','Color','r');
rbPlotter = laneBoundaryPlotter(bep,'DisplayName','Right-lane boundary','Color','g');
plotLaneBoundary(lbPlotter,lb)
plotLaneBoundary(rbPlotter,rb);
grid
hold on
```

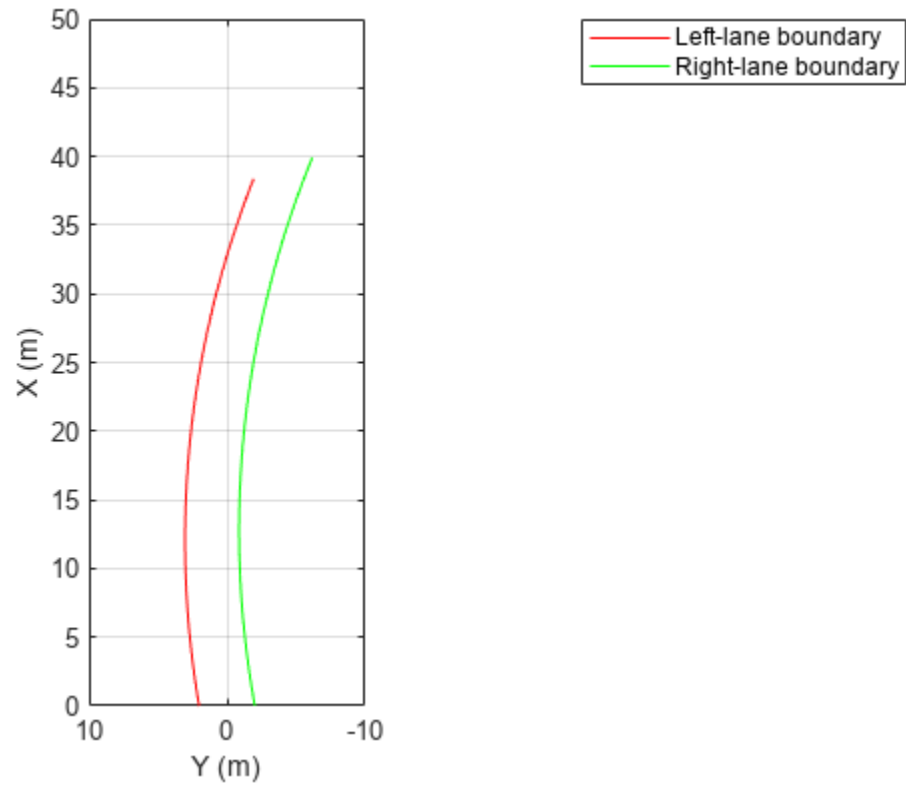

Plot the coordinates of selected points along the boundaries.

```
x = 0:5:50;  
yl = computeBoundaryModel(lb,x);  
yr = computeBoundaryModel(rb,x);  
plot(x,yl,'ro')  
plot(x,yr,'go')  
hold off
```

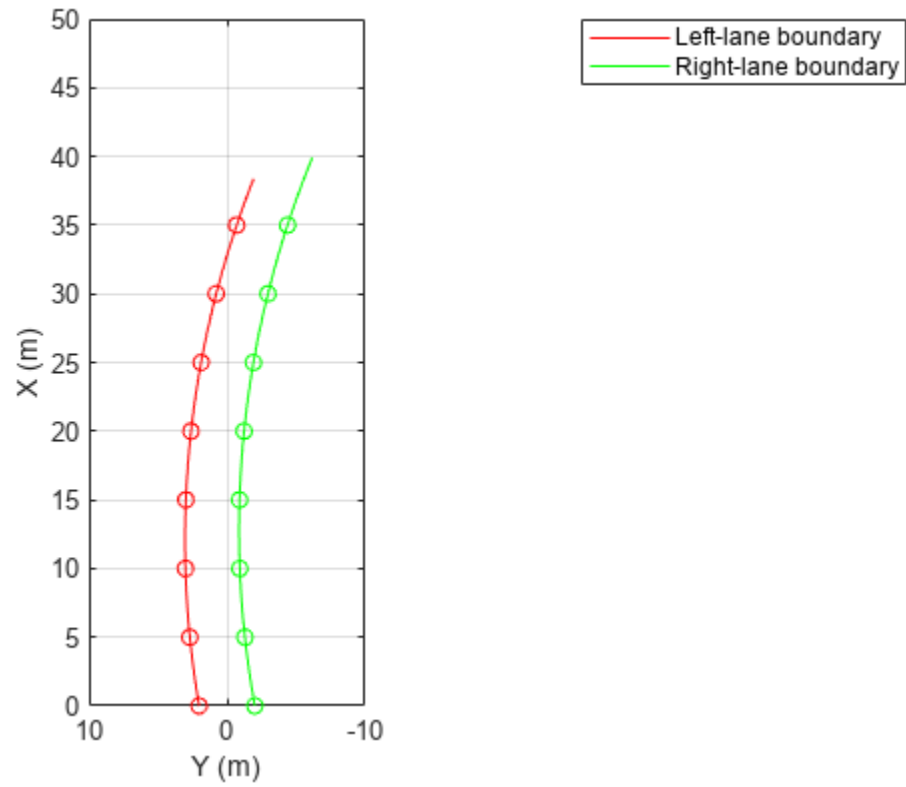

Version History

Introduced in R2018a

See Also

Objects

lanespec

Functions

plotLaneBoundary | laneBoundaryPlotter | laneBoundaries | laneMarking

computeBoundaryModel

Compute lane boundary points from clothoid lane boundary model

Syntax

```
yworld = computeBoundaryModel(boundary,xworld)
```

Description

`yworld = computeBoundaryModel(boundary,xworld)` returns the y-coordinates of lane boundary points, `yworld`, derived from a lane boundary, `boundary`, at points specified by the x-coordinates, `xworld`. All points are in world coordinates.

Examples

Create Clothoid Lane Boundaries

Create clothoid curves to represent left and right lane boundaries. Then, plot the curves.

Create the left boundary.

```
lb = clothoidLaneBoundary('BoundaryType','Solid', ...  
'Strength',1,'Width',0.2,'CurveLength',40, ...  
'Curvature',-0.8,'LateralOffset',2,'HeadingAngle',10);
```

Create the right boundary with almost identical properties.

```
rb = lb;  
rb.LateralOffset = -2;
```

Create a bird's-eye plot. Then, create the lane boundary plotters and plot the boundaries.

```
bep = birdsEyePlot('XLimits',[0 50],'YLimits',[-10 10]);  
lbPlotter = laneBoundaryPlotter(bep,'DisplayName','Left-lane boundary','Color','r');  
rbPlotter = laneBoundaryPlotter(bep,'DisplayName','Right-lane boundary','Color','g');  
plotLaneBoundary(lbPlotter,lb)  
plotLaneBoundary(rbPlotter,rb);  
grid  
hold on
```

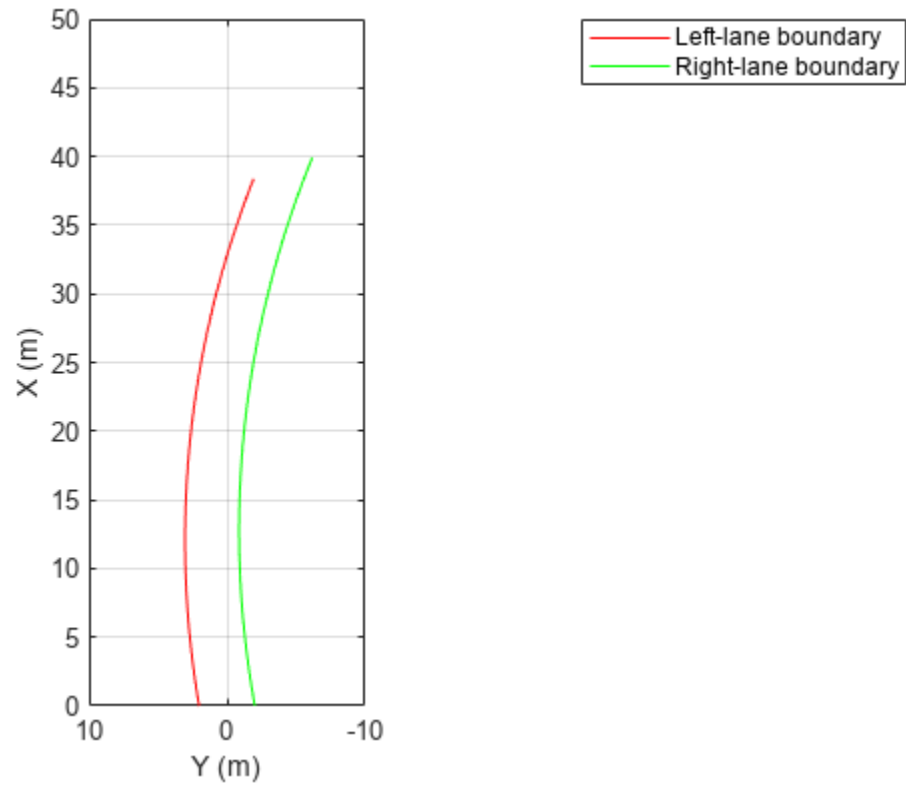

Plot the coordinates of selected points along the boundaries.

```
x = 0:5:50;  
yl = computeBoundaryModel(lb,x);  
yr = computeBoundaryModel(rb,x);  
plot(x,yl,'ro')  
plot(x,yr,'go')  
hold off
```

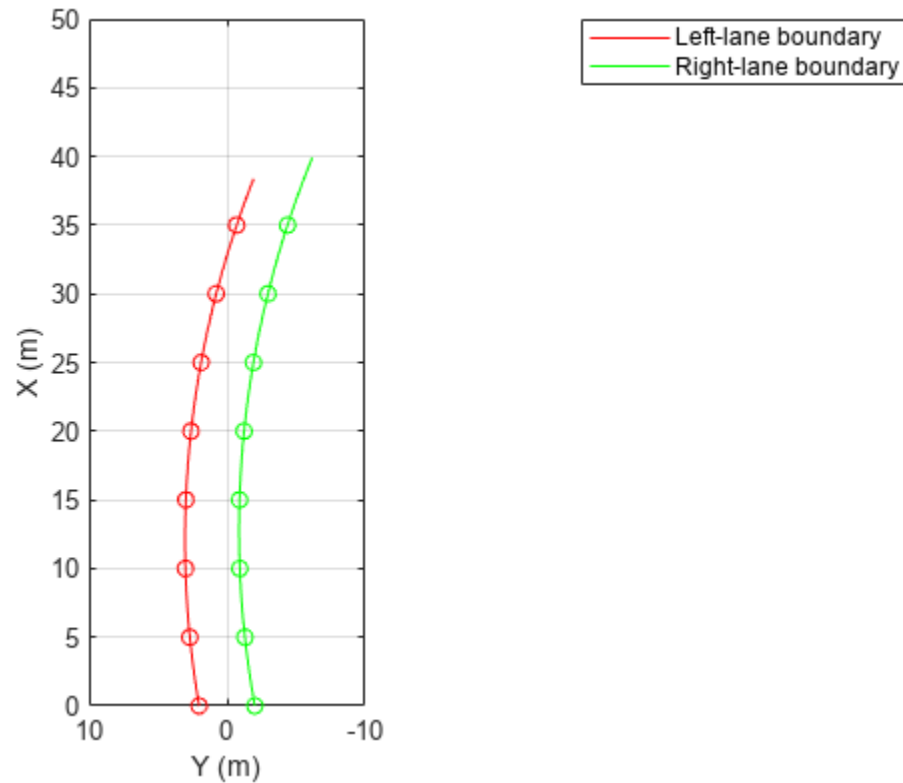

Input Arguments

boundary — Lane boundary model

clothoidLaneBoundary object

Lane boundary model, specified as a `clothoidLaneBoundary` object.

xworld — x-world coordinates

real-valued vector of length N

x-world coordinates, specified as a real-valued vector of length N , where N is the number of coordinates.

Example: `2:2.5:100`

Data Types: `single` | `double`

Output Arguments

yworld — y-world coordinates

real-valued vector of length N

y-world coordinates, returned as a real-valued vector of length N , where N is the number of coordinates. The length and data type of `yWorld` are the same as for `xWorld`.

Data Types: `single` | `double`

Version History

Introduced in R2018a

See Also

`laneBoundaries` | `clothoidLaneBoundary`

driving.scenario.bicycleMesh

Mesh representation of bicycle in driving scenario

Syntax

```
vehicleMesh = driving.scenario.bicycleMesh
```

Description

`vehicleMesh = driving.scenario.bicycleMesh` creates a mesh representation of a bicycle as an `extendedObjectMesh` object, `mesh`.

Examples

Generate Lidar Point Cloud by Using Bicycle Mesh

Add a prebuilt bicycle mesh to a driving scenario. Then, use a `lidarPointCloudGenerator System object™` to generate a point cloud of the bicycle mesh.

Create and show the prebuilt bicycle mesh.

```
mesh = driving.scenario.bicycleMesh;  
egoMesh = driving.scenario.carMesh;  
figure  
show(mesh)
```

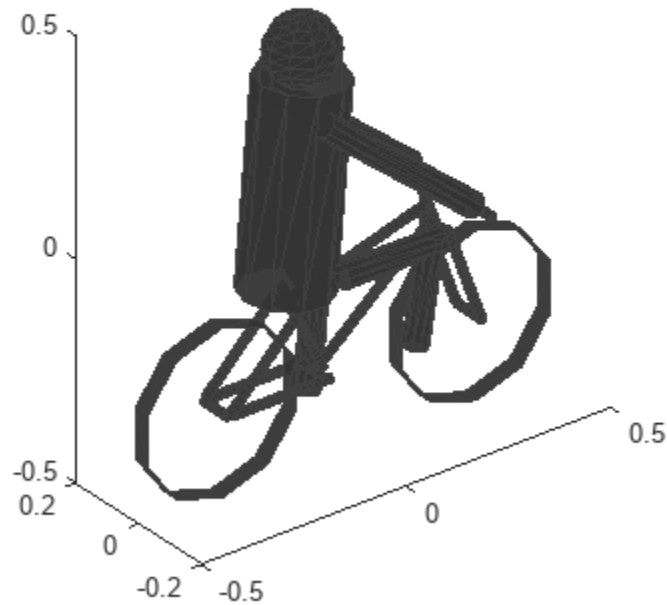

```
ans =
  Axes with properties:
      XLim: [-0.5000 0.5000]
      YLim: [-0.2000 0.2000]
      XScale: 'linear'
      YScale: 'linear'
      GridLineStyle: '-'
      Position: [0.1300 0.1100 0.7750 0.8150]
      Units: 'normalized'
```

Show all properties

Create a driving scenario.

```
s = drivingScenario;
```

Add a straight road to the driving scenario. The road has one lane traveling in each direction.

```
road(s,[0 0 0; 30 0 0], 'Lanes',lanespec([1 1]));
```

Add a car as an ego vehicle and a bicycle as a non-ego actor.

```
egoVehicle = vehicle(s, 'ClassID',1, 'Mesh',egoMesh);
bicycle = vehicle(s, 'Position',[15 2 0], 'Yaw',180, 'ClassID',3, 'Mesh',mesh);
smoothTrajectory(egoVehicle,[1 -2 0; 21.3 -2 0],20);
```

Plot the driving scenario. Set name-value pair 'Meshes', 'on' to show the meshes of the actors in the plot.

```
figure;
plot(s, 'Meshes', 'on');
```

Create a `lidarPointCloudGenerator` System object. Set the actor profiles of the System object to those in the driving scenario.

```
lidar = lidarPointCloudGenerator;
lidar.ActorProfiles = actorProfiles(s);
```

Generate a lidar point cloud of the driving scenario.

```
player = pcplayer([-20 20],[-10 10],[0 4]);
while advance(s)
    tgts = targetPoses(egoVehicle);
    rdmesh = roadMesh(egoVehicle);
    [ptCloud,isValidTime] = lidar(tgts,rdmesh,s.SimulationTime);
    if isValidTime
        view(player,ptCloud);
    end
end
```

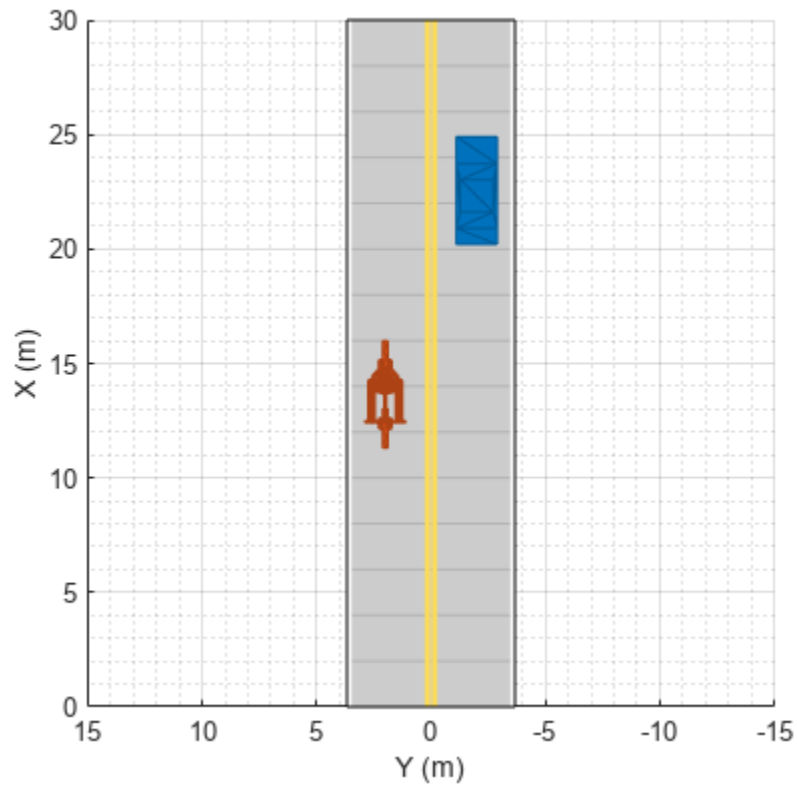

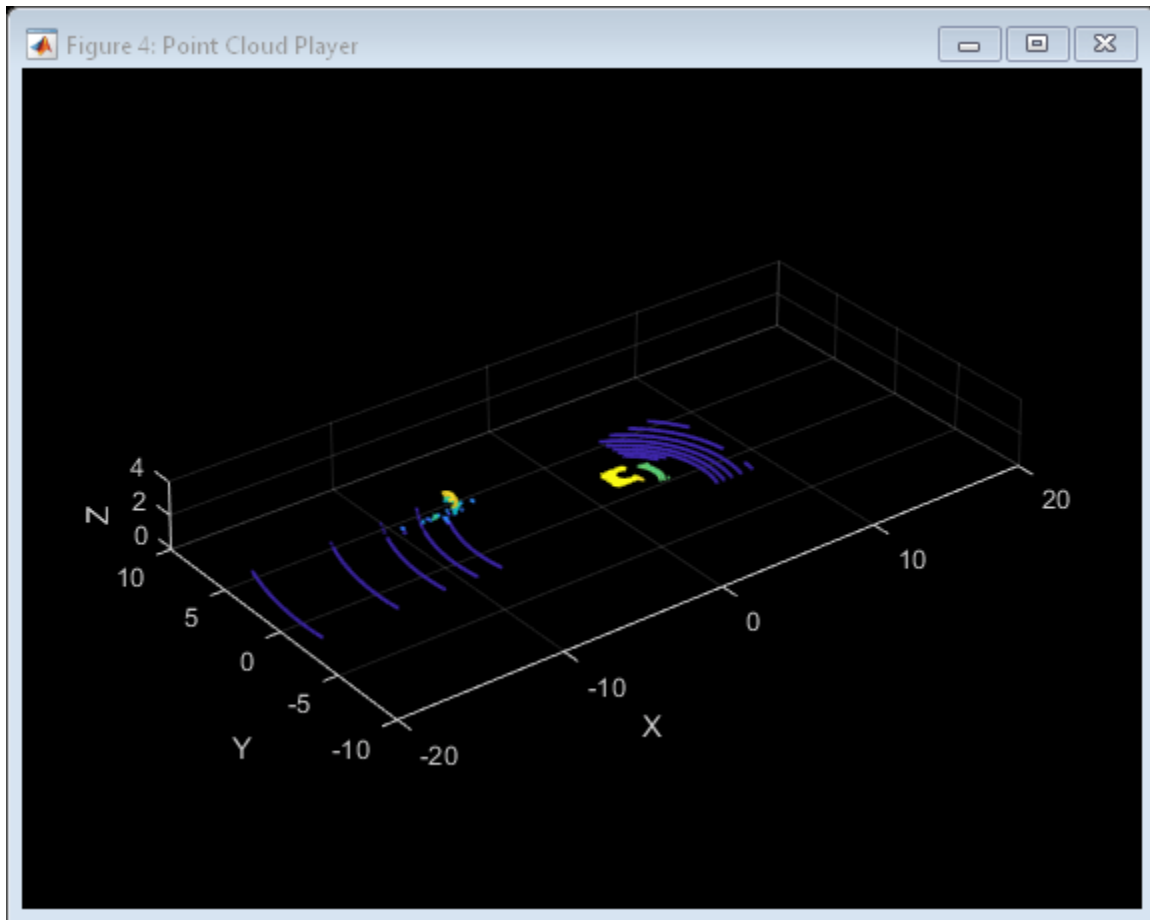

Output Arguments

vehicleMesh — Mesh representation of bicycle

extendedObjectMesh object

Mesh representation of bicycle, returned as an extendedObjectMesh object. The origin of the mesh is located at its geometric center.

You can develop your own meshes by using this prebuilt bicycle mesh as a starting point. At the MATLAB command line, enter:

```
edit driving.scenario.bicycleMesh
```

Version History

Introduced in R2020a

See Also

Objects

extendedObjectMesh

Functions

`driving.scenario.carMesh` | `driving.scenario.pedestrianMesh` |
`driving.scenario.truckMesh` | `translate` | `rotate` | `scale` | `applyTransform` | `join` |
`scaleToFit` | `show`

driving.scenario.carMesh

Mesh representation of car in driving scenario

Syntax

```
vehicleMesh = driving.scenario.carMesh
```

Description

`vehicleMesh = driving.scenario.carMesh` creates a mesh representation of a car as an `extendedObjectMesh` object, `mesh`.

Examples

Generate Lidar Point Cloud by Using Car Mesh

Add the prebuilt car mesh to a driving scenario. Then, use `lidarPointCloudGenerator System object™` to generate a point cloud of the car mesh.

Create and show the prebuilt car mesh.

```
mesh = driving.scenario.carMesh;  
show(mesh);
```

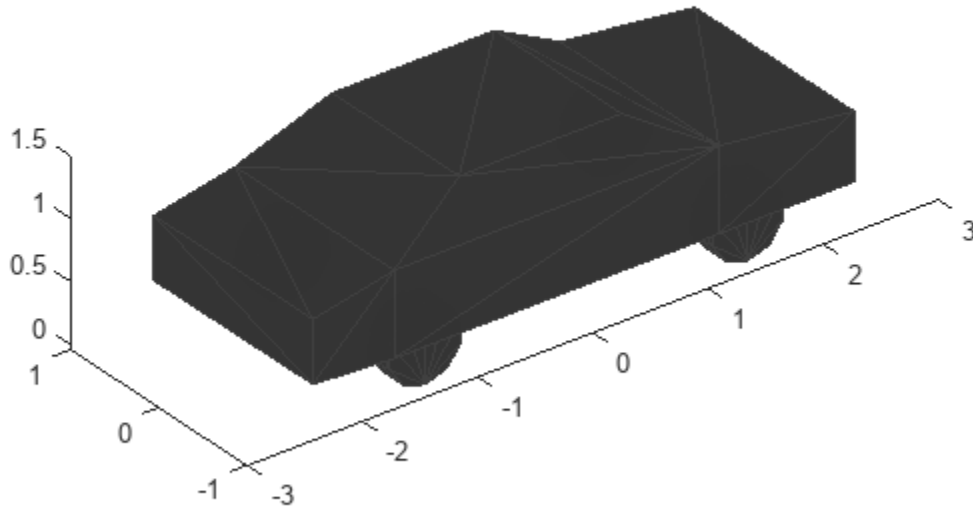

Create a driving scenario.

```
s = drivingScenario;
```

Add a straight road to the driving scenario. The road has one lane in each direction.

```
road(s,[0 0 0; 25 0 0], 'Lanes',lanespec([1 1]));
```

Add a car as an ego vehicle and as a non-ego actor.

```
egoVehicle = vehicle(s, 'ClassID',1, 'Mesh',mesh);
smoothTrajectory(egoVehicle,[1 -2 0; 21.3 -2 0],20);
car = vehicle(s, 'Position',[15 2 0], 'Yaw',180, 'ClassID',1, 'Mesh',mesh);
```

Plot the driving scenario. Set name-value pair 'Meshes', 'on' to show the meshes of the actors in the plot.

```
plot(s, 'Meshes', 'on');
```

Create a `lidarPointCloudGenerator` System object. Set the actor profiles of the System object to those in the driving scenario.

```
lidar = lidarPointCloudGenerator;
lidar.ActorProfiles = actorProfiles(s);
```

Generate a lidar point cloud of the driving scenario.

```
player = pcplayer([-20 20],[-10 10],[0 4]);
while advance(s)
```



```
tgts = targetPoses(egoVehicle);  
rdmesh = roadMesh(egoVehicle);  
[ptCloud,isValidTime] = lidar(tgts,rdmesh,s.SimulationTime);  
if isValidTime  
    view(player,ptCloud);  
end  
end
```

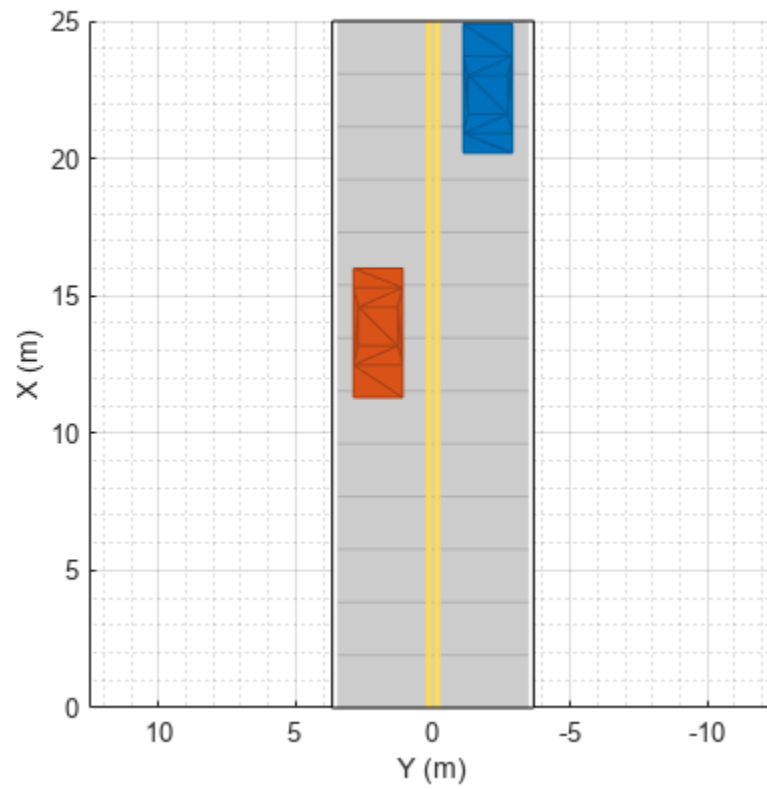

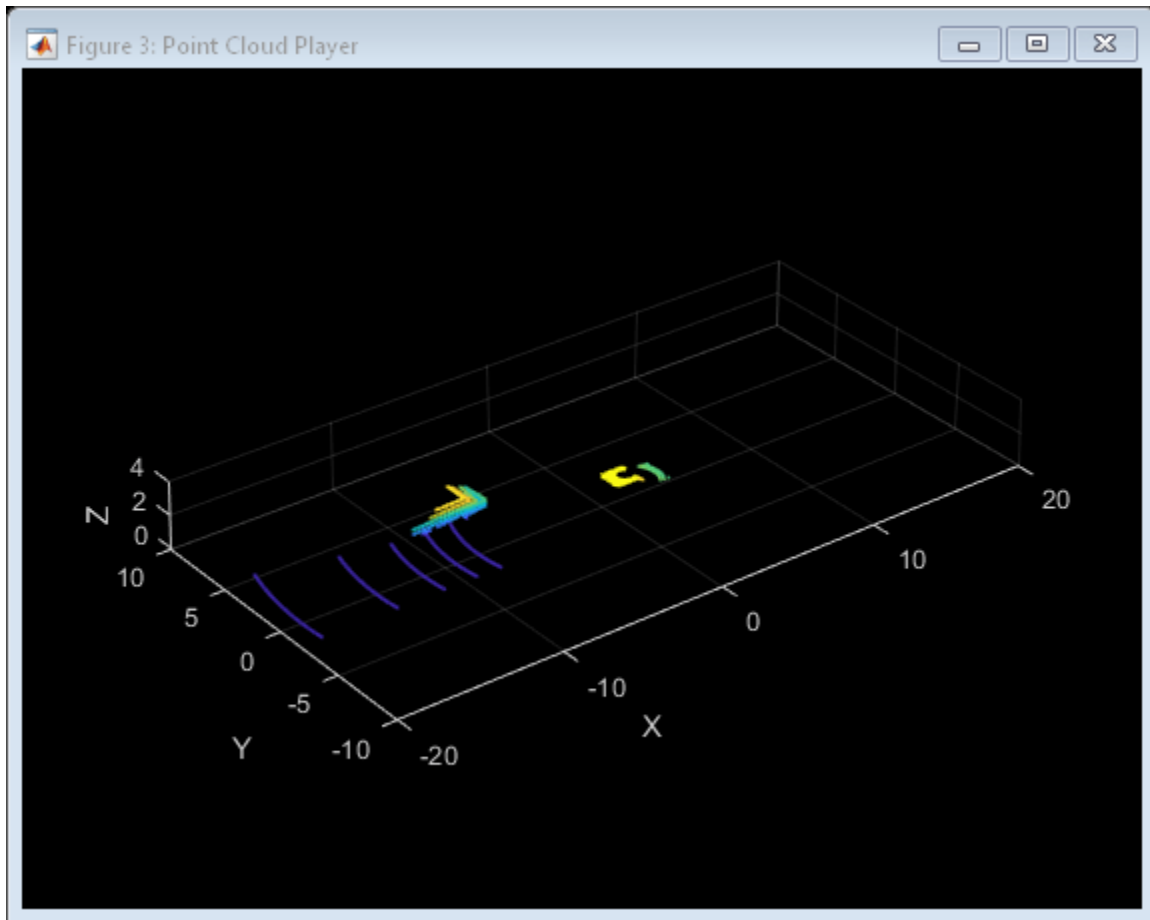

Output Arguments

vehicleMesh — Mesh representation of car

`extendedObjectMesh` object

Mesh representation of car, returned as an `extendedObjectMesh` object. The origin of the mesh is located at its geometric center.

You can develop your own meshes by using this prebuilt car mesh as a starting point. At the MATLAB command line, enter:

```
edit driving.scenario.carMesh
```

Version History

Introduced in R2020a

See Also

Objects

`extendedObjectMesh`

Functions

driving.scenario.bicycleMesh | driving.scenario.pedestrianMesh |
driving.scenario.truckMesh | translate | rotate | scale | applyTransform | join |
scaleToFit | show

driving.scenario.pedestrianMesh

Mesh representation of pedestrian in driving scenario

Syntax

```
pedMesh = driving.scenario.pedestrianMesh
```

Description

`pedMesh = driving.scenario.pedestrianMesh` creates a mesh representation of a pedestrian as an `extendedObjectMesh` object, `mesh`.

Examples

Generate Lidar Point Cloud by Using Pedestrian Mesh

Add the prebuilt pedestrian mesh to a driving scenario. Then, use `lidarPointCloudGenerator` System object™ to generate a point cloud of the pedestrian mesh.

Create and show the prebuilt pedestrian mesh.

```
mesh = driving.scenario.pedestrianMesh;  
egoMesh = driving.scenario.carMesh;  
show(mesh);
```

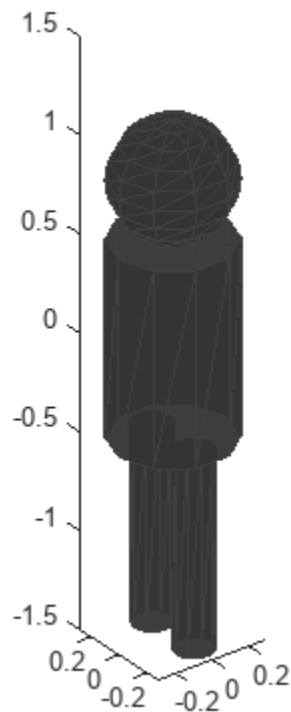

Create a driving scenario.

```
s = drivingScenario;
```

Add a straight road to the driving scenario. The road has one lane in each direction.

```
road(s,[0 0 0; 30 0 0], 'Lanes',lanespec([1 1]));
```

Add a car as an ego vehicle and a pedestrian as a non-ego actor.

```
egoVehicle = vehicle(s, 'ClassID',1, 'Mesh',egoMesh);
smoothTrajectory(egoVehicle,[1 -2 0; 21.3 -2 0],20);
pedestrian = actor(s, 'Length',0.24, 'Width',0.45, 'Height',1.7, 'Position',[15 2 0], 'ClassID',4, 'Mesh',pedestrianMesh);
```

Plot the driving scenario. Set name-value pair 'Meshes', 'on' to show the meshes of the actors in the plot.

```
plot(s, 'Meshes', 'on');
```

Create a `lidarPointCloudGenerator` System object. Set the actor profiles of the System object to those in the driving scenario.

```
lidar = lidarPointCloudGenerator;
lidar.ActorProfiles = actorProfiles(s);
```

Generate a lidar point cloud of the driving scenario.

```
player = pcplayer([-20 20],[-10 10],[0 4]);
while advance(s)
```

```
tgts = targetPoses(egoVehicle);  
rdmesh = roadMesh(egoVehicle);  
[ptCloud,isValidTime] = lidar(tgts,rdmesh,s.SimulationTime);  
    if isValidTime  
        view(player,ptCloud);  
    end  
end
```

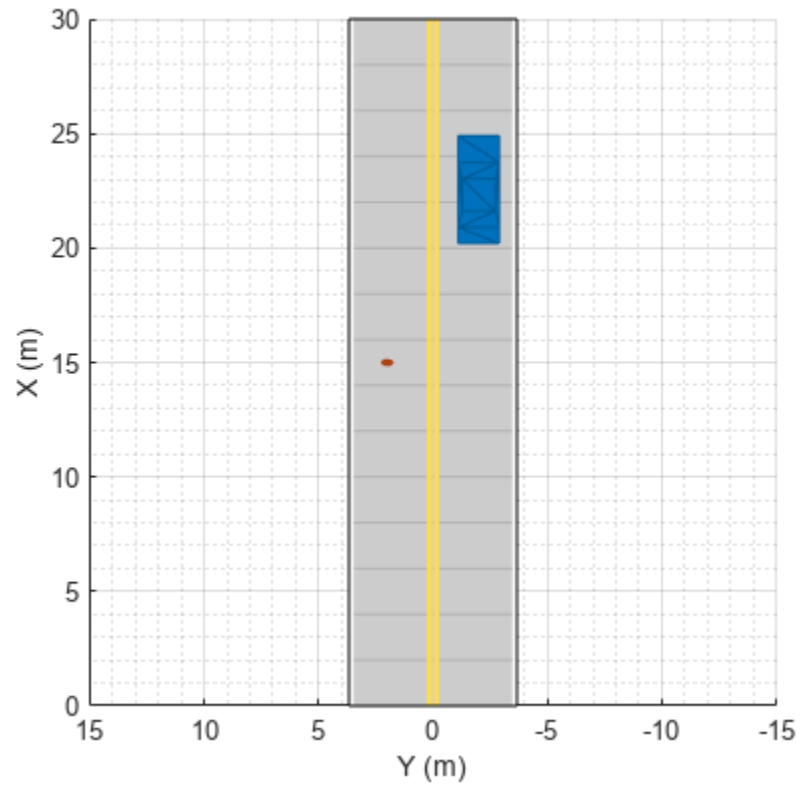

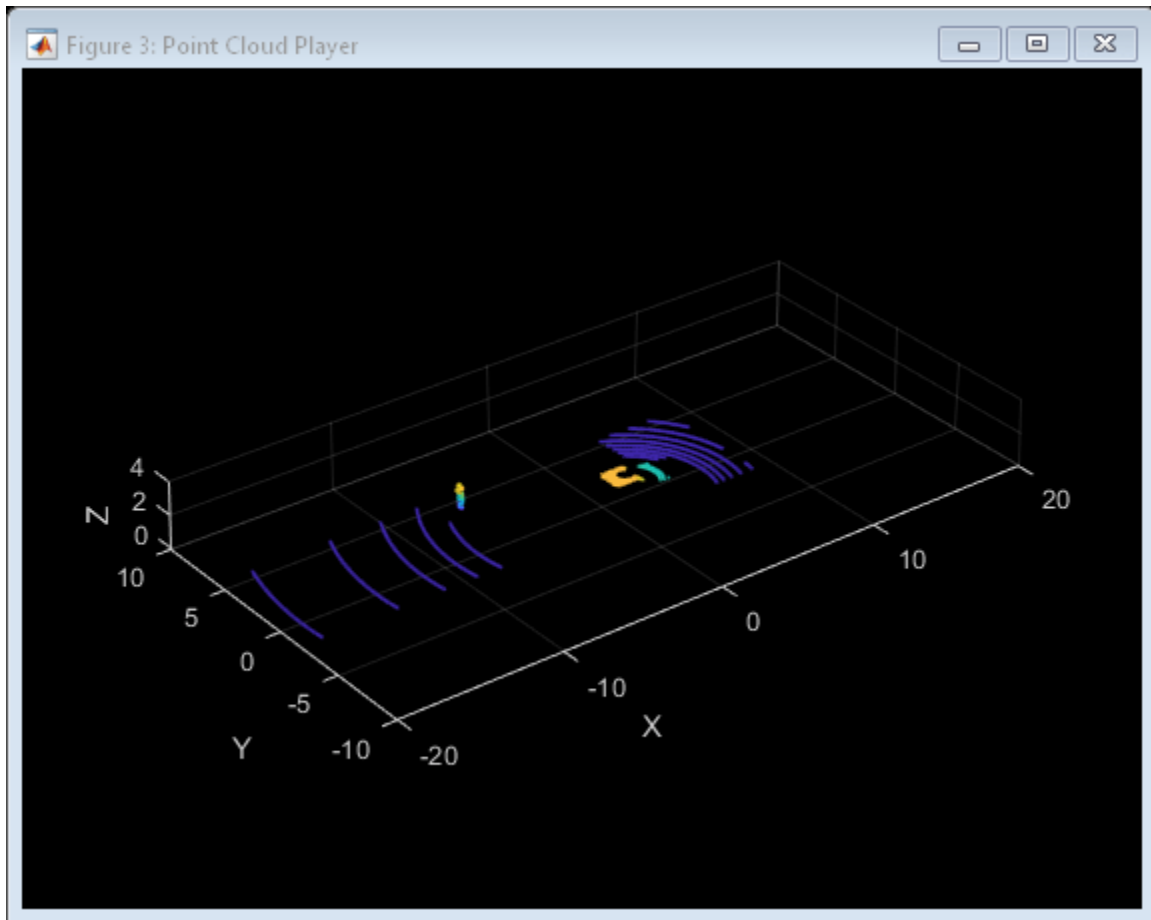

Output Arguments

pedMesh — Mesh representation of pedestrian

extendedObjectMesh object

Mesh representation of pedestrian, returned as an extendedObjectMesh object. The origin of the mesh is located at its geometric center.

You can develop your own meshes by using this prebuilt pedestrian mesh as a starting point. At the MATLAB command line, enter:

```
edit driving.scenario.pedestrianMesh
```

Version History

Introduced in R2020a

See Also

Objects

extendedObjectMesh

Functions

`driving.scenario.bicycleMesh | driving.scenario.carMesh |
driving.scenario.truckMesh | translate | rotate | scale | applyTransform | join |
scaleToFit | show`

driving.scenario.truckMesh

Mesh representation of truck in driving scenario

Syntax

```
vehicleMesh = driving.scenario.truckMesh
```

Description

`vehicleMesh = driving.scenario.truckMesh` creates a mesh representation of a truck as an `extendedObjectMesh` object, `mesh`.

Examples

Generate Lidar Point Cloud by Using Truck Mesh

Add the prebuilt truck mesh to a driving scenario to generate a point cloud. Then, use `lidarPointCloudGenerator System` object™ to generate a point cloud of the truck mesh.

Create and show the prebuilt truck mesh.

```
mesh = driving.scenario.truckMesh;  
egoMesh = driving.scenario.carMesh;  
show(mesh);
```

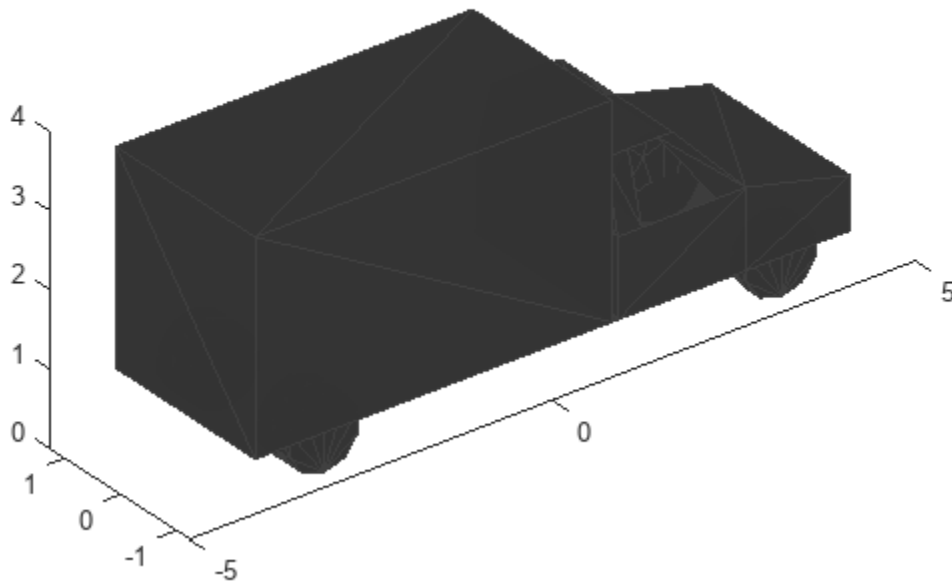

```
pause(1);
```

Create a driving scenario.

```
s = drivingScenario;
```

Add a straight road to the driving scenario. The road has one lane in each direction.

```
road(s,[0 0 0; 30 0 0], 'Lanes',lanespec([1 1]));
```

Add a car as the ego vehicle and a truck as a non-ego actor.

```
egoVehicle = vehicle(s, 'ClassID',1, 'Mesh',egoMesh);
smoothTrajectory(egoVehicle,[1 -2 0; 21.3 -2 0],20);
truck = vehicle(s, 'Position',[15 2 0], 'Yaw',180, 'ClassID',2, 'Mesh',mesh);
```

Plot the driving scenario. Set name-value pair 'Meshes', 'on' to show the meshes of the actors in the plot.

```
plot(s, 'Meshes', 'on');
```

Create a `lidarPointCloudGenerator` System object. Set the actor profiles of the System object to those in the driving scenario.

```
lidar = lidarPointCloudGenerator;
lidar.ActorProfiles = actorProfiles(s);
```

Generate a lidar point cloud of the driving scenario.

```
player = pcplayer([-20 20],[-10 10],[0 4]);  
while advance(s)  
    tgts = targetPoses(egoVehicle);  
    rdmesh = roadMesh(egoVehicle);  
    [ptCloud,isValidTime] = lidar(tgts,rdmesh,s.SimulationTime);  
    if isValidTime  
        view(player,ptCloud);  
    end  
end
```

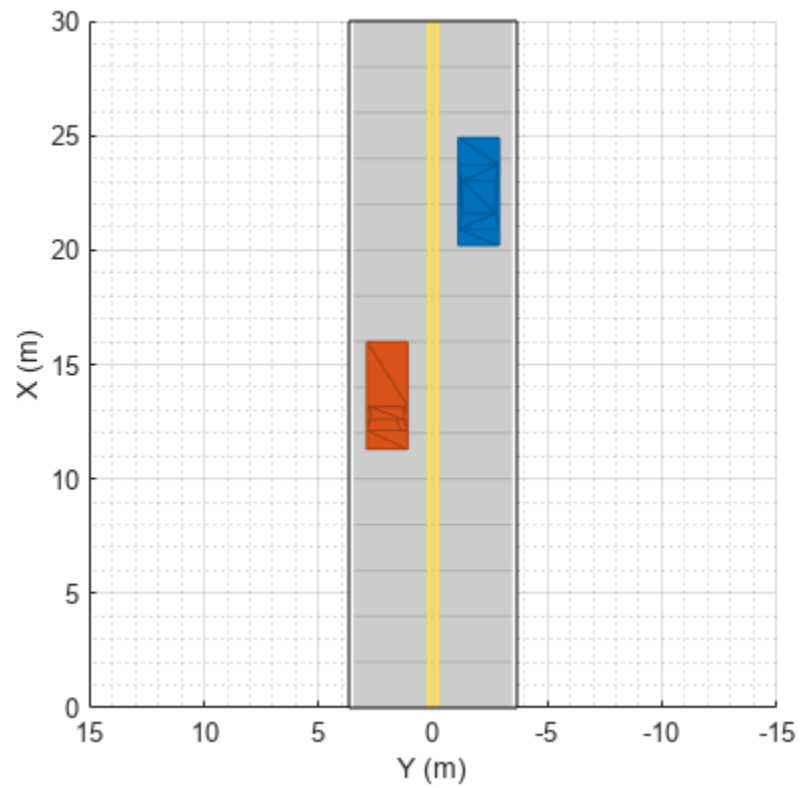

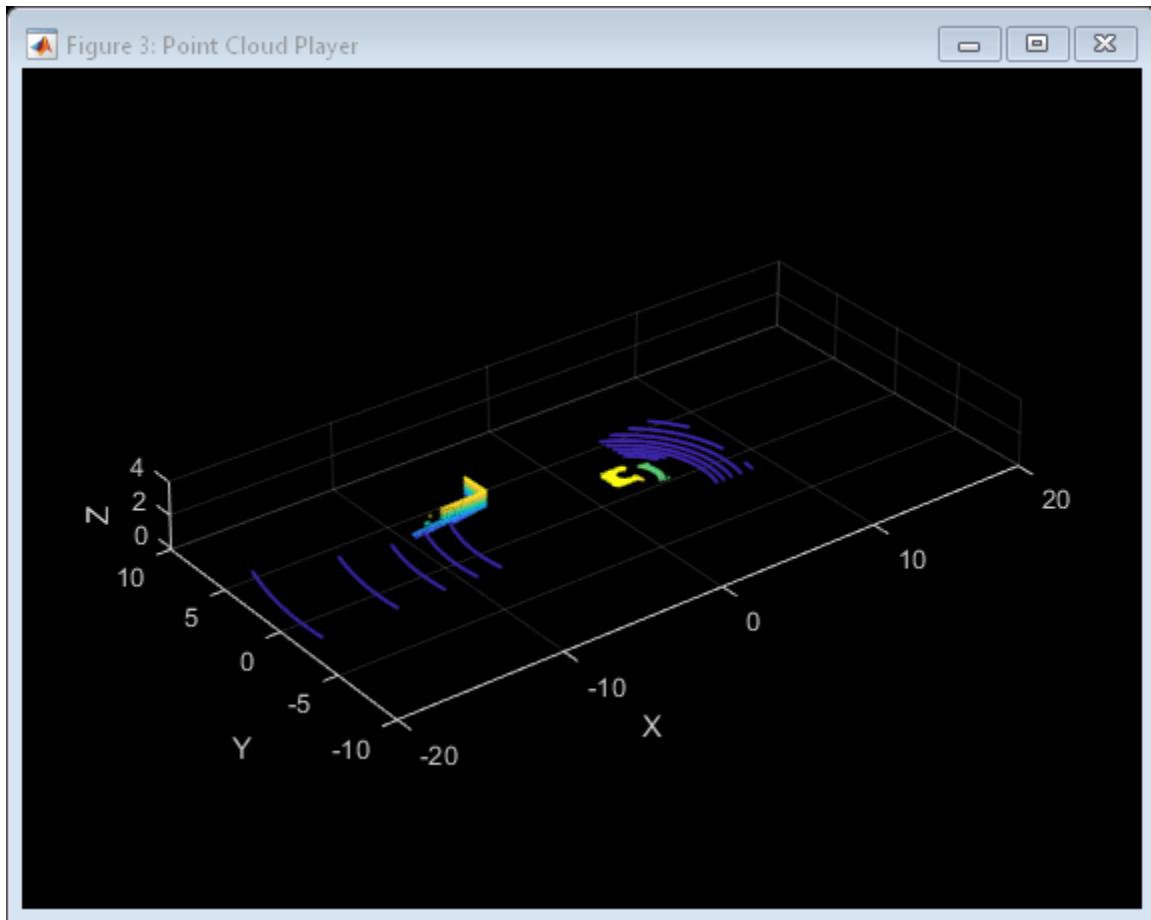

Output Arguments

vehicleMesh — Mesh representation of truck

`extendedObjectMesh` object

Mesh representation of truck, returned as an `extendedObjectMesh` object. The origin of the mesh is located at its geometric center.

You can develop your own meshes by using this prebuilt truck mesh as a starting point. At the MATLAB command line, enter:

```
edit driving.scenario.truckMesh
```

Version History

Introduced in R2020a

See Also

Objects

`extendedObjectMesh`

Functions

driving.scenario.bicycleMesh | driving.scenario.carMesh |
driving.scenario.pedestrianMesh | translate | rotate | scale | applyTransform | join |
scaleToFit | show

driving.scenario.jerseyBarrierMesh

Mesh representation of Jersey barrier in driving scenario

Syntax

```
barrierMesh = driving.scenario.jerseyBarrierMesh
```

Description

`barrierMesh = driving.scenario.jerseyBarrierMesh` creates a mesh representation of a Jersey barrier as an `extendedObjectMesh` object, `mesh`.

Examples

Generate Lidar Point Cloud by Using Jersey Barrier Mesh

Add the prebuilt Jersey barrier mesh to a driving scenario. Then, use `lidarPointCloudGenerator` System object™ to generate a point cloud of the Jersey barrier mesh.

Create and show the prebuilt Jersey barrier mesh.

```
mesh = driving.scenario.jerseyBarrierMesh;  
show(mesh);
```

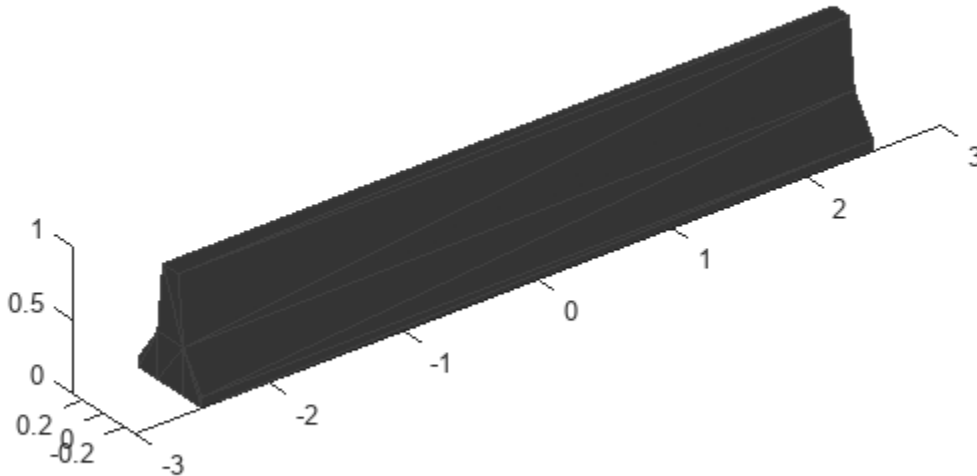

Create a driving scenario.

```
s = drivingScenario;
```

Add a straight road to the driving scenario. The road has one lane in each direction.

```
road1 = road(s, [0 0 0; 25 0 0], 'Lanes', lanespec([1 1]));
```

Add a Jersey barrier to the road along the right edge.

```
barrier(s, road1, 'Mesh', mesh);
```

Add a car as an ego vehicle and as a non-ego actor and apply the car mesh to both using `driving.scenario.carMesh`.

```
carMesh = driving.scenario.carMesh;
egoVehicle = vehicle(s, 'ClassID', 1, 'Mesh', carMesh);
smoothTrajectory(egoVehicle, [1 -2 0; 21.3 -2 0], 20);
car = vehicle(s, 'Position', [15 2 0], 'Yaw', 180, 'ClassID', 1, 'Mesh', carMesh);
```

Plot the driving scenario. Set name-value pair 'Meshes', 'on' to show the meshes of the actors in the plot.

```
plot(s, 'Meshes', 'on');
```

Create a `lidarPointCloudGenerator` System object. Set the actor profiles of the System object to those in the driving scenario.

```
lidar = lidarPointCloudGenerator;  
lidar.ActorProfiles = actorProfiles(s);
```

Generate a lidar point cloud of the driving scenario.

```
player = pcplayer([-20 20],[-10 10],[0 4]);  
while advance(s)  
    tgts = targetPoses(egoVehicle);  
    rdmesh = roadMesh(egoVehicle);  
    [ptCloud, isValidTime] = lidar(tgts,rdmesh,s.SimulationTime);  
    if isValidTime  
        view(player,ptCloud);  
    end  
end
```

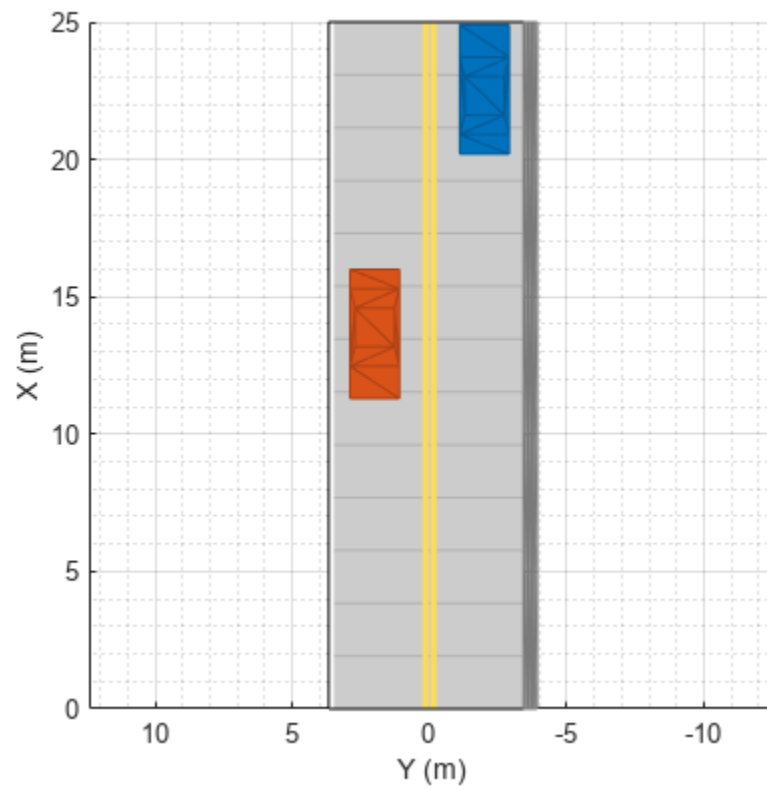

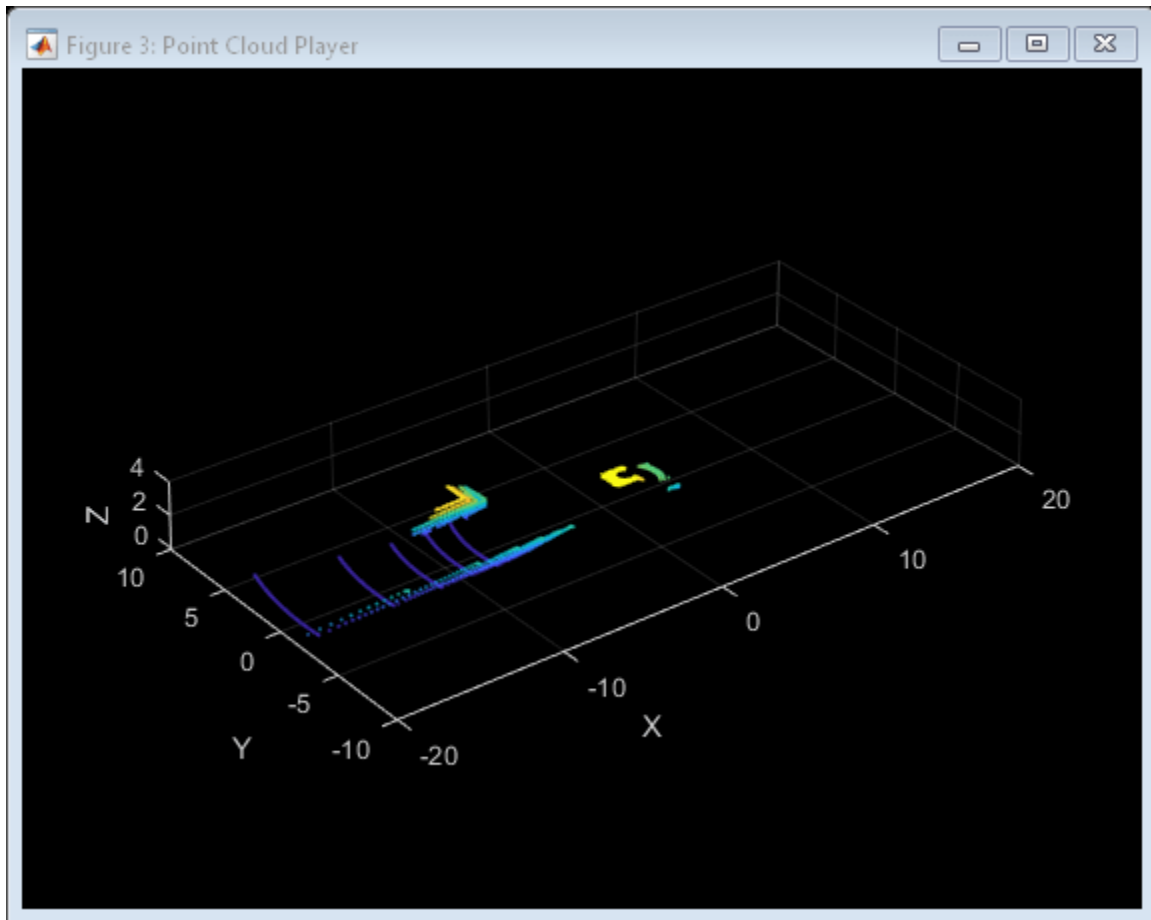

Output Arguments

barrierMesh — Mesh representation of Jersey barrier

extendedObjectMesh object

Mesh representation of Jersey barrier, returned as an extendedObjectMesh object. The origin of the mesh is located at its geometric center.

You can develop your own meshes by using this prebuilt Jersey barrier mesh as a starting point. At the MATLAB command line, enter:

```
edit driving.scenario.jerseyBarrierMesh
```

Version History

Introduced in R2021a

See Also

Objects

extendedObjectMesh

Functions

driving.scenario.guardrailMesh | driving.scenario.carMesh |
driving.scenario.bicycleMesh | driving.scenario.pedestrianMesh |
driving.scenario.truckMesh | translate | rotate | scale | applyTransform | join |
scaleToFit | show

driving.scenario.guardrailMesh

Mesh representation of guardrail in driving scenario

Syntax

```
barrierMesh = driving.scenario.guardrailMesh
```

Description

`barrierMesh = driving.scenario.guardrailMesh` creates a mesh representation of a guardrail as an `extendedObjectMesh` object, `mesh`.

Examples

Generate Lidar Point Cloud by Using Guardrail Mesh

Add the prebuilt guardrail mesh to a driving scenario. Then, use `lidarPointCloudGenerator System object™` to generate a point cloud of the guardrail mesh.

Create and show the prebuilt guardrail mesh.

```
mesh = driving.scenario.guardrailMesh;  
show(mesh);
```

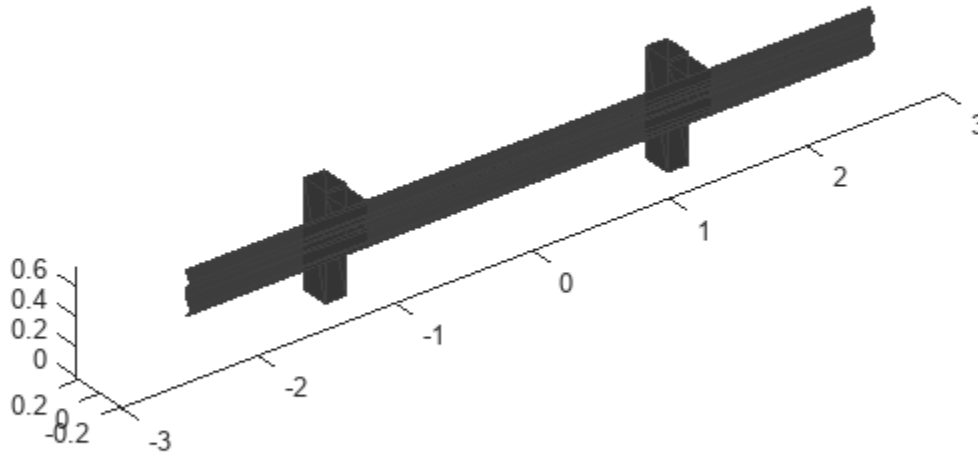

Create a driving scenario.

```
s = drivingScenario;
```

Add a straight road to the driving scenario. The road has one lane in each direction.

```
road1 = road(s, [0 0 0; 25 0 0], 'Lanes', lanespec([1 1]));
```

Add a guardrail to the road along the right edge.

```
barrier(s, road1, 'Mesh', mesh);
```

Add a car as an ego vehicle and as a non-ego actor and apply the car mesh to both using `driving.scenario.carMesh`.

```
carMesh = driving.scenario.carMesh;
egoVehicle = vehicle(s, 'ClassID', 1, 'Mesh', carMesh);
smoothTrajectory(egoVehicle, [1 -2 0; 21.3 -2 0], 20);
car = vehicle(s, 'Position', [15 2 0], 'Yaw', 180, 'ClassID', 1, 'Mesh', carMesh);
```

Plot the driving scenario. Set name-value pair `'Meshes', 'on'` to show the meshes of the actors in the plot.

```
plot(s, 'Meshes', 'on');
```

Create a `lidarPointCloudGenerator` System object. Set the actor profiles of the System object to those in the driving scenario.

```
lidar = lidarPointCloudGenerator;  
lidar.ActorProfiles = actorProfiles(s);
```

Generate a lidar point cloud of the driving scenario.

```
player = pcplayer([-20 20],[-10 10],[0 4]);
```

```
while advance(s)  
    tgts = targetPoses(egoVehicle);  
    rdmesh = roadMesh(egoVehicle);  
    [ptCloud, isValidTime] = lidar(tgts,rdmesh,s.SimulationTime);  
    if isValidTime  
        view(player,ptCloud);  
    end  
end
```

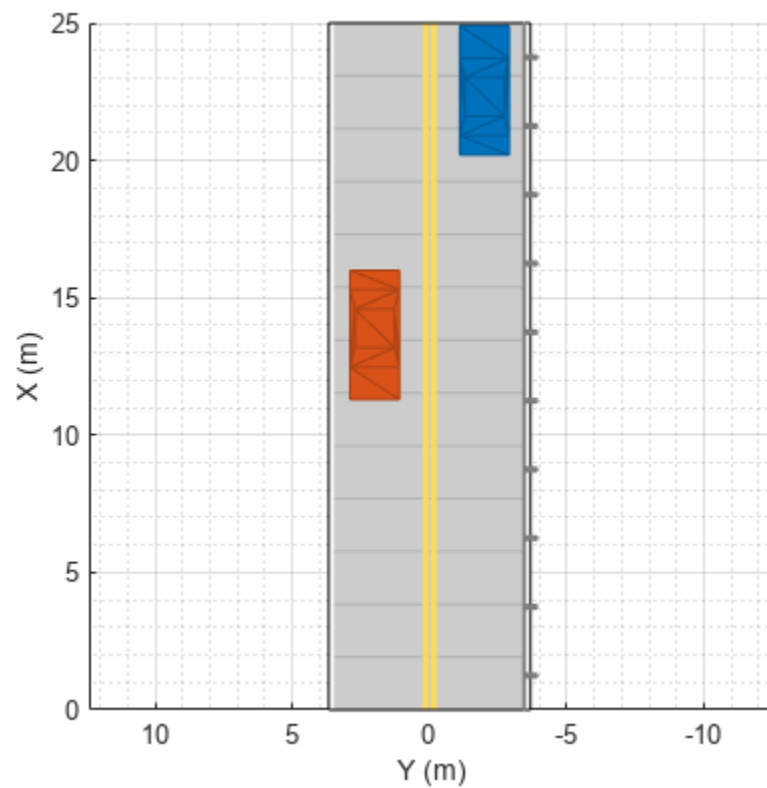

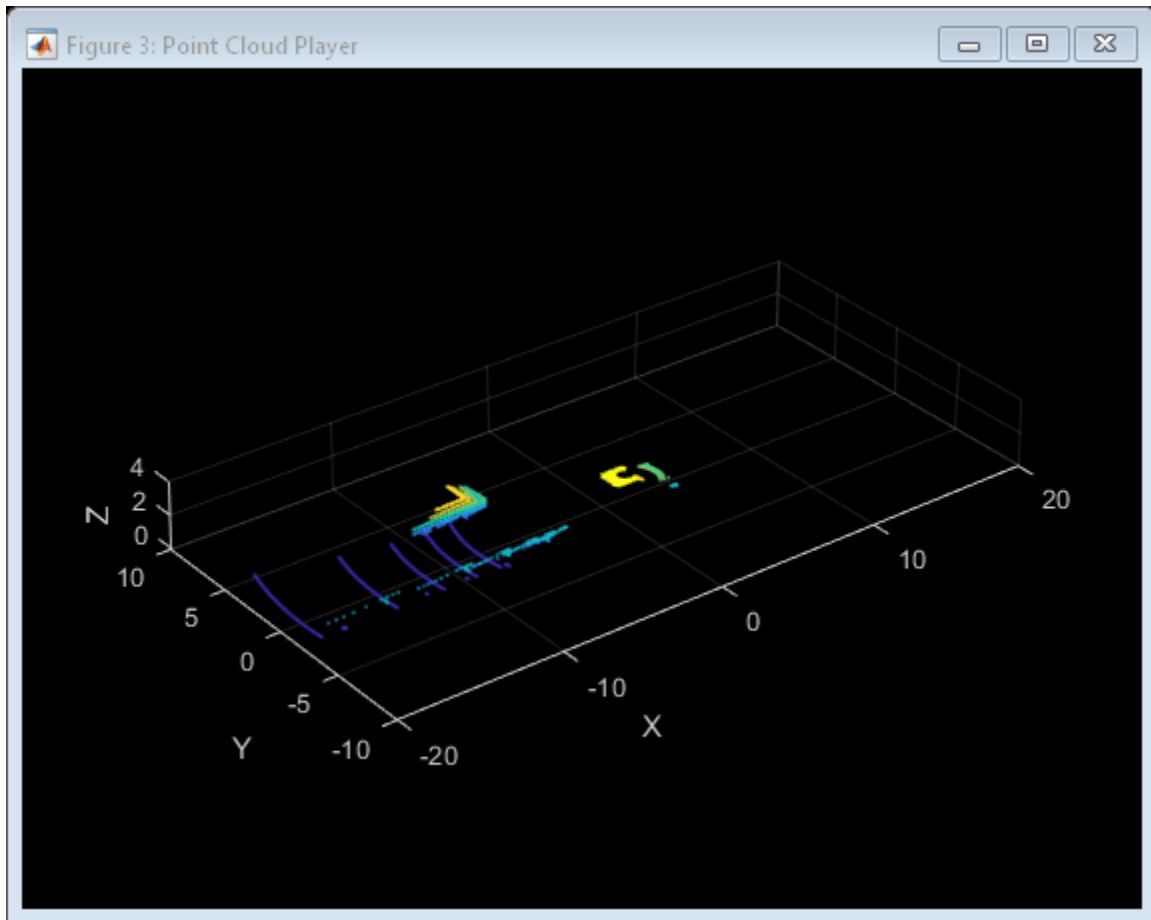

Output Arguments

barrierMesh — Mesh representation of guardrail

extendedObjectMesh object

Mesh representation of guardrail, returned as an `extendedObjectMesh` object. The origin of the mesh is located at its geometric center.

You can develop your own meshes by using this prebuilt guardrail mesh as a starting point. At the MATLAB command line, enter:

```
edit driving.scenario.guardrailMesh
```

Version History

Introduced in R2021a

See Also

Objects

`extendedObjectMesh`

Functions

driving.scenario.jerseyBarrierMesh | driving.scenario.carMesh |
driving.scenario.bicycleMesh | driving.scenario.pedestrianMesh |
driving.scenario.truckMesh | translate | rotate | scale | applyTransform | join |
scaleToFit | show

addSensors

Add sensors to specific host vehicle

Syntax

```
addSensors(scenario, sensors, hostVehicleID)
```

Description

`addSensors(scenario, sensors, hostVehicleID)` adds all the sensors to the vehicle with unique ID `hostVehicleID`, in the driving scenario `scenario`.

Examples

Add Sensors to Driving Scenario and Get Target Poses Using Sensor Input

In this example, you will add sensors to a driving scenario using the `addSensors` function and get ground-truth target poses based on the individual sensor inputs. Then, you process the ground-truth target poses into detections and visualize them.

Set Up Driving Scenario and Bird's-Eye-Plot

Create a driving scenario with an ego vehicle and two target vehicles. One target vehicle is in the front and the other is to the left of the ego-vehicle.

```
[scenario, egovehicle] = helperCreateDrivingScenario;
```

Configure a vision sensor to be mounted at the front of the ego vehicle.

```
visionSensor = visionDetectionGenerator(SensorIndex=1, SensorLocation=[4.0 0], Height=1.1, Pitch=1.0);
```

Configure an ultrasonic sensor to be mounted at the left side of the ego-vehicle.

```
leftUltrasonic = ultrasonicDetectionGenerator(SensorIndex=2, MountingLocation=[0.5 1 0.2], MountingAngle=90);
```

Create a bird's-eye-plot to visualize the driving scenario.

```
[detPlotter, lmPlotter, olPlotter, lulrdPlotter, luldetectPlotter, bepAxes] = helperCreateBEP(visionSensor, leftUltrasonic, egovehicle, scenario);
```

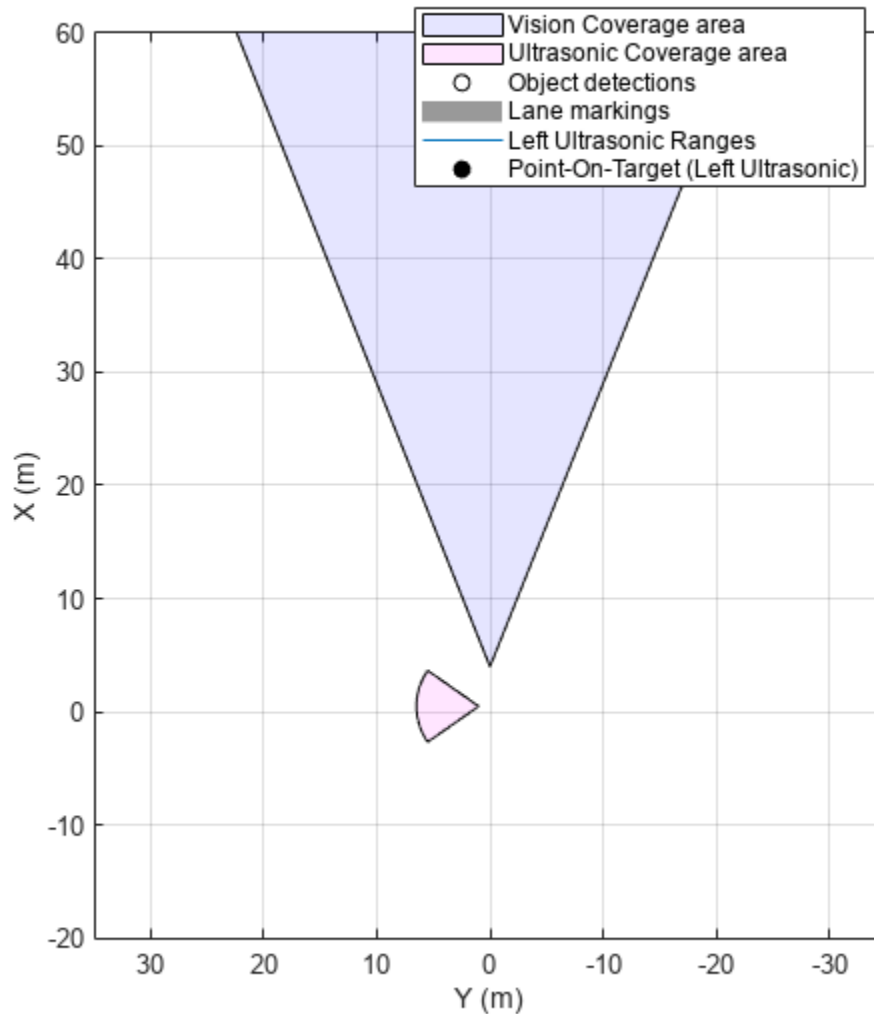
Add Sensors and Simulate Driving Scenario

Add both vision and ultrasonic sensors to the driving scenario using the `addSensors` function. You can add sensors to any vehicle in the driving scenario using the `addSensors` function by specifying the actor ID of the desired vehicle. In this example, specify the ego-vehicle actor ID.

```
addSensors(scenario, {visionSensor, leftUltrasonic}, egovehicle.ActorID);
```

Simulate the driving scenario. Note that you get separate target poses based on individual sensors by specifying their respective sensor IDs as inputs to the `targetPoses` function. This syntax returns the ground-truth poses of targets only within the range of the specified sensor. You then pass the ground-truth poses to their respective sensor models to generate detections and visualize them.

```
legend(bepAxes, 'show')
lookaheadDistance = 0:0.5:60;
while advance(scenario)

    lb = laneBoundaries(egovehicle, 'XDistance', lookaheadDistance, 'LocationType', 'inner');
    [lmv, lmf] = laneMarkingVertices(egovehicle);

    % Get ground-truth poses of targets in the range of vision and ultrasonic sensors separately
    tgtposeVision = targetPoses(scenario, visionSensor.SensorIndex);
    tgtposeUltrasonic = targetPoses(scenario, leftUltrasonic.SensorIndex);

    % Obtain detections based on targets only in range
    [obdets, obValid] = visionSensor(tgtposeVision, scenario.SimulationTime);
    [lobdets, lobValid] = leftUltrasonic(tgtposeUltrasonic, scenario.SimulationTime);

    helperPlotBEPVision(egovehicle, lmv, lmf, obdets, obValid, detPlotter, lmPlotter, olPlotter)
    helperPlotBEPUltrasonic(lobdets, lobValid, leftUltrasonic, lulrdPlotter, luldetPlotter)
end
```

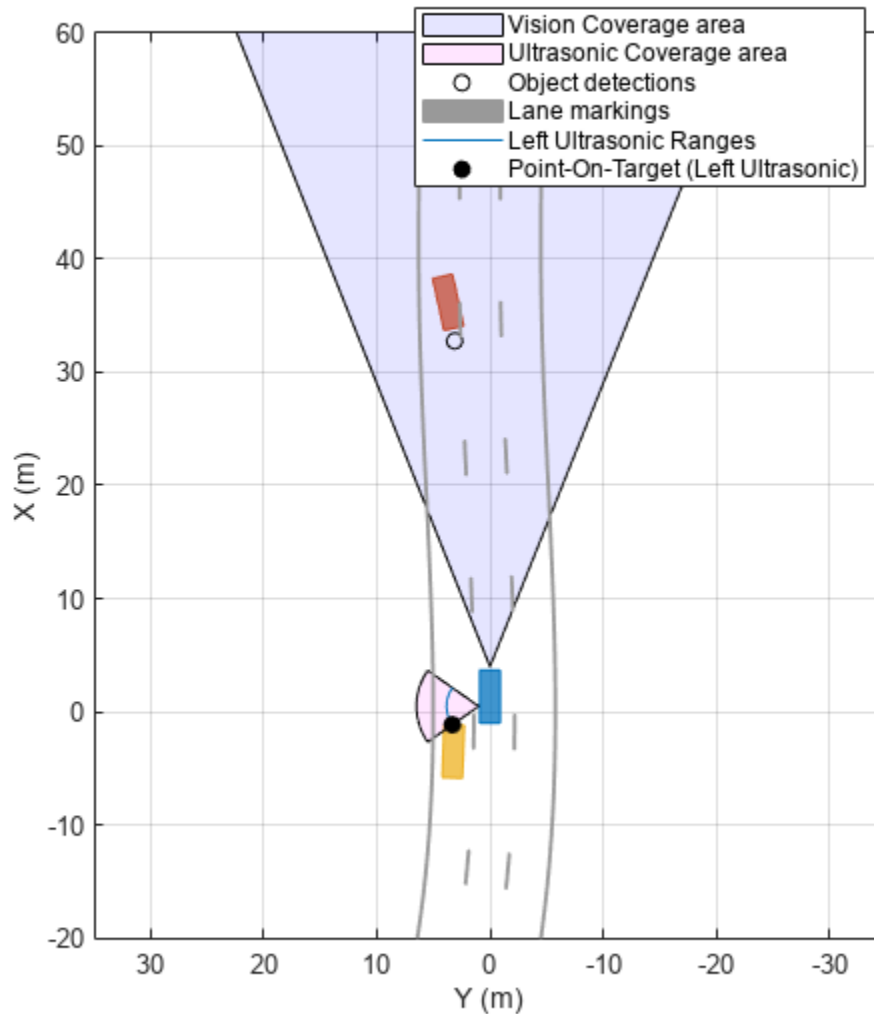

Helper Functions

`helperCreateDrivingScenario` creates a driving scenario by specifying the road and vehicle properties.

```
function [scenario, egovehicle] = helperCreateDrivingScenario
    scenario = drivingScenario;
    roadCenters = [-120 30 0; -60 0 0; 0 0 0; 60 0 0; 120 30 0; 180 60 0];
    lspc = lanespec(3);
    road(scenario, roadCenters, Lanes=lspc);

    % Create an ego vehicle that travels in the center lane at a velocity of 30 m/s.
    egovehicle = vehicle(scenario, ClassID=1);
    egopath = [1.5 0 0; 60 0 0; 111 25 0];
```

```

egospeed = 30;
smoothTrajectory(egovehicle, egopath, egospeed);

% Add a target vehicle that travels ahead of the ego vehicle at 30.5 m/s in the right lane,
ftargetcar = vehicle(scenario, ClassID=1);
ftargetpath = [8 2; 60 -3.2; 120 33];
ftargetspeed = 40;
smoothTrajectory(ftargetcar, ftargetpath, ftargetspeed);

% Add a second target vehicle that travels in the left lane at 32m/s.
ltargetcar = vehicle(scenario, ClassID=1);
ltargetpath = [-5.0 3.5 0; 60 3.5 0; 111 28.5 0];
ltargetspeed = 30;
smoothTrajectory(ltargetcar, ltargetpath, ltargetspeed);
end

```

helperCreateBEP creates a bird's-eye-plot for visualizing the driving scenario simulation.

```

function [detPlotter, lmPlotter, olPlotter, lulrdPlotter, luldetPlotter, bepAxes] = helperCreateBEP(scenario, egoVehicle, egoPath, egoSpeed, targetCar, targetPath, targetSpeed, secondTargetCar, secondTargetPath, secondTargetSpeed)
figureName = "BEP";
Figure = findobj('Type', 'Figure', Name=figureName);
if isempty(Figure)
    screenSize = double(get(groot, 'ScreenSize'));
    Figure = figure(Name=figureName);
    Figure.Position = [screenSize(3)*0.17 screenSize(4)*0.15 screenSize(3)*0.4 screenSize(4)*0.4];
    Figure.NumberTitle = 'off';
    Figure.MenuBar = 'none';
    Figure.ToolBar = 'none';
end
clf(Figure);
bepAxes = axes(Figure);
grid(bepAxes, 'on');
legend(bepAxes, 'hide');

bep = birdsEyePlot(Parent=bepAxes, XLim=[-20 60], YLim=[-35 35]);
caPlotterV = coverageAreaPlotter(bep, DisplayName="Vision Coverage area", FaceColor="b");
caPlotterU = coverageAreaPlotter(bep, DisplayName="Ultrasonic Coverage area", FaceColor="m");
detPlotter = detectionPlotter(bep, DisplayName="Object detections");
lmPlotter = laneMarkingPlotter(bep, DisplayName="Lane markings");
olPlotter = outlinePlotter(bep);
plotCoverageArea(caPlotterV, visionSensor.SensorLocation, ...
    visionSensor.MaxRange, visionSensor.Yaw, ...
    visionSensor.FieldOfView(1));
plotCoverageArea(caPlotterU, leftUltrasonic.MountingLocation(1:2), ...
    leftUltrasonic.DetectionRange(3), leftUltrasonic.MountingAngles(1), ...
    leftUltrasonic.FieldOfView(1));

lulrdPlotter = rangeDetectionPlotter(bep, DisplayName="Left Ultrasonic Ranges", LineStyle="-");
luldetPlotter = detectionPlotter(bep, DisplayName="Point-On-Target (Left Ultrasonic)", MarkerFaceColor="r");
end

```

helperPlotBEPVision plots ego vehicle outlines, lanes and vision detections on the bird's-eye-plot.

```

function helperPlotBEPVision(egovehicle, lmv, lmf, obdets, obValid, detPlotter, lmPlotter, olPlotter)
plotLaneMarking(lmPlotter, lmv, lmf)

[objposition, objyaw, objlength, objwidth, objoriginOffset, color] = targetOutlines(egovehicle);
plotOutline(olPlotter, objposition, objyaw, objlength, objwidth, ...

```

```

        OriginOffset=objoriginOffset,Color=color)

    if obValid
        detPos = cellfun(@(d)d.Measurement(1:2),obdets,UniformOutput=false);
        detPos = vertcat(zeros(0,2),cell2mat(detPos'))';
        plotDetection(detPlotter,detPos)
    end

end

helperPlotBEPUltrasonic plots ultrasonic range measurements and points on targets.

function helperPlotBEPUltrasonic(lobdets,lobValid,leftUltrasonic,lulrdPlotter,luldetPlotter)

    if ~isempty(lobdets) && lobValid
        lranges = lobdets{1}.Measurement;
        plotRangeDetection(lulrdPlotter,lranges,leftUltrasonic.FieldOfView(1),leftUltrasonic.Mour
        plotDetection(luldetPlotter,lobdets{1}.ObjectAttributes{1}.PointOnTarget(1:2)')
    end

end

```

Input Arguments

scenario — Driving scenario

drivingScenario object

Driving scenario, specified as a drivingScenario object.

sensors — Sensors to add to driving scenario

visionDetectionGenerator object | drivingRadarDataGenerator object |
ultrasonicDetectionGenerator object | cell array of detection generator objects

Sensors to add to the driving scenario, specified as one of the following:

- A single visionDetectionGenerator, drivingRadarDataGenerator or ultrasonicDetectionGenerator object
- A cell array of any combination of detection generator objects listed above

Each detection generator must have a unique sensor ID specified by its SensorIndex property.

hostVehicleID — Actor ID of vehicle in driving scenario

positive scalar

Actor ID of the vehicle in the driving scenario, specified as a positive scalar. The function adds sensors to the vehicle corresponding to this ID in the scenario. You can access the actor ID using the ActorID property of the vehicle object.

```

hostVehicle = vehicle(scenario,ClassID=1);
hostVehicleID = vehicle.ActorID

```

Version History

Introduced in R2023a

See Also

`drivingScenario` | `targetPoses` | `drivingRadarDataGenerator` |
`visionDetectionGenerator` | `ultrasonicDetectionGenerator`

parkingLot

Add parking lot to driving scenario

Syntax

```
parkingLot(scenario,vertices)
parkingLot(scenario,vertices,Name=Value)
lot = parkingLot( ___ )
```

Description

`parkingLot(scenario,vertices)` adds a parking lot to a driving scenario. The parking lot is in the shape of a polygon formed by the specified vertices.

`parkingLot(scenario,vertices,Name=Value)` specifies additional options using name-value arguments. For example, to define the parking space used to populate one of the predefined parking lot layouts, use the `ParkingSpace` name-value argument.

`lot = parkingLot(___)` returns a `ParkingLot` object, `lot`, that stores the properties of the created parking lot. To insert parking spaces into this parking lot, specify `lot` as an input argument of the `insertParkingSpaces` function. You can return `lot` using any of the previous syntaxes.

Examples

Create Parking Lot with Spaces Along Edges

Create a driving scenario containing a short road that enters into a parking lot that is 50 meters long and 20 meters wide. Plot the parking lot and display the edge numbers along which you can insert parking spaces. Because edge 3 forms a junction with the road, its edge number does not display on the plot, but you can still insert spaces along it.

```
scenario = drivingScenario;
roadcenters = [25 30; 25 15];
road(scenario,roadcenters);

vertices = [0 0; 50 0; 50 20; 0 20];
lot = parkingLot(scenario,vertices);
plot(scenario,ParkingLotEdges="On")
```

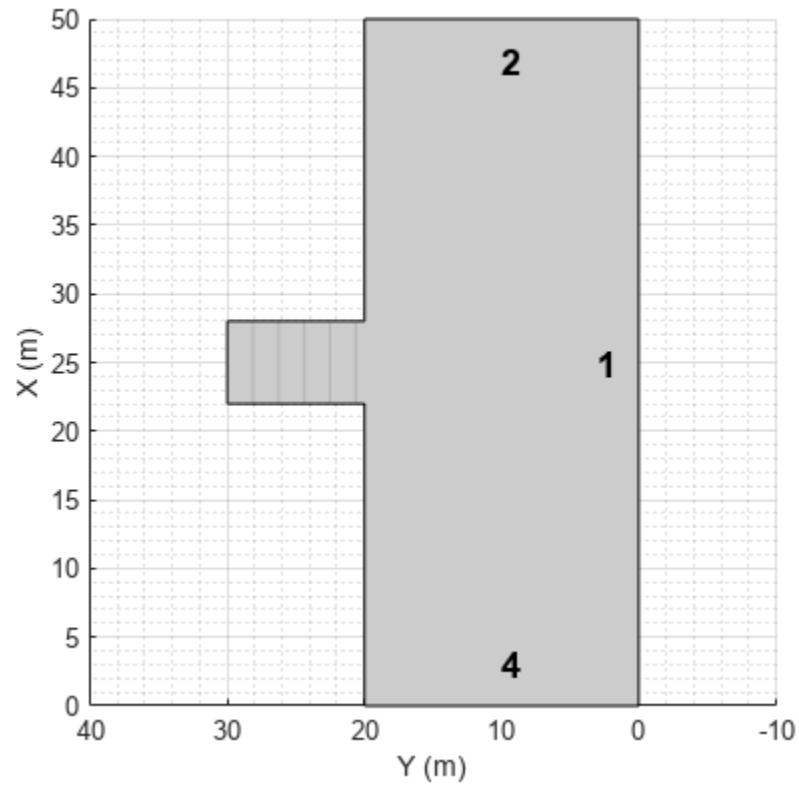

Define the parking space type to add along one of the edges. Set an angle of 60 degrees. Plot the parking space.

```
space = parkingSpace(Angle=60);  
plot(space)
```

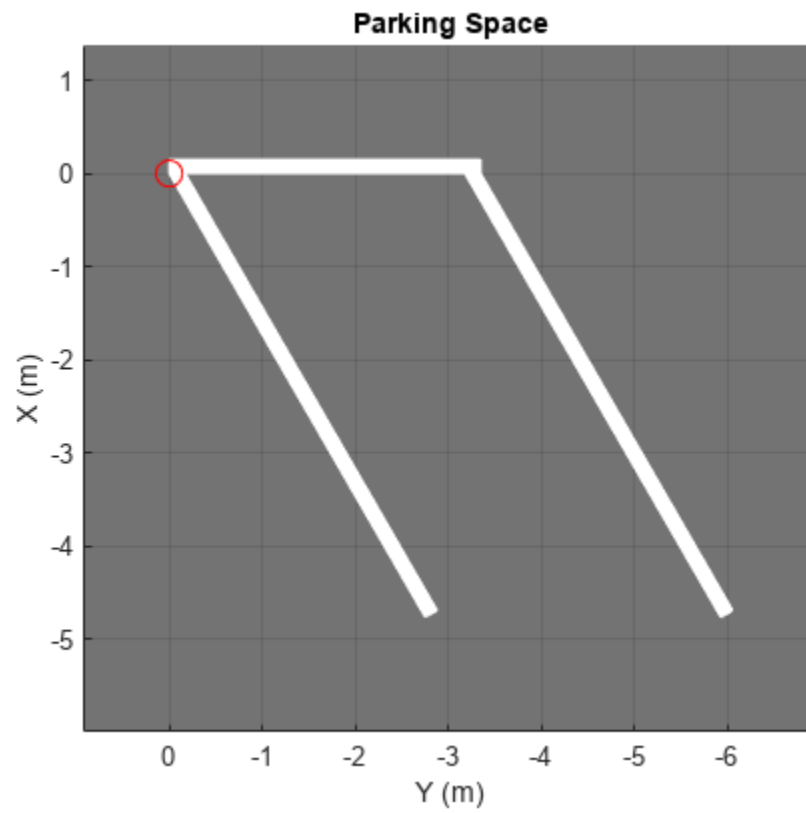
Insert the angled spaces along edge 1 of the parking lot.

```
insertParkingSpaces(lot,space,Edge=1)
```

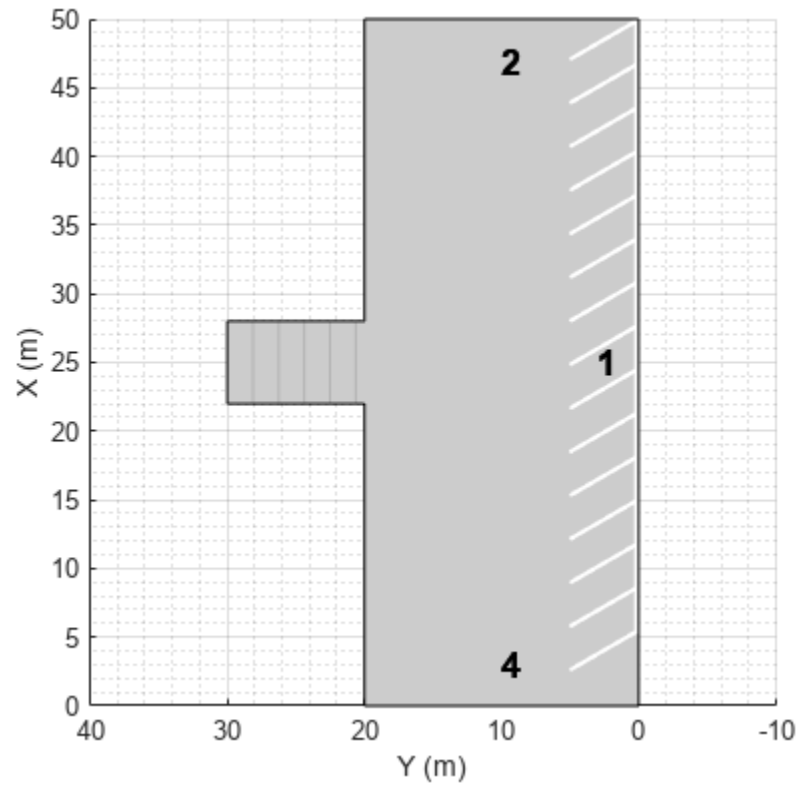

Insert angled spaces along edge 3: five above the junction and five below the junction. Offset these spaces by 3 meters and 30 meters from the bottom of edge 3, respectively. Reverse the angle of the spaces used along edge 1.

```
numSpaces = 5;
space = parkingSpace(Angle=120);
insertParkingSpaces(lot,space,numSpaces,Edge=3,Offset=3)
insertParkingSpaces(lot,space,numSpaces,Edge=3,Offset=30)
```

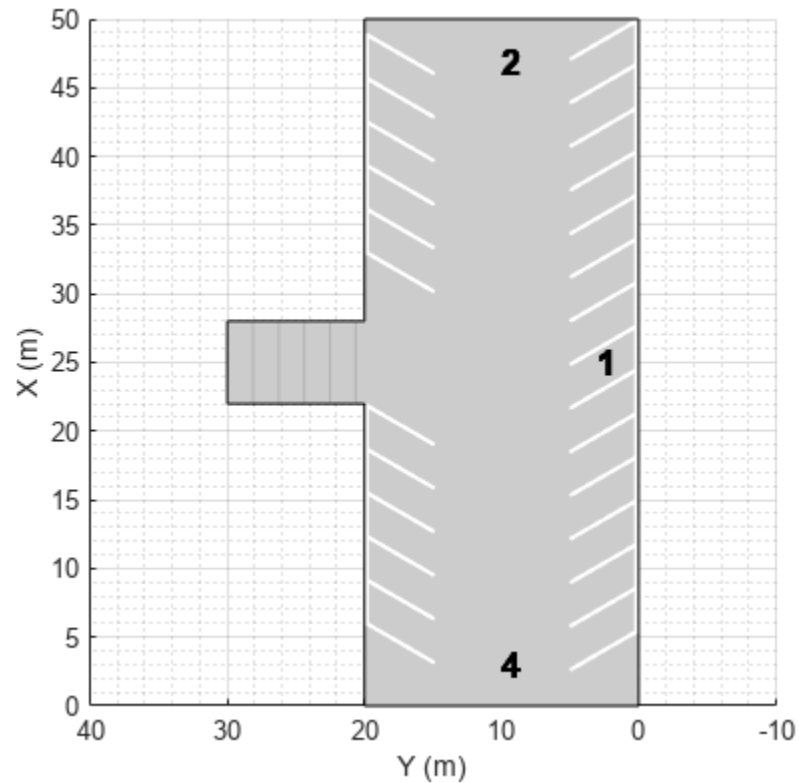

Create Parking Lot Using Predefined Layout

Explore the various parking lots that you can create by using predefined layouts as well as the options for configuring those layouts.

Define the parking space used to populate the parking lot. Modify the width, length, or angle of the space and the width and strength of its lane markings. Plot the parking space.

```
width = 2.6  ; % m
length = 5.5  ; % m
angle = 90  ; % deg
markingWidth = 0.15  ;
markingStrength = 1  ;

space = parkingSpace(Width=width, ...
                    Length=length, ...
                    Angle=angle, ...
                    MarkingWidth=markingWidth, ...
                    MarkingStrength=markingStrength);

plot(space)
```

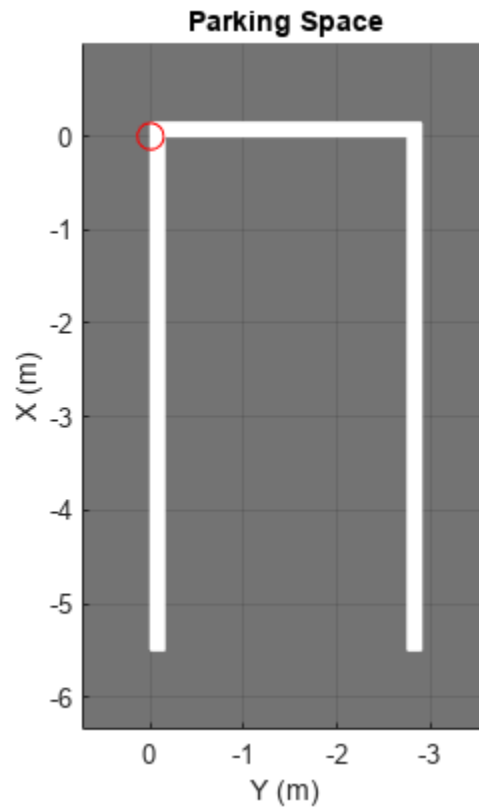

Create a driving scenario containing a 50-by-50 meter parking lot. Specify a predefined parking lot layout and a minimum driving lane width. The generated parking lot fills with as many parking spaces that fit the layout as possible given the minimum driving lane width constraint. Modify the parking space, layout type, and driving lane width, and observe the effects on the parking lot. For example:

- As you increase the size of the parking space or the minimum driving lane width, the number of parking grids that fit in the middle of the parking lot decreases.
- If you select the `HorizontalWithEdges` or `VerticalWithEdges` layout, one edge has fewer spaces than the others. This edge contains a driving lane of width `DrivingLaneWidth` that enables vehicles to enter the parking lot.

```
scenario = drivingScenario;
vertices = [0 0; 50 0; 50 -50; 0 -50];
parkingLayout = "Vertical";
drivingLaneWidth = 2.6 ; % m
parkingLot(scenario,vertices, ...
    ParkingSpace=space, ...
    ParkingLayout=parkingLayout, ...
    DrivingLaneWidth=drivingLaneWidth);
plot(scenario)
```

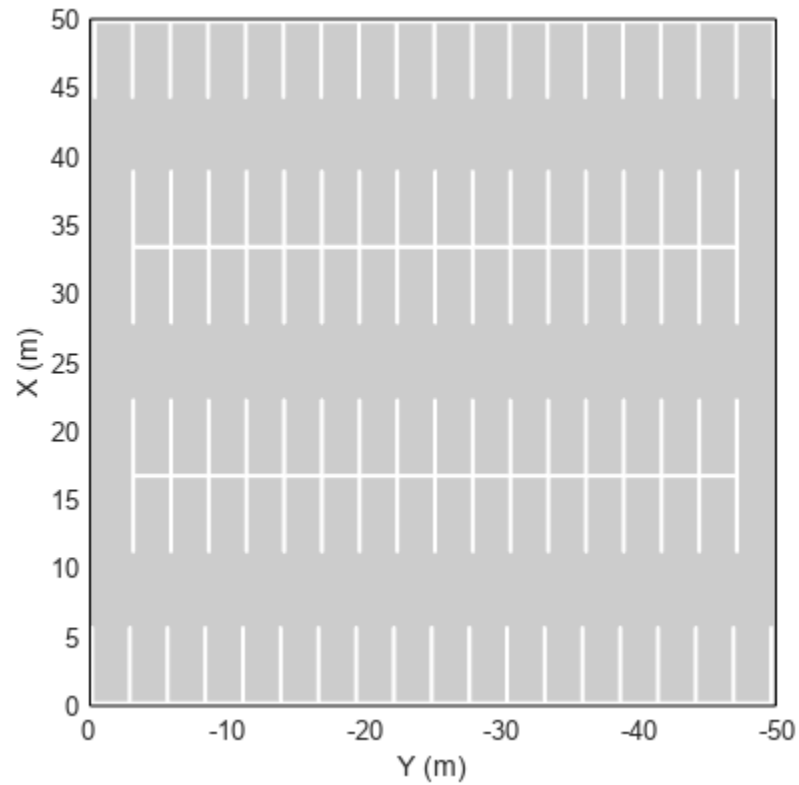

Create Parking Lot Containing Grid at Specific Position and Orientation

Create a driving scenario containing a 50-meter road and a 20-by-30 meter parking lot. Plot the scenario.

```
scenario = drivingScenario;
roadcenters = [0 50; 50 0];
road(scenario,roadcenters);

vertices = [40 10; 25 -5; 5 15; 20 30];
lot = parkingLot(scenario,vertices);
plot(scenario)
```

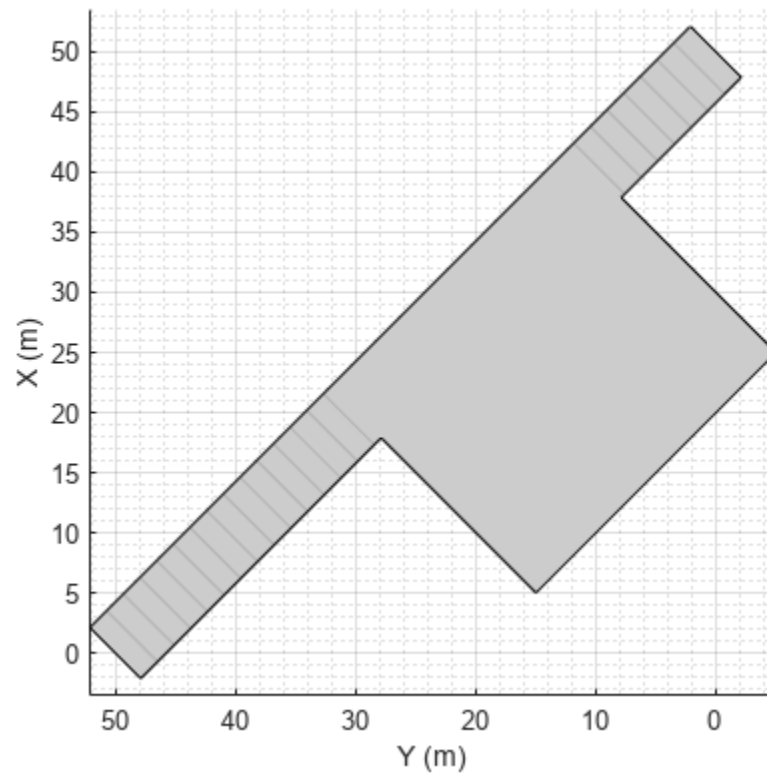

Insert a parking grid into the lot. Specify a grid with two rows of eight spaces. Use the default parking space dimensions, and place the grid at a 45-degree angle to align it with the road.

```
space = parkingSpace;  
numSpaces = 8;  
insertParkingSpaces(lot, space, numSpaces, Rows=2, Position=[15 20], Orientation=45)
```

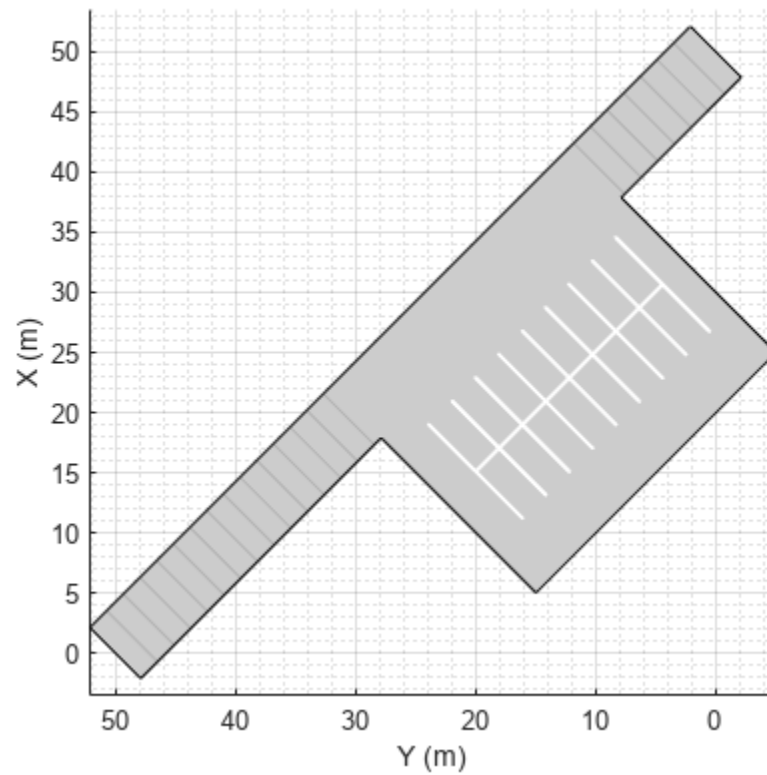

Create Parking Lot Containing Multiple Space Types

Create a parking lot that contains a mixture of parking spaces, no-parking areas, and accessible spaces.

Define the parking space to use in the parking lot. Use the default settings. Plot the space.

```
space = parkingSpace;  
plot(space, Origin="off")
```

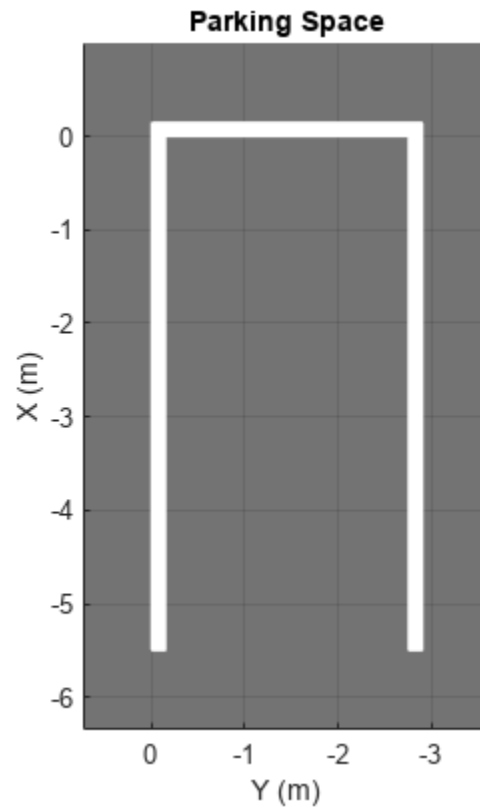

Define the no-parking areas to use in the parking lot. Specify a color of white and a width that is one meter less than the width of the default parking space. Plot the space.

```
noSpace = parkingSpace(Type="NoParking",Width=(space.Width - 1),MarkingColor="White");  
plot(noSpace,Origin="off")
```

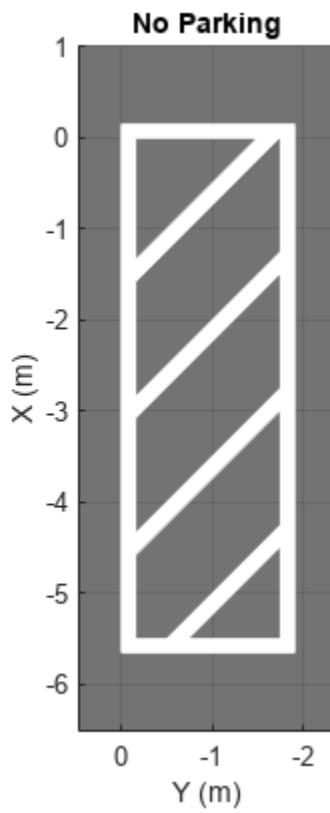
Define the accessible parking space to use in the parking lot. Specify a width that is one meter more than the width of the default parking space. Plot the space.

```
accessibleSpace = parkingSpace(Type="Accessible",Width=(space.Width + 1));  
plot(accessibleSpace,Origin="off")
```

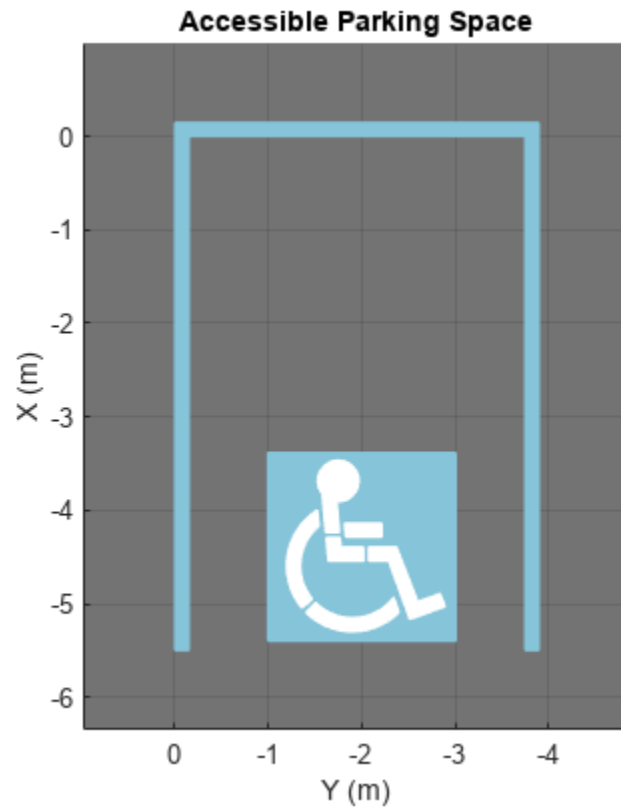

Create a driving scenario containing a parking lot with a nonrectangular layout. Plot the parking lot and display the edge numbers along which you can add parking spaces.

```
scenario = drivingScenario;  
vertices = [0 0; 32 -10.5; 32 -50.5; 25 -57.5; 0 -57.5];  
lot = parkingLot(scenario,vertices);  
plot(scenario,ParkingLotEdges="on")
```

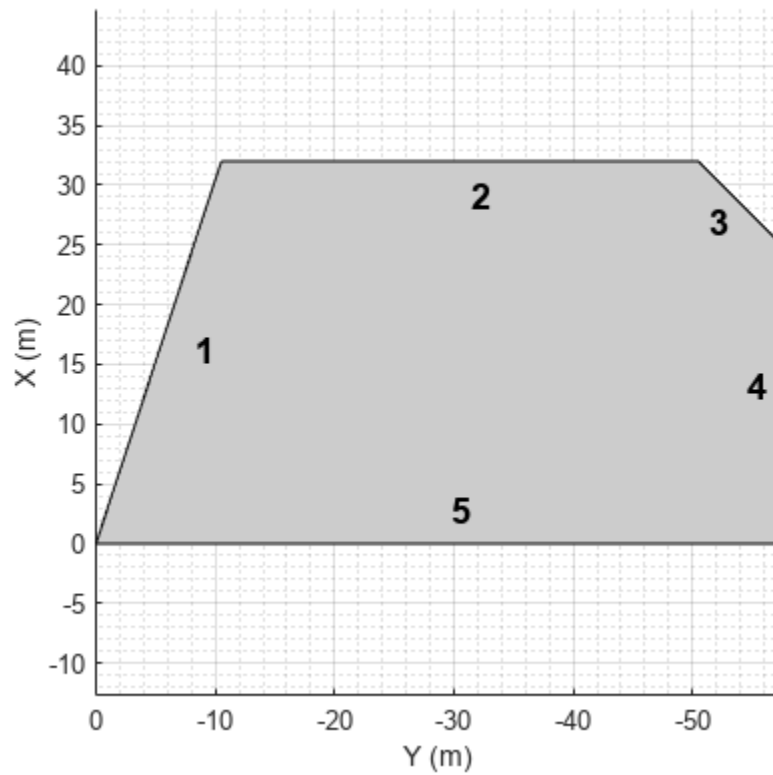

Insert default parking spaces along the first three edges of the parking lot. To avoid overlapping parking spaces, make these adjustments to the insertions:

- Along edge 1, insert only 10 spaces.
- Along edge 2, offset the spaces by 5 meters from the first vertex of the edge.
- Along edge 3, offset the spaces by 3 meters from the first vertex of the edge.

```
numSpaces = 10;  
insertParkingSpaces(lot,space,numSpaces,Edge=1)  
insertParkingSpaces(lot,space,Edge=2,Offset=5)  
insertParkingSpaces(lot,space,Edge=3,Offset=3)
```

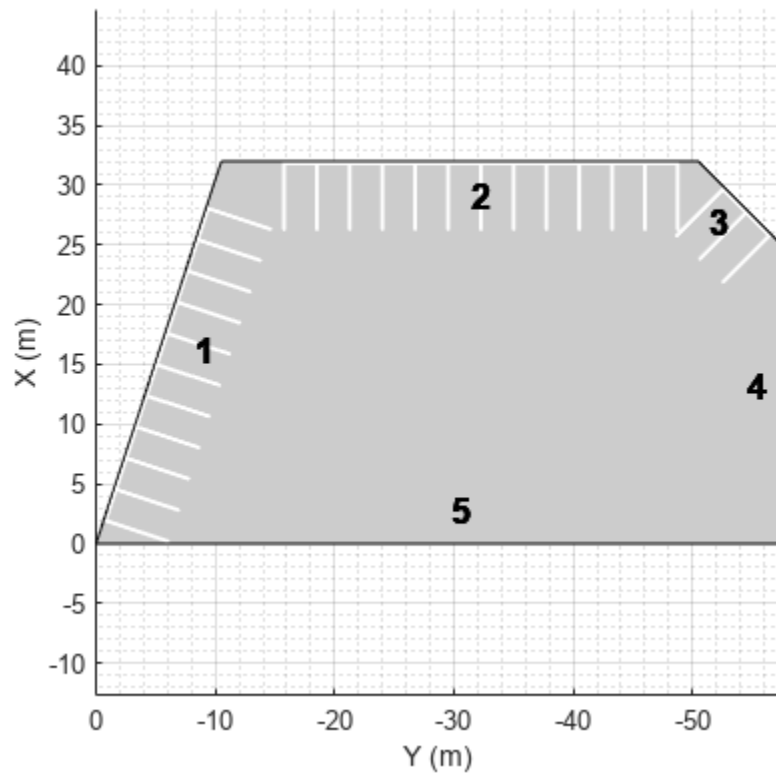

In the center of the parking lot, insert a 2-by-10 grid of parking spaces containing 8 columns of default spaces, 1 column of no-parking areas, and 1 column of accessible spaces.

```
insertParkingSpaces(lot,[space noSpace accessibleSpace],[8 1 1],Position=[12 -18],Rows=2)
```

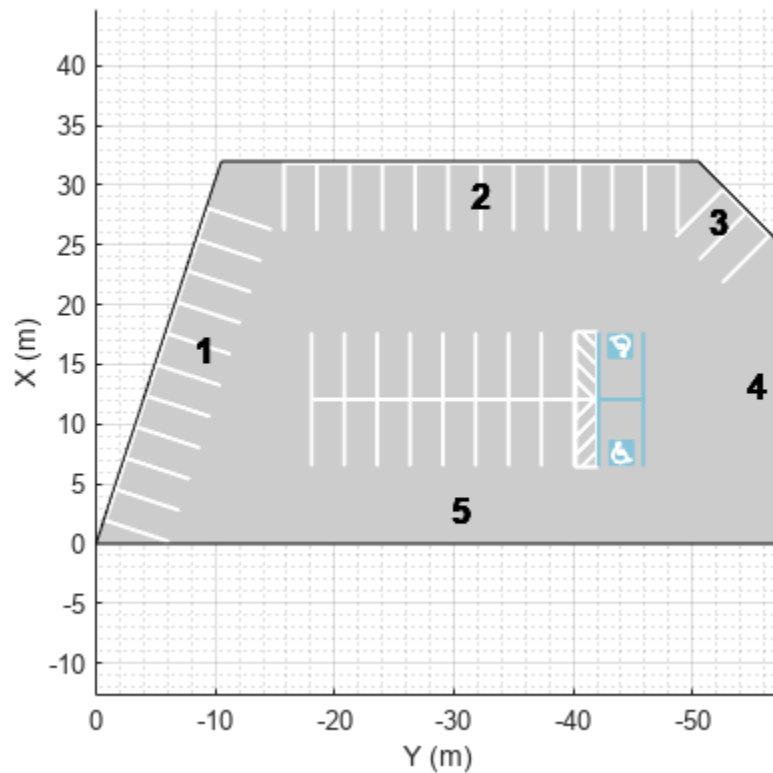

Simulate Car Backing into Parking Space

Simulate a driving scenario in which a car drives in reverse to back into a parking space.

Create a driving scenario containing a parking lot.

```
scenario = drivingScenario;
vertices = [0 9; 18 9; 18 -9; 0 -9];
parkingLot(scenario, vertices, ParkingSpace=parkingSpace);
```

Create a car and define its trajectory. The car drives forward, stops, and then drives in reverse to back into the parking space. As the car enters the parking space, it has a yaw orientation angle that is 90 degrees counterclockwise from where it started.

```
car = vehicle(scenario, ClassID=1);
waypoints = [9 -5; 9 5; 6 -1.3; 2 -1.3];
speed = [3; 0; -2; 0];
yaw = [90 90 180 180];
smoothTrajectory(car, waypoints, speed, Yaw=yaw)
```

Plot the driving scenario and display the waypoints of the trajectory.

```
plot(scenario, Waypoints="on")
while advance(scenario)
```

```

    pause(0.001)
end

```

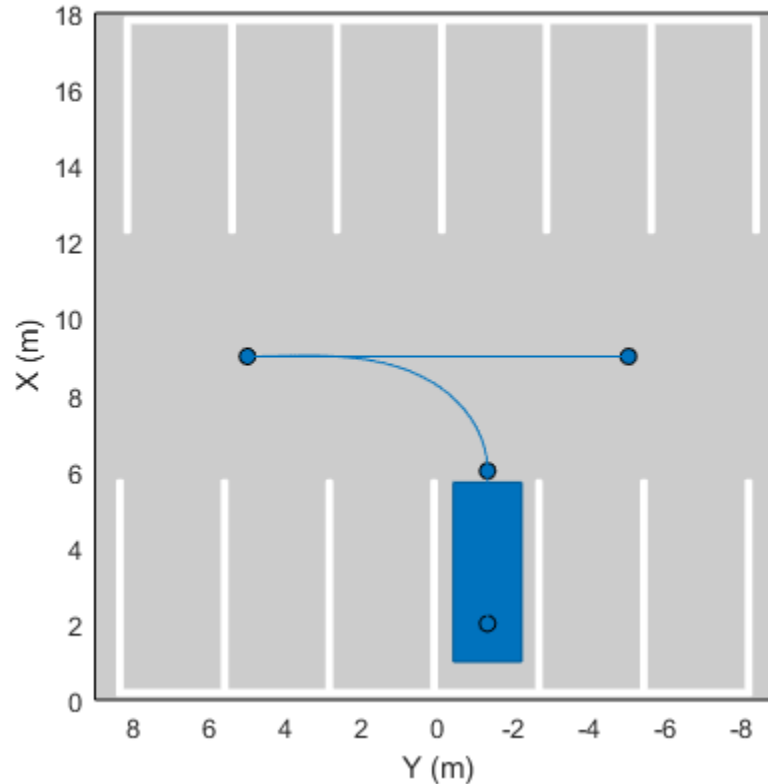

Generate Detections of Cars in Parking Lot

Generate detections of cars parked in a parking lot, and plot the detections on a bird's-eye plot.

Create a driving scenario containing a road and parking lot.

```

scenario = drivingScenario;
roadcenters = [10 40; 10 -40];
road(scenario,roadcenters);
vertices = [0 20; 20 20; 20 -20; 0 -20];
parkingLot(scenario,vertices,ParkingSpace=parkingSpace);

```

Add an ego vehicle and specify a trajectory in which the vehicle drives through the parking lot.

```

ego = vehicle(scenario);
waypoints = [10 35 0; 10 10 0];
speed = 5; % m/s
smoothTrajectory(ego,waypoints,speed)

```

Create parked cars in several parking spaces. Plot the scenario.

```

parkedCar1 = vehicle(scenario,Position=[15.8 12.4 0]);
parkedCar2 = vehicle(scenario,Position=[15.8 -12.4 0]);

```

```

parkedCar3 = vehicle(scenario,Position=[2 -9.7 0]);
parkedCar4 = vehicle(scenario,Position=[2 9.7 0]);
plot(scenario)

```

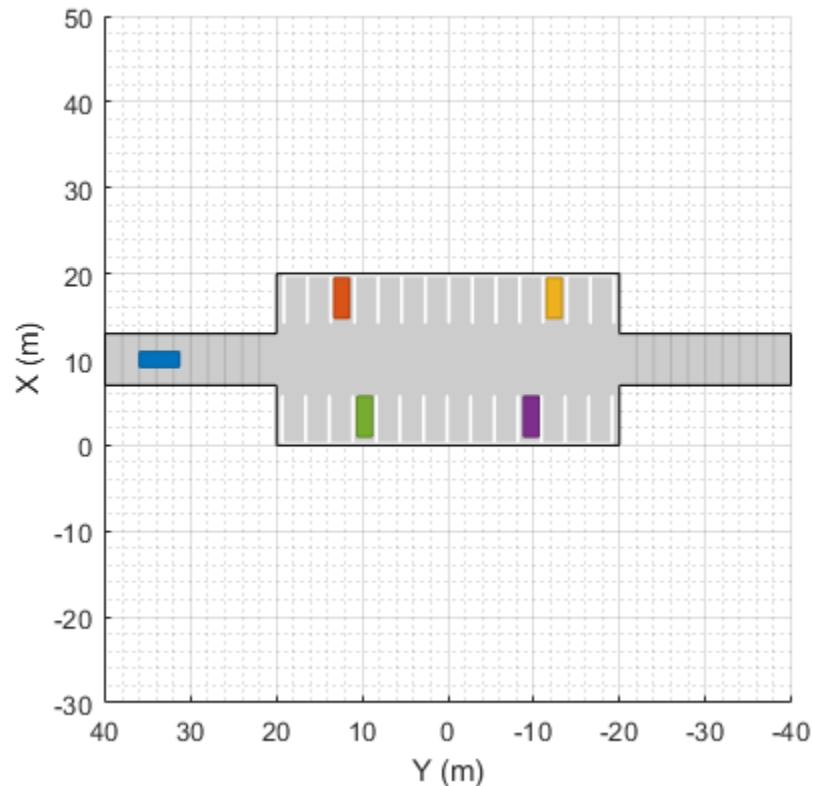

Create a vision sensor for generating the detections. By default, the sensor is mounted to the front bumper of the ego vehicle.

```
sensor = visionDetectionGenerator;
```

Create a bird's-eye plot and plotters for visualizing the target outlines, road boundaries, parking lane markings, sensor coverage area, and detections. Then, simulate the scenario and generate the detections.

```

bep = birdsEyePlot(XLim=[-40 40],YLim=[-30 30]);
olPlotter = outlinePlotter(bep);
lbPlotter = laneBoundaryPlotter(bep);
lmPlotter = laneMarkingPlotter(bep,DisplayName="Parking lanes");
caPlotter = coverageAreaPlotter(bep,DisplayName="Coverage area");
detPlotter = detectionPlotter(bep,DisplayName="Detections");

```

```
while advance(scenario)
```

```
    % Plot target outlines.
```

```
    [position,yaw,length,width,originOffset,color] = targetOutlines(ego);
    plotOutline(olPlotter,position,yaw,length,width)
```

```
    % Plot lane boundaries of ego vehicle.
```

```
    rbEgo = roadBoundaries(ego);
```

```

plotLaneBoundary(lbPlotter,rbEgo)

% Plot parking lane markings.
[plmv,plmf] = parkingLaneMarkingVertices(ego);
plotParkingLaneMarking(lmPlotter,plmv,plmf)

% Plot sensor coverage area.
mountPosition = sensor.SensorLocation;
range = sensor.MaxRange;
orientation = sensor.Yaw;
fieldOfView = sensor.FieldOfView(1);
plotCoverageArea(caPlotter,mountPosition,range,orientation,fieldOfView)

% Generate and plot detections.
actors = targetPoses(ego);
time = scenario.SimulationTime;
[dets,isValidTime] = sensor(actors,time);
if isValidTime
    positions = cell2mat(cellfun(@(x)([x.Measurement(1) x.Measurement(2)]), ...
        dets,UniformOutput=false));
    plotDetection(detPlotter,positions)
end
end

```

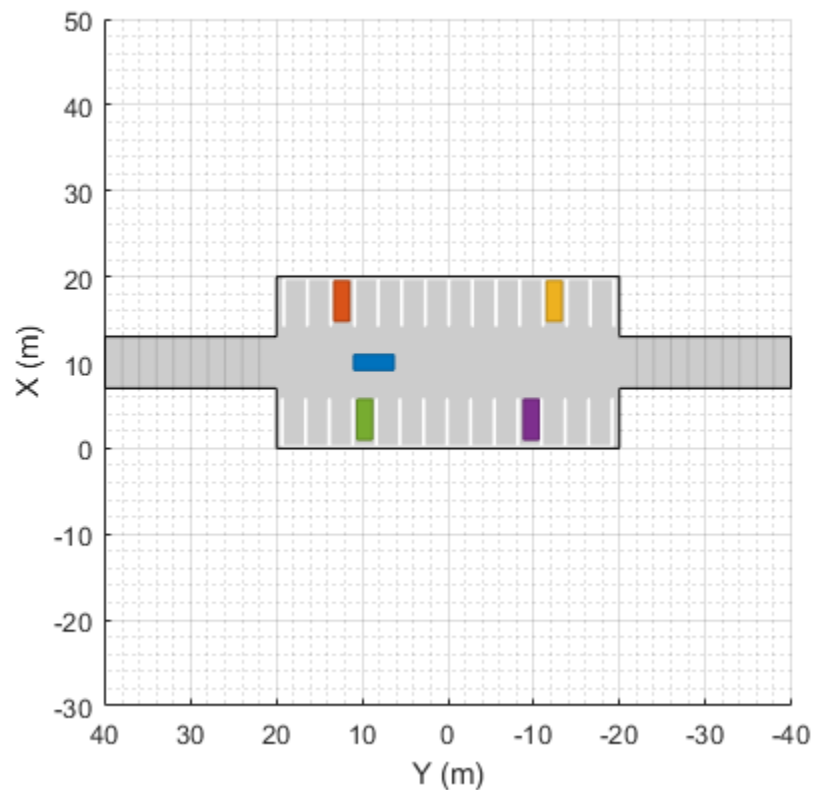

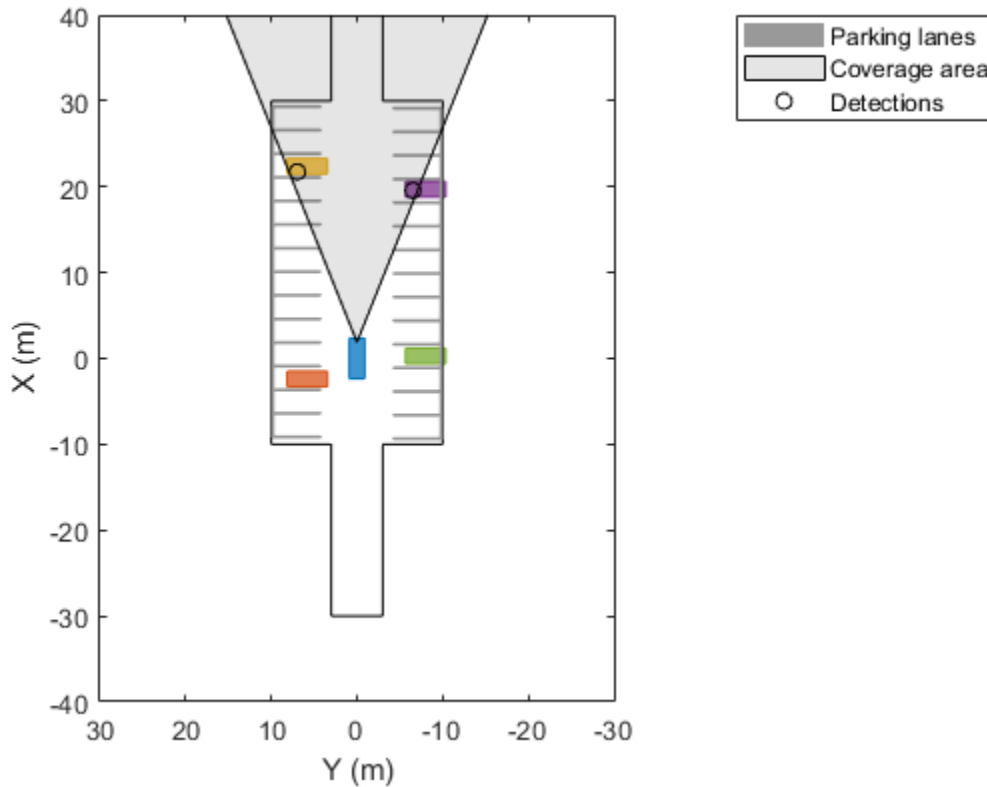

Input Arguments

scenario — Driving scenario

`drivingScenario` object

Driving scenario, specified as a `drivingScenario` object.

vertices — Parking lot vertices

real-valued N -by-2 matrix | real-valued N -by-3 matrix

Parking lot vertices, specified as an N -by-2 or N -by-3 real-valued matrix. N is the number of vertices, and each of the $N - 1$ segments between the vertices defines a parking lot edge. N must be greater than or equal to 3.

- If `vertices` is an N -by-2 matrix, then each matrix row represents the (x, y) coordinate of a vertex. The z -coordinate of each vertex is 0.
- If `vertices` is an N -by-3 matrix, then each matrix row represents the (x, y, z) coordinate of a vertex.

Vertices are in the world coordinate system of the driving scenario.

This argument sets the `Vertices` property of the parking lot. To view the properties of a parking lot, either access the `ParkingLots` property of `scenario`, or return the parking lot by specifying the `lot` output argument.

Example: `[0 0; 0 20; 20 20; 20 0]`

Example: [0 0 0; 0 20 5; 20 20 5; 20 0 0]

Name-Value Pair Arguments

Specify optional pairs of arguments as `Name1=Value1, . . . , NameN=ValueN`, where `Name` is the argument name and `Value` is the corresponding value. Name-value arguments must appear after other arguments, but the order of the pairs does not matter.

Example: `ParkingSpace=parkingSpace, ParkingLayout="Horizontal"` populates a parking lot with the default parking space in a horizontal layout.

ParkingSpace — Parking space

`parkingSpace` object

Parking space used to populate the parking lot, specified as a `parkingSpace` object. To specify the type of layout used to populate the parking lot with spaces, use the `ParkingLayout` name-value argument.

You can specify `ParkingSpace` only for rectangular parking lots. To add parking spaces to nonrectangular parking lots, use the `insertParkingSpaces` function.

ParkingLayout — Parking lot layout

"Vertical" (default) | "Horizontal" | "VerticalWithEdges" | "HorizontalWithEdges"

Parking lot layout, specified as "Vertical", "Horizontal", "VerticalWithEdges", or "HorizontalWithEdges".

To use this argument, you must specify the `ParkingSpace` name-value argument. The `parkingLot` function adds as many spaces of space `ParkingSpace` that fit the layout as possible, given the minimum driving width specified by `DrivingLaneWidth`.

This table describes the `ParkingLayout` options.

Option	Description
"Vertical"	<p data-bbox="865 300 1393 331">Lay out parking spaces from top to bottom.</p>  A diagram illustrating a vertical parking layout. It shows a rectangular area divided into three horizontal rows. Each row contains 12 vertical lines representing parking spaces. The spaces are arranged in a grid pattern, with two horizontal lines separating the rows. The entire diagram is set against a light gray background.
"Horizontal"	<p data-bbox="865 999 1365 1031">Lay out parking spaces from left to right.</p>  A diagram illustrating a horizontal parking layout. It shows a rectangular area divided into three vertical columns. Each column contains 12 horizontal lines representing parking spaces. The spaces are arranged in a grid pattern, with two vertical lines separating the columns. The entire diagram is set against a light gray background.

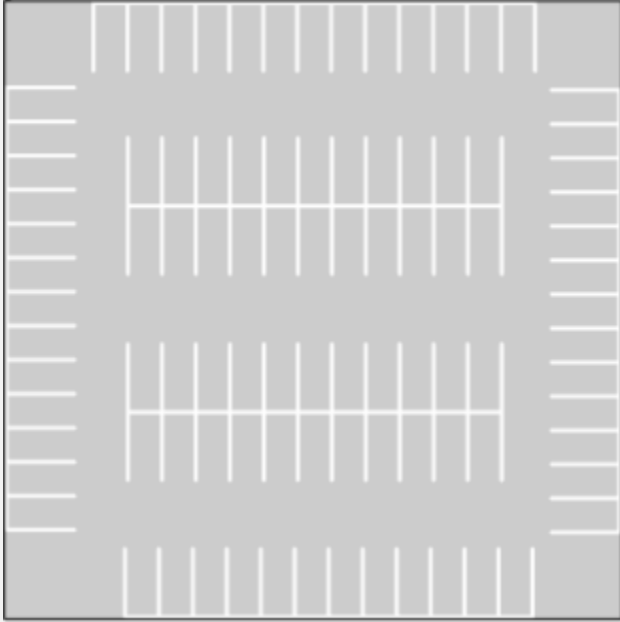
Option	Description
<p>"VerticalWithEdges"</p>	<p>Lay out parking spaces from top to bottom and also insert parking spaces along the left and right edges. To enable vehicles to enter the parking lot, the bottom edge contains a driving lane with a width of <code>DrivingLaneWidth</code> meters.</p> 

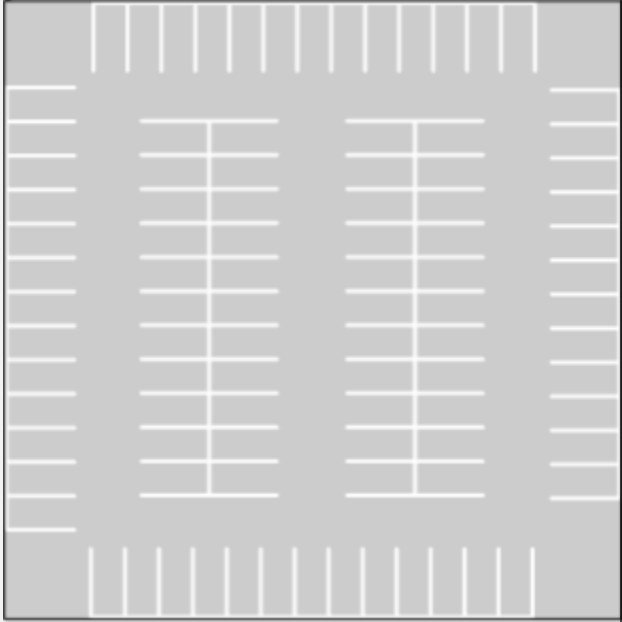
Option	Description
"HorizontalWithEdges"	<p>Lay out parking spaces from left to right and also insert parking spaces along the top and bottom edges. To enable vehicles to enter the parking lot, the right edge contains a driving lane with a width of <code>DrivingLaneWidth</code> meters.</p> 

Data Types: char | string

DrivingLaneWidth — Minimum width of driving lanes (m)

real scalar in range [0, 50]

Minimum width of driving lanes in the parking lot, in meters, specified as a real scalar in the range [0, 50]. To use this argument, you must specify the `ParkingSpace` name-value argument. The `parkingLot` function uses `DrivingLaneWidth` to determine the amount of space to add on either side of the parking grids. By default, `DrivingLaneWidth` is equal to the width of the space specified by `ParkingSpace`.

To enforce the symmetrical arrangement of the parking grids, the actual width of driving lanes might be greater than `DrivingLaneWidth`. For example, in this parking lot, the horizontal width, W_H , is equal to `DrivingLaneWidth`, but the vertical width, W_V , is slightly greater than `DrivingLaneWidth`. The extra vertical width enables the even distribution of the parking grids in the lot along the vertical axis

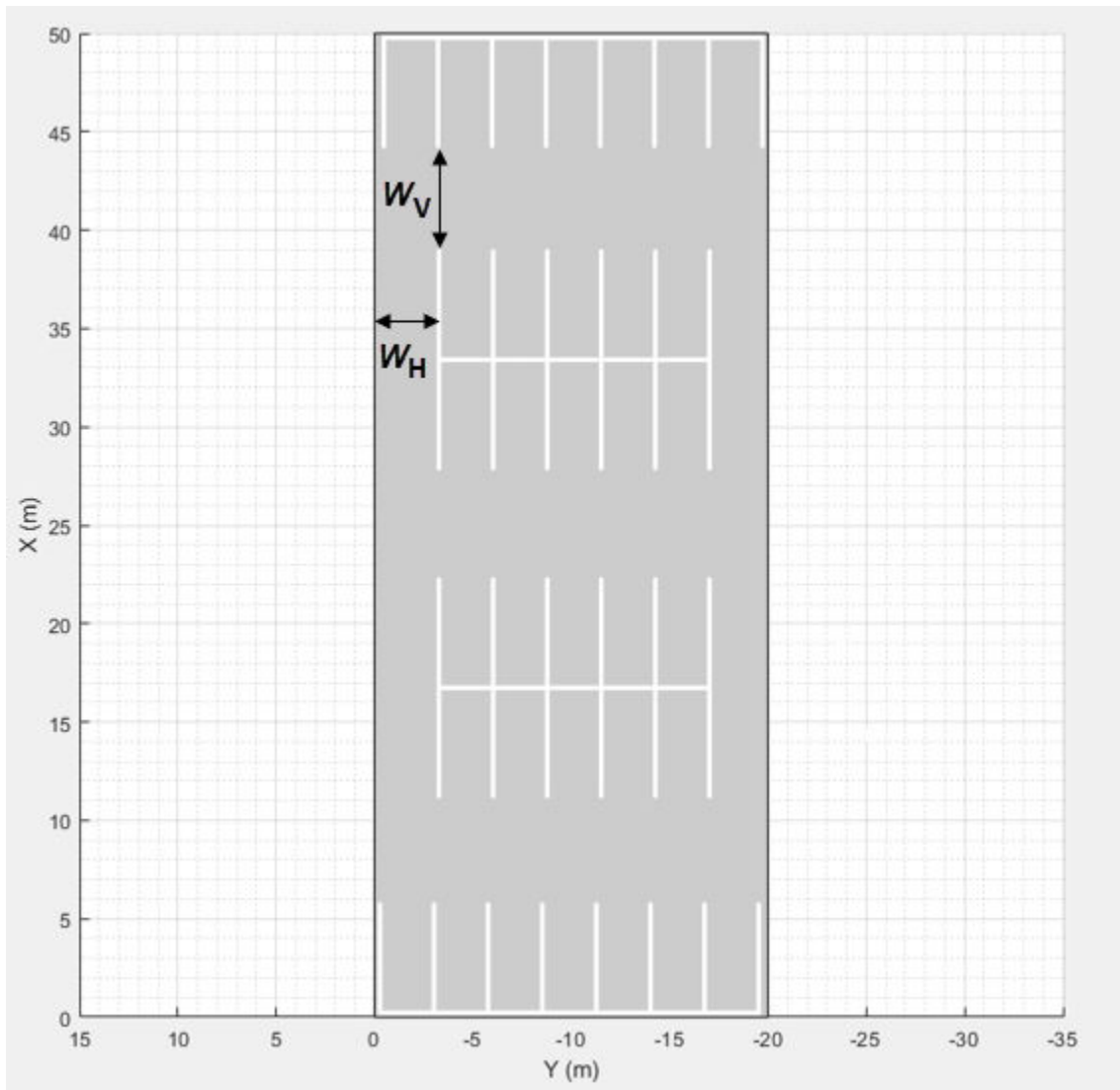

Name — Parking lot name

' ' (default) | character vector | string scalar

Parking lot name, specified as a character vector or string scalar. This argument sets the Name property of the parking lot. To view this property in a parking lot, either access the ParkingLots property of scenario or return the parking lot by specifying the lot output argument.

Data Types: char | string

Output Arguments

lot — Output parking lot

ParkingLot object

Output parking lot, returned as a ParkingLot object that has the properties described in this table. With the exception of RoadID, which is a scenario-generated property, the property names correspond to the input arguments used to create the parking lot. All properties are read-only.

Property	Value
Vertices	<p>Parking lot vertices, specified as a real-valued N-by-3 matrix, where N is the number of vertices.</p> <p>The <code>vertices</code> input argument sets this property. If you specify <code>vertices</code> as an N-by-2 matrix, then the third value (z-value) of each matrix row of <code>Vertices</code> is 0. The stored <code>Vertices</code> are of the same data type as the input <code>vertices</code>.</p>
RoadID	<p>Parking lot identifier, specified as a positive integer.</p> <p>The input <code>drivingScenario</code> object specified by <code>scenario</code> generates a unique ID for each road and parking lot in the driving scenario. Driving scenarios treat a parking lot as a road, because it forms junctions when it intersects with other roads.</p>
Name	<p>Parking lot name, specified as a string scalar.</p> <p>The <code>Name</code> name-value argument sets this property. Even if you specify this argument as a character vector, the <code>Name</code> property value is a string scalar.</p>

To insert parking spaces into this parking lot, specify `lot` as an input argument of the `insertParkingSpaces` function.

Limitations

- The importing of parking lot data from external sources by using the `roadNetwork` function is not supported.
- The importing of parking lots into the **Driving Scenario Designer** app is not supported. If you open a scenario containing a parking lot in the app, the app omits the parking lot from the scenario.
- The importing of parking lots into Simulink is not supported. If you read a scenario containing a parking lot into Simulink by using the Scenario Reader block, the block omits the parking lot from the Simulink model.
- Sensor detections of parking lane markings are not supported. However, you can visualize parking lane markings on a `birdsEyePlot` object by using the `plotParkingLaneMarking` function.

Version History

Introduced in R2021b

See Also

`parkingSpace` | `insertParkingSpaces` | `plotParkingLaneMarking` | `parkingLaneMarkingVertices` | `drivingScenario` | `road`

Topics

“Simulate Vehicle Parking Maneuver in Driving Scenario”

insertParkingSpaces

Package:

Insert parking spaces into parking lot

Syntax

```
insertParkingSpaces(lot, space, numSpaces, Position=position)
insertParkingSpaces( ____, Name=Value)
```

```
insertParkingSpaces(lot, space, Edge=edge)
insertParkingSpaces(lot, space, numSpaces, Edge=edge)
insertParkingSpaces( ____, Edge=edge, Name=Value)
```

Description

The `insertParkingSpaces` function inserts a grid of parking spaces into a parking lot at a specified position or along specified edges.

- To insert spaces at a specified position, use the `Position` name-value argument.
- To insert spaces along specified edges, use the `Edge` name-value argument.

To use this function, you must specify either `Position` or `Edge`, but you cannot specify both.

Insert Spaces at Specified Position

`insertParkingSpaces(lot, space, numSpaces, Position=position)` inserts a one-row parking grid containing `numSpaces` spaces of type `space` into a parking lot, `lot`. The function inserts the grid at the specified `xy`-position in meters.

`insertParkingSpaces(____, Name=Value)` sets options using name-value arguments, in addition to the input arguments from the previous syntax. You can specify `Position` and the other name-value arguments in any order after the other input arguments.

Example: `insertParkingSpaces(lot, space, 8, Rows=2, Position=[25 25])` inserts a 2-by-8 grid of parking spaces into a parking lot at position (25, 25) in meters from the scenario origin.

Insert Spaces Along Specified Edges

`insertParkingSpaces(lot, space, Edge=edge)` inserts a one-row grid of spaces of type `space` along the specified edges `edge` of a parking lot, `lot`. The function inserts as many spaces as fit the edges.

`insertParkingSpaces(lot, space, numSpaces, Edge=edge)` inserts `numSpaces` spaces along each specified edge.

`insertParkingSpaces(____, Edge=edge, Name=Value)` sets options using name-value arguments, in addition to any combination of input arguments from previous syntaxes. You can specify `Edge` and the other name-value arguments in any order after the other input arguments.

Example: `insertParkingSpaces(lot, space, Edge=[1, 3], Offset=5)` inserts a row of parking spaces along edges 1 and 3 of a parking lot and offsets each row from its edge by 5 meters.

Examples

Create Parking Lot with Spaces Along Edges

Create a driving scenario containing a short road that enters into a parking lot that is 50 meters long and 20 meters wide. Plot the parking lot and display the edge numbers along which you can insert parking spaces. Because edge 3 forms a junction with the road, its edge number does not display on the plot, but you can still insert spaces along it.

```
scenario = drivingScenario;
roadcenters = [25 30; 25 15];
road(scenario, roadcenters);

vertices = [0 0; 50 0; 50 20; 0 20];
lot = parkingLot(scenario, vertices);
plot(scenario, ParkingLotEdges="On")
```

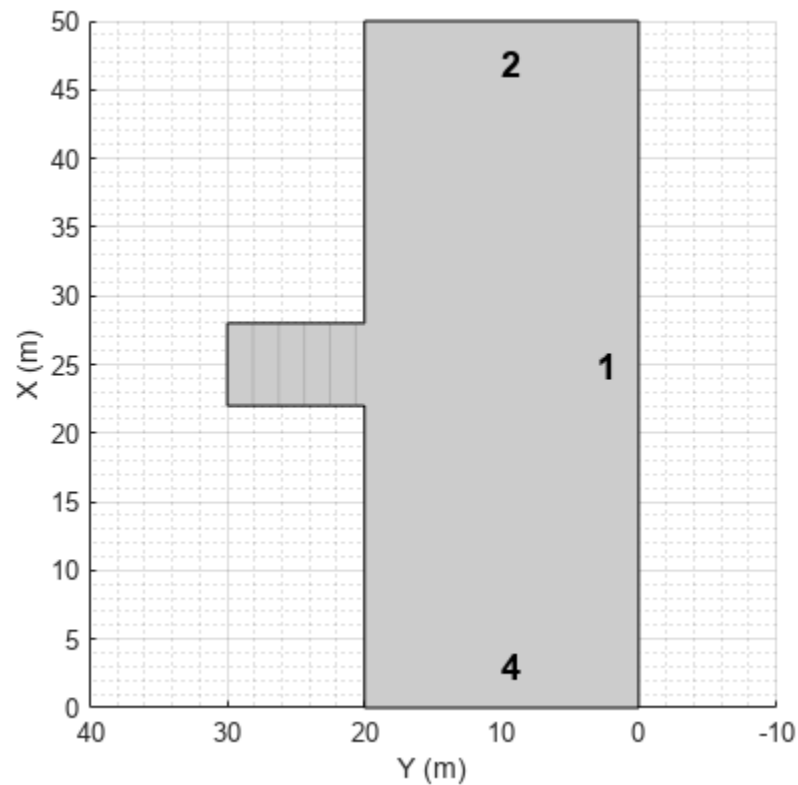

Define the parking space type to add along one of the edges. Set an angle of 60 degrees. Plot the parking space.

```
space = parkingSpace(Angle=60);
plot(space)
```

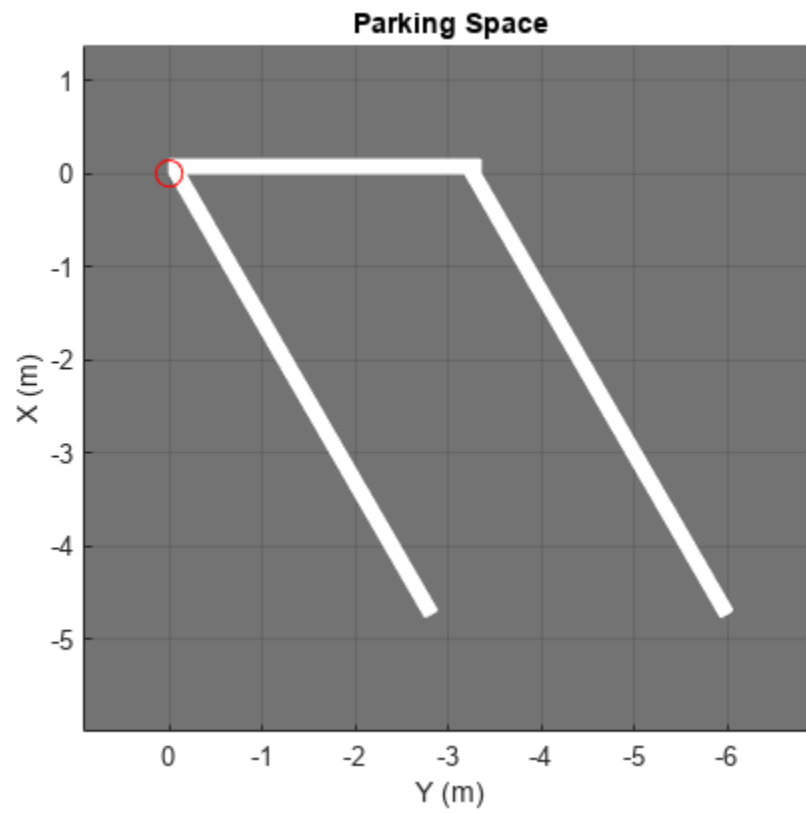

Insert the angled spaces along edge 1 of the parking lot.

```
insertParkingSpaces(lot,space,Edge=1)
```

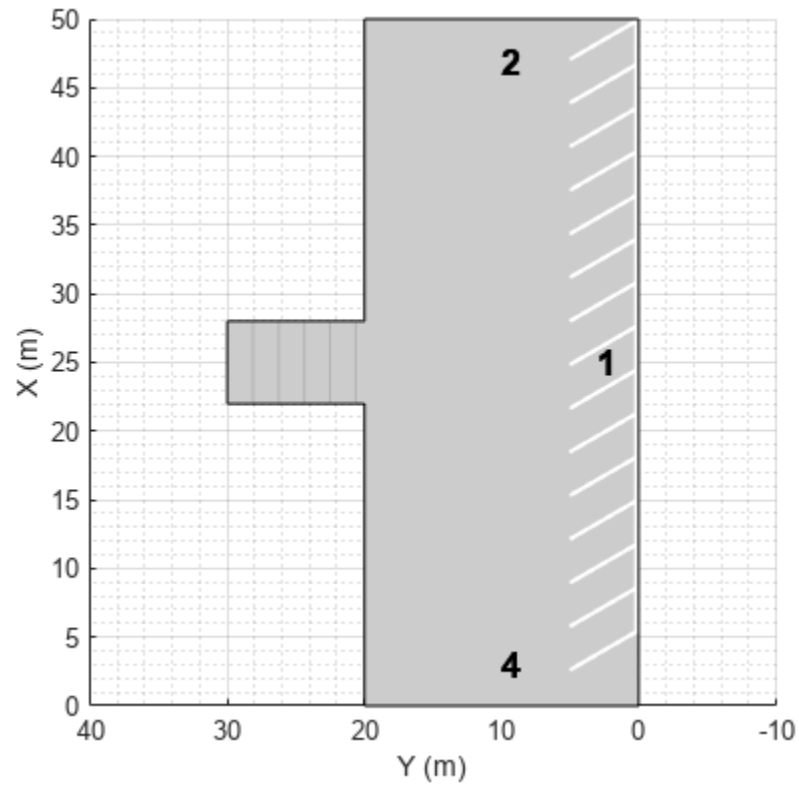

Insert angled spaces along edge 3: five above the junction and five below the junction. Offset these spaces by 3 meters and 30 meters from the bottom of edge 3, respectively. Reverse the angle of the spaces used along edge 1.

```
numSpaces = 5;
space = parkingSpace(Angle=120);
insertParkingSpaces(lot,space,numSpaces,Edge=3,Offset=3)
insertParkingSpaces(lot,space,numSpaces,Edge=3,Offset=30)
```

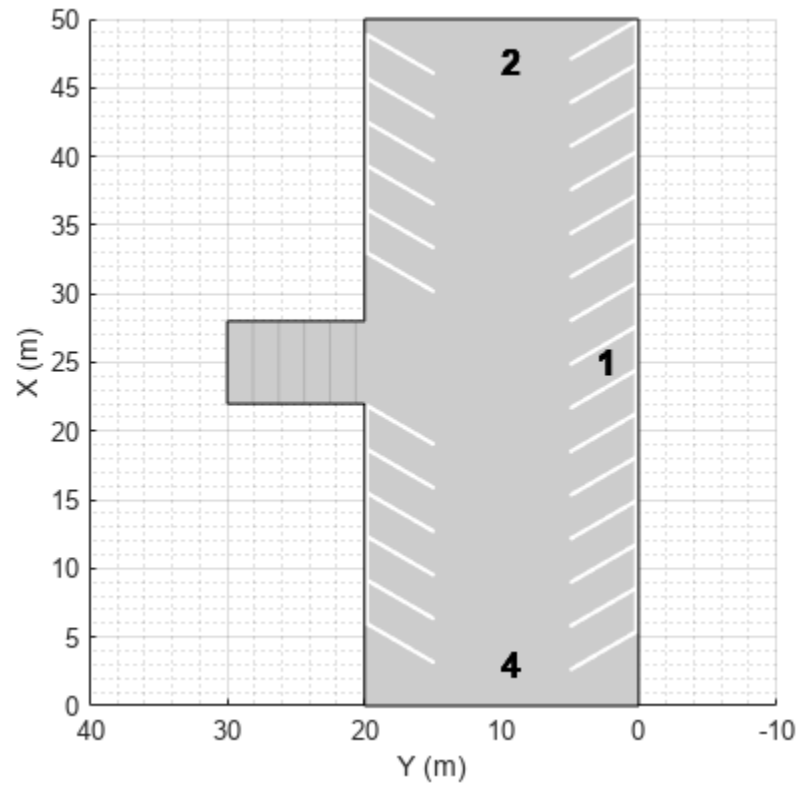

Create Parking Lot Containing Grid at Specific Position and Orientation

Create a driving scenario containing a 50-meter road and a 20-by-30 meter parking lot. Plot the scenario.

```
scenario = drivingScenario;
roadcenters = [0 50; 50 0];
road(scenario,roadcenters);

vertices = [40 10; 25 -5; 5 15; 20 30];
lot = parkingLot(scenario,vertices);
plot(scenario)
```

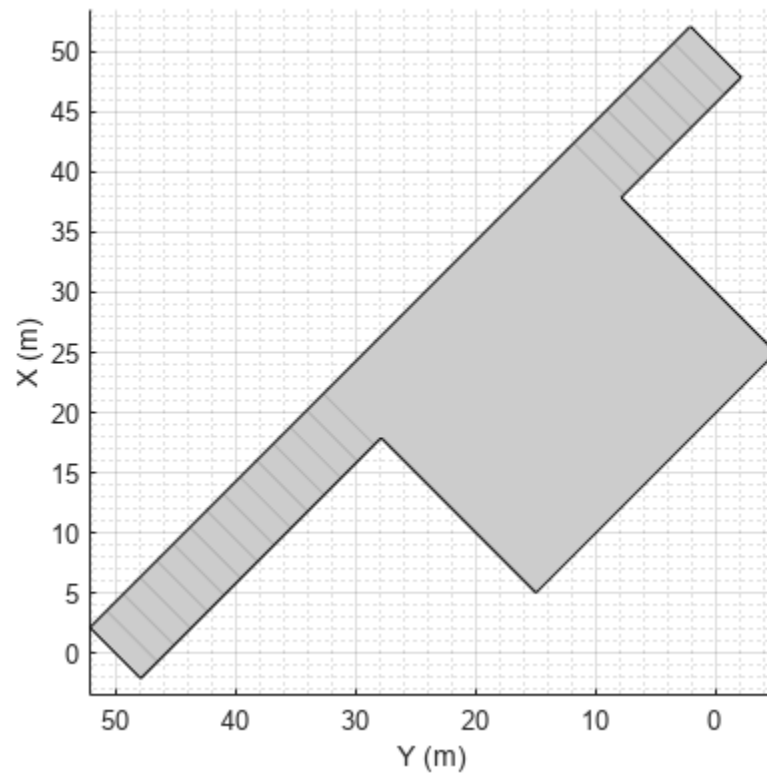

Insert a parking grid into the lot. Specify a grid with two rows of eight spaces. Use the default parking space dimensions, and place the grid at a 45-degree angle to align it with the road.

```
space = parkingSpace;  
numSpaces = 8;  
insertParkingSpaces(lot, space, numSpaces, Rows=2, Position=[15 20], Orientation=45)
```

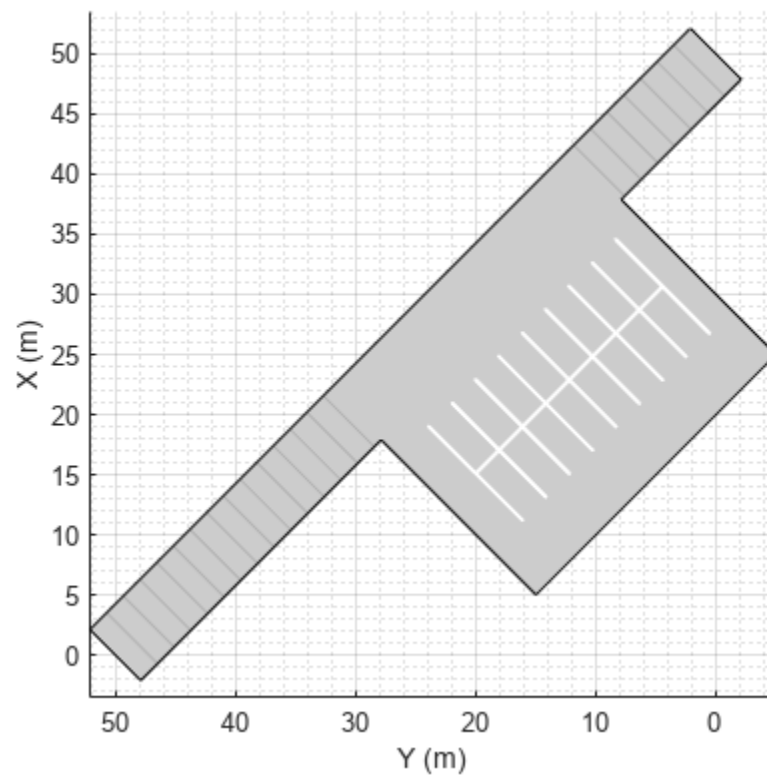

Create Parking Lot Containing Multiple Space Types

Create a parking lot that contains a mixture of parking spaces, no-parking areas, and accessible spaces.

Define the parking space to use in the parking lot. Use the default settings. Plot the space.

```
space = parkingSpace;  
plot(space, Origin="off")
```

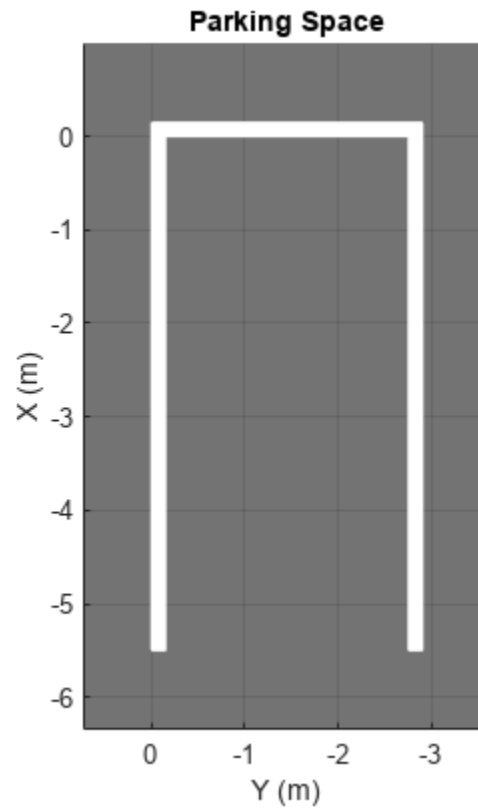

Define the no-parking areas to use in the parking lot. Specify a color of white and a width that is one meter less than the width of the default parking space. Plot the space.

```
noSpace = parkingSpace(Type="NoParking",Width=(space.Width - 1),MarkingColor="White");  
plot(noSpace,Origin="off")
```

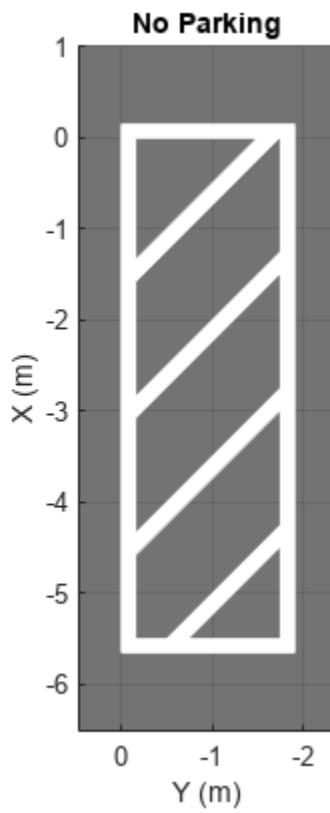
Define the accessible parking space to use in the parking lot. Specify a width that is one meter more than the width of the default parking space. Plot the space.

```
accessibleSpace = parkingSpace(Type="Accessible",Width=(space.Width + 1));  
plot(accessibleSpace,Origin="off")
```

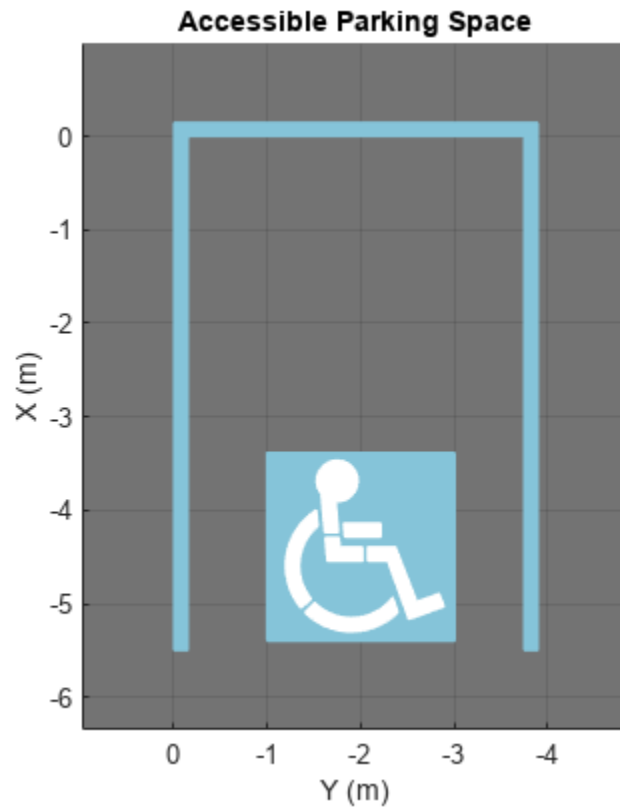

Create a driving scenario containing a parking lot with a nonrectangular layout. Plot the parking lot and display the edge numbers along which you can add parking spaces.

```
scenario = drivingScenario;  
vertices = [0 0; 32 -10.5; 32 -50.5; 25 -57.5; 0 -57.5];  
lot = parkingLot(scenario,vertices);  
plot(scenario,ParkingLotEdges="on")
```

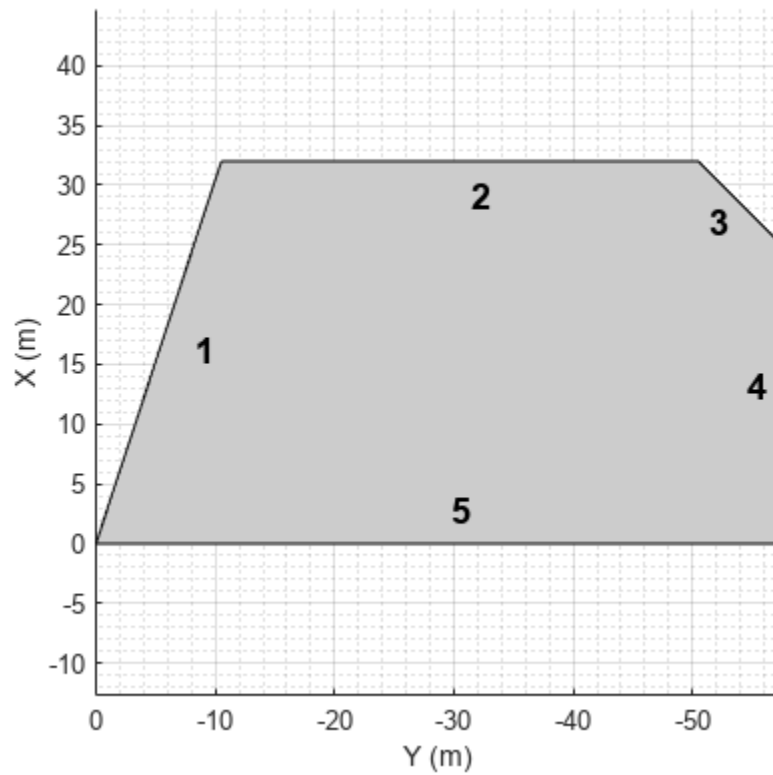

Insert default parking spaces along the first three edges of the parking lot. To avoid overlapping parking spaces, make these adjustments to the insertions:

- Along edge 1, insert only 10 spaces.
- Along edge 2, offset the spaces by 5 meters from the first vertex of the edge.
- Along edge 3, offset the spaces by 3 meters from the first vertex of the edge.

```
numSpaces = 10;  
insertParkingSpaces(lot,space,numSpaces,Edge=1)  
insertParkingSpaces(lot,space,Edge=2,Offset=5)  
insertParkingSpaces(lot,space,Edge=3,Offset=3)
```

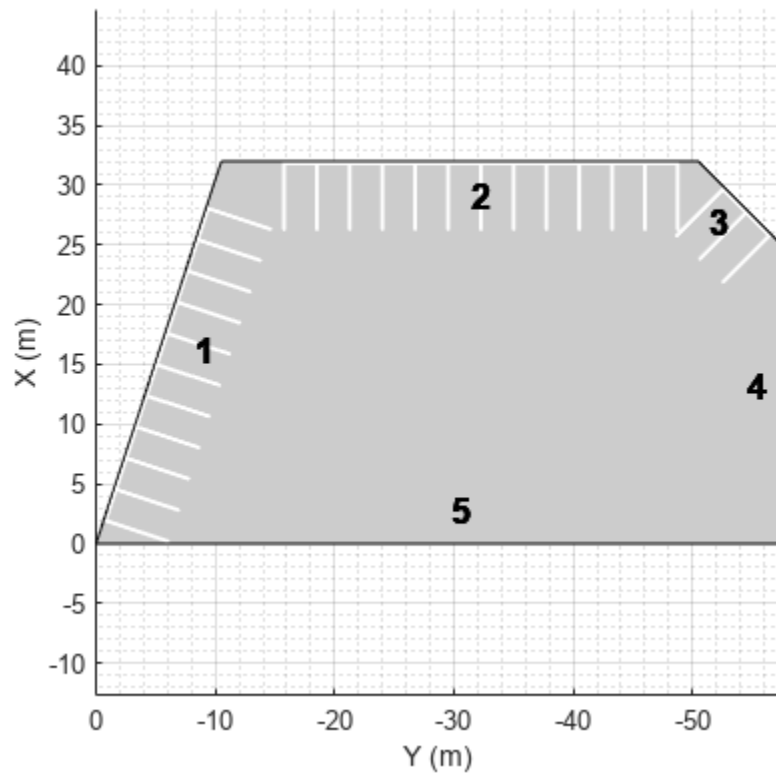

In the center of the parking lot, insert a 2-by-10 grid of parking spaces containing 8 columns of default spaces, 1 column of no-parking areas, and 1 column of accessible spaces.

```
insertParkingSpaces(lot,[space noSpace accessibleSpace],[8 1 1],Position=[12 -18],Rows=2)
```

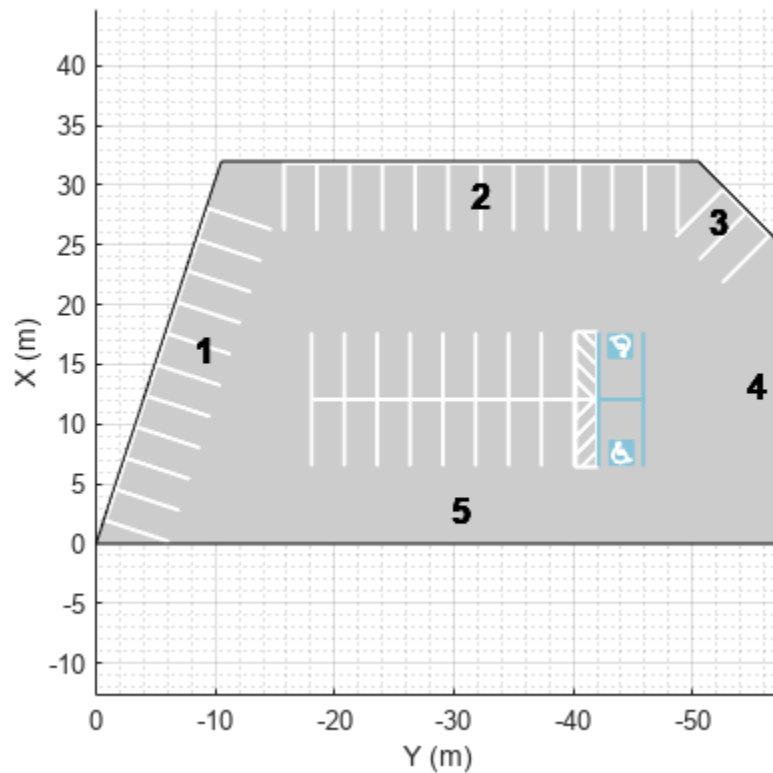

Input Arguments

lot — Parking lot

ParkingLot object

Parking lot in which to insert spaces, specified as a ParkingLot object. To create a parking lot, use the parkingLot function.

space — Parking spaces to insert

parkingSpace object | vector of parkingSpace objects

Parking spaces to insert, specified as a parkingSpace object or vector of parkingSpace objects.

space and numSpaces must contain the same number of elements. Each element of numSpaces specifies the number of parking spaces, of the type specified in the corresponding position of space, to include in the parking grid.

Example: [parkingSpace parkingSpace(Type="NoParking")
parkingSpace(Type="Accessible")]

numSpaces — Number of spaces in parking grid

positive integer | vector of positive integers

Number of spaces in the parking grid, specified as a positive integer or vector of positive integers.

space and numSpaces must contain the same number of elements. Each element of numSpaces specifies the number of parking spaces, of the type specified in the corresponding position of space, to include in the parking grid.

The inserted parking grid contains sum(numSpaces) parking spaces. If you specify more spaces than can fit the parking lot, then the inserted parking spaces extend past the parking lot border.

Example: [5 1 1]

position – Position at which to insert parking grid

row vector of form [x y]

Position at which to insert the parking grid, specified as a row vector of the form [x y] in meters from the scenario origin. The insertParkingSpaces function determines the elevation (z-value) of the parking grid based on the elevation of the input parking lot lot.

- For one-row parking grids (Rows=1), position specifies the upper-left corner of the parking grid.
- For two-row parking grids (Rows=2), position specifies the midpoint of the left-most parking lane marking.

This table shows sample positions for one-row and two-row parking grids.

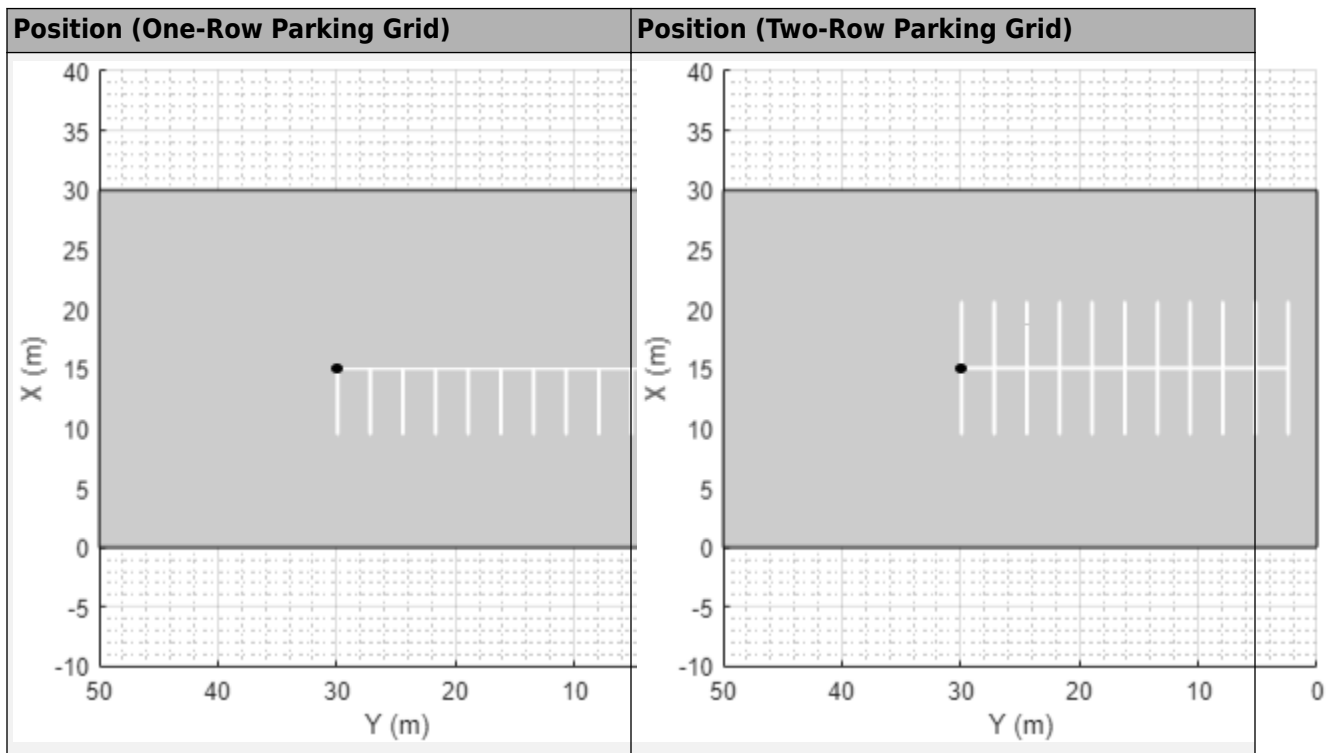

Example: [10 15]

edge – Edges along which to insert parking grid

positive integer | vector of positive integers

Edges along which to insert a parking grid, specified as a positive integer or vector of positive integers. Valid edge values are in the range [1, M], where M is the maximum number of edges in the parking lot. To view the edges along which you can insert a parking grid, use the plot function to

plot the driving scenario that contains the parking lot, lot, and turn parking lot edges on. Sample code:

```
plot(scenario, ParkingLotEdges="on")
```

Example: [2 4]

Name-Value Pair Arguments

Specify optional pairs of arguments as `Name1=Value1, ..., NameN=ValueN`, where `Name` is the argument name and `Value` is the corresponding value. Name-value arguments must appear after other arguments, but the order of the pairs does not matter.

Example: `insertParkingSpaces(lot, space, Orientation=45, Position=[50 35])` inserts a parking grid at a 45-degree angle at position (50, 35) in meters from the scenario origin.

Rows — Number of rows in parking grid

1 (default) | 2

Number of rows in the parking grid, specified as 1 or 2.

Dependencies

To use this argument, you must specify the `position` argument.

Orientation — Orientation of parking grid (deg)

0 (default) | nonnegative real scalar

Orientation of the parking grid, in degrees, specified as a nonnegative real scalar. Orientation is measured counterclockwise with respect to the horizontal axis of the parking grid.

- For one-row parking grids (`Rows=1`), the horizontal axis is the top edge of the grid.
- For two-row parking grids (`Rows=2`), the horizontal axis is the center line of the grid.

The table shows sample orientations for one-row and two-row parking grids.

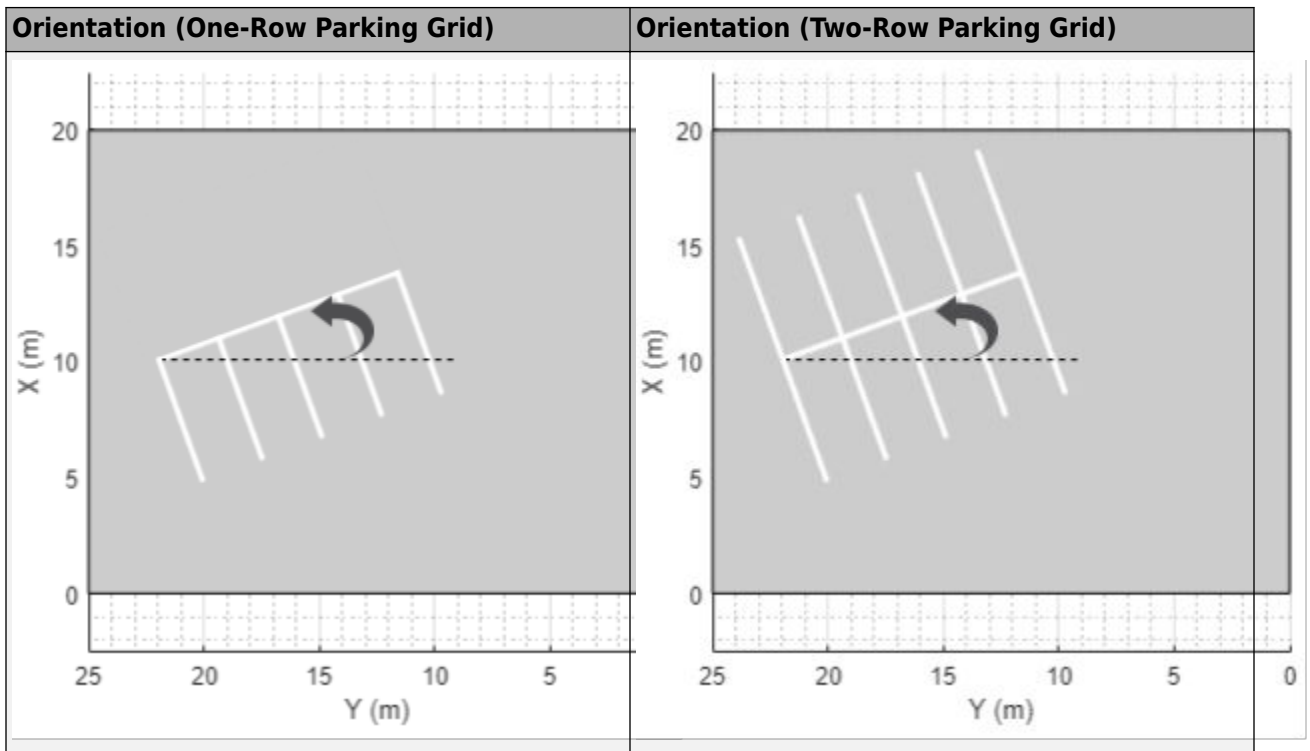
**Dependencies**

To use this argument, you must specify the `position` argument.

Offset — Offset of parking grid from edges (m)

0 (default) | nonnegative real scalar

Offset of the parking grid from the edges, in meters, specified as a nonnegative real scalar. Offset is relative to the first vertex of each specified edge. The same offset applies to all edges.

Dependencies

To use this argument, you must specify the `edge` argument.

Version History

Introduced in R2021b

See Also

`parkingLot` | `parkingSpace`

Topics

“Simulate Vehicle Parking Maneuver in Driving Scenario”

parkingSpace

Define parking space for parking lot

Description

parkingSpace objects define the parking spaces to add to parking lots in a driving scenario. You can define the dimensions and angle of the parking space, the type of parking space, and the color, width, and strength of the parking lane markings. To visualize a parking space before adding it to a parking lot, use the `plot` function. To populate a parking lot with the parking spaces that you create, use the `parkingLot` or `insertParkingSpaces` functions.

Creation

Syntax

```
space = parkingSpace  
space = parkingSpace(Name=Value)
```

Description

`space = parkingSpace` creates a straight parking space that is 2.6 meters wide, 5.5 meters long, and has white lane markings.

`space = parkingSpace(Name=Value)` sets properties using name-value arguments. For example, `space = parkingSpace(Type="Accessible",Width=3,Angle=60)` creates an accessible parking space that is 3 meters wide and has an angle of 60 degrees.

Properties

Type — Type of parking space

"Parking" (default) | "NoParking" | "Accessible"

Type of parking space, specified as "Parking", "NoParking", or "Accessible". This table shows the default parking space for each type.

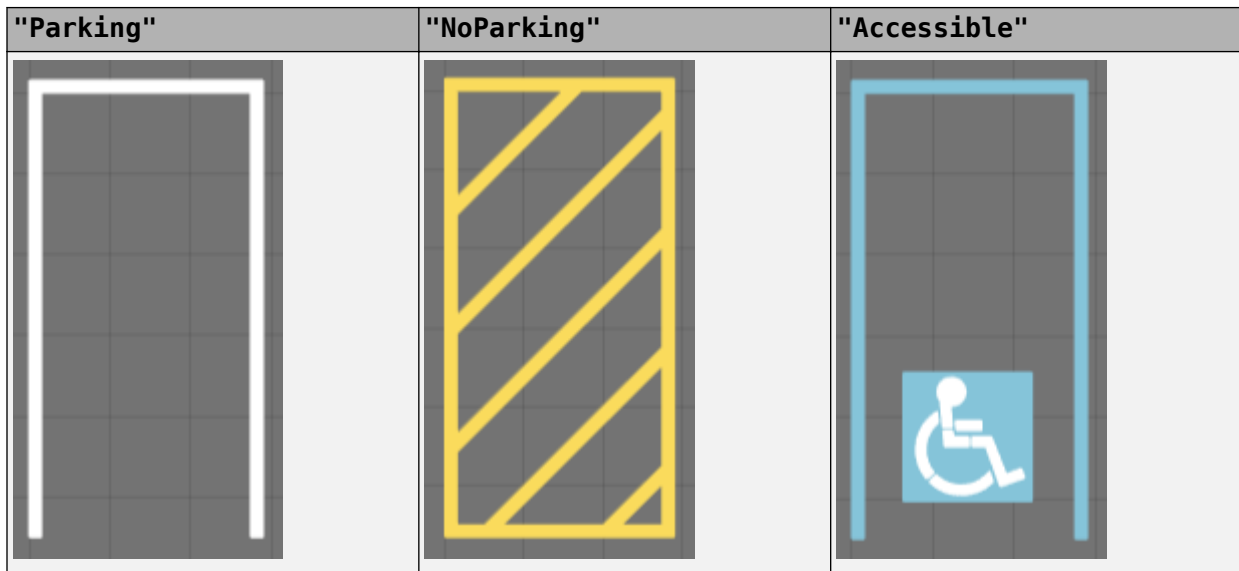
**Width — Width of parking space (m)**

2.6 (default) | real scalar in range [0.5, 100]

Width of parking space, in meters, specified as a real scalar in the range [0.5, 100].

Example: 3.6

Length — Length of parking space (m)

5.5 (default) | real scalar in range [0.5, 100]

Length of parking space, in meters, specified as a real scalar in the range [0.5, 100].

Example: 7.0

Angle — Angle of parking space (deg)

90 (default) | real scalar in range [20, 160]

Angle of parking space, in degrees, specified as a real scalar in the range [20, 160]. Angle is measured clockwise from the top edge to the left edge of the parking space. This table shows sample Angle values and their corresponding plots.

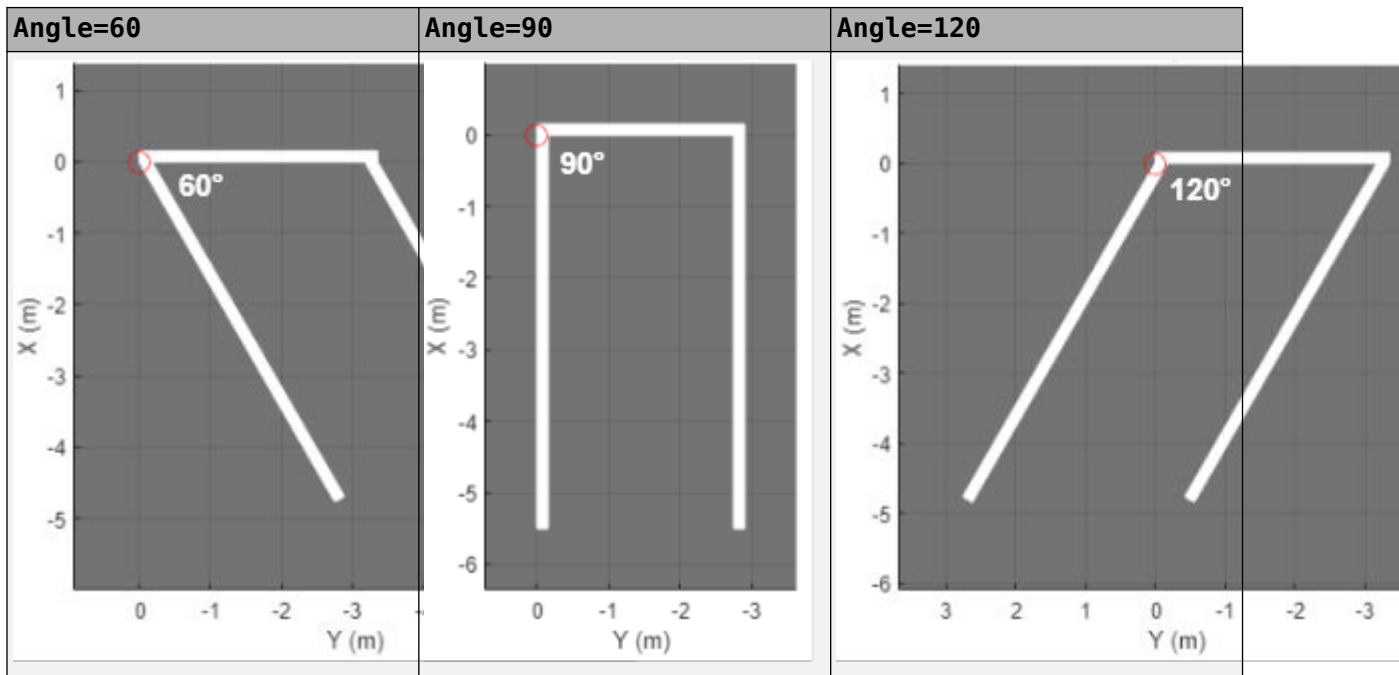

Example: 45

MarkingColor — Color of parking space lane markings





RGB triplet | hexadecimal color code | color name | short color name

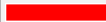

Color of parking space lane markings, specified as an RGB triplet, a hexadecimal color code, a color name, or a short color name. The same color applies to all markings in the space.

For a custom color, specify an RGB triplet or a hexadecimal color code.

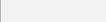
- An RGB triplet is a three-element row vector whose elements specify the intensities of the red, green, and blue components of the color. The intensities must be in the range $[0, 1]$, for example, $[0.4 \ 0.6 \ 0.7]$.
- A hexadecimal color code is a string scalar or character vector that starts with a hash symbol (#) followed by three or six hexadecimal digits, which can range from 0 to F. The values are not case sensitive. Therefore, the color codes "#FF8800", "#ff8800", "#F80", and "#f80" are equivalent.

Alternatively, you can specify some common colors by name. This table lists the named color options, the equivalent RGB triplets, and hexadecimal color codes.

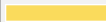
Color Name	Short Name	RGB Triplet	Hexadecimal Color Code	Appearance
"red"	"r"	[1 0 0]	"#FF0000"	
"green"	"g"	[0 1 0]	"#00FF00"	
"blue"	"b"	[0.5234 0.7695 0.8516]	"#85C4D9"	
"cyan"	"c"	[0 1 1]	"#00FFFF"	
"magenta"	"m"	[1 0 1]	"#FF00FF"	

Color Name	Short Name	RGB Triplet	Hexadecimal Color Code	Appearance
"yellow"	"y"	[0.98 0.86 0.36]	"#FADB5C"	
"black"	"k"	[0 0 0]	"#000000"	
"white"	"w"	[1 1 1]	"#FFFFFF"	

The default marking color depends on the parking space type specified by Type.

Type	MarkingColor Default
"Parking"	[1 1 1] (white)
"NoParking"	[0.98 0.86 0.36] (yellow)
"Accessible"	[0.5234 0.7695 0.8516] (blue)

Example: [0.8 0.8 0.8]

MarkingWidth — Width of parking space lane markings (m)

0.15 (default) | positive real scalar

Width of parking space lane markings, in meters, specified as a positive real scalar. The same width applies to all markings in the space.

MarkingWidth must be less than or equal to the parking space width specified by Width.

Example: 0.2

MarkingStrength — Saturation strength of parking lane marking color

1 (default) | real scalar in range [0, 1]

Saturation strength of the parking lane marking color, specified as a real scalar in the range [0, 1]. A value of 0 corresponds to a marking color that is fully unsaturated. The marking is the color of the underlying lot. A value of 1 corresponds to a marking color that is fully saturated.

Example: 0.75

Object Functions

plot Plot parking space

Examples

Create Parking Lot Containing Multiple Space Types

Create a parking lot that contains a mixture of parking spaces, no-parking areas, and accessible spaces.

Define the parking space to use in the parking lot. Use the default settings. Plot the space.

```
space = parkingSpace;
plot(space, Origin="off")
```

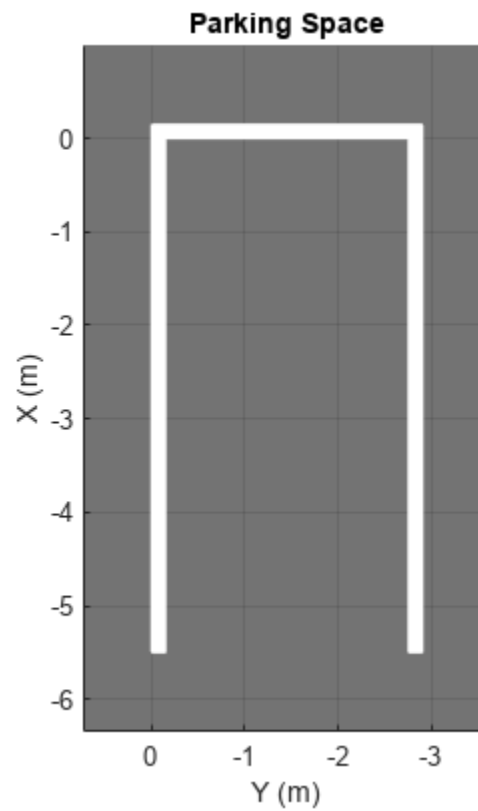

Define the no-parking areas to use in the parking lot. Specify a color of white and a width that is one meter less than the width of the default parking space. Plot the space.

```
noSpace = parkingSpace(Type="NoParking",Width=(space.Width - 1),MarkingColor="White");  
plot(noSpace,Origin="off")
```

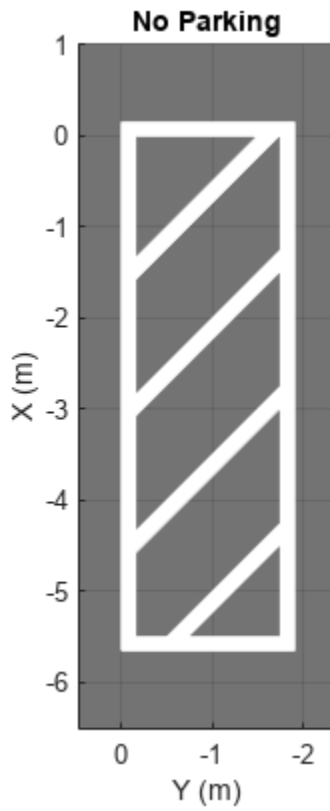

Define the accessible parking space to use in the parking lot. Specify a width that is one meter more than the width of the default parking space. Plot the space.

```
accessibleSpace = parkingSpace(Type="Accessible",Width=(space.Width + 1));  
plot(accessibleSpace,Origin="off")
```

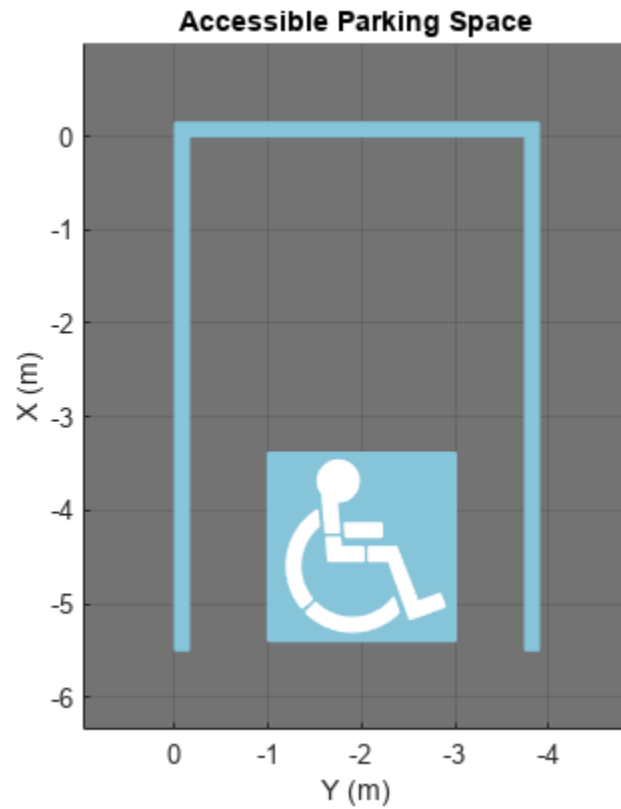

Create a driving scenario containing a parking lot with a nonrectangular layout. Plot the parking lot and display the edge numbers along which you can add parking spaces.

```
scenario = drivingScenario;  
vertices = [0 0; 32 -10.5; 32 -50.5; 25 -57.5; 0 -57.5];  
lot = parkingLot(scenario,vertices);  
plot(scenario,ParkingLotEdges="on")
```

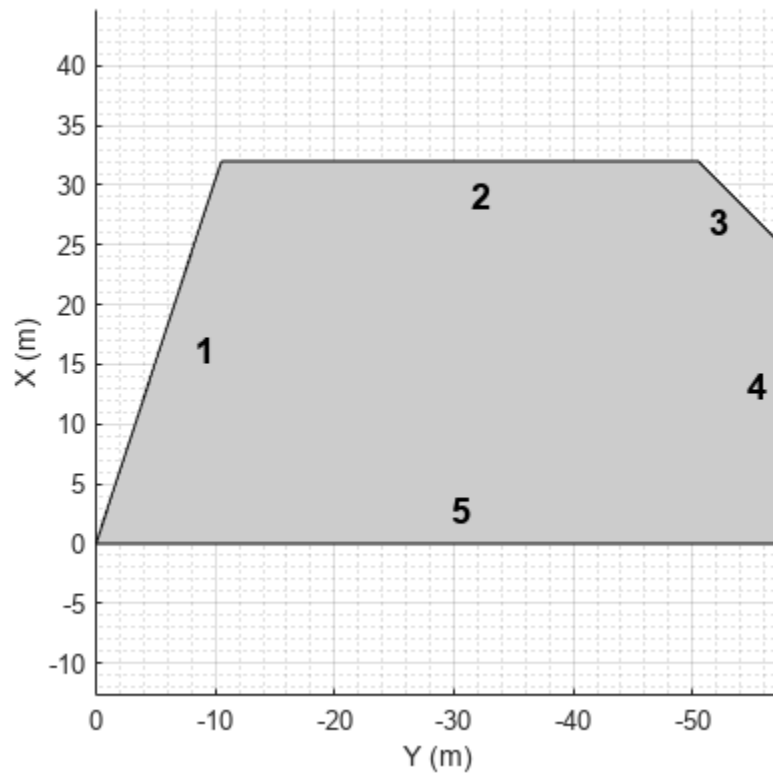

Insert default parking spaces along the first three edges of the parking lot. To avoid overlapping parking spaces, make these adjustments to the insertions:

- Along edge 1, insert only 10 spaces.
- Along edge 2, offset the spaces by 5 meters from the first vertex of the edge.
- Along edge 3, offset the spaces by 3 meters from the first vertex of the edge.

```
numSpaces = 10;  
insertParkingSpaces(lot,space,numSpaces,Edge=1)  
insertParkingSpaces(lot,space,Edge=2,Offset=5)  
insertParkingSpaces(lot,space,Edge=3,Offset=3)
```

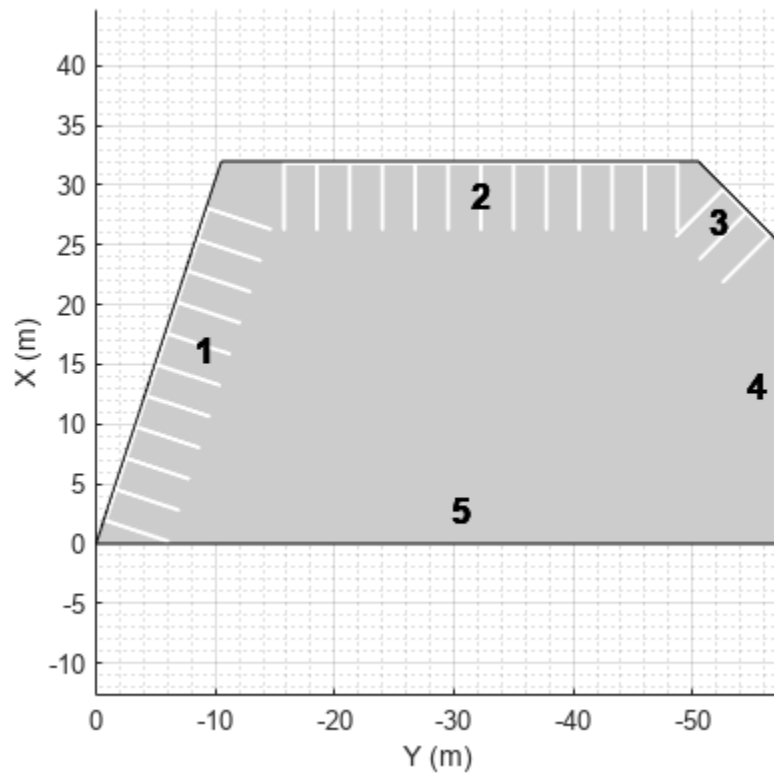
In the center of the parking lot, insert a 2-by-10 grid of parking spaces containing 8 columns of default spaces, 1 column of no-parking areas, and 1 column of accessible spaces.

```
insertParkingSpaces(lot,[space noSpace accessibleSpace],[8 1 1],Position=[12 -18],Rows=2)
```

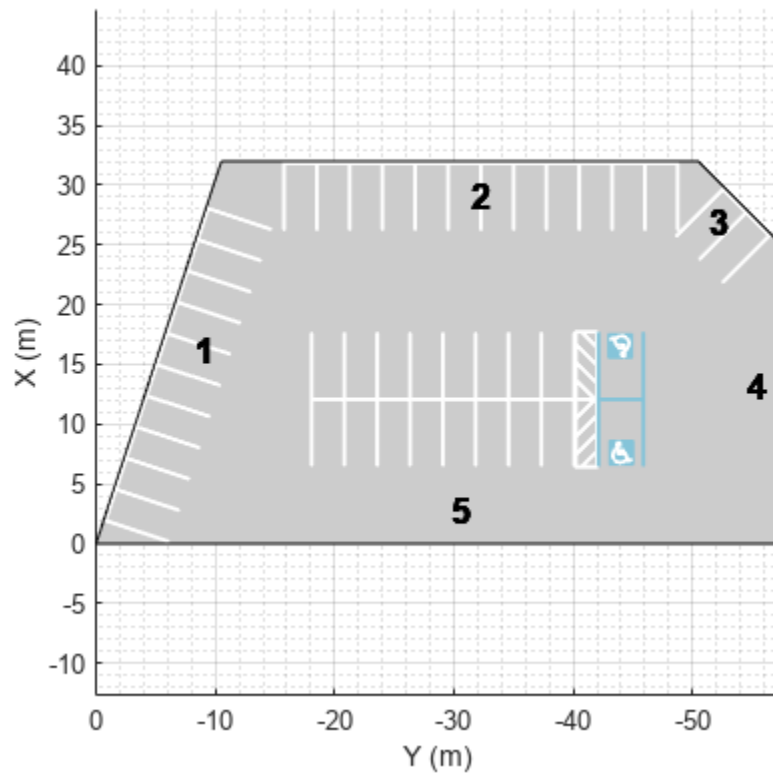

Create Parking Lot Using Predefined Layout

Explore the various parking lots that you can create by using predefined layouts as well as the options for configuring those layouts.

Define the parking space used to populate the parking lot. Modify the width, length, or angle of the space and the width and strength of its lane markings. Plot the parking space.

```
width = 2.6  ; % m
length = 5.5  ; % m
angle = 90  ; % deg
markingWidth = 0.15  ;
markingStrength = 1  ;

space = parkingSpace(Width=width, ...
                    Length=length, ...
                    Angle=angle, ...
                    MarkingWidth=markingWidth, ...
                    MarkingStrength=markingStrength);

plot(space)
```

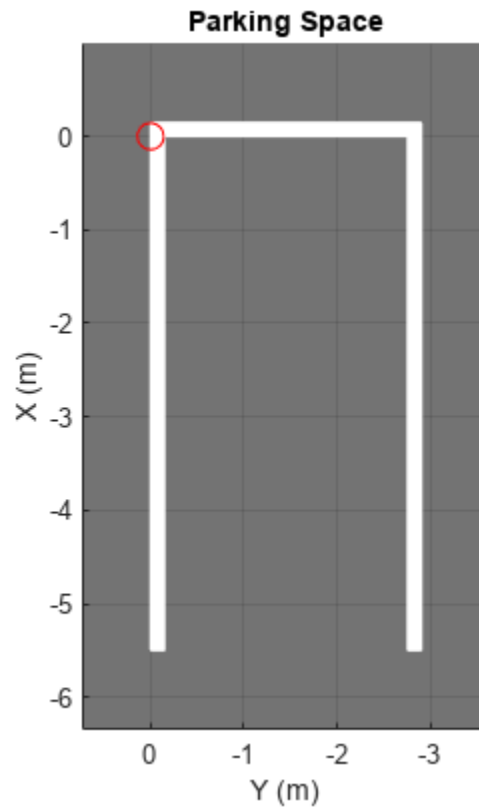

Create a driving scenario containing a 50-by-50 meter parking lot. Specify a predefined parking lot layout and a minimum driving lane width. The generated parking lot fills with as many parking spaces that fit the layout as possible given the minimum driving lane width constraint. Modify the parking space, layout type, and driving lane width, and observe the effects on the parking lot. For example:

- As you increase the size of the parking space or the minimum driving lane width, the number of parking grids that fit in the middle of the parking lot decreases.
- If you select the `HorizontalWithEdges` or `VerticalWithEdges` layout, one edge has fewer spaces than the others. This edge contains a driving lane of width `DrivingLaneWidth` that enables vehicles to enter the parking lot.

```
scenario = drivingScenario;
vertices = [0 0; 50 0; 50 -50; 0 -50];
parkingLayout = "Vertical";
drivingLaneWidth = 2.6 ; % m

parkingLot(scenario,vertices, ...
    ParkingSpace=space, ...
    ParkingLayout=parkingLayout, ...
    DrivingLaneWidth=drivingLaneWidth);

plot(scenario)
```

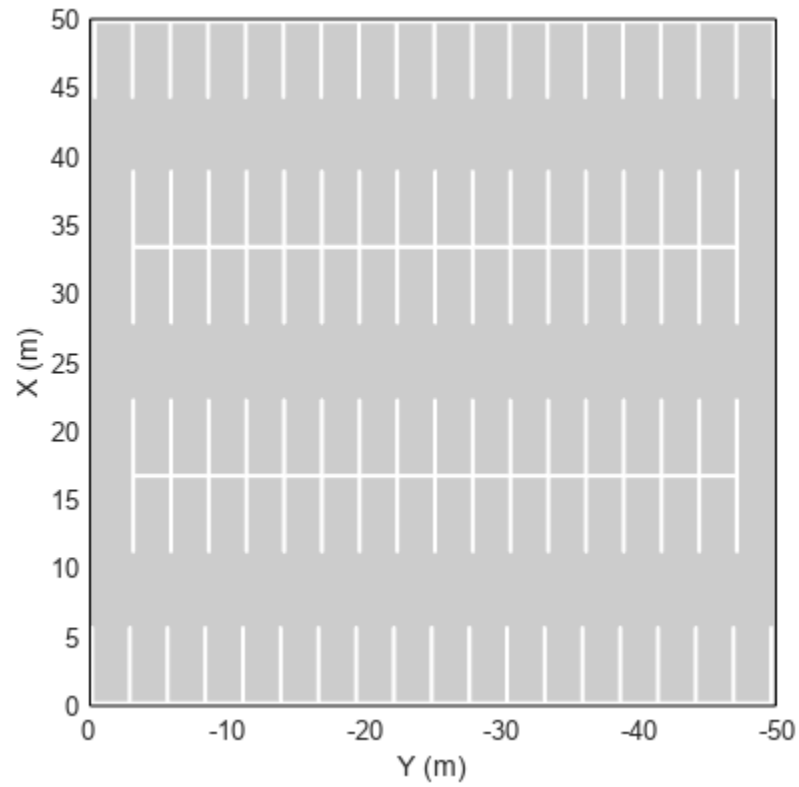

Version History

Introduced in R2021b

See Also

`insertParkingSpaces` | `parkingLot`

Topics

“Simulate Vehicle Parking Maneuver in Driving Scenario”

plot

Plot parking space

Syntax

```
plot(space)
plot(space,Origin=visibility)
```

Description

`plot(space)` plots a bird's-eye view of a parking space. Use this plot to examine the dimensions, angle, color, and type of a parking space before adding it to a parking lot.

`plot(space,Origin=visibility)` sets the visibility of the parking space origin to "on" or "off".

Examples

Create Parking Lot Using Predefined Layout

Explore the various parking lots that you can create by using predefined layouts as well as the options for configuring those layouts.

Define the parking space used to populate the parking lot. Modify the width, length, or angle of the space and the width and strength of its lane markings. Plot the parking space.

```
width = 2.6 ; % m
length = 5.5 ; % m
angle = 90 ; % deg
markingWidth = 0.15 ;
markingStrength = 1 ;

space = parkingSpace(Width=width, ...
                    Length=length, ...
                    Angle=angle, ...
                    MarkingWidth=markingWidth, ...
                    MarkingStrength=markingStrength);

plot(space)
```

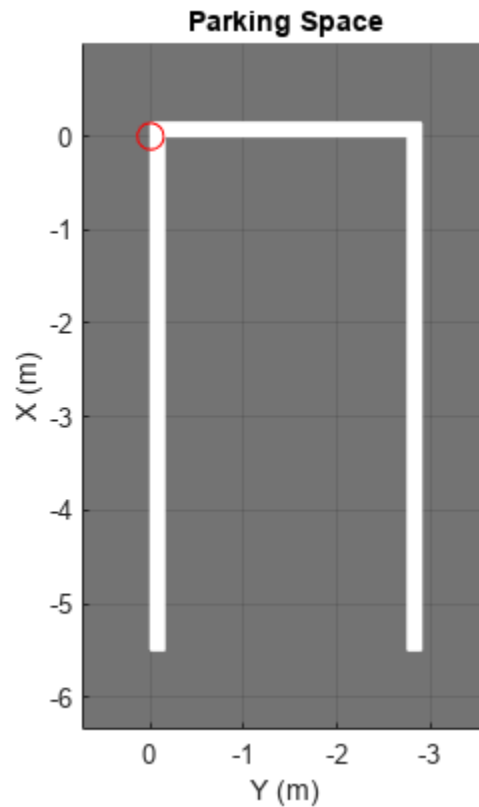

Create a driving scenario containing a 50-by-50 meter parking lot. Specify a predefined parking lot layout and a minimum driving lane width. The generated parking lot fills with as many parking spaces that fit the layout as possible given the minimum driving lane width constraint. Modify the parking space, layout type, and driving lane width, and observe the effects on the parking lot. For example:

- As you increase the size of the parking space or the minimum driving lane width, the number of parking grids that fit in the middle of the parking lot decreases.
- If you select the `HorizontalWithEdges` or `VerticalWithEdges` layout, one edge has fewer spaces than the others. This edge contains a driving lane of width `DrivingLaneWidth` that enables vehicles to enter the parking lot.

```
scenario = drivingScenario;
vertices = [0 0; 50 0; 50 -50; 0 -50];
parkingLayout = "Vertical";
drivingLaneWidth = 2.6 ; % m

parkingLot(scenario,vertices, ...
    ParkingSpace=space, ...
    ParkingLayout=parkingLayout, ...
    DrivingLaneWidth=drivingLaneWidth);

plot(scenario)
```

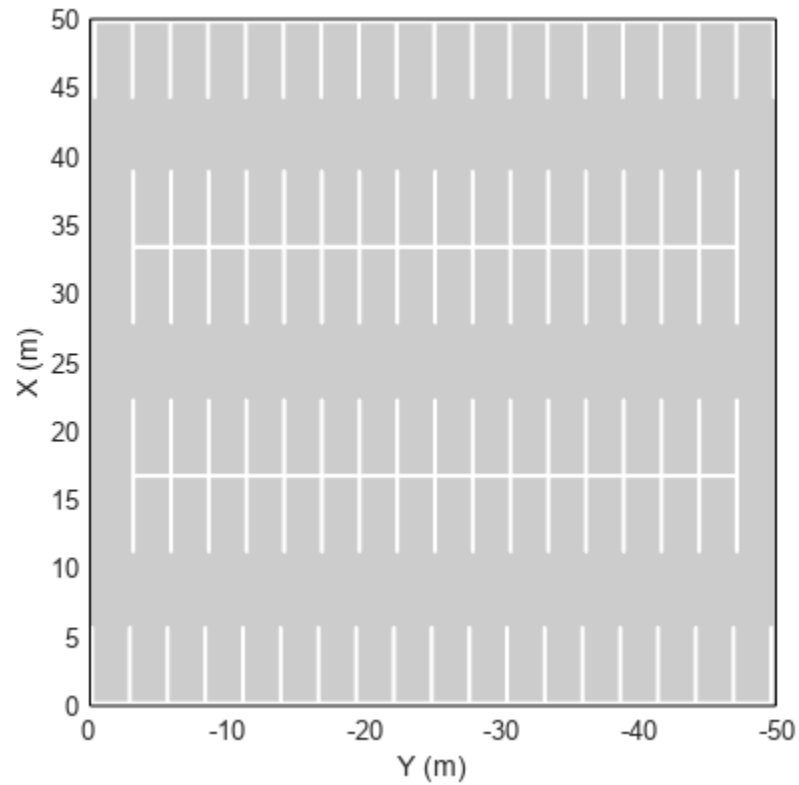

Create Parking Lot Containing Multiple Space Types

Create a parking lot that contains a mixture of parking spaces, no-parking areas, and accessible spaces.

Define the parking space to use in the parking lot. Use the default settings. Plot the space.

```
space = parkingSpace;  
plot(space,Origin="off")
```

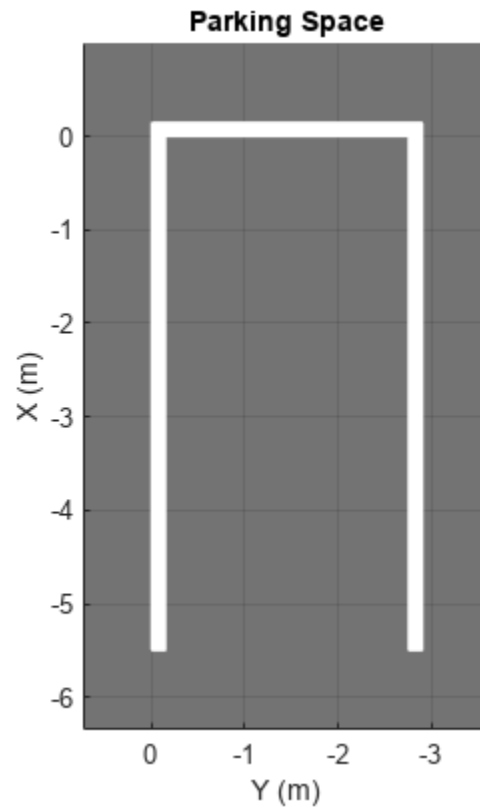

Define the no-parking areas to use in the parking lot. Specify a color of white and a width that is one meter less than the width of the default parking space. Plot the space.

```
noSpace = parkingSpace(Type="NoParking",Width=(space.Width - 1),MarkingColor="White");  
plot(noSpace,Origin="off")
```

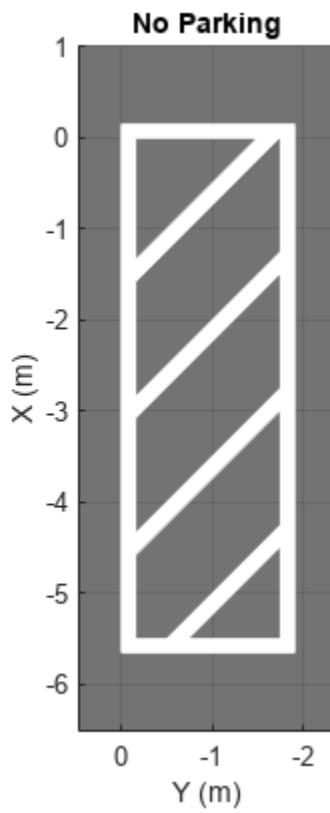
Define the accessible parking space to use in the parking lot. Specify a width that is one meter more than the width of the default parking space. Plot the space.

```
accessibleSpace = parkingSpace(Type="Accessible",Width=(space.Width + 1));  
plot(accessibleSpace,Origin="off")
```

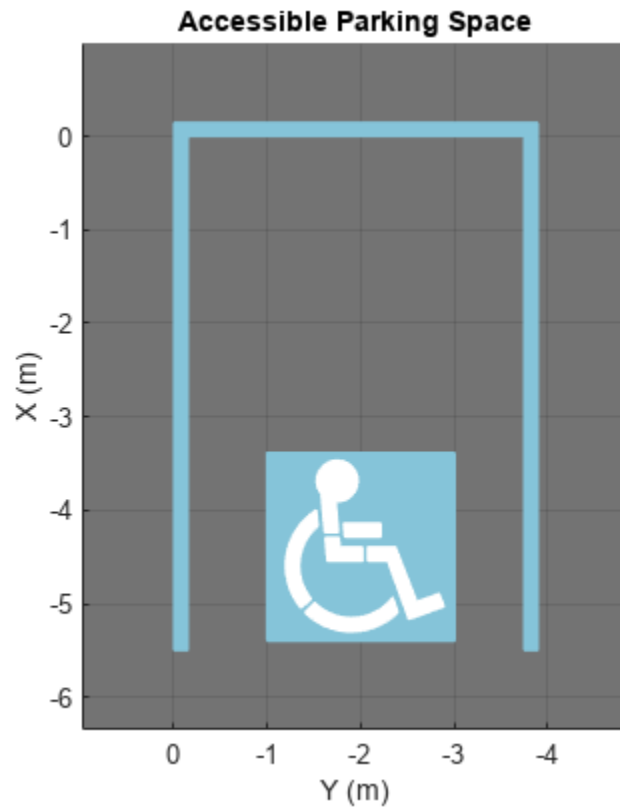

Create a driving scenario containing a parking lot with a nonrectangular layout. Plot the parking lot and display the edge numbers along which you can add parking spaces.

```
scenario = drivingScenario;  
vertices = [0 0; 32 -10.5; 32 -50.5; 25 -57.5; 0 -57.5];  
lot = parkingLot(scenario,vertices);  
plot(scenario,ParkingLotEdges="on")
```

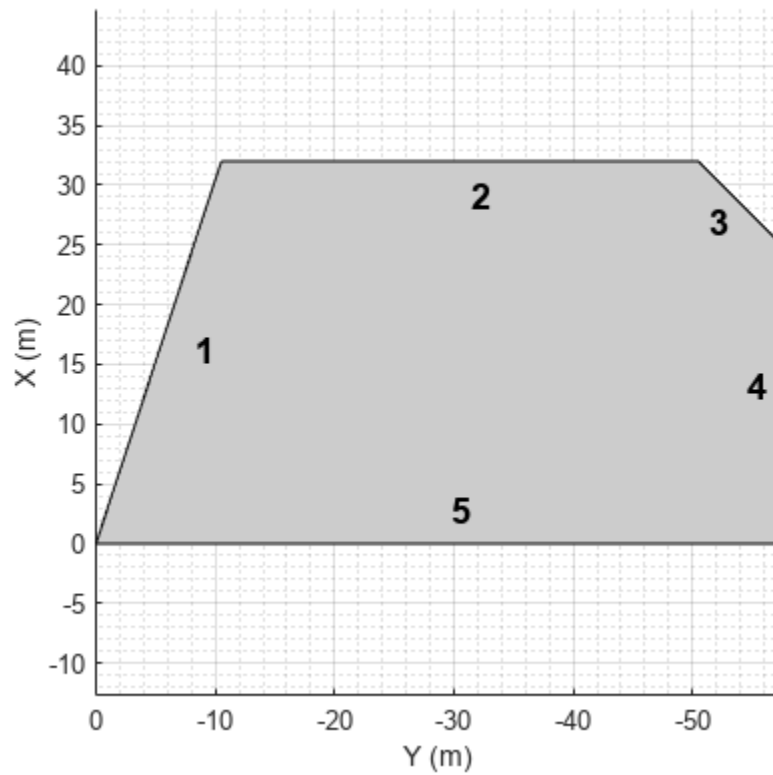

Insert default parking spaces along the first three edges of the parking lot. To avoid overlapping parking spaces, make these adjustments to the insertions:

- Along edge 1, insert only 10 spaces.
- Along edge 2, offset the spaces by 5 meters from the first vertex of the edge.
- Along edge 3, offset the spaces by 3 meters from the first vertex of the edge.

```
numSpaces = 10;  
insertParkingSpaces(lot,space,numSpaces,Edge=1)  
insertParkingSpaces(lot,space,Edge=2,Offset=5)  
insertParkingSpaces(lot,space,Edge=3,Offset=3)
```

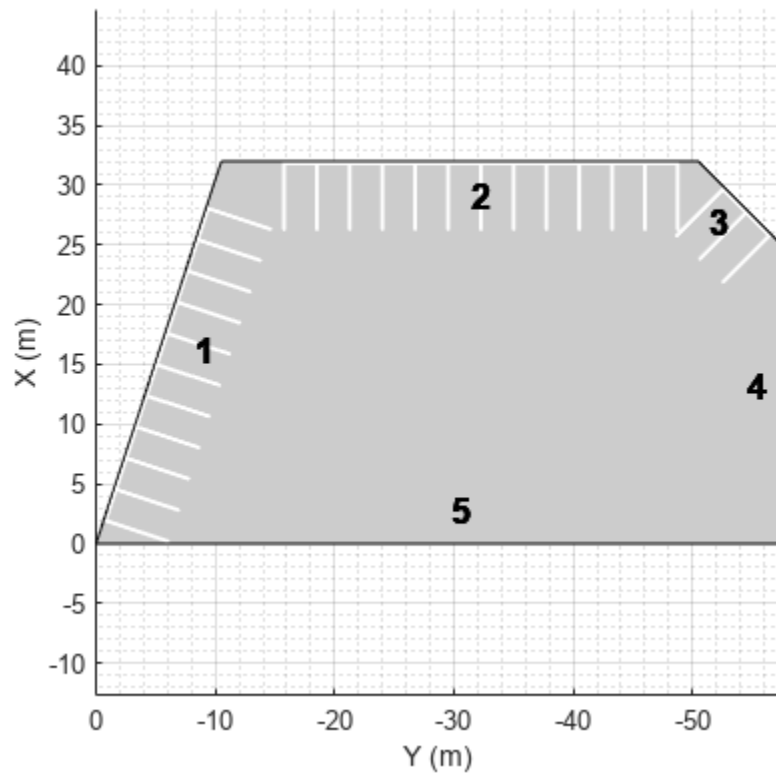

In the center of the parking lot, insert a 2-by-10 grid of parking spaces containing 8 columns of default spaces, 1 column of no-parking areas, and 1 column of accessible spaces.

```
insertParkingSpaces(lot,[space noSpace accessibleSpace],[8 1 1],Position=[12 -18],Rows=2)
```

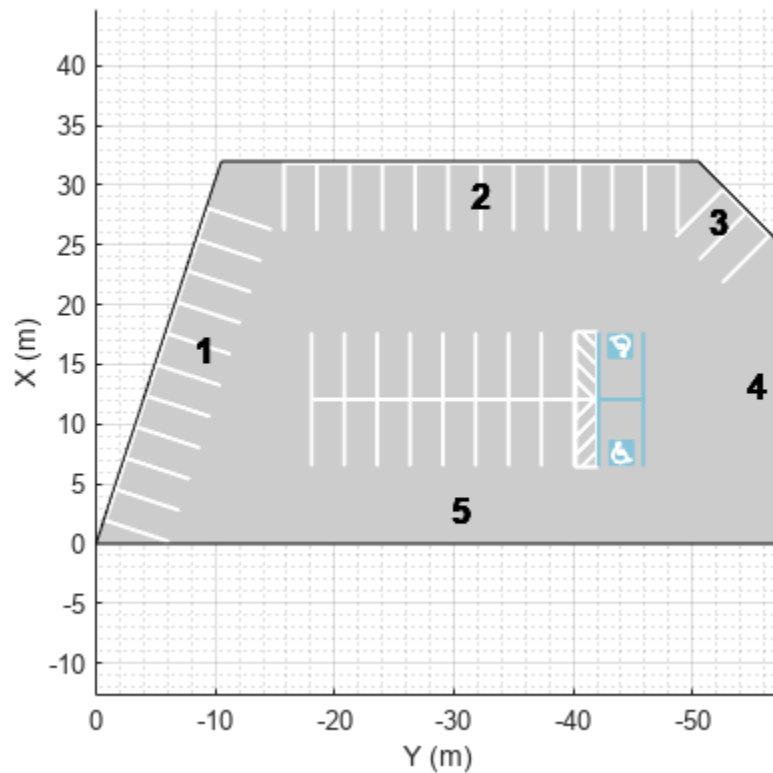

Input Arguments

space — Parking space

parkingSpace object

Parking space, specified as a parkingSpace object.

visibility — Visibility of parking space origin

"on" (default) | "off"

Visibility of parking space origin, specified as "on" or "off". The origin is located on the upper-left corner of the parking space.

Data Types: char | string

Version History

Introduced in R2021b

See Also

parkingLot | parkingSpace | insertParkingSpaces

getRoadRunnerHDMap

Get RoadRunner HD Map from Driving Scenario in MATLAB

Syntax

```
rrMap = getRoadRunnerHDMap(scenario)
```

Description

`rrMap = getRoadRunnerHDMap(scenario)` returns a RoadRunner HD Map object, `rrMap` for the road network and static actors in the driving scenario, `scenario`. RoadRunner HD Map is a road data model for representing high-definition map data in a RoadRunner scene. Use the `rrMap` object to inspect the scenario representation and modify elements. Then, you can write `rrMap` to a `.rrhd` binary file using the `write` function, and import the `.rrhd` file into RoadRunner. There may be variations between the original scenario and the exported scenario. For details, see [Limitations](#) on page 4-809.

Examples

Export RoadRunner HD Map from Driving Scenario

Create a driving scenario object.

```
scenario = helperCreateDrivingScenario;
```

Plot the scenario.

```
plot(scenario)
```

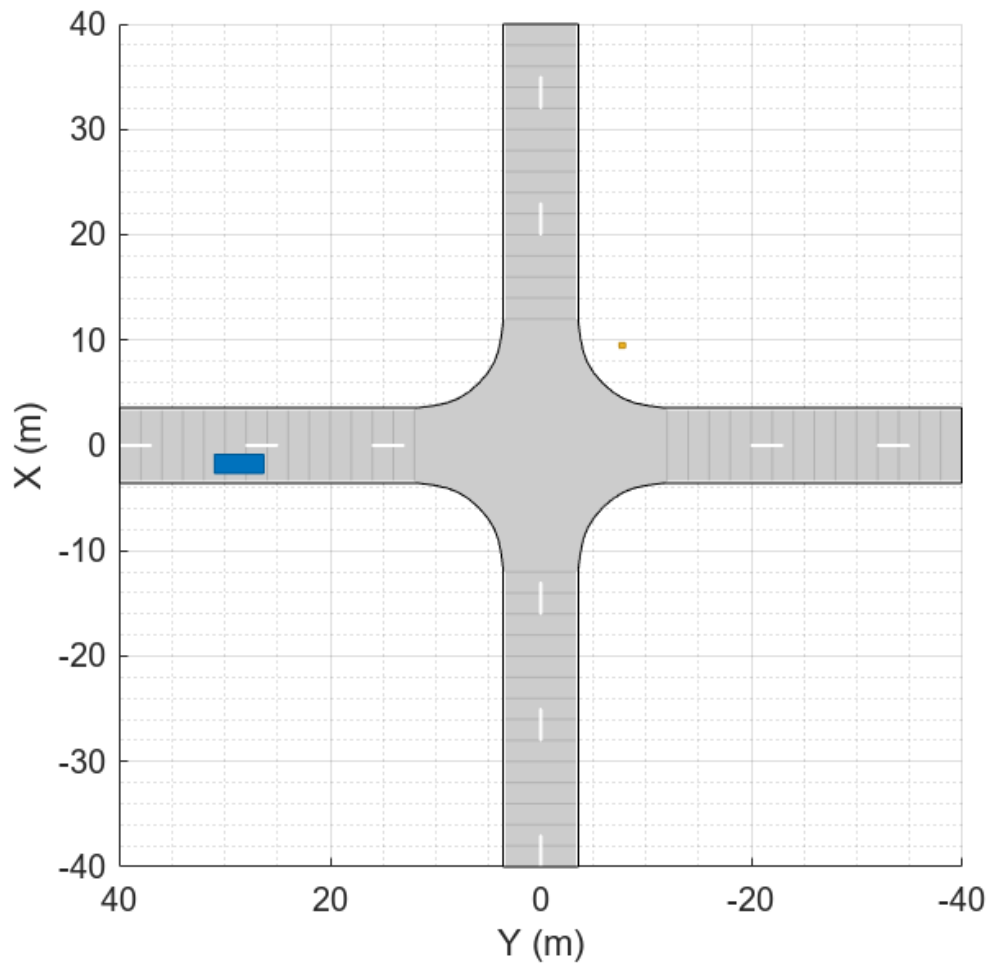

Export the driving scenario directly to a `.rrhd` binary file.

```
export(scenario, "RoadRunner HD Map", "directExportScenario.rrhd")
```

Alternatively, you can first get the RoadRunner HD Map object for the scenario and plot it.

```
rrMap = getRoadRunnerHDMap(scenario);  
plot(rrMap)
```

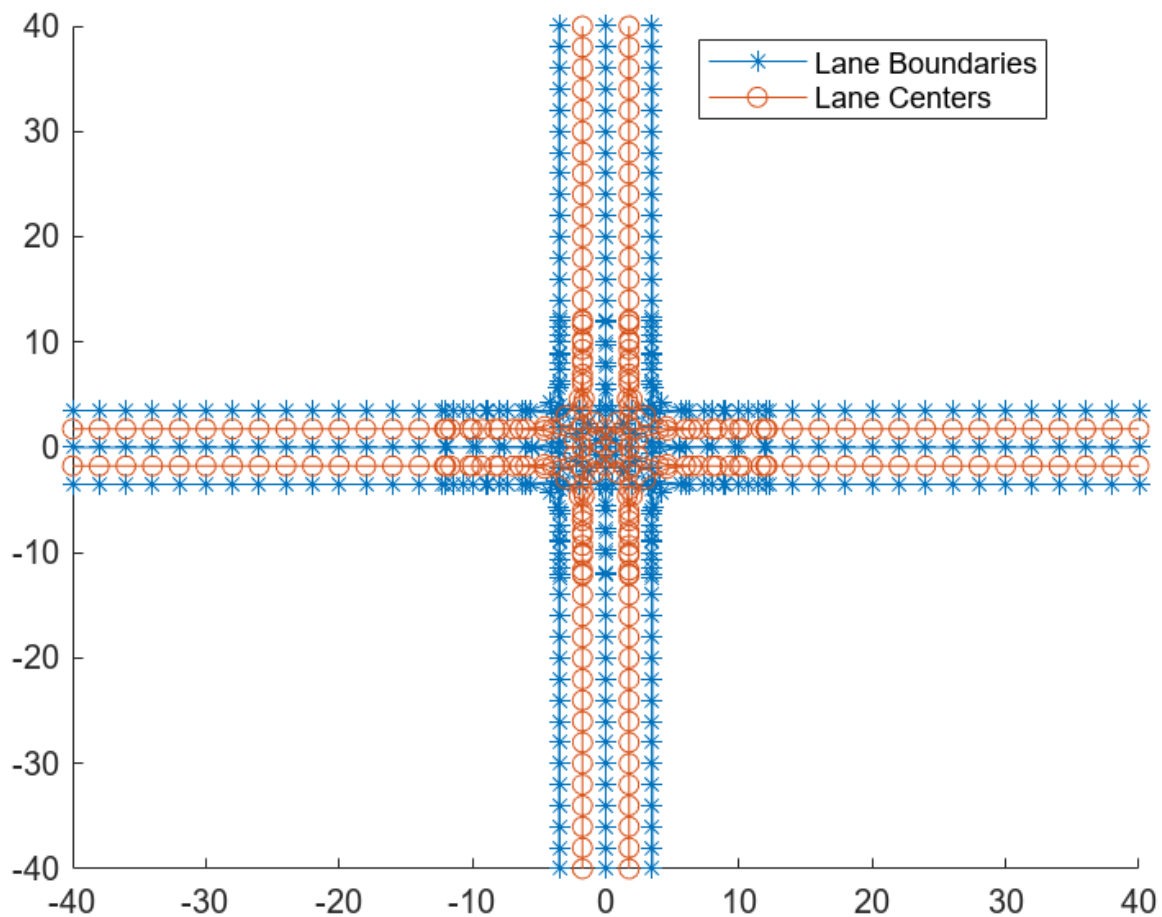

You can inspect it and make any desired modifications. Then, write the RoadRunner HD Map to a .rrhd binary file.

```
write(rrMap, '4wayIntersection.rrhd')
```

Import the map into RoadRunner.

```
rrApp = roadrunner("D:\RR\TestProjects");  
importScene(rrApp, fullfile(pwd, "4wayIntersection.rrhd"), "RoadRunner HD Map")
```

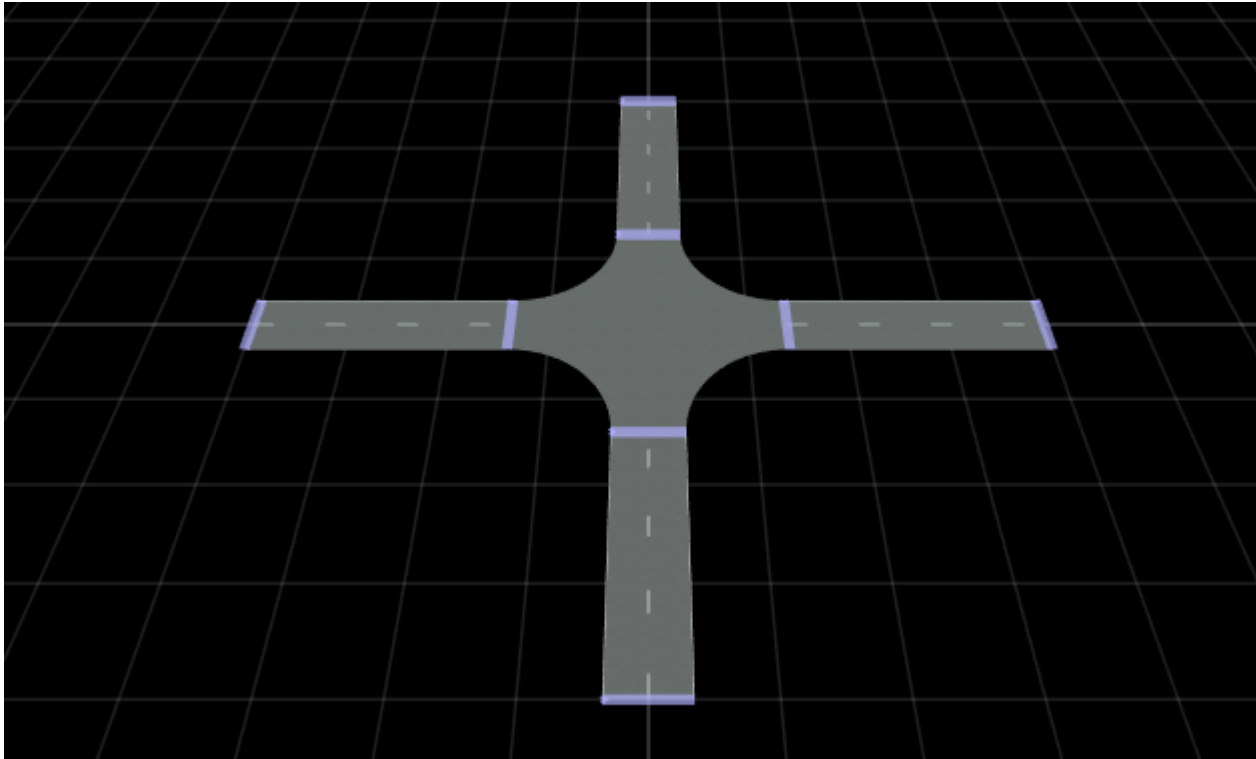
Helper Functions

`helperCreateDrivingScenario` creates a four way intersection driving scenario with an ego vehicle and a pedestrian.

```
function scenario = helperCreateDrivingScenario

% Create scenario and add roads
scenario = drivingScenario;
roadCenters = [0 40 0;
               0 -40 0];
marking = [laneMarking('Solid')
           laneMarking('Dashed')
           laneMarking('Solid')];
laneSpecification = lanespec(2, 'Width', 3.5, 'Marking', marking);
road(scenario, roadCenters, 'Lanes', laneSpecification, 'Name', 'Road');

roadCenters = [-40 0 0;
               40 0 0];
marking = [laneMarking('Solid')
           laneMarking('Dashed')
           laneMarking('Solid')];
laneSpecification = lanespec(2, 'Width', 3.5, 'Marking', marking);
road(scenario, roadCenters, 'Lanes', laneSpecification, 'Name', 'Road1');

roadCenters = [0 11.5 0;
               0.8753853761202 7.0991405278015 0;
               3.3682720163547 3.3682720163547 0];
```

```

    7.0991405278015 0.8753853761202 0;
    11.5 0 0];
    marking = [laneMarking('Solid')
               laneMarking('Dashed')
               laneMarking('Solid')];
    laneSpecification = lanespec(2, 'Width', 3.5, 'Marking', marking);
    road(scenario, roadCenters, 'Lanes', laneSpecification, 'Name', 'Road2');

    roadCenters = [0 -11.5 0;
                  0.8753853761202 -7.0991405278015 0;
                  3.3682720163547 -3.3682720163547 0;
                  7.0991405278015 -0.8753853761202 0;
                  11.5 0 0];
    marking = [laneMarking('Solid')
               laneMarking('Dashed')
               laneMarking('Solid')];
    laneSpecification = lanespec(2, 'Width', 3.5, 'Marking', marking);
    road(scenario, roadCenters, 'Lanes', laneSpecification, 'Name', 'Road3');

    roadCenters = [0 -11.5 0;
                  -0.8753853761202 -7.0991405278015 0;
                  -3.3682720163547 -3.3682720163547 0;
                  -7.0991405278015 -0.8753853761202 0;
                  -11.5 0 0];
    marking = [laneMarking('Solid')
               laneMarking('Dashed')
               laneMarking('Solid')];
    laneSpecification = lanespec(2, 'Width', 3.5, 'Marking', marking);
    road(scenario, roadCenters, 'Lanes', laneSpecification, 'Name', 'Road4');

    roadCenters = [0 11.5 0;
                  -0.8753853761202 7.0991405278015 0;
                  -3.3682720163547 3.3682720163547 0;
                  -7.0991405278015 0.8753853761202 0;
                  -11.5 0 0];
    marking = [laneMarking('Solid')
               laneMarking('Dashed')
               laneMarking('Solid')];
    laneSpecification = lanespec(2, 'Width', 3.5, 'Marking', marking);
    road(scenario, roadCenters, 'Lanes', laneSpecification, 'Name', 'Road5');

    % Add ego vehicle
    egoVehicle = vehicle(scenario, ...
        'ClassID', 1, ...
        'Position', [-1.75 30 0], ...
        'FrontOverhang', 0.9, ...
        'Wheelbase', 2.8, ...
        'Mesh', driving.scenario.carMesh, ...
        'Name', 'Vehicle Under Test');
    waypoints = [-1.75 30 0;
                -1.75 10.629767723813 0;
                -0.980075893866154 4.2738387109925 0;
                4.2738387109925 -0.980075893866154 0;
                10.629767723813 -1.75 0;
                30 -1.75 0];
    speed = 2.777777777777778;
    yaw = [-90; -90; -69.38; -20.62; 0; 0];
    smoothTrajectory(egoVehicle, waypoints, speed, 'Yaw', yaw);

```

```

% Add the non-ego actors
euron cappedpedestriantarget = actor(scenario, ...
    'ClassID', 4, ...
    'Length', 0.6, ...
    'Width', 0.5, ...
    'Height', 1.8, ...
    'Position', [9.5 -7.75 0], ...
    'PlotColor', [237 177 32] / 255, ...
    'Name', 'Euro NCAP Pedestrian Target');
waypoints = [9.5 -7.75 0;
    9.5 -6.75 0;
    9.5 10 0];
speed = [0;1.388888888888889;1.388888888888889];
waittime = [7.82;0;0];
trajectory(euron cappedpedestriantarget, waypoints, speed, waittime);
end

```

Input Arguments

scenario — Driving scenario

drivingScenario object

Driving scenario, specified as a drivingScenario object.

Output Arguments

rrMap — RoadRunner HD Map road data model

roadrunnerHDMAP object

RoadRunner HD Map road data model, specified as a roadrunnerHDMAP object. rrMap defines a simple data structure to represent road layouts using lanes, lane boundaries, lane markings, and junctions. This object provides functions that support reading, writing, and plotting HD map data.

Limitations

RoadRunner HD Map Export Limitations

A RoadRunner Scene Builder license is required to build a scene from the HD map file. Without a RoadRunner Scene Builder license, you can import the HD map file and only view the map as nodes and links in RoadRunner.

Composite Lane Specifications

- Roads that use composite lane specifications (compositeLaneSpec) and form loops or intersect with themselves are not supported.
- Composite lane specifications for creating roads with varying widths are not supported

Lane Markings and Lane Type

- For lane markings created using the laneMarking object and lane types created using the laneType object, only Color name-value argument is supported. Only white and yellow colors are supported.

- For roads that form loops, multiple lane marking styles are not supported.

Parking Lot

- Driving scenarios containing parking lots added using the `parkingLot` function are not supported.

Barriers

- Barriers with gaps between segments created using the `barrier` function with `SegmentGap` name-value argument, are not supported. Such barriers will be laid out without any gaps in the RoadRunner HD map representation.
- For barriers, setting the `SegmentLength`, `Width`, and `Height` properties are not supported. These properties are calculated automatically based on the asset size during import to RoadRunner.

Junctions

- Only single 4-way intersection and merge/exit junction are supported.

Static Actors

- Static actors such as pedestrians and bicycles are not supported. To represent these actors in RoadRunner, you can either download a cuboid FBX and place it under `Assets/Vehicles/` or edit the map to point to their own assets.

Road Groups and Road Networks

- Road junctions and intersections added using the `roadGroup` function are not supported.
- Road networks created using the `roadNetwork` function are not supported.

Version History

Introduced in R2023a

See Also

`roadrunnerHDMAP` | `drivingScenario` | `export`

adtfFileReader

Read stream information from ADTF DAT file

Description

An `adtfFileReader` object reads the stream information associated with the various sensors in an Automotive Data and Time-Triggered Framework (ADTF) DAT file. ADTF is a framework developed by Elektrobit, to develop, visualize, test and validate advanced driver assistance systems (ADAS) and automated driving functions. DAT files contain data from various sensors, such as lidars and cameras as well as other automotive data.

To select messages of a specific type to read from an `adtfFileReader` object, use the `select` object function.

`adtfFileReader` supports reading both 2.0 and 3.0 versions of ADTF DAT files. Each stream in the DAT file must contain sorted chunk timestamps. This requirement applies to the data within a stream only, and not across multiple streams.

Creation

Syntax

```
adtfReader = adtfFileReader(dataFileName)
adtfReader = adtfFileReader(dataFileName,descriptionFileName)
adtfReader = adtfFileReader(dataFileName,pluginDirectoryPath)
adtfReader = adtfFileReader(dataFileName,descriptionFileName,
pluginDirectoryPath)
```

Description

`adtfReader = adtfFileReader(dataFileName)` creates an `adtfFileReader` object, `adtfReader`, that reads stream information from the specified ADTF DAT file.

`adtfReader = adtfFileReader(dataFileName,descriptionFileName)` specifies a description file, `descriptionFileName`, that defines the structure of the streams in the ADTF DAT file.

`adtfReader = adtfFileReader(dataFileName,pluginDirectoryPath)` specifies a directory, `pluginDirectoryPath`, that contains plugins to use when reading information from the ADTF DAT file. Plugins are operating system specific, compiled object files that help in reading DAT files.

`adtfReader = adtfFileReader(dataFileName,descriptionFileName,pluginDirectoryPath)` specifies the plugin directory and the description file to read data from the ADTF DAT file.

Input Arguments

dataFileName — ADTF DAT file name

string scalar | character vector

ADTF DAT file name, specified as a string scalar or character vector.

descriptionFileName — Description file name

string scalar | character vector

Description file name, specified as a string scalar or character vector. Description files have the extension as XML or DESCRIPTION.

pluginDirectoryPath — Absolute path to ADTF plugin directory

string scalar | character vector

Absolute path to ADTF plugin directory, specified as a string scalar or character vector. The object uses only the plugin files within the specified directory that have the `.adtfplugin` extension.

Properties

DataFileName — Absolute path to ADTF DAT file

string scalar

This property is read-only.

Absolute path to the ADTF DAT file to read, specified as a string scalar.

DescriptionFileName — Absolute path to description file

string scalar

This property is read-only.

Absolute path to the description file, specified as a string scalar.

PluginDirectory — Absolute path to ADTF plugin directory

string scalar

This property is read-only.

Absolute path to ADTF plugin directory, specified as a string scalar.

StreamCount — Number of streams in DAT file

positive integer

This property is read-only.

Number of streams in DAT file, specified as a positive integer.

StreamInfo — Summary of all streams in the DAT file

structure

This property is read-only.

Summary of all streams in the DAT file, specified as a structure.

Object Functions

`select` Create reader for selected subset of ADTF DAT file data

Examples

Extract Video Stream From ADTF DAT File

This example shows how to extract and visualize a video stream, stored in an ADTF DAT file. It also shows how to write the video stream into a video file.

Download the sample video DAT file.

```
downloadURL = 'https://ssd.mathworks.com/supportfiles/driving/data/sample_can_video_dat.zip';
dataFolder = fullfile(tempdir, 'adtf-video', filesep);
options     = weboptions('Timeout', Inf);
zipFileName = [dataFolder, 'sample_can_video_dat.zip'];
folderExists = exist(dataFolder, 'dir');
```

% Create a folder in a temporary directory to save the downloaded file.

```
if ~folderExists
    mkdir(dataFolder);
    disp('Downloading sample_can_video_dat.zip (9.74 MB)...')
    websave(zipFileName, downloadURL, options);
```

% Extract contents of the downloaded file.

```
disp('Extracting sample_can_video_dat.zip...')
unzip(zipFileName, dataFolder);
```

`end`

Downloading sample_can_video_dat.zip (9.74 MB)...

Extracting sample_can_video_dat.zip...

Create the ADTF File Reader object.

```
datFileName = fullfile(dataFolder, "sample_can_video.dat");
fileReader = adtfFileReader(datFileName)
```

`fileReader =`

```
    DataFileName: "C:\Users\latrival\AppData\Local\Temp\adtf-video\sample_can_video.dat"
  DescriptionFileName: ""
    PluginDirectory: ""
      StreamCount: 2
      StreamInfo:
```

StreamIndex	StreamName	StreamType	StartTime	EndTime	ItemCount	Subst
1	{'rawcan'}	{'UNRESOLVED'}	0 sec	14.805 sec	743	{0×1 }
2	{'video' }	{'adtf/image'}	0 sec	14.799 sec	149	{0×1 }

From the `StreamInfo` property, note that the index of the video stream is 2. Use the `select` function of the `adtfFileReader` object, to select the video stream for reading. The returned `adtfStreamReader` object has all the information about the selection.

```
streamReader = select(fileReader,2)
streamReader =
    adtfStreamReader with properties:
        DataFileName: "C:\Users\latrival\AppData\Local\Temp\adtf-video\sample_can_video.dat"
        DescriptionFileName: ""
        PluginDirectory: ""
        StreamIndex: 2
        StartIndex: 1
        EndIndex: 149
        CurrentIndexOffset: 0
        StartTime: [0x0 duration]
        EndTime: [0x0 duration]
        DataCount: 149
```

Note that the value of `CurrentIndexOffset` is 0. This signifies that the next `readNext` call will return the first item.

Preview the first image frame from the stream.

```
firstFrame = readNext(streamReader);
imshow(firstFrame.Data.Item)
```

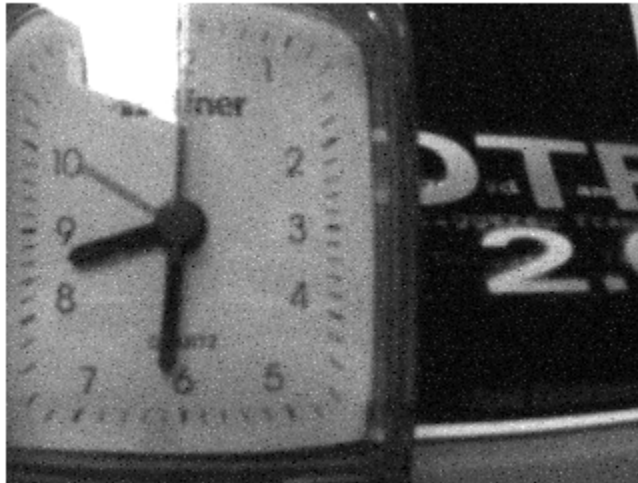

Before creating a video, use the `reset` function to start reading from the first frame. This resets the value of `CurrentIndexOffset` to 0.

```
reset(streamReader);
fprintf("CurrentIndexOffset = %d\n",streamReader.CurrentIndexOffset)
```

```
CurrentIndexOffset = 0
```

Create a `VideoWriter` object that you can use to write image frames to a video file. Specify a frame rate of 1 frame per second.

```
videoWriterObj = VideoWriter("example_video.avi");  
videoWriterObj.FrameRate = 1;  
open(videoWriterObj);
```

Using the `streamReader` object, iterate over the data items in the selection one-by-one. The `hasNext` function determines if there is an item left to read as we are incrementally reading the file. `readNext` returns the data item which is basically a structure containing the data and the associated timestamp. In every iteration, extract the image frame and write it to the video file.

```
while streamReader.hasNext()  
    streamData = streamReader.readNext();  
    imageFrame = streamData.Data.Item;  
    frame      = im2frame(streamData.Data.Item, gray);  
    writeVideo(videoWriterObj, frame);  
end
```

Alternatively, you can read all the image frames at once, using the `read` function, and iterate over it later.

```
allData = read(streamReader)  
  
allData = struct with fields:  
    StreamIndex: 2  
    Data: [149x1 struct]
```

Close the connection with the video file.

```
close(videoWriterObj);  
close all
```

Visualize the output file `example_video.avi` using Video Viewer.

```
implay("example_video.avi")
```

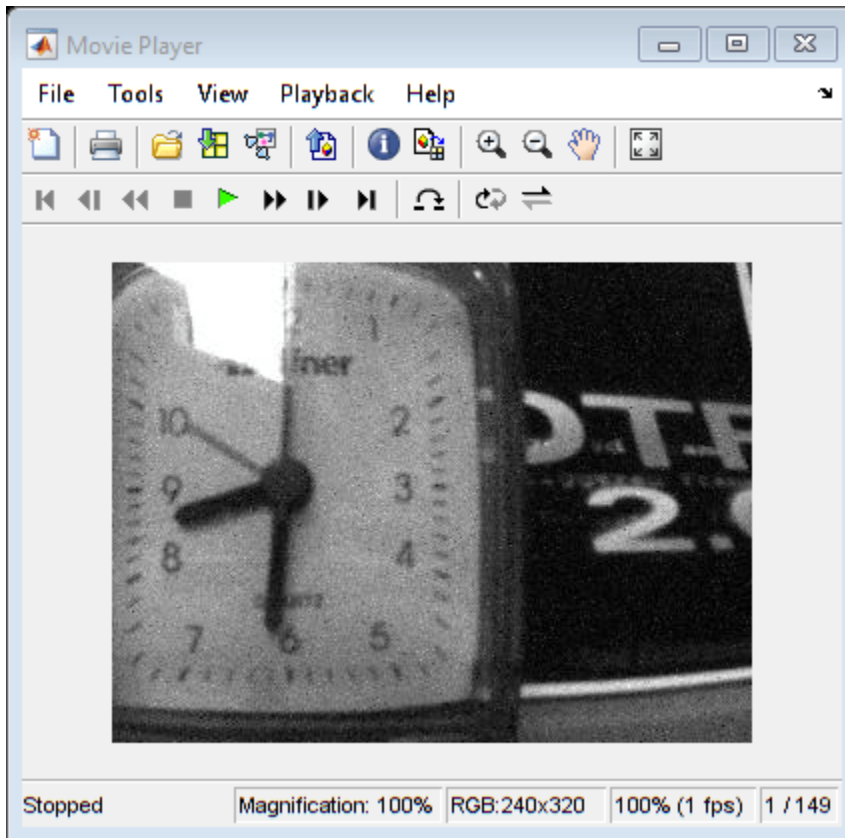

Limitations

- Reading DAT files on Mac platforms is not supported.
- Reading these stream types is not supported:
 - adtf/anonymous
 - adtf/audio
- For reading adtf/video_compressed stream type, only JPEG compression format is supported.

Version History

Introduced in R2022a

See Also

[select](#) | [adtfStreamReader](#) | [read](#) | [readNext](#) | [hasNext](#)

Topics

“Read Data From ADTF DAT Files”

adtfStreamReader

Stream reader for ADTF DAT file

Description

The `adtfStreamReader` object is an indexed selection of the data in an Automotive Data and Time-Triggered Framework (ADTF) DAT file, which you can use to read that data into the MATLAB workspace. An `adtfStreamReader` object contains the indices and time stamps of the first and final data items from each stream selected from an `adtfFileReader` object. Each stream in the DAT file must contain sorted chunk timestamps. This requirement applies to the data within a stream only, and not across multiple streams.

Creation

To create an `adtfStreamReader` object, use the `select` object function of the `adtfFileReader` object. You can read data from all the selected streams at once using the `read` object function, or read data items one-by-one sequentially using the `readNext` object function.

```
adtfReader = adtfFileReader("sample_adtf.dat","sample_adtf.description");
streamReader = select(adtfReader, TimeRange=[0, minutes(1)]);
data = read(streamReader);
```

Properties

DataFileName — Absolute path to ADTF DAT file

string scalar

This property is read-only.

Absolute path to the ADTF DAT file to read, specified as a string scalar.

DescriptionFileName — Absolute path to description file

string scalar

This property is read-only.

Absolute path to the description file, specified as a string scalar.

PluginDirectory — Absolute path to ADTF plugin directory

string scalar

This property is read-only.

Absolute path to ADTF plugin directory, specified as a string scalar.

StreamIndex — Indices of selected streams

vector of positive integers

This property is read-only.

Indices of the selected streams, specified as a vector of positive integers. The length of the vector is equal to the number of selected streams

StartIndex — Index of first data item for each stream in selection

vector of positive integers

This property is read-only.

Index of first data item for each stream in the selection, specified as a vector of positive integers. The length of the vector is equal to the number of streams in the selection.

EndIndex — Index of final data item for each stream in selection

vector of positive integers

This property is read-only.

Index of final data item for each stream in the selection, specified as a vector of positive integers. The length of the vector is equal to the number of streams in the selection.

CurrentIndexOffset — Current index offset from StartIndex

0 (default) | nonnegative scalar

This property is read-only.

Current offset from `StartIndex`, specified as a nonnegative scalar. This property indicates the current index offset of each stream, starting from the `StartIndex` value of that stream, when reading data sequentially using the `readNext` function. The `hasNext` function also uses this value to determine whether any streams in the selection have subsequent data items to read. The default value of 0 indicates that any sequential reading operation begins at the `StartIndex` value of each stream. You can reset this index to 0 using the `reset` function.

StartTime — Timestamp of first data item of each stream in selection

duration scalar

This property is read-only.

Timestamp of the first data item of each stream in the selection, specified as a duration scalar.

Dependencies

To assign this property value, you must specify the `TimeRangename`-value argument of the `select` function. Otherwise, the value is an empty duration array.

EndTime — Timestamp of final data item of each stream in selection

duration scalar

This property is read-only.

Timestamp of final data item of each stream in the selection, specified as a duration scalar.

Dependencies

To assign this property value, you must specify the `TimeRangename`-value argument of the `select` function. Otherwise, the value is an empty duration array.

DataCount — Number of data items in each stream of selection

vector of nonnegative integers

This property is read-only.

Number of data items in each stream of the selection, specified as a vector of nonnegative integers. The length of the vector is equal to the number of streams in the selection.

Object Functions

`read` Read all data items from ADTF DAT file selection
`readNext` Read next available data item from each stream of ADTF DAT file selection
`hasNext` Check if the ADTF DAT file selection has next data
`reset` Reset stream reader to first data item in ADTF DAT file selection

Examples

Extract Video Stream From ADTF DAT File

This example shows how to extract and visualize a video stream, stored in an ADTF DAT file. It also shows how to write the video stream into a video file.

Download the sample video DAT file.

```
downloadURL = 'https://ssd.mathworks.com/supportfiles/driving/data/sample_can_video_dat.zip';
dataFolder = fullfile(tempdir, 'adtf-video', filesep);
options     = weboptions('Timeout', Inf);
zipFileName = [dataFolder, 'sample_can_video_dat.zip'];
folderExists = exist(dataFolder, 'dir');
```

```
% Create a folder in a temporary directory to save the downloaded file.
```

```
if ~folderExists
    mkdir(dataFolder);
    disp('Downloading sample_can_video_dat.zip (9.74 MB)...')
    websave(zipFileName, downloadURL, options);
```

```
% Extract contents of the downloaded file.
```

```
disp('Extracting sample_can_video_dat.zip...')
unzip(zipFileName, dataFolder);
```

```
end
```

```
Downloading sample_can_video_dat.zip (9.74 MB)...
```

```
Extracting sample_can_video_dat.zip...
```

Create the ADTF File Reader object.

```
datFileName = fullfile(dataFolder, "sample_can_video.dat");
fileReader = adtfFileReader(datFileName)
```

```
fileReader =
```

```
    DataFileName: "C:\Users\latriwal\AppData\Local\Temp\adtf-video\sample_can_video.dat"
  DescriptionFileName: ""
    PluginDirectory: ""
        StreamCount: 2
        StreamInfo:
```

StreamIndex	StreamName	StreamType	StartTime	EndTime	ItemCount	Subst
-------------	------------	------------	-----------	---------	-----------	-------

1	{'rawcan'}	{'UNRESOLVED'}	0 sec	14.805 sec	743	{0x1
2	{'video' }	{'adtf/image'}	0 sec	14.799 sec	149	{0x1

From the `StreamInfo` property, note that the index of the video stream is 2. Use the `select` function of the `adtfFileReader` object, to select the video stream for reading. The returned `adtfStreamReader` object has all the information about the selection.

```
streamReader = select(fileReader,2)
```

```
streamReader =  
  adtfStreamReader with properties:
```

```
    DataFileName: "C:\Users\latriwal\AppData\Local\Temp\adtf-video\sample_can_video.dat"  
  DescriptionFileName: ""  
    PluginDirectory: ""  
      StreamIndex: 2  
      StartIndex: 1  
      EndIndex: 149  
  CurrentIndexOffset: 0  
      StartTime: [0x0 duration]  
      EndTime: [0x0 duration]  
      DataCount: 149
```

Note that the value of `CurrentIndexOffset` is 0. This signifies that the next `readNext` call will return the first item.

Preview the first image frame from the stream.

```
firstFrame = readNext(streamReader);  
imshow(firstFrame.Data.Item)
```

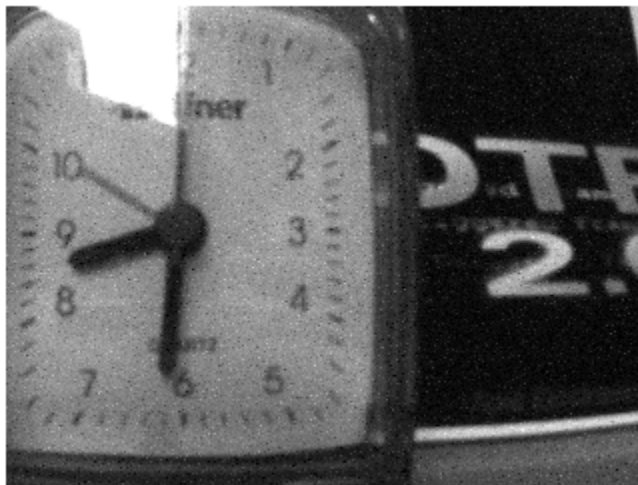

Before creating a video, use the `reset` function to start reading from the first frame. This resets the value of `CurrentIndexOffset` to 0.

```
reset(streamReader);
fprintf("CurrentIndexOffset = %d\n", streamReader.CurrentIndexOffset)
```

```
CurrentIndexOffset = 0
```

Create a `VideoWriter` object that you can use to write image frames to a video file. Specify a frame rate of 1 frame per second.

```
videoWriterObj = VideoWriter("example_video.avi");
videoWriterObj.FrameRate = 1;
open(videoWriterObj);
```

Using the `streamReader` object, iterate over the data items in the selection one-by-one. The `hasNext` function determines if there is an item left to read as we are incrementally reading the file. `readNext` returns the data item which is basically a structure containing the data and the associated timestamp. In every iteration, extract the image frame and write it to the video file.

```
while streamReader.hasNext()
    streamData = streamReader.readNext();
    imageFrame = streamData.Data.Item;
    frame      = im2frame(streamData.Data.Item, gray);
    writeVideo(videoWriterObj, frame);
end
```

Alternatively, you can read all the image frames at once, using the `read` function, and iterate over it later.

```
allData = read(streamReader)

allData = struct with fields:
    StreamIndex: 2
    Data: [149x1 struct]
```

Close the connection with the video file.

```
close(videoWriterObj);
close all
```

Visualize the output file `example_video.avi` using Video Viewer.

```
imshow("example_video.avi")
```

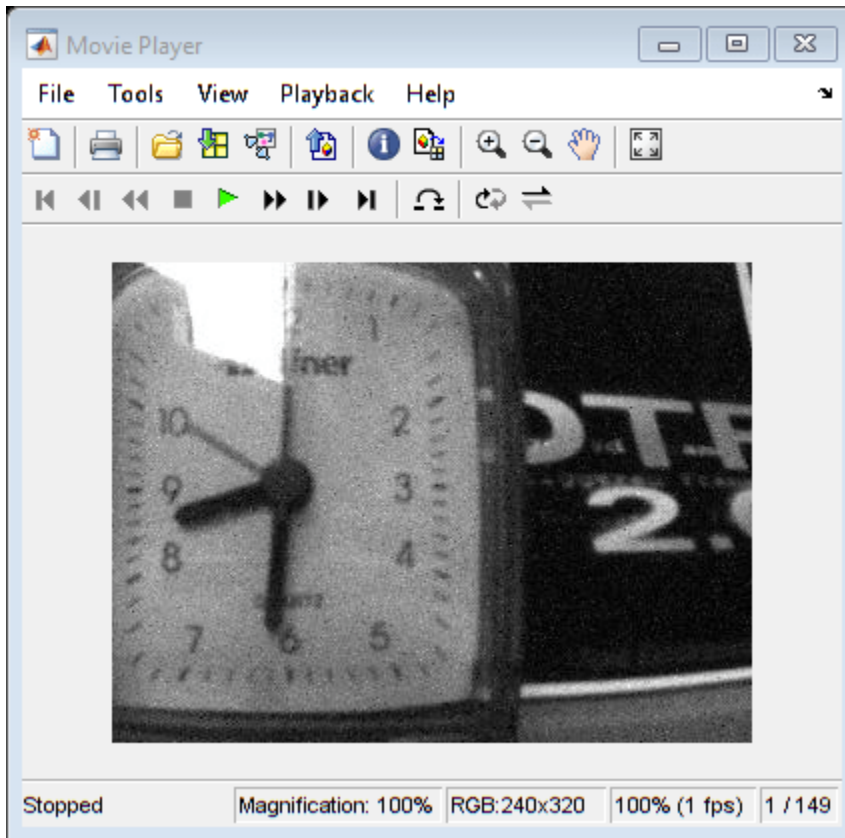

Limitations

- Reading DAT files on Mac platforms is not supported.
- Reading these stream types is not supported:
 - adtf/anonymous
 - adtf/audio
- For reading adtf/video_compressed stream type, only JPEG compression format is supported.

Version History

Introduced in R2022a

See Also

adtfFileReader | select | read | readNext | hasNext | reset

Topics

“Read Data From ADTF DAT Files”

select

Create reader for selected subset of ADTF DAT file data

Syntax

```
streamReader = select(adtfReader)
streamReader = select(adtfReader,streamIndices)
streamReader = select(adtfReader,streamName)
streamReader = select( ____,Name=Value)
```

Description

Use the `select` object function to create a reader for a selected subset of stream data to read from the ADTF DAT file. You can select streams using either the stream indices or stream name. Additionally, you can specify an index range or time range of data, to select from each of the specified streams. The `select` function returns an `adtfStreamReader` object, which you can use to read data from the selected streams in the ADTF DAT file.

`streamReader = select(adtfReader)` creates an `adtfStreamReader` object, `streamReader`, that can read data from all streams in the Automotive Data and Time-Triggered Framework (ADTF) DAT file associated with the specified `adtfFileReader` object `adtfReader`.

`streamReader = select(adtfReader,streamIndices)` specifies a subset of streams from the ADTF DAT file using the stream indices `streamIndices`.

`streamReader = select(adtfReader,streamName)` specifies a data stream from the ADTF DAT file using the stream name `streamName`.

`streamReader = select(____,Name=Value)` specifies an additional option using one `Name=Value` pair argument, in addition to any combination of input arguments from previous syntaxes. You must use only one name-value argument, specifying either the index range or time range of data to read from the selected streams. For example, `IndexRange=[1 30]` selects the first thirty frames of data from each selected stream.

Examples

Extract Video Stream From ADTF DAT File

This example shows how to extract and visualize a video stream, stored in an ADTF DAT file. It also shows how to write the video stream into a video file.

Download the sample video DAT file.

```
downloadURL = 'https://ssd.mathworks.com/supportfiles/driving/data/sample_can_video_dat.zip';
dataFolder  = fullfile(tempdir, 'adtf-video', filesep);
options     = weboptions('Timeout', Inf);
zipFileName = [dataFolder, 'sample_can_video_dat.zip'];
folderExists = exist(dataFolder, 'dir');
```

```

% Create a folder in a temporary directory to save the downloaded file.
if ~folderExists
    mkdir(dataFolder);
    disp('Downloading sample_can_video_dat.zip (9.74 MB)...')
    websave(zipFileName, downloadURL, options);

    % Extract contents of the downloaded file.
    disp('Extracting sample_can_video_dat.zip...')
    unzip(zipFileName, dataFolder);
end

```

Downloading sample_can_video_dat.zip (9.74 MB)...

Extracting sample_can_video_dat.zip...

Create the ADTF File Reader object.

```

datFileName = fullfile(dataFolder,"sample_can_video.dat");
fileReader = adtfFileReader(datFileName)

```

```

fileReader =
    DataFileName: "C:\Users\latrival\AppData\Local\Temp\adtf-video\sample_can_video.dat"
    DescriptionFileName: ""
    PluginDirectory: ""
    StreamCount: 2
    StreamInfo:

```

StreamIndex	StreamName	StreamType	StartTime	EndTime	ItemCount	Subst
1	{'rawcan'}	{'UNRESOLVED'}	0 sec	14.805 sec	743	{0x1 }
2	{'video' }	{'adtf/image'}	0 sec	14.799 sec	149	{0x1 }

From the `StreamInfo` property, note that the index of the video stream is 2. Use the `select` function of the `adtfFileReader` object, to select the video stream for reading. The returned `adtfStreamReader` object has all the information about the selection.

```

streamReader = select(fileReader,2)

```

```

streamReader =
    adtfStreamReader with properties:

```

```

    DataFileName: "C:\Users\latrival\AppData\Local\Temp\adtf-video\sample_can_video.dat"
    DescriptionFileName: ""
    PluginDirectory: ""
    StreamIndex: 2
    StartIndex: 1
    EndIndex: 149
    CurrentIndexOffset: 0
    StartTime: [0x0 duration]
    EndTime: [0x0 duration]
    DataCount: 149

```

Note that the value of `CurrentIndexOffset` is 0. This signifies that the next `readNext` call will return the first item.

Preview the first image frame from the stream.

```
firstFrame = readNext(streamReader);
imshow(firstFrame.Data.Item)
```

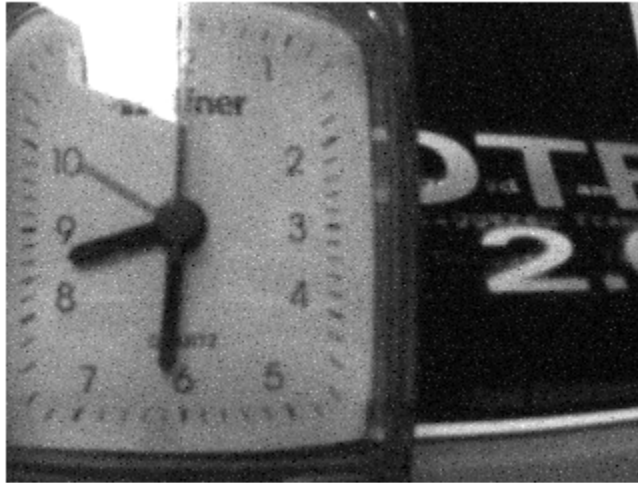

Before creating a video, use the `reset` function to start reading from the first frame. This resets the value of `CurrentIndexOffset` to 0.

```
reset(streamReader);
fprintf("CurrentIndexOffset = %d\n", streamReader.CurrentIndexOffset)
```

```
CurrentIndexOffset = 0
```

Create a `VideoWriter` object that you can use to write image frames to a video file. Specify a frame rate of 1 frame per second.

```
videoWriterObj = VideoWriter("example_video.avi");
videoWriterObj.FrameRate = 1;
open(videoWriterObj);
```

Using the `streamReader` object, iterate over the data items in the selection one-by-one. The `hasNext` function determines if there is an item left to read as we are incrementally reading the file. `readNext` returns the data item which is basically a structure containing the data and the associated timestamp. In every iteration, extract the image frame and write it to the video file.

```
while streamReader.hasNext()
    streamData = streamReader.readNext();
    imageFrame = streamData.Data.Item;
    frame      = im2frame(streamData.Data.Item, gray);
    writeVideo(videoWriterObj, frame);
end
```

Alternatively, you can read all the image frames at once, using the `read` function, and iterate over it later.

```
allData = read(streamReader)
allData = struct with fields:
    StreamIndex: 2
    Data: [149x1 struct]
```

Close the connection with the video file.

```
close(videoWriterObj);
close all
```

Visualize the output file `example_video.avi` using Video Viewer.

```
imshow("example_video.avi")
```

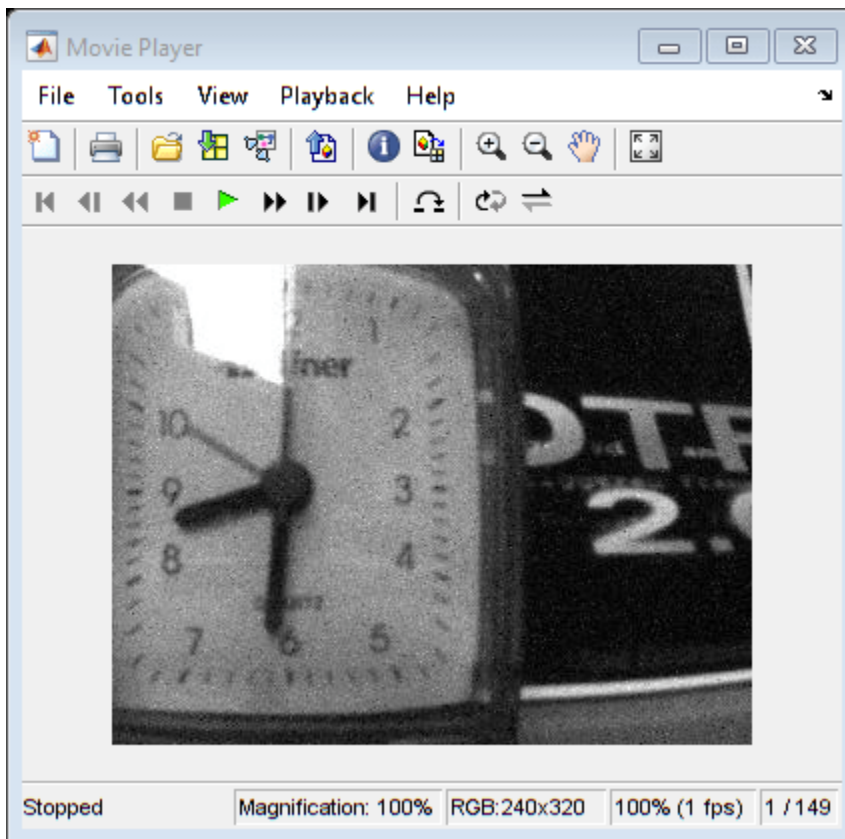

Input Arguments

adtFReader — ADTF file reader

adtFFileReader object

ADTF file reader, specified as an `adtFFileReader` object.

streamIndices — Linear indices of streams

vector of positive integers

Linear indices of the streams to select, specified as a vector of positive integers.

streamName — Name of the stream

string scalar

Name of the stream to select, specified as a string scalar.

Name-Value Pair Arguments

Specify optional pair of arguments as `Name=Value`, where `Name` is the argument name and `Value` is the corresponding value. This function supports only one Name-value argument per syntax and it must appear after other arguments.

Example: `select(adtfReader, IndexRange=[1 10])` selects the first 10 frames from each stream of the ADTF DAT file associated with the specified ADTF file reader.

IndexRange — Index range of data to select from selected streams

two-element vector of positive integers

Index range of data to select from the selected streams, specified as a two-element vector of positive integers. The first element specifies the initial index to select from each stream, and the second element specifies the final index to select from each stream.

TimeRange — Time range of data to select from selected streams

two-element duration vector

Time range of data to select from selected streams, specified as a two-element duration vector of the form `[startTime endTime]`.

Output Arguments**streamReader — Stream reader**

adtfStreamReader object

Stream reader, returned as an `adtfStreamReader` object. This object enables you to read data from the selected streams in the ADTF DAT file.

Version History

Introduced in R2022a

See Also`adtfStreamReader` | `adtfFileReader` | `read` | `readNext`**Topics**

"Read Data From ADTF DAT Files"

read

Read all data items from ADTF DAT file selection

Syntax

```
data = read(streamReader)
```

Description

`data = read(streamReader)` reads all data from the `adtfStreamReader` object `streamReader` across all streams, and returns it in the form of the structure array, `data`.

Examples

Extract Video Stream From ADTF DAT File

This example shows how to extract and visualize a video stream, stored in an ADTF DAT file. It also shows how to write the video stream into a video file.

Download the sample video DAT file.

```
downloadURL = 'https://ssd.mathworks.com/supportfiles/driving/data/sample_can_video_dat.zip';
dataFolder  = fullfile(tempdir, 'adtf-video', filesep);
options     = weboptions('Timeout', Inf);
zipFileName = [dataFolder, 'sample_can_video_dat.zip'];
folderExists = exist(dataFolder, 'dir');

% Create a folder in a temporary directory to save the downloaded file.
if ~folderExists
    mkdir(dataFolder);
    disp('Downloading sample_can_video_dat.zip (9.74 MB)...')
    websave(zipFileName, downloadURL, options);

    % Extract contents of the downloaded file.
    disp('Extracting sample_can_video_dat.zip...')
    unzip(zipFileName, dataFolder);
end
```

```
Downloading sample_can_video_dat.zip (9.74 MB)...
```

```
Extracting sample_can_video_dat.zip...
```

Create the ADTF File Reader object.

```
datFileName = fullfile(dataFolder, "sample_can_video.dat");
fileReader  = adtfFileReader(datFileName)
```

```
fileReader =
    DataFileName: "C:\Users\latrival\AppData\Local\Temp\adtf-video\sample_can_video.da
    DescriptionFileName: ""
    PluginDirectory: ""
```

```

StreamCount: 2
StreamInfo:

```

StreamIndex	StreamName	StreamType	StartTime	EndTime	ItemCount	Subst
1	{'rawcan'}	{'UNRESOLVED'}	0 sec	14.805 sec	743	{0x1
2	{'video' }	{'adtf/image'}	0 sec	14.799 sec	149	{0x1

From the `StreamInfo` property, note that the index of the video stream is 2. Use the `select` function of the `adtfFileReader` object, to select the video stream for reading. The returned `adtfStreamReader` object has all the information about the selection.

```
streamReader = select(fileReader,2)
```

```
streamReader =
```

```
adtfStreamReader with properties:
```

```

    DataFileName: "C:\Users\latriwal\AppData\Local\Temp\adtf-video\sample_can_video.dat"
  DescriptionFileName: ""
    PluginDirectory: ""
    StreamIndex: 2
    StartIndex: 1
    EndIndex: 149
  CurrentIndexOffset: 0
    StartTime: [0x0 duration]
    EndTime: [0x0 duration]
    DataCount: 149

```

Note that the value of `CurrentIndexOffset` is 0. This signifies that the next `readNext` call will return the first item.

Preview the first image frame from the stream.

```
firstFrame = readNext(streamReader);
imshow(firstFrame.Data.Item)
```

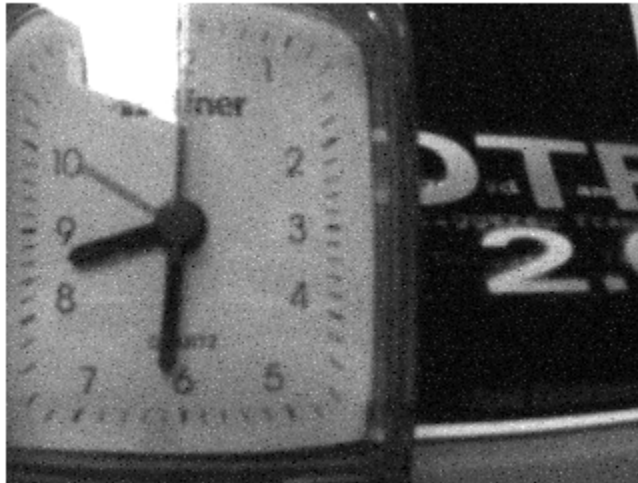

Before creating a video, use the `reset` function to start reading from the first frame. This resets the value of `CurrentIndexOffset` to 0.

```
reset(streamReader);  
fprintf("CurrentIndexOffset = %d\n", streamReader.CurrentIndexOffset)
```

```
CurrentIndexOffset = 0
```

Create a `VideoWriter` object that you can use to write image frames to a video file. Specify a frame rate of 1 frame per second.

```
videoWriterObj = VideoWriter("example_video.avi");  
videoWriterObj.FrameRate = 1;  
open(videoWriterObj);
```

Using the `streamReader` object, iterate over the data items in the selection one-by-one. The `hasNext` function determines if there is an item left to read as we are incrementally reading the file. `readNext` returns the data item which is basically a structure containing the data and the associated timestamp. In every iteration, extract the image frame and write it to the video file.

```
while streamReader.hasNext()  
    streamData = streamReader.readNext();  
    imageFrame = streamData.Data.Item;  
    frame      = im2frame(streamData.Data.Item, gray);  
    writeVideo(videoWriterObj, frame);  
end
```

Alternatively, you can read all the image frames at once, using the `read` function, and iterate over it later.

```
allData = read(streamReader)  
  
allData = struct with fields:  
    StreamIndex: 2
```



```
Data: [149x1 struct]
```

Close the connection with the video file.

```
close(videoWriterObj);
close all
```

Visualize the output file `example_video.avi` using Video Viewer.

```
implay("example_video.avi")
```

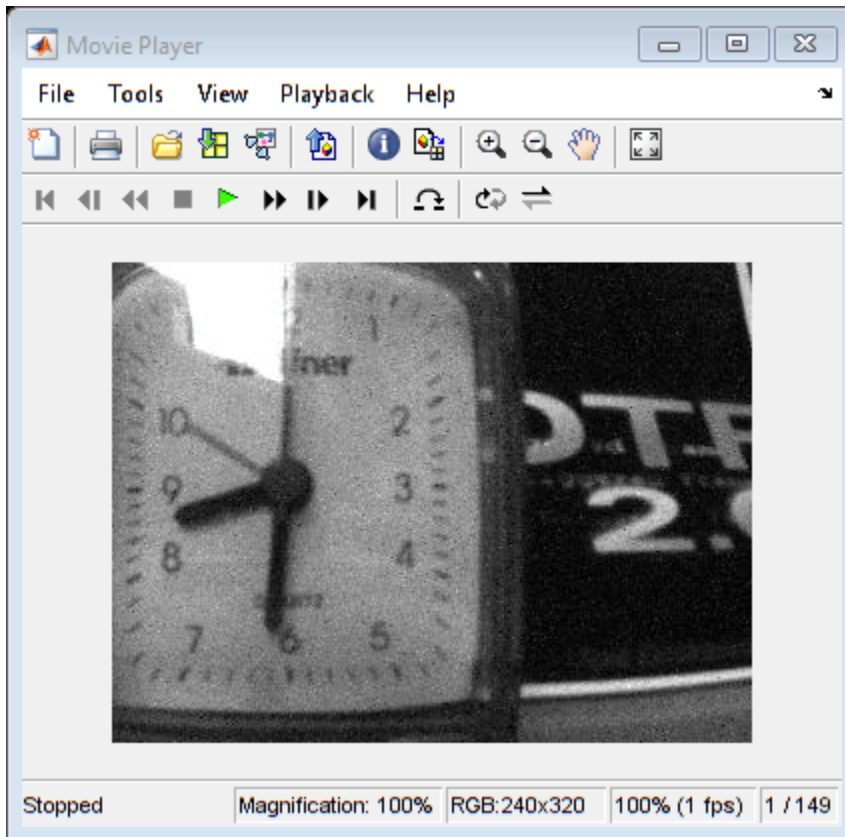

Input Arguments

streamReader — Stream reader

adtfStreamReader object

Stream reader, specified as an `adtfStreamReader` object.

Output Arguments

data — All data items from selection across all streams

N -by-1 structure array

All data items from the selection across all streams, returned as an N -by-1 structure array. N is the number of streams in the selection. Each element in `data` is a structure that has these fields:

- `StreamIndex` — Index of the stream the data comes from.
- `Data` — Structure array containing all data items from the stream. Each structure in the array has these fields:
 - `ChunkTimestamp` — Time at which the data item was written to the DAT file.
 - `SampleTimestamp` — Time at which the data item was collected at the source.
 - `Item` — Data item.
 - `ItemName` — Name of the structure stored in `Item`.
 - `IsValid` — Flag indicating whether the read operation was successful, stored as a logical value.
 - `SubstreamIndex` — Index of the substream, if the data item belongs to one.

Version History

Introduced in R2022a

See Also

`adtfFileReader` | `select` | `adtfStreamReader` | `readNext` | `hasNext` | `reset`

Topics

“Read Data From ADTF DAT Files”

readNext

Read next available data item from each stream of ADTF DAT file selection

Syntax

```
data = readNext(streamReader)
```

Description

`data = readNext(streamReader)` reads the next available data item in each stream of the `adtfStreamReader` object `streamReader` across. `data` is a structure containing nested structures, arrays based on the contents of the files. By default, `readNext` initially reads from the first data item in each stream of the selection. It then reads subsequent data items during successive calls, up to the last available item across all streams. To reset the reading operation back to the first data item, use the `reset` object function of the `adtfStreamReader` object.

When reading from a selection that contains multiple streams, if some streams reach the end of selection criteria, then this function reads only from the remaining data streams.

Examples

Extract Video Stream From ADTF DAT File

This example shows how to extract and visualize a video stream, stored in an ADTF DAT file. It also shows how to write the video stream into a video file.

Download the sample video DAT file.

```
downloadURL = 'https://ssd.mathworks.com/supportfiles/driving/data/sample_can_video_dat.zip';
dataFolder  = fullfile(tempdir, 'adtf-video', filesep);
options     = weboptions('Timeout', Inf);
zipFileName = [dataFolder, 'sample_can_video_dat.zip'];
folderExists = exist(dataFolder, 'dir');

% Create a folder in a temporary directory to save the downloaded file.
if ~folderExists
    mkdir(dataFolder);
    disp('Downloading sample_can_video_dat.zip (9.74 MB)...')
    websave(zipFileName, downloadURL, options);

    % Extract contents of the downloaded file.
    disp('Extracting sample_can_video_dat.zip...')
    unzip(zipFileName, dataFolder);
end
```

```
Downloading sample_can_video_dat.zip (9.74 MB)...
```

```
Extracting sample_can_video_dat.zip...
```

Create the ADTF File Reader object.

```
datFileName = fullfile(dataFolder, "sample_can_video.dat");
fileReader = adtfFileReader(datFileName)
```

```
fileReader =
    DataFileName: "C:\Users\latriwal\AppData\Local\Temp\adtf-video\sample_can_video.dat"
    DescriptionFileName: ""
    PluginDirectory: ""
    StreamCount: 2
    StreamInfo:
```

StreamIndex	StreamName	StreamType	StartTime	EndTime	ItemCount	Subst
1	{'rawcan'}	{'UNRESOLVED'}	0 sec	14.805 sec	743	{0x1 s
2	{'video' }	{'adtf/image'}	0 sec	14.799 sec	149	{0x1 s

From the `StreamInfo` property, note that the index of the video stream is 2. Use the `select` function of the `adtfFileReader` object, to select the video stream for reading. The returned `adtfStreamReader` object has all the information about the selection.

```
streamReader = select(fileReader,2)
```

```
streamReader =
    adtfStreamReader with properties:
        DataFileName: "C:\Users\latriwal\AppData\Local\Temp\adtf-video\sample_can_video.dat"
        DescriptionFileName: ""
        PluginDirectory: ""
        StreamIndex: 2
        StartIndex: 1
        EndIndex: 149
        CurrentIndexOffset: 0
        StartTime: [0x0 duration]
        EndTime: [0x0 duration]
        DataCount: 149
```

Note that the value of `CurrentIndexOffset` is 0. This signifies that the next `readNext` call will return the first item.

Preview the first image frame from the stream.

```
firstFrame = readNext(streamReader);
imshow(firstFrame.Data.Item)
```

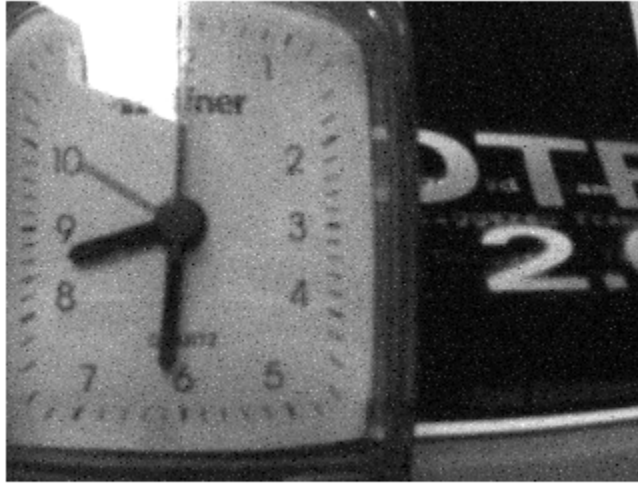

Before creating a video, use the `reset` function to start reading from the first frame. This resets the value of `CurrentIndexOffset` to 0.

```
reset(streamReader);
fprintf("CurrentIndexOffset = %d\n", streamReader.CurrentIndexOffset)
```

```
CurrentIndexOffset = 0
```

Create a `VideoWriter` object that you can use to write image frames to a video file. Specify a frame rate of 1 frame per second.

```
videoWriterObj = VideoWriter("example_video.avi");
videoWriterObj.FrameRate = 1;
open(videoWriterObj);
```

Using the `streamReader` object, iterate over the data items in the selection one-by-one. The `hasNext` function determines if there is an item left to read as we are incrementally reading the file. `readNext` returns the data item which is basically a structure containing the data and the associated timestamp. In every iteration, extract the image frame and write it to the video file.

```
while streamReader.hasNext()
    streamData = streamReader.readNext();
    imageFrame = streamData.Data.Item;
    frame      = im2frame(streamData.Data.Item, gray);
    writeVideo(videoWriterObj, frame);
end
```

Alternatively, you can read all the image frames at once, using the `read` function, and iterate over it later.

```
allData = read(streamReader)

allData = struct with fields:
    StreamIndex: 2
```

```
Data: [149x1 struct]
```

Close the connection with the video file.

```
close(videoWriterObj);
close all
```

Visualize the output file `example_video.avi` using Video Viewer.

```
implay("example_video.avi")
```

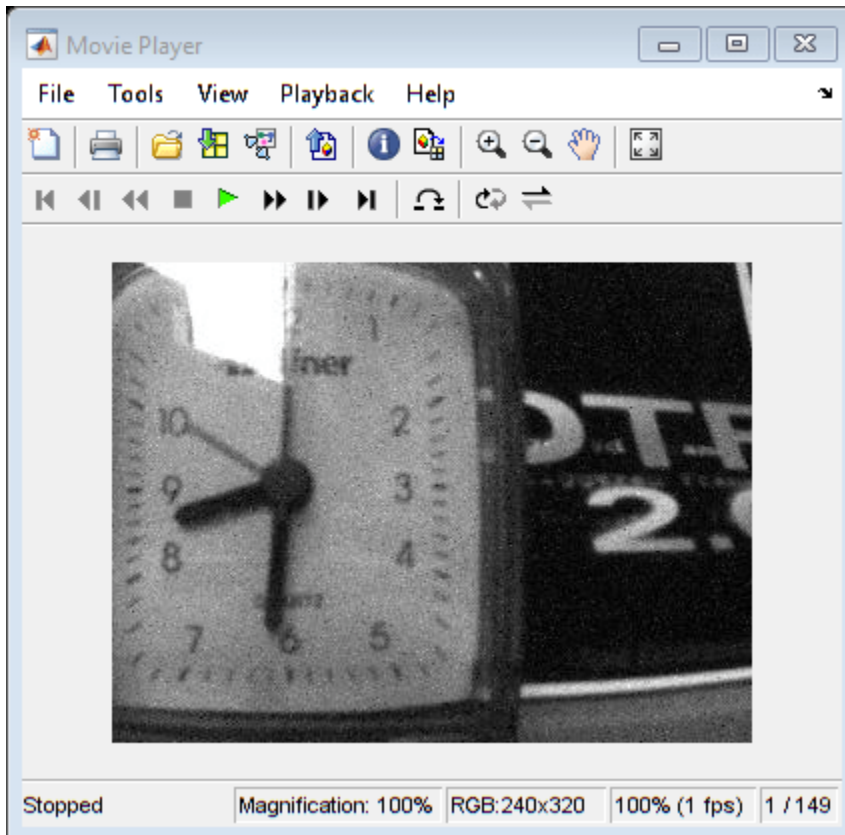

Input Arguments

streamReader — Stream reader

`adtfstreamReader` object

Stream reader, specified as an `adtfstreamReader` object.

Output Arguments

data — Next available data item from each stream of selection

structure array

Next available data item from each stream of the selection, returned as an N -by-1 structure array. N is the number of streams in the selection. Each element in `data` is a structure that has these fields:

- `StreamIndex` — Index of the stream the data comes from.
- `Data` — Structure array containing all data items from the stream. Each structure in the array has these fields:
 - `SampleTimestamp` — Time of data item collection.
 - `ChunkTimestamp` — Time of data item writing to the DAT file.
 - `Item` — Data item.
 - `IsValid` — Flag indicating whether the read operation was successful, stored as a logical value.
 - `ItemName` — Name of the structure stored in `Item`.
 - `SubstreamIndex` — Index of the substream, if the data item belongs to one.

Version History

Introduced in R2022a

See Also

`adtfFileReader` | `select` | `adtfStreamReader` | `read` | `hasNext` | `reset`

Topics

“Read Data From ADTF DAT Files”

hasNext

Check if the ADTF DAT file selection has next data

Syntax

```
flag = hasNext(streamReader)
```

Description

`flag = hasNext(streamReader)` returns `true` if one or more streams of the ADTF DAT file specified by the `adtfStreamReader` object `streamReader`, has a next available data item to read. Otherwise, it returns `false`.

When reading from a selection with multiple streams, if some streams reach the end of selection criteria, then this function returns `true` as long as there is next available data item in at least one stream.

Examples

Extract Video Stream From ADTF DAT File

This example shows how to extract and visualize a video stream, stored in an ADTF DAT file. It also shows how to write the video stream into a video file.

Download the sample video DAT file.

```
downloadURL = 'https://ssd.mathworks.com/supportfiles/driving/data/sample_can_video_dat.zip';  
dataFolder = fullfile(tempdir, 'adtf-video', filesep);  
options = weboptions('Timeout', Inf);  
zipFileName = [dataFolder, 'sample_can_video_dat.zip'];  
folderExists = exist(dataFolder, 'dir');
```

```
% Create a folder in a temporary directory to save the downloaded file.
```

```
if ~folderExists  
    mkdir(dataFolder);  
    disp('Downloading sample_can_video_dat.zip (9.74 MB)...')  
    websave(zipFileName, downloadURL, options);
```

```
% Extract contents of the downloaded file.
```

```
disp('Extracting sample_can_video_dat.zip...')  
unzip(zipFileName, dataFolder);
```

```
end
```

```
Downloading sample_can_video_dat.zip (9.74 MB)...
```

```
Extracting sample_can_video_dat.zip...
```

Create the ADTF File Reader object.

```
datFileName = fullfile(dataFolder, "sample_can_video.dat");  
fileReader = adtfFileReader(datFileName)
```



```
fileReader =
    DataFileName: "C:\Users\latriwal\AppData\Local\Temp\adtf-video\sample_can_video.dat"
    DescriptionFileName: ""
    PluginDirectory: ""
    StreamCount: 2
    StreamInfo:

```

StreamIndex	StreamName	StreamType	StartTime	EndTime	ItemCount	Subst
1	{'rawcan'}	{'UNRESOLVED'}	0 sec	14.805 sec	743	{0x1 }
2	{'video' }	{'adtf/image'}	0 sec	14.799 sec	149	{0x1 }

From the `StreamInfo` property, note that the index of the video stream is 2. Use the `select` function of the `adtfFileReader` object, to select the video stream for reading. The returned `adtfStreamReader` object has all the information about the selection.

```
streamReader = select(fileReader,2)
```

```
streamReader =
    adtfStreamReader with properties:
        DataFileName: "C:\Users\latriwal\AppData\Local\Temp\adtf-video\sample_can_video.dat"
        DescriptionFileName: ""
        PluginDirectory: ""
        StreamIndex: 2
        StartIndex: 1
        EndIndex: 149
        CurrentIndexOffset: 0
        StartTime: [0x0 duration]
        EndTime: [0x0 duration]
        DataCount: 149
```

Note that the value of `CurrentIndexOffset` is 0. This signifies that the next `readNext` call will return the first item.

Preview the first image frame from the stream.

```
firstFrame = readNext(streamReader);
imshow(firstFrame.Data.Item)
```

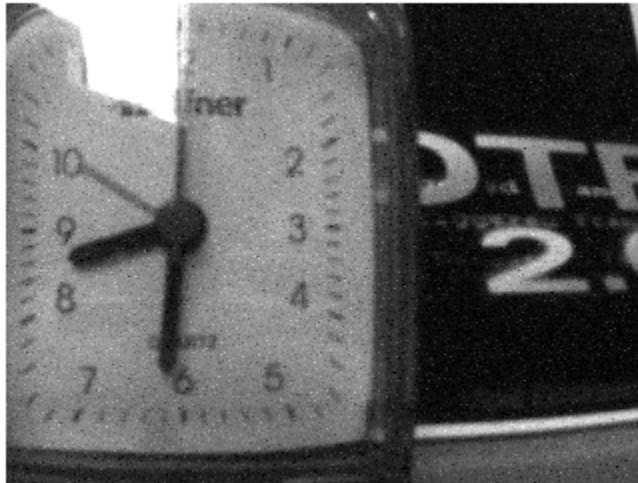

Before creating a video, use the `reset` function to start reading from the first frame. This resets the value of `CurrentIndexOffset` to 0.

```
reset(streamReader);
fprintf("CurrentIndexOffset = %d\n", streamReader.CurrentIndexOffset)
```

```
CurrentIndexOffset = 0
```

Create a `VideoWriter` object that you can use to write image frames to a video file. Specify a frame rate of 1 frame per second.

```
videoWriterObj = VideoWriter("example_video.avi");
videoWriterObj.FrameRate = 1;
open(videoWriterObj);
```

Using the `streamReader` object, iterate over the data items in the selection one-by-one. The `hasNext` function determines if there is an item left to read as we are incrementally reading the file. `readNext` returns the data item which is basically a structure containing the data and the associated timestamp. In every iteration, extract the image frame and write it to the video file.

```
while streamReader.hasNext()
    streamData = streamReader.readNext();
    imageFrame = streamData.Data.Item;
    frame      = im2frame(streamData.Data.Item, gray);
    writeVideo(videoWriterObj, frame);
end
```

Alternatively, you can read all the image frames at once, using the `read` function, and iterate over it later.

```
allData = read(streamReader)

allData = struct with fields:
    StreamIndex: 2
```

```
Data: [149x1 struct]
```

Close the connection with the video file.

```
close(videoWriterObj);
close all
```

Visualize the output file `example_video.avi` using Video Viewer.

```
imshow("example_video.avi")
```

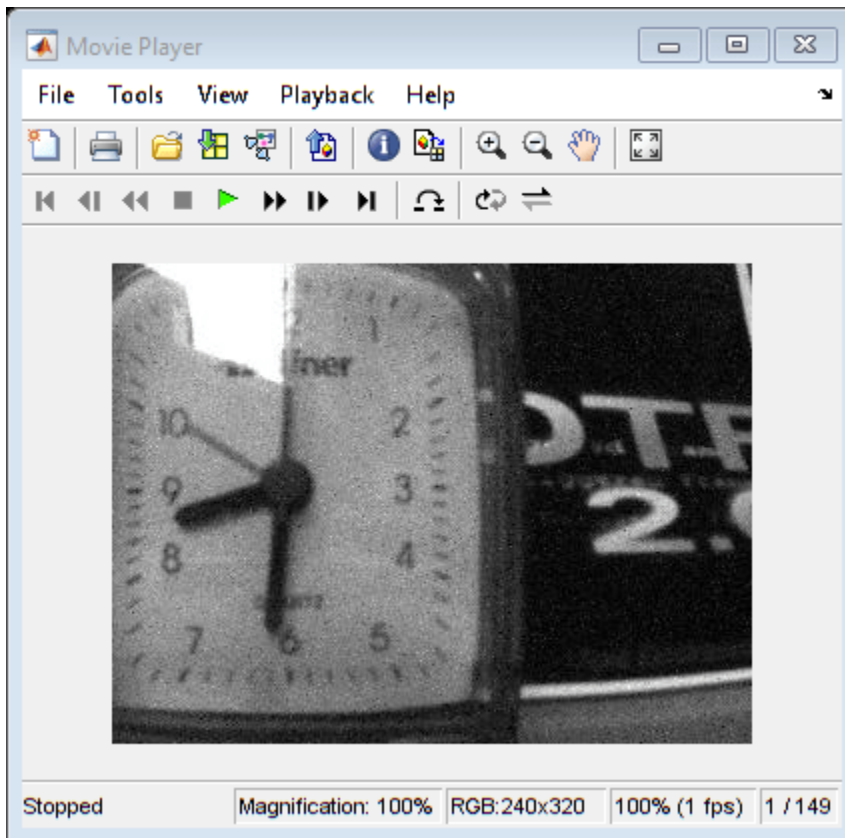

Input Arguments

streamReader — Stream reader

adtfStreamReader object

Stream reader, specified as an `adtfStreamReader` object.

Output Arguments

flag — File selection has next available data item to read

true or 1 | false or 0

File selection has a next available data item to read, returned as a logical 1 (true) or 0 (false).

Version History

Introduced in R2022a

See Also

[adtfFileReader](#) | [select](#) | [adtfStreamReader](#) | [readNext](#) | [reset](#)

Topics

[“Read Data From ADTF DAT Files”](#)

reset

Reset stream reader to first data item in ADTF DAT file selection

Syntax

```
reset(streamReader)
```

Description

`reset(streamReader)` resets the `adtfStreamReader` object, `StreamReader` to the first data item in the associated ADTF DAT file selection. Use this to read from the beginning of the file selection when you are reading data items sequentially with the `readNext` function.

Examples

Extract Video Stream From ADTF DAT File

This example shows how to extract and visualize a video stream, stored in an ADTF DAT file. It also shows how to write the video stream into a video file.

Download the sample video DAT file.

```
downloadURL = 'https://ssd.mathworks.com/supportfiles/driving/data/sample_can_video_dat.zip';
dataFolder  = fullfile(tempdir, 'adtf-video', filesep);
options      = weboptions('Timeout', Inf);
zipFileName = [dataFolder, 'sample_can_video_dat.zip'];
folderExists = exist(dataFolder, 'dir');

% Create a folder in a temporary directory to save the downloaded file.
if ~folderExists
    mkdir(dataFolder);
    disp('Downloading sample_can_video_dat.zip (9.74 MB)...')
    websave(zipFileName, downloadURL, options);

    % Extract contents of the downloaded file.
    disp('Extracting sample_can_video_dat.zip...')
    unzip(zipFileName, dataFolder);
end
```

```
Downloading sample_can_video_dat.zip (9.74 MB)...
```

```
Extracting sample_can_video_dat.zip...
```

Create the ADTF File Reader object.

```
datFileName = fullfile(dataFolder, "sample_can_video.dat");
fileReader  = adtfFileReader(datFileName)
```

```
fileReader =
    DataFileName: "C:\Users\latrival\AppData\Local\Temp\adtf-video\sample_can_video.da
    DescriptionFileName: ""
```

```

        PluginDirectory: ""
        StreamCount: 2
        StreamInfo:

```

StreamIndex	StreamName	StreamType	StartTime	EndTime	ItemCount	Subst
1	{'rawcan'}	{'UNRESOLVED'}	0 sec	14.805 sec	743	{0x1 9
2	{'video' }	{'adtf/image'}	0 sec	14.799 sec	149	{0x1 9

From the `StreamInfo` property, note that the index of the video stream is 2. Use the `select` function of the `adtfFileReader` object, to select the video stream for reading. The returned `adtfStreamReader` object has all the information about the selection.

```
streamReader = select(fileReader,2)
```

```
streamReader =
```

```
adtfStreamReader with properties:
```

```

        DataFileName: "C:\Users\latriwal\AppData\Local\Temp\adtf-video\sample_can_video.dat"
        DescriptionFileName: ""
        PluginDirectory: ""
        StreamIndex: 2
        StartIndex: 1
        EndIndex: 149
        CurrentIndexOffset: 0
        StartTime: [0x0 duration]
        EndTime: [0x0 duration]
        DataCount: 149

```

Note that the value of `CurrentIndexOffset` is 0. This signifies that the next `readNext` call will return the first item.

Preview the first image frame from the stream.

```

firstFrame = readNext(streamReader);
imshow(firstFrame.Data.Item)

```

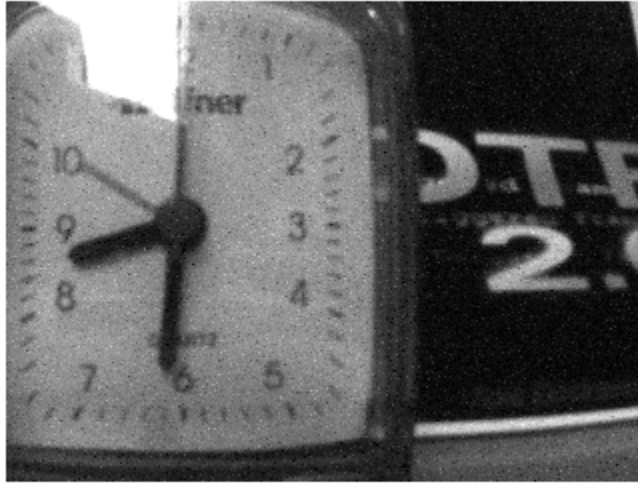

Before creating a video, use the `reset` function to start reading from the first frame. This resets the value of `CurrentIndexOffset` to 0.

```
reset(streamReader);
fprintf("CurrentIndexOffset = %d\n", streamReader.CurrentIndexOffset)
```

```
CurrentIndexOffset = 0
```

Create a `VideoWriter` object that you can use to write image frames to a video file. Specify a frame rate of 1 frame per second.

```
videoWriterObj = VideoWriter("example_video.avi");
videoWriterObj.FrameRate = 1;
open(videoWriterObj);
```

Using the `streamReader` object, iterate over the data items in the selection one-by-one. The `hasNext` function determines if there is an item left to read as we are incrementally reading the file. `readNext` returns the data item which is basically a structure containing the data and the associated timestamp. In every iteration, extract the image frame and write it to the video file.

```
while streamReader.hasNext()
    streamData = streamReader.readNext();
    imageFrame = streamData.Data.Item;
    frame      = im2frame(streamData.Data.Item, gray);
    writeVideo(videoWriterObj, frame);
end
```

Alternatively, you can read all the image frames at once, using the `read` function, and iterate over it later.

```
allData = read(streamReader)

allData = struct with fields:
    StreamIndex: 2
```

```
Data: [149x1 struct]
```

Close the connection with the video file.

```
close(videoWriterObj);  
close all
```

Visualize the output file `example_video.avi` using Video Viewer.

```
implay("example_video.avi")
```

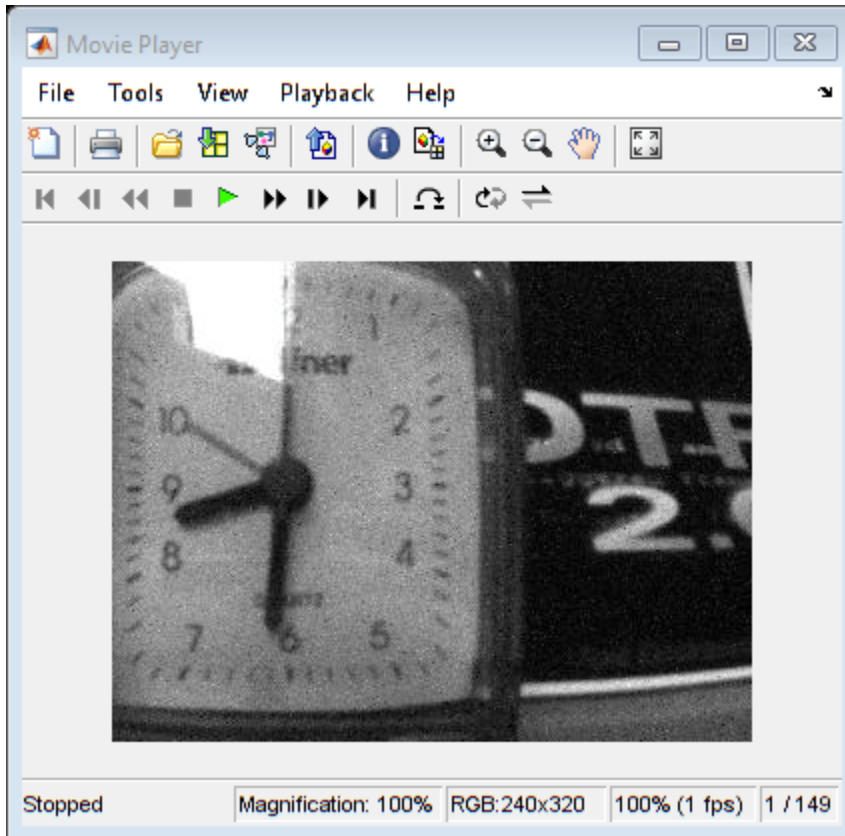

Input Arguments

streamReader — Stream reader

`adtfstreamReader` object

Stream reader, specified as an `adtfstreamReader` object.

Version History

Introduced in R2022a

See Also

`adtffileReader` | `select` | `adtfstreamReader` | `read` | `readNext` | `hasNext`

Topics

“Read Data From ADTF DAT Files”

ibeoFileReader

Read message headers from Ibeo Data Container (IDC) file

Description

Ibeo® Automotive Systems is a manufacturer of lidar sensor-based devices. The data from different sensors such as lidar and camera sensors, captured by these devices is stored in Ibeo Data Container (IDC) files. An `ibeoFileReader` object reads the message headers associated with the various sensors in an IDC file. Use the `select` object function to select messages of a specific type for reading, from an `ibeoFileReader` object.

Creation

Syntax

```
ibeoReader = ibeoFileReader(fileName)
```

Description

`ibeoReader = ibeoFileReader(fileName)` creates an `ibeoFileReader` object, `ibeoReader`, that reads message headers from the specified IDC file.

Input Arguments

fileName — IDC file name

string scalar | character vector

IDC file name, specified as a string or character vector.

Properties

FileName — Absolute path to IDC file

string

This property is read-only.

Absolute path to the IDC file to be read, specified as a string.

StartTime — Timestamp of first message in IDC file

datetime scalar

This property is read-only.

Timestamp of the first message in the IDC file with precision up to a nanosecond.

EndTime — Timestamp of final message in IDC file

datetime scalar

This property is read-only.

Timestamp of the final message in the IDC file, specified as a datetime scalar. This value is precise up to a nanosecond.

Duration — Total duration of IDC file in seconds

duration scalar

This property is read-only.

Total duration of IDC file in seconds specified as a duration scalar. This value is precise up to a nanosecond.

FileSummary — Summary table of all messages in file

table

This property is read-only.

A table with columns NumMessages, MessageID, and DeviceID. The table rows are named based on the message types in the IDC file that are supported for reading.

Object Functions

select Select subset of messages to read from Ibeo Data Container (IDC) file

Examples

Read Sensor Messages from IDC file

Create an `ibeoFileReader` object, `ibeoReader`, to read the message headers from an IDC file. Replace the placeholder argument `sample_data.idc` with the name of your IDC file as `sample_data.idc` file is not provided with the toolbox.

```
ibeoReader = ibeoFileReader('sample_data.idc')
```

```
ibeoReader =
```

```
ibeoFileReader with properties:
```

```

    FileName: "C:/Documents/MATLAB/ibeo_data/sample_data.idc"
    StartTime: 15-Mar-2020 11:21:04.999434999
    EndTime: 15-Mar-2020 11:25:35.030095000
    Duration: 00:04:30
FileSummary: CAN          53      msgs [0x1002]
              scan        53      msgs [0x2205]
              object     106      msgs [0x2281]
              image       53      msgs [0x2403]
              vehicleState 53      msgs [0x2808]
              measurementList 53    msgs [0x2821]
              pointCloudPlane 53    msgs [0x7510]
              unsupported  53      msgs [0x6120]
              unsupported  53      msgs [0x6970]
```

Create two `ibeoMessageReader` objects, `imgReader` and `objReader`, to read all image and object detection messages in the first 2 minutes, respectively, by using the `select` function with appropriate message type and time range values.

```
timeRange = [0 minutes(2)];
imgReader = select(ibeoReader, 'image', timeRange);
objReader = select(ibeoReader, 'object', timeRange);
```

Read the first 10 images and all object detection messages in the first 2 minutes, by using the `readMessages` function on the respective `ibeoMessageReader` objects with appropriate `indices` and `timeRange` arguments. Reading object detection messages returns both online objects and postprocessed objects along with their metadata.

```
imgs = readMessages(imgReader, 1:10);
[rawObjs, procObjs, rawMetadata, procMetadata] = readMessages(objReader);
```

Read and Visualize Sensor Messages from IDC File

Create an `ibeoFileReader` object, `ibeoReader`, to read the message headers from the IDC file. Replace the placeholder argument `sample_data.idc` with the name of your IDC file as `sample_data.idc` file is not provided with the toolbox.

```
ibeoReader = ibeoFileReader('sample_data.idc')
```

```
ibeoReader =
```

```
ibeoFileReader with properties:
```

```
FileName: "C:/Documents/MATLAB/ibeo_data/sample_data.idc"
StartTime: 15-Mar-2020 11:21:04.999434999
EndTime: 15-Mar-2020 11:25:35.030095000
Duration: 00:04:30
FileSummary: CAN          53      msgs [0x1002]
              scan        53      msgs [0x2205]
              object     106      msgs [0x2281]
              image       53      msgs [0x2403]
              vehicleState 53      msgs [0x2808]
              measurementList 53      msgs [0x2821]
              pointCloudPlane 53      msgs [0x7510]
              unsupported  53      msgs [0x6120]
              unsupported  53      msgs [0x6970]
```

Create an `ibeoMessageReader` object, `imgReader`, to read all images in the first 2 minutes, by using the `select` function with appropriate message type and time range values.

```
timeRange = [0, minutes(2)];
imgReader = select(ibeoReader, 'image', timeRange);
```

Visualize the message data by reading the messages one at a time to a video player object. First, create a `vision.VideoPlayer` object. Then, use the `hasNextMessage` function to check whether `imgReader` contains a message after the current one. If it does, use `readNextMessage` function to read the images into the workspace.

```
videoPlayer = vision.VideoPlayer;
while hasNextMessage(imgReader)
    img = readNextMessage(imgReader);
```

```
        step(videoPlayer, img);  
end  
release(videoPlayer);
```

Reset the `ibeoMessageReader` object, `imgReader`, to the first message in the selection, using the `reset` function.

```
reset(imgReader);
```

Limitations

- `ibeoFileReader` is designed for use with Ibeo Interface Specification v1.50. If you read older versions of IDC files, some fields may contain empty or random data.
- The `StartTime`, `EndTime`, and `Duration` properties do not include the arrival time of postprocessed object messages.

Version History

Introduced in R2021a

See Also

`select` | `ibeoMessageReader` | `readMessages` | `readNextMessage`

select

Select subset of messages to read from Ibeo Data Container (IDC) file

Syntax

```
msgReader = select(ibeoReader,msgType)
msgReader = select(ibeoReader,msgID)
msgReader = select( ____,timeRange)
msgReader = select( ____, 'DeviceID',deviceID)
```

Description

Use `select` object function to specify a subset of messages to read from the IDC file based on message type, message ID or device ID. The `select` method returns an `ibeoMessageReader` object which can be used to read the selected messages, from the IDC file. The supported values for message type and message ID are listed below. A Lidar Toolbox™ license is required to read `scan` and `pointCloudPlane` messages.

Message Type	Message ID	Ibeo Data Type Name
'scan'	'0x2205'	Ibeo FUSION SYSTEM/ECU scan data
'pointCloudPlane'	'0x7510'	Ibeo point cloud plane
'image'	'0x2403'	Ibeo FUSION SYSTEM/ECU image
'object'	'0x2281'	Ibeo FUSION SYSTEM/ECU object data
'vehicleState'	'0x2808'	Ibeo FUSION SYSTEM/ECU vehicle state
'measurementList'	'0x2821'	Ibeo FUSION SYSTEM/ECU measurement list
'CAN'	'0x1002'	Ibeo FUSION SYSTEM/ECU CAN messages

`msgReader = select(ibeoReader,msgType)` creates an `ibeoMessageReader` object, `msgReader`, that can read all messages of type, `msgType`, present in an `ibeoFileReader` object, `ibeoReader`.

`msgReader = select(ibeoReader,msgID)` creates an `ibeoMessageReader` object, `msgReader`, that can read all messages with ID, `msgID`, present in an `ibeoFileReader` object.

`msgReader = select(____,timeRange)` specifies a time range within which the `ibeoMessageReader` object can read messages, in addition to any combination of arguments from previous syntaxes.

`msgReader = select(____, 'DeviceID',deviceID)` specifies a device ID corresponding to which the `ibeoMessageReader` object can read messages, in addition to any combination of arguments from previous syntaxes.

Examples

Read Sensor Messages from IDC file

Create an `ibeoFileReader` object, `ibeoReader`, to read the message headers from an IDC file. Replace the placeholder argument `sample_data.idc` with the name of your IDC file as `sample_data.idc` file is not provided with the toolbox.

```
ibeoReader = ibeoFileReader('sample_data.idc')
```

```
ibeoReader =
```

```
ibeoFileReader with properties:
```

```

    FileName: "C:/Documents/MATLAB/ibeo_data/sample_data.idc"
    StartTime: 15-Mar-2020 11:21:04.999434999
    EndTime: 15-Mar-2020 11:25:35.030095000
    Duration: 00:04:30
FileSummary: CAN          53      msgs [0x1002]
              scan       53      msgs [0x2205]
              object    106     msgs [0x2281]
              image     53      msgs [0x2403]
              vehicleState 53     msgs [0x2808]
              measurementList 53    msgs [0x2821]
              pointCloudPlane 53    msgs [0x7510]
              unsupported 53     msgs [0x6120]
              unsupported 53     msgs [0x6970]
```

Create two `ibeoMessageReader` objects, `imgReader` and `objReader`, to read all image and object detection messages in the first 2 minutes, respectively, by using the `select` function with appropriate message type and time range values.

```
timeRange = [0 minutes(2)];
imgReader = select(ibeoReader, 'image', timeRange);
objReader = select(ibeoReader, 'object', timeRange);
```

Read the first 10 images and all object detection messages in the first 2 minutes, by using the `readMessages` function on the respective `ibeoMessageReader` objects with appropriate `indices` and `timeRange` arguments. Reading object detection messages returns both online objects and postprocessed objects along with their metadata.

```
imgs = readMessages(imgReader, 1:10);
[rawObjs, procObjs, rawMetadata, procMetadata] = readMessages(objReader);
```

Read and Visualize Sensor Messages from IDC File

Create an `ibeoFileReader` object, `ibeoReader`, to read the message headers from the IDC file. Replace the placeholder argument `sample_data.idc` with the name of your IDC file as `sample_data.idc` file is not provided with the toolbox.

```
ibeoReader = ibeoFileReader('sample_data.idc')
```

```
ibeoReader =
```

```
ibeoFileReader with properties:
```

```

FileName: "C:/Documents/MATLAB/ibeo_data/sample_data.idc"
StartTime: 15-Mar-2020 11:21:04.999434999
EndTime: 15-Mar-2020 11:25:35.030095000
Duration: 00:04:30
FileSummary: CAN          53      msgs [0x1002]
              scan        53      msgs [0x2205]
              object      106     msgs [0x2281]
              image       53      msgs [0x2403]
              vehicleState 53      msgs [0x2808]
              measurementList 53     msgs [0x2821]
              pointCloudPlane 53     msgs [0x7510]
              unsupported  53      msgs [0x6120]
              unsupported  53      msgs [0x6970]

```

Create an `ibeoMessageReader` object, `imgReader`, to read all images in the first 2 minutes, by using the `select` function with appropriate message type and time range values.

```

timeRange = [0, minutes(2)];
imgReader = select(ibeoReader, 'image', timeRange);

```

Visualize the message data by reading the messages one at a time to a video player object. First, create a `vision.VideoPlayer` object. Then, use the `hasNextMessage` function to check whether `imgReader` contains a message after the current one. If it does, use `readNextMessage` function to read the images into the workspace.

```

videoPlayer = vision.VideoPlayer;
while hasNextMessage(imgReader)
    img = readNextMessage(imgReader);
    step(videoPlayer, img);
end
release(videoPlayer);

```

Reset the `ibeoMessageReader` object, `imgReader`, to the first message in the selection, using the `reset` function.

```
reset(imgReader);
```

Input Arguments

ibeoReader — IDC message reader

`ibeoFileReader` object

`ibeoFileReader` object, corresponding to the IDC file to be read.

msgType — Message type

string scalar | character vector

Message type to read from the IDC file, specified as string scalar or character vector. Specific `msgType` values correspond to Ibeo data types, as illustrated in the table.

msgID — Message ID

string scalar | character vector

Message ID of the message type to be read from the IDC file, specified as string scalar or character vector. Specific `msgID` values correspond to Ibeo data types, as illustrated in the table.

timeRange — Time range in which to read messages

duration vector | datetime vector

Time range in which to read messages, specified as a duration or datetime vector of the form [startTime endTime]. If timeRange is a duration vector, startTime and endTime are relative to the start time specified by the StartTime property of ibeoReader.

deviceID — Device ID

nonnegative integer | vector of nonnegative integers

Device IDs of messages to read, specified as a scalar or vector of nonnegative integers. For a list of device IDs that you can select, see the DeviceID column of the table stored in FileSummary property of ibeoReader.

Output Arguments**msgReader — Message reader**

ibeoMessageReader object

Message reader, returned as an ibeoMessageReader object. This object reads selected messages from the IDC file.

Version History**Introduced in R2021a****See Also**

ibeoFileReader | ibeoMessageReader | readMessages | readNextMessage

ibeoMessageReader

Object for reading message content from Ibeo Data Container (IDC) file

Description

The `ibeoMessageReader` object is an indexed selection of the messages in an Ibeo IDC file. Use this object to read message content from an IDC file. Each `ibeoMessageReader` object contains content for only messages of the selected type from an `ibeoFileReader` object.

Creation

To create an `ibeoMessageReader` object, use the `select` object function of the `ibeoFileReader` object.

```
ibeoReader = ibeoFileReader('sample_data.idc');  
msgReader = select(ibeoReader, 'image');
```

Properties

FileName — Absolute path to IDC file

string scalar

This property is read-only.

Absolute path to IDC file, specified as a string scalar.

StartTime — Timestamp of first message

datetime scalar

This property is read-only.

Timestamp of the first message, specified as a datetime scalar.

EndTime — Timestamp of last message

datetime scalar

This property is read-only.

Timestamp of the last message, specified as a datetime scalar.

CurrentTime — Timestamp of current message

datetime scalar

Timestamp of the current message, specified as a datetime scalar.

Timestamps — Timestamps of all messages

N-by-1 datetime vector

This property is read-only.

Timestamps of all messages, specified as a N -by-1 datetime vector. N is the number of messages in the selection.

Duration — Total duration of selection

duration scalar

This property is read-only.

Total duration of the selection, specified as a duration scalar in seconds.

MessageType — Selected message type

string scalar

This property is read-only.

Selected message type, specified as a string scalar.

NumMessages — Number of messages in the selection

nonnegative integer

This property is read-only.

Number of messages in the selection, specified as a nonnegative integer.

DeviceID — IDs of devices associated with the selection

vector of nonnegative integers

This property is read-only.

IDs of the devices associated with the selection, specified as a vector of nonnegative integers.

Object Functions

<code>readMessages</code>	Read messages from Ibeo Data Container (IDC) file selection
<code>readNextMessage</code>	Read next message from Ibeo Data Container (IDC) file selection
<code>hasNextMessage</code>	Check if Ibeo Data Container (IDC) file selection has next message
<code>reset</code>	Reset to first message in Ibeo Data Container (IDC) file selection

Examples

Read Sensor Messages from IDC file

Create an `ibeoFileReader` object, `ibeoReader`, to read the message headers from an IDC file. Replace the placeholder argument `sample_data.idc` with the name of your IDC file as `sample_data.idc` file is not provided with the toolbox.

```
ibeoReader = ibeoFileReader('sample_data.idc')
```

```
ibeoReader =
```

```
ibeoFileReader with properties:
```

```
FileName: "C:/Documents/MATLAB/ibeo_data/sample_data.idc"
StartTime: 15-Mar-2020 11:21:04.999434999
EndTime: 15-Mar-2020 11:25:35.030095000
```

```

Duration: 00:04:30
FileSummary: CAN          53      msgs [0x1002]
              scan       53      msgs [0x2205]
              object     106     msgs [0x2281]
              image      53      msgs [0x2403]
              vehicleState 53      msgs [0x2808]
              measurementList 53      msgs [0x2821]
              pointCloudPlane 53      msgs [0x7510]
              unsupported  53      msgs [0x6120]
              unsupported  53      msgs [0x6970]

```

Create two `ibeoMessageReader` objects, `imgReader` and `objReader`, to read all image and object detection messages in the first 2 minutes, respectively, by using the `select` function with appropriate message type and time range values.

```

timeRange = [0 minutes(2)];
imgReader = select(ibeoReader, 'image', timeRange);
objReader = select(ibeoReader, 'object', timeRange);

```

Read the first 10 images and all object detection messages in the first 2 minutes, by using the `readMessages` function on the respective `ibeoMessageReader` objects with appropriate `indices` and `timeRange` arguments. Reading object detection messages returns both online objects and postprocessed objects along with their metadata.

```

imgs = readMessages(imgReader, 1:10);
[rawObjs, procObjs, rawMetadata, procMetadata] = readMessages(objReader);

```

Read and Visualize Sensor Messages from IDC File

Create an `ibeoFileReader` object, `ibeoReader`, to read the message headers from the IDC file. Replace the placeholder argument `sample_data.idc` with the name of your IDC file as `sample_data.idc` file is not provided with the toolbox.

```

ibeoReader = ibeoFileReader('sample_data.idc')

```

```

ibeoReader =

```

```

ibeoFileReader with properties:

```

```

FileName: "C:/Documents/MATLAB/ibeo_data/sample_data.idc"
StartTime: 15-Mar-2020 11:21:04.999434999
EndTime: 15-Mar-2020 11:25:35.030095000
Duration: 00:04:30
FileSummary: CAN          53      msgs [0x1002]
              scan       53      msgs [0x2205]
              object     106     msgs [0x2281]
              image      53      msgs [0x2403]
              vehicleState 53      msgs [0x2808]
              measurementList 53      msgs [0x2821]
              pointCloudPlane 53      msgs [0x7510]
              unsupported  53      msgs [0x6120]
              unsupported  53      msgs [0x6970]

```

Create an `ibeoMessageReader` object, `imgReader`, to read all images in the first 2 minutes, by using the `select` function with appropriate message type and time range values.

```
timeRange = [0, minutes(2)];  
imgReader = select(ibeoReader, 'image', timeRange);
```

Visualize the message data by reading the messages one at a time to a video player object. First, create a `vision.VideoPlayer` object. Then, use the `hasNextMessage` function to check whether `imgReader` contains a message after the current one. If it does, use `readNextMessage` function to read the images into the workspace.

```
videoPlayer = vision.VideoPlayer;  
while hasNextMessage(imgReader)  
    img = readNextMessage(imgReader);  
    step(videoPlayer, img);  
end  
release(videoPlayer);
```

Reset the `ibeoMessageReader` object, `imgReader`, to the first message in the selection, using the `reset` function.

```
reset(imgReader);
```

Tips

- If the `MessageType` property value is 'object', and if the IDC file contains both online objects and postprocessed objects, the `StartTime`, `EndTime`, `CurrentTime`, `Timestamps`, `Duration`, and `NumMessages` properties are determined by only the online object messages.
- If the `MessageType` value is 'object', and the IDC file contains only postprocessed messages, the `Timestamps` property corresponds to the postprocessing time, not the time of data collection. For synchronization purposes, use the `MidScanTimeStamp` field from the object metadata returned by the `readMessages` or `readNextMessage` object function.

Version History

Introduced in R2021a

See Also

`ibeoFileReader` | `select` | `readMessages` | `readNextMessage`

hasNextMessage

Check if Ibeo Data Container (IDC) file selection has next message

Syntax

```
flag = hasNextMessage(msgReader)
```

Description

`flag = hasNextMessage(msgReader)` checks if the IDC file selection has a subsequent message to read. This object function returns `true` if there is a next message available to read from the `ibeoMessageReader` object, `msgReader`. Otherwise, it returns `false`.

Examples

Read and Visualize Sensor Messages from IDC File

Create an `ibeoFileReader` object, `ibeoReader`, to read the message headers from the IDC file. Replace the placeholder argument `sample_data.idc` with the name of your IDC file as `sample_data.idc` file is not provided with the toolbox.

```
ibeoReader = ibeoFileReader('sample_data.idc')
```

```
ibeoReader =
```

```
ibeoFileReader with properties:
```

```

    FileName: "C:/Documents/MATLAB/ibeo_data/sample_data.idc"
    StartTime: 15-Mar-2020 11:21:04.999434999
    EndTime: 15-Mar-2020 11:25:35.030095000
    Duration: 00:04:30
FileSummary: CAN          53      msgs [0x1002]
              scan        53      msgs [0x2205]
              object     106      msgs [0x2281]
              image       53      msgs [0x2403]
              vehicleState 53      msgs [0x2808]
              measurementList 53    msgs [0x2821]
              pointCloudPlane 53    msgs [0x7510]
              unsupported  53      msgs [0x6120]
              unsupported  53      msgs [0x6970]
```

Create an `ibeoMessageReader` object, `imgReader`, to read all images in the first 2 minutes, by using the `select` function with appropriate message type and time range values.

```
timeRange = [0, minutes(2)];
imgReader = select(ibeoReader, 'image', timeRange);
```

Visualize the message data by reading the messages one at a time to a video player object. First, create a `vision.VideoPlayer` object. Then, use the `hasNextMessage` function to check whether `imgReader` contains a message after the current one. If it does, use `readNextMessage` function to read the images into the workspace.

```
videoPlayer = vision.VideoPlayer;
while hasNextMessage(imgReader)
    img = readNextMessage(imgReader);
    step(videoPlayer, img);
end
release(videoPlayer);
```

Reset the `ibeoMessageReader` object, `imgReader`, to the first message in the selection, using the `reset` function.

```
reset(imgReader);
```

Input Arguments

msgReader — Message reader

`ibeoMessageReader` object

Message reader, specified as a `ibeoMessageReader` object.

Output Arguments

flag — File selection has subsequent message to read

`true` | `false`

File selection has subsequent message to read, returned as a logical `true` or `false`.

Version History

Introduced in R2021a

See Also

`ibeoFileReader` | `select` | `reset` | `readNextMessage` | `readMessages`

readMessages

Read messages from Ibeo Data Container (IDC) file selection

Syntax

```
msgs = readMessages(msgReader)
msgs = readMessages(msgReader,timeRange)
[ ___ ] = readMessages( ___, 'DeviceID',deviceID)
msgs = readMessages(msgReader,indices)
msgs = readMessages(msgReader,timestamps)
[msgs,metadata] = readMessages( ___ )
[rawMsgs,procMsgs] = readMessages( ___ )
[rawMsgs,procMsgs,rawMetadata,procMetadata] = readMessages( ___ )
```

Description

`msgs = readMessages(msgReader)` reads all messages available in the `ibeoMessageReader` object, `msgReader`. If the input `MessageType` property of `msgReader` is `'object'`, this syntax returns online object messages.

`msgs = readMessages(msgReader,timeRange)` reads messages that are within the specified time range, `timeRange`.

`[___] = readMessages(___, 'DeviceID',deviceID)` reads messages that correspond to the specified device, `deviceID`, in addition to any combination of input arguments from previous syntaxes.

`msgs = readMessages(msgReader,indices)` reads messages at the specified linear indices, `indices`.

`msgs = readMessages(msgReader,timestamps)` reads the messages with the specified timestamps, `timestamps`.

`[msgs,metadata] = readMessages(___)` returns the metadata associated with the selected messages. If `MessageType` property of `msgReader` is `'object'`, then this syntax does not apply.

`[rawMsgs,procMsgs] = readMessages(___)` returns online object detection messages, `rawMsgs`, and postprocessed object detection messages, `procMsgs`, in the selection. To use this syntax, `MessageType` property of `msgReader` must be `'object'`.

`[rawMsgs,procMsgs,rawMetadata,procMetadata] = readMessages(___)` returns the metadata associated with `rawMsgs` and `procMsgs`. To use this syntax, the `MessageType` property of `msgReader` must be `'object'`.

Examples

Read Sensor Messages from IDC file

Create an `ibeoFileReader` object, `ibeoReader`, to read the message headers from an IDC file. Replace the placeholder argument `sample_data.idc` with the name of your IDC file as `sample_data.idc` file is not provided with the toolbox.

```
ibeoReader = ibeoFileReader('sample_data.idc')
```

```
ibeoReader =
```

```
ibeoFileReader with properties:
```

```

    FileName: "C:/Documents/MATLAB/ibeo_data/sample_data.idc"
    StartTime: 15-Mar-2020 11:21:04.999434999
    EndTime: 15-Mar-2020 11:25:35.030095000
    Duration: 00:04:30
FileSummary: CAN          53      msgs [0x1002]
              scan        53      msgs [0x2205]
              object     106      msgs [0x2281]
              image       53      msgs [0x2403]
              vehicleState 53      msgs [0x2808]
              measurementList 53      msgs [0x2821]
              pointCloudPlane 53      msgs [0x7510]
              unsupported  53      msgs [0x6120]
              unsupported  53      msgs [0x6970]
```

Create two `ibeoMessageReader` objects, `imgReader` and `objReader`, to read all image and object detection messages in the first 2 minutes, respectively, by using the `select` function with appropriate message type and time range values.

```
timeRange = [0 minutes(2)];
imgReader = select(ibeoReader, 'image', timeRange);
objReader = select(ibeoReader, 'object', timeRange);
```

Read the first 10 images and all object detection messages in the first 2 minutes, by using the `readMessages` function on the respective `ibeoMessageReader` objects with appropriate `indices` and `timeRange` arguments. Reading object detection messages returns both online objects and postprocessed objects along with their metadata.

```
imgs = readMessages(imgReader, 1:10);
[rawObjs, procObjs, rawMetadata, procMetadata] = readMessages(objReader);
```

Input Arguments

msgReader — Message reader

`ibeoMessageReader` object

Message reader, specified as a `ibeoMessageReader` object.

indices — Indices

vector of nonnegative integers

Linear indices of the messages to read, specified as a vector of nonnegative integers. The maximum index value that can be specified corresponds to the number of messages in the selection, corresponding to the `NumMessages` property of `msgReader`.

timestamps – Timestamps*M-by-1 datetime vector | M-by-1 duration vector*

Timestamps of messages to read, specified as an M-by-1 datetime or duration vector. This table lists the range of valid timestamp values based on data type:

timestamps Data Type	Minimum Value	Maximum Value
datetime vector	StartTime property of msgReader	EndTime property of msgReader
duration vector	0	Duration property of msgReader

timeRange – Time range*datetime vector | duration vector*

Time range of messages to read, specified as duration or datetime vector of the form [startTime endTime]. If timeRange is a duration vector, the values of startTime and endTime are relative to the start time specified by the StartTime property of msgReader.

deviceID – Device IDs*vector of nonnegative integers*

Device IDs of messages to read, specified as a scalar or vector of nonnegative integers. deviceID cannot be used along with indices or timestamps as the second argument. By default, its value is the same as the DeviceID property of the msgReader.

Output Arguments**msgs – Messages read from IDC file***array of structures | pointCloud array | cell array*

Messages read from the IDC file, returned as an array of structures, pointCloud array or cell array. The datatype is determined by the MessageType property of the msgReader. For more information, see Data Structure of Ibeo Messages and Metadata on page 4-865.

metadata – Metadata*array of structures*

Metadata of the messages, returned as an array of structures. The fields of each structure are determined by the MessageType property of msgReader. For more information, see Data Structure of Ibeo Messages and Metadata on page 4-865.

rawMsgs – Online object detection messages*cell array of array of structures*

Online object detection messages, returned as a cell array of array of structures. To return this argument, the MessageType property of msgReader must be 'object'. For more information, see Data Structure of Ibeo Messages and Metadata on page 4-865.

procMsgs – Postprocessed object detection messages*cell array of array of structures*

Postprocessed object detection messages, returned as a cell array of array of structures. To return this argument, the `MessageType` property of `msgReader` must be 'object'. For more information, see Data Structure of Ibeo Messages and Metadata on page 4-865.

rawMetadata – Metadata of the online object detection messages

array of structures

Metadata of the online object detection messages, returned as an array of structures. To return this argument, the `MessageType` property of the `msgReader` must be 'object'. For more information, see Data Structure of Ibeo Messages and Metadata on page 4-865.

procMetadata – Metadata of the postprocessed object detection messages

array of structures

Metadata of the postprocessed object detection messages, returned as an array of structures. To return this argument, the `MessageType` property of the `msgReader` must be 'object'. For more information, see Data Structure of Ibeo Messages and Metadata on page 4-865.

More About

Data Structure of Ibeo Messages and Metadata

The following function calls illustrate the use of `readMessages` function to read multiple messages and their associated metadata from an IDC file using an `ibeoMessageReader` object.

- `[msgs, metadata] = readMessages(msgReader)`
- `[rawMsgs, procMsgs, rawMetadata, procMetadata] = readMessages(msgReader)`

This table highlights the format and data structure of messages and metadata returned by this function, based on the message type of the `ibeoMessageReader` object.

Message Type	Message Format [msgs, rawMsgs, procMsgs]	Metadata Format [metadata, rawMetadata, procMetadata]
Scan	pointCloud array	Structure array of ScanMetaDataSet
PointCloudPlane	pointCloud array	Structure array of PointCloudPlaneMetaDataSet
Image	Cell array of H_t -by- W_t -by-3 matrices, where t is the timestamp of each message.	Cell array of ImageMetaDataSet objects
Object Both online objects and post-processed objects have the same structure.	Cell array of M_t -by-1 structure arrays of ObjectStruct, where t is the timestamp of each message.	Structure array of ObjectMetaDataSet
VehicleState	Structure array of VehicleStateStruct	Structure array of VehicleStateMetaDataSet

Message Type	Message Format [msgs, rawMsgs, procMsgs]	Metadata Format [metadata, rawMetadata, procMetadata]
MeasurementList	Cell array of M_t -by-1 structure arrays of MeasurementStruct, where t is the timestamp of each message.	Structure array of MeasurementMetaDataSet
CAN	Structure array of CANStruct	Structure array of CANMetaDataSet

Tips

When working with large numbers of messages, this has high time and system memory requirements. Consider reading smaller batches of messages, or using the `readNextMessage` object function to read messages one by one.

Version History

Introduced in R2021a

See Also

`ibeoFileReader` | `select` | `readNextMessage`

readNextMessage

Read next message from Ibeo Data Container (IDC) file selection

Syntax

```
msg = readNextMessage(msgReader)
[msg,metadata] = readNextMessage(msgReader)
[rawMsg,procMsg] = readNextMessage(msgReader)
[rawMsg,procMsg,rawMetadata,procMetadata] = readNextMessage(msgReader)
[ ___ ] = readNextMessage(msgReader,'DeviceID',deviceID)
```

Description

`msg = readNextMessage(msgReader)` reads the next message from the selection of messages available in the `ibeoMessageReader` object, `msgReader`. By default, `readNextMessage` starts reading from the first message in the selection and reads subsequent messages during successive calls, all the way to the last available message. To reset the reading back to the first message, use `reset` method on the `ibeoMessageReader` object. If the `MessageType` property of `msgReader` is 'object', this syntax returns the next online object message.

`[msg,metadata] = readNextMessage(msgReader)` returns the metadata associated with the selected message. If `MessageType` property of `msgReader` is 'object', then this syntax does not apply.

`[rawMsg,procMsg] = readNextMessage(msgReader)` returns the next online object detection message, `rawMsg`, and postprocessed object detection message, `procMsg`, in the selection. To use this syntax, `MessageType` property of `msgReader` must be 'object'.

`[rawMsg,procMsg,rawMetadata,procMetadata] = readNextMessage(msgReader)` returns the metadata associated with, `rawMsg` and `procMsg`. To use this syntax, the `MessageType` property of `msgReader` must be 'object'.

`[___] = readNextMessage(msgReader,'DeviceID',deviceID)` reads the next message from the selection of messages, that correspond to the specified device, `deviceID`.

Examples

Read and Visualize Sensor Messages from IDC File

Create an `ibeoFileReader` object, `ibeoReader`, to read the message headers from the IDC file. Replace the placeholder argument `sample_data.idc` with the name of your IDC file as `sample_data.idc` file is not provided with the toolbox.

```
ibeoReader = ibeoFileReader('sample_data.idc')
```

```
ibeoReader =
```

```
    ibeoFileReader with properties:
```

```

    FileName: "C:/Documents/MATLAB/ibeo_data/sample_data.idc"
    StartTime: 15-Mar-2020 11:21:04.999434999
    EndTime: 15-Mar-2020 11:25:35.030095000
    Duration: 00:04:30
    FileSummary: CAN          53      msgs [0x1002]
                 scan        53      msgs [0x2205]
                 object      106     msgs [0x2281]
                 image       53      msgs [0x2403]
                 vehicleState 53      msgs [0x2808]
                 measurementList 53     msgs [0x2821]
                 pointCloudPlane 53     msgs [0x7510]
                 unsupported  53      msgs [0x6120]
                 unsupported  53      msgs [0x6970]

```

Create an `ibeoMessageReader` object, `imgReader`, to read all images in the first 2 minutes, by using the `select` function with appropriate message type and time range values.

```

timeRange = [0, minutes(2)];
imgReader = select(ibeoReader, 'image', timeRange);

```

Visualize the message data by reading the messages one at a time to a video player object. First, create a `vision.VideoPlayer` object. Then, use the `hasNextMessage` function to check whether `imgReader` contains a message after the current one. If it does, use `readNextMessage` function to read the images into the workspace.

```

videoPlayer = vision.VideoPlayer;
while hasNextMessage(imgReader)
    img = readNextMessage(imgReader);
    step(videoPlayer, img);
end
release(videoPlayer);

```

Reset the `ibeoMessageReader` object, `imgReader`, to the first message in the selection, using the `reset` function.

```

reset(imgReader);

```

Input Arguments

msgReader — Message reader

`ibeoMessageReader` object

Message reader, specified as a `ibeoMessageReader` object.

Output Arguments

msg — Message read from IDC file

structure | `pointCloud` object | array

Message read from IDC file, returned as a structure, `pointCloud` or array, determined by the `MessageType` property of the `msgReader`. For more information, see [Data Structure of Ibeo Message and Metadata](#) on page 4-869.

metadata — Metadata

structure

Metadata of the message, returned as a structure. The fields of each structure are determined by the `MessageType` property of `msgReader`. For more information, see [Data Structure of Ibeo Message and Metadata](#) on page 4-869.

rawMsg — Online object detection message

array of structures

Online object detection message, returned as an array of structures. To return this argument, the `MessageType` property of `msgReader` must be `'object'`. For more information, see [Data Structure of Ibeo Message and Metadata](#) on page 4-869.

procMsg — Postprocessed object detection message

array of structures

Postprocessed object detection message, returned as an array of structures. To return this argument, the `MessageType` property of `msgReader` must be `'object'`. For more information, see [Data Structure of Ibeo Message and Metadata](#) on page 4-869.

rawMetadata — Metadata of the online object detection message

structure

Metadata of the online object detection message, returned as a structure. To return this argument, the `MessageType` property of `msgReader` must be `'object'`. For more information, see [Data Structure of Ibeo Message and Metadata](#) on page 4-869.

procMetadata — Metadata of the postprocessed object detection message

structure

Metadata of the postprocessed object detection message, `procMsg`, returned as a structure. To return this argument, the `MessageType` property of the `msgReader` must be `'object'`. For more information, see [Data Structure of Ibeo Message and Metadata](#) on page 4-869.

More About

Data Structure of Ibeo Message and Metadata

The following function calls illustrate the use of `readNextMessage` function to read a single message and its associated metadata from an IDC file using an `ibeoMessageReader` object.

- `[msg, metadata] = readNextMessage(msgReader)`
- `[rawMsg, procMsg, rawMetadata, procMetadata] = readNextMessage(msgReader)`

This table highlights the format and data structure of the message and metadata returned by this function, based on the message type of the `ibeoMessageReader` object.

Message Type	Message Format [msg, rawMsg, procMsg]	Metadata Format [metadata, rawMetadata, procMetadata]
Scan	pointCloud	ScanMetaDataSet
PointCloudPlane	pointCloud	PointCloudPlaneMetaDataSet
Image	<i>H</i> -by- <i>W</i> -by-3 array, where <i>H</i> and <i>W</i> are the height and width of the image.	ImageMetaDataSet object

Message Type	Message Format [msg, rawMsg, procMsg]	Metadata Format [metadata, rawMetadata, procMetadata]
Object Both online objects and post-processed objects have the same structure.	<i>M</i> -by-1 structure array of ObjectStruct, where <i>M</i> is the number of object detections	ObjectMetaDataStruct
VehicleState	VehicleStateStruct	VehicleStateMetaDataStruct
MeasurementList	<i>M</i> -by-1 structure array of MeasurementStruct, where <i>M</i> is the number of measurements	MeasurementMetaDataStruct
CAN	CANStruct	CANMetaDataStruct

Version History

Introduced in R2021a

See Also

ibeoFileReader | select | reset | hasNextMessage | readMessages

reset

Reset to first message in Ibeo Data Container (IDC) file selection

Syntax

```
reset(msgReader)
```

Description

`reset(msgReader)` resets the `ibeoMessageReader` object, `msgReader` to the first message in the selection.

Examples

Read and Visualize Sensor Messages from IDC File

Create an `ibeoFileReader` object, `ibeoReader`, to read the message headers from the IDC file. Replace the placeholder argument `sample_data.idc` with the name of your IDC file as `sample_data.idc` file is not provided with the toolbox.

```
ibeoReader = ibeoFileReader('sample_data.idc')
```

```
ibeoReader =
```

```
ibeoFileReader with properties:
```

```

    FileName: "C:/Documents/MATLAB/ibeo_data/sample_data.idc"
    StartTime: 15-Mar-2020 11:21:04.999434999
    EndTime: 15-Mar-2020 11:25:35.030095000
    Duration: 00:04:30
FileSummary: CAN          53      msgs [0x1002]
              scan        53      msgs [0x2205]
              object     106     msgs [0x2281]
              image       53      msgs [0x2403]
              vehicleState 53      msgs [0x2808]
              measurementList 53    msgs [0x2821]
              pointCloudPlane 53    msgs [0x7510]
              unsupported  53      msgs [0x6120]
              unsupported  53      msgs [0x6970]
```

Create an `ibeoMessageReader` object, `imgReader`, to read all images in the first 2 minutes, by using the `select` function with appropriate message type and time range values.

```
timeRange = [0, minutes(2)];
imgReader = select(ibeoReader, 'image', timeRange);
```

Visualize the message data by reading the messages one at a time to a video player object. First, create a `vision.VideoPlayer` object. Then, use the `hasNextMessage` function to check whether `imgReader` contains a message after the current one. If it does, use `readNextMessage` function to read the images into the workspace.

```
videoPlayer = vision.VideoPlayer;
while hasNextMessage(imgReader)
    img = readNextMessage(imgReader);
    step(videoPlayer, img);
end
release(videoPlayer);
```

Reset the `ibeoMessageReader` object, `imgReader`, to the first message in the selection, using the `reset` function.

```
reset(imgReader);
```

Input Arguments

msgReader — Message reader

`ibeoMessageReader` object

Message reader, specified as a `ibeoMessageReader` object.

Version History

Introduced in R2021a

See Also

`ibeoFileReader` | `select` | `ibeoMessageReader` | `hasNextMessage` | `readNextMessage` | `readMessages`

groundTruthMultisignal

Ground truth label data for multiple signals

Description

The `groundTruthMultisignal` object contains information about the ground truth data source, label definitions, and marked label annotations for multiple signals. The source of the signals can be a video, image sequence, lidar point cloud, or any other custom format containing multiple signals. You can export or import a `groundTruthMultisignal` object from the **Ground Truth Labeler** app.

To create training data for deep learning applications from arrays of `groundTruthMultisignal` objects, use the `gatherLabelData` function.

Creation

To export a `groundTruthMultisignal` object from the **Ground Truth Labeler** app, on the app toolstrip, select **Export Labels > To Workspace**. The app exports the object to the MATLAB workspace. To create a `groundTruthMultisignal` object programmatically, use the `groundTruthMultisignal` function (described here).

Syntax

```
gTruth = groundTruthMultisignal(dataSources, labelDefs, roiData, sceneData)
```

Description

`gTruth = groundTruthMultisignal(dataSources, labelDefs, roiData, sceneData)` returns an object containing ground truth labels that can be imported into the **Ground Truth Labeler** app.

- `dataSources` specifies the sources of the ground truth data and sets the `DataSource` property.
- `labelDefs` specifies the label, sublabel, and attribute definitions of the ground truth data and sets the `LabelDefinitions` property.
- `roiData` specifies the identifying information, position, and timestamps for the marked region of interest (ROI) labels and sets the `ROILabelData` property.
- `sceneData` specifies the identifying information and timestamps for marked scene labels and sets the `SceneLabelData` property.

Properties

DataSource — Sources of ground truth data

vector of `MultiSignalSource` objects

Sources of ground truth data, specified as a vector of `MultiSignalSource` objects. These objects contain information that describe the sources from which ground truth data was labeled. This table describes the type of `MultiSignalSource` objects that you can specify in this vector.

MultiSignalSource Object Type	Data Source	Class Reference
VideoSource	Video file	vision.labeler.loading.VideoSource
ImageSequenceSource	Image sequence folder	vision.labeler.loading.ImageSequenceSource
VelodyneLidarSource	Velodyne [®] packet capture (PCAP) file	vision.labeler.loading.VelodyneLidarSource
RosbagSource	Rosbag file	vision.labeler.loading.RosbagSource
PointCloudSequenceSource	Point cloud sequence folder	vision.labeler.loading.PointCloudSequenceSource
CustomImageSource	Custom image format	vision.labeler.loading.CustomImageSource

To specify additional data sources, create a new type of `MultiSignalSource` object by using the `vision.labeler.loading.MultiSignalSource` class.

LabelDefinitions – Label definitions

table

Label definitions, specified as a table. To create this table, use one of these options.

- In the **Ground Truth Labeler** app, create label definitions, and then export them as part of a `groundTruthMultisignal` object.
- Use a `labelDefinitionCreatorMultisignal` object to generate a label definitions table. If you save this table to a MAT-file, you can then load the label definitions into a **Ground Truth Labeler** app session by selecting **Open > Label Definitions** from the app toolstrip.
- Create the label definitions table at the MATLAB command line.

This table describes the required and optional columns of the table specified in the `LabelDefinitions` property.

Column	Description	Required or Optional
Name	Strings or character vectors specifying the name of each label definition.	Required

Column	Description	Required or Optional									
SignalType	<p>SignalType enumerations that specify the signal type supported for each label definition. Valid values are Image for image signals such as videos or image sequences, PointCloud for lidar signals, or Time for scene label definitions.</p> <p>If a label definition supports multiple signal types, then the label definition has a separate row for each signal type. For example, consider a label definition named car. In the Ground Truth Labeler app, you draw this label as a rectangle in image signals and a cuboid in lidar point cloud signals. In the LabelDefinitions table, car appears twice and has these Name, SignalType, and LabelType values.</p> <table border="1" data-bbox="440 730 1252 863"> <thead> <tr> <th data-bbox="440 730 711 772">Name</th> <th data-bbox="716 730 980 772">SignalType</th> <th data-bbox="985 730 1252 772">LabelType</th> </tr> </thead> <tbody> <tr> <td data-bbox="440 772 711 814">'car'</td> <td data-bbox="716 772 980 814">Image</td> <td data-bbox="985 772 1252 814">Rectangle</td> </tr> <tr> <td data-bbox="440 814 711 863">'car'</td> <td data-bbox="716 814 980 863">PointCloud</td> <td data-bbox="985 814 1252 863">Cuboid</td> </tr> </tbody> </table>	Name	SignalType	LabelType	'car'	Image	Rectangle	'car'	PointCloud	Cuboid	Required
Name	SignalType	LabelType									
'car'	Image	Rectangle									
'car'	PointCloud	Cuboid									
LabelType	<p>LabelType enumerations that specify the type of each label definition.</p> <p>For ROI label definitions with a SignalType of Image, valid LabelType enumerations are:</p> <ul style="list-style-type: none"> • labelType.Rectangle • labelType.Line • labelType.PixelLabel • labelType.Polygon • labelType.ProjectectedCuboid <p>For ROI label definitions with a SignalType of PointCloud, the only valid LabelType enumeration is labelType.Cuboid.</p> <p>For scene label definitions, the only valid LabelType enumeration is labelType.Scene.</p> <p>You can also add ground truth data that is not an ROI or scene label to a groundTruthMultisignal object. In the label definitions table, specify a label definition whose labelType is Custom.</p>	Required									

Column	Description	Required or Optional
Group	Strings or character vectors specifying the group to which each label definition belongs.	<p>Optional</p> <p>If you create label definitions at the MATLAB command line, you do not need to include a Group column.</p> <p>If you export label definitions from the Ground Truth Labeler app or create them using a <code>labelDefinitionCreatorMultisignal</code> object, the label definitions table includes this column, even if you did not specify groups. The app assigns each label definition a Group value of 'None'.</p>

Column	Description	Required or Optional
Description	Strings or character vectors that describe each label definition.	<p data-bbox="1276 327 1382 359">Optional</p> <p data-bbox="1276 390 1455 699">If you create label definitions at the MATLAB command line, you do not need to include a Description column.</p> <p data-bbox="1276 730 1463 1554">If you export label definitions from the Ground Truth Labeler app or create them using a <code>labelDefinitionCreatorMultisignal</code> object, the label definitions table includes this column, even if you did not specify descriptions. The Description for these label definitions is an empty character vector.</p>

Column	Description	Required or Optional
LabelColor	1-by-3 row vectors of RGB triplets that specify the colors of the label definitions. Values are in the range [0, 1]. The color yellow (RGB triplet [1 1 0]) is reserved for the color of selected labels in the Ground Truth Labeler app.	<p>Optional</p> <p>When you define labels in the Ground Truth Labeler app, you must specify a color. Therefore, an exported label definitions table always includes this column.</p> <p>When you create label definitions using the <code>labelDefinitionCreator</code> <code>Multisignal</code> object without specifying colors, the returned label definition table includes this column, but all column values are empty.</p>

Column	Description	Required or Optional
PixelLabelID	Scalars, column vectors, <i>M</i> -by-3 matrices of integer-valued label IDs. PixelLabelID specifies the pixel label values used to represent a label definition. Pixel label ID values must be between 0 and 255.	<p>Optional</p> <p>When you define pixel labels in the Ground Truth Labeler app or the <code>labelDefinitionCreatorMultisignal</code> object, the generated label definitions table includes this column.</p> <p>When creating a label definitions table at the MATLAB command line, if you set <code>LabelType</code> to <code>labelType.PixelLabel</code> for any label, then this column is required.</p>
Hierarchy	Structures containing sublabel and attribute data for each label definition. For an example of the Hierarchy format, see "Export and Explore Ground Truth Labels for Multiple Signals".	<p>Optional</p> <p>When you define sublabels or attributes in the Ground Truth Labeler app or the <code>labelDefinitionCreatorMultisignal</code> object, the generated label definitions table includes this column.</p>

R0ILabelData — ROI label data

R0ILabelData object

ROI label data across all signals, specified as an R0ILabelData object.

For Rectangle, Cuboid, ProjectedCuboid, Polygon, and Line label types, ground truth data that is not a floating-point array has a data type of single.

SceneLabelData — Scene label data

SceneLabelData object

Scene label data across all signals, specified as a SceneLabelData object.

Object Functions

selectLabelsByLabelName	Select multisignal ground truth by label name
selectLabelsByLabelType	Select multisignal ground truth by label type
selectLabelsByGroupName	Select multisignal ground truth by label group name
selectLabelsBySignalName	Select multisignal ground truth by signal name
selectLabelsBySignalType	Select multisignal ground truth labels by signal type
gatherLabelData	Gather synchronized label data from ground truth
writeFrames	Write signal frames for ground truth data to disk
changeFilePaths	Change file paths in multisignal ground truth data

Examples**Create Ground Truth from Multiple Signals**

Create ground truth data for a video signal and a lidar point cloud sequence signal that captures the same driving scene. Specify the signal sources, label definitions, and ROI and scene label data.

Create the video data source from an MP4 file.

```
sourceName = '01_city_c2s_fcw_10s.mp4';  
sourceParams = [];  
vidSource = vision.labeler.loading.VideoSource;  
vidSource.loadSource(sourceName,sourceParams);
```

Create the point cloud sequence source from a folder of point cloud data (PCD) files.

```
pcSeqFolder = fullfile(toolboxdir('driving'),'drivingdata','lidarSequence');  
addpath(pcSeqFolder)  
load timestamps.mat  
rmpath(pcSeqFolder)
```

```
lidarSourceData = load(fullfile(pcSeqFolder,'timestamps.mat'));
```

```
sourceName = pcSeqFolder;  
sourceParams = struct;  
sourceParams.Timestamps = timestamps;
```

```
pcseqSource = vision.labeler.loading.PointCloudSequenceSource;  
pcseqSource.loadSource(sourceName,sourceParams);
```

Combine the signal sources into an array.

```
dataSource = [vidSource pcseqSource]
```

```
dataSource =
```

```
1x2 heterogeneous MultiSignalSource (VideoSource, PointCloudSequenceSource) array with properties:
```

```
SourceName
SourceParams
SignalName
SignalType
Timestamp
NumSignals
```

Create a table of label definitions for the ground truth data by using a `labelDefinitionCreatorMultisignal` object.

- The Car label definition appears twice. Even though Car is defined as a rectangle, you can draw rectangles only for image signals, such as videos. The `labelDefinitionCreatorMultisignal` object creates an additional row for lidar point cloud signals. In these signal types, you can draw Car labels as cuboids only.
- The label definitions have no descriptions and no assigned colors, so the `Description` and `LabelColor` columns are empty.
- The label definitions have no assigned groups, so for all label definitions, the corresponding cell in the `Group` column is set to 'None'.
- Road is a pixel label definition, so the table includes a `PixelLabelID` column.
- No label definitions have sublabels or attributes, so the table does not include a `Hierarchy` column for storing such information.

```
ldc = labelDefinitionCreatorMultisignal;
addLabel(ldc, 'Car', 'Rectangle');
addLabel(ldc, 'Truck', 'ProjectedCuboid');
addLabel(ldc, 'Lane', 'Line');
addLabel(ldc, 'Road', 'PixelLabel');
addLabel(ldc, 'Sunny', 'Scene');
labelDefs = create(ldc)
```

```
labelDefs =
```

```
7x7 table
```

Name	SignalType	LabelType	Group	Description	LabelColor	PixelLabelID
{'Car' }	Image	Rectangle	{'None'}	{' '}	{0x0 char}	{0x0 char}
{'Car' }	PointCloud	Cuboid	{'None'}	{' '}	{0x0 char}	{0x0 char}
{'Truck' }	Image	ProjectedCuboid	{'None'}	{' '}	{0x0 char}	{0x0 char}
{'Lane' }	Image	Line	{'None'}	{' '}	{0x0 char}	{0x0 char}
{'Lane' }	PointCloud	Line	{'None'}	{' '}	{0x0 char}	{0x0 char}
{'Road' }	Image	PixelLabel	{'None'}	{' '}	{0x0 char}	{}
{'Sunny' }	Time	Scene	{'None'}	{' '}	{0x0 char}	{0x0 char}

Create ROI label data for the first frame of the video.

```

numVideoFrames = numel(vidSource.Timestamp{1});
carData = cell(numVideoFrames,1);
laneData = cell(numVideoFrames,1);
truckData = cell(numVideoFrames,1);
carData{1} = [304 212 37 33];
laneData{1} = [70 458; 311 261];
truckData{1} = [309,215,33,24,330,211,33,24];
videoData = timetable(vidSource.Timestamp{1},carData,laneData, ...
    'VariableNames',{'Car','Lane'});

```

Create ROI label data for the first point cloud in the sequence.

```

numPCFrames = numel(pcseqSource.Timestamp{1});
carData = cell(numPCFrames, 1);
carData{1} = [27.35 18.32 -0.11 4.25 4.75 3.45 0 0 0];
lidarData = timetable(pcseqSource.Timestamp{1},carData,'VariableNames',{'Car'});

```

Combine the ROI label data for both sources.

```

signalNames = [dataSource.SignalName];
roiData = vision.labeler.labeldata.ROILabelData(signalNames,{videoData,lidarData})

```

```
roiData =
```

```
ROILabelData with properties:
```

```

    video_01_city_c2s_fcw_10s: [204x2 timetable]
    lidarSequence: [34x1 timetable]

```

Create scene label data for the first 10 seconds of the driving scene.

```

sunnyData = seconds([0 10]);
labelNames = ["Sunny"];
sceneData = vision.labeler.labeldata.SceneLabelData(labelNames,{sunnyData})

```

```
sceneData =
```

```
SceneLabelData with properties:
```

```
Sunny: [0 sec    10 sec]
```

Create a ground truth object from the signal sources, label definitions, and ROI and scene label data. You can import this object into the **Ground Truth Labeler** app for manual labeling or to run a labeling automation algorithm on it. You can also extract training data from this object for deep learning models by using the `gatherLabelData` function.

```
gTruth = groundTruthMultisignal(dataSource,labelDefs,roiData,sceneData)
```

```
gTruth =
```

```
groundTruthMultisignal with properties:
```

```

    DataSource: [1x2 vision.labeler.loading.MultiSignalSource]
    LabelDefinitions: [7x7 table]

```

```
ROILabelData: [1x1 vision.labeler.labeldata.ROILabelData]  
SceneLabelData: [1x1 vision.labeler.labeldata.SceneLabelData]
```

Tips

- `groundTruthMultisignal` objects with video-based data sources rely on the video reading capabilities of your operating system. A `groundTruthMultisignal` object created using video data sources remains consistent only for the same platform that was used to create it. To create a platform-independent `groundTruthMultisignal` object, convert the videos into sequences of images and include the associated timestamps with the image sequences.
- To create a `groundTruthMultisignal` object containing ROI label data but no scene label data, specify the `SceneLabelData` property as an empty array. To create this array, at the MATLAB command prompt, enter this code.

```
sceneData = vision.labeler.labeldata.SceneLabelData.empty
```

Version History

Introduced in R2020a

See Also

Apps

Ground Truth Labeler

Objects

`labelDefinitionCreatorMultisignal` | `labelType` | `attributeType`

Topics

“Get Started with Ground Truth Labelling”

“Share and Store Labeled Ground Truth Data”

“How Labeler Apps Store Exported Pixel Labels”

selectLabelsByLabelName

Select multisignal ground truth by label name

Syntax

```
gtLabel = selectLabelsByLabelName(gTruth, labelNames)
```

Description

`gtLabel = selectLabelsByLabelName(gTruth, labelNames)` selects labels specified by `labelNames` from a `groundTruthMultisignal` object, `gTruth`. The function returns a corresponding `groundTruthMultisignal` object, `gtLabel`, that contains only the selected labels. If `gTruth` is a vector of `groundTruthMultisignal` objects, then the function returns a vector of corresponding `groundTruthMultisignal` objects that contain only the selected labels.

Examples

Select Ground Truth Labels by Label Name

Select ground truth labels from a `groundTruthMultisignal` object by specifying a label name.

Load a `groundTruthMultisignal` object containing ROI and scene label data for a video and corresponding lidar point cloud sequence. The helper function used to load this object is attached to the example as a supporting file.

```
gTruth = helperLoadGTruthVideoLidar;
```

Inspect the label definitions. The object contains ROI labels for different vehicle types and a scene label. Because image and lidar point cloud signals represent ROIs differently, the car label has two rows. On image signals, such as videos, you draw the label as a rectangle. On point cloud signals, you draw the label as a cuboid.

```
gTruth.LabelDefinitions
```

```
ans =
```

```
5x7 table
```

Name	SignalType	LabelType	Group	Description	LabelColor
{'car' }	Image	Rectangle	{'Vehicles'}	{0x0 char}	{[0.5862 0.8276 0.3100]}
{'car' }	PointCloud	Cuboid	{'Vehicles'}	{0x0 char}	{[0.5862 0.8276 0.3100]}
{'truck' }	Image	Rectangle	{'Vehicles'}	{0x0 char}	{[0.5172 0.5172]}
{'truck' }	PointCloud	Cuboid	{'Vehicles'}	{0x0 char}	{[0.5172 0.5172]}
{'sunny' }	Time	Scene	{'None' }	{0x0 char}	{[0 0.7241 0.655]}

Create a new `groundTruthMultisignal` object that contains labels for only the "sunny" label definition.

```
labelNames = "sunny";
gtLabel = selectLabelsByLabelName(gTruth, labelNames);
```

For the original and new objects, inspect the ROI label data. Because you did not select any ROI label names, in the new object, the signals do not contain any ROI label data at any timestamp.

```
gTruth.ROILabelData
gtLabel.ROILabelData
```

```
ans =
```

```
ROILabelData with properties:
```

```
video_01_city_c2s_fcw_10s: [204x2 timetable]
lidarSequence: [34x2 timetable]
```

```
ans =
```

```
ROILabelData with properties:
```

```
video_01_city_c2s_fcw_10s: [204x0 timetable]
lidarSequence: [34x0 timetable]
```

For the original and new objects, inspect the scene label data. Because you selected the "sunny" label, the original object and new object contain identical scene label data.

```
gTruth.SceneLabelData
gtLabel.SceneLabelData
```

```
ans =
```

```
SceneLabelData with properties:
```

```
sunny: [0 sec 10.15 sec]
```

```
ans =
```

```
SceneLabelData with properties:
```

```
sunny: [0 sec 10.15 sec]
```

Input Arguments

gTruth — Multisignal ground truth data

groundTruthMultisignal object | vector of groundTruthMultisignal objects

Multisignal ground truth data, specified as a groundTruthMultisignal object or vector of groundTruthMultisignal objects.

labelNames — Label names

character vector | string scalar | cell array of character vectors | string vector

Label names, specified as a character vector, string scalar, cell array of character vectors, or string vector.

To view all label names in a `groundTruthMultisignal` object, `gTruth`, enter this command at the MATLAB command prompt.

```
unique(gTruth.LabelDefinitions.Name)
```

```
Example: 'car'
```

```
Example: "car"
```

```
Example: {'car','lane'}
```

```
Example: ["car" "lane"]
```

Output Arguments

gtLabel — Ground truth with only selected labels

`groundTruthMultisignal` object | vector of `groundTruthMultisignal` objects

Ground truth with only the selected labels, returned as a `groundTruthMultisignal` object or vector of `groundTruthMultisignal` objects.

Each `groundTruthMultisignal` object in `gtLabel` corresponds to a `groundTruthMultisignal` object in the `gTruth` input. The returned objects contain only the labels that are of the label names specified by the `labelNames` input.

Limitations

- Selecting pixel labels by label name is not supported. However, you can select all labels of type `pixel`. Use the `selectLabelsByLabelType` function, specifying the label type as a `labelType.PixelLabel` enumeration.
- Selecting sublabels by label name is not supported.

Version History

Introduced in R2020a

See Also

Objects

`groundTruthMultisignal`

Functions

`selectLabelsByGroupName` | `selectLabelsBySignalName` | `selectLabelsBySignalType` | `selectLabelsByLabelType`

selectLabelsByLabelType

Select multisignal ground truth by label type

Syntax

```
gtLabel = selectLabelsByLabelType(gTruth, labelTypes)
```

Description

`gtLabel = selectLabelsByLabelType(gTruth, labelTypes)` selects labels of the types specified by `labelTypes` from a `groundTruthMultisignal` object, `gTruth`. The function returns a corresponding `groundTruthMultisignal` object, `gtLabel`, that contains only the selected labels. If `gTruth` is a vector of `groundTruthMultisignal` objects, then the function returns a vector of corresponding `groundTruthMultisignal` objects that contain only the selected labels.

Examples

Select Ground Truth Labels by Label Type

Select ground truth labels from a `groundTruthMultisignal` object by specifying a label type.

Load a `groundTruthMultisignal` object containing ROI and scene label data for a video and corresponding lidar point cloud sequence. The helper function used to load this object is attached to the example as a supporting file.

```
gTruth = helperLoadGTruthVideoLidar;
```

Inspect the label definitions. The object contains definitions for rectangle, cuboid, and scene label types.

```
gTruth.LabelDefinitions
```

```
ans =
```

```
5x7 table
```

Name	SignalType	LabelType	Group	Description	LabelColor
{'car' }	Image	Rectangle	{'Vehicles'}	{0x0 char}	{[0.5862 0.8276 0.3103]}
{'car' }	PointCloud	Cuboid	{'Vehicles'}	{0x0 char}	{[0.5862 0.8276 0.3103]}
{'truck'}	Image	Rectangle	{'Vehicles'}	{0x0 char}	{[0.5172 0.5172 1]}
{'truck'}	PointCloud	Cuboid	{'Vehicles'}	{0x0 char}	{[0.5172 0.5172 1]}
{'sunny'}	Time	Scene	{'None' }	{0x0 char}	{[0 0.7241 0.6552]}

Inspect the ROI labels. The object contains labels for the lidar point cloud sequence and the video.

```
gTruth.ROIlabelData
```

```
ans =
```

```
R0ILabelData with properties:
```

```
video_01_city_c2s_fcw_10s: [204x2 timetable]
lidarSequence: [34x2 timetable]
```

Create a new `groundTruthMultisignal` object that contains only labels that are of type cuboid.

```
labelTypes = labelType.Cuboid;
gtLabel = selectLabelsByLabelType(gTruth, labelTypes);
```

For the original and new objects, inspect the first five rows of label data for the lidar point cloud sequence. Because the lidar point cloud signal in the original object contains only cuboid labels, the new object contains the same label data for the lidar sequence as the original object.

```
lidarLabels = gTruth.R0ILabelData.lidarSequence;
lidarLabelsSelection = gtLabel.R0ILabelData.lidarSequence;
```

```
numrows = 5;
head(lidarLabels, numrows)
head(lidarLabelsSelection, numrows)
```

Time	car	truck
0 sec	{1x1 struct}	{1x0 struct}
0.29926 sec	{1x1 struct}	{1x0 struct}
0.59997 sec	{1x1 struct}	{1x0 struct}
0.8485 sec	{1x1 struct}	{1x0 struct}
1.1484 sec	{1x1 struct}	{1x0 struct}

Time	car	truck
0 sec	{1x1 struct}	{1x0 struct}
0.29926 sec	{1x1 struct}	{1x0 struct}
0.59997 sec	{1x1 struct}	{1x0 struct}
0.8485 sec	{1x1 struct}	{1x0 struct}
1.1484 sec	{1x1 struct}	{1x0 struct}

For the original and new objects, inspect the first five rows of label data for the video. Because video signals do not support the `Cuboid` label type, the new object contains no label data for the video.

```
videoLabels = gTruth.R0ILabelData.video_01_city_c2s_fcw_10s;
videoLabelsSelection = gtLabel.R0ILabelData.video_01_city_c2s_fcw_10s;
```

```
head(videoLabels, numrows)
head(videoLabelsSelection, numrows)
```

Time	car	truck
0 sec	{1x3 struct}	{1x0 struct}
0.05 sec	{1x3 struct}	{1x0 struct}

```

0.1 sec    {1x3 struct}    {1x0 struct}
0.15 sec   {1x3 struct}   {1x0 struct}
0.2 sec    {1x3 struct}    {1x0 struct}

```

```

Time
-----
0 sec
0.05 sec
0.1 sec
0.15 sec
0.2 sec

```

Input Arguments

gTruth — Multisignal ground truth data

`groundTruthMultisignal` object | vector of `groundTruthMultisignal` objects

Multisignal ground truth data, specified as a `groundTruthMultisignal` object or vector of `groundTruthMultisignal` objects.

labelTypes — Label types

`labelType` enumeration | vector of `labelType` enumerations

Label types, specified as a `labelType` enumeration or vector of `labelType` enumerations.

To view all label types in a `groundTruthMultisignal` object, `gTruth`, enter this command at the MATLAB command prompt.

```
unique(gTruth.LabelDefinitions.LabelType)
```

Example: `labelType.Cuboid`

Example: `[labelType.Cuboid labelType.Scene]`

Output Arguments

gtLabel — Ground truth with only selected labels

`groundTruthMultisignal` object | vector of `groundTruthMultisignal` objects

Ground truth with only the selected labels, returned as a `groundTruthMultisignal` object or vector of `groundTruthMultisignal` objects.

Each `groundTruthMultisignal` object in `gtLabel` corresponds to a `groundTruthMultisignal` object in the `gTruth` input. The returned objects contain only the labels that are of the label types specified by the `labelTypes` input.

Limitations

- Selecting sublabels by label type is not supported.

Version History

Introduced in R2020a

See Also

Objects

groundTruthMultisignal

Functions

selectLabelsByLabelName | selectLabelsByGroupName | selectLabelsBySignalName |
selectLabelsBySignalType

selectLabelsByGroupName

Select multisignal ground truth by label group name

Syntax

```
gtLabel = selectLabelsByGroupName(gTruth, labelGroups)
```

Description

`gtLabel = selectLabelsByGroupName(gTruth, labelGroups)` selects labels belonging to the groups specified by `labelGroups` from a `groundTruthMultisignal` object, `gTruth`. The function returns a corresponding `groundTruthMultisignal` object, `gtLabel`, that contains only the selected labels. If `gTruth` is a vector of `groundTruthMultisignal` objects, then the function returns a vector of corresponding `groundTruthMultisignal` objects that contain only the selected labels.

Examples

Select Ground Truth Labels by Group Name

Select ground truth labels from a `groundTruthMultisignal` object by specifying a group name.

Load a `groundTruthMultisignal` object containing ROI and scene label data for a video and corresponding lidar point cloud sequence. The helper function used to load this object is attached to the example as a supporting file.

```
gTruth = helperLoadGTruthVideoLidar;
```

Inspect the label definitions. The object contains label definitions in a "Vehicles" group. Ungrouped labels are in the group named "None".

```
gTruth.LabelDefinitions
```

```
ans =
```

```
5x7 table
```

Name	SignalType	LabelType	Group	Description	LabelColor
{'car' }	Image	Rectangle	{'Vehicles'}	{0x0 char}	{[0.5862 0.8276 0.3100]}
{'car' }	PointCloud	Cuboid	{'Vehicles'}	{0x0 char}	{[0.5862 0.8276 0.3100]}
{'truck'}	Image	Rectangle	{'Vehicles'}	{0x0 char}	{[0.5172 0.5172 1]}
{'truck'}	PointCloud	Cuboid	{'Vehicles'}	{0x0 char}	{[0.5172 0.5172 1]}
{'sunny'}	Time	Scene	{'None' }	{0x0 char}	{[0 0.7241 0.6552]}

Create a new `groundTruthMultisignal` object that contains labels for only the "Vehicles" group.

```
groupNames = "Vehicles";  
gtLabel = selectLabelsByGroupName(gTruth, groupNames);
```

For the original and new objects, inspect the ROI label data. Because "Vehicles" is the only group used for the ROI label data, the original and new object contain identical ROI label data.

```
gTruth.ROILabelData  
gtLabel.ROILabelData
```

```
ans =
```

```
ROILabelData with properties:
```

```
video_01_city_c2s_fcw_10s: [204x2 timetable]  
lidarSequence: [34x2 timetable]
```

```
ans =
```

```
ROILabelData with properties:
```

```
video_01_city_c2s_fcw_10s: [204x2 timetable]  
lidarSequence: [34x2 timetable]
```

For the original and new objects, inspect the scene label data. The "None" group, which is used only in scene labels, was not selected. Therefore, the new object contains no scene label data.

```
gTruth.SceneLabelData  
gtLabel.SceneLabelData
```

```
ans =
```

```
SceneLabelData with properties:
```

```
sunny: [0 sec 10.15 sec]
```

```
ans =
```

```
SceneLabelData with properties:
```

```
sunny: [0x0 duration]
```

Input Arguments

gTruth — Multisignal ground truth data

groundTruthMultisignal object | vector of groundTruthMultisignal objects

Multisignal ground truth data, specified as a groundTruthMultisignal object or vector of groundTruthMultisignal objects.

labelGroups — Label group names

character vector | string scalar | cell array of character vectors | string vector

Label group names, specified as a character vector, string scalar, cell array of character vectors, or string vector.

To view all label group names in a `groundTruthMultisignal` object, `gTruth`, enter this command at the MATLAB command prompt.

```
unique(gTruth.LabelDefinitions.Group)
```

```
Example: 'Vehicles'
```

```
Example: "Vehicles"
```

```
Example: {'Vehicles', 'Signs'}
```

```
Example: ["Vehicles" "Signs"]
```

Output Arguments

gtLabel — Ground truth with only selected labels

`groundTruthMultisignal` object | vector of `groundTruthMultisignal` objects

Ground truth with only the selected labels, returned as a `groundTruthMultisignal` object or vector of `groundTruthMultisignal` objects.

Each `groundTruthMultisignal` object in `gtLabel` corresponds to a `groundTruthMultisignal` object in the `gTruth` input. The returned objects contain only the labels belonging to the groups specified by the `labelGroups` input.

Version History

Introduced in R2020a

See Also

Objects

`groundTruthMultisignal`

Functions

`selectLabelsByLabelName` | `selectLabelsBySignalName` | `selectLabelsBySignalType` | `selectLabelsByLabelType`

selectLabelsBySignalName

Select multisignal ground truth by signal name

Syntax

```
gtLabel = selectLabelsBySignalName(gTruth, signalNames)
```

Description

`gtLabel = selectLabelsBySignalName(gTruth, signalNames)` selects labels for the signals specified by `signalNames` from a `groundTruthMultisignal` object, `gTruth`. The function returns a corresponding `groundTruthMultisignal` object, `gtLabel`, that contains only the selected labels. If `gTruth` is a vector of `groundTruthMultisignal` objects, then the function returns a vector of corresponding `groundTruthMultisignal` objects that contain only the selected labels.

Examples

Select Ground Truth Labels by Signal Name

Select ground truth labels from a `groundTruthMultisignal` object by specifying a signal name.

Load a `groundTruthMultisignal` object containing ROI and scene label data for a video and corresponding lidar point cloud sequence. The helper function used to load this object is attached to the example as a supporting file.

```
gTruth = helperLoadGTruthVideoLidar;
```

Inspect the ROI labels. The object contains labels for the lidar point cloud sequence and the video.

```
gTruth.ROILabelData
```

```
ans =
```

```
ROILabelData with properties:
```

```
video_01_city_c2s_fcw_10s: [204x2 timetable]  
lidarSequence: [34x2 timetable]
```

Create a new `groundTruthMultisignal` object that contains labels for only the `lidarSequence` signal.

```
signalNames = "lidarSequence";  
gtLabel = selectLabelsBySignalName(gTruth, signalNames);
```

For the original and new objects, inspect the first five rows of label data for the lidar point cloud sequence. The new object contains the same label data for the lidar sequence as the original object.

```
lidarLabels = gTruth.ROILabelData.lidarSequence;  
lidarLabelsSelection = gtLabel.ROILabelData.lidarSequence;
```



```
numrows = 5;
head(lidarLabels,numrows)
head(lidarLabelsSelection,numrows)
```

Time	car	truck
0 sec	{1x1 struct}	{1x0 struct}
0.29926 sec	{1x1 struct}	{1x0 struct}
0.59997 sec	{1x1 struct}	{1x0 struct}
0.8485 sec	{1x1 struct}	{1x0 struct}
1.1484 sec	{1x1 struct}	{1x0 struct}

Time	car	truck
0 sec	{1x1 struct}	{1x0 struct}
0.29926 sec	{1x1 struct}	{1x0 struct}
0.59997 sec	{1x1 struct}	{1x0 struct}
0.8485 sec	{1x1 struct}	{1x0 struct}
1.1484 sec	{1x1 struct}	{1x0 struct}

For the original and new objects, inspect the first five rows of label data for the video. The new object contains no label data for the video.

```
videoLabels = gTruth.R0ILabelData.video_01_city_c2s_fcw_10s;
videoLabelsSelection = gtLabel.R0ILabelData.video_01_city_c2s_fcw_10s;
```

```
head(videoLabels,numrows)
head(videoLabelsSelection,numrows)
```

Time	car	truck
0 sec	{1x3 struct}	{1x0 struct}
0.05 sec	{1x3 struct}	{1x0 struct}
0.1 sec	{1x3 struct}	{1x0 struct}
0.15 sec	{1x3 struct}	{1x0 struct}
0.2 sec	{1x3 struct}	{1x0 struct}

Time
0 sec
0.05 sec
0.1 sec
0.15 sec
0.2 sec

Input Arguments

gTruth — Multisignal ground truth data

groundTruthMultisignal object | vector of groundTruthMultisignal objects

Multisignal ground truth data, specified as a `groundTruthMultisignal` object or vector of `groundTruthMultisignal` objects.

signalNames — Signal names

character vector | string scalar | cell array of character vectors | string vector

Signal names, specified as a character vector, string scalar, cell array of character vectors, or string vector.

To view all signal names in a `groundTruthMultisignal` object, `gTruth`, enter this command at the MATLAB command prompt.

```
gTruth.DataSource.SignalName
```

```
Example: 'lidarSequence'
```

```
Example: "lidarSequence"
```

```
Example: {'lidarSequence', 'imageSequence'}
```

```
Example: ["lidarSequence" "imageSequence"]
```

Output Arguments**gtLabel — Ground truth with only selected labels**

`groundTruthMultisignal` object | vector of `groundTruthMultisignal` objects

Ground truth with only the selected labels, returned as a `groundTruthMultisignal` object or vector of `groundTruthMultisignal` objects.

Each `groundTruthMultisignal` object in `gtLabel` corresponds to a `groundTruthMultisignal` object in the `gTruth` input. The returned objects contain only the labels with signal names specified by the `signalNames` input.

Version History

Introduced in R2020a

See Also**Objects**

`groundTruthMultisignal`

Functions

`selectLabelsByLabelName` | `selectLabelsByLabelType` | `selectLabelsByGroupName` | `selectLabelsBySignalType`

selectLabelsBySignalType

Select multisignal ground truth labels by signal type

Syntax

```
gtLabel = selectLabelsBySignalType(gTruth, signalTypes)
```

Description

`gtLabel = selectLabelsBySignalType(gTruth, signalTypes)` selects labels of the signal types specified by `signalTypes` from a `groundTruthMultisignal` object, `gTruth`. The function returns a corresponding `groundTruthMultisignal` object, `gtLabel`, that contains only the selected labels. If `gTruth` is a vector of `groundTruthMultisignal` objects, then the function returns a vector of corresponding `groundTruthMultisignal` objects that contain only the selected labels.

Examples

Select Ground Truth Labels by Signal Type

Select ground truth labels from a `groundTruthMultisignal` object by specifying a signal type.

Load a `groundTruthMultisignal` object containing ROI and scene label data for a video and corresponding lidar point cloud sequence. The helper function used to load this object is attached to the example as a supporting file.

```
gTruth = helperLoadGTruthVideoLidar;
```

Inspect the label definitions. The object contains definitions for image, point cloud, and time signals.

```
gTruth.LabelDefinitions
```

```
ans =
```

```
5x7 table
```

Name	SignalType	LabelType	Group	Description	LabelColor
{'car' }	Image	Rectangle	{'Vehicles'}	{0x0 char}	{[0.5862 0.8276 0.3103]}
{'car' }	PointCloud	Cuboid	{'Vehicles'}	{0x0 char}	{[0.5862 0.8276 0.3103]}
{'truck'}	Image	Rectangle	{'Vehicles'}	{0x0 char}	{[0.5172 0.5172 0]}
{'truck'}	PointCloud	Cuboid	{'Vehicles'}	{0x0 char}	{[0.5172 0.5172 0]}
{'sunny'}	Time	Scene	{'None' }	{0x0 char}	{[0 0.7241 0.655]}

Inspect the ROI labels. The object contains labels for the lidar point cloud sequence and the video.

```
gTruth.ROIlabelData
```

```
ans =
```

```
R0ILabelData with properties:
```

```
video_01_city_c2s_fcw_10s: [204x2 timetable]
      lidarSequence: [34x2 timetable]
```

Create a new `groundTruthMultisignal` object that contains labels for only point cloud signals.

```
signalTypes = vision.labeler.loading.SignalType.PointCloud;
gtLabel = selectLabelsBySignalType(gTruth, signalTypes);
```

For the original and new objects, inspect the first five rows of label data for the lidar point cloud sequence. Because lidar signals are of type `PointCloud`, the new object contains the same label data for the lidar sequence as the original object.

```
lidarLabels = gTruth.R0ILabelData.lidarSequence;
lidarLabelsSelection = gtLabel.R0ILabelData.lidarSequence;
```

```
numrows = 5;
head(lidarLabels, numrows)
head(lidarLabelsSelection, numrows)
```

Time	car	truck
0 sec	{1x1 struct}	{1x0 struct}
0.29926 sec	{1x1 struct}	{1x0 struct}
0.59997 sec	{1x1 struct}	{1x0 struct}
0.8485 sec	{1x1 struct}	{1x0 struct}
1.1484 sec	{1x1 struct}	{1x0 struct}

Time	car	truck
0 sec	{1x1 struct}	{1x0 struct}
0.29926 sec	{1x1 struct}	{1x0 struct}
0.59997 sec	{1x1 struct}	{1x0 struct}
0.8485 sec	{1x1 struct}	{1x0 struct}
1.1484 sec	{1x1 struct}	{1x0 struct}

For the original and new objects, inspect the first five rows of label data for the video. Because video signals are of type `Image`, the new object contains no label data for the video.

```
videoLabels = gTruth.R0ILabelData.video_01_city_c2s_fcw_10s;
videoLabelsSelection = gtLabel.R0ILabelData.video_01_city_c2s_fcw_10s;
```

```
head(videoLabels, numrows)
head(videoLabelsSelection, numrows)
```

Time	car	truck
0 sec	{1x3 struct}	{1x0 struct}
0.05 sec	{1x3 struct}	{1x0 struct}

```
0.1 sec    {1x3 struct}    {1x0 struct}
0.15 sec   {1x3 struct}   {1x0 struct}
0.2 sec    {1x3 struct}   {1x0 struct}
```

Time

```
0 sec
0.05 sec
0.1 sec
0.15 sec
0.2 sec
```

Input Arguments

gTruth — Multisignal ground truth data

groundTruthMultisignal object | vector of groundTruthMultisignal objects

Multisignal ground truth data, specified as a groundTruthMultisignal object or vector of groundTruthMultisignal objects.

signalTypes — Signal types

vision.labeler.loading.SignalType enumeration | vector of vision.labeler.loading.SignalType enumerations

Signal types, specified as a vision.labeler.loading.SignalType enumeration or vector of vision.labeler.loading.SignalType enumerations.

To view all signal types in a groundTruthMultisignal object, gTruth, enter this command at the MATLAB command prompt.

```
unique(gTruth.LabelDefinitions.SignalType)
```

Example: vision.labeler.loading.SignalType.Image

Example: [vision.labeler.loading.SignalType.Image
vision.labeler.loading.SignalType.PointCloud]

Output Arguments

gtLabel — Ground truth with only selected labels

groundTruthMultisignal object | vector of groundTruthMultisignal objects

Ground truth with only the selected labels, returned as a groundTruthMultisignal object or vector of groundTruthMultisignal objects.

Each groundTruthMultisignal object in gtLabel corresponds to a groundTruthMultisignal object in the gTruth input. The returned objects contain only the labels that are of the signal types specified by the signalTypes input.

Limitations

- Selecting sublabels by signal type is not supported.

Version History

Introduced in R2020a

See Also

Objects

groundTruthMultisignal

Functions

selectLabelsByLabelName | selectLabelsByLabelType | selectLabelsByGroupName |
selectLabelsBySignalName

gatherLabelData

Gather synchronized label data from ground truth

Syntax

```
labelData = gatherLabelData(gTruth,signalNames,labelTypes)
[labelData,timestamps] = gatherLabelData( ___ )
[ ___ ] = gatherLabelData( ___ ,Name=Value)
```

Description

`labelData = gatherLabelData(gTruth,signalNames,labelTypes)` returns synchronized label data gathered from multisignal ground truth data, `gTruth`. The function returns label data for the signals specified by `signalNames` and the label types specified by `labelTypes`.

`[labelData,timestamps] = gatherLabelData(___)` additionally returns the signal timestamps associated with the gathered label data, using the arguments from the previous syntax.

Use `timestamps` with the `writeFrames` function to write the associated signal frames from the `groundTruthMultisignal` objects to disk. Use these frames and the associated labels as training data for machine learning or deep learning models.

`[___] = gatherLabelData(___ ,Name=Value)` specifies options using one or more name-value arguments in addition to any combination of arguments from previous syntaxes. For example, `Verbose=True` enables display to the workspace environment.

Examples

Gather Label Data and Write Associated Signal Frames

Gather label data for a video signal and a lidar point cloud sequence signal from a `groundTruthMultisignal` object. Write the signal frames associated with that label data to disk and visualize the frames.

Add the point cloud sequence folder path to the MATLAB® search path. The video is already on the MATLAB search path.

```
pcSeqDir = fullfile(toolboxdir('driving'),'drivingdata', ...
    'lidarSequence');
addpath(pcSeqDir);
```

Load a `groundTruthMultisignal` object that contains label data for the video and the lidar point cloud sequence.

```
data = load('MultisignalGTruth.mat');
gTruth = data.gTruth;
```

Specify the signals from which to gather label data.

```
signalNames = ["video_01_city_c2s_fcw_10s" "lidarSequence"];
```

The video contains rectangle labels, whereas the lidar point cloud sequence contains cuboid labels. Gather the rectangle labels from the video and the cuboid labels from the lidar point cloud sequence.

```
labelTypes = [labelType.Rectangle labelType.Cuboid];
[labelData,timestamps] = gatherLabelData(gTruth,signalNames,labelTypes);
```

Display the first eight rows of label data from the two signals. Both signals contain data for the Car label. In the video, the Car label is drawn as a rectangle bounding box. In the lidar point cloud sequence, the Car label is drawn as a cuboid bounding box.

```
videoLabelSample = head(labelData{1})
lidarLabelSample = head(labelData{2})
```

```
videoLabelSample =
```

```
table
      Car
-----
 {[299 213 42 33]}
```

```
lidarLabelSample =
```

```
table
      Car
-----
 {[17.7444 6.7386 3.3291 3.6109 3.2214 3.5583 0 0 0]}
```

Write signal frames associated with the gathered label data to temporary folder locations, with one folder per signal. Use the timestamps returned by the `gatherLabelData` function to indicate which signal frames to write.

```
outputFolder = fullfile(tempdir,["videoFrames" "lidarFrames"]);
fileNames = writeFrames(gTruth,signalNames,outputFolder,timestamps);
```

Writing 2 frames from the following signals:

```
* video_01_city_c2s_fcw_10s
* lidarSequence
```

Load the written video signal frames by using an `imageDatastore` object. Load the associated rectangle label data by using a `boxLabelDatastore` object.

```
imds = imageDatastore(fileNames{1});
blds = boxLabelDatastore(labelData{1});
```

Load the written lidar signal frames by using a `fileDatastore` object. Load the associated cuboid label data by using a `boxLabelDatastore` object.

```
fds = fileDatastore(fileNames{2}, 'ReadFcn', @pcread);
clds = boxLabelDatastore(labelData{2});
```

Visualize the written video frames by using a `vision.VideoPlayer` object. Visualize the written lidar frames by using a `pcplayer` object.

```
videoPlayer = vision.VideoPlayer;  
  
ptCloud = preview(fds);  
ptCloudPlayer = pcplayer(ptCloud.XLimits,ptCloud.YLimits,ptCloud.ZLimits);  
  
while hasdata(imds)  
    % Read video and lidar frames.  
    I = read(imds);  
    ptCloud = read(fds);  
  
    % Visualize video and lidar frames.  
    videoPlayer(I);  
    view(ptCloudPlayer,ptCloud);  
end
```

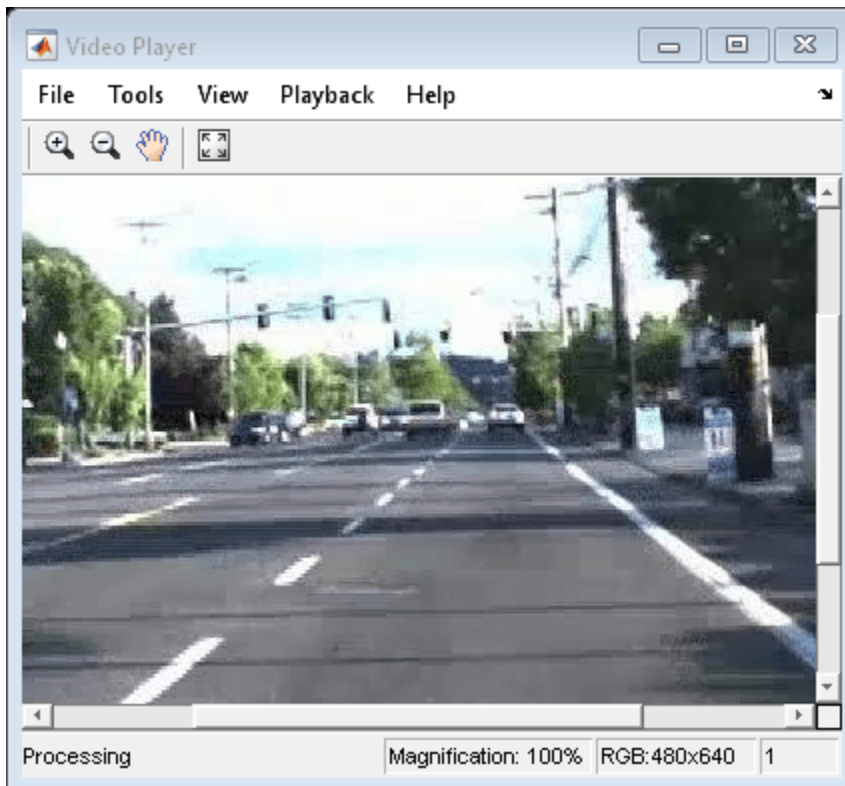

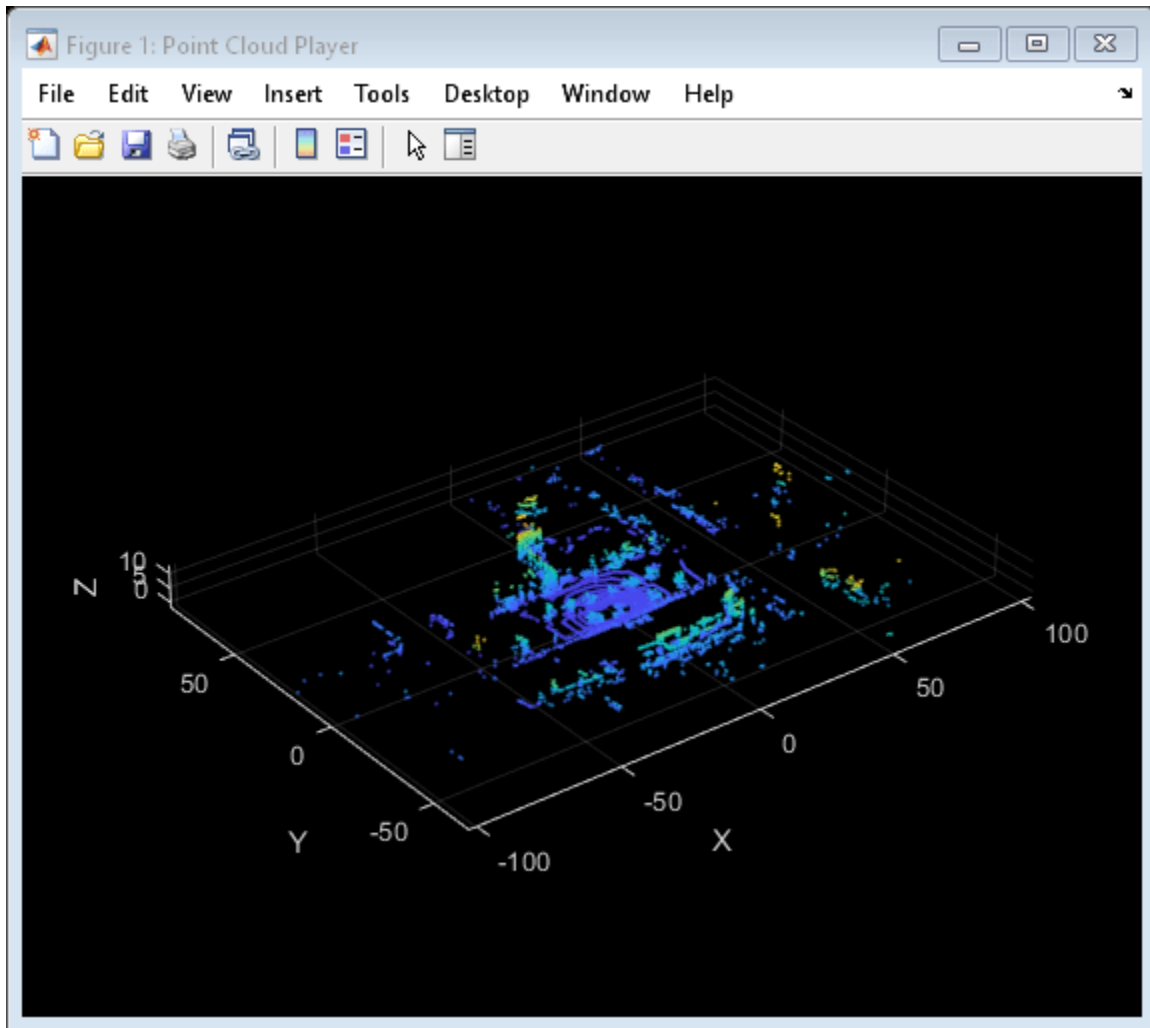

Remove the path to the point cloud sequence folder.

```
rmpath(pcSeqDir);
```

Input Arguments

gTruth — Multisignal ground truth data

groundTruthMultisignal object | vector of groundTruthMultisignal objects

Multisignal ground truth data, specified as a `groundTruthMultisignal` object or vector of `groundTruthMultisignal` objects.

Each `groundTruthMultisignal` object in `gTruth` must include all the signals specified in the `signalNames` input.

In addition, each object must include at least one marked label per gathered label definition. Suppose `gTruth` is a `groundTruthMultisignal` object containing label data for a single video signal named `video_front_camera`. The object contains marked rectangle region of interest (ROI) labels for the car label definition but not for the truck label definition. If you use this syntax to gather labels of type `Rectangle` from this object, then the `gatherLabelData` function returns an error.

```
labelData = gatherLabelData(gTruth, "video_front_camera", labelType.Rectangle);
```

signalNames — Names of signals

character vector | string scalar | cell array of character vectors | string array

Names of the signals from which to gather label data, specified as a character vector, string scalar, cell array of character vectors, or string vector. The signal names must be valid signal names stored in the input multisignal ground truth data, `gTruth`.

To obtain the signal names from a `groundTruthMultisignal` object, use this syntax, where `gTruth` is the variable name of the object:

```
gTruth.DataSource.SignalName
```

```
Example: 'video_01_city_c2s_fcw_10s'
```

```
Example: "video_01_city_c2s_fcw_10s"
```

```
Example: {'video_01_city_c2s_fcw_10s', 'lidarSequence'}
```

```
Example: ["video_01_city_c2s_fcw_10s" "lidarSequence"]
```

labelTypes — Label types

`labelType` enumeration scalar | `labelType` enumeration vector | cell array of `labelType` enumeration scalars and vectors

Label types from which to gather label data, specified as a `labelType` enumeration scalar, `labelType` enumeration vector, or a cell array of `labelType` enumeration scalars and vectors. The `gatherLabelData` function gathers label data for each signal specified by input `signalNames` and each `groundTruthMultisignal` object specified by input `gTruth`. The number of elements in `labelTypes` must match the number of signals in `signalNames`.

Gather Label Data for Single Label Type per Signal

To gather label data for a single label type per signal, specify `labelTypes` as a `labelType` enumeration scalar or vector. Across all `groundTruthMultisignal` objects in `gTruth`, the `gatherLabelData` function gathers `labelTypes(n)` label data from `signalName(n)`, where `n` is the index of the label type and the corresponding signal name whose label data is to be gathered. Each returned table in the output `labelData` cell array contains data for only one label type per signal.

In this code sample, the `gatherLabelData` function gathers labels of type `Rectangle` from a video signal named `video_front_camera`. The function also gathers labels of type `Cuboid` from a lidar point cloud sequence signal stored in a folder named `lidarData`. The `gTruth` input contains the `groundTruthMultisignal` objects from which this data is to be gathered.

```
labelData = gatherLabelData(gTruth, ...
    ["video_front_camera", "lidarData"], ...
    [labelType.Rectangle, labelType.Cuboid]);
```

To gather label data for a single label type from separate signals, you must repeat the label type for each signal. In this code sample, the `gatherLabelData` function gathers labels of type `Rectangle` from the `video_left_camera` and `video_right_camera` video signals.

```
labelData = gatherLabelData(gTruth, ...
    ["video_left_camera", "video_right_camera"], ...
    [labelType.Rectangle, labelType.Rectangle]);
```

Gather Label Data for Multiple Label Types per Signal

To gather label data for multiple label types per signal, specify `labelTypes` as a cell array of `labelType` enumeration scalars and vectors. Across all `groundTruthMultisignal` objects in `gTruth`, the `gatherLabelData` function gathers `labelTypes{n}` label data from `signalName(n)`, where `n` is the index of the label types and the corresponding signal name whose label data is to be gathered. The function groups the data for these label types into one table per signal per `groundTruthMultisignal` object.

In this code sample, the `gatherLabelData` function gathers labels of type `Rectangle` and `Line` from the `video_front_camera` video signal. The function also gathers labels of type `Cuboid` from a lidar point cloud sequence signal stored in a folder named `lidarData`. The `gTruth` input contains the `groundTruthMultisignal` objects from which this data is to be gathered.

```
labelData = gatherLabelData(gTruth, ...
    ["video_front_camera", ...
    "lidarData"], ...
    {[labelType.Rectangle labelType.Line], ...
    labelType.Cuboid});
```

Valid Enumeration Types

You can specify one or more of these enumeration types.

- `labelType.Rectangle` — Rectangle ROI labels
- `labelType.Cuboid` — Cuboid ROI labels (point clouds)
- `labelType.ProjectedCuboid` — Projected cuboid ROI labels (images and video data)
- `labelType.Line` — Line ROI labels
- `labelType.PixelLabel` — Pixel ROI labels
- `labelType.Polygon` — Polygon ROI labels
- `labelType.Scene` — Scene labels

To gather label data for scenes, you must specify `labelTypes` as the `labelType.Scene` enumeration scalar. You cannot specify any other label types with `labelType.Scene`.

Name-Value Pair Arguments

Specify optional pairs of arguments as `Name1=Value1, ..., NameN=ValueN`, where `Name` is the argument name and `Value` is the corresponding value. Name-value arguments must appear after other arguments, but the order of the pairs does not matter.

Example: (`SamplingFactor=5`) sets the subsampling factor to 5 to drop every fifth frame.

SamplingFactor — Factor for subsampling images

1 (default) | integer | vector of integers

Sample factor used to subsample label data, specified as a positive integer. A sample factor of `K` includes every `K`th signal frame. Increase the sample factor to drop redundant frames from signals with high sample rates, such as videos. To set the `SamplingFactor` with projected cuboid data, you must specify the `LabelData` name-value argument to `labelType.ProjectedCuboid`.

Use sampled data to reduce repeated data, such as a sequence of images with the same scene and labels. It can also help in reducing training time.

GroupLabelData — Group columns from label data

"LabelName" (default) | "LabelType"

Group columns from label data, specified as "LabelName" or "LabelType".

- "LabelName" — Groups the label data into columns by label definitions.
- "LabelType" — Groups the label data into columns by label type. You can use this option to gather label data while retaining the region-of-interest (ROI) stacking order determined by the label type.

IncludeAttributeAndSublabel — Logical to indicate if attribute and sublabel data is returned in label data output

false (0) (default) | true (1)

Logical to indicate if attribute and sublabel data is returned in label data output, specified as a logical false (0) or true (1). A value of false indicates that only the position values that correspond to ROIs are collected. A value of true indicates that each table in LabelData contain structs that contain the position, attributes, and sublabels associated with each label.

Output Arguments**LabelData — Label data**

cell array of tables

Label data, returned as an M-by-N cell array of tables, where:

- M is the number of groundTruthMultisignal objects in gTruth.
- When labelTypes contains ROI labelType enumerations, N is the number of signals in signalNames and the number of elements in labelTypes. In this case, labelData{m,n} contains a table of label data for the nth signal of signalNames that is in the mth groundTruthMultisignal object of gTruth. The table contains label data for only the label types in the nth position of labelTypes.
- When labelTypes contains only the labelType.Scene enumeration, N is equal to 1. In this case, labelData{m} contains a table of scene label data across all signals in the mth groundTruthMultisignal object of gTruth.

For a given label data table, tbl, the table is of size T-by-L, where:

- T is the number of timestamps in the signal for which label data exists.
- L is the number of label definitions that are of the label types gathered for that signal.
- tbl(t,l) contains the label data gathered for the lth label at the tth timestamp.

If one of the signals has no label data at a timestamp, then the corresponding label data table does not include a row for that timestamp.

For each cell in the table, the format of the returned label data depends on the type of label.

Label Type	Storage Format for Labels at Each Timestamp
labelType.Rectangle	<p>M-by-4 numeric matrix of the form [x, y, w, h], where:</p> <ul style="list-style-type: none">• M is the number of labels in the frame.• x and y specify the upper-left corner of the rectangle.• w specifies the width of the rectangle, which is its length along the x-axis.• h specifies the height of the rectangle, which is its length along the y-axis.

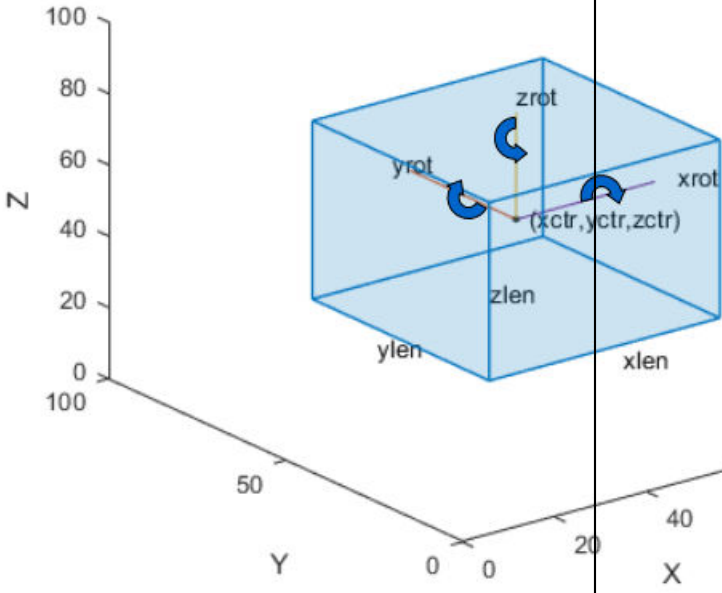
Label Type	Storage Format for Labels at Each Timestamp
labelType.Cuboid	<p>M-by-9 numeric matrix with rows of the form [xctr, yctr, zctr, xlen, ylen, zlen, xrot, yrot, zrot], where:</p> <ul style="list-style-type: none"> • M is the number of labels in the frame. • xctr, yctr, and zctr specify the center of the cuboid. • xlen, ylen, and zlen specify the length of the cuboid along the x-axis, y-axis, and z-axis, respectively, before rotation has been applied. • xrot, yrot, and zrot specify the rotation angles for the cuboid along the x-axis, y-axis, and z-axis, respectively. These angles are clockwise-positive when looking in the forward direction of their corresponding axes. <p>The figure shows how these values determine the position of a cuboid.</p> 

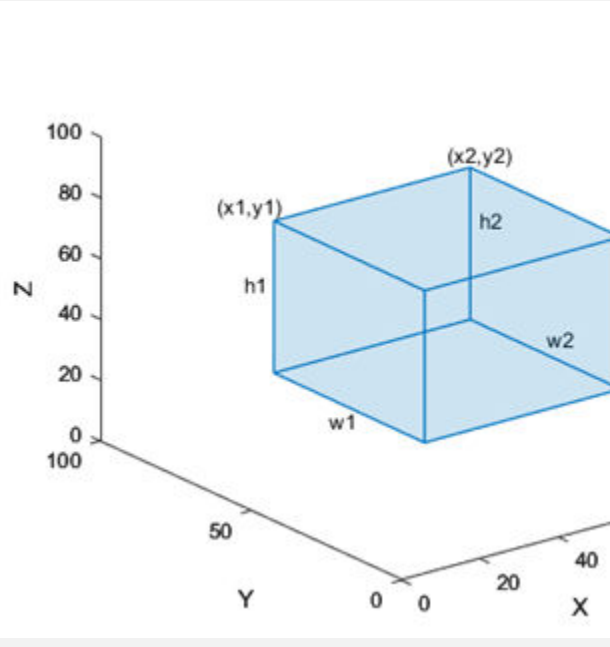
Label Type	Storage Format for Labels at Each Timestamp
labelType.ProjectectedCuboid	<p>M-by-8 vector of the form [x1, y1, w1, h1, x2, y2, w2, h2], where:</p> <ul style="list-style-type: none"> • M is the number of labels in the frame. • x1, y1 specifies the x,y coordinates for the upper-left location of the front-face of the projected cuboid • w1 specifies the width for the front-face of the projected cuboid. • h1 specifies the height for the front-face of the projected cuboid. • x2, y2 specifies the x,y coordinates for the upper-left location of the back-face of the projected cuboid. • w2 specifies the width for the back-face of the projected cuboid. • h2 specifies the height for the back-face of the projected cuboid. <p>The figure shows how these values determine the position of a cuboid.</p> 
labelType.Line	<p>M-by-1 vector of cell arrays, where M is the number of labels in the frame. Each cell array contains an N-by-2 numeric matrix of the form [x1 y1; x2 y2; ... ; xN yN] for N points in the polyline.</p>

Label Type	Storage Format for Labels at Each Timestamp
<code>labelType.PixelLabel</code>	Label data for all pixel label definitions is stored in a single M -by-1 <code>PixelLabelData</code> column for M images or frames. Each element contains a filename for a pixel label image. A pixel label image describes the label or labels contained in the corresponding image. The labels can be described as a 1- or 3- channel label matrix. To use <code>PixelLabelData</code> with any of the labeler apps, you must use a single-channel label matrix, where the values are of type <code>uint8</code> . You can convert a 3-channel pixel label data matrix to a single-channel label matrix programmatically to use with the labeler apps.
<code>labelType.Polygon</code>	M -by-1 vector of cell arrays, where M is the number of labels. Each cell array contains an N -by-2 numeric matrix of the form $[x_1 \ y_1; x_2 \ y_2; \dots; x_N \ y_N]$ for N points in the polygon.
<code>labelType.Scene</code>	Logical 1 (<code>true</code>) if the scene label is applied. Otherwise logical 0 (<code>false</code>)

Label Data Format

Consider a cell array of label data gathered by using the `gatherLabelData` function. The function gathers labels from three `groundTruthMultisignal` objects with variable names `gTruth1`, `gTruth2`, and `gTruth3`.

- For a video signal named `video_front_camera`, the function gathers labels of type `Rectangle` and `Line`.
- For a lidar point cloud sequence signal stored in a folder named `lidarData`, the function gathers labels of type `Cuboid`.

This code shows the call to the `gatherLabelData` function.

```
labelData = gatherLabelData([gTruth1 gTruth2 gTruth3], ...
    ["video_front_camera", ...
    "lidarData"], ...
    {[labelType.Rectangle labelType.Line], ...
    labelType.Cuboid});
```

The `labelData` output is a 3-by-2 cell array of tables. Each row of the cell array contains label data for one of the `groundTruthMultisignal` objects. The first column contains the label data for the video signal, `video_front_camera`. The second column contains the label data for the point cloud sequence signal, `lidarData`. This figure shows the `labelData` cell array.

	1	2
gTruth1	1 4x2 table	4x1 table
gTruth2	2 4x2 table	4x1 table
gTruth3	3 4x2 table	4x1 table

This figure shows the label data table for the video signal in the third `groundTruthMultisignal` object. The `gatherLabelData` function gathered data for a `Rectangle` label named `car` and a `Line` label named `lane`. The table contains label data at four timestamps in the signal.

	1	2
	car	lane
1	[208,208,39,32;365,205,73,40]	2x1 cell
2	[280,204,47,49;358,204,58,46]	2x1 cell
3	[292,204,74,43]	2x1 cell
4	[289,206,79,49]	2x1 cell

This figure shows the label data table for the lidar signal in the third `groundTruthMultisignal` object. The `gatherLabelData` function gathered data for a `Cuboid` label, also named `car`. The `car` label appears in both signal types because it is marked as a `Rectangle` label for video signals and a `Cuboid` label for lidar signals. The table contains label data at four timestamps in the signal.

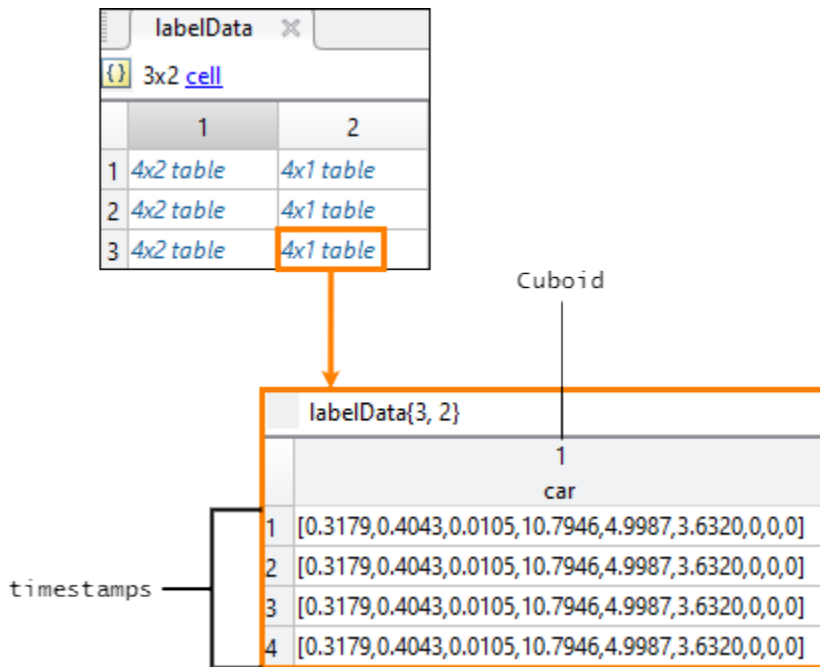

timestamps – Signal timestamps

cell array of duration vectors

Signal timestamps, returned as an M-by-N cell array of duration vectors, where:

- M is the number of `groundTruthMultisignal` objects in `gTruth`.
- N is the number of signals in `signalNames`.
- `labelData{m,n}` contains the timestamps for the *n*th signal of `signalNames` that is in the *m*th `groundTruthMultisignal` object of `gTruth`.

If you gather label data from multiple signals, the signal timestamps are synchronized to the timestamps of the first signal specified by `signalNames`.

Version History

Introduced in R2020a

See Also

`writeFrames` | `groundTruthMultisignal` | `boxLabelDatastore`

writeFrames

Write signal frames for ground truth data to disk

Syntax

```
fileNames = writeFrames(gTruth,signalNames,location)
fileNames = writeFrames(gTruth,signalNames,location,timestamps)
fileNames = writeFrames( ___,Name,Value)
```

Description

`fileNames = writeFrames(gTruth,signalNames,location)` writes the frames of ground truth signal sources to the specified folder locations. The function returns the names of the files containing the written frames. `fileNames` contains one file name per signal specified by `signalNames` per `groundTruthMultisignal` object specified by `gTruth`.

Use these written frames and the associated ground truth labels obtained from the `gatherLabelData` function as training data for machine learning or deep learning models.

`fileNames = writeFrames(gTruth,signalNames,location,timestamps)` specifies the timestamps of the signal frames to write. To obtain signal timestamps, use the `gatherLabelData` function.

`fileNames = writeFrames(___,Name,Value)` specifies options using one or more name-value pair arguments, in addition to any of the input argument combinations from previous syntaxes. For example, you can specify the prefix and file type extension of the file names for the written frames.

Examples

Gather Label Data and Write Associated Signal Frames

Gather label data for a video signal and a lidar point cloud sequence signal from a `groundTruthMultisignal` object. Write the signal frames associated with that label data to disk and visualize the frames.

Add the point cloud sequence folder path to the MATLAB® search path. The video is already on the MATLAB search path.

```
pcSeqDir = fullfile(toolboxdir('driving'),'drivingdata', ...
    'lidarSequence');
addpath(pcSeqDir);
```

Load a `groundTruthMultisignal` object that contains label data for the video and the lidar point cloud sequence.

```
data = load('MultisignalGTruth.mat');
gTruth = data.gTruth;
```

Specify the signals from which to gather label data.

```
signalNames = ["video_01_city_c2s_fcw_10s" "lidarSequence"];
```

The video contains rectangle labels, whereas the lidar point cloud sequence contains cuboid labels. Gather the rectangle labels from the video and the cuboid labels from the lidar point cloud sequence.

```
labelTypes = [labelType.Rectangle labelType.Cuboid];
[labelData,timestamps] = gatherLabelData(gTruth,signalNames,labelTypes);
```

Display the first eight rows of label data from the two signals. Both signals contain data for the Car label. In the video, the Car label is drawn as a rectangle bounding box. In the lidar point cloud sequence, the Car label is drawn as a cuboid bounding box.

```
videoLabelSample = head(labelData{1})
lidarLabelSample = head(labelData{2})
```

```
videoLabelSample =
```

```
table
      Car
-----
{{299 213 42 33}}
```

```
lidarLabelSample =
```

```
table
      Car
-----
{{17.7444 6.7386 3.3291 3.6109 3.2214 3.5583 0 0 0}}
```

Write signal frames associated with the gathered label data to temporary folder locations, with one folder per signal. Use the timestamps returned by the `gatherLabelData` function to indicate which signal frames to write.

```
outputFolder = fullfile(tempdir,["videoFrames" "lidarFrames"]);
fileNames = writeFrames(gTruth,signalNames,outputFolder,timestamps);
```

Writing 2 frames from the following signals:

```
* video_01_city_c2s_fcw_10s
* lidarSequence
```

Load the written video signal frames by using an `imageDatastore` object. Load the associated rectangle label data by using a `boxLabelDatastore` object.

```
imds = imageDatastore(fileNames{1});
blds = boxLabelDatastore(labelData{1});
```

Load the written lidar signal frames by using a `fileDatastore` object. Load the associated cuboid label data by using a `boxLabelDatastore` object.

```
fds = fileDatastore(fileNames{2}, 'ReadFcn', @pcread);  
clds = boxLabelDatastore(labelData{2});
```

Visualize the written video frames by using a `vision.VideoPlayer` object. Visualize the written lidar frames by using a `pcplayer` object.

```
videoPlayer = vision.VideoPlayer;
```

```
ptCloud = preview(fds);  
ptCloudPlayer = pcplayer(ptCloud.XLimits, ptCloud.YLimits, ptCloud.ZLimits);
```

```
while hasdata(imds)  
    % Read video and lidar frames.  
    I = read(imds);  
    ptCloud = read(fds);  
  
    % Visualize video and lidar frames.  
    videoPlayer(I);  
    view(ptCloudPlayer, ptCloud);  
end
```

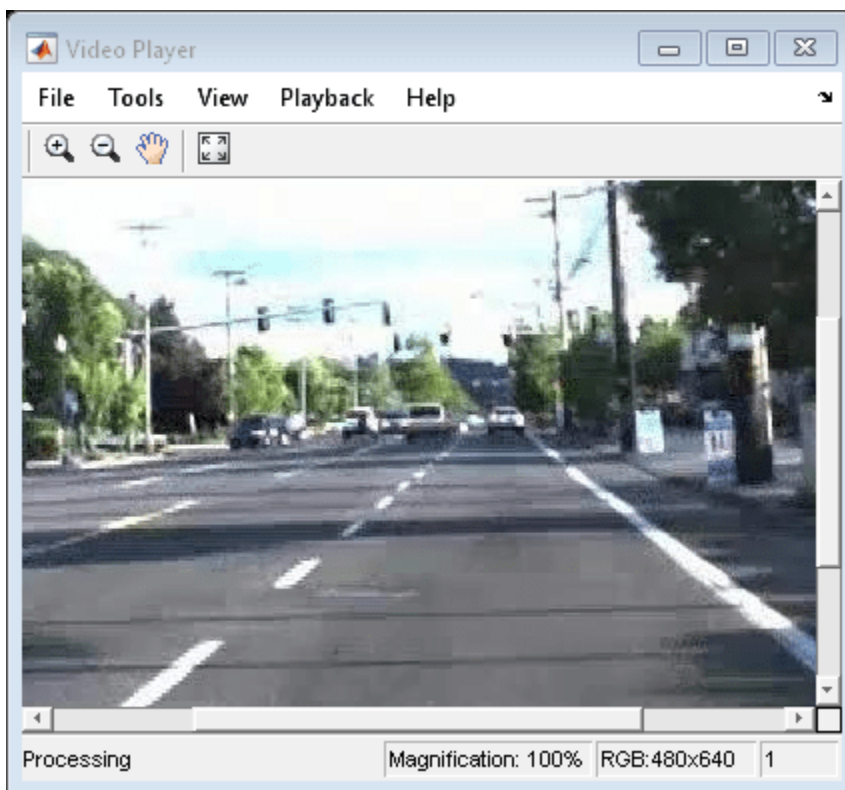

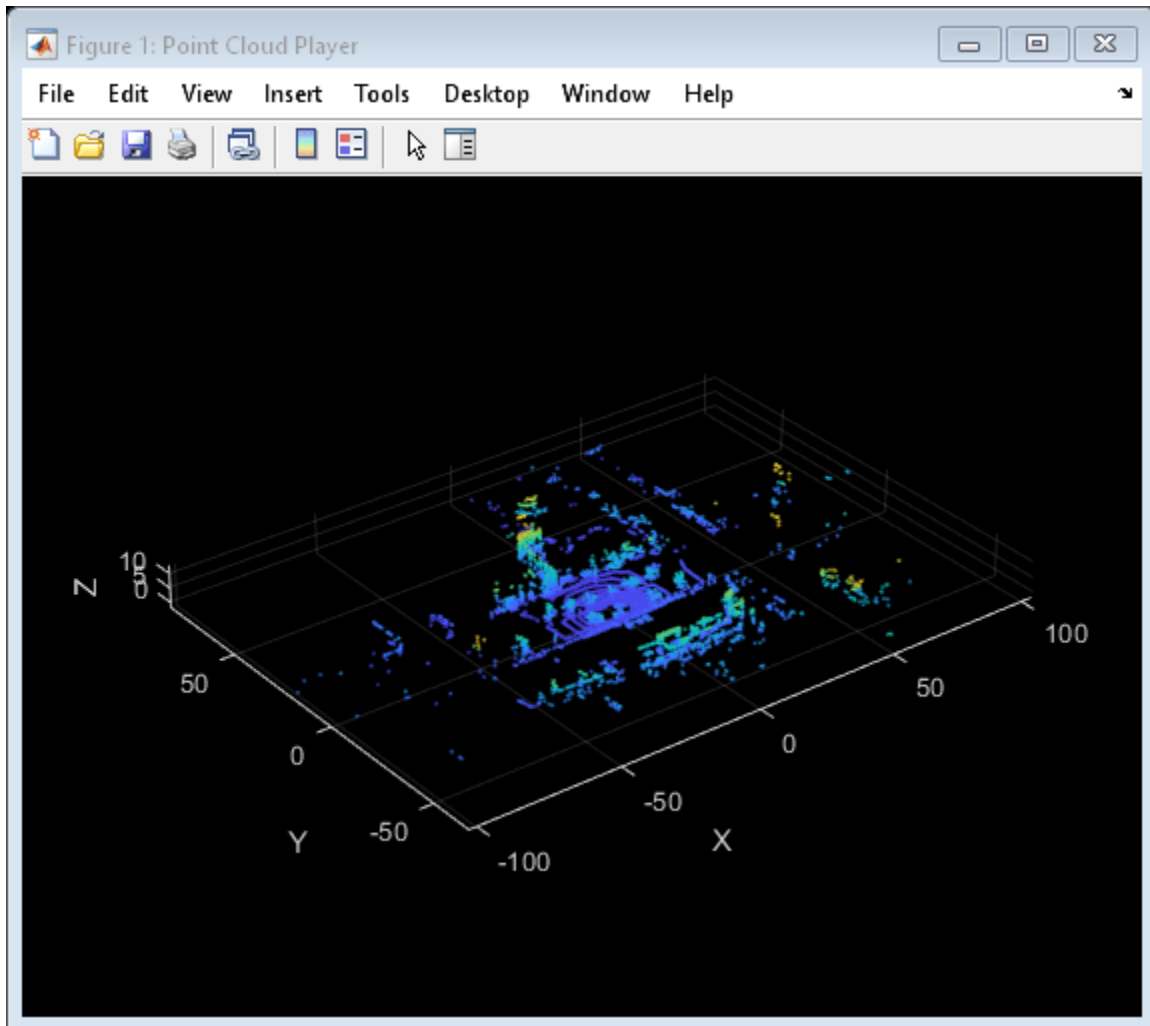

Remove the path to the point cloud sequence folder.

```
rmpath(pcSeqDir);
```

Input Arguments

gTruth — Multisignal ground truth data

groundTruthMultisignal object | vector of groundTruthMultisignal objects

Multisignal ground truth data, specified as a groundTruthMultisignal object or vector of groundTruthMultisignal objects.

signalNames — Names of signals

character vector | cell array of character vectors | string scalar | string vector

Names of the signals for which to write frames, specified as a character vector, string scalar, cell array of character vectors, or string vector. The signal names must be valid signal names stored in the input multisignal ground truth data, gTruth.

To obtain the signal names from a `groundTruthMultisignal` object, use this syntax, where `gTruth` is the variable name of the object:

```
gTruth.DataSource.SignalName
```

```
Example: 'video_01_city_c2s_fcw_10s'
```

```
Example: "video_01_city_c2s_fcw_10s"
```

```
Example: {'video_01_city_c2s_fcw_10s', 'lidarSequence'}
```

```
Example: ["video_01_city_c2s_fcw_10s" "lidarSequence"]
```

location — Folder locations

matrix of strings | cell array of character vectors

Folder locations to which to write frames, specified as an M-by-N matrix of strings or an M-by-N cell array of character vectors, where:

- M is the number of `groundTruthMultisignal` objects in `gTruth`.
- N is the number of signals in `signalNames`.
- `location(m,n)` (for matrix inputs) or `location{m,n}` (for cell array inputs) contains the frame-writing folder location for the nth signal of `signalNames` that is in the mth `groundTruthMultisignal` object of `gTruth`.

You can specify folder locations as relative paths or full file paths. If any specified folder locations do not exist, the `writeFrames` function creates the folders. All folder locations must be unique. If files already exist in a specified folder location, and the existing files are writeable, then the `writeFrames` function overwrites them.

timestamps — Timestamps of frames to write

duration vector | cell array of duration vectors

Timestamps of the frames to write, specified as a duration vector or an M-by-N cell array of duration vectors, where:

- M is the number of `groundTruthMultisignal` objects in `gTruth`.
- N is the number of signals in `signalNames`.
- `timestamps{m,n}` contains the timestamps for the nth signal of `signalNames` that is in the mth `groundTruthMultisignal` object of `gTruth`.

If you are writing frames for only one signal and one `groundTruthMultisignal` object, specify `timestamps` as a single duration vector.

By default, the `writeFrames` function writes all signal frames. When a signal does not have a frame at the specified timestamps, the function writes the frame with the nearest preceding timestamp.

Name-Value Pair Arguments

Specify optional pairs of arguments as `Name1=Value1, ..., NameN=ValueN`, where `Name` is the argument name and `Value` is the corresponding value. Name-value arguments must appear after other arguments, but the order of the pairs does not matter.

Before R2021a, use commas to separate each name and value, and enclose Name in quotes.

Example: 'NamePrefix', ["video" "lidar"], 'FileType', ["png" "ply"] writes video frames with file names of the format video_001.png, video_002.png, and so on, and writes lidar frames with file names of the format lidar_001.ply, lidar_002.ply, and so on.

NamePrefix — File name prefix for each signal

character vector | string scalar | cell array of character vectors | string vector

File name prefix for each signal in `signalNames`, specified as the comma-separated pair consisting of 'NamePrefix' and a character vector, string scalar, cell array of character vectors, or string vector.

Each element of 'NamePrefix' specifies the file type for the signal in the corresponding position of `signalNames`. By default, 'NamePrefix' is the name of each signal in `signalNames`.

FileType — File type for each signal

"jpg" for Image signals, "pcd" for PointCloud signals (default) | character vector | string scalar | cell array of character vectors | string vector

File type for each signal in `signalNames`, specified as the comma-separated pair consisting of 'FileType' and a character vector, string scalar, cell array of character vectors, or string vector.

Each element of 'FileType' specifies the file type for the signal in the corresponding position of `signalNames`. Use this name-value pair argument to specify the file extensions in the names of the written files.

The supported file types for a signal depend on whether that signal is of type Image or PointCloud.

Signal Type	Supported File Types
Image	All file types supported by the <code>imwrite</code> function
PointCloud	"pcd" or "ply" Point cloud data (PCD) and polygon (PLY) files are written using binary encoding. For more details on these file formats, see the <code>pcwrite</code> function.

To view the signal types for signals stored in a `groundTruthMultisignal` object, `gTruth`, use this code:

```
gTruth.DataSource.SignalType
```

```
Example: 'FileType', 'png'
```

```
Example: 'FileType', "png"
```

```
Example: 'FileType', {'png', 'ply'}
```

```
Example: 'FileType', ["png" "ply"]
```

Verbose — Display writing progress information

true or 1 (default) | false or 0

Display writing progress information at the MATLAB command line, specified as the comma-separated pair consisting of 'Verbose' and logical 1 (true) or 0 (false).

Output Arguments

fileNames — File names of written frames

cell array of string column vectors

File names of the written frames, returned as an M-by-N cell array of string vectors, where:

- M is the number of `groundTruthMultisignal` objects in `gTruth`.
- N is the number of signals in `signalNames`.
- `fileNames{m,n}` contains the file names for the frames of the *n*th signal of `signalNames` that is in the *m*th `groundTruthMultisignal` object of `gTruth`.

The file names for each signal are returned in a string column vector, where each row contains the file name for a written frame. If you specified the input `timestamps`, then each file name represents a written frame at the timestamp in the corresponding position of `timestamps`.

Each output file is named *NamePrefix_UID.FileType*, where:

- *NamePrefix* is the file name prefix. To set the file name prefix, use the 'NamePrefix' name-value pair argument.
- *UID* is the unique integer index for each written frame. The `writeFrames` function generates these indices.
- *FileType* is the file type extension. To set the file type extension, use the 'FileType' name-value pair argument.

Version History

Introduced in R2020a

See Also

`groundTruthMultisignal` | `gatherLabelData` | `imformats` | `imwrite` | `pcwrite`

changeFilePaths

Change file paths in multisignal ground truth data

Syntax

```
unresolvedPaths = changeFilePaths(gTruth,alternativePaths)
```

Description

`unresolvedPaths = changeFilePaths(gTruth,alternativePaths)` changes the file paths stored in a `groundTruthMultisignal` object, `gTruth`, based on pairs of current paths and alternative paths, `alternativePaths`. If `gTruth` is a vector of `groundTruthMultisignal` objects, the function changes the file paths across all objects. The function returns the unresolved paths in `unresolvedPaths`. An unresolved path is any current path in `alternativePaths` not found in `gTruth` or any alternative path in `alternativePaths` not found at the specified path location. In both cases, `unresolvedPaths` returns only the current paths.

Use this function to update the file paths of ground truth data that changes folder locations. You can change file paths for the ground truth data sources and pixel label data.

Examples

Change File Paths in Multisignal Ground Truth Data

Change the file paths to the data sources and pixel label data in a `groundTruthMultisignal` object.

Load a `groundTruthMultisignal` object containing ground truth data into the workspace. The data source and pixel label data of the object contain file paths corresponding to an image sequence showing a building. MATLAB® displays a warning that the path to the data source cannot be found.

```
load('gTruthMultiOldPaths.mat')
```

```
Warning: The data source for the following source names could not be loaded. Update the data source
'C:\Sources\building'
```

Display the current path to the data source.

```
gTruth.DataSource
```

```
ans =
```

```
ImageSequenceSource with properties:
```

```
    Name: "Image Sequence"
  Description: "An image sequence reader"
    SourceName: "C:\Sources\building"
  SourceParams: [1x1 struct]
    SignalName: "building"
    SignalType: Image
    Timestamp: {[5x1 duration]}
```

```
NumSignals: 1
```

Specify the current path to the data source and an alternative path and store these paths in a cell array. Use the `changeFilePaths` function to update the data source path based on the paths in the cell array. Because the function does not find the pixel label data at the specified new path, it returns the current unresolved paths.

```
currentPathDataSource = "C:\Sources\building";
newPathDataSource = fullfile(matlabroot,"toolbox\vision\visiondata\building");
alternativePaths = {[currentPathDataSource newPathDataSource]};
unresolvedPaths = changeFilePaths(gTruth,alternativePaths)

unresolvedPaths = 5x1 string
    "C:\Pixels\Label_1.png"
    "C:\Pixels\Label_2.png"
    "C:\Pixels\Label_3.png"
    "C:\Pixels\Label_4.png"
    "C:\Pixels\Label_5.png"
```

Verify that the paths in the `groundTruthMultisignal` object match the unresolved paths returned by the `changeFilePaths` function. The unresolved paths are stored in the `ROILabelData` property of the `groundTruthMultisignal` object, in the `PixelLabelData` column of the table for the building image sequence signal.

```
gTruth.ROILabelData.building.PixelLabelData
```

```
ans = 5x1 cell
    {'C:\Pixels\Label_1.png'}
    {'C:\Pixels\Label_2.png'}
    {'C:\Pixels\Label_3.png'}
    {'C:\Pixels\Label_4.png'}
    {'C:\Pixels\Label_5.png'}
```

Specify the current path and an alternative path for the pixel label files and change the file paths. The function updates the paths for all pixel labels. Because the function resolves all paths, it returns an empty array of unresolved paths.

```
currentPathPixels = "C:\Pixels";
newPathPixels = fullfile(matlabroot,"toolbox\vision\visiondata\buildingPixelLabels");
alternativePaths = {[currentPathPixels newPathPixels]};
unresolvedPaths = changeFilePaths(gTruth,alternativePaths)

unresolvedPaths =

    0x0 empty string array
```

To view the new data source path, use the `gTruth.DataSource` command. To view the new pixel label data paths, use the `gTruth.ROILabelData.building.PixelLabelData` command.

Input Arguments

gTruth — Multisignal ground truth data

groundTruthMultisignal object | vector of groundTruthMultisignal objects

Multisignal ground truth data, specified as a `groundTruthMultisignal` object or vector of `groundTruthMultisignal` objects.

alternativePaths — Alternative file paths

1-by-2 string vector | cell array of 1-by-2 string vectors

Alternative file paths, specified as a 1-by-2 string vector or cell array of 1-by-2 string vectors of the form $[p_{\text{current}} p_{\text{new}}]$.

- p_{current} is a current file path in `gTruth`. This file path can be from the data source or pixel label data of `gTruth`. Specify p_{current} using backslashes as the path separators.
- p_{new} is the new path to which you want to change p_{current} . Specify p_{new} using either forward slashes or backslashes as the path separators.

You can specify alternatives paths to these files.

- Signal data sources — The `DataSource` property of `gTruth` contains one `MultiSignalSource` object per signal. The `changeFilePaths` function updates the signal paths stored in these objects.
- Pixel label data — The `ROILabelData` property of `gTruth` contains an `ROILabelData` object, which contains a table of ROI label data for each signal. For signals with pixel label data, which is stored in the `PixelLabelData` column of the table for that signal, the function updates the paths to the pixel label data.

If `gTruth` is a vector of `groundTruthMultisignal` objects, the function changes the file paths across all objects.

Example: `["C:\Pixels\PixelLabelData_1" "C:\Pixels\PixelLabelData_2"]` changes the path to the pixel label data folder. The function updates the path in all pixel label files stored in that folder.

Example: `{"B:\Sources\video1.mp4" "C:\Sources\video1.mp4"}; ["B:\Sources\video2.mp4" "C:\Sources\video2.mp4"]` changes the drive letter in the paths to the data sources.

Output Arguments

unresolvedPaths — Unresolved file paths

string array

Unresolved file paths, returned as a string array. If the `changeFilePaths` function cannot find either the current path or new path in the string vectors specified by the `alternativePaths` input, then it returns the unresolved current paths in `unresolvedPaths`.

If the function finds and resolves all file paths, then it returns `unresolvedPaths` as an empty string array.

Version History

Introduced in R2020a

See Also

`groundTruthMultisignal`

Topics

“Share and Store Labeled Ground Truth Data”

“How Labeler Apps Store Exported Pixel Labels”

geoplayer

Visualize streaming geographic map data

Description

A `geoplayer` object is a geographic player that displays the streaming coordinates of a driving route on a map.

- To display the driving route of a vehicle, use the `plotRoute` function.
- To display the position of a vehicle as it drives along a route, use the `plotPosition` function. You can plot the position of multiple vehicles on different routes simultaneously by specifying a unique track ID for each route. For more information, see the 'TrackID' name-value pair argument on `plotPosition`.
- To change the underlying map, or basemap, of the `geoplayer` object, update the `Basemap` property of the object. For more information, see “Custom Basemaps” on page 4-944.

Creation

Syntax

```
player = geoplayer(latCenter,lonCenter)
player = geoplayer(latCenter,lonCenter,zoomLevel)
player = geoplayer( ___,Name,Value)
```

Description

`player = geoplayer(latCenter,lonCenter)` creates a geographic player, centered at latitude coordinate `latCenter` and longitude coordinate `lonCenter`.

`player = geoplayer(latCenter,lonCenter,zoomLevel)` creates a geographic player with a map magnification specified by `zoomLevel`.

`player = geoplayer(___,Name,Value)` sets properties on page 4-926 using one or more name-value pairs, in addition to specifying input arguments from previous syntaxes. For example, `geoplayer(45,0,'HistoryDepth',5)` creates a geographic player centered at the latitude-longitude coordinate (45, 0), and sets the `HistoryDepth` property such that the player displays the five previous geographic coordinates.

Input Arguments

latCenter — Latitude coordinate

real scalar in the range (-90, 90)

Latitude coordinate at which the geographic player is centered, specified as a real scalar in the range (-90, 90).

Data Types: `single` | `double`

LonCenter — Longitude coordinate

real scalar in the range [-180, 180]

Longitude coordinate at which the geographic player is centered, specified as a real scalar in the range [-180, 180].

Data Types: `single` | `double`

zoomLevel — Magnification

15 | integer in the range [0, 25]

Magnification of the geographic player, specified as an integer in the range [0, 25]. This magnification occurs on a logarithmic scale with base 2. Increasing `zoomLevel` by one doubles the map scale.

Properties**HistoryDepth — Number of previous geographic coordinates to display**

0 (default) | nonnegative integer | `Inf`

Number of previous geographic coordinates to display, specified as a nonnegative integer or `Inf`. A value of 0 displays only the current geographic coordinates. A value of `Inf` displays all geographic coordinates previously plotted using the `plotPosition` function.

You can set this property only when you create the object. After you create the object, this property is read-only.

HistoryStyle — Style of displayed geographic coordinates

'point' (default) | 'line'

Style of displayed geographic coordinates, specified as one of these values:

- 'point' — Display the coordinates as discrete, unconnected points.
- 'line' — Display the coordinates as a single connected line.



You can set this property when you create the object. After you create the object, this property is read-only.

Basemap — Map on which to plot data

'streets' (default) | 'streets-light' | 'streets-dark' | 'satellite' | 'topographic' | ...

Map on which to plot data, specified as one of the basemap names in this table, 'none', or a custom basemap defined using the `addCustomBasemap` function. For more information on adding custom basemaps, see “Custom Basemaps” on page 4-944. For examples on how to add custom basemaps, see “Display Data on OpenStreetMap Basemap” on page 4-931 and “Display Data on HERE Basemap” on page 3-7.

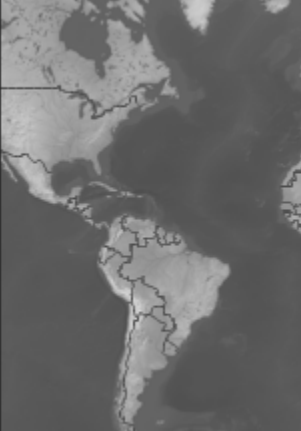
 <p>A standard street map of Cape Town, South Africa, showing major roads like the N2 and N1, and landmarks like Table Mountain and Sybrand Park. The map uses a light, natural color palette.</p>	<p>'streets' (default)</p> <p>Street map data composed of geographic map tiles using the World Street Map provided by Esri. For more information about the map, see World Street Map on the Esri ArcGIS website.</p> <p>Hosted by Esri.</p> <p>Esri, HERE, Garmin, NGA, USGS</p>	 <p>A street map of Cape Town where the streets are rendered in white lines on a light gray background, providing a clean, minimalist view of the road network.</p>	<p>'streets-light'</p> <p>Map designed to provide geographic context while highlighting user data on a light background.</p> <p>Hosted by Esri.</p> <p>Esri South Africa, HERE, Garmin, NGA, USGS</p>
 <p>A street map of Cape Town where the streets are rendered in white lines on a dark gray background, designed for high contrast and visibility in low light.</p>	<p>'streets-dark'</p> <p>Map designed to provide geographic context while highlighting user data on a dark background.</p> <p>Hosted by Esri.</p> <p>Esri, HERE, Garmin, NGA, USGS</p>	 <p>A high-resolution satellite image of Cape Town, showing the city's layout, buildings, and surrounding terrain in natural colors.</p>	<p>'satellite'</p> <p>Full global basemap composed of high-resolution satellite imagery.</p> <p>Hosted by Esri.</p> <p>Earthstar Geographics, CNES/Airbus DS</p>
 <p>A topographic map of Cape Town showing contour lines to represent elevation, major roads, and geographical features. The map uses a light, natural color palette.</p>	<p>'topographic'</p> <p>General-purpose map with styling to depict topographic features.</p> <p>Hosted by Esri.</p> <p>Esri South Africa, HERE, Garmin, USGS, NGA</p>	 <p>A landcover map of Cape Town where different land uses are represented by various shades of green, yellow, and blue, showing the distribution of urban, agricultural, and natural areas.</p>	<p>'landcover'</p> <p>Map that combines satellite-derived land cover data, shaded relief, and ocean-bottom relief. The light, natural palette is suitable for thematic and reference maps.</p> <p>Created using Natural Earth.</p>

	<p>'colorterrain'</p> <p>Shaded relief map blended with a land cover palette. Humid lowlands are green and arid lowlands are brown.</p> <p>Created using Natural Earth.</p>		<p>'grayterrain'</p> <p>Terrain map in shades of gray. Shaded relief emphasizes both high mountains and micro-terrain found in lowlands.</p> <p>Created using Natural Earth.</p>
	<p>'bluegreen'</p> <p>Two-tone, land-ocean map with light green land areas and light blue water areas.</p> <p>Created using Natural Earth.</p>		<p>'grayland'</p> <p>Two-tone, land-ocean map with gray land areas and white water areas.</p> <p>Created using Natural Earth.</p>
	<p>'darkwater'</p> <p>Two-tone, land-ocean map with light gray land areas and dark gray water areas. This basemap is installed with MATLAB.</p> <p>Created using Natural Earth.</p>	<p>N/A</p>	<p>'none'</p> <p>Geographic axes plots your data with latitude-longitude grid, ticks, and labels but does not include a map.</p>

By default, access to basemaps requires an Internet connection. The exception is the 'darkwater' basemap, which is installed with MATLAB.

If you do not have consistent access to the Internet, you can download the basemaps created using Natural Earth onto your local system by using the Add-On Explorer. The basemaps hosted by Esri are not available for download. For more information about downloading basemaps, see "Access Basemaps for Geographic Axes and Charts".

The basemaps hosted by Esri update periodically. As a result, you might see differences in your visualizations over time.

Alignment of boundaries and region labels are a presentation of the feature provided by the data vendors and do not imply endorsement by MathWorks®.

Example: `player = geoplayer(latCenter, lonCenter, 'Basemap', 'darkwater')`

Example: `player.Basemap = 'darkwater'`

Data Types: `char` | `string`

CenterOnID — Recenter display based on specified track ID

`[]`(center on first track) (default) | positive integer

Recenter display based on the specified track ID, specified as a positive integer. The `geoplayer` object recenters the map when the new position, specified by `latCenter` and `lonCenter`, moves outside of the current viewable map area. You can also use this property to recenter the map on a previously drawn track that is outside of the viewable area. Define the track ID by using the 'TrackID' name-value pair argument when you call the `plotPosition` object function.

Parent — Parent axes of geographic player

`Figure` graphics object | `Panel` graphics object

Parent axes of the geographic player, specified as a `Figure` graphics object or `Panel` graphics object. If you do not specify `Parent`, then `geoplayer` creates the geographic player in a new figure.

You can set this property when you create the object. After you create the object, this property is read-only.

Axes — Axes used by geographic player

`GeographicAxes` object

This property is read-only.

Axes used by geographic player, specified as a `GeographicAxes` object. Use this axes to customize the map that the geographic player displays. For an example, see “Customize Geographic Axes” on page 4-938. For details on the properties that you can customize, see `GeographicAxes` Properties.

Object Functions

<code>plotPosition</code>	Display current position in geoplayer figure
<code>plotRoute</code>	Display continuous route in geoplayer figure
<code>reset</code>	Remove all existing plots from geoplayer figure
<code>show</code>	Make geoplayer figure visible
<code>hide</code>	Make geoplayer figure invisible
<code>isOpen</code>	Return true if geoplayer figure is visible

Examples

Animate Sequence of Latitude and Longitude Coordinates

Load a sequence of latitude and longitude coordinates.

```
data = load('geoSequence.mat');
```

Create a geographic player and configure it to display all points in its history.

```
zoomLevel = 17;
player = geoplayer(data.latitude(1),data.longitude(1),zoomLevel,'HistoryDepth',Inf);
```

Display the sequence of coordinates.

```
for i = 1:length(data.latitude)
    plotPosition(player,data.latitude(i),data.longitude(i));
    pause(0.01)
end
```

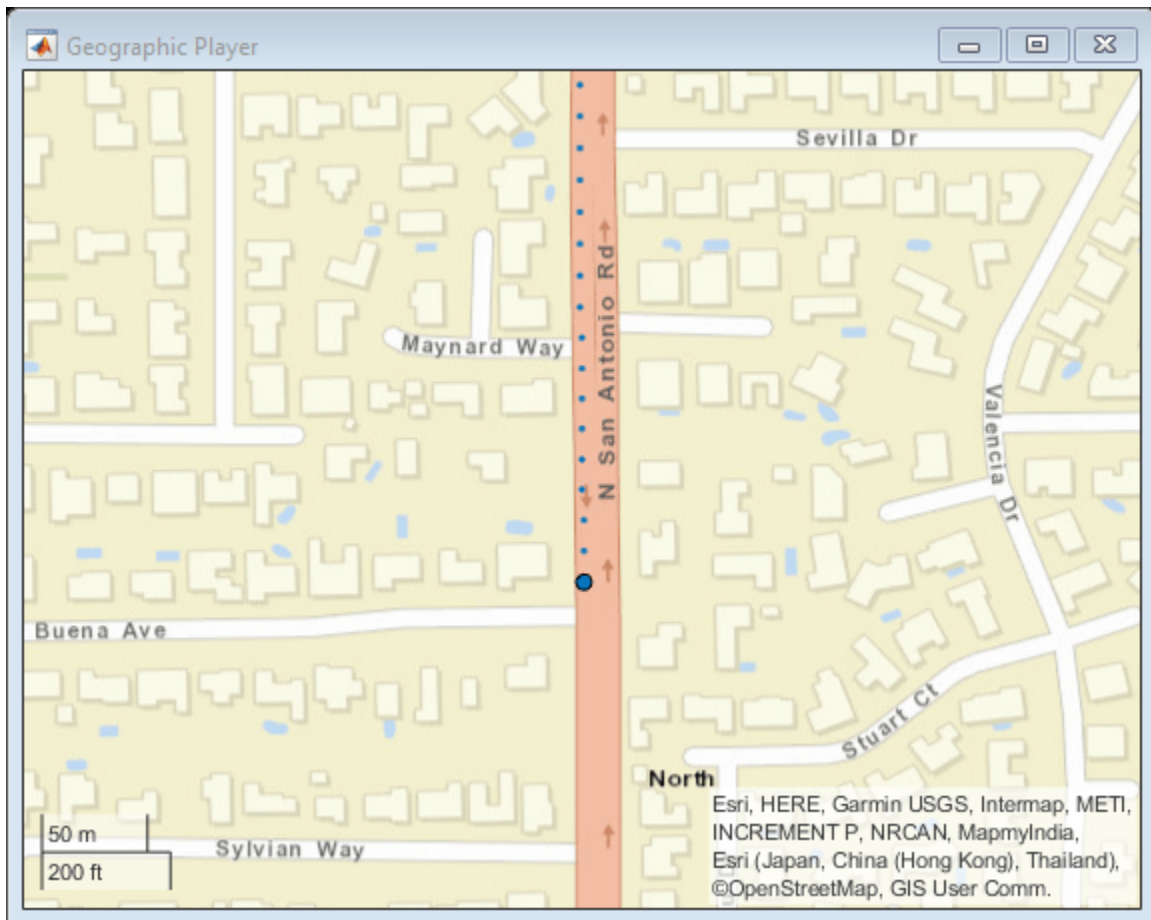

View Position of Vehicle Along Route

Load a sequence of latitude and longitude coordinates.

```
data = load('geoRoute.mat');
```

Create a geographic player and set the zoom level to 12. Compared to the default zoom level, this zoom level zooms the map out by a factor of 8.

```
player = geoplayer(data.latitude(1),data.longitude(1),12);
```

Display the full route.

```
plotRoute(player,data.latitude,data.longitude);
```

Display the coordinates in a sequence. The circle marker indicates the current position.

```
for i = 1:length(data.latitude)
    plotPosition(player,data.latitude(i),data.longitude(i));
    pause(0.05)
end
```

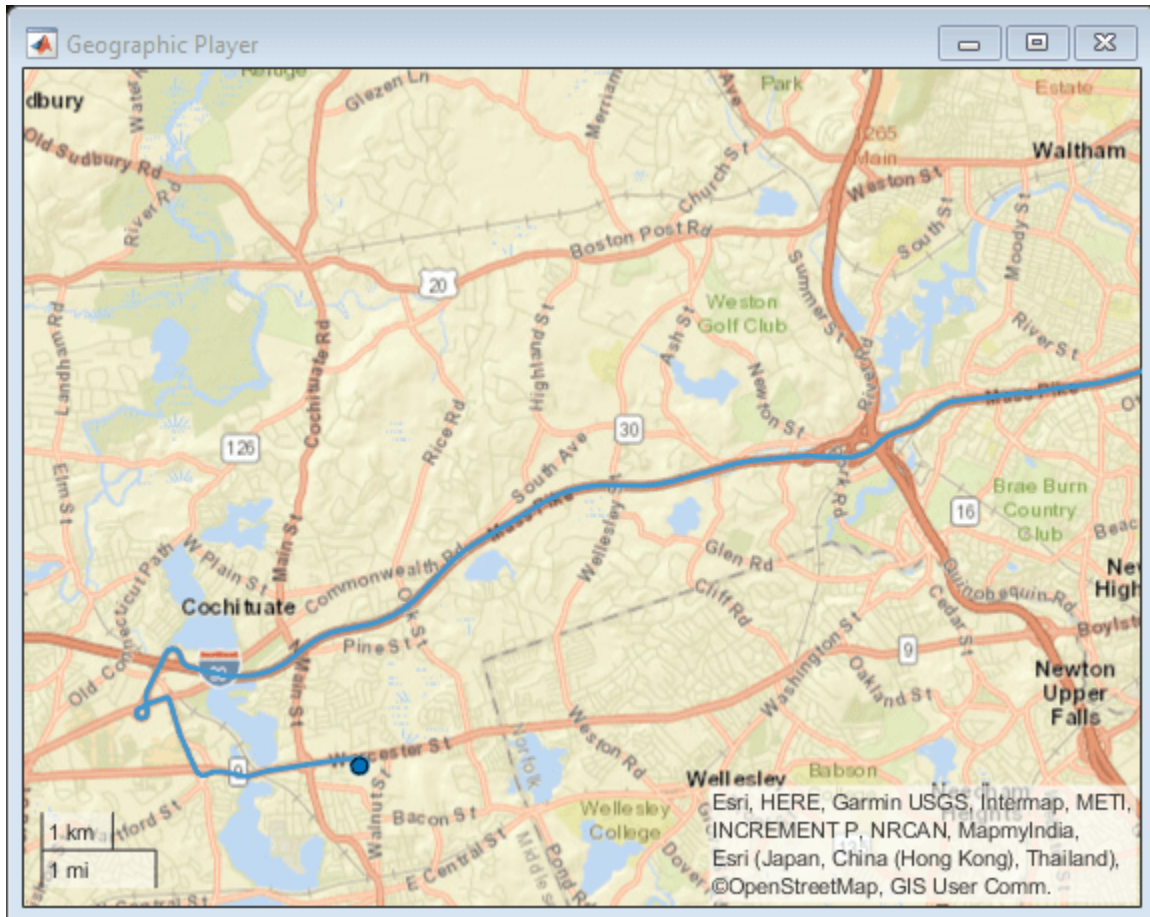

Display Data on OpenStreetMap Basemap

This example shows how to display a driving route and vehicle positions on an OpenStreetMap® basemap.

Add the OpenStreetMap basemap to the list of basemaps available for use with the geoplayer object. After you add the basemap, you do not need to add it again in future sessions.

```
name = 'openstreetmap';
url = 'https://a.tile.openstreetmap.org/{z}/{x}/{y}.png';
copyright = char(uint8(169));
```

```
attribution = copyright + "OpenStreetMap contributors";
addCustomBasemap(name,url,'Attribution',attribution)
```

Load a sequence of latitude and longitude coordinates.

```
data = load('geoRoute.mat');
```

Create a geographic player. Center the geographic player on the first position of the driving route and set the zoom level to 12.

```
zoomLevel = 12;
player = geoplayer(data.latitude(1),data.longitude(1),zoomLevel);
```

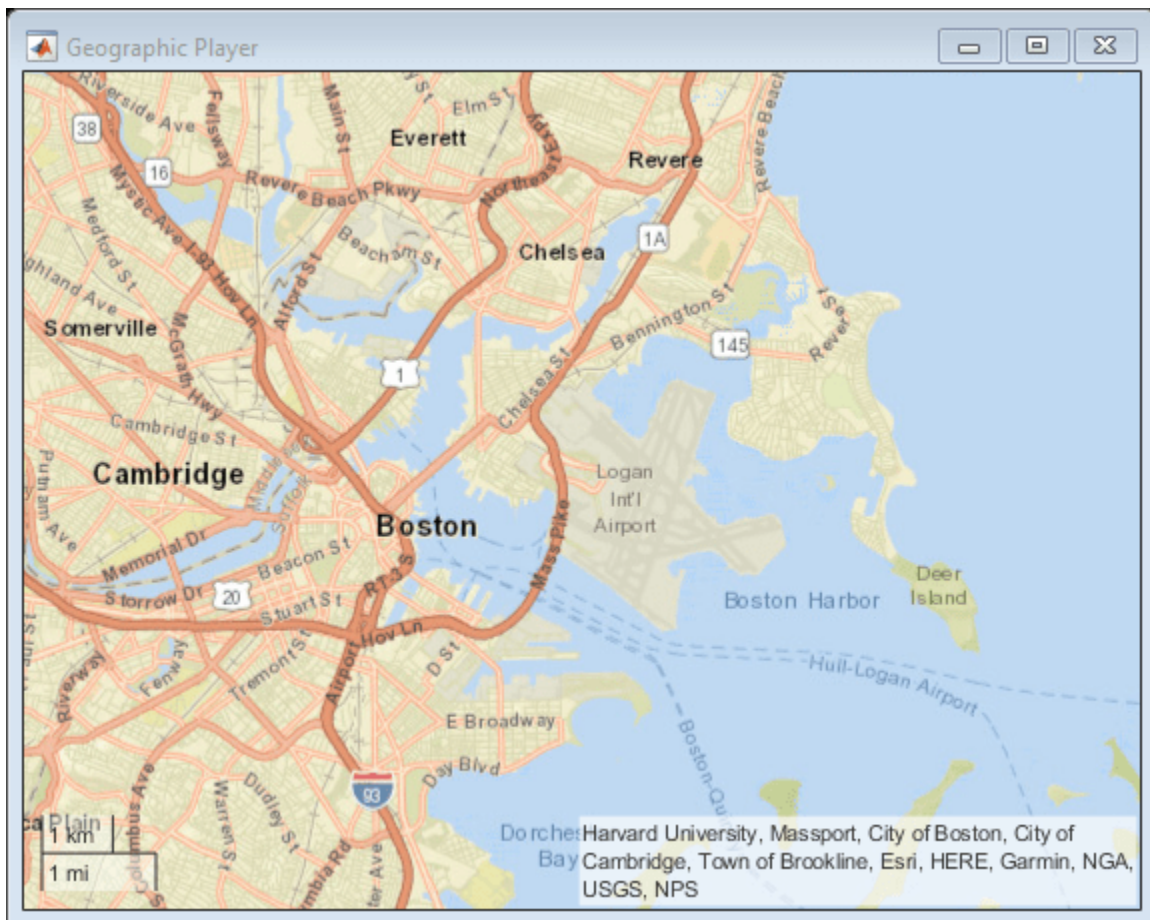

Display the full route.

```
plotRoute(player,data.latitude,data.longitude);
```

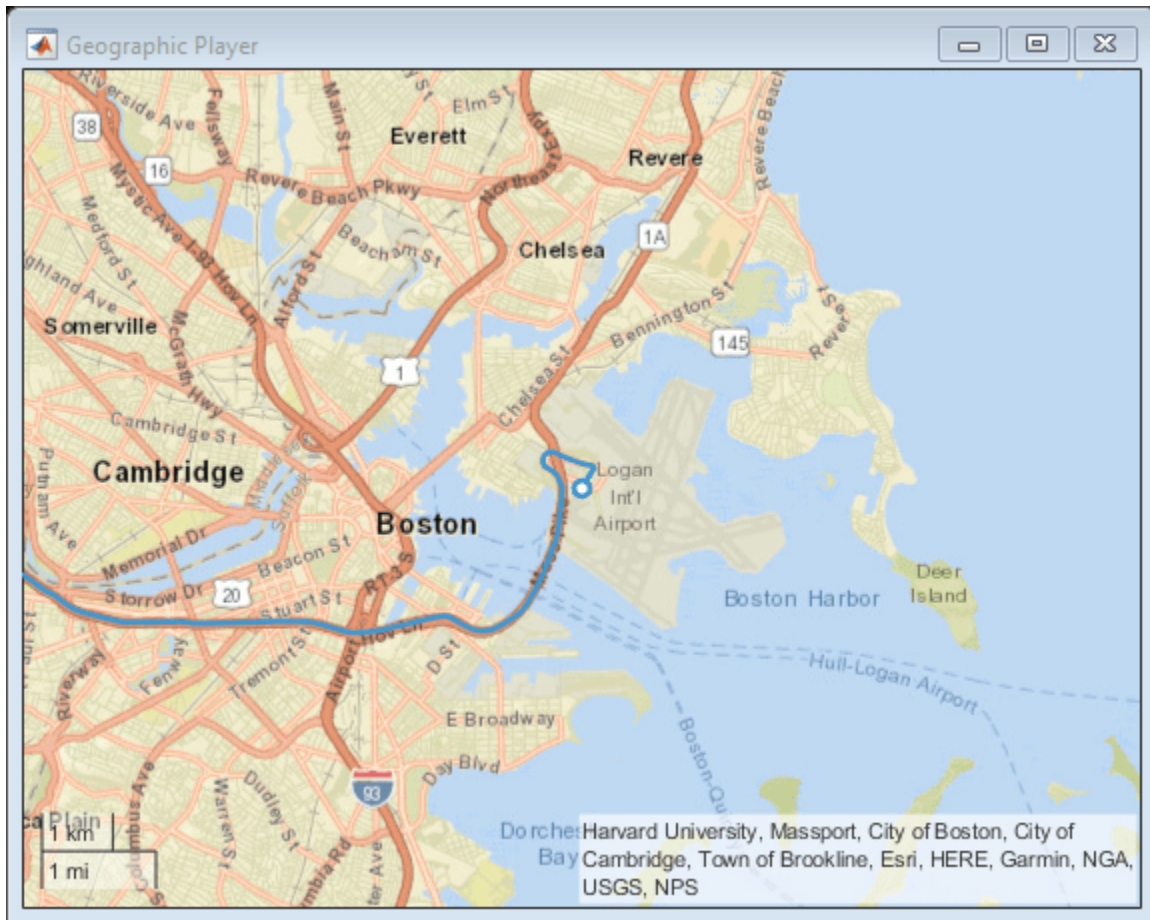

By default, the geographic player uses the World Street Map basemap ('streets') provided by Esri®. Update the geographic player to use the added OpenStreetMap basemap instead.

```
player.Basemap = 'openstreetmap';
```

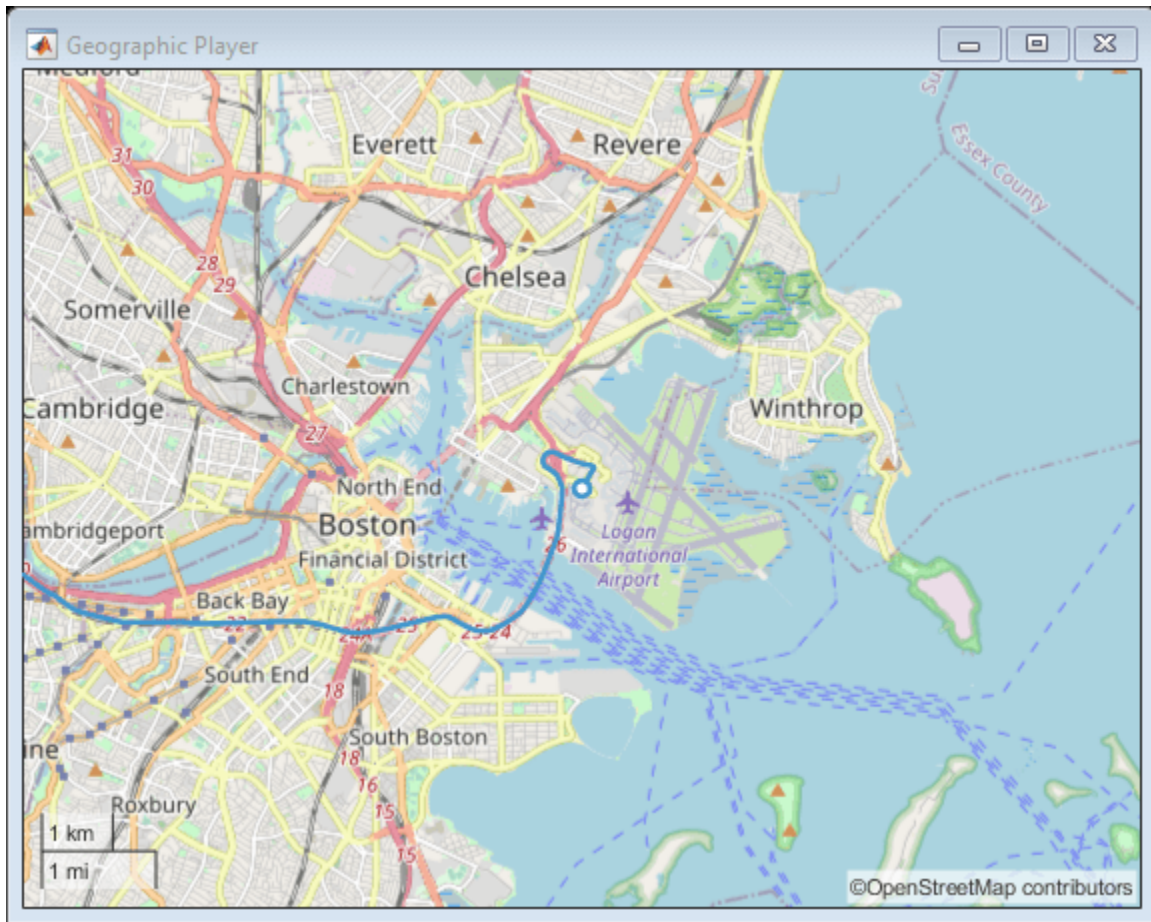
Display the route again.

```
plotRoute(player,data.latitude,data.longitude);
```

Display the positions of the vehicle in a sequence.

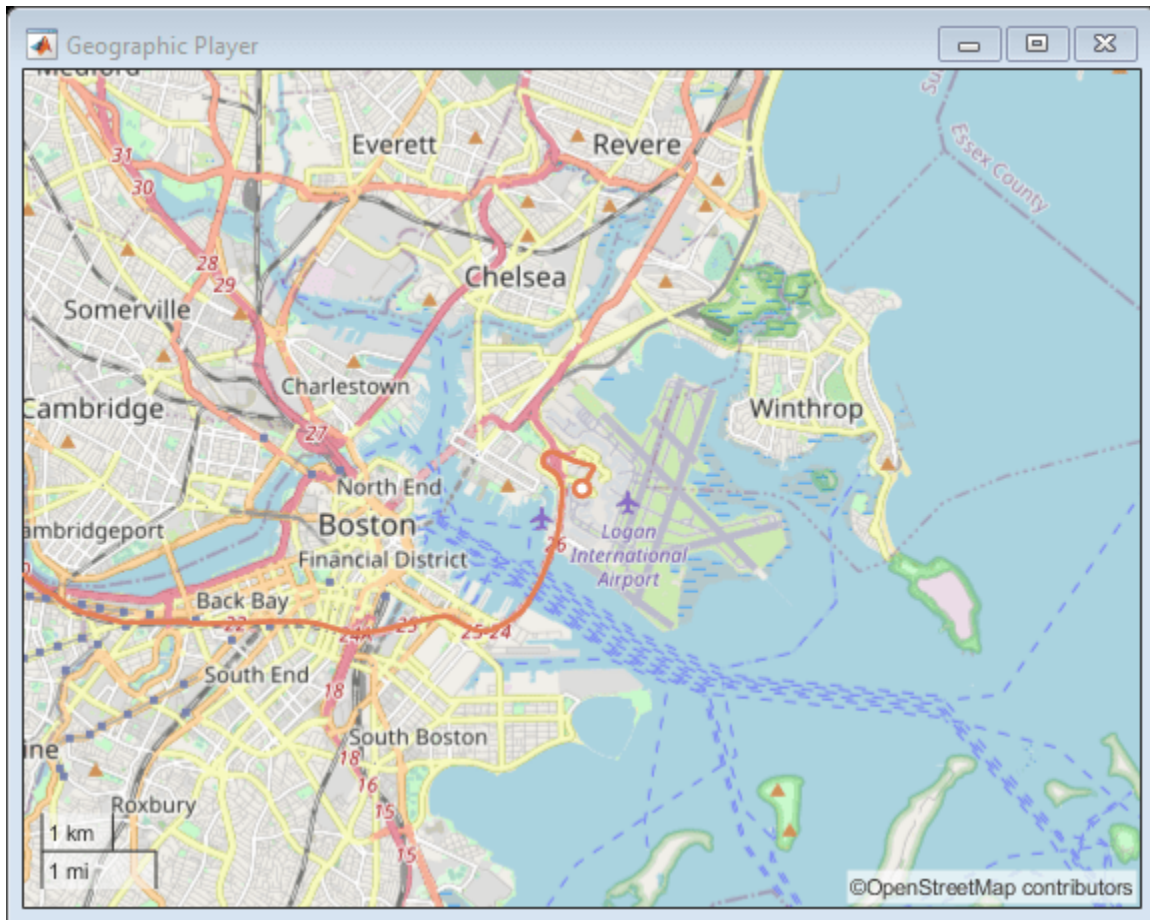
```
for i = 1:length(data.latitude)
    plotPosition(player,data.latitude(i),data.longitude(i))
end
```

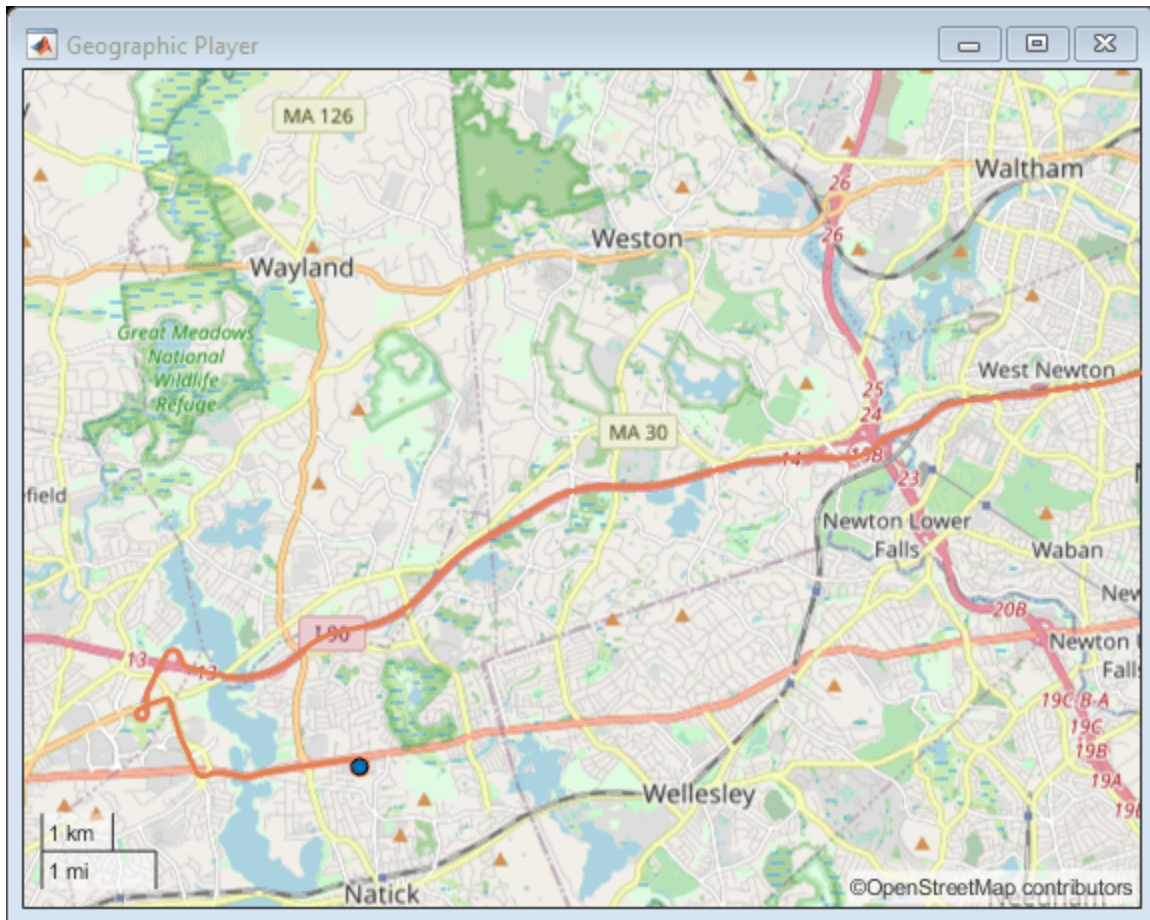

Display Data on HERE Basemap

Display a driving route on a basemap provided by HERE Technologies. To use this example, you must have a valid license from HERE Technologies.

Specify the basemap name and map URL.

```
name = 'herestreets';
url = ['https://1.base.maps.ls.hereapi.com/maptile/2.1/maptile/', ...
      'newest/normal.day/{z}/{x}/{y}/256/png?apikey=%s'];
```

Maps from HERE Technologies require a valid license. Create a dialog box. In the dialog box, enter the Access Key ID corresponding to your HERE license.

```
prompt = {'HERE Access Key ID:'};
title = 'HERE Tokens';
dims = [1 40]; % Text edit field height and width
hereTokens = inputdlg(prompt,title,dims);
```

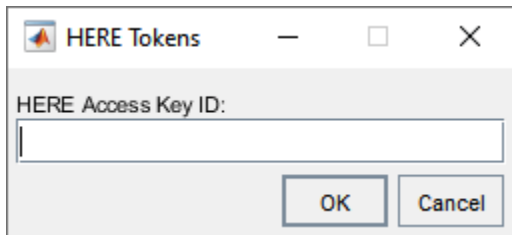

If the license is valid, specify the HERE credentials and a custom attribution, load coordinate data, and display the coordinates on the HERE basemap using a `geoplayer` object. If the license is not valid, display an error message.

```

if ~isempty(hereTokens)

    % Add HERE basemap with custom attribution.
    url = sprintf(url,hereTokens{1});
    copyrightSymbol = char(169); % Alt code
    attribution = [copyrightSymbol, ' ',datestr(now,'yyyy'),' HERE'];
    addCustomBasemap(name,url,'Attribution',attribution);

    % Load sample lat,lon coordinates.
    data = load('geoSequence.mat');

    % Create geoplayer with HERE basemap.
    player = geoplayer(data.latitude(1),data.longitude(1), ...
        'Basemap','herestreets','HistoryDepth',Inf);

    % Display the coordinates in a sequence.
    for i = 1:length(data.latitude)
        plotPosition(player,data.latitude(i),data.longitude(i));
    end

else
    error('You must enter valid credentials to access maps from HERE Technologies');
end

```

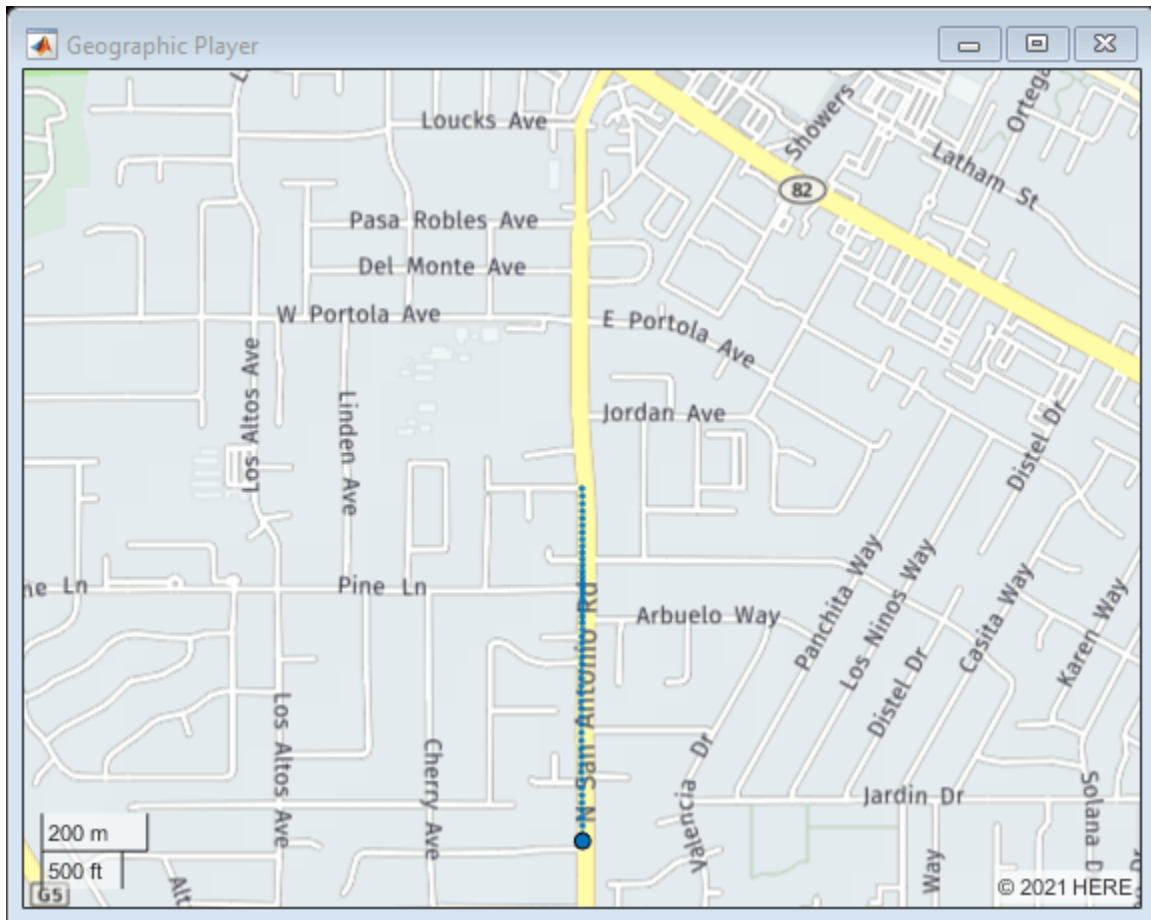

Customize Geographic Axes

Customize the geographic axes of a `geoplayer` object by adding a custom line between route endpoints.

Load a driving route and vehicle positions along that route.

```
data = load('geoRoute.mat');
```

Create a geographic player that is centered on the first position of the vehicle.

```
zoomLevel = 10;
player = geoplayer(data.latitude(1), data.longitude(1), zoomLevel);
```

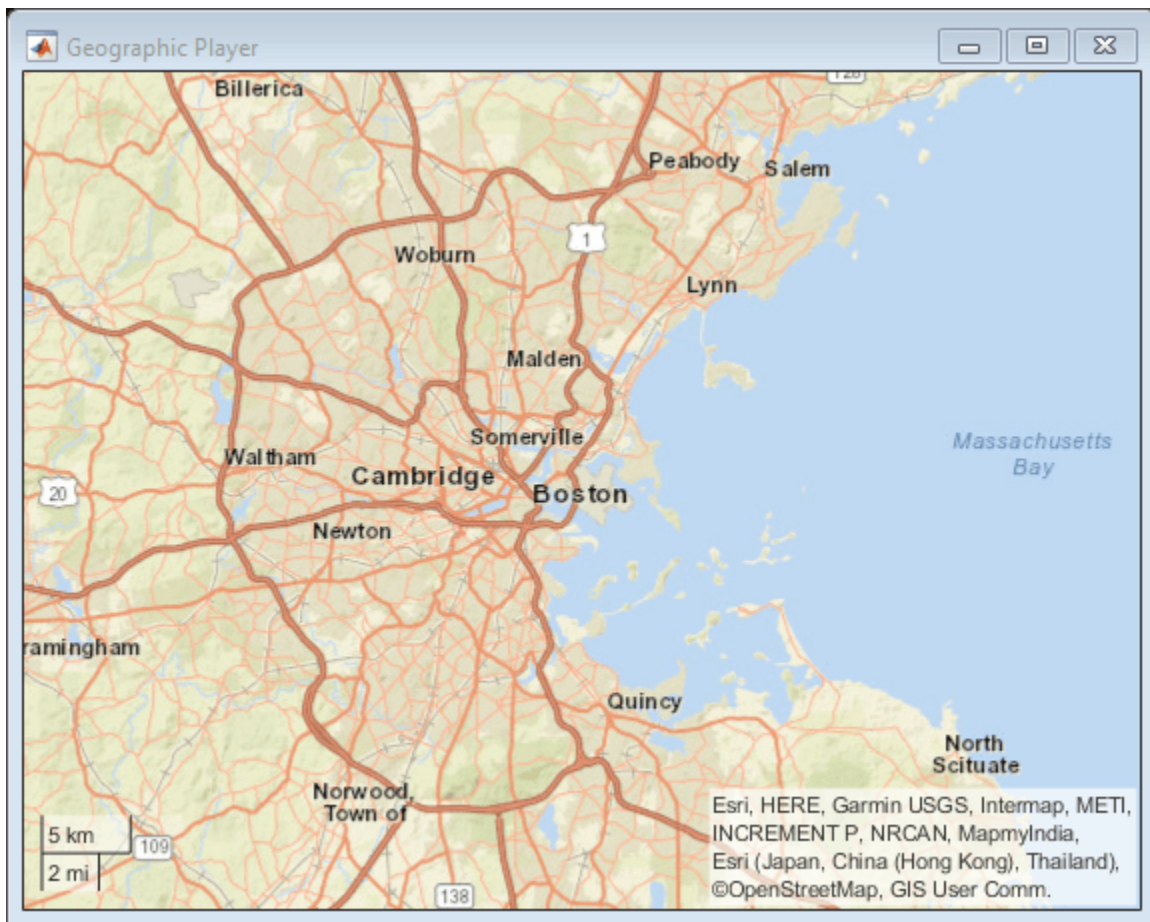
Display the full route.

```
plotRoute(player,data.latitude,data.longitude);
```

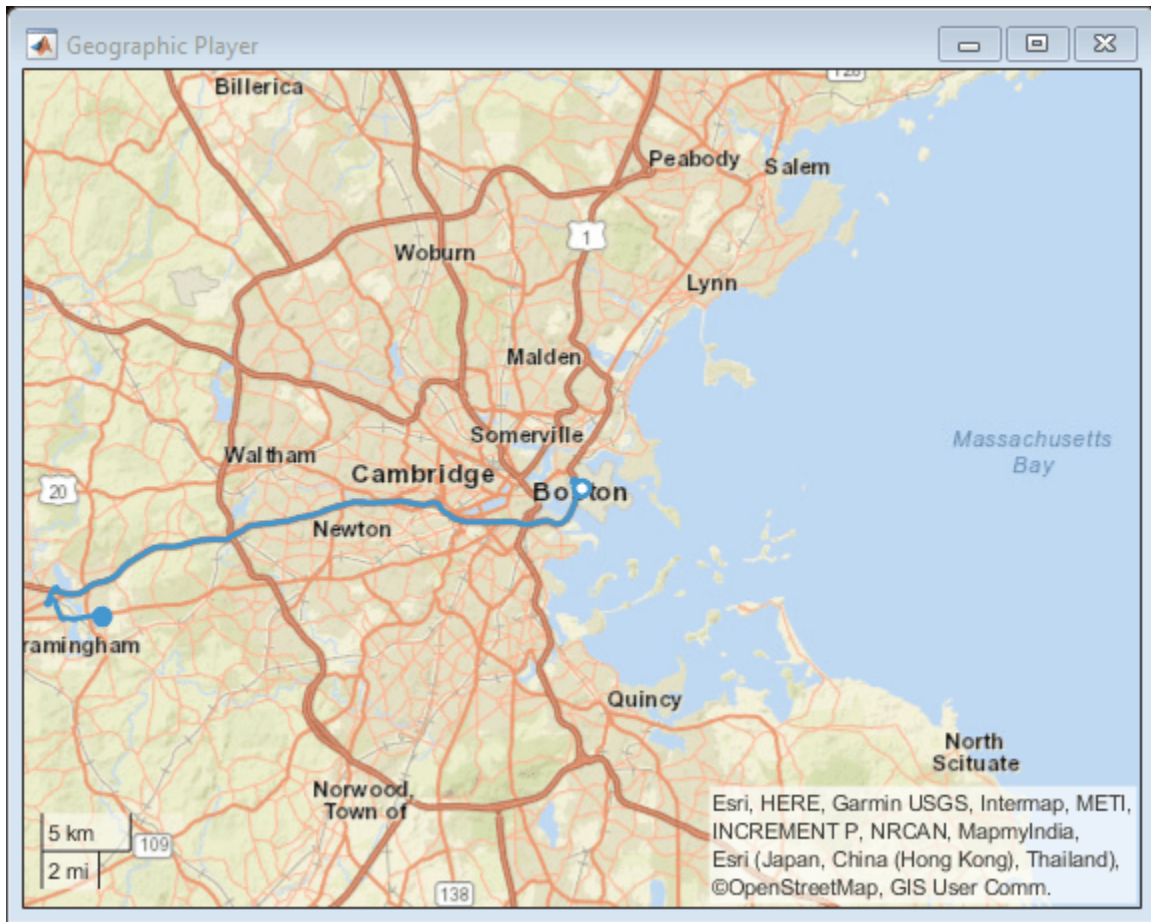

Display positions of the vehicle along the route.

```
for i = 1:length(data.latitude)
    plotPosition(player,data.latitude(i),data.longitude(i))
end
```

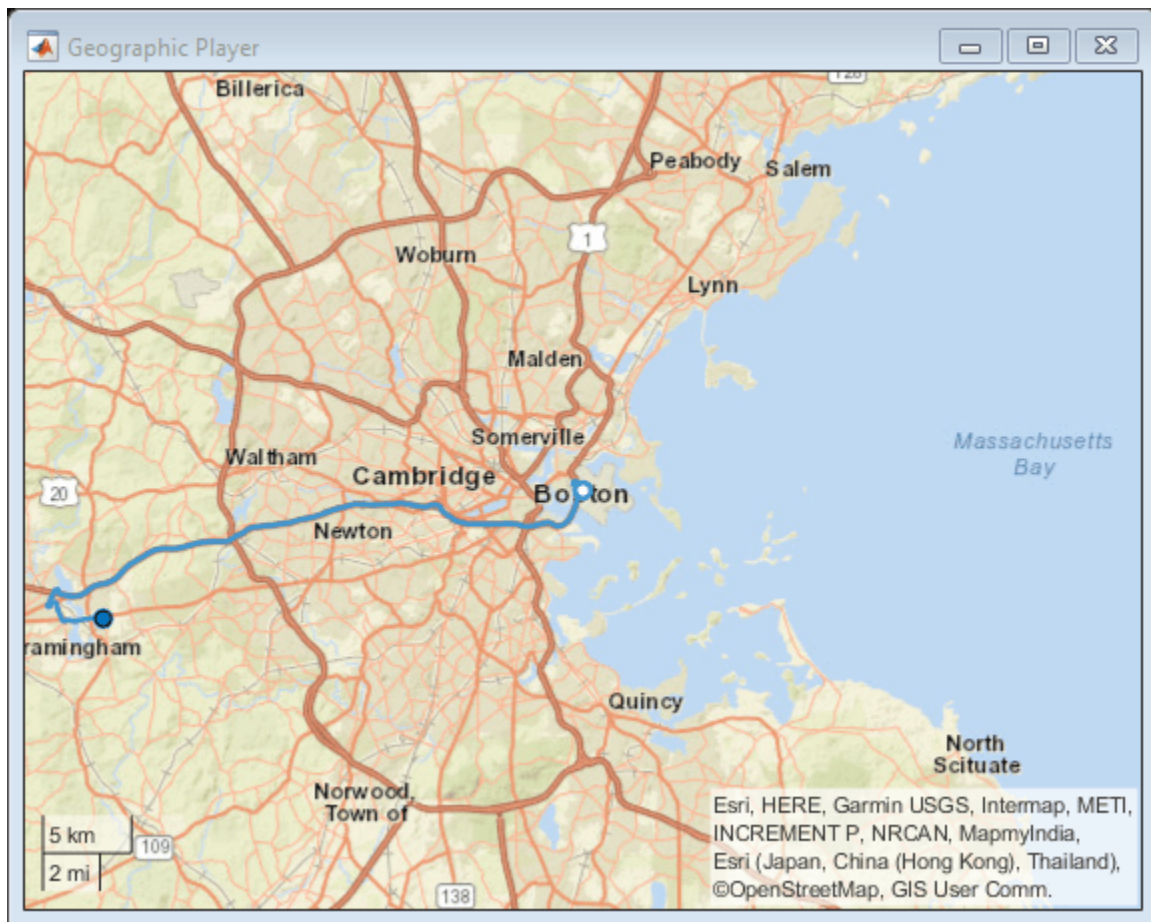

Customize the geographic axes by adding a line between the two endpoints of the route.

```
geoplot(player.Axes,[data.latitude(1) data.latitude(end)], ...  
        [data.longitude(1) data.longitude(end)], 'g-*')
```

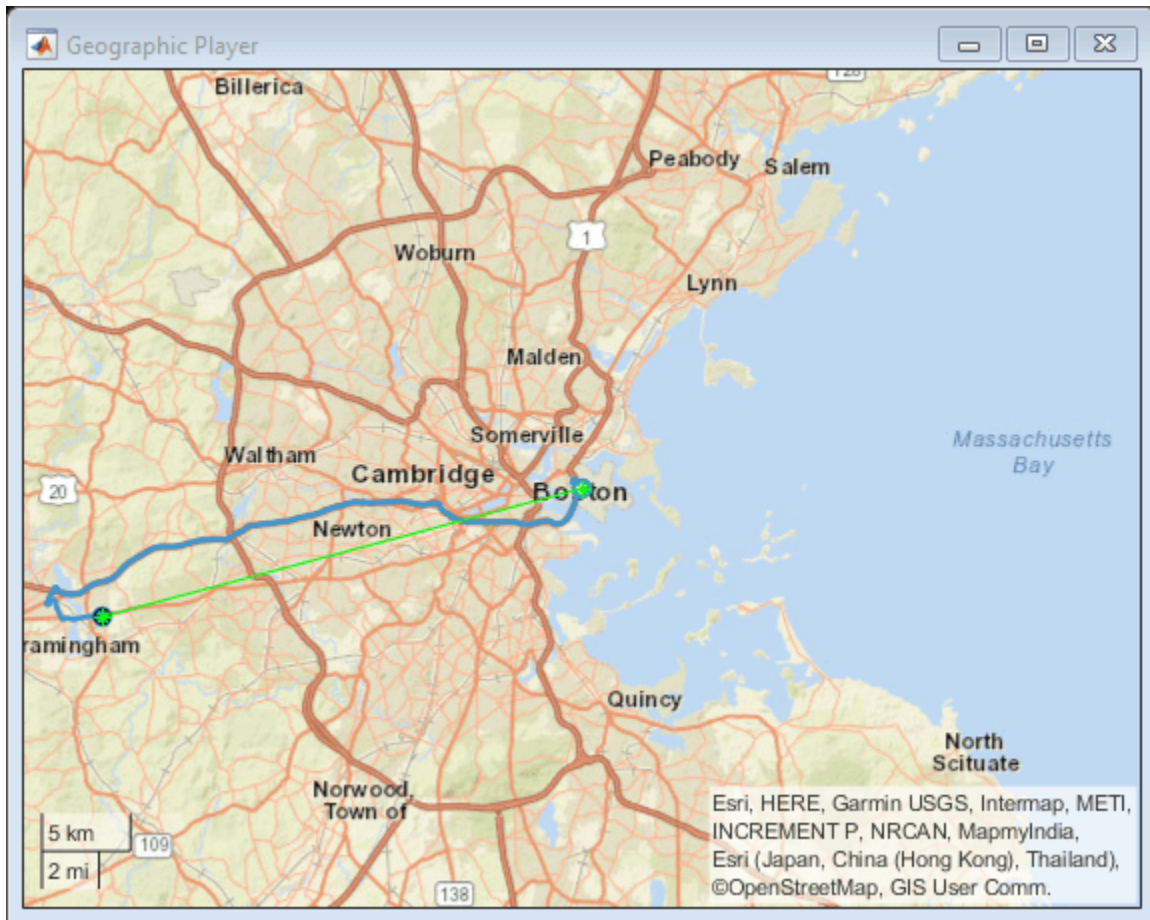
Plot the Tracks of Two Vehicles

Plot multiple routes simultaneously in a geographic player. First, assign each route a unique identifier. Then, when plotting points on the routes using the `plotPosition` object function, specify the route identifier using the 'TrackID' name-value pair argument. In this example, the routes are labeled Vehicle 1 and Vehicle 2. This screen capture shows the point where the two routes are about to cross paths.

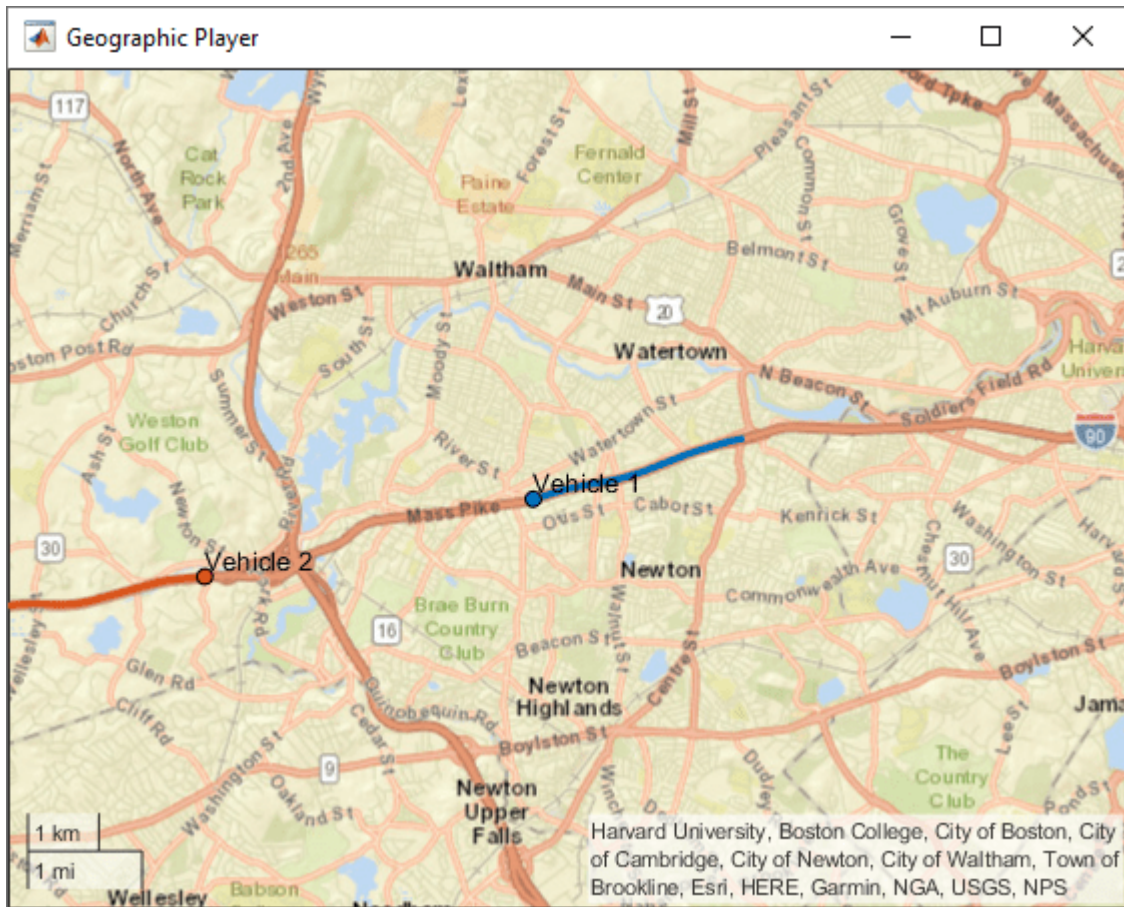

Load data for a route.

```
data = load('geoRoute.mat');
```

Extract data for the first vehicle.

```
lat1 = data.latitude;
lon1 = data.longitude;
```

Create a synthetic route for the second vehicle that drives the same route in the opposite direction.

```
lat2 = flipud(lat1);
lon2 = flipud(lon1);
```

Create a `geoplayer` object. Initialize the player to display the last 10 positions as a line trailing the current position.

```
zoomLevel = 12;
player = geoplayer(lat1(1),lon1(1),zoomLevel,...
    'HistoryDepth',10,'HistoryStyle','line');
```

Plot the positions of both vehicles as they move over the route. Specify an ID for each track by using the `'TrackID'` name-value pair argument. By default, the `geoplayer` object centers the display of the vehicle on the first track. You can center the display on other tracks by using the `CenterOnID` property of the `geoplayer` object.

```

loopCounter = length(lat1);
for i = 1:loopCounter
    plotPosition(player,lat1(i),lon1(i), 'TrackID',1, 'Label', 'Vehicle 1');
    plotPosition(player,lat2(i),lon2(i), 'TrackID',2, 'Label', 'Vehicle 2');
end

```

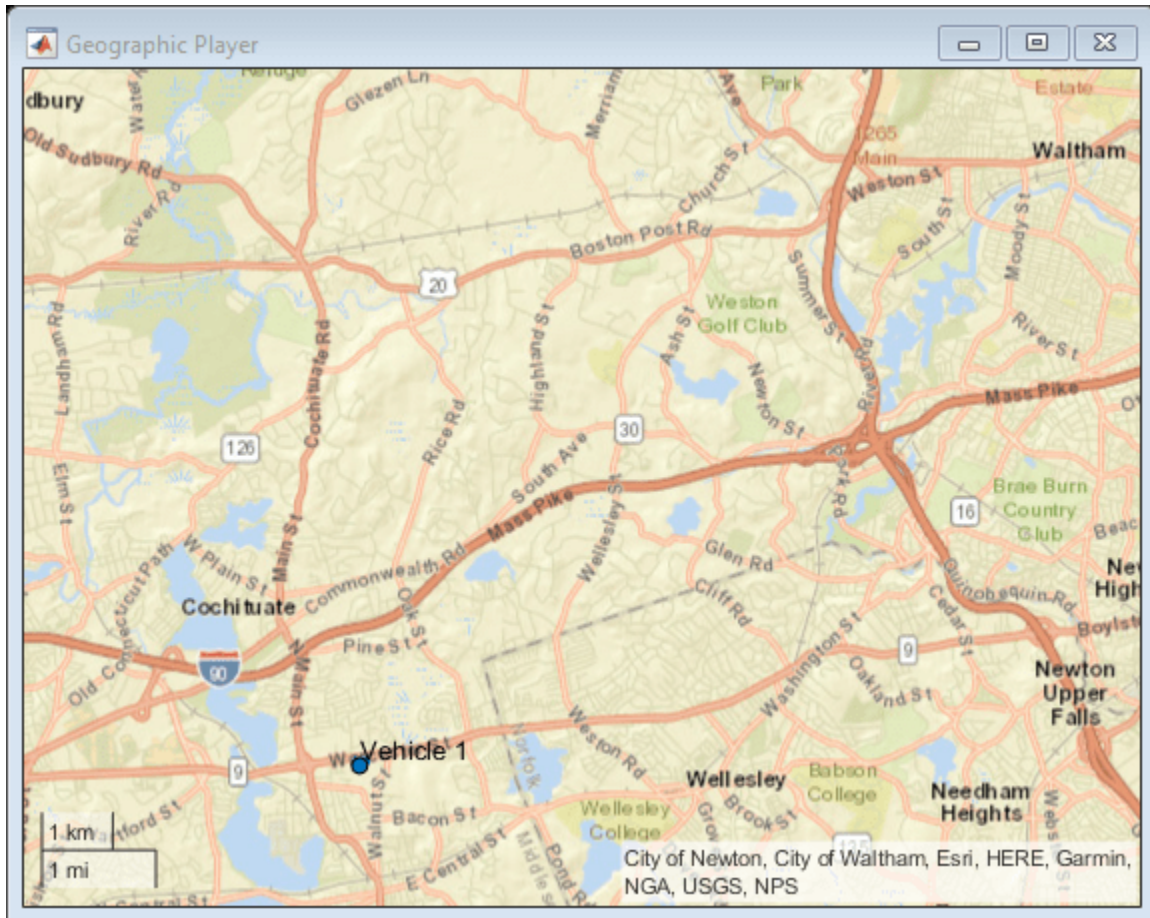

Limitations

- Geographic map tiles are not available for all locations.

More About

Custom Basemaps

The `geoplayer` object can use custom basemaps from providers such as HERE Technologies and OpenStreetMap.

To make a custom basemap available for use with the `geoplayer` object, use the `addCustomBasemap` function. After you add a custom basemap, it remains available for use in future MATLAB sessions, until you remove the basemap by using the `removeCustomBasemap` function.

To display streaming coordinates on a custom basemap, specify the name of the basemap in the `Basemap` property of the `geoplayer` object.

Note For some custom basemaps, access to the map servers requires a valid license from the map provider.

Tips

- When the `geoplayer` object plots a position that is outside the current view of the map, the object automatically scrolls the map.

Version History

Introduced in R2018a

See Also

Functions

[geobubble](#) | [geoaxes](#) | [geobasemap](#) | [geoplot](#) | [geolimits](#) | [latlon2local](#) | [local2latlon](#) | [addCustomBasemap](#) | [removeCustomBasemap](#)

Properties

[GeographicAxes Properties](#)

plotPosition

Display current position in geoplayer figure

Syntax

```
plotPosition(player,lat,lon)
plotPosition(player,lat,lon,Name,Value)
```

Description

`plotPosition(player,lat,lon)` plots the point specified by latitude and longitude coordinates, (lat,lon), in the `geoplayer` figure, specified by `player`. To plot multiple routes simultaneously, specify a unique identifier for each route using the `TrackID` parameter.

`plotPosition(player,lat,lon,Name,Value)` uses `Name,Value` pair arguments to modify aspects of the plotted points.

For example, `plotPosition(player,45,0,'Color','w','Marker','*')` plots a point in the `geoplayer` figure as a white star.

Examples

View Position of Vehicle Along Route

Load a sequence of latitude and longitude coordinates.

```
data = load('geoRoute.mat');
```

Create a geographic player and set the zoom level to 12. Compared to the default zoom level, this zoom level zooms the map out by a factor of 8.

```
player = geoplayer(data.latitude(1),data.longitude(1),12);
```

Display the full route.

```
plotRoute(player,data.latitude,data.longitude);
```

Display the coordinates in a sequence. The circle marker indicates the current position.

```
for i = 1:length(data.latitude)
    plotPosition(player,data.latitude(i),data.longitude(i));
    pause(0.05)
end
```

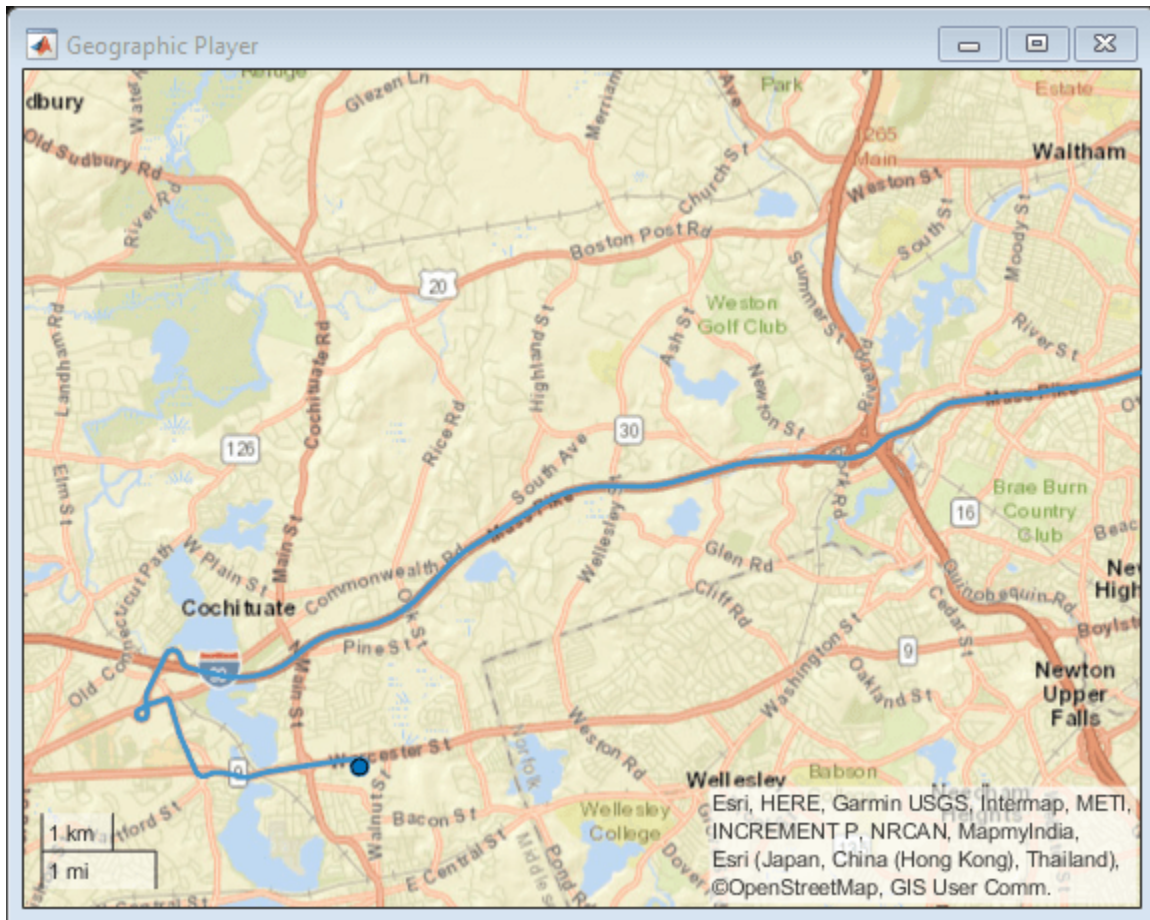
Plot the Tracks of Two Vehicles

Plot multiple routes simultaneously in a geographic player. First, assign each route a unique identifier. Then, when plotting points on the routes using the `plotPosition` object function, specify the route identifier using the 'TrackID' name-value pair argument. In this example, the routes are labeled Vehicle 1 and Vehicle 2. This screen capture shows the point where the two routes are about to cross paths.

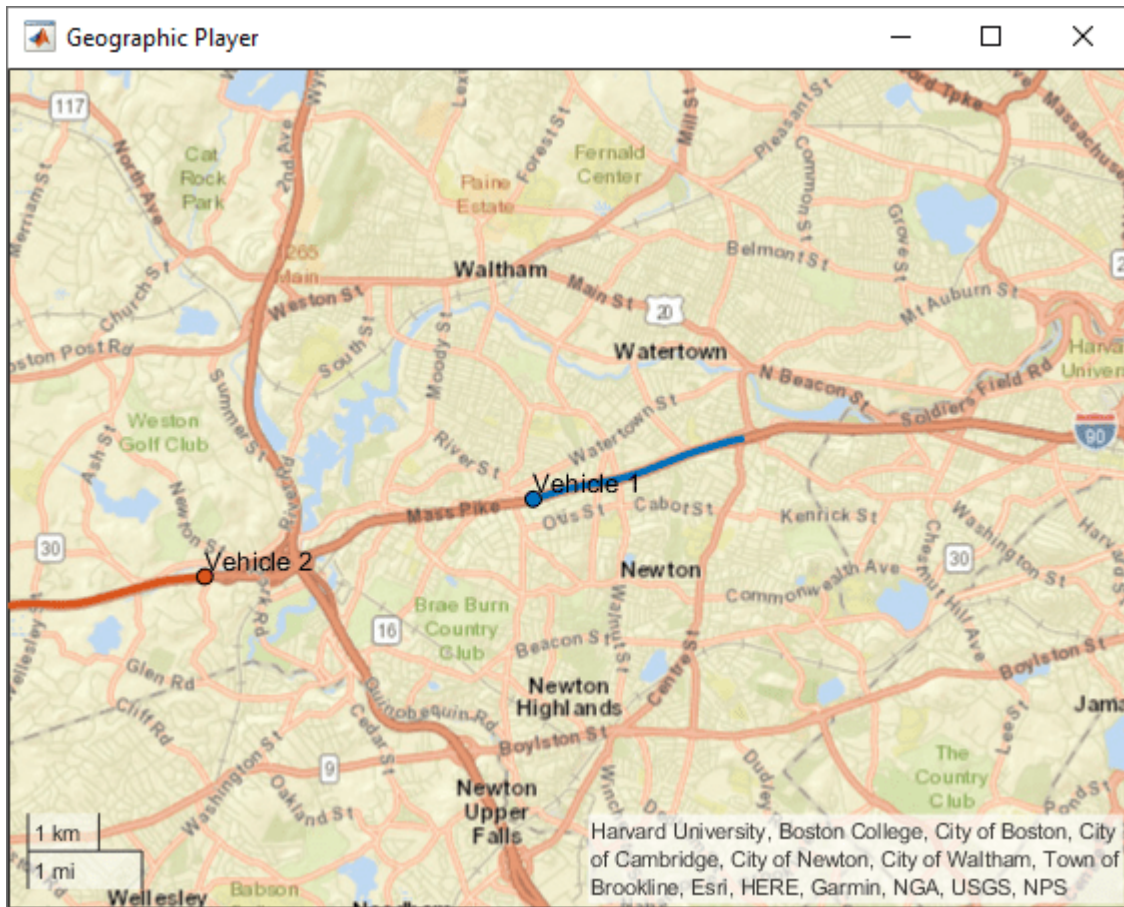

Load data for a route.

```
data = load('geoRoute.mat');
```

Extract data for the first vehicle.

```
lat1 = data.latitude;
lon1 = data.longitude;
```

Create a synthetic route for the second vehicle that drives the same route in the opposite direction.

```
lat2 = flipud(lat1);
lon2 = flipud(lon1);
```

Create a `geoplayer` object. Initialize the player to display the last 10 positions as a line trailing the current position.

```
zoomLevel = 12;
player = geoplayer(lat1(1),lon1(1),zoomLevel,...
    'HistoryDepth',10,'HistoryStyle','line');
```

Plot the positions of both vehicles as they move over the route. Specify an ID for each track by using the `'TrackID'` name-value pair argument. By default, the `geoplayer` object centers the display of the vehicle on the first track. You can center the display on other tracks by using the `CenterOnID` property of the `geoplayer` object.

```

loopCounter = length(lat1);
for i = 1:loopCounter
    plotPosition(player,lat1(i),lon1(i), 'TrackID',1, 'Label', 'Vehicle 1');
    plotPosition(player,lat2(i),lon2(i), 'TrackID',2, 'Label', 'Vehicle 2');
end

```

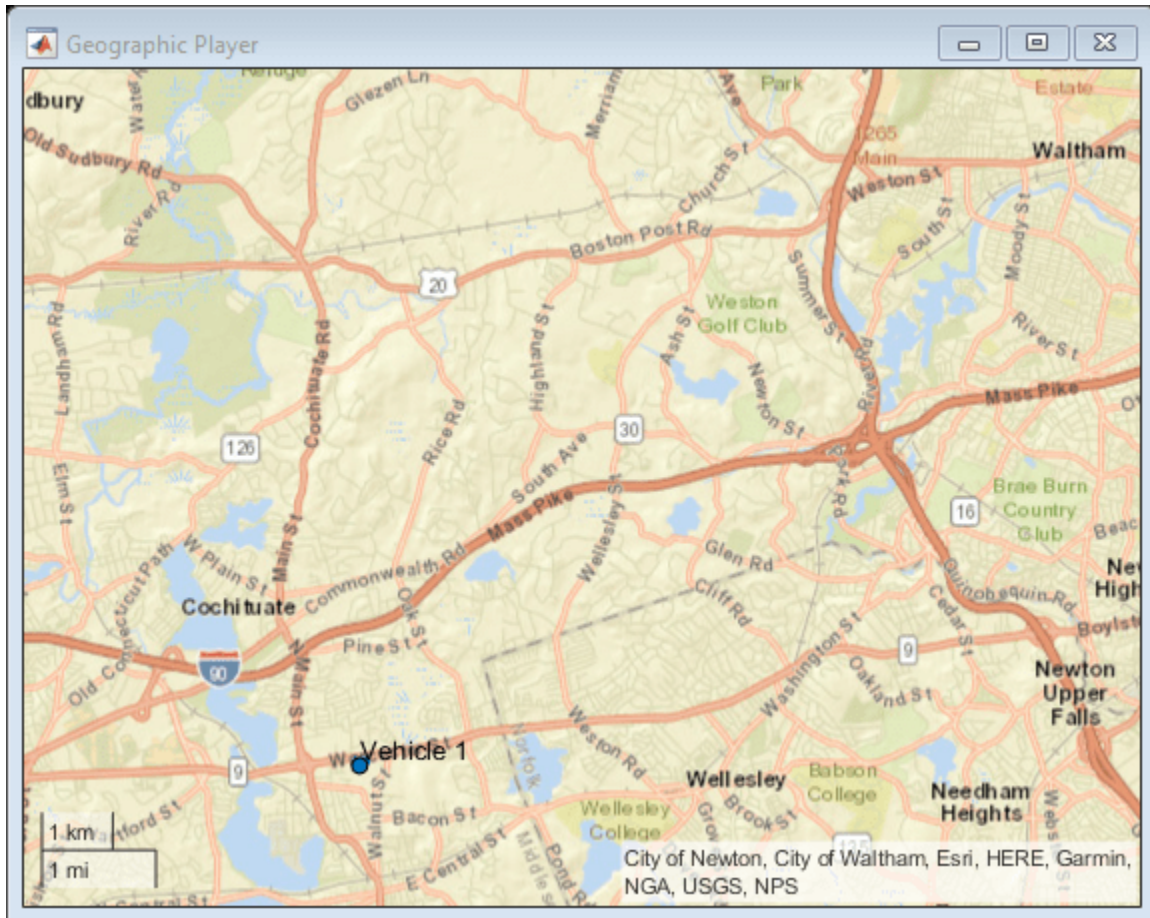

Input Arguments

player — Streaming geographic player

geoplayer object

Streaming geographic player, specified as a `geoplayer` object.⁹

lat — Latitude coordinate

real scalar in the range $[-90, 90]$

Latitude coordinate of the point to display in the geographic player, specified as a real scalar in the range $[-90, 90]$.

Data Types: `single` | `double`

⁹ Alignment of boundaries and region labels are a presentation of the feature provided by the data vendors and do not imply endorsement by MathWorks.

Lon — Longitude coordinate

real scalar in the range [-180, 180]

Longitude coordinate of the point to display in the geographic player, specified as a real scalar in the range [-180, 180].

Data Types: single | double

Name-Value Pair Arguments

Specify optional pairs of arguments as `Name1=Value1, ..., NameN=ValueN`, where `Name` is the argument name and `Value` is the corresponding value. Name-value arguments must appear after other arguments, but the order of the pairs does not matter.

Before R2021a, use commas to separate each name and value, and enclose Name in quotes.

Example: 'Color', 'k'

Label — Text description

' ' (default) | character vector | string scalar

Text description of the point, specified as the comma-separated pair consisting of 'Label' and a character vector or string scalar.







Example: 'Label', '07:45:00AM'

Color — Marker color

color name | short color name | RGB triplet

Marker color, specified as the comma-separated pair consisting of 'Color' and a color name, short color name, or RGB triplet. By default, the marker color is selected automatically.

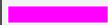
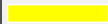
For a custom color, specify an RGB triplet. An RGB triplet is a three-element row vector whose elements specify the intensities of the red, green, and blue components of the color. The intensities must be in the range [0, 1]; for example, [0.4 0.6 0.7]. Alternatively, you can specify some common colors by name. This table lists the named color options and the equivalent RGB triplet values.

Color Name	Color Short Name	RGB Triplet	Appearance
'red'	'r'	[1 0 0]	
'green'	'g'	[0 1 0]	
'blue'	'b'	[0 0 1]	
'cyan'	'c'	[0 1 1]	
'magenta'	'm'	[1 0 1]	
'yellow'	'y'	[1 1 0]	
'black'	'k'	[0 0 0]	
'white'	'w'	[1 1 1]	

Example: 'Color', [1 0 1]

Example: 'Color', 'm'

Example: 'Color', 'magenta'

Marker – Marker symbol

'o' (default) | '+' | '*' | '.' | 'x' | ...

Marker symbol, specified as the comma-separated pair consisting of 'Marker' and one of the markers in this table.

Marker	Description	Resulting Marker
"o"	Circle	○
"+"	Plus sign	+
"*"	Asterisk	*
","	Point	•
"x"	Cross	×
"_"	Horizontal line	—
" "	Vertical line	
"square"	Square	□
"diamond"	Diamond	◇
"^"	Upward-pointing triangle	△
"v"	Downward-pointing triangle	▽
">"	Right-pointing triangle	▷
"<"	Left-pointing triangle	◁
"pentagram"	Pentagram	☆
"hexagram"	Hexagram	☆

MarkerSize – Diameter of marker

6 (default) | positive real scalar

Approximate diameter of marker in points, specified as the comma-separated pair consisting of 'MarkerSize' and a positive real scalar. 1 point = 1/72 inch. A marker size larger than 6 can reduce the rendering performance.

TrackID – Unique identifier for plotted track

1 (default) | positive integer

Unique identifier for plotted track, specified as a positive integer. Use this value to identify individual tracks when you plot multiple tracks. When you specify this value, all other name-value pair arguments for this function apply to only the track specified by this unique identifier.

Tips

- When a vehicle's track goes outside of viewable area, the map automatically re-centers based on the value of the `geoplayer.CenterOnID` property.

Version History

Introduced in R2018a

See Also

`geoplayer` | `plotRoute` | `reset` | `latlon2local` | `local2latlon`

plotRoute

Display continuous route in `geoplayer` figure

Syntax

```
plotRoute(player, lat, lon)
plotRoute(player, lat, lon, Name, Value)
```

Description

`plotRoute(player, lat, lon)` displays a route, as defined by a series of latitude-longitude coordinates, in a `geoplayer` figure. The route appears as a continuous line on a map. To plot multiple routes in a `geoplayer`, call `plotRoute` for each route.

`plotRoute(player, lat, lon, Name, Value)` uses `Name, Value` pair arguments to modify the visual style of the route.

For example, `plotRoute(player, [45 46], [0 0], 'Color', 'k')` plots a route in a `geoplayer` figure as a black line.

Examples

View Position of Vehicle Along Route

Load a sequence of latitude and longitude coordinates.

```
data = load('geoRoute.mat');
```

Create a geographic player and set the zoom level to 12. Compared to the default zoom level, this zoom level zooms the map out by a factor of 8.

```
player = geoplayer(data.latitude(1), data.longitude(1), 12);
```

Display the full route.

```
plotRoute(player, data.latitude, data.longitude);
```

Display the coordinates in a sequence. The circle marker indicates the current position.

```
for i = 1:length(data.latitude)
    plotPosition(player, data.latitude(i), data.longitude(i));
    pause(0.05)
end
```

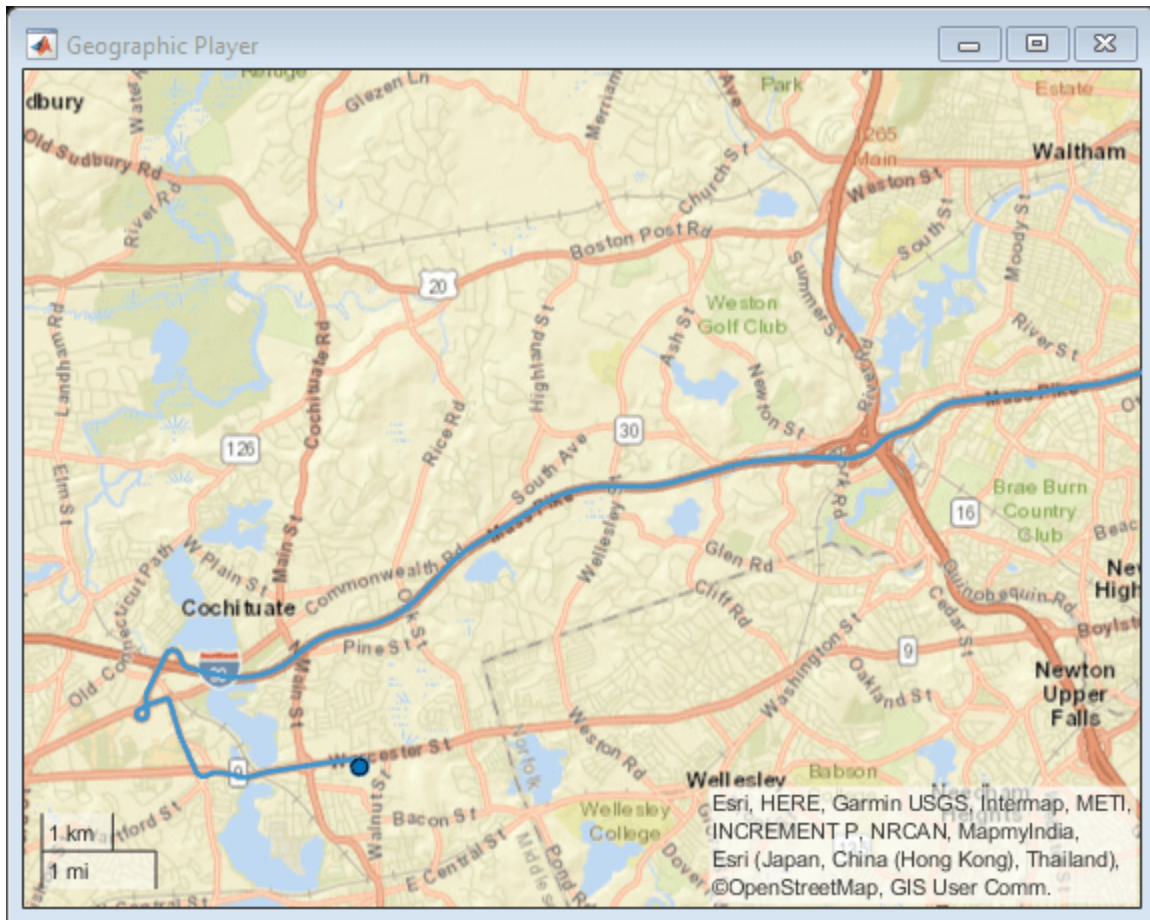

Plot Multiple Routes

Plot multiple routes in a geographic player by calling `plotRoute` multiple times.

Load data for a route.

```
data = load('geoRoute.mat');
```

Extract data for the first vehicle.

```
lat1 = data.latitude;  
lon1 = data.longitude;
```

Create a synthetic route for the second vehicle. Add a small offset for better visibility.

```
lat2 = lat1 + 0.002; % add a small offset in degrees  
lon2 = lon1;
```

Create a `geoplayer` object, specifying the starting coordinates for one of the routes.

```
player = geoplayer(lat1(1), lon1(1));
```

Plot the routes in the geographic player by calling `plotRoute` for each route.

```
plotRoute(player, lat1, lon1);
plotRoute(player, lat2, lon2);
```

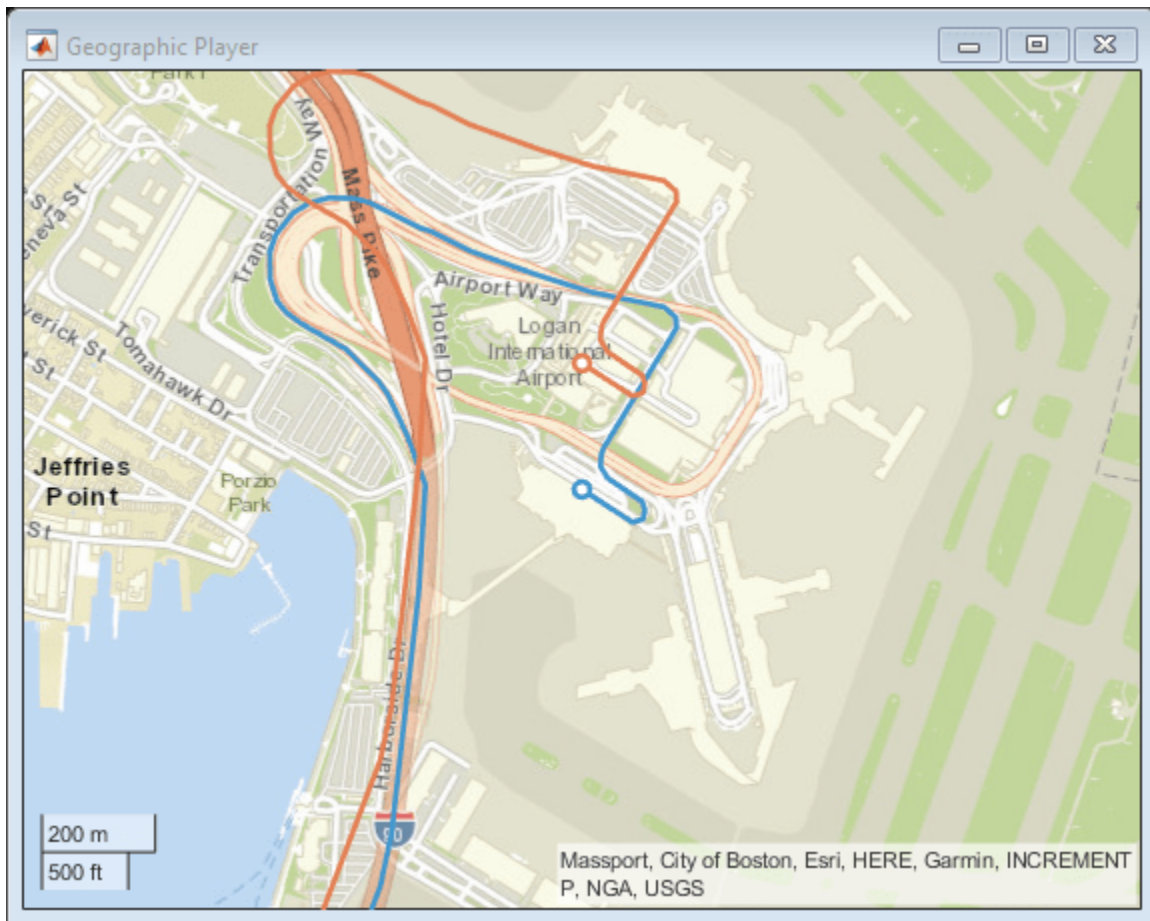

Input Arguments

player — Streaming geographic player

geoplayer object

Streaming geographic player, specified as a geoplayer object.¹⁰

lat — Latitude coordinates

real-valued vector

Latitude coordinates of points along the route, specified as a real-valued vector with elements in the range [-90, 90].

Data Types: single | double

lon — Longitude coordinates

real-valued vector

¹⁰ Alignment of boundaries and region labels are a presentation of the feature provided by the data vendors and do not imply endorsement by MathWorks.

Longitude coordinates of points along the route, specified as a real-valued vector with elements in the range [-180, 180].

Data Types: `single` | `double`

Name-Value Pair Arguments

Specify optional pairs of arguments as `Name1=Value1, ..., NameN=ValueN`, where `Name` is the argument name and `Value` is the corresponding value. Name-value arguments must appear after other arguments, but the order of the pairs does not matter.

Before R2021a, use commas to separate each name and value, and enclose Name in quotes.





Example: `'Color','g'`

Color — Line color

`color name` | `short color name` | `RGB triplet`

Line color, specified as the comma-separated pair consisting of `'Color'` and a color name, short color name, or RGB triplet. By default, the line color is selected automatically.

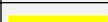
For a custom color, specify an RGB triplet. An RGB triplet is a three-element row vector whose elements specify the intensities of the red, green, and blue components of the color. The intensities must be in the range [0, 1]; for example, [0.4 0.6 0.7]. Alternatively, you can specify some common colors by name. This table lists the named color options and the equivalent RGB triplet values.

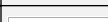
Color Name	Color Short Name	RGB Triplet	Appearance
'red'	'r'	[1 0 0]	
'green'	'g'	[0 1 0]	
'blue'	'b'	[0 0 1]	
'cyan'	'c'	[0 1 1]	
'magenta'	'm'	[1 0 1]	
'yellow'	'y'	[1 1 0]	
'black'	'k'	[0 0 0]	
'white'	'w'	[1 1 1]	

Example: `'Color',[1 0 1]`

Example: `'Color','m'`

Example: `'Color','magenta'`

LineWidth — Line width

2 (default) | positive number

Line width in points, specified as the comma-separated pair consisting of `'LineWidth'` and a positive number. 1 point = 1/72 inch.

ShowEndpoints — Display origin and destination

`'on'` (default) | `'off'`

Display the origin and destination points, specified as the comma-separated pair consisting of 'ShowEndpoints' and 'on' or 'off'. Specify 'on' to display the origin and destination points. The origin marker is white and the destination marker is filled with color.

Version History

Introduced in R2018a

See Also

`geoplayer` | `plotPosition` | `reset` | `latlon2local` | `local2latlon`

reset

Remove all existing plots from `geoplayer` figure

Syntax

```
reset(player)
```

Description

`reset(player)` removes all previously plotted points and routes from the `geoplayer` figure.

Examples

Reset Geographic Player

Load a sequence of latitude and longitude coordinates.

```
data = load('geoRoute.mat');
```

Create a geographic player with a zoom level of 12. Configure the geographic player to display all points in its history.

```
player = geoplayer(data.latitude(1),data.longitude(1),12,'HistoryDepth',Inf);
```

Display the full route.

```
plotRoute(player,data.latitude,data.longitude);
```

Display the coordinates in a sequence. The circle marker indicates the current position. At the 200th point, reset the geographic player. Observe that the route and all previously plotted points are removed.

```
for i = 1:length(data.latitude)
    plotPosition(player,data.latitude(i),data.longitude(i));

    if i == 200
        reset(player)
    end

    pause(.05)
end
```

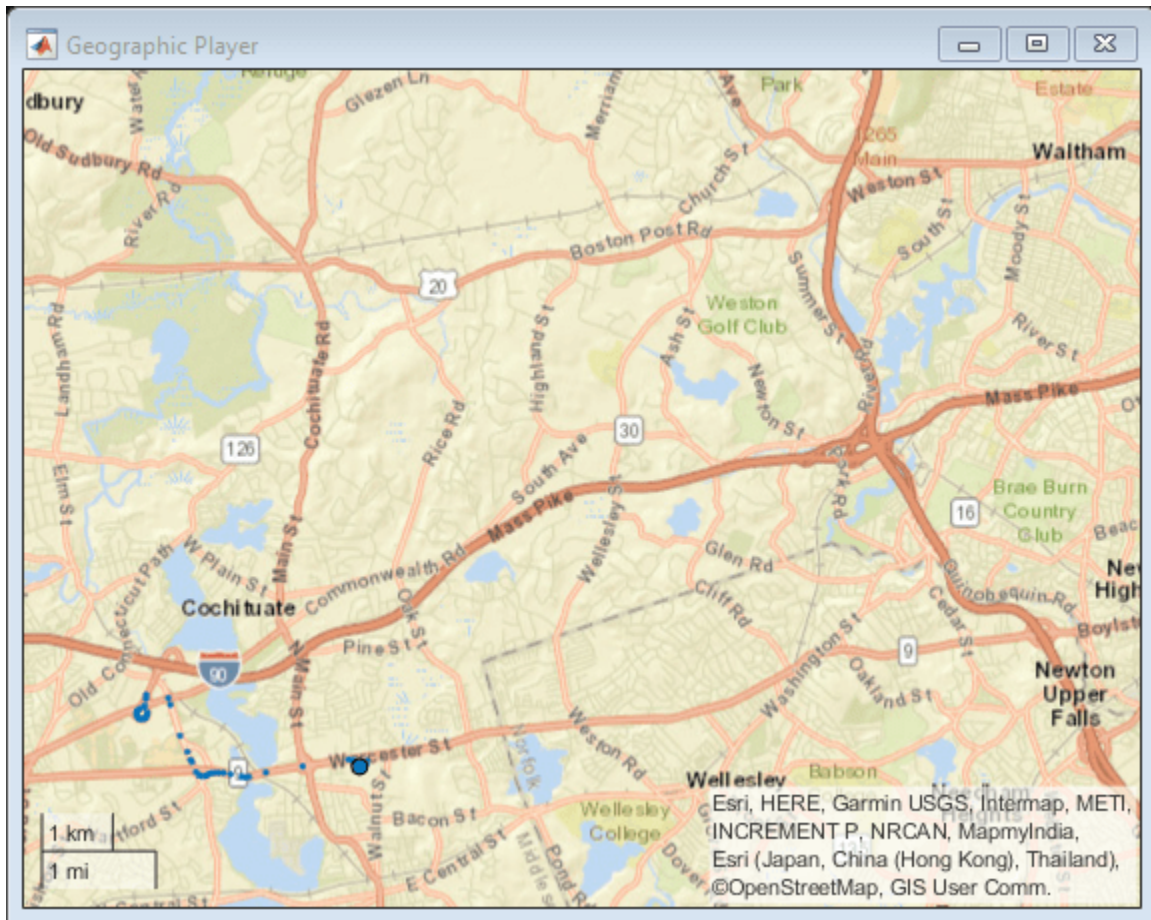
Input Arguments

player — Streaming geographic player
geoplayer object

Streaming geographic player, specified as a geoplayer object.¹¹

Version History

Introduced in R2018a

See Also

plotPosition | plotRoute | geoplayer

¹¹ Alignment of boundaries and region labels are a presentation of the feature provided by the data vendors and do not imply endorsement by MathWorks.

show

Make geoplayer figure visible

Syntax

```
show(player)
```

Description

`show(player)` makes the geoplayer figure visible again after closing or hiding it.

Examples

Hide and Show Geographic Player

Load a sequence of latitude and longitude coordinates.

```
data = load('geoRoute.mat');
```

Create a geographic player with a zoom level of 10. Configure the player to show its complete history of plotted points.

```
player = geoplayer(data.latitude(1),data.longitude(1),10,'HistoryDepth',Inf);
```

Display the first half of the geographic coordinates in a sequence. The circle marker indicates the current position.

```
halfLength = round(length(data.latitude)/2);
```

```
for i = 1:halfLength
    plotPosition(player,data.latitude(i),data.longitude(i));
end
```

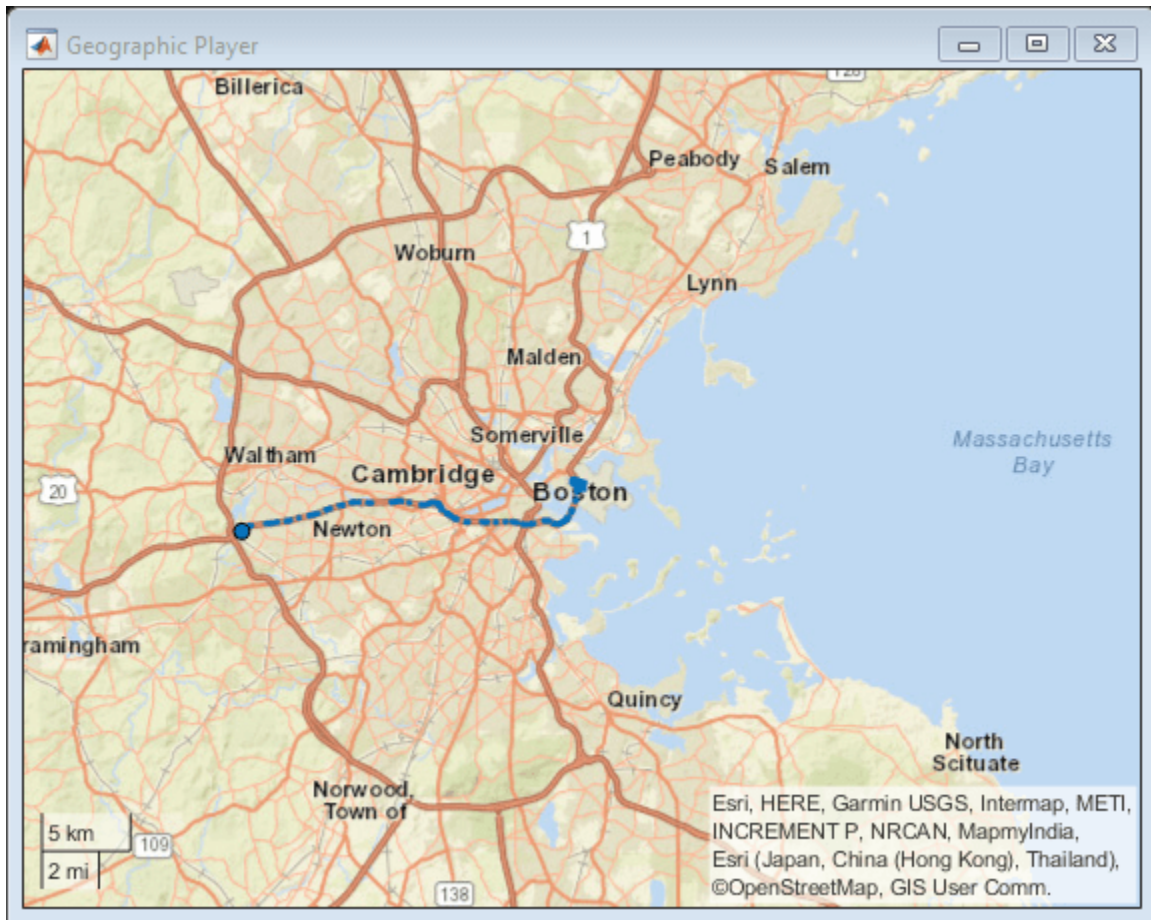

Hide the player and confirm that it is no longer visible.

```
hide(player)
isOpen(player)
```

```
ans = logical
      0
```

Add the remaining half of the geographic coordinates to the map.

```
for i = halfLength+1:length(data.latitude)
    plotPosition(player,data.latitude(i),data.longitude(i));
end
```

Show the player. The player now displays both halves of the route.

```
show(player)
```

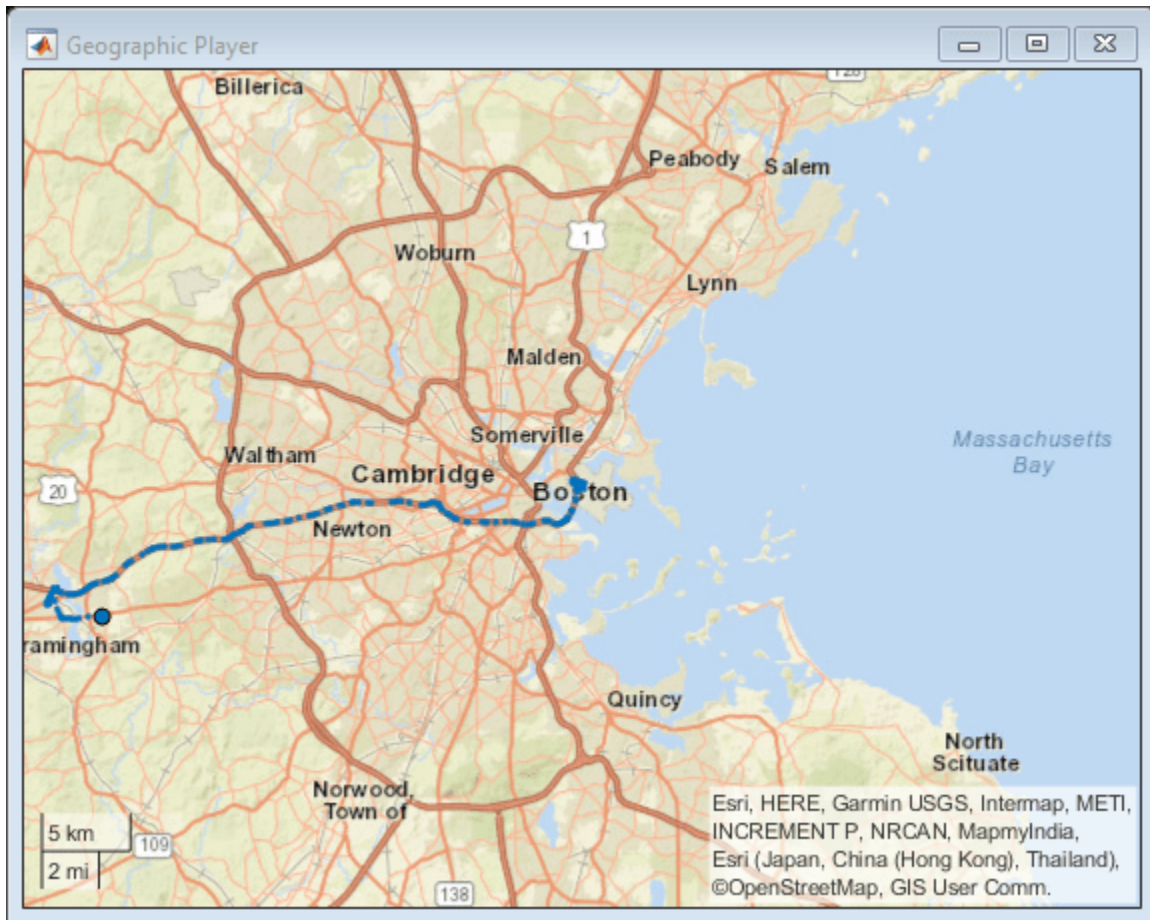

Input Arguments

player — Streaming geographic player
geoplayer object

Streaming geographic player, specified as a geoplayer object.¹²

Version History

Introduced in R2018a

See Also

hide | isOpen | geoplayer

¹² Alignment of boundaries and region labels are a presentation of the feature provided by the data vendors and do not imply endorsement by MathWorks.

hide

Make geoplayer figure invisible

Syntax

```
hide(player)
```

Description

`hide(player)` hides the geoplayer figure. To redisplay this figure, use `show(player)`.

Examples

Hide and Show Geographic Player

Load a sequence of latitude and longitude coordinates.

```
data = load('geoRoute.mat');
```

Create a geographic player with a zoom level of 10. Configure the player to show its complete history of plotted points.

```
player = geoplayer(data.latitude(1),data.longitude(1),10,'HistoryDepth',Inf);
```

Display the first half of the geographic coordinates in a sequence. The circle marker indicates the current position.

```
halfLength = round(length(data.latitude)/2);
```

```
for i = 1:halfLength
    plotPosition(player,data.latitude(i),data.longitude(i));
end
```

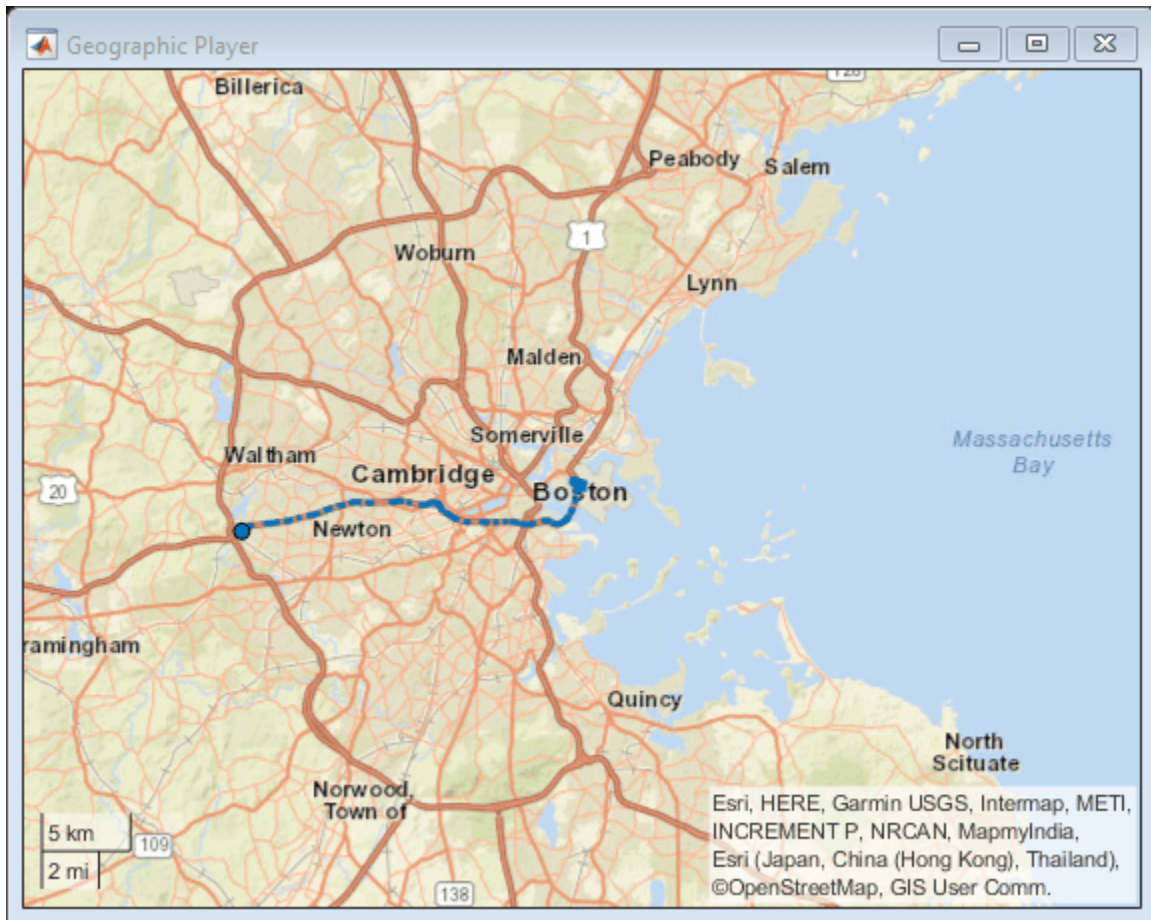
Hide the player and confirm that it is no longer visible.

```
hide(player)
isOpen(player)
```

```
ans = logical
      0
```

Add the remaining half of the geographic coordinates to the map.

```
for i = halfLength+1:length(data.latitude)
    plotPosition(player,data.latitude(i),data.longitude(i));
end
```

Show the player. The player now displays both halves of the route.

```
show(player)
```

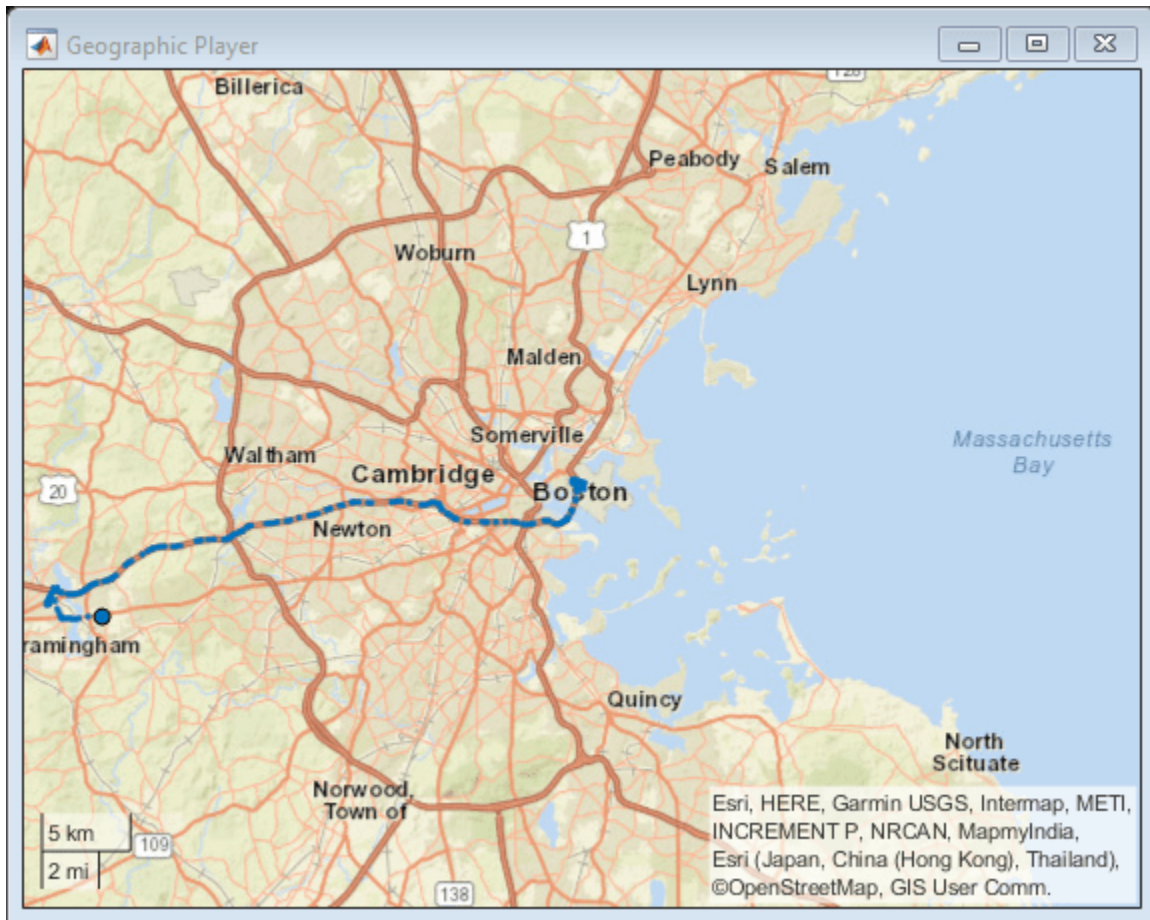

Input Arguments

player — Streaming geographic player
geoplayer object

Streaming geographic player, specified as a geoplayer object.¹³

Version History

Introduced in R2018a

See Also

show | isOpen | geoplayer

¹³ Alignment of boundaries and region labels are a presentation of the feature provided by the data vendors and do not imply endorsement by MathWorks.

isOpen

Return true if `geoplayer` figure is visible

Syntax

```
tf = isOpen(player)
```

Description

`tf = isOpen(player)` returns logical 1 (true) if the `geoplayer` figure is visible. Otherwise, `isOpen` returns logical 0 (false).

Examples

Plot Points While Geographic Player Is Open

Load a sequence of latitude and longitude coordinates.

```
data = load('geoRoute.mat');
```

Create a geographic player with a zoom level of 12. Configure the player to display all points in its history.

```
player = geoplayer(data.latitude(1),data.longitude(1),12,'HistoryDepth',Inf);
```

Display the geographic coordinates in a sequence by using the `plotPosition` function. Put the call to `plotPosition` inside a `while` loop, so that the player plots points only while the figure is open. You can exit the loop by closing the figure. If you do not close the figure, then the loop automatically exits when all points are plotted.

```
i = 1;
numPoints = length(data.latitude);
while isOpen(player) && i<=numPoints
    plotPosition(player,data.latitude(i),data.longitude(i))
    pause(0.1)
    i=i+1;
end
```

To make the figure visible again, use the `show` function.

```
show(player)
```

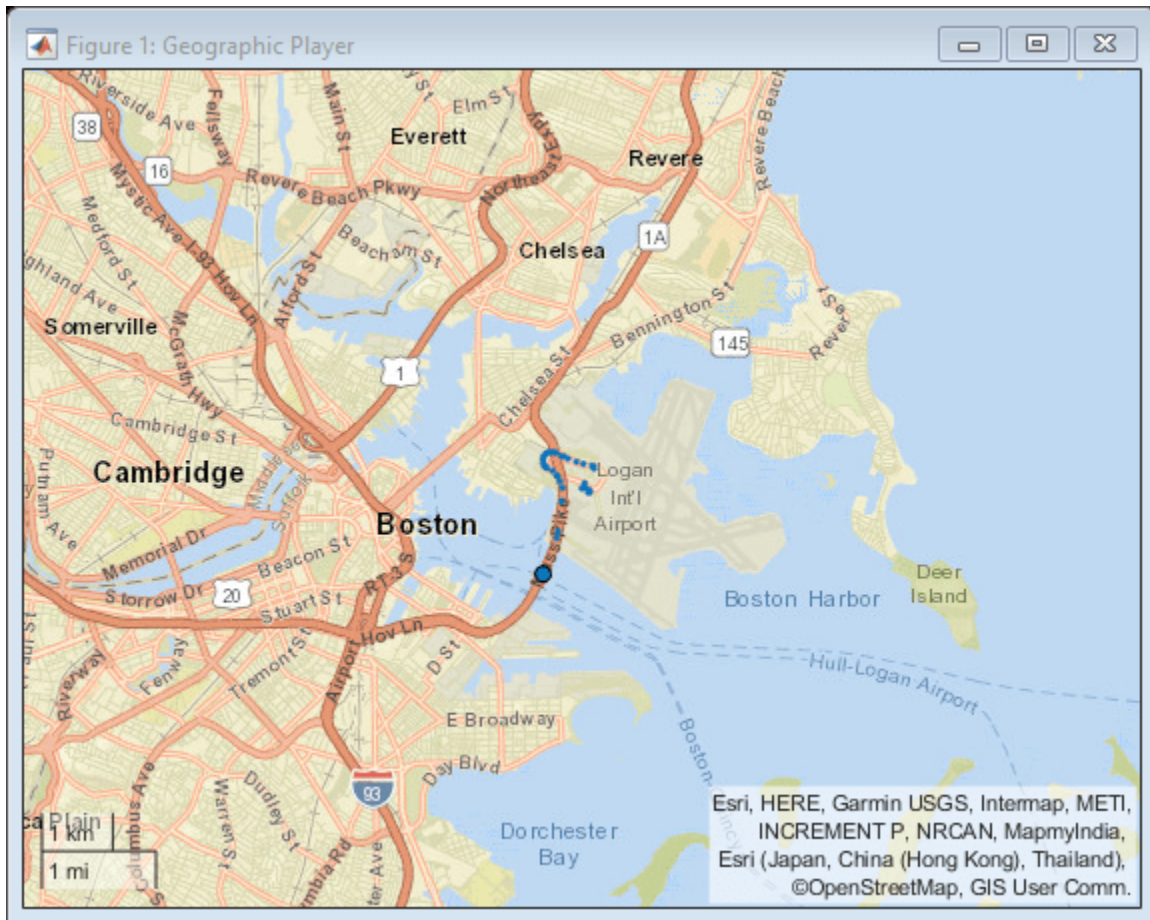
Input Arguments

player — Streaming geographic player

geoplayer object

Streaming geographic player, specified as a geoplayer object.¹⁴

Output Arguments

tf — Visibility of geographic player

1 (true) | 0 (false)

Visibility of geographic player, returned as logical 1 (true) when the geoplayer figure is open, and logical 0 (false) otherwise.

Version History

Introduced in R2018a

¹⁴ Alignment of boundaries and region labels are a presentation of the feature provided by the data vendors and do not imply endorsement by MathWorks.

See Also

show | hide | geoplayer

hereHDLMReader

HERE HD Live Map reader

Description

Use a `hereHDLMReader` object to read high-definition map data for selected map tiles from the HERE HD Live Map ¹⁵ (HERE HDLM) web service, provided by HERE Technologies. HERE HDLM data provides highly detailed and accurate information about the vehicle environment, such as road and lane topology, and is suitable for developing automated driving applications.

You can select specific map tiles from which to read data or select map tiles based on the coordinates of a driving route. To read map data for tiles, use the `read` function and specify the reader as an input argument. For more details, see “Read and Visualize HERE HD Live Map Data”.

Note Use of the `hereHDLMReader` object requires valid HERE HDLM credentials. If you have not previously set up credentials, a dialog box prompts you to enter them. Enter the **Access Key ID** and **Access Key Secret** that you obtained from HERE Technologies, and click **OK**.

Creation

Syntax

```
reader = hereHDLMReader(lat,lon)
reader = hereHDLMReader(tileID)
reader = hereHDLMReader( ____,Name,Value)
```

Description

`reader = hereHDLMReader(lat,lon)` creates a HERE HDLM reader that can read map data for the HERE map tiles that correspond to a set of latitude and longitude coordinates. The map tiles are at a zoom level of 14.

`reader = hereHDLMReader(tileID)` creates a HERE HDLM reader that can read map data for the map tiles with the specified HERE tile IDs. These tile IDs are stored in the `TileIDs` property of the HERE HDLM reader.

`reader = hereHDLMReader(____,Name,Value)` sets the `Configuration`, `WriteLocation`, and `CoordinateFormat` properties using one or more name-value pairs. For example, `hereHDLMReader(tileID, 'Configuration', config)` creates a reader that is configured to read map tile data from a specific HERE HDLM production catalog or catalog version, where `config` is a `hereHDLMConfiguration` object.

¹⁵ You need to enter into a separate agreement with HERE in order to gain access to the HDLM services and to get the required credentials (`access_key_id` and `access_key_secret`) for using the HERE Service.

Input Arguments

lat — Latitude coordinates

vector of real values in the range [-90, 90]

Latitude coordinates, specified as a vector of real values in the range [-90, 90].

Use this vector, along with `lon`, to specify the coordinates of a driving route that you want to read map data from.

`lat` and `lon` must be the same size.

Data Types: `double`

lon — Longitude coordinates

vector of real values in the range [-180, 180]

Longitude coordinates, specified as a vector of real values in the range [-180, 180].

Use this vector, along with `lat`, to specify the coordinates of a driving route that you want to read map data from.

`lat` and `lon` must be the same size.

Data Types: `double`

tileID — HERE tile IDs

vector of unsigned 32-bit integers

HERE tile IDs from which to read data, specified as a vector of unsigned 32-bit integers. These tile IDs are stored in the `TileIDs` property of the `hereHDLMReader` object. The specified map tiles must all come from the same HERE HDLM production catalog.

If you configure the `hereHDLMReader` object to read data from a specific catalog using the `hereHDLMConfiguration` object, then all tile IDs must be found within that catalog. Otherwise, the reader object returns an error.

Example: `uint32([386497368 386497369])`

Data Types: `uint32`

Properties

TileIDs — HERE tile IDs

vector of unsigned 32-bit integers

This property is read-only.

HERE tile IDs from which to read data, specified as a vector of unsigned 32-bit integers. These tiles correspond to either the specified `lat` and `lon` coordinates or the specified `tileID` tiles.

Example: `uint32([386497368 386497369])`

Data Types: `uint32`

Layers — Map data layers

string array

This property is read-only.

Map data layers available for the selected HERE tile IDs, specified as a string array of layer names. The available map layers vary depending on the geographic region.

To read data from these layers, specify these layer names as inputs to the `read` function.

Configuration — Catalog configuration

`hereHDLMConfiguration` object

This property is read-only.

Catalog configuration, specified as a `hereHDLMConfiguration` object. This configuration contains the specific HERE HDLM catalog and catalog version that the `hereHDLMReader` object reads data from.

If you do not specify a configuration at creation, the reader object computes the default configuration by searching the latest version of each production catalog. If all selected map tile IDs are found within a catalog, then the `hereHDLMReader` object is configured to read data from the latest version of that catalog.

You can set this property when you create the reader object. After you create the object, this property is read-only.

WriteLocation — Folder name of downloaded map data

`tempdir` (temporary directory) (default) | string scalar | character vector

This property is read-only.

Name of folder to which HERE HDLM data is downloaded, specified as a string scalar or character vector. The specified folder must exist and have write permissions.

By default, data from the HERE HDLM web service is downloaded to a temporary file location. This temporary file location is deleted at the end of your MATLAB session.

You can set this property when you create the reader object. After you create the object, this property is read-only.

Example: `"C:\Users\myName\HERE"`

CoordinateFormat — Type of coordinate encoding format

`'geographic'` (default) | `'raw'`

Type of coordinate encoding format to apply to geographic coordinate values, specified as either `'geographic'` or `'raw'`.

Format	Description	Example
<code>'geographic'</code>	Coordinate values are returned as (latitude, longitude) pairs with decimal degrees.	<code>[42.3743 -71.0266]</code>
<code>'raw'</code>	Coordinate values are returned in the default coordinate encoding format of the HERE HDLM service.	<code>int64(5978842261285240832)</code>

Object Functions

`read` Read HERE HD Live Map layer data
`plot` Plot HERE HD Live Map layer data

Examples

Plot and Stream Lane Topology Data from Driving Route

Use the HERE HD Live Map (HERE HDLM) service to read the lane topology data of a driving route and its surrounding area. Plot this data, and then stream the route on a geographic player.

Load the latitude and longitude coordinates of a driving route in Natick, Massachusetts, USA.

```
route = load('geoSequenceNatickMA.mat');  
lat = route.latitude;  
lon = route.longitude;
```

Stream the coordinates on a geographic player.

```
player = geoplayer(lat(1),lon(1),'HistoryDepth',5);  
plotRoute(player,lat,lon)
```

```
for idx = 1:length(lat)  
    plotPosition(player,lat(idx),lon(idx))  
end
```

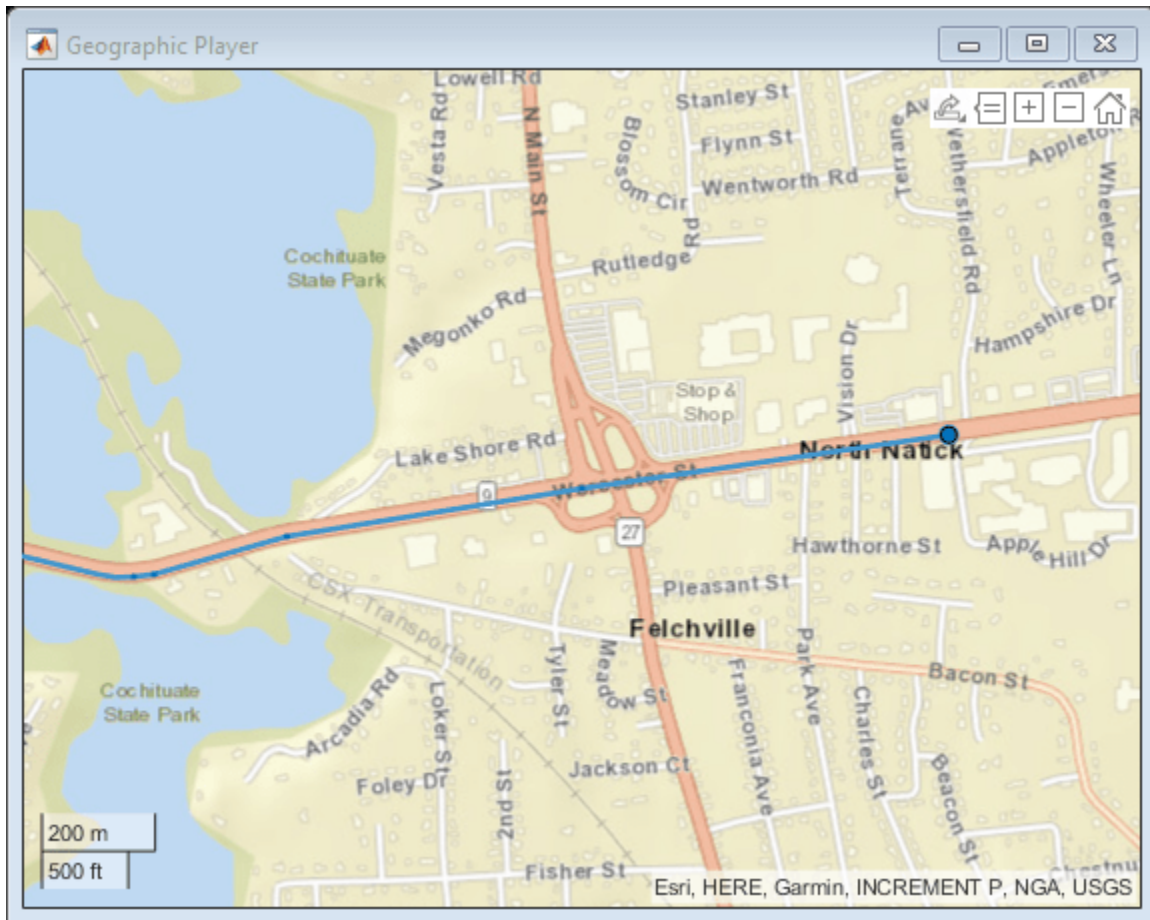

Create a HERE HDLM reader from the route coordinates. If you have not previously set up HERE HDLM credentials, a dialog box prompts you to enter them. The reader contains map data for the two map tiles that the route crosses.

```
reader = hereHDLMReader(lat,lon);
```

Read lane topology data from the LaneTopology layer of the map tiles. Plot the lane topology.

```
laneTopology = read(reader, 'LaneTopology');
plot(laneTopology)
```

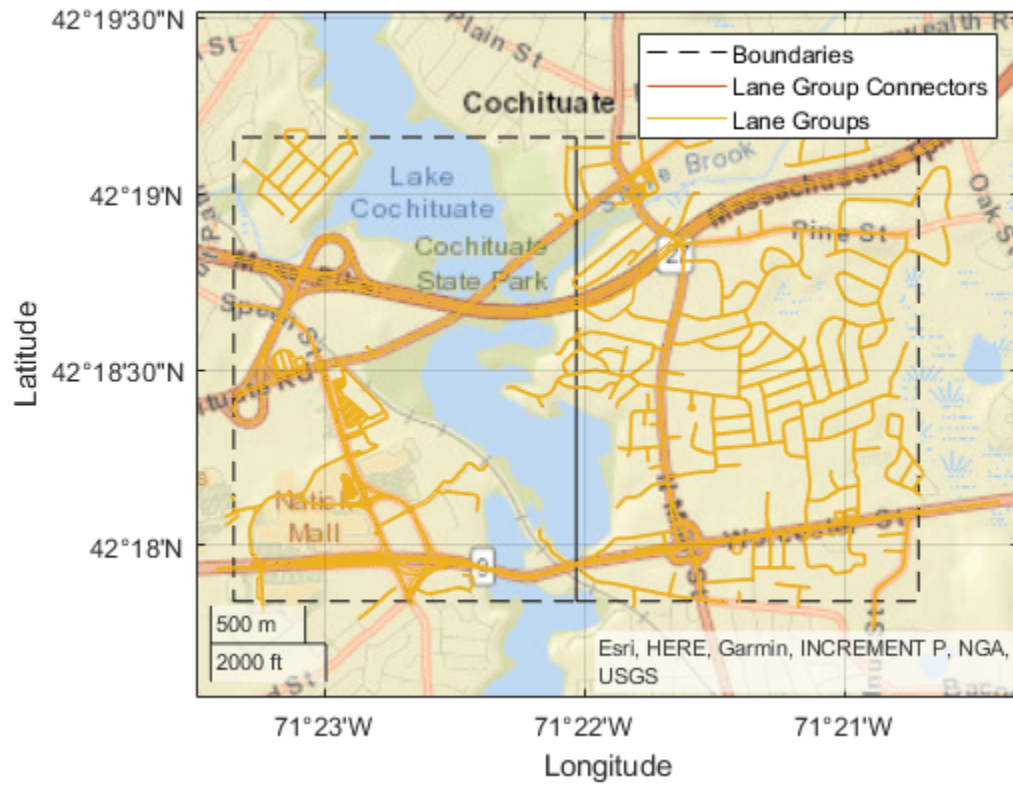

Overlay the route data on the plot.

```
hold on  
geoplot(lat,lon,'bo-','DisplayName','Route');  
hold off
```

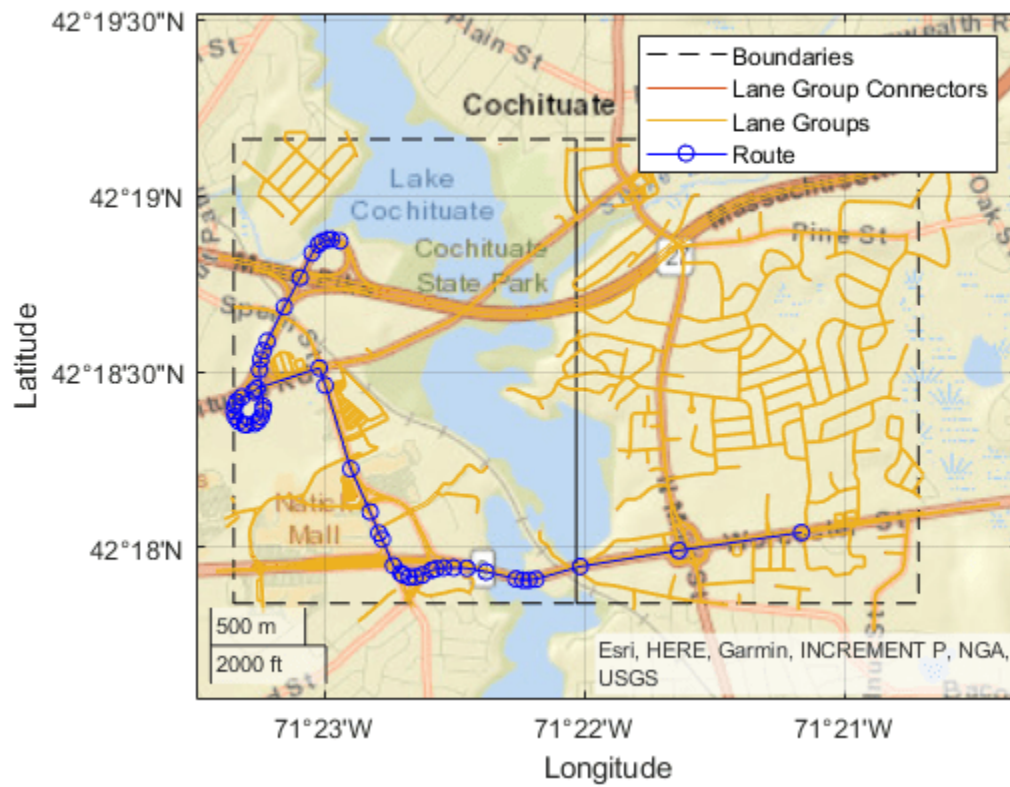
Overlay the lane topology data on the geographic player. Stream the route again.

```
plot(laneTopology, 'Axes', player.Axes)
for idx = 1:length(lat)
    plotPosition(player, lat(idx), lon(idx))
end
```

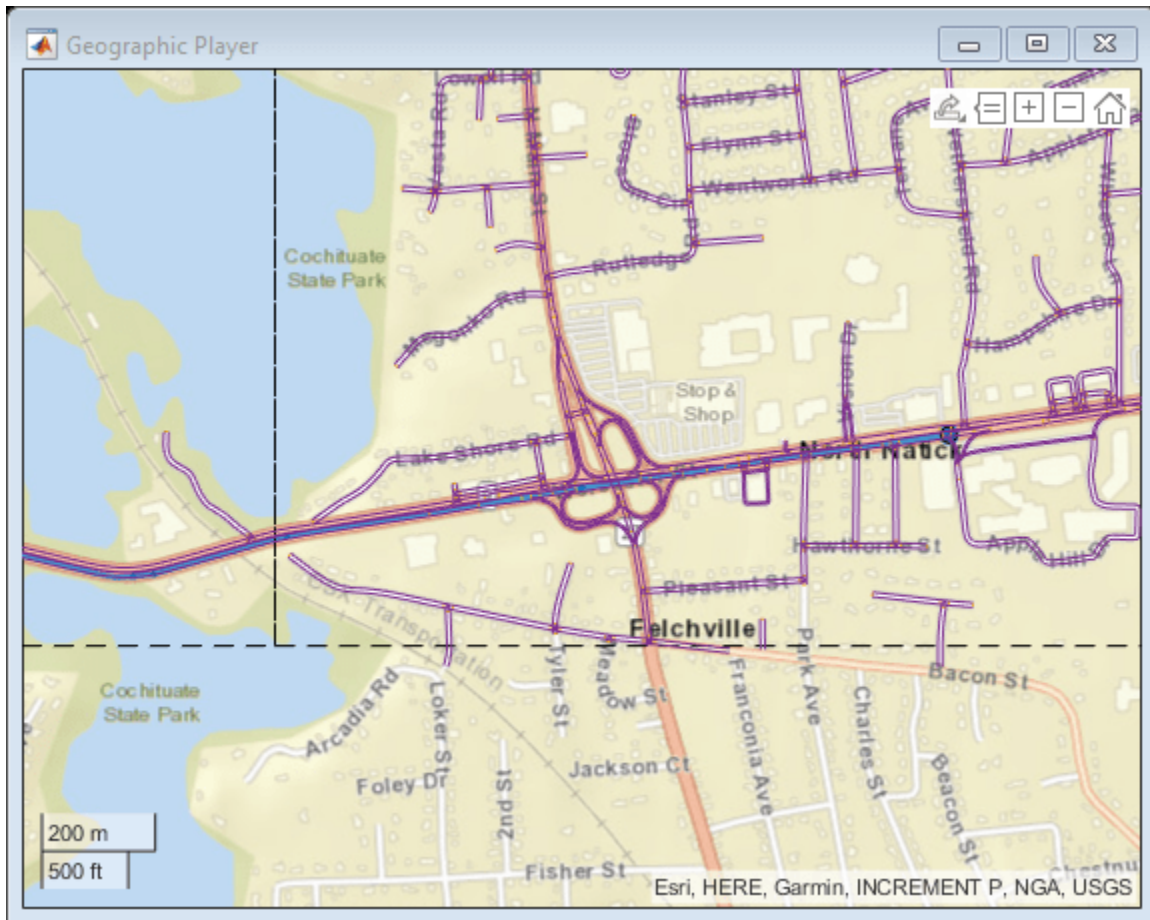

Plot 2-D Lane Geometry on Custom Basemap

Use the HERE HD Live Map (HERE HDLM) web service to read 3-D lane geometry data from a map tile. Then, plot the 2-D part of the data on an OpenStreetMap® basemap.

Create a HERE HDLM reader for a map tile ID representing an area of Berlin, Germany. If you have not previously set up HERE HDLM credentials, a dialog box prompts you to enter them.

```
tileID = uint32(377894435);
reader = hereHDLMReader(tileID);
```

Add the OpenStreetMap basemap to the list of basemaps available for use with the HERE HDLM service. After you add the basemap, you do not need to add it again in future sessions.

```
name = 'openstreetmap';
url = 'https://a.tile.openstreetmap.org/{z}/{x}/{y}.png';
copyright = char(uint8(169));
attribution = copyright + "OpenStreetMap contributors";
addCustomBasemap(name,url,'Attribution',attribution)
```

Read 3-D lane geometry data from the LaneGeometryPolyline layer of the map tile. Plot the 2-D part of the lane geometry on the openstreetmap basemap.

```
laneGeometryPolyline = read(reader, 'LaneGeometryPolyline');
gx = plot(laneGeometryPolyline);
geobasemap(gx, 'openstreetmap')
```

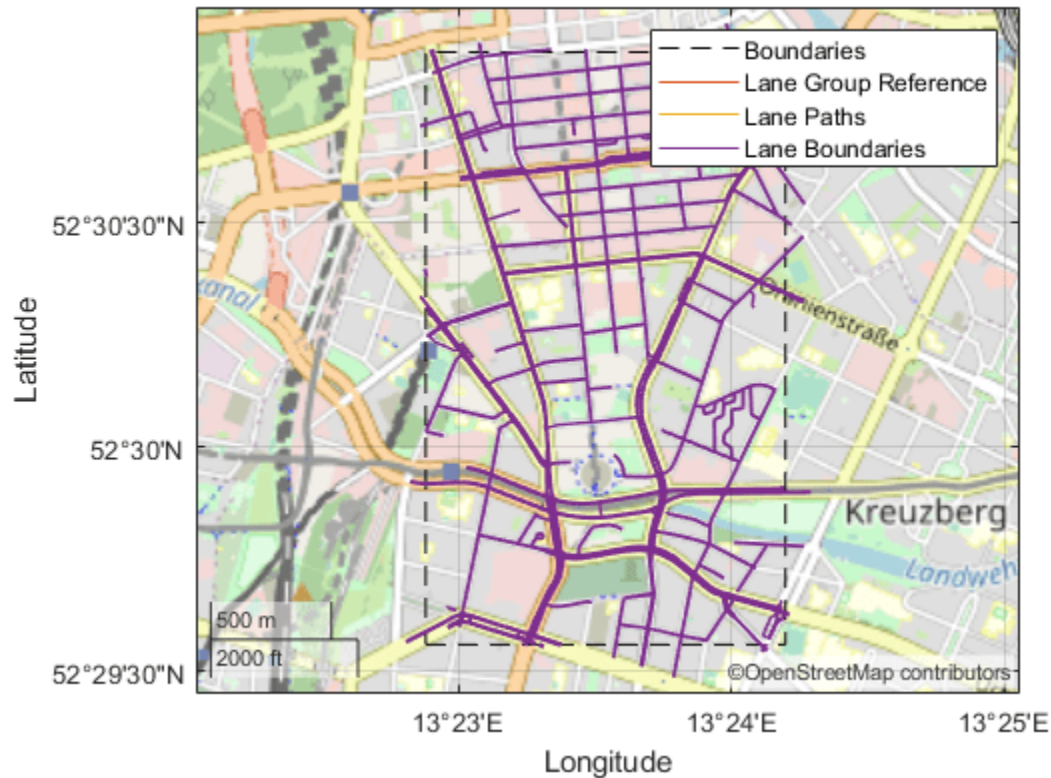

Zoom in on the central coordinate of the map tile.

```
latcenter = laneGeometryPolyline.TileCenterHere3dCoordinate.Here2dCoordinate(1);
loncenter = laneGeometryPolyline.TileCenterHere3dCoordinate.Here2dCoordinate(2);
```

```
offset = 0.001;
latlim = [latcenter-offset, latcenter+offset];
lonlim = [loncenter-offset, loncenter+offset];
```

```
geolimits(latlim, lonlim)
```

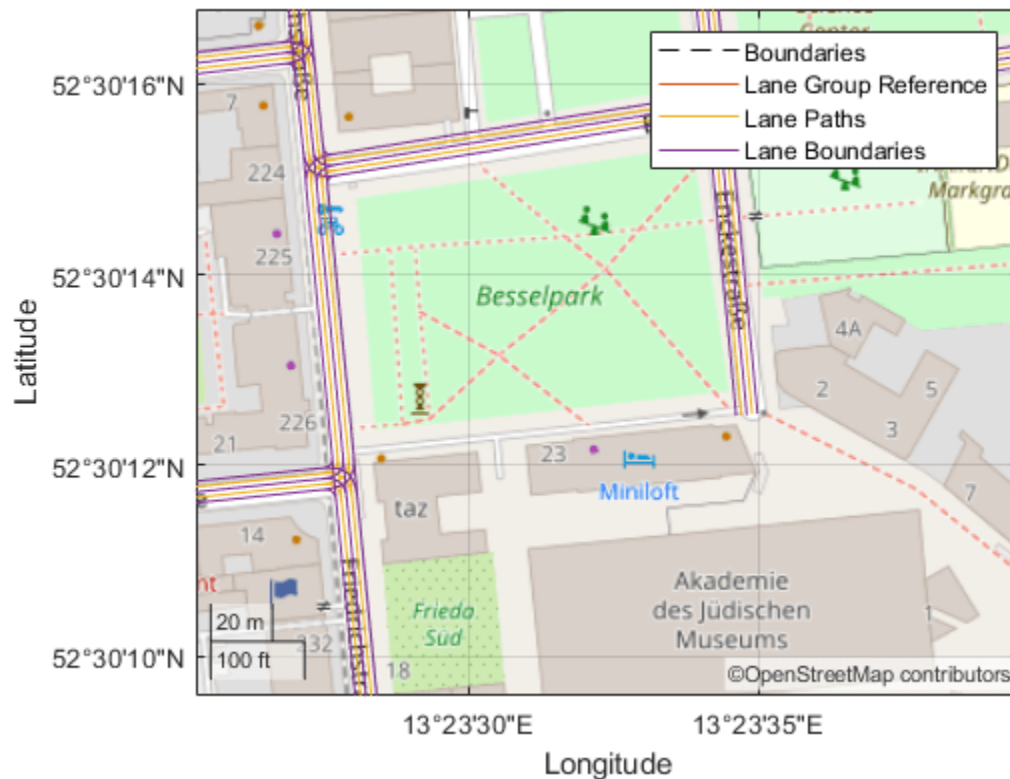

Find Shortest Path Between Two Nodes

Use the HERE HD Live Map (HERE HDLM) web service to read the topology geometry data from a map tile. Use this data to find the shortest path between two nodes within the map tile.

Define a HERE tile ID for an area of Stockholm, Sweden.

```
tileID = uint32(378373553);
```

Create a HERE HDLM reader for the tile ID. Configure the reader to search for the tile in only the Western Europe catalog. If you have not previously set up HERE HDLM credentials, a dialog box prompts you to enter them. The reader contains map data for the specified map tile.

```
config = hereHDLMConfiguration('hrn:here:data::olp-here-had:here-hdln-protobuf-weu-2');
reader = hereHDLMReader(tileID, 'Configuration', config);
```

Read the link definitions from the TopologyGeometry layer of the map tile. The returned layer object contains the specified LinksStartingInTile field and the required map tile fields, such as the tile ID. The other fields are empty. Your map data and catalog version might differ from the ones shown here.

```
topology = read(reader, 'TopologyGeometry', 'LinksStartingInTile')
```

```
topology =
  TopologyGeometry with properties:
```

```
Data:
    HereTileId: 378373553
    IntersectingLinkRefs: []
    LinksStartingInTile: [1249x1 struct]
    NodesInTile: []
    TileCenterHere2dCoordinate: [59.3372 18.0505]

Metadata:
    Catalog: 'hrn:here:data::olp-here-had:here-hdlm-protobuf-weu-2'
    CatalogVersion: 5597
```

Use plot to visualize TopologyGeometry data.

Find the start and end nodes for each link in the LinksStartingInTile field.

```
startNodes = [topology.LinksStartingInTile.StartNodeId];
endNodesRef = [topology.LinksStartingInTile.EndNodeRef];
endNodes = [endNodesRef.NodeId];
```

Find the length of each link in meters.

```
linkLengths = [topology.LinksStartingInTile.LinkLengthMeters];
```

Create an undirected graph for the links in the map tile.

```
G = graph(string(startNodes), string(endNodes), double(linkLengths));
H = plot(G, 'Layout', 'force');
title('Undirected Graph')
```

Undirected Graph

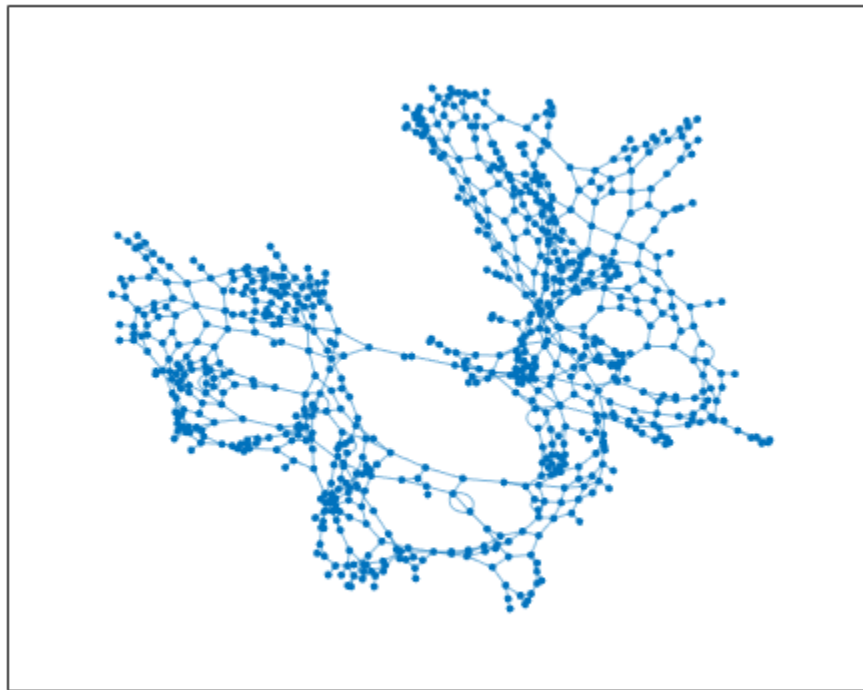

Specify a start and end node to find the shortest path between them. Use the first and last node in the graph as the start and end nodes, respectively. Overlay the nodes on the graph.

```
startNode = G.Nodes.Name(1);  
endNode = G.Nodes.Name(end);
```

```
highlight(H,[startNode endNode], 'NodeColor', 'red', 'MarkerSize', 6)  
title('Undirected Graph - Start and End Nodes')
```

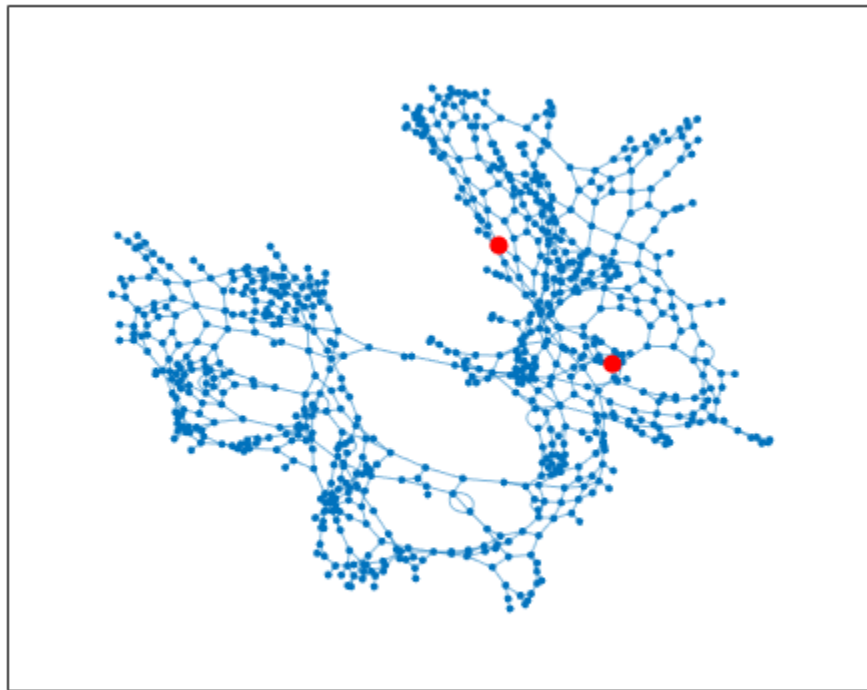
Undirected Graph - Start and End Nodes

Find the shortest path between the two nodes. Plot the path.

```
path = shortestpath(G,startNode,endNode);  
highlight(H,path,'EdgeColor','red','LineWidth',2);  
title('Undirected Graph - Shortest Path')
```

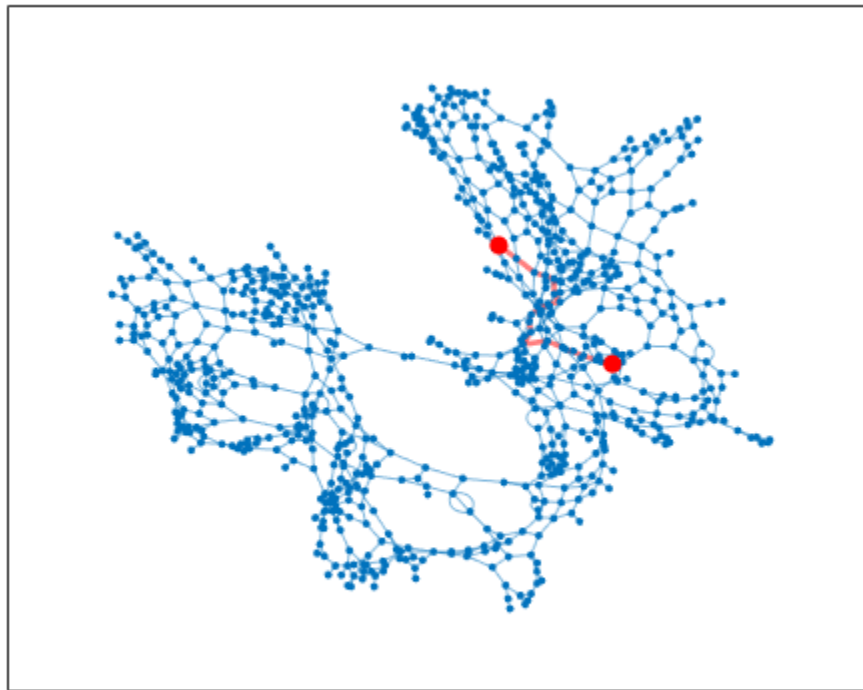
Undirected Graph - Shortest Path

Limitations

- The HERE HDLM web service determines the geographic coverage of the map data. Map data is not available for all locations.

Tips

- To speed up the performance of the reader, when creating the reader, specify a `hereHDLMConfiguration` object for the `Configuration` property. This object configures the reader to search for the selected map tiles only a specific HERE HD Live Map production catalog. If you do not specify a configuration object when you create the reader, the reader searches for the map tiles across all catalogs.
- To save HERE HDLM credentials between MATLAB sessions, select the corresponding option in the HERE HD Live Map Credentials dialog box. To manage HERE HDLM credentials, use the `hereHDLMcredentials` function.

Version History

Introduced in R2019a

See Also

`hereHDLMConfiguration` | `hereHDLMcredentials` | `geoplot` | `geoplayer`

Topics

“Read and Visualize HERE HD Live Map Data”

“HERE HD Live Map Layers”

“Use HERE HD Live Map Data to Verify Lane Configurations”

“Localization Correction Using Traffic Sign Data from HERE HD Maps”

read

Read HERE HD Live Map layer data

Syntax

```
layerData = read(reader, layerType)
layerData = read(reader, layerType, fields)
```

Description

`layerData = read(reader, layerType)` reads HERE HD Live Map ¹⁶ (HERE HDLM) data of a specified layer type from a `hereHDLMReader` object and returns an array of layer objects. These layer objects contain map layer data for the HERE map tiles whose IDs correspond to the IDs stored in the `TileIds` property of `reader`.

`layerData = read(reader, layerType, fields)` returns an array of layer objects containing data for only the required fields, such as the `HereTileId` field, and for the specified fields. All other fields in the returned layer objects are returned as empty: `[]`. If you do not require data from all fields within the layer objects, use this syntax to speed up performance of this function.

Examples

Plot and Stream Lane Topology Data from Driving Route

Use the HERE HD Live Map (HERE HDLM) service to read the lane topology data of a driving route and its surrounding area. Plot this data, and then stream the route on a geographic player.

Load the latitude and longitude coordinates of a driving route in Natick, Massachusetts, USA.

```
route = load('geoSequenceNatickMA.mat');
lat = route.latitude;
lon = route.longitude;
```

Stream the coordinates on a geographic player.

```
player = geoplayer(lat(1), lon(1), 'HistoryDepth', 5);
plotRoute(player, lat, lon)
```

```
for idx = 1:length(lat)
    plotPosition(player, lat(idx), lon(idx))
end
```

¹⁶ You need to enter into a separate agreement with HERE in order to gain access to the HDLM services and to get the required credentials (`access_key_id` and `access_key_secret`) for using the HERE Service.

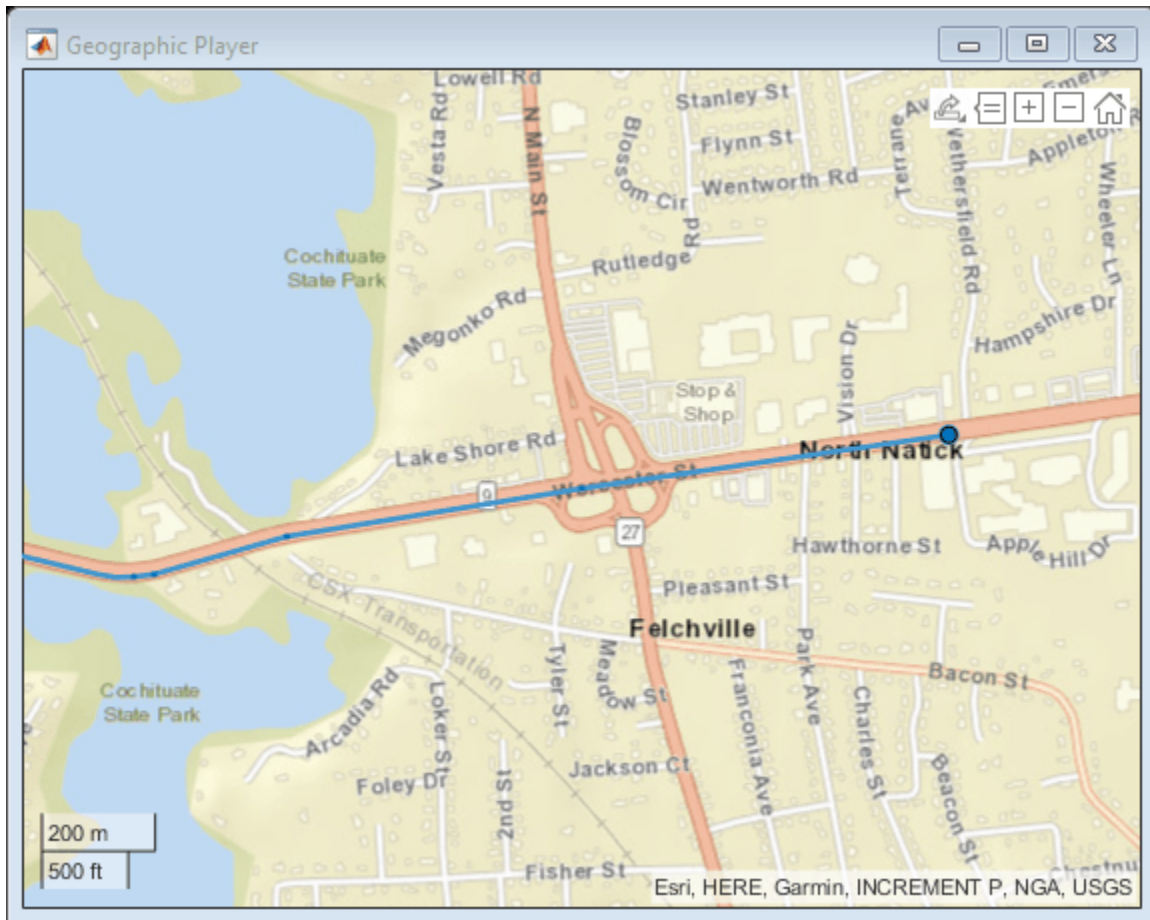

Create a HERE HDLM reader from the route coordinates. If you have not previously set up HERE HDLM credentials, a dialog box prompts you to enter them. The reader contains map data for the two map tiles that the route crosses.

```
reader = hereHDLMReader(lat,lon);
```

Read lane topology data from the LaneTopology layer of the map tiles. Plot the lane topology.

```
laneTopology = read(reader, 'LaneTopology');
plot(laneTopology)
```

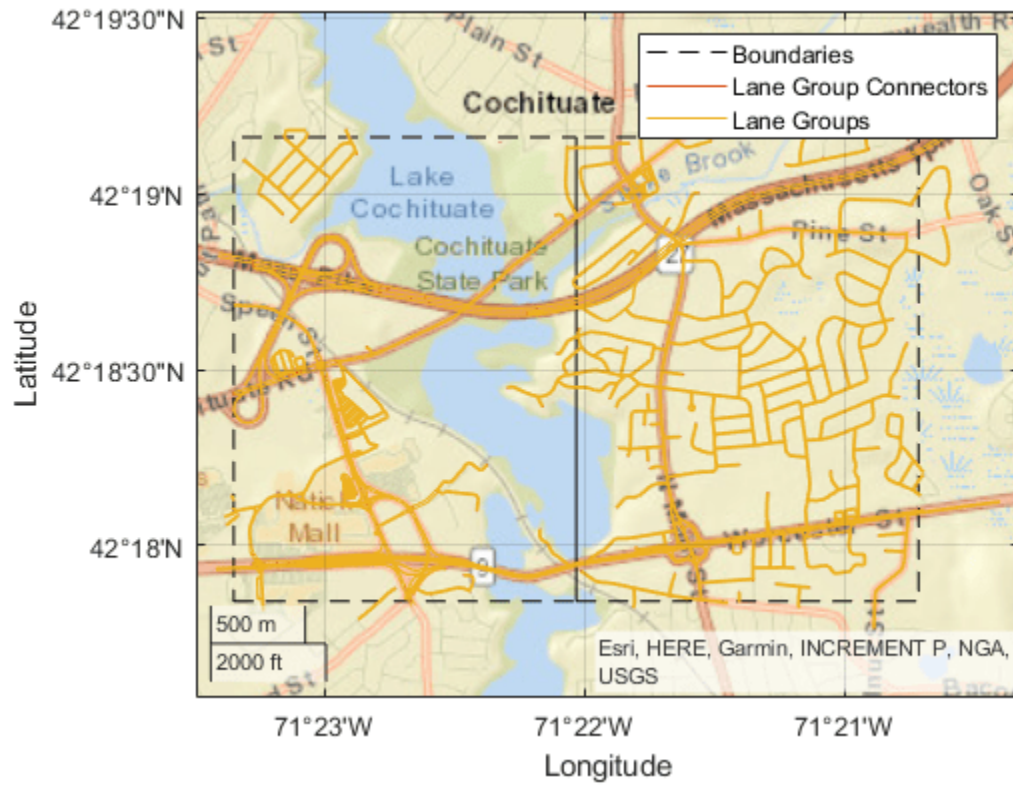

Overlay the route data on the plot.

```
hold on  
geoplot(lat,lon,'bo-','DisplayName','Route');  
hold off
```

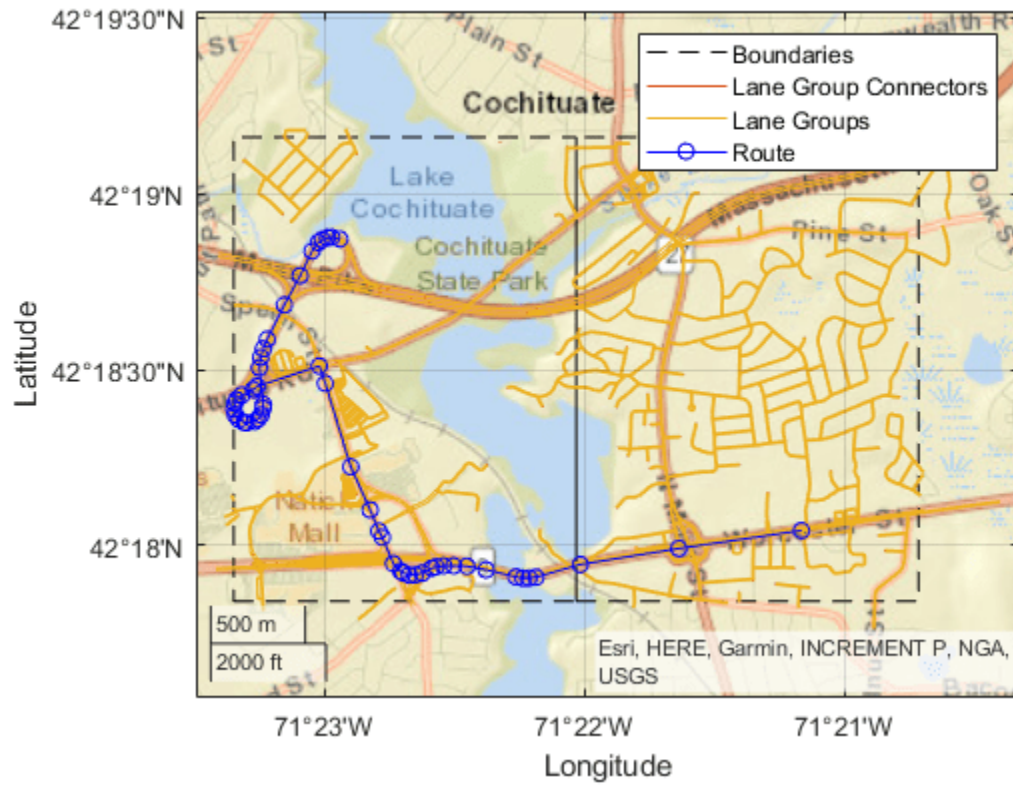

Overlay the lane topology data on the geographic player. Stream the route again.

```
plot(laneTopology, 'Axes', player.Axes)
for idx = 1:length(lat)
    plotPosition(player, lat(idx), lon(idx))
end
```

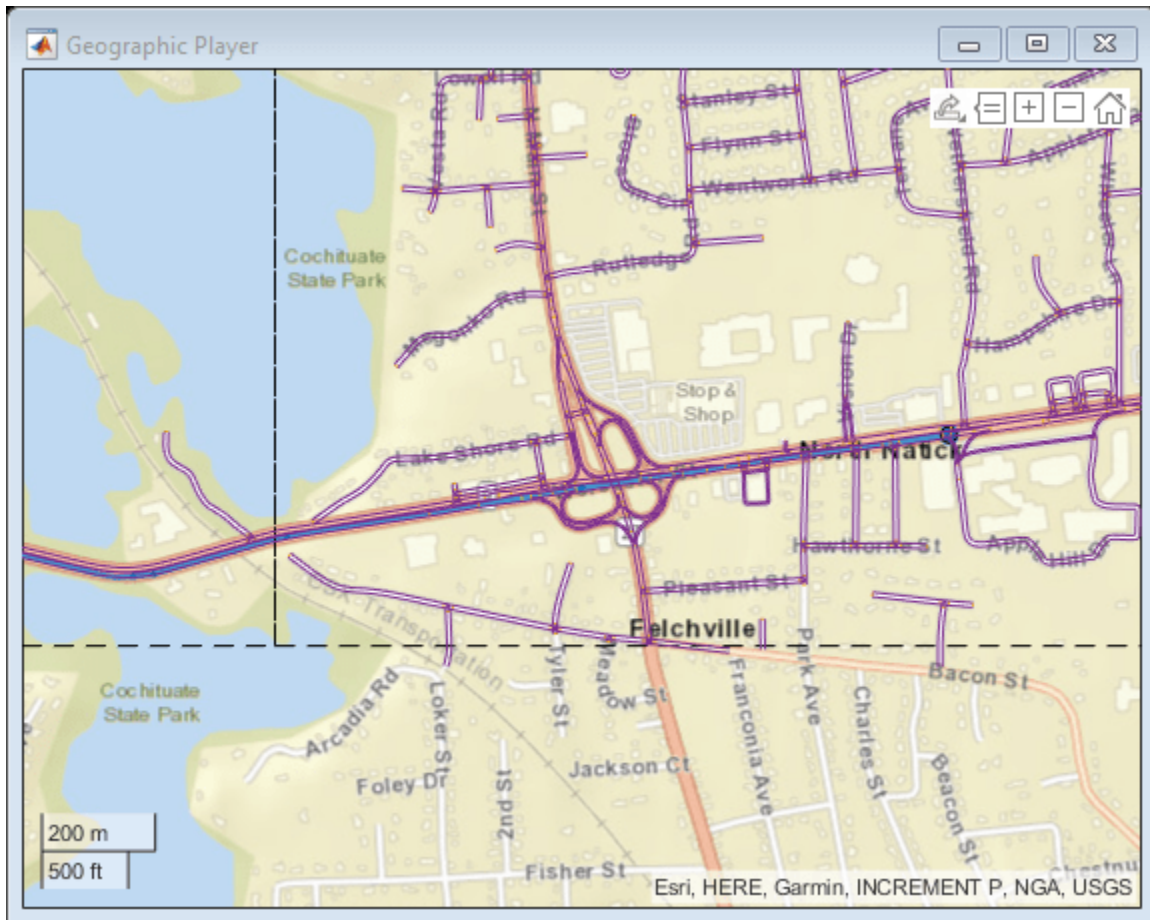

Find Shortest Path Between Two Nodes

Use the HERE HD Live Map (HERE HDLM) web service to read the topology geometry data from a map tile. Use this data to find the shortest path between two nodes within the map tile.

Define a HERE tile ID for an area of Stockholm, Sweden.

```
tileID = uint32(378373553);
```

Create a HERE HDLM reader for the tile ID. Configure the reader to search for the tile in only the Western Europe catalog. If you have not previously set up HERE HDLM credentials, a dialog box prompts you to enter them. The reader contains map data for the specified map tile.

```
config = hereHDLMConfiguration('hrn:here:data::olp-here-had:here-hdln-protobuf-weu-2');
reader = hereHDLMReader(tileID, 'Configuration', config);
```

Read the link definitions from the TopologyGeometry layer of the map tile. The returned layer object contains the specified LinksStartingInTile field and the required map tile fields, such as the tile ID. The other fields are empty. Your map data and catalog version might differ from the ones shown here.

```
topology = read(reader, 'TopologyGeometry', 'LinksStartingInTile')
```

```
topology =  
  TopologyGeometry with properties:  
  
  Data:  
      HereTileId: 378373553  
      IntersectingLinkRefs: []  
      LinksStartingInTile: [1249x1 struct]  
      NodesInTile: []  
      TileCenterHere2dCoordinate: [59.3372 18.0505]  
  
  Metadata:  
      Catalog: 'hrn:here:data::olp-here-had:here-hdlm-protobuf-weu-2'  
      CatalogVersion: 5597
```

Use `plot` to visualize `TopologyGeometry` data.

Find the start and end nodes for each link in the `LinksStartingInTile` field.

```
startNodes = [topology.LinksStartingInTile.StartNodeId];  
endNodesRef = [topology.LinksStartingInTile.EndNodeRef];  
endNodes = [endNodesRef.NodeId];
```

Find the length of each link in meters.

```
linkLengths = [topology.LinksStartingInTile.LinkLengthMeters];
```

Create an undirected graph for the links in the map tile.

```
G = graph(string(startNodes), string(endNodes), double(linkLengths));  
H = plot(G, 'Layout', 'force');  
title('Undirected Graph')
```

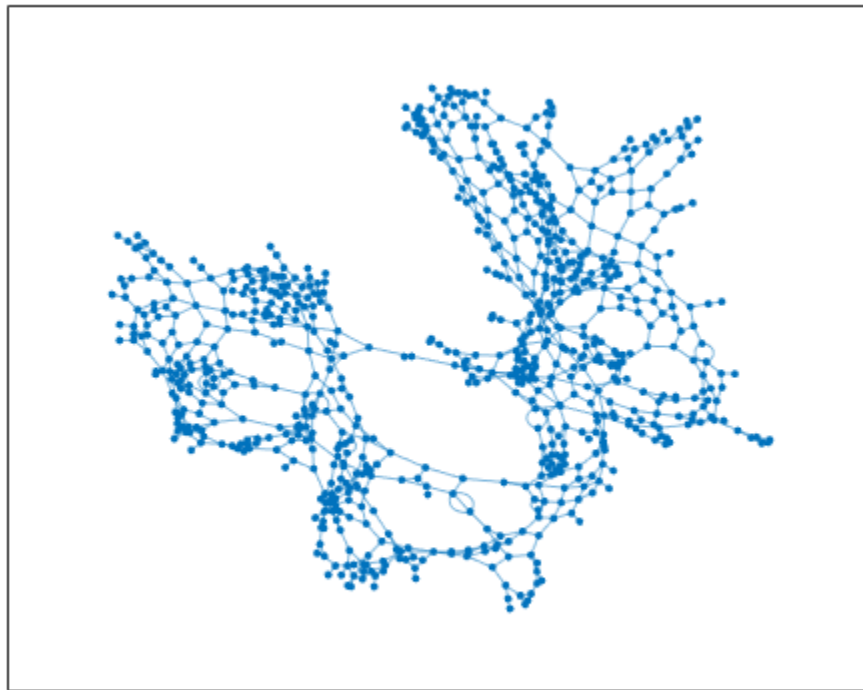

Undirected Graph



Specify a start and end node to find the shortest path between them. Use the first and last node in the graph as the start and end nodes, respectively. Overlay the nodes on the graph.

```
startNode = G.Nodes.Name(1);  
endNode = G.Nodes.Name(end);
```

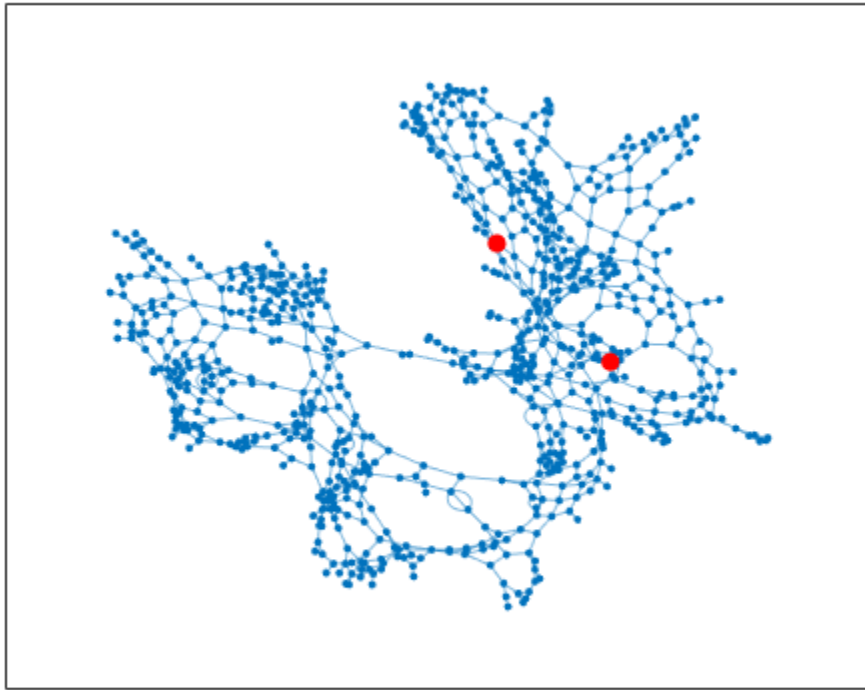
```
highlight(H,[startNode endNode], 'NodeColor', 'red', 'MarkerSize', 6)  
title('Undirected Graph - Start and End Nodes')
```

Undirected Graph - Start and End Nodes

Find the shortest path between the two nodes. Plot the path.

```
path = shortestpath(G,startNode,endNode);  
highlight(H,path,'EdgeColor','red','LineWidth',2);  
title('Undirected Graph - Shortest Path')
```

Undirected Graph - Shortest Path

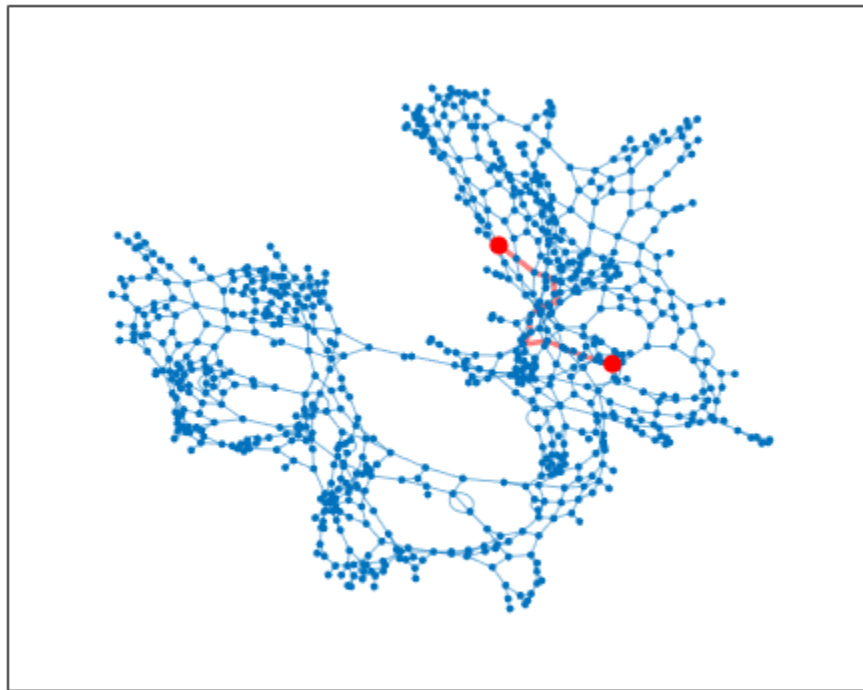

Input Arguments

reader — Input HERE HDLM reader

hereHDLMReader object

Input HERE HDLM reader, specified as a hereHDLMReader object.

layerType — Layer type

string scalar | character vector

Layer type from which to read data, specified as a string scalar or character vector. `layerType` must be a valid layer type for the map tiles stored in `reader`. To see the list of valid layers, use the `Layers` property of `reader`.

Example: "AdasAttributes"

Example: 'LaneTopology'

fields — Layer object fields

string scalar | character vector | string array | cell array of character vectors

Layer object fields from which to read data, specified as a string scalar, character vector, string array, or cell array of character vectors. All fields must be valid fields of the layer specified by `layerType`. You can specify only the top-level fields of this layer. You cannot specify its metadata fields.

In the returned array of layer objects, only required fields, such as the `HereTileId` field, and the specified fields contain data. All other fields are returned as empty: `[]`.

For a list of the valid top-level data fields for each layer type, see the `data output` argument.

Example: `'LinkAttribution'`

Example: `"NodeAttribution"`

Example: `["LinkAttribution" "NodeAttribution"]`

Example: `{'LinkAttribution','NodeAttribution'}`

Output Arguments

layerData — HERE HDLM layer data

T-by-1 array of layer objects

HERE HDLM layer data, returned as a *T*-by-1 array of layer objects. *T* is the number of map tile IDs stored in the `TileIds` property of the specified reader. Each layer object contains map data that is of type `layerType` for a HERE map tile that was read from `reader`. Such data can include:

- The geometry of links (streets) and nodes (intersections and dead ends) within map tiles
- Various road-level and lane-level attributes
- Landmark-based localization information, such as the barriers, signs, and poles along a road

The layer objects also contain metadata specifying the catalog name and catalog version from which the `read` function obtained the data.

The properties of the layer objects correspond to valid HERE HDLM layer fields. In these layer objects, the names of the layer fields are modified to fit the MATLAB naming convention for object properties. For each layer field name, the first letter and first letter after each underscore are capitalized and the underscores are removed. This table shows sample name changes.

HERE HDLM Layer Fields	MATLAB Layer Object Property
<code>here_tile_id</code>	<code>HereTileId</code>
<code>tile_center_here_2d_coordinate</code>	<code>TileCenterHere2dCoordinate</code>
<code>nodes_in_tile</code>	<code>NodesInTile</code>

The layer objects are MATLAB structures whose properties correspond to structure fields. To access data from these fields, use dot notation.

For example, this code selects the `NodeId` subfield from the `NodeAttribution` field of a layer:

```
layerData.NodeAttribution.NodeId
```

This table summarizes the valid types of layer objects and their top-level data fields. The available layers are for the Road Centerline Model, HD Lane Model, and HD Localization Model. For an overview of HERE HDLM layers and the models that they belong to, see “HERE HD Live Map Layers”.

Layer Object	Description	Top-Level Data Fields (Layer Object Properties)	Plot Support
AdasAttributes	Precision geometry measurements, such as slope, elevation, and curvature of roads. Use this data to develop advanced driver assistance systems (ADAS).	<ul style="list-style-type: none"> • HereTileId • LinkAttribution • NodeAttribution 	Not available
ExternalReferenceAttributes	References to external map links, nodes, and topologies for other HERE maps.	<ul style="list-style-type: none"> • HereTileId • LinkAttribution • NodeAttribution 	Not available
LaneAttributes	Lane-level attributes, such as direction of travel and lane type.	<ul style="list-style-type: none"> • HereTileId • LaneGroupAttribution 	Not available
LaneGeometryPolyline	3-D lane geometry composed of a set of 3-D points joined into polylines.	<ul style="list-style-type: none"> • HereTileId • TileCenterHere3dCoordinate • LaneGroupGeometries 	Available — Use the plot function. 
LaneRoadReferences	Road and lane group references and range information. Use this data to translate positions between the Road Centerline Model and the HD Lane Model.	<ul style="list-style-type: none"> • HereTileId • LaneGroupLinkReferences • LinkLaneGroupReferences 	Not available

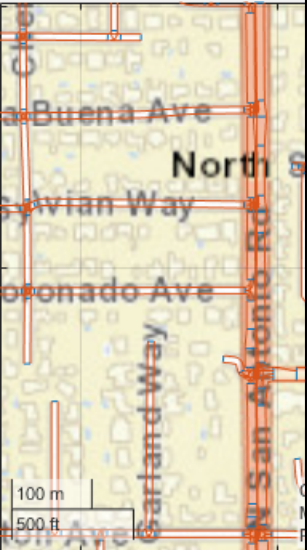
Layer Object	Description	Top-Level Data Fields (Layer Object Properties)	Plot Support
LaneTopology	Topologies of the HD Lane model, including lane group, lane group connector, lane, and lane connector topologies. This layer also contains the simplified 2-D boundary geometry of the lane model for determining map tile affinity and overflow.	<ul style="list-style-type: none"> • HereTileId • TileCenterHere2d Coordinate • LaneGroupsStartingInTile • LaneGroupConnectorsInTile • IntersectingLaneGroupRefs 	<p>Available — Use the plot function.</p>  <p>The image is a map snippet showing lane topologies. It features several roads: Buena Ave, North Star, Avian Way, Coronado Ave, and San Antonio Rd. A legend in the top right corner shows different line styles for boundaries and lanes. A scale bar at the bottom left indicates 100 meters and 500 feet. Text at the bottom right identifies the County of Santa Clara and mentions Esri, NGA, and USGS.</p>
LocalizationBarrier	Positions, dimensions, and attributes of barriers such as guardrails and Jersey barriers found along roads	<ul style="list-style-type: none"> • HereTileId • TileCenterHere3d Coordinate • Barriers • RoadToBarriersReferences • IntersectingBarrierRefs 	Not available
LocalizationPole	Positions, dimensions, and attributes of traffic signal poles and other poles found along or hanging over roads	<ul style="list-style-type: none"> • HereTileId • TileCenterHere3d Coordinate • Poles • RoadToPolesReferences 	Not available
LocalizationSign	Positions, dimensions, and attributes of traffic-sign faces found along roads	<ul style="list-style-type: none"> • HereTileId • TileCenterHere3d Coordinate • Signs • RoadToSignsReferences 	Not available

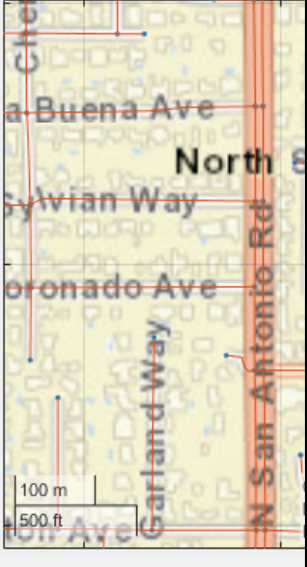
Layer Object	Description	Top-Level Data Fields (Layer Object Properties)	Plot Support
RoutingAttributes	Road attributes related to navigation and conditions. These attributes are mapped parametrically to the 2-D polyline geometry in the topology layer.	<ul style="list-style-type: none"> • HereTileId • LinkAttribution • NodeAttribution • StrandAttribution • AttributionGroup List 	Not available
RoutingLaneAttributes	Core navigation lane attributes and conditions, such as the number of lanes in a road. These values are mapped parametrically to 2-D polylines along the road links.	<ul style="list-style-type: none"> • HereTileId • LinkAttribution 	Not available
SpeedAttributes	Speed-related road attributes, such as speed limits. These attributes are mapped to the 2-D polyline geometry of the topology layer.	<ul style="list-style-type: none"> • HereTileId • LinkAttribution 	Not available
TopologyGeometry	Topology and 2-D line geometry of the road. This layer also contains definitions of the nodes and links in the map tile.	<ul style="list-style-type: none"> • HereTileId • TileCenterHere2d Coordinate • NodesInTile • LinksStartingInTile • IntersectingLink Refs 	Available — Use the plot function. 

Version History

Introduced in R2019a

See Also

[hereHDLMCredentials](#) | [hereHDLMConfiguration](#) | [plot](#) | [hereHDLMReader](#)

Topics

“Read and Visualize HERE HD Live Map Data”

“HERE HD Live Map Layers”

“Use HERE HD Live Map Data to Verify Lane Configurations”

plot

Package: `driving.heremaps`

Plot HERE HD Live Map layer data

Syntax

```
plot(layerData)
plot(layerData, 'Axes', gxIn)
gxOut = plot( ___ )
```

Description

`plot(layerData)` plots HERE HD Live Map ¹⁷ (HERE HDLM) layer data on a geographic axes. `layerData` is a map layer object that was read from the selected tiles of a `hereHDLMReader` object by using the `read` function.

`plot(layerData, 'Axes', gxIn)` plots the layer data in the specified geographic axes, `gxIn`.

`gxOut = plot(___)` plots the layer data and returns the geographic axes on which the data was plotted, using the inputs from any of the preceding syntaxes. Use `gxOut` to modify properties of the geographic axes.

Examples

Plot Road Topology Data from Driving Route

Load a sequence of latitude and longitude coordinates from a driving route.

```
data = load('geoSequence.mat')

data = struct with fields:
    latitude: [1000x1 double]
    longitude: [1000x1 double]
```

Create a HERE HD Live Map (HERE HDLM) reader from the specified coordinates. If you have not previously set up HERE HDLM credentials, a dialog box prompts you to enter them. The reader contains layered map data for the tile that the driving route is on.

```
reader = hereHDLMReader(data.latitude,data.longitude);
```

Read road topology data from the `TopologyGeometry` layer. Plot the data.

```
roadTopology = read(reader, 'TopologyGeometry');
plot(roadTopology)
legend('Location', 'northeastoutside')
```

¹⁷ You need to enter into a separate agreement with HERE in order to gain access to the HDLM services and to get the required credentials (`access_key_id` and `access_key_secret`) for using the HERE Service.

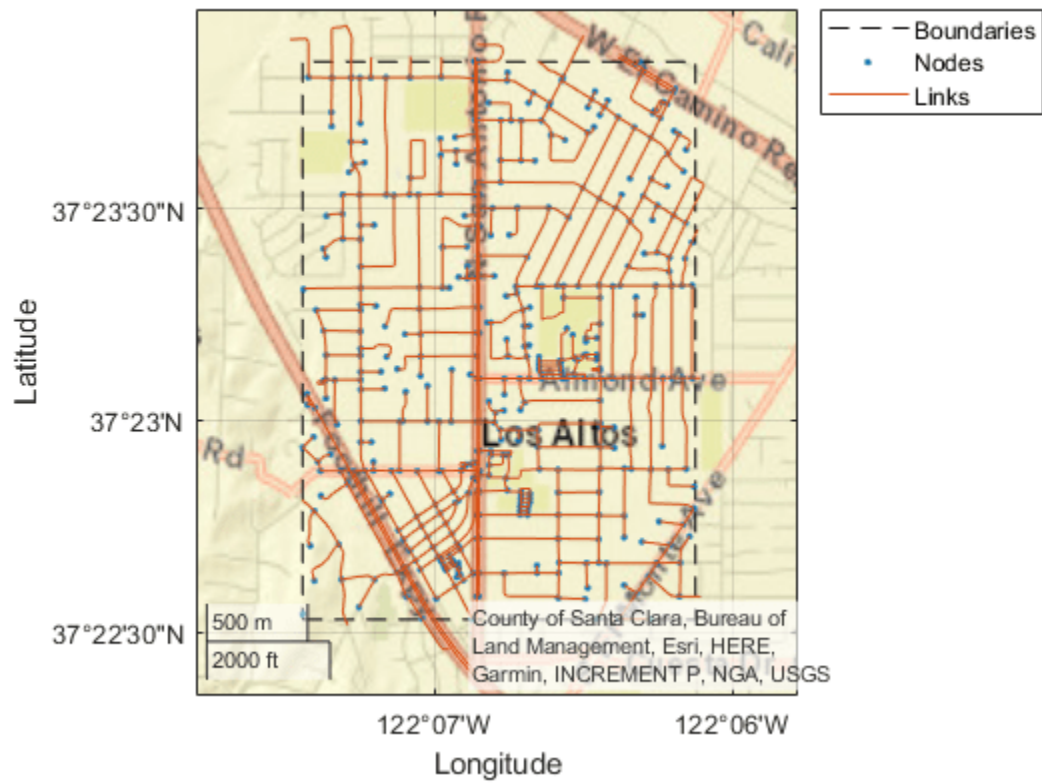

Overlay the driving route coordinates on the plot.

```
hold on
geoplot(data.latitude,data.longitude,'bo-', 'DisplayName', 'Route')
hold off
```

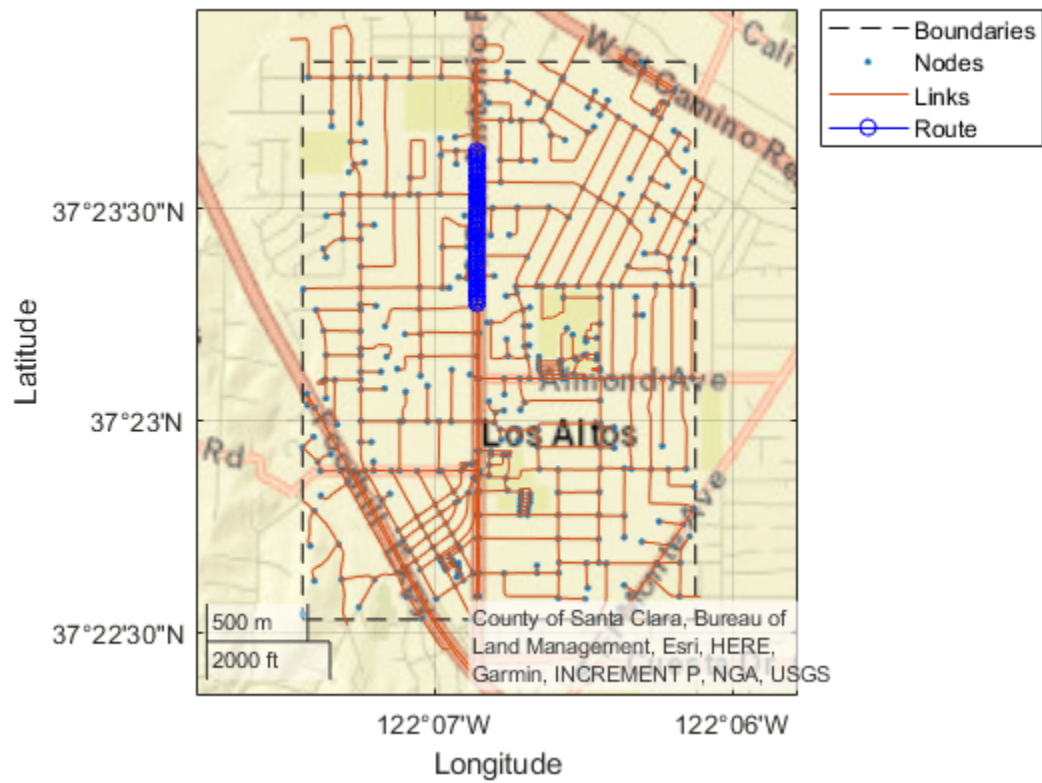

Zoom in on the route.

```
latcenter = median(data.latitude);  
loncenter = median(data.longitude);
```

```
offset = 0.005;  
latlim = [latcenter-offset, latcenter+offset];  
lonlim = [loncenter-offset, loncenter+offset];
```

```
geolimits(latlim, lonlim)
```

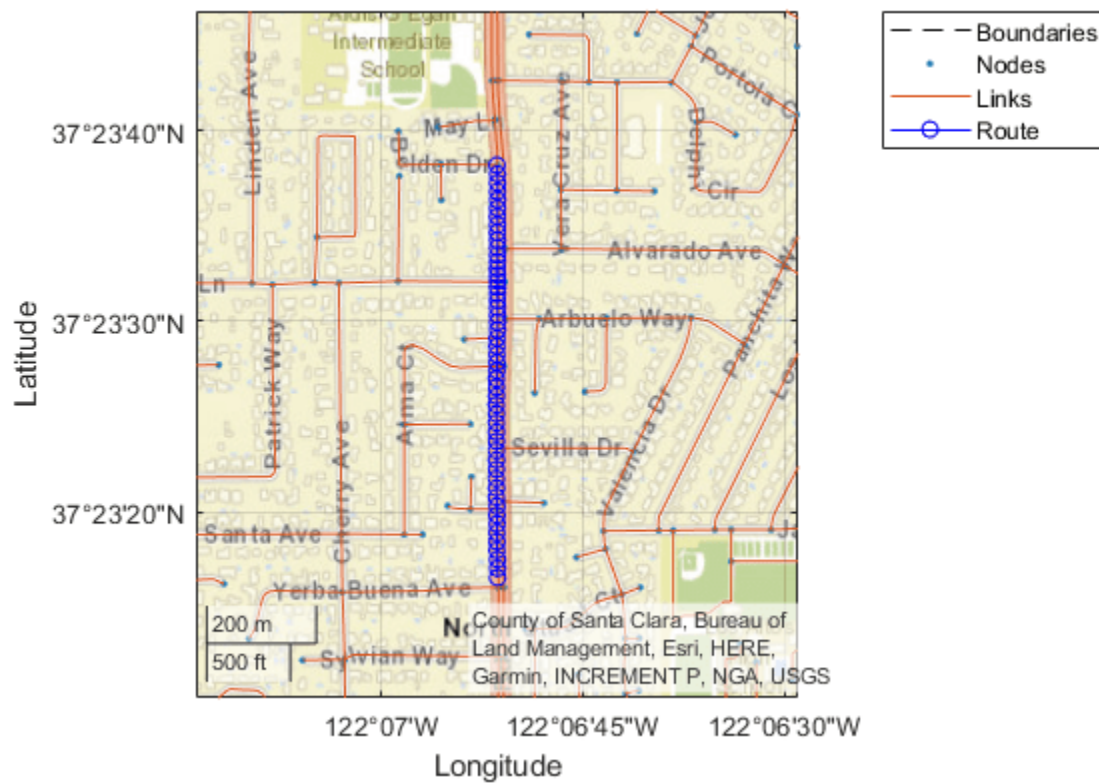

Plot and Stream Lane Topology Data from Driving Route

Use the HERE HD Live Map (HERE HDLM) service to read the lane topology data of a driving route and its surrounding area. Plot this data, and then stream the route on a geographic player.

Load the latitude and longitude coordinates of a driving route in Natick, Massachusetts, USA.

```
route = load('geoSequenceNatickMA.mat');
lat = route.latitude;
lon = route.longitude;
```

Stream the coordinates on a geographic player.

```
player = geoplayer(lat(1),lon(1), 'HistoryDepth',5);
plotRoute(player,lat,lon)
```

```
for idx = 1:length(lat)
    plotPosition(player,lat(idx),lon(idx))
end
```

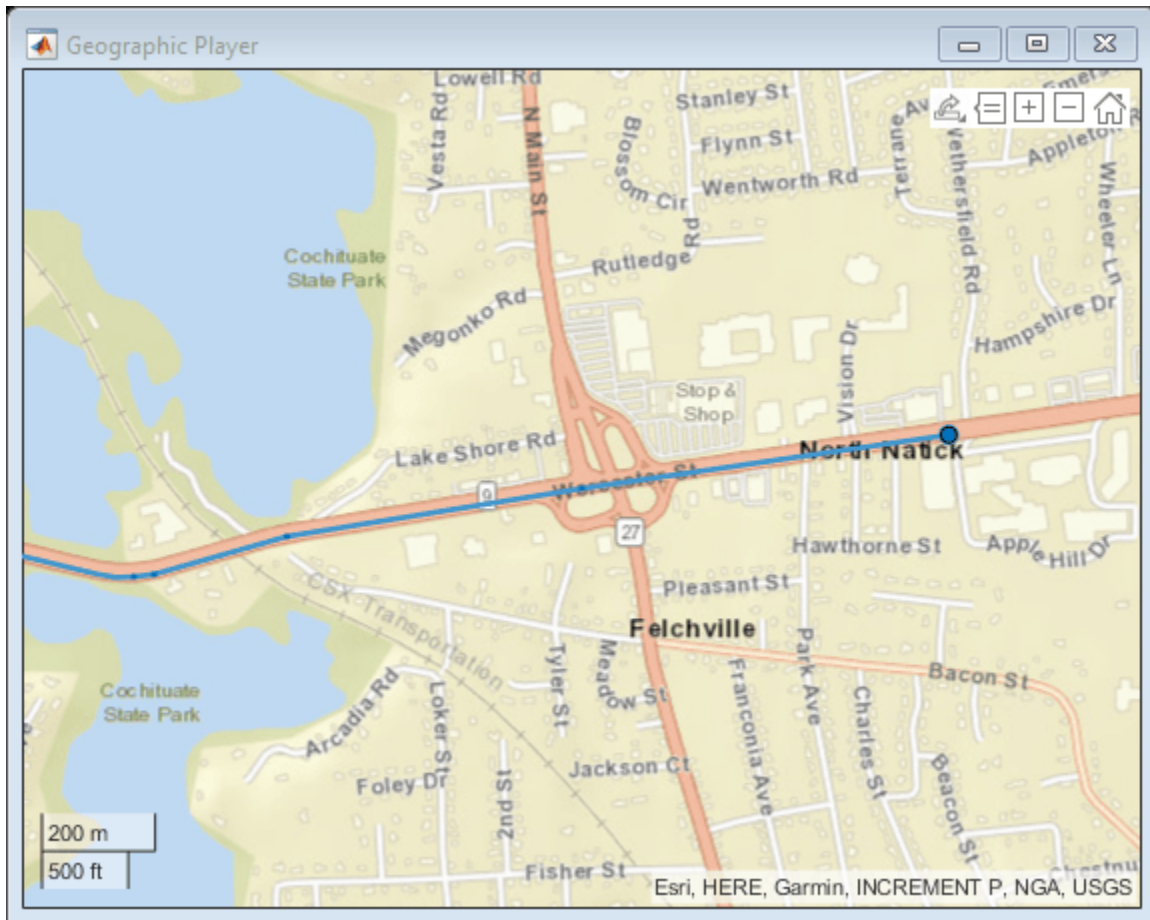

Create a HERE HDLM reader from the route coordinates. If you have not previously set up HERE HDLM credentials, a dialog box prompts you to enter them. The reader contains map data for the two map tiles that the route crosses.

```
reader = hereHDLMReader(lat,lon);
```

Read lane topology data from the LaneTopology layer of the map tiles. Plot the lane topology.

```
laneTopology = read(reader, 'LaneTopology');
plot(laneTopology)
```

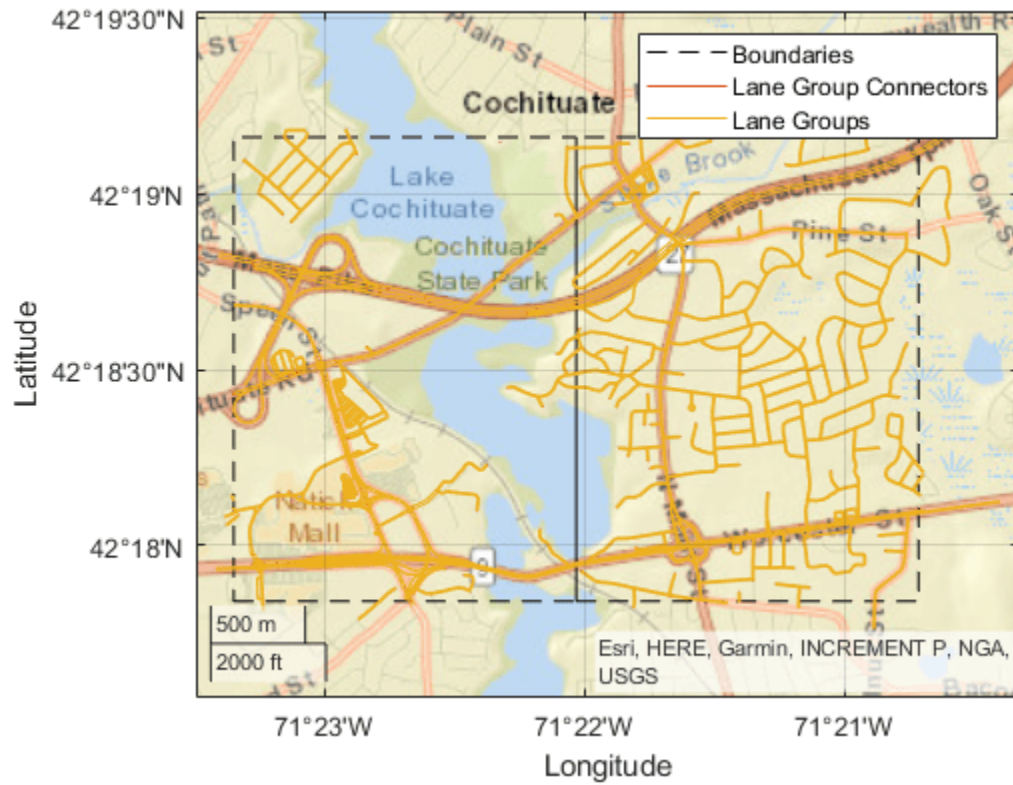

Overlay the route data on the plot.

```
hold on  
geoplot(lat,lon,'bo-','DisplayName','Route');  
hold off
```

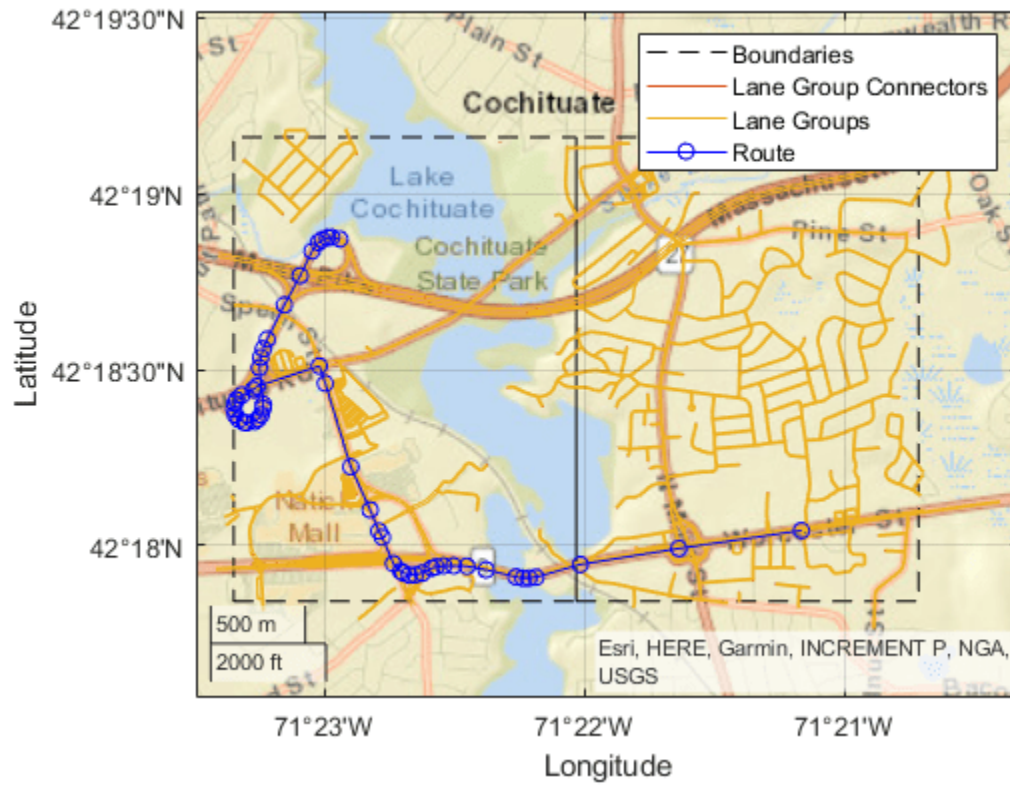
Overlay the lane topology data on the geographic player. Stream the route again.

```
plot(laneTopology, 'Axes', player.Axes)
for idx = 1:length(lat)
    plotPosition(player, lat(idx), lon(idx))
end
```

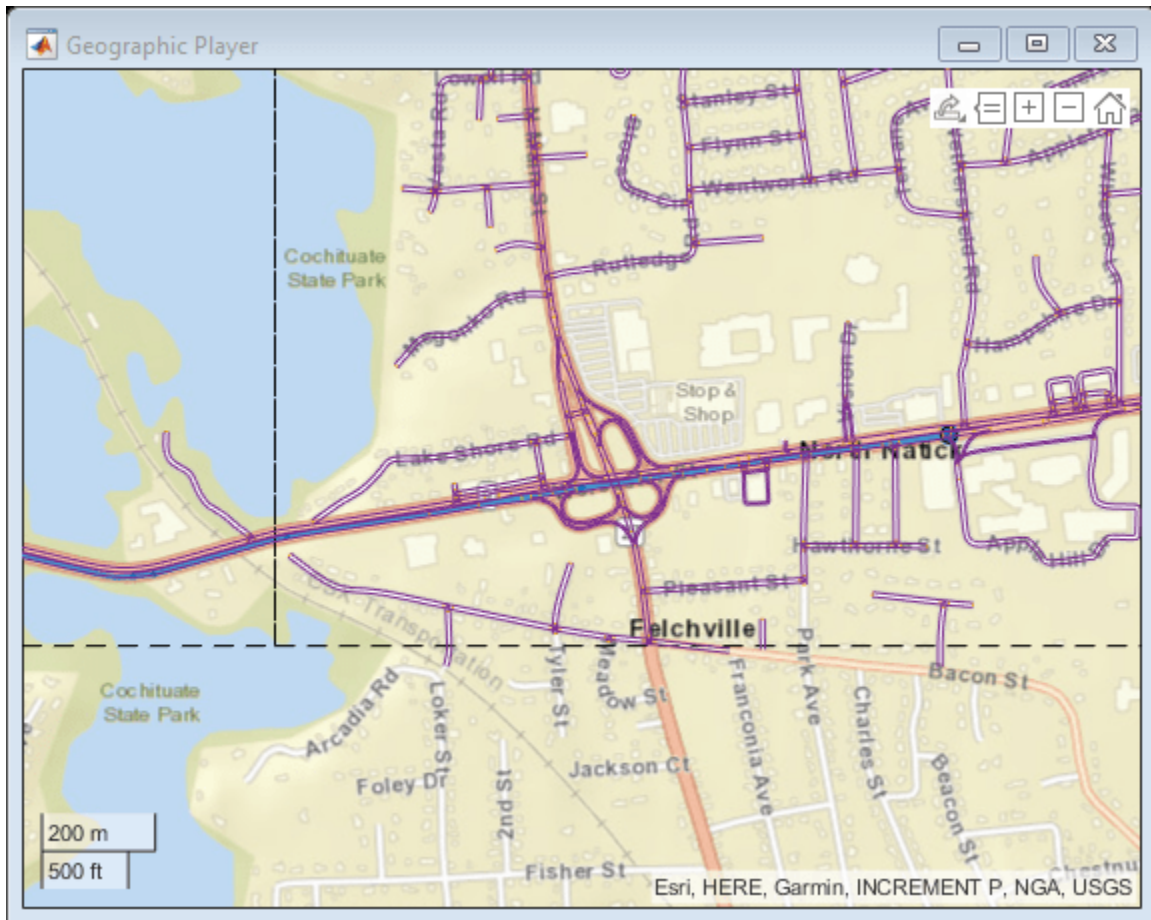

Plot 2-D Lane Geometry on Custom Basemap

Use the HERE HD Live Map (HERE HDLM) web service to read 3-D lane geometry data from a map tile. Then, plot the 2-D part of the data on an OpenStreetMap® basemap.

Create a HERE HDLM reader for a map tile ID representing an area of Berlin, Germany. If you have not previously set up HERE HDLM credentials, a dialog box prompts you to enter them.

```
tileID = uint32(377894435);
reader = hereHDLMReader(tileID);
```

Add the OpenStreetMap basemap to the list of basemaps available for use with the HERE HDLM service. After you add the basemap, you do not need to add it again in future sessions.

```
name = 'openstreetmap';
url = 'https://a.tile.openstreetmap.org/{z}/{x}/{y}.png';
copyright = char(uint8(169));
attribution = copyright + "OpenStreetMap contributors";
addCustomBasemap(name,url,'Attribution',attribution)
```

Read 3-D lane geometry data from the LaneGeometryPolyline layer of the map tile. Plot the 2-D part of the lane geometry on the openstreetmap basemap.

```
laneGeometryPolyline = read(reader, 'LaneGeometryPolyline');
gx = plot(laneGeometryPolyline);
geobasemap(gx, 'openstreetmap')
```

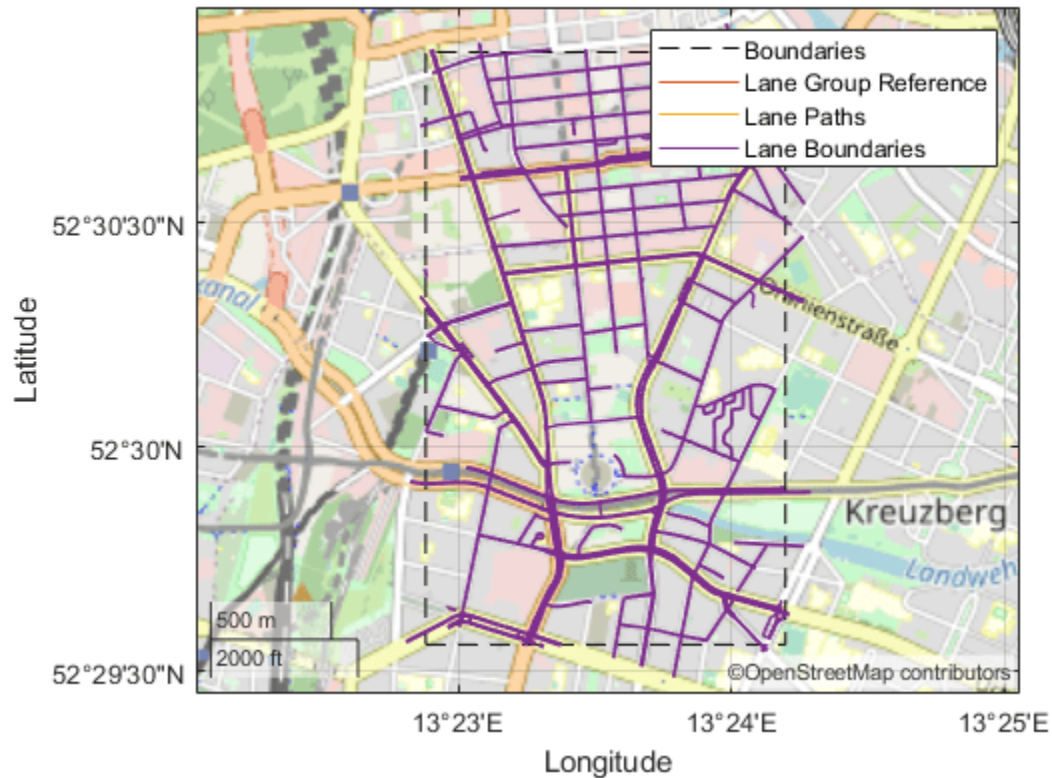

Zoom in on the central coordinate of the map tile.

```
latcenter = laneGeometryPolyline.TileCenterHere3dCoordinate.Here2dCoordinate(1);
loncenter = laneGeometryPolyline.TileCenterHere3dCoordinate.Here2dCoordinate(2);
```

```
offset = 0.001;
latlim = [latcenter-offset, latcenter+offset];
lonlim = [loncenter-offset, loncenter+offset];
```

```
geolimits(latlim, lonlim)
```

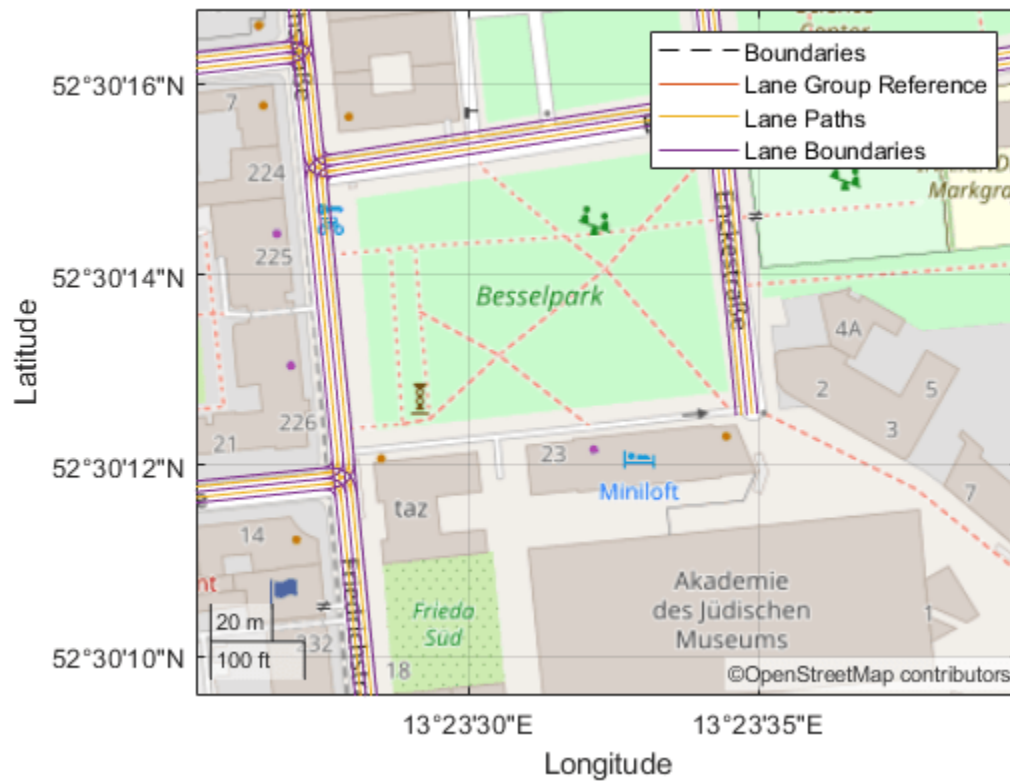
Set Default Basemap for Plots Created from Layer Data

Since R2023a

Set the default basemap for plots created from HERE HD Live Map layer data.

Add HERE Basemap

Add a basemap from HERE to the list of basemaps available for use with mapping functions. To add a HERE basemap, you must have a valid license from HERE.

Specify the basemap name and map URL.

```
name = "herestreets";
url = "https://1.base.maps.ls.hereapi.com/maptile/2.1/maptile/" + ...
    "newest/normal.day/{z}/{x}/{y}/256/png?apikey=%s";
```

Create a dialog box. In the dialog box, enter the Access Key ID corresponding to your HERE license.

```
prompt = "HERE Access Key ID:";
title = "HERE Tokens";
dims = [1 40]; % Text edit field height and width
hereTokens = inputdlg(prompt,title,dims);
```

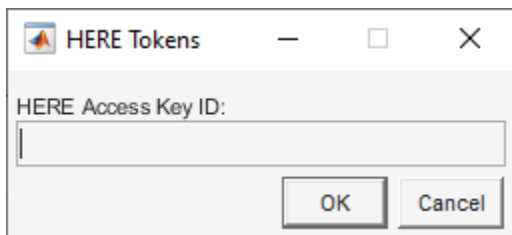

Add the basemap using the map URL, the Access Key ID, and a custom attribution. After you add the basemap, you do not need to add it again in future sessions.

```
url = sprintf(url,hereTokens{1});
copyrightSymbol = char(169); % Alt code
yr = string(datetime("today",Format="yyyy"));
attribution = copyrightSymbol + yr + " HERE";
addCustomBasemap(name,url,"Attribution",attribution)
```

Specify Basemap as Default Basemap

MATLAB® stores the default basemap for plots created from HERE HD Live Map layer data in the MATLAB settings tree. Set the personal value for the default basemap to the HERE basemap. The personal value persists across MATLAB sessions for an individual user.

```
s = settings;
s.driving.heremaps.Basemap.PersonalValue = "herestreets";
```

Plot Data

Load a sequence of latitude and longitude coordinates from a driving route in Natick, Massachusetts, USA.

```
route = load("geoSequenceNatickMA.mat");
lat = route.latitude;
lon = route.longitude;
```

Create a HERE HD Live Map reader from the route coordinates. If you have not previously set up HERE HD Live Map credentials, a dialog box prompts you to enter them. The reader contains map data for the two map tiles that the route crosses.

```
reader = hereHDLMReader(lat,lon);
```

Read 3-D lane geometry data from the LaneGeometryPolyline layer of the map tile. Plot the 2-D part of the lane geometry on a geographic axes. Note that the geographic axes uses the HERE basemap.

```
laneGeometryPolyline = read(reader,"LaneGeometryPolyline");
plot(laneGeometryPolyline)
```

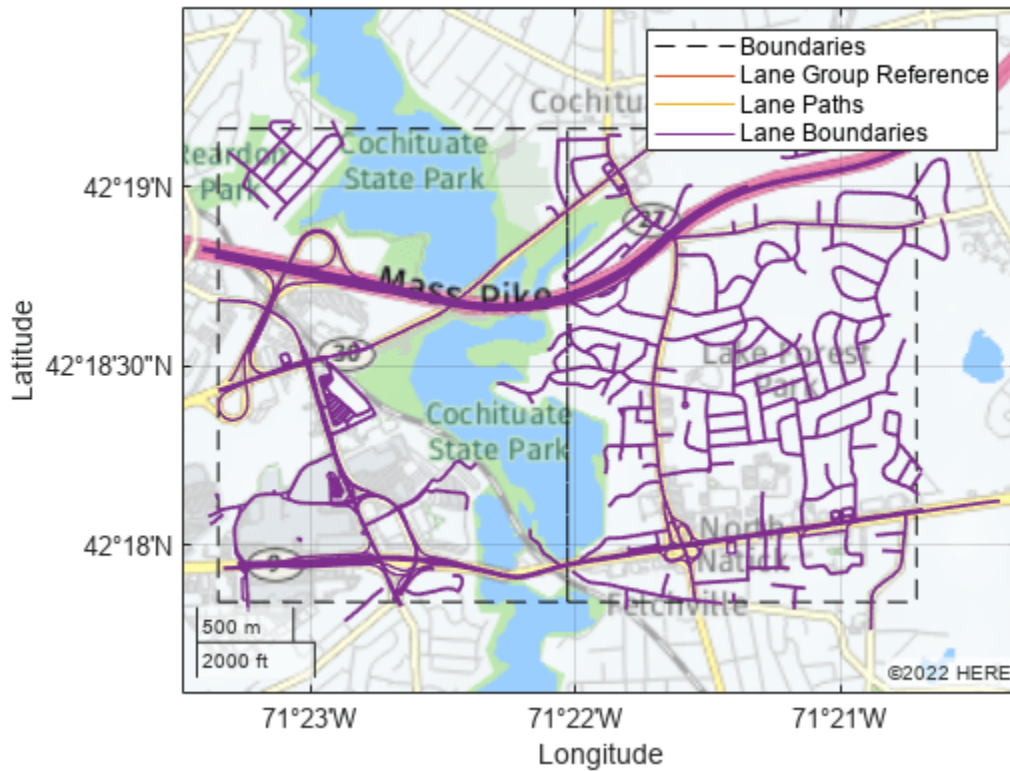

Reset Default Basemap

Clear the personal value of the basemap setting, restoring the default basemap to the factory value.

```
clearPersonalValue(s.driving.heremaps.Basemap)
```

For more information about changing MATLAB settings, see “Access and Modify Settings”.

Input Arguments

layerData — HERE HDLM layer data

LaneGeometryPolyline object | LaneTopology object | TopologyGeometry object

HERE HDLM layer data to plot, specified as one of the layer objects shown in the table.

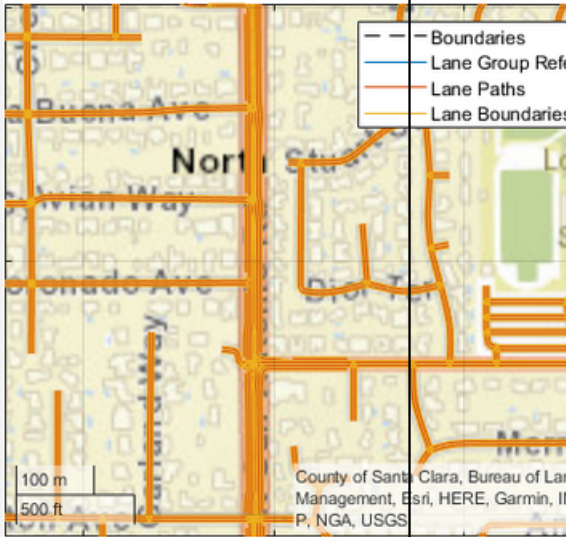
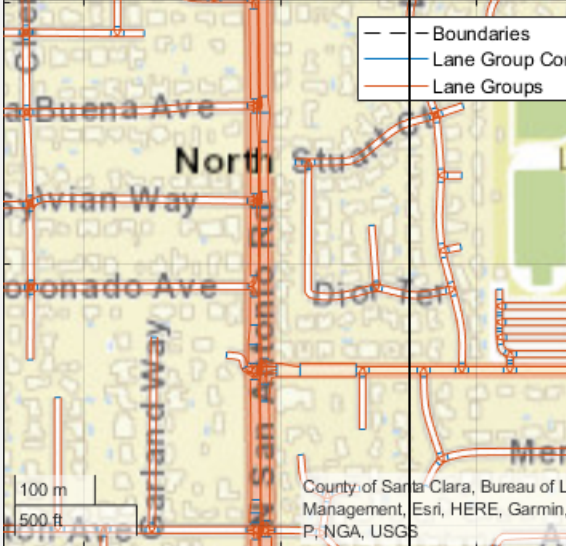
Layer Object	Description	Sample Plot
LaneGeometryPolyline	3-D lane geometry composed of a set of 3-D points joined into polylines.	
LaneTopology	Topologies of the HD Lane model, including lane group, lane group connector, lane, and lane connector topologies. This layer also contains the simplified 2-D boundary geometry of the lane model for determining map tile affinity and overflow.	

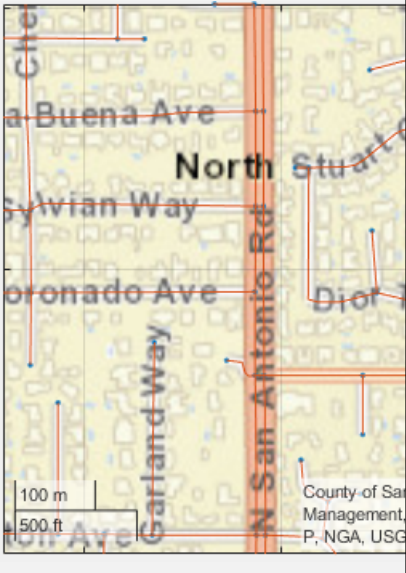
Layer Object	Description	Sample Plot
TopologyGeometry	Topology and 2-D line geometry of the road. This layer also contains definitions of the links (streets) and nodes (intersections and dead-ends) in the map tile.	

To obtain these layers from map tiles selected by a `hereHDLReader` object, use the `read` function.

gxIn — Geographic axes on which to plot data

`GeographicAxes` object

Geographic axes on which to plot data, specified as a `GeographicAxes` object.¹⁸

Output Arguments

gxOut — Geographic axes on which data is plotted

`GeographicAxes` object

Geographic axes on which data is plotted, returned as a `GeographicAxes` object. Use this object to customize the map display. For more details, see `GeographicAxes` Properties.

Version History

Introduced in R2019a

See Also

`hereHDLReader` | `geoplayer` | `geoaxes` | `geoplot` | `geobasemap` | `read`

Topics

`GeographicAxes` Properties

“Read and Visualize HERE HD Live Map Data”

“Use HERE HD Live Map Data to Verify Lane Configurations”

¹⁸ Alignment of boundaries and region labels are a presentation of the feature provided by the data vendors and do not imply endorsement by MathWorks.

hereHDLMConfiguration

Configure HERE HD Live Map reader

Description

A `hereHDLMConfiguration` object configures a `hereHDLMReader` object to search for map data in only a specific HERE HD Live Map ¹⁹ (HDLM) production catalog or catalog version. These catalogs roughly correspond to various geographic regions, such as Western Europe and North America. Using this configuration object can speed up the performance of the reader, so that it does not search unnecessary catalogs. The configuration object is stored in the `Configuration` property of a `hereHDLMReader` object.

Note Use of the `hereHDLMConfiguration` object requires valid HERE HDLM credentials. If you have not previously set up credentials, a dialog box prompts you to enter them. Enter the **Access Key ID** and **Access Key Secret** that you obtained from HERE Technologies, and click **OK**.

Creation

Syntax

```
config = hereHDLMConfiguration(catalog)
config = hereHDLMConfiguration(catalog, catalogVersion)
```

Description

`config = hereHDLMConfiguration(catalog)` creates a `hereHDLMConfiguration` object for the latest version of the specified HERE HDLM catalog. A `hereHDLMReader` object with this configuration searches for the selected map tiles within only the catalog and version specified by that configuration.

`config = hereHDLMConfiguration(catalog, catalogVersion)` creates a `hereHDLMConfiguration` object for the specified version of the catalog.

Input Arguments

catalog — Name of HERE HDLM production catalog

string scalar | character vector

Name of HERE HDLM production catalog, specified as a string scalar or character vector. You can obtain production catalog names from HERE Technologies.

Example: `'hrn:here:data::olp-here-had:here-hd\lm-protobuf-na-2'` specifies a catalog that roughly corresponds to the North America region.

Example: `'hrn:here:data::olp-here-had:here-hd\lm-protobuf-weu-2'` specifies a catalog that roughly corresponds to the Western Europe region.

¹⁹ You need to enter into a separate agreement with HERE in order to gain access to the HDLM services and to get the required credentials (`access_key_id` and `access_key_secret`) for using the HERE Service.

catalogVersion — Version number of HERE HDLM production catalog

positive integer

Version number of a HERE HDLM production catalog, specified as a positive integer. The HERE HDLM web service determines the availability of previous versions of the catalog. If you specify a version of a catalog that is not available, then hereHDLMConfiguration returns an error.

Properties**Catalog — Name of HERE HDLM production catalog**

string scalar | character vector

This property is read-only.

Name of a HERE HDLM production catalog, specified as a string scalar or character vector. This property is set to the name of the catalog specified by the catalog input.

CatalogVersion — Version number of HERE HDLM production catalog

positive integer

This property is read-only.

Version number of a HERE HDLM production catalog, specified as a positive integer. The version number corresponds to the value specified in the catalogVersion input argument. If you do not specify catalogVersion, then this property is set to the latest version of the specified catalog.

Examples**Create Configuration for Specific Catalog**

Define a HERE tile ID for an area of Berlin, Germany.

```
tileID = uint32(377894435);
```

Create a HERE HD Live Map (HERE HDLM) configuration object for the catalog that roughly corresponds to Western Europe. If you have not previously set up HERE HDLM credentials, a dialog box prompts you to enter them. Your catalog version might differ from the one shown here.

```
config = hereHDLMConfiguration('hrn:here:data::olp-here-had:here-hdlm-protobuf-weu-2')
```

```
config =
```

```
hereHDLMConfiguration with properties:
```

```
    Catalog: 'hrn:here:data::olp-here-had:here-hdlm-protobuf-weu-2'
  CatalogVersion: 5597
```

Create a HERE HDLM reader using the specified HERE tile ID and configuration object. During creation, hereHDLMReader searches for the tile ID within only the Western Europe catalog. This reader is configured to read map data from only that catalog.

```
reader = hereHDLMReader(tileID, 'Configuration', config);
```

Create Configuration for Specific Catalog Version

Create a HERE HD Live Map (HERE HDLM) configuration object for the previous version of a catalog.

Load a sequence of latitude and longitude coordinates for a driving route in Los Altos, California, USA.

```
data = load('geoSequence.mat')  
  
data = struct with fields:  
    latitude: [1000x1 double]  
    longitude: [1000x1 double]
```

Create a HERE HDLM configuration object for the latest version of a catalog that roughly corresponds to North America. If you have not previously set up HERE HDLM credentials, a dialog box prompts you to enter them. Your catalog version might differ from the one shown here.

```
catalog = 'hrn:here:data::olp-here-had:here-hdlm-protobuf-na-2';  
configLatest = hereHDLMConfiguration(catalog)  
  
configLatest =  
    hereHDLMConfiguration with properties:  
  
        Catalog: 'hrn:here:data::olp-here-had:here-hdlm-protobuf-na-2'  
        CatalogVersion: 3320
```

Create a configuration object for the previous version of the catalog.

```
previousVersion = configLatest.CatalogVersion - 1;  
config = hereHDLMConfiguration(catalog,previousVersion)  
  
config =  
    hereHDLMConfiguration with properties:  
  
        Catalog: 'hrn:here:data::olp-here-had:here-hdlm-protobuf-na-2'  
        CatalogVersion: 3319
```

Create a HERE HDLM reader using the specified configuration object. The reader is configured to read data from only the previous version of the North America catalog.

```
reader = hereHDLMReader(data.latitude,data.longitude,'Configuration',config);
```

Tips

- To save HERE HDLM credentials between MATLAB sessions, select the **Save my credentials between MATLAB sessions** option in the HERE HD Live Map Credentials dialog box. To manage HERE HDLM credentials, use the `hereHDLMCredentials` function.

Version History

Introduced in R2019a

R2021a: hereHDLConfiguration(region) syntax has been removed*Errors starting in R2021a*

In hereHDLConfiguration objects, the syntax for configuring a hereHDLReader object to search catalogs from a specific region, hereHDLConfiguration(region), has been removed. Instead, specify the catalog name that corresponds to that region by using the hereHDLConfiguration(catalog) syntax.

Previously, the catalog names for regions such as North America were not available to customers. HERE Technologies now makes these catalog names available through the HERE HD Live Map Marketplace, making the region syntax unnecessary.

Update Code

The table shows a typical usage of the hereHDLConfiguration(region) syntax. It also shows how to update your code using the hereHDLConfiguration(catalog) syntax.

Discouraged Usage	Recommended Replacement
catalog = hereHDLConfiguration('North America')	catalog = hereHDLConfiguration('hrn:here:data::olp-h')

See Also

hereHDLCredentials | hereHDLReader

Topics

“Read and Visualize HERE HD Live Map Data”

inflationCollisionChecker

Collision-checking configuration for costmap based on inflation

Description

The `inflationCollisionChecker` function creates an `InflationCollisionChecker` object, which holds the collision-checking configuration of a vehicle costmap. A vehicle costmap with this configuration inflates the size of obstacles in the vehicle environment. This inflation is based on the specified `InflationCollisionChecker` properties, such as the dimensions of the vehicle and the radius of circles required to enclose the vehicle. For more details, see “Algorithms” on page 4-1022. Path planning algorithms, such as `pathPlannerRRT`, use this costmap collision-checking configuration to avoid inflated obstacles and plan collision-free paths through an environment.

Use the `InflationCollisionChecker` object to set the `CollisionChecker` property of your `vehicleCostmap` object. This collision-checking configuration affects the return values of the `checkFree` and `checkOccupied` functions used by `vehicleCostmap`. These values indicate whether a vehicle pose is *free* or *occupied*.

Creation

Syntax

```
ccConfig = inflationCollisionChecker
ccConfig = inflationCollisionChecker(vehicleDims)
ccConfig = inflationCollisionChecker(vehicleDims,numCircles)
ccConfig = inflationCollisionChecker( ____,Name,Value)
```

Description

`ccConfig = inflationCollisionChecker` creates an `InflationCollisionChecker` object, `ccConfig`, that holds the collision-checking configuration of a vehicle costmap. This object uses one circle to enclose the vehicle. The dimensions of the vehicle correspond to the values of a default `vehicleDimensions` object.

`ccConfig = inflationCollisionChecker(vehicleDims)` specifies the dimensions of the vehicle, where `vehicleDims` is a `vehicleDimensions` object. The `vehicleDims` input sets the `VehicleDimensions` property of `ccConfig`.

`ccConfig = inflationCollisionChecker(vehicleDims,numCircles)` also specifies the number of circles used to enclose the vehicle. The `numCircles` input sets the `NumCircles` property of `ccConfig`.

`ccConfig = inflationCollisionChecker(____,Name,Value)` sets the `CenterPlacements` and `InflationRadius` properties using name-value pairs and the inputs from any of the preceding syntaxes. Enclose each property name in quotes.

Example: `inflationCollisionChecker('CenterPlacements',[0.2 0.5 0.8], 'InflationRadius',1.2)`

Properties

NumCircles — Number of circles enclosing the vehicle

1 (default) | positive integer

Number of circles used to enclose the vehicle and calculate the inflation radius, specified as a positive integer. Typical values are from 1 to 5.

- For faster but more conservative collision checking, decrease the number of circles. This approach improves performance because the path planning algorithm makes fewer collision checks.
- For slower but more precise collision checking, increase the number of circles. This approach is useful when planning a path around tight corners or through narrow corridors, such as in a parking lot.

CenterPlacements — Normalized placement of circle centers

1-by-NumCircles vector of real values in the range [0, 1]

Normalized placement of circle centers along the longitudinal axis of the vehicle, specified as a 1-by-NumCircles vector of real values in the range [0, 1].

- A value of 0 places a circle center at the rear of the vehicle.
- A value of 1 places a circle center at the front of the vehicle.

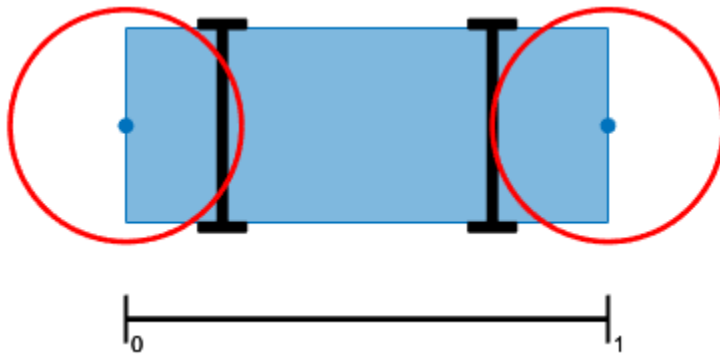

Specify `CenterPlacements` when you want to align the circles with exact positions on the vehicle. If you leave `CenterPlacements` unspecified, the object computes the center placements so that the circles completely enclose the vehicle. If you change the number of center placements, `NumCircles` is updated to the number of elements in `CenterPlacements`.

VehicleDimensions — Vehicle dimensions

`vehicleDimensions` object

Vehicle dimensions used to compute the inflation radius, specified as a `vehicleDimensions` object. By default, the `InflationCollisionChecker` object uses the dimensions of a default `vehicleDimensions` object. Vehicle dimensions are in world units.

InflationRadius — Inflation radius

nonnegative real number

Inflation radius, specified as a nonnegative real number. By default, the object computes the inflation radius based on the values of `NumCircles`, `CenterPlacements`, and `VehicleDimensions`. For more details, see “Algorithms” on page 4-1022.

Object Functions

plot Plot collision configuration

Examples

Plan Path Using Different Collision-Checking Configurations

Plan a vehicle path to a narrow parking spot by using the optimized rapidly exploring random tree (RRT*) algorithm. Try different collision-checking configurations in the costmap used by the RRT* path planner.

Load and display a costmap of a parking lot. The costmap is a `vehicleCostmap` object. By default, `vehicleCostmap` uses a collision-checking configuration that inflates obstacles based on a radius of only one circle enclosing the vehicle. The costmap overinflates the obstacles (the parking spot boundaries).

```
data = load('parkingLotCostmap.mat');
costmap = data.parkingLotCostmap;

figure
plot(costmap)
title('Collision Checking with One Circle')
```

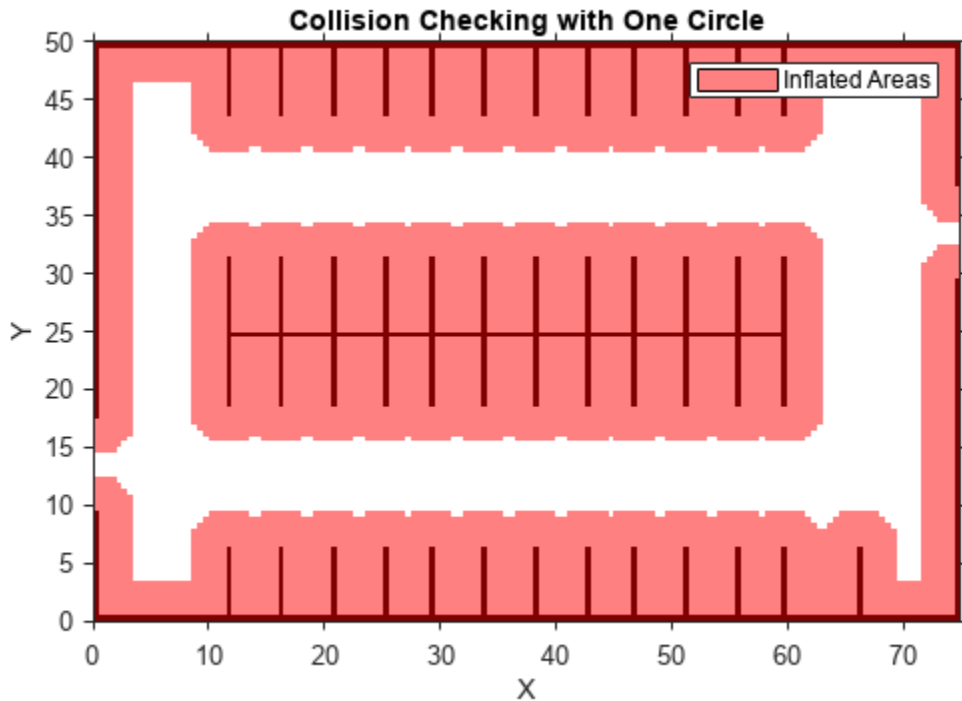

Use `inflationCollisionChecker` to create a new collision-checking configuration for the costmap.

- To decrease inflation of the obstacles, increase the number of circles enclosing the vehicle.
- To specify the dimensions of the vehicle, use a `vehicleDimensions` object.

Specify the collision-checking configuration in the `CollisionChecker` property of the costmap.

```
vehicleDims = vehicleDimensions(4.5,1.7); % 4.5 m long, 1.7 m wide
numCircles = 3;
ccConfig = inflationCollisionChecker(vehicleDims,numCircles);
costmap.CollisionChecker = ccConfig;
```

Display the costmap with the new collision-checking configuration. The inflated areas are reduced.

```
figure
plot(costmap)
title('Collision Checking with Three Circles')
```

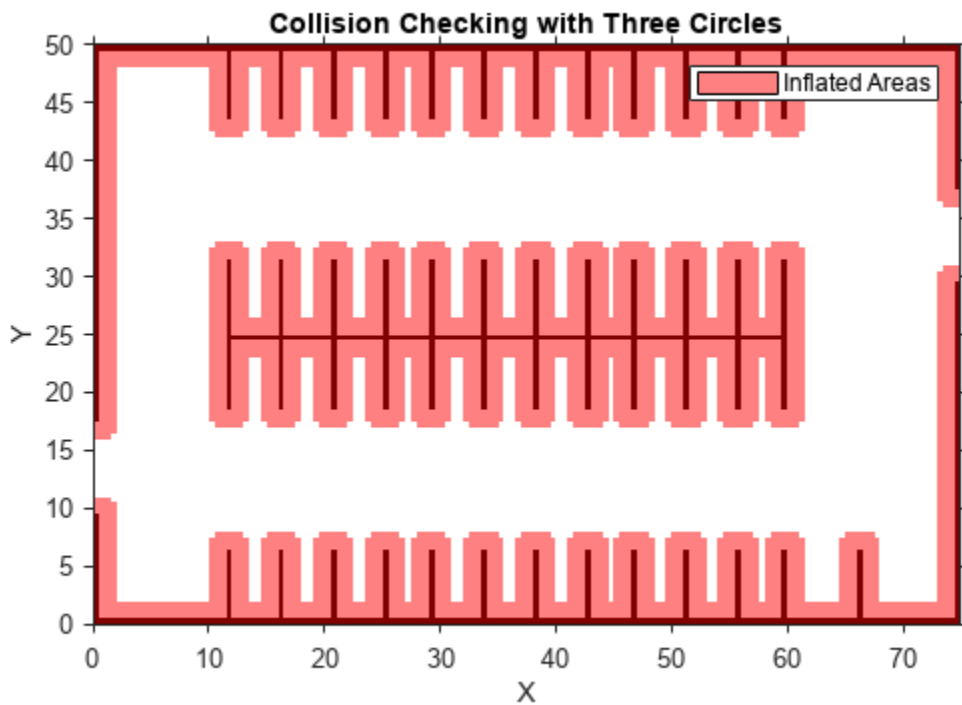

Define a planning problem: a vehicle starts near the left entrance of the parking lot and ends in a parking spot.

```
startPose = [11 10 0]; % [meters, meters, degrees]
goalPose = [31.5 17 90];
```

Use a `pathPlannerRRT` object to plan a path to the parking spot. Plot the planned path.

```
planner = pathPlannerRRT(costmap);
refPath = plan(planner,startPose,goalPose);
```

```
hold on
plot(refPath)
hold off
```

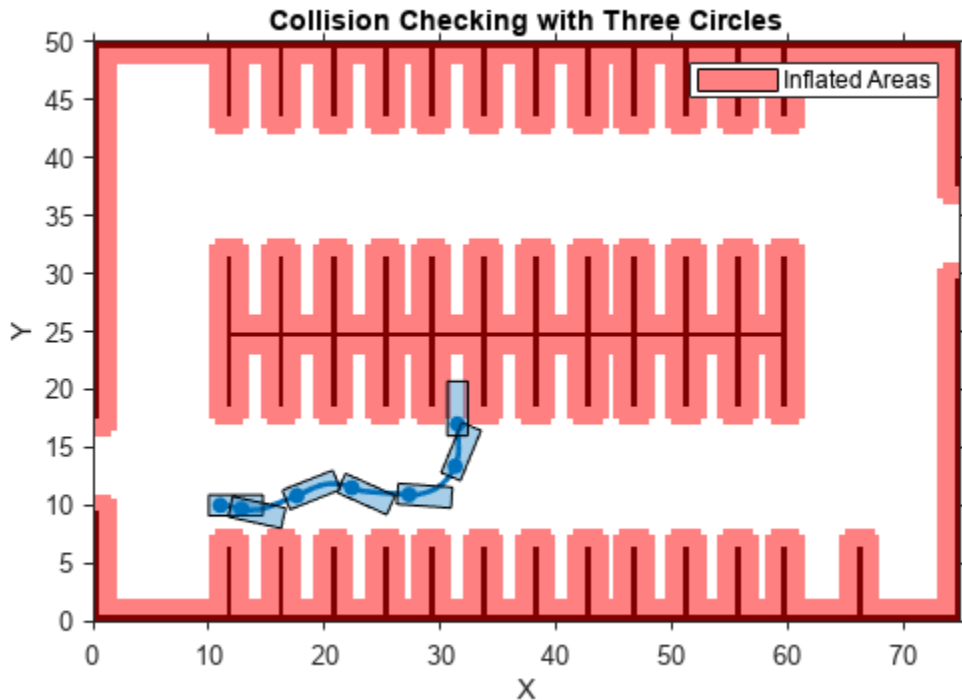

Create Collision-Checking Configuration with Center Placements

Create a collision-checking configuration for a costmap. Manually specify the circle centers so that they fully enclose the vehicle.

Define the dimensions of a vehicle by using a `vehicleDimensions` object.

```
length = 5; % meters
width = 2; % meters
vehicleDims = vehicleDimensions(length,width);
```

Define three circle centers and the inflation radius to use for collision checking. Place one center at the vehicle's midpoint. Offset the other two centers by an equal amount on either end of the vehicle.

```
distFromSide = 0.175;
centerPlacements = [distFromSide 0.5 1-distFromSide];
inflationRadius = 1.2;
```

Create and display the collision-checking configuration.

```
ccConfig = inflationCollisionChecker(vehicleDims, ...
    'CenterPlacements',centerPlacements,'InflationRadius',inflationRadius);
```

```
figure  
plot(ccConfig)
```

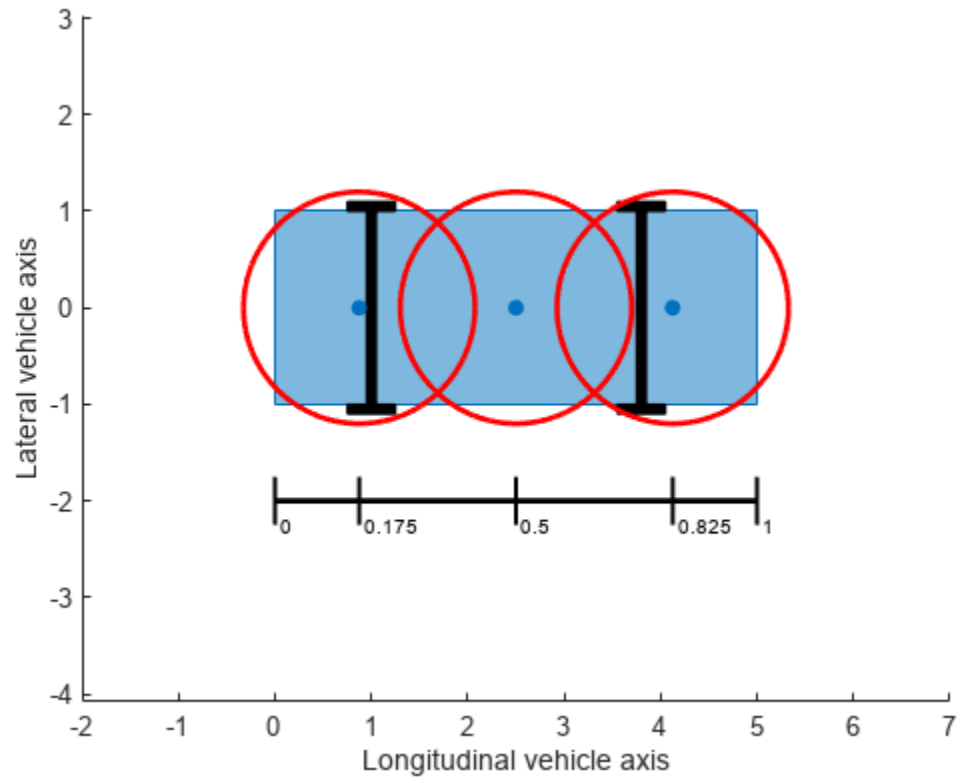

In this configuration, the corners of the vehicle are not enclosed within the circles. To fully enclose the vehicle, increase the inflation radius. Display the updated configuration.

```
ccConfig.InflationRadius = 1.3;  
plot(ccConfig)
```

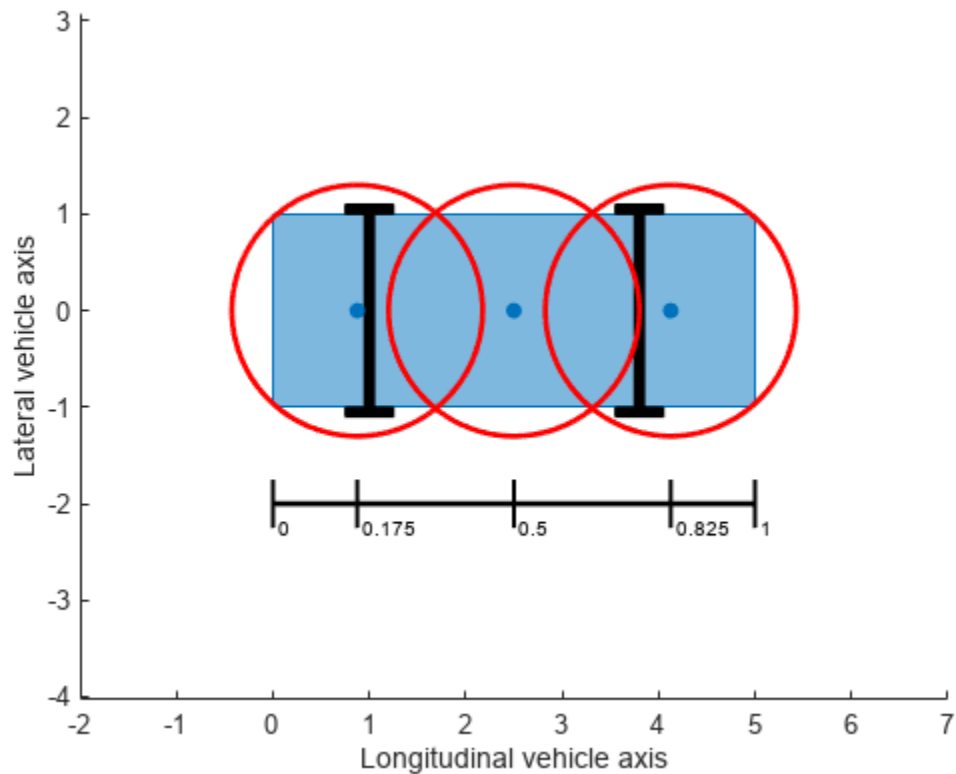

Use this collision-checking configuration to create a 10-by-20 meter costmap.

```
costmap = vehicleCostmap(10,20,0.1,'CollisionChecker',ccConfig);
```

Tips

- To visually verify that the circles completely enclose the vehicle, use the `plot` function. If the circles do not completely enclose the vehicle, some of the free poses returned by `checkFree` (or unoccupied poses returned by `checkOccupied`) might actually be in collision.

Algorithms

The `InflationRadius` property of `InflationCollisionChecker` determines the amount, in world units, by which to inflate obstacles. By default, `InflationRadius` is equal to the radius of the smallest set of overlapping circles required to completely enclose the vehicle, as determined by the following properties:

- `NumCircles` — Number of circles used to enclose the vehicle
- `CenterPlacements` — Placements of the circle centers along the longitudinal axis of the vehicle
- `VehicleDimensions` — Dimensions of the vehicle

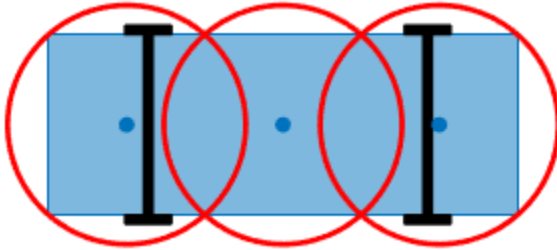

For more details about how this collision-checking configuration defines inflated areas in a costmap, see the “Algorithms” on page 4-1404 section of `vehicleCostmap`.

Version History

Introduced in R2018b

References

[1] Ziegler, J., and C. Stiller. "Fast Collision Checking for Intelligent Vehicle Motion Planning." *IEEE Intelligent Vehicle Symposium*. June 21-24, 2010.

Extended Capabilities

C/C++ Code Generation

Generate C and C++ code using MATLAB® Coder™.

Usage notes and limitations:

- All inputs to `inflationCollisionChecker` must be compile-time constants.

See Also

Objects

`pathPlannerRRT` | `vehicleCostmap` | `vehicleDimensions`

Topics

“Automated Parking Valet”

plot

Plot collision configuration

Syntax

```
plot(ccConfig)
plot(ccConfig,Name,Value)
```

Description

`plot(ccConfig)` plots the collision-checking configuration of an `InflationCollisionChecker` object. Use `plot` to visually verify that the circles in the configuration fully enclose the vehicle.

`plot(ccConfig,Name,Value)` specifies options using one or more `Name,Value` pair arguments. For example, `plot(ccConfig,'Ruler','Off')` turns off the ruler that indicates the locations of the circle centers.

Examples

Create Collision-Checking Configuration with Center Placements

Create a collision-checking configuration for a costmap. Manually specify the circle centers so that they fully enclose the vehicle.

Define the dimensions of a vehicle by using a `vehicleDimensions` object.

```
length = 5; % meters
width = 2; % meters
vehicleDims = vehicleDimensions(length,width);
```

Define three circle centers and the inflation radius to use for collision checking. Place one center at the vehicle's midpoint. Offset the other two centers by an equal amount on either end of the vehicle.

```
distFromSide = 0.175;
centerPlacements = [distFromSide 0.5 1-distFromSide];
inflationRadius = 1.2;
```

Create and display the collision-checking configuration.

```
ccConfig = inflationCollisionChecker(vehicleDims, ...
    'CenterPlacements',centerPlacements,'InflationRadius',inflationRadius);
```

```
figure
plot(ccConfig)
```

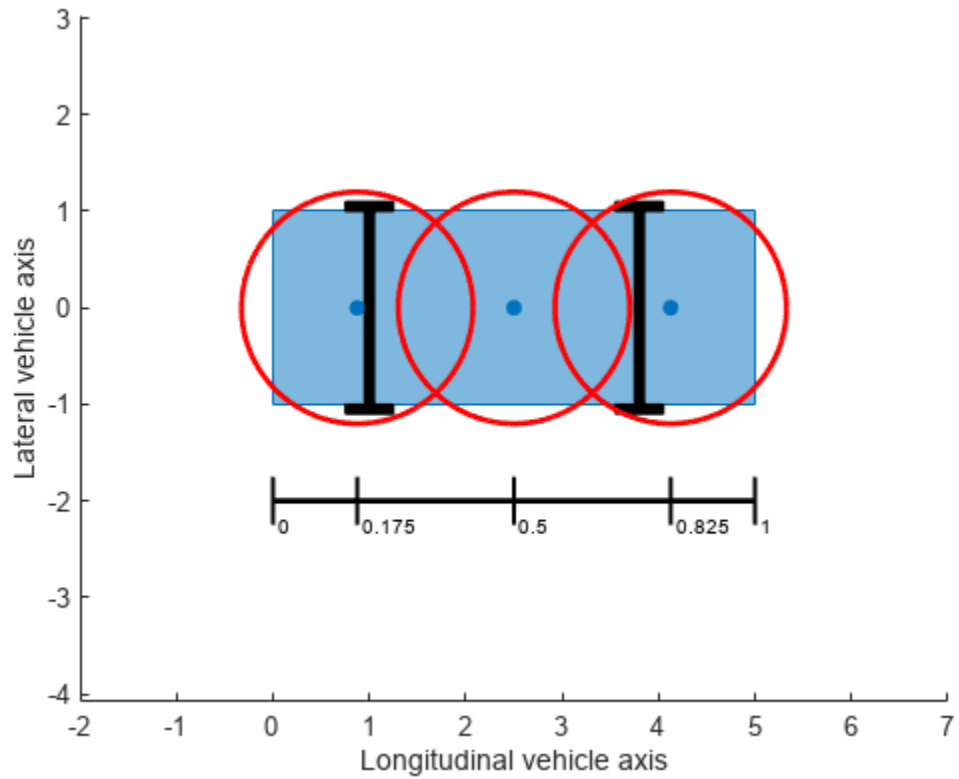

In this configuration, the corners of the vehicle are not enclosed within the circles. To fully enclose the vehicle, increase the inflation radius. Display the updated configuration.

```
ccConfig.InflationRadius = 1.3;  
plot(ccConfig)
```

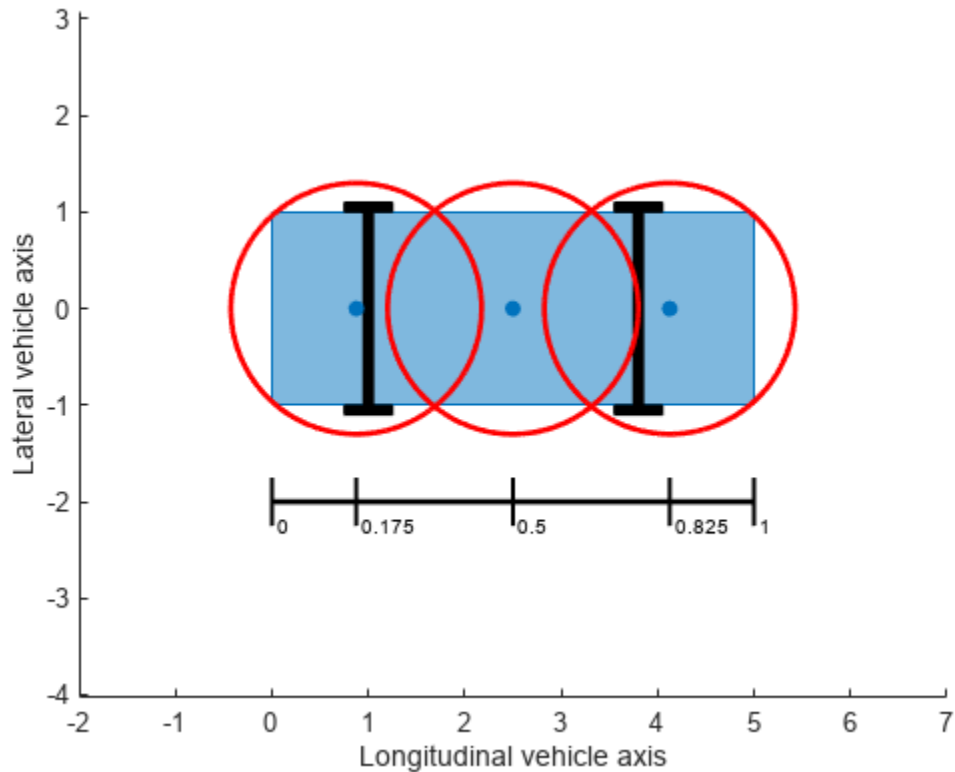

Use this collision-checking configuration to create a 10-by-20 meter costmap.

```
costmap = vehicleCostmap(10,20,0.1,'CollisionChecker',ccConfig);
```

Input Arguments

ccConfig — Collision-checking configuration

`InflationCollisionChecker` object

Collision-checking configuration, specified as an `InflationCollisionChecker` object. To create a collision-checking configuration, use the `inflationCollisionChecker` function.

Name-Value Pair Arguments

Specify optional pairs of arguments as `Name1=Value1, ..., NameN=ValueN`, where `Name` is the argument name and `Value` is the corresponding value. Name-value arguments must appear after other arguments, but the order of the pairs does not matter.

Before R2021a, use commas to separate each name and value, and enclose Name in quotes.

Example: `plot(ccConfig, 'Parent', ax)` plots the collision configuration in axes `ax`.

Parent — Axes on which to plot collision configuration

Axes object

Axes on which to plot the collision configuration, specified as the comma-separated pair consisting of 'Parent' and an Axes object. To create an Axes object, use the axes function.

To plot the collision configuration in a new figure, leave 'Parent' unspecified.

Ruler — Display ruler

'on' (default) | 'off'

Display the ruler that shows the locations of the circle centers, specified as the comma-separated pair consisting of 'Ruler' and 'on' or 'off'.

Version History

Introduced in R2018b

See Also

inflationCollisionChecker

parabolicLaneBoundary

Parabolic lane boundary model

Description

The `parabolicLaneBoundary` object contains information about a parabolic lane boundary model.

Creation

To generate parabolic lane boundary models that fit a set of boundary points and an approximate width, use the `findParabolicLaneBoundaries` function. If you already know your parabolic parameters, create lane boundary models by using the `parabolicLaneBoundary` function (described here).

Syntax

```
boundaries = parabolicLaneBoundary(parabolicParameters)
```

Description

`boundaries = parabolicLaneBoundary(parabolicParameters)` creates an array of parabolic lane boundary models from an array of [A B C] parameters for the parabolic equation $y = Ax^2 + Bx + C$. Points within the lane boundary models are in world coordinates.

Input Arguments

parabolicParameters — Coefficients for parabolic models

[A B C] real-valued vector | matrix of [A B C] values

Coefficients for parabolic models of the form $y = Ax^2 + Bx + C$, specified as an [A B C] real-valued vector or as a matrix of [A B C] values. Each row of `parabolicParameters` describes a separate parabolic lane boundary model.

Properties

Parameters — Coefficients for parabolic model

[A B C] real-valued vector

Coefficients for a parabolic model of the form $y = Ax^2 + Bx + C$, specified as a real-valued vector of the form [A B C].

BoundaryType — Type of boundary

LaneBoundaryType

Type of lane boundary, specified as a `LaneBoundaryType` enumeration. Supported lane boundary types are:

- Unmarked
- Solid
- Dashed
- BottsDots
- DoubleSolid

Lane boundary objects always return `BoundaryType` as type `Solid`. Update these types to match the types of the lanes that are being fitted. To update a lane boundary type, use the `LaneBoundaryType.BoundaryType` syntax. For example, this code sample shows how to update the first output lane boundary to type `BottsDots`:

```
boundaries(1) = LaneBoundaryType.BottsDots;
```

Strength — Strength of boundary model

real scalar

Strength of the boundary model, specified as a real scalar. `Strength` is the ratio of the number of unique x -axis locations on the boundary to the length of the boundary specified by the `XExtent` property. A solid line without any breaks has a higher strength than a dotted line that has breaks along the full length of the boundary.

XExtent — Length of boundary along x-axis

[minX maxX] real-valued vector

Length of the boundary along the x -axis, specified as a real-valued vector of the form [minX maxX] that describes the minimum and maximum x -axis locations.

Object Functions

`computeBoundaryModel` Obtain y-coordinates of lane boundaries given x-coordinates

Examples

Create Parabolic Lane Boundaries

Create left-lane and right-lane parabolic boundary models.

```
llane = parabolicLaneBoundary([-0.001 0.01 0.5]);
rlane = parabolicLaneBoundary([-0.001 0.01 -0.5]);
```

Create a bird's-eye plot and lane boundary plotter. Plot the lane boundaries.

```
bep = birdsEyePlot('XLimits',[0 30],'YLimits',[-5 5]);
lbPlotter = laneBoundaryPlotter(bep,'DisplayName','Lane boundaries');
plotLaneBoundary(lbPlotter, [llane rlane]);
```

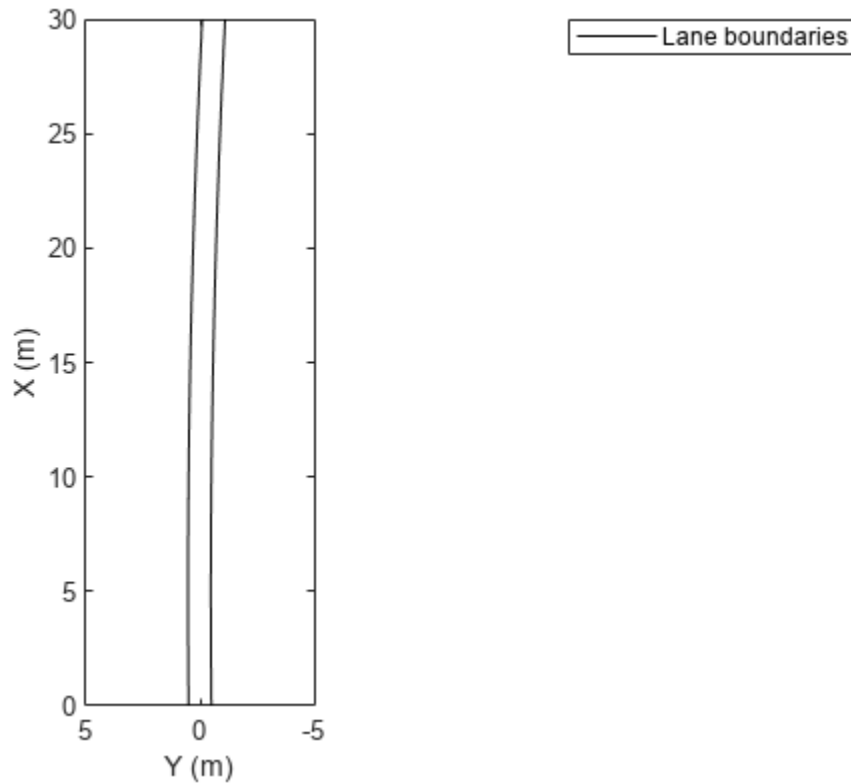

Find Parabolic Lane Boundaries in Bird's-Eye-View Image

Find lanes in an image by using parabolic lane boundary models. Overlay the identified lanes on the original image and on a bird's-eye-view transformation of the image.

Load an image of a road with lanes. The image was obtained from a camera sensor mounted on the front of a vehicle.

```
I = imread('road.png');
```

Transform the image into a bird's-eye-view image by using a preconfigured sensor object. This object models the sensor that captured the original image.

```
bevSensor = load('birdsEyeConfig');  
birdsEyeImage = transformImage(bevSensor.birdsEyeConfig,I);  
imshow(birdsEyeImage)
```





Set the approximate lane marker width in world units (meters).

```
approxBoundaryWidth = 0.25;
```

Detect lane features and display them as a black-and-white image.

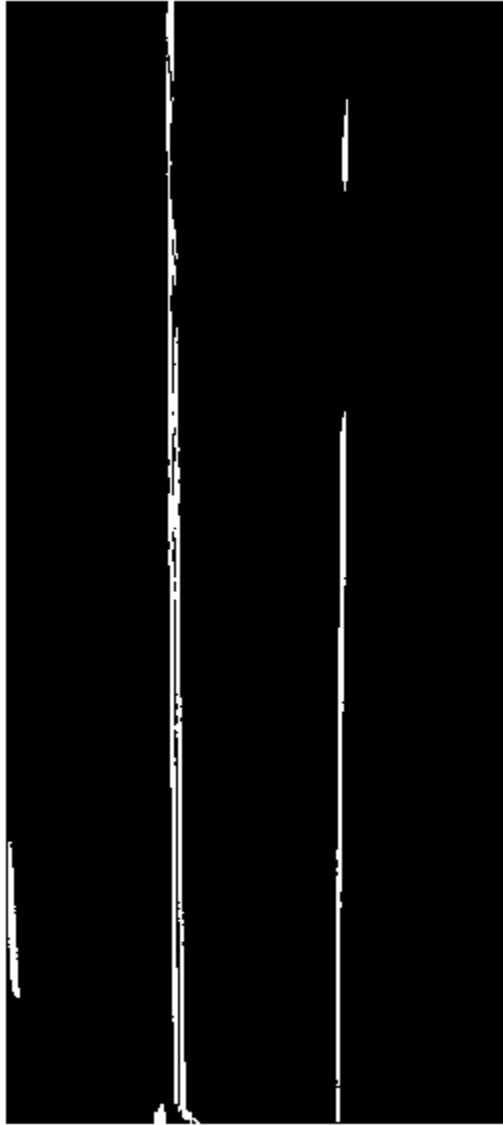
```
birdsEyeBW = segmentLaneMarkerRidge(im2gray(birdsEyeImage), ...  
    bevSensor.birdsEyeConfig,approxBoundaryWidth);  
imshow(birdsEyeBW)
```



Obtain the image coordinates corresponding to the lane candidate positions. The `find` function returns pixel indices that correspond to the candidate lane positions. By convention, the order of the image coordinates is always reversed relative to the pixel indices. For more information about image coordinates, see “Coordinate Systems”.

Obtain the corresponding lane boundary points in vehicle coordinates by using the `imageToVehicle` function.

```
[imageY,imageX] = find(birdsEyeBW);  
xyBoundaryPoints = imageToVehicle(bevSensor.birdsEyeConfig,[imageX,imageY]);
```

Find lane boundaries in the image by using the `findParabolicLaneBoundaries` function. By default, the function returns a maximum of two lane boundaries. The boundaries are stored in an array of `parabolicLaneBoundary` objects.

```
boundaries = findParabolicLaneBoundaries(xyBoundaryPoints, approxBoundaryWidth);
```

Use `insertLaneBoundary` to overlay the lanes on the original image. The `XPoints` vector represents the lane points, in meters, that are within range of the ego vehicle's sensor. Specify the lanes in different colors. By default, lanes are yellow.

```
XPoints = 3:30;
```

```
figure
sensor = bevSensor.birdsEyeConfig.Sensor;
lanesI = insertLaneBoundary(I, boundaries(1), sensor, XPoints);
lanesI = insertLaneBoundary(lanesI, boundaries(2), sensor, XPoints, 'Color', 'green');
imshow(lanesI)
```



View the lanes in the bird's-eye-view image.

```
figure
BEconfig = bevSensor.birdsEyeConfig;
lanesBEI = insertLaneBoundary(birdsEyeImage, boundaries(1), BEconfig, XPoints);
```

```
lanesBEI = insertLaneBoundary(lanesBEI, boundaries(2), BEconfig, XPoints, 'Color', 'green');  
imshow(lanesBEI)
```

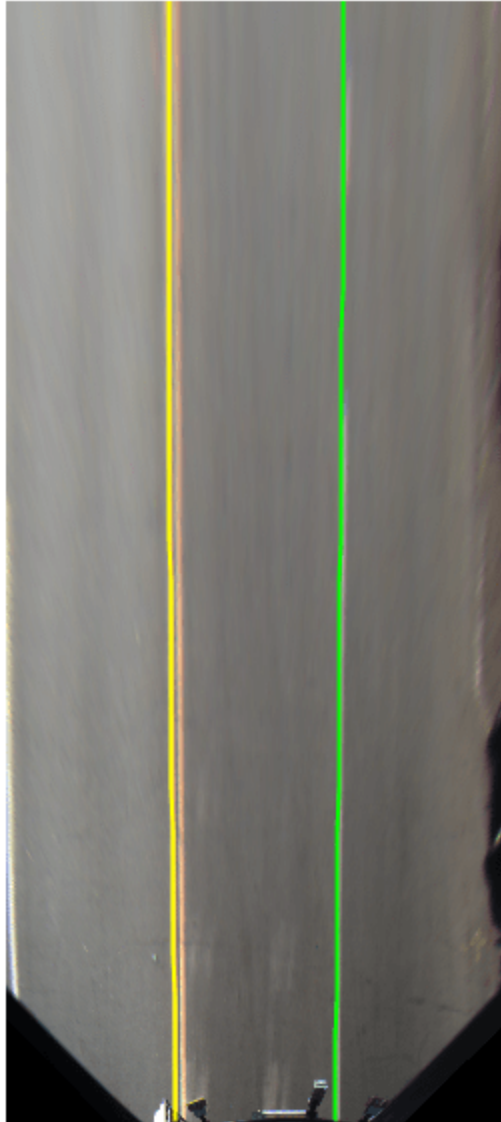

Version History

Introduced in R2017a

Extended Capabilities

C/C++ Code Generation

Generate C and C++ code using MATLAB® Coder™.

To select a set of parabolic lane boundary models from an array of `parabolicLaneBoundary` objects, use either indexing by position or linear indexing. Logical indexing is not supported. For example,

```
boundaries = findParabolicLaneBoundaries(xyBoundaryPoints,...
                                         approxBoundaryWidth);
```

```
boundaries =
```

```
    1×5 parabolicLaneBoundary array with properties:
```

```
    Parameters
    BoundaryType
    Strength
    XExtent
    Width
```

```
index = [1 3 5];
selectedBoundaries = boundaries(index)
```

```
selectedBoundaries =
```

```
    1×3 parabolicLaneBoundary array with properties:
```

```
    Parameters
    BoundaryType
    Strength
    XExtent
    Width
```

See Also

Apps

Ground Truth Labeler

Objects

`cubicLaneBoundary`

Functions

`findParabolicLaneBoundaries` | `insertLaneBoundary` | `evaluateLaneBoundaries`

cubicLaneBoundary

Cubic lane boundary model

Description

The `cubicLaneBoundary` object contains information about a cubic lane boundary model.

Creation

To generate cubic lane boundary models that fit a set of boundary points and an approximate width, use the `findCubicLaneBoundaries` function. If you already know your cubic parameters, create lane boundary models by using the `cubicLaneBoundary` function (described here).

Syntax

```
boundaries = cubicLaneBoundary(cubicParameters)
```

Description

`boundaries = cubicLaneBoundary(cubicParameters)` creates an array of cubic lane boundary models from an array of `[A B C D]` parameters for the cubic equation $y = Ax^3 + Bx^2 + Cx + D$. Points within the lane boundary models are in world coordinates.

Input Arguments

cubicParameters — Parameters for cubic models

`[A B C D]` real-valued vector | matrix of `[A B C D]` values

Parameters for cubic models of the form $y = Ax^3 + Bx^2 + Cx + D$, specified as an `[A B C D]` real-valued vector or as a matrix of `[A B C D]` values. Each row of `cubicParameters` describes a separate cubic lane boundary model.

Properties

Parameters — Coefficients for cubic model

`[A B C D]` real-valued vector

Coefficients for a cubic model of the form $y = Ax^3 + Bx^2 + Cx + D$, specified as a real-valued vector of the form `[A B C D]`.

BoundaryType — Type of boundary

`LaneBoundaryType`

Type of lane boundary, specified as a `LaneBoundaryType` enumeration. Supported lane boundary types are:

- Unmarked

- Solid
- Dashed
- BottsDots
- DoubleSolid

Lane boundary objects always return `BoundaryType` as type `Solid`. Update these types to match the types of the lanes that are being fitted. To update a lane boundary type, use the `LaneBoundaryType.BoundaryType` syntax. For example, this code sample shows how to update the first output lane boundary to type `BottsDots`:

```
boundaries(1) = LaneBoundaryType.BottsDots;
```

Strength — Strength of boundary model

real scalar

Strength of the boundary model, specified as a real scalar. `Strength` is the ratio of the number of unique `x`-axis locations on the boundary to the length of the boundary specified by the `XExtent` property. A solid line without any breaks has a higher strength than a dotted line that has breaks along the full length of the boundary.

XExtent — Length of boundary along x-axis

[minX maxX] real-valued vector

Length of the boundary along the `x`-axis, specified as a real-valued vector of the form [minX maxX] that describes the minimum and maximum `x`-axis locations.

Object Functions

`computeBoundaryModel` Obtain y-coordinates of lane boundaries given x-coordinates

Examples

Create Cubic Lane Boundaries

Create left-lane and right-lane cubic boundary models.

```
llane = cubicLaneBoundary([-0.0001 0.0 0.003 1.6]);
rlane = cubicLaneBoundary([-0.0001 0.0 0.003 -1.8]);
```

Create a bird's-eye plot and lane boundary plotter. Plot the lane boundaries.

```
bep = birdsEyePlot('XLimits',[0 30],'YLimits',[-10 10]);
lbPlotter = laneBoundaryPlotter(bep,'DisplayName','Lane boundaries');

plotLaneBoundary(lbPlotter, [llane rlane]);
```

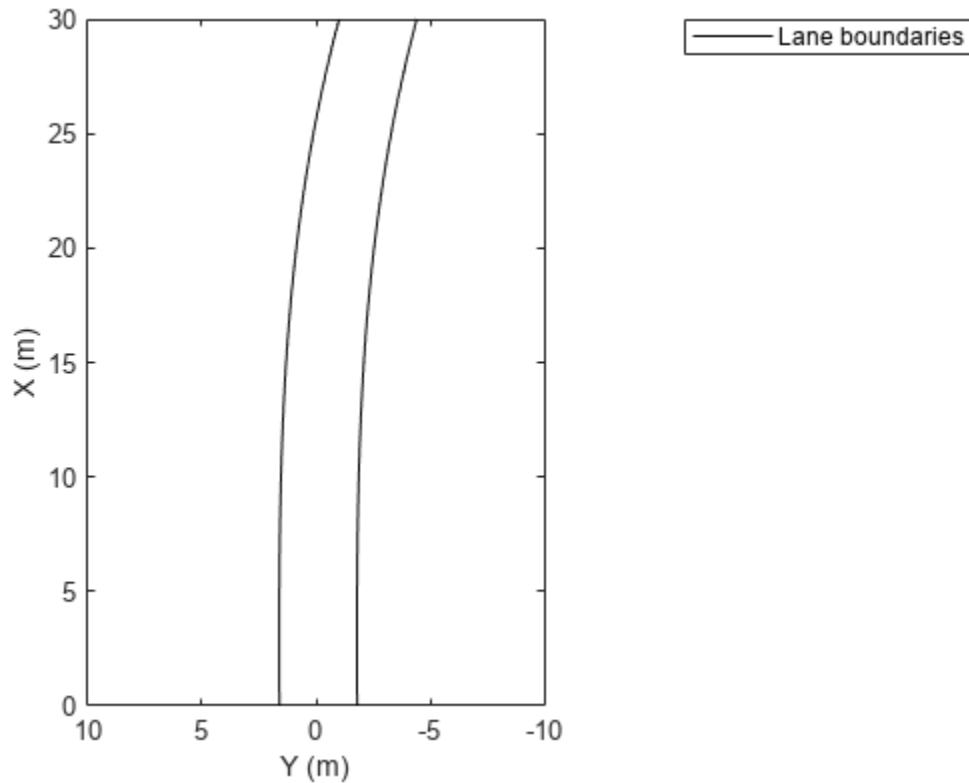

Find Cubic Lane Boundaries in Bird's-Eye-View Image

Find lanes in an image by using cubic lane boundary models. Overlay the identified lanes on the original image and on a bird's-eye-view transformation of the image.

Load an image of a road with lanes. The image was obtained from a camera sensor mounted on the front of a vehicle.

```
I = imread('road.png');
```

Transform the image into a bird's-eye-view image by using a preconfigured sensor object. This object models the sensor that captured the original image.

```
bevSensor = load('birdsEyeConfig');  
birdsEyeImage = transformImage(bevSensor.birdsEyeConfig,I);  
imshow(birdsEyeImage)
```





Set the approximate lane marker width in world units (meters).

```
approxBoundaryWidth = 0.25;
```

Detect lane features and display them as a black-and-white image.

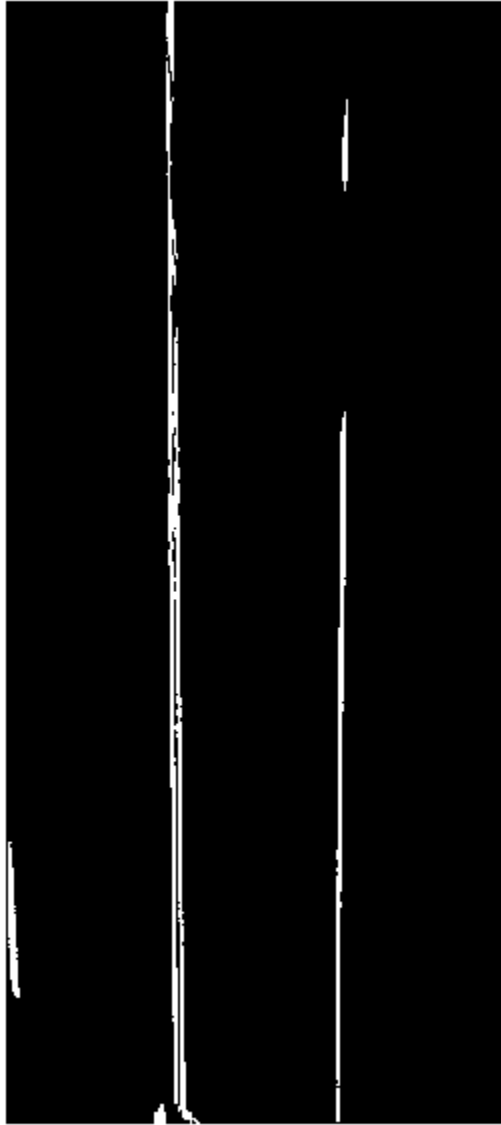
```
birdsEyeBW = segmentLaneMarkerRidge(im2gray(birdsEyeImage), ...  
    bevSensor.birdsEyeConfig,approxBoundaryWidth);  
imshow(birdsEyeBW)
```



Obtain the image coordinates corresponding to the lane candidate positions. The `find` function returns pixel indices that correspond to the candidate lane positions. By convention, the order of the image coordinates is always reversed relative to the pixel indices. For more information about image coordinates, see “Coordinate Systems”.

Obtain the corresponding lane boundary points in vehicle coordinates by using the `imageToVehicle` function.

```
[imgaeY,imageX] = find(birdsEyeBW);  
xyBoundaryPoints = imageToVehicle(bevSensor.birdsEyeConfig,[imageX,imgaeY]);
```

Find lane boundaries in the image by using the `findCubicLaneBoundaries` function. By default, the function returns a maximum of two lane boundaries. The boundaries are stored in an array of `cubicLaneBoundary` objects.

```
boundaries = findCubicLaneBoundaries(xyBoundaryPoints,approxBoundaryWidth);
```

Use `insertLaneBoundary` to overlay the lanes on the original image. The `XPoints` vector represents the lane points, in meters, that are within range of the ego vehicle's sensor. Specify the lanes in different colors. By default, lanes are yellow.

```
XPoints = 3:30;
```

```
figure
sensor = bevSensor.birdsEyeConfig.Sensor;
lanesI = insertLaneBoundary(I,boundaries(1),sensor,XPoints);
lanesI = insertLaneBoundary(lanesI,boundaries(2),sensor,XPoints,'Color','green');
imshow(lanesI)
```



View the lanes in the bird's-eye-view image.

```
figure
BEconfig = bevSensor.birdsEyeConfig;
lanesBEI = insertLaneBoundary(birdsEyeImage,boundaries(1),BEconfig,XPoints);
```

```
lanesBEI = insertLaneBoundary(lanesBEI, boundaries(2), BEconfig, XPoints, 'Color', 'green');  
imshow(lanesBEI)
```

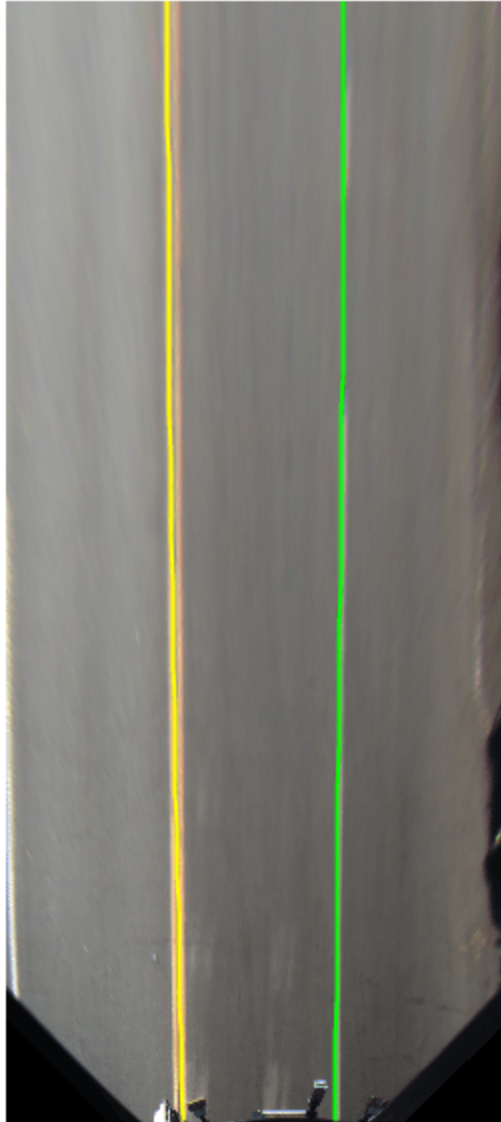

Version History

Introduced in R2018a

Extended Capabilities

C/C++ Code Generation

Generate C and C++ code using MATLAB® Coder™.

See Also

Apps

Ground Truth Labeler

Objects

parabolicLaneBoundary

Functions

findCubicLaneBoundaries | insertLaneBoundary | evaluateLaneBoundaries

computeBoundaryModel

Obtain y -coordinates of lane boundaries given x -coordinates

Syntax

```
yWorld = computeBoundaryModel(boundaries,xWorld)
```

Description

`yWorld = computeBoundaryModel(boundaries,xWorld)` computes the y -axis world coordinates of lane boundary models at the specified x -axis world coordinates.

- If `boundaries` is a single lane boundary model, then `yWorld` is a vector of coordinates corresponding to the coordinates in `xWorld`.
- If `boundaries` is an array of lane boundary models, then `yWorld` is a matrix. Each row or column of `yWorld` corresponds to a lane boundary model computed at the x -coordinates in row or column vector `xWorld`.

Examples

Compute Lane Boundary

Create a `parabolicLaneBoundary` object to model a lane boundary. Compute the positions of the lane along a set of x -axis locations.

Specify the parabolic parameters and create a lane boundary model.

```
parabolicParams = [-0.005 0.15 0.55];  
lb = parabolicLaneBoundary(parabolicParams);
```

Compute the y -axis locations for given x -axis locations within the range of a camera sensor mounted to the front of a vehicle.

```
xWorld = 3:30; % in meters  
yWorld = computeBoundaryModel(lb,xWorld);
```

Plot the lane boundary points. To fit the coordinate system, flip the axis order and change the x -direction.

```
plot(yWorld,xWorld)  
axis equal  
set(gca,'XDir','reverse')
```

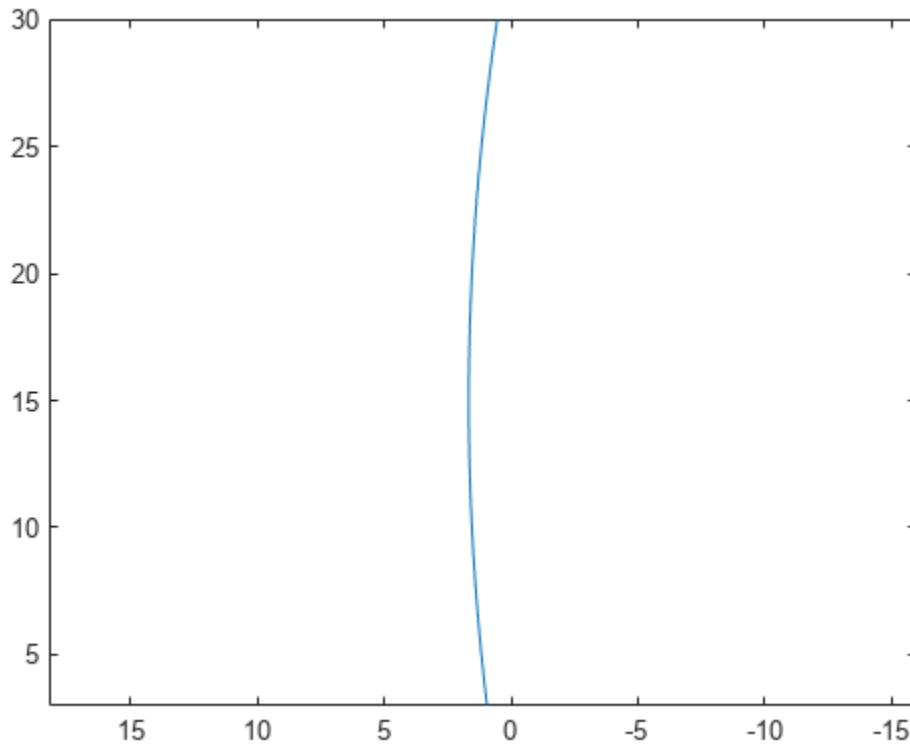

Plot Path of Ego Vehicle

Create a 3-meter-wide lane.

```
lb = parabolicLaneBoundary([-0.001,0.01,1.5]);
rb = parabolicLaneBoundary([-0.001,0.01,-1.5]);
```

Compute the lane boundary model manually from 0 to 30 meters along the x-axis.

```
xWorld = (0:30)';
yLeft = computeBoundaryModel(lb,xWorld);
yRight = computeBoundaryModel(rb,xWorld);
```

Create a bird's-eye plot and lane boundary plotter. Display the lane information on the bird's-eye plot.

```
bep = birdsEyePlot('XLimits',[0 30],'YLimits',[-5 5]);
lanePlotter = laneBoundaryPlotter(bep,'DisplayName','Lane boundaries');
plotLaneBoundary(lanePlotter,{[xWorld,yLeft],[xWorld,yRight]});
```

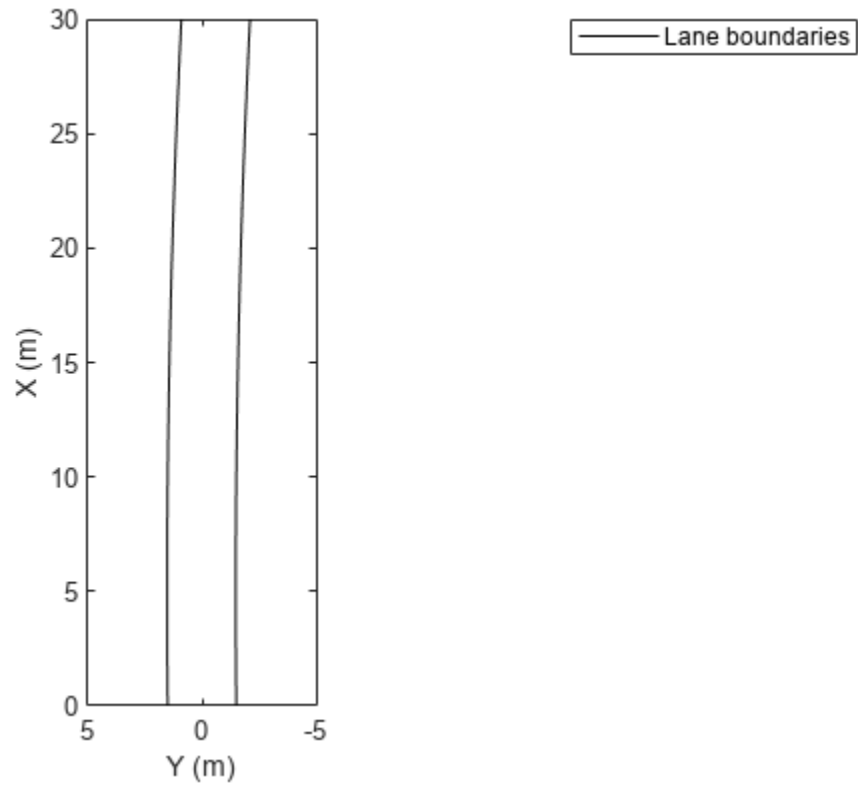

Create a path plotter. Create and display the path of an ego vehicle that travels through the center of the lane.

```
yCenter = (yLeft + yRight)/2;  
egoPathPlotter = pathPlotter(bep, 'DisplayName', 'Ego vehicle path');  
plotPath(egoPathPlotter, {[xWorld, yCenter]});
```

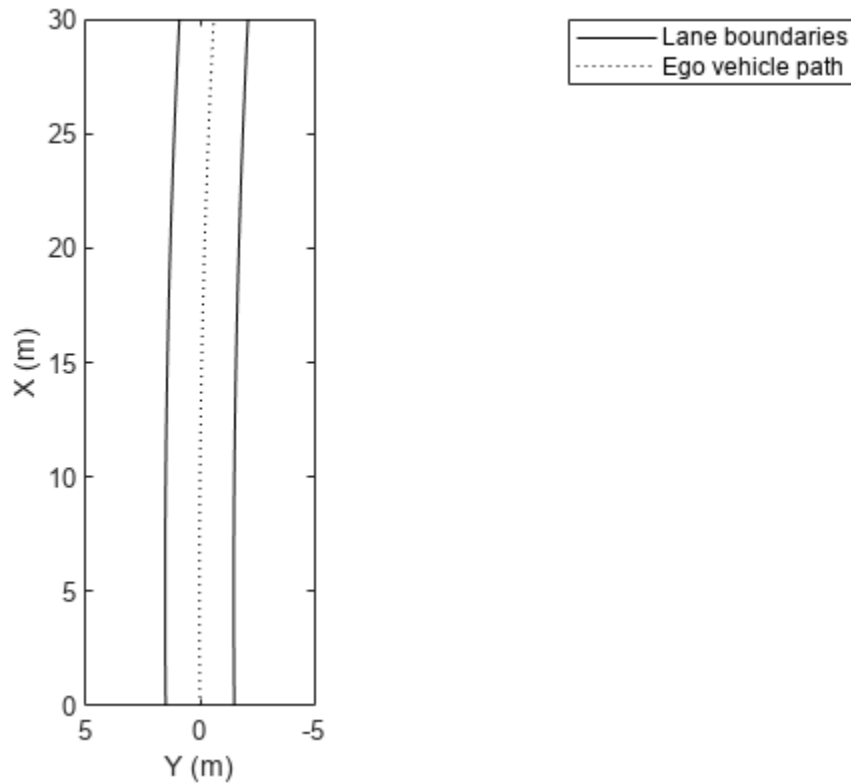
Find Candidate Ego Lane Boundaries

Find candidate ego lane boundaries from an array of lane boundaries.

Create an array of cubic lane boundaries.

```
lbs = [cubicLaneBoundary([-0.0001, 0.0, 0.003, 1.6]), ...
       cubicLaneBoundary([-0.0001, 0.0, 0.003, 4.6]), ...
       cubicLaneBoundary([-0.0001, 0.0, 0.003, -1.6]), ...
       cubicLaneBoundary([-0.0001, 0.0, 0.003, -4.6])];
```

For each lane boundary, compute the y-axis location at which the x-coordinate is 0.

```
xWorld = 0; % meters
yWorld = computeBoundaryModel(lbs,0);
```

Use the computed locations to find the ego lane boundaries that best meet the criteria.

```
leftEgoBoundaryIndex = find(yWorld == min(yWorld(yWorld>0)));
rightEgoBoundaryIndex = find(yWorld == max(yWorld(yWorld<=0)));
leftEgoBoundary = lbs(leftEgoBoundaryIndex);
rightEgoBoundary = lbs(rightEgoBoundaryIndex);
```

Plot the boundaries using a bird's-eye plot and lane boundary plotter.

```
bep = birdsEyePlot('XLimits',[0 30],'YLimits',[-5 5]);
lbPlotter = laneBoundaryPlotter(bep,'DisplayName','Left-lane boundary','Color','r');
rbPlotter = laneBoundaryPlotter(bep,'DisplayName','Right-lane boundary','Color','g');
plotLaneBoundary(lbPlotter,leftEgoBoundary)
plotLaneBoundary(rbPlotter,rightEgoBoundary)
```

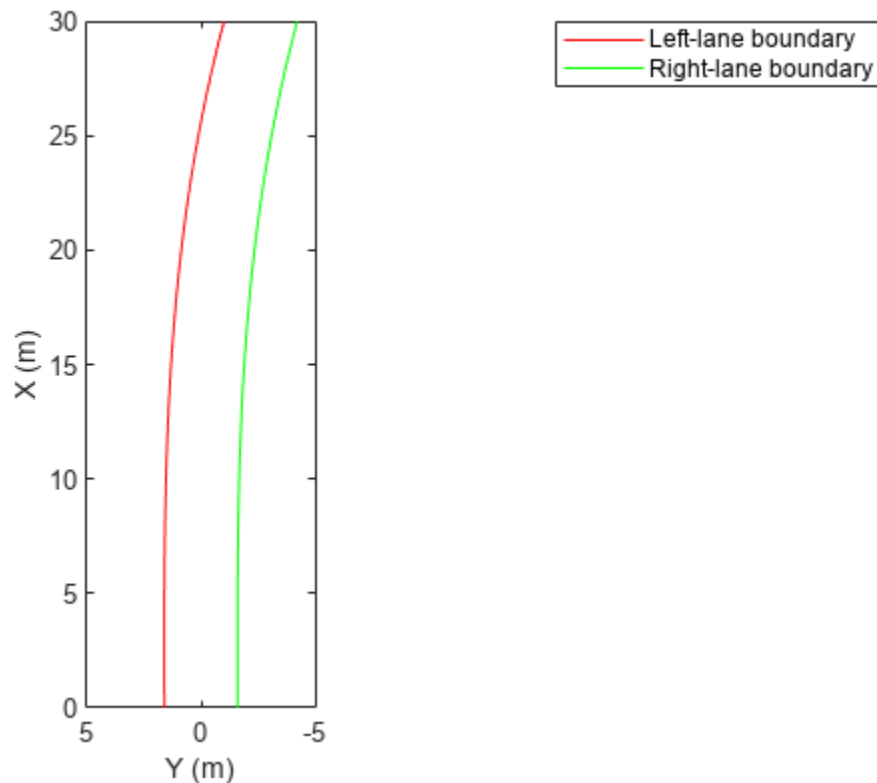

Input Arguments

boundaries — Lane boundary models

lane boundary object | array of lane boundary objects

Lane boundary models containing the parameters used to compute the y-axis coordinates, specified as a lane boundary object or an array of lane boundary objects. Valid objects are `parabolicLaneBoundary` and `cubicLaneBoundary`.

xWorld — x-axis locations of boundaries

real scalar | real-valued vector

x-axis locations of the boundaries in world coordinates, specified as a real scalar or real-valued vector.

Version History

Introduced in R2017a

Extended Capabilities

C/C++ Code Generation

Generate C and C++ code using MATLAB® Coder™.

See Also

Objects

`parabolicLaneBoundary` | `cubicLaneBoundary`

Functions

`insertLaneBoundary`

monoCamera

Configure monocular camera sensor

Description

The `monoCamera` object holds information about the configuration of a monocular camera sensor. Configuration information includes the camera intrinsics, camera extrinsics such as its orientation (as described by pitch, yaw, and roll), and the camera location within the vehicle. To estimate the intrinsic and extrinsic camera parameters, see “Calibrate a Monocular Camera”.

For images captured by the camera, you can use the `imageToVehicle` and `vehicleToImage` functions to transform point locations between image coordinates and vehicle coordinates. These functions apply projective transformations (homography), which enable you to estimate distances from a camera mounted on the vehicle to locations on a flat road surface.

Creation

Syntax

```
sensor = monoCamera(intrinsics,height)
sensor = monoCamera(intrinsics,height,Name,Value)
```

Description

`sensor = monoCamera(intrinsics,height)` creates a `monoCamera` object that contains the configuration of a monocular camera sensor, given the intrinsic parameters of the camera and the height of the camera above the ground. `intrinsics` and `height` set the `Intrinsics` and `Height` properties of the camera.

`sensor = monoCamera(intrinsics,height,Name,Value)` sets properties on page 4-1050 using one or more name-value pairs. For example, `monoCamera(intrinsics,1.5,'Pitch',1)` creates a monocular camera sensor that is 1.5 meters above the ground and has a 1-degree pitch toward the ground. Enclose each property name in quotes.

Properties

Intrinsics — Intrinsic camera parameters

`cameraIntrinsics` object | `cameraParameters` object

Intrinsic camera parameters, specified as either a `cameraIntrinsics` or `cameraParameters` object. The intrinsic camera parameters include the focal length and optical center of the camera, and the size of the image produced by the camera.

You can set this property when you create the object. After you create the object, this property is read-only.

Height — Height from road surface to camera sensor

real scalar

Height from the road surface to the camera sensor, specified as a real scalar. The height is the perpendicular distance from the ground to the focal point of the camera. Specify the height in world units, such as meters. To estimate this value, use the `estimateMonoCameraParameters` function.

Pitch – Pitch angle

real scalar

Pitch angle between the horizontal plane of the vehicle and the optical axis of the camera, specified as a real scalar in degrees. To estimate this value, use the `estimateMonoCameraParameters` function.

Pitch uses the ISO convention for rotation, with a clockwise positive angle direction when looking in the positive direction of the vehicle's Y_V axis.

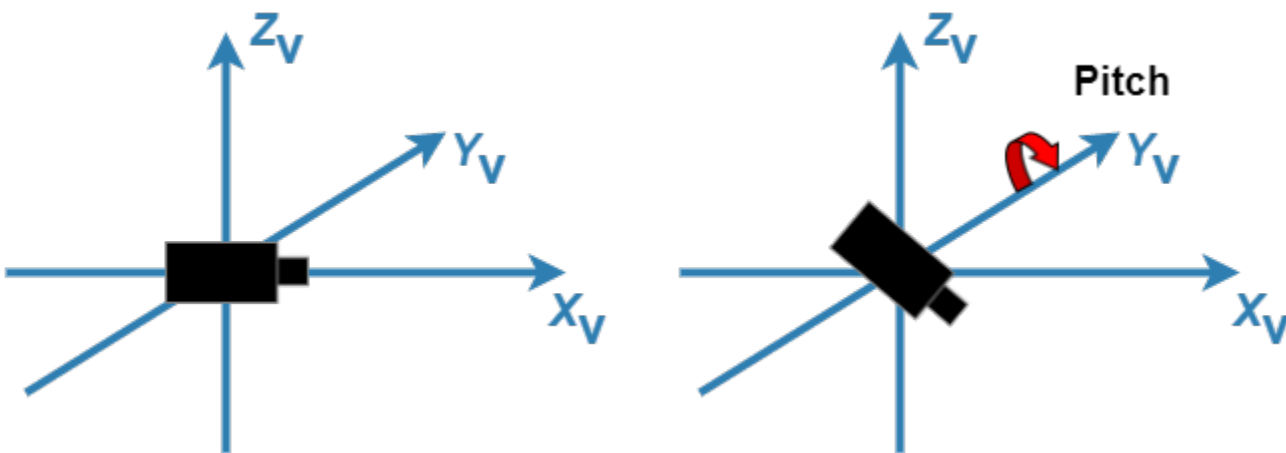

For more details, see “Angle Directions” on page 4-1060.

Yaw – Yaw angle

real scalar

Yaw angle between the X_V axis of the vehicle and the optical axis of the camera, specified as a real scalar in degrees. To estimate this value, use the `estimateMonoCameraParameters` function.

Yaw uses the ISO convention for rotation, with a clockwise positive angle direction when looking in the positive direction of the vehicle's Z_V axis.

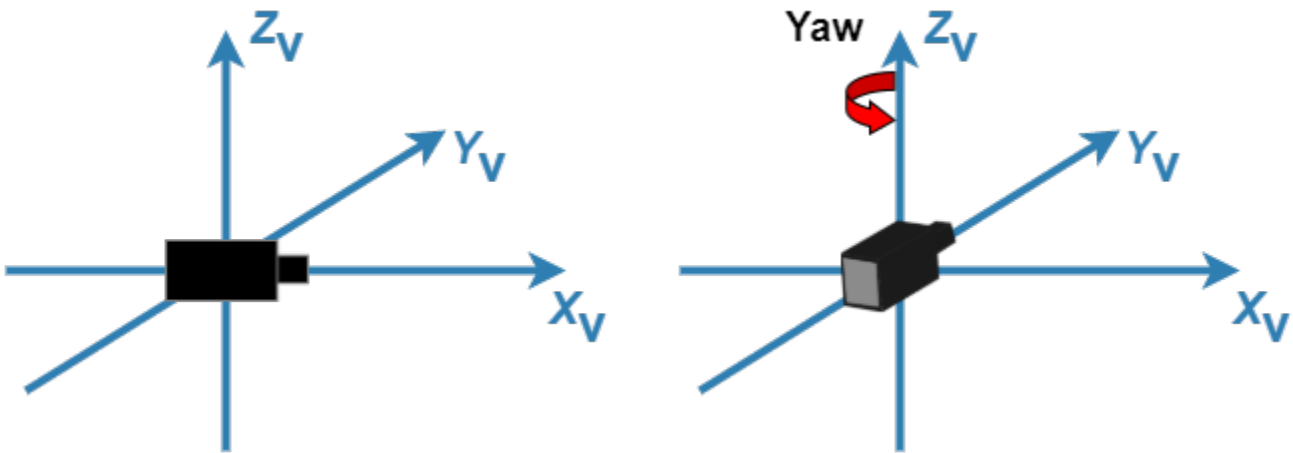

For more details, see “Angle Directions” on page 4-1060.

Roll – Roll angle

real scalar

Roll angle of the camera around its optical axis, returned as a real scalar in degrees. To estimate this value, use the `estimateMonoCameraParameters` function.

Roll uses the ISO convention for rotation, with a clockwise positive angle direction when looking in the positive direction of the vehicle's X_v axis.

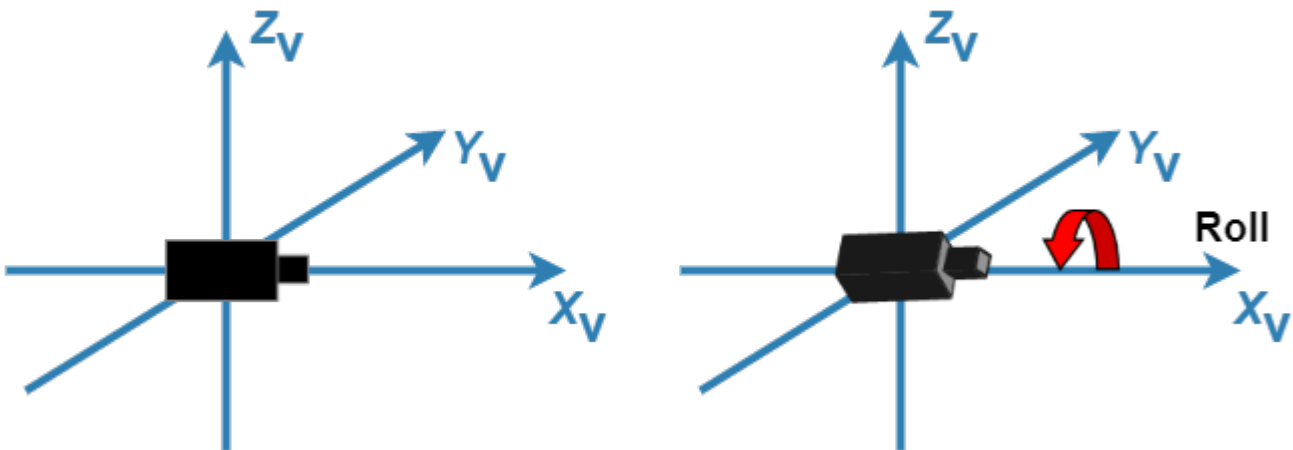

For more details, see “Angle Directions” on page 4-1060.

SensorLocation – Location of center of camera sensor

[0 0] (default) | two-element vector

Location of the center of the camera sensor, specified as a two-element vector of the form $[x \ y]$. Use this property to change the placement of the camera. Units are in the vehicle coordinate system (X_v , Y_v , Z_v).

By default, the camera sensor is located at the (X_v , Y_v) origin, at the height specified by `Height`.

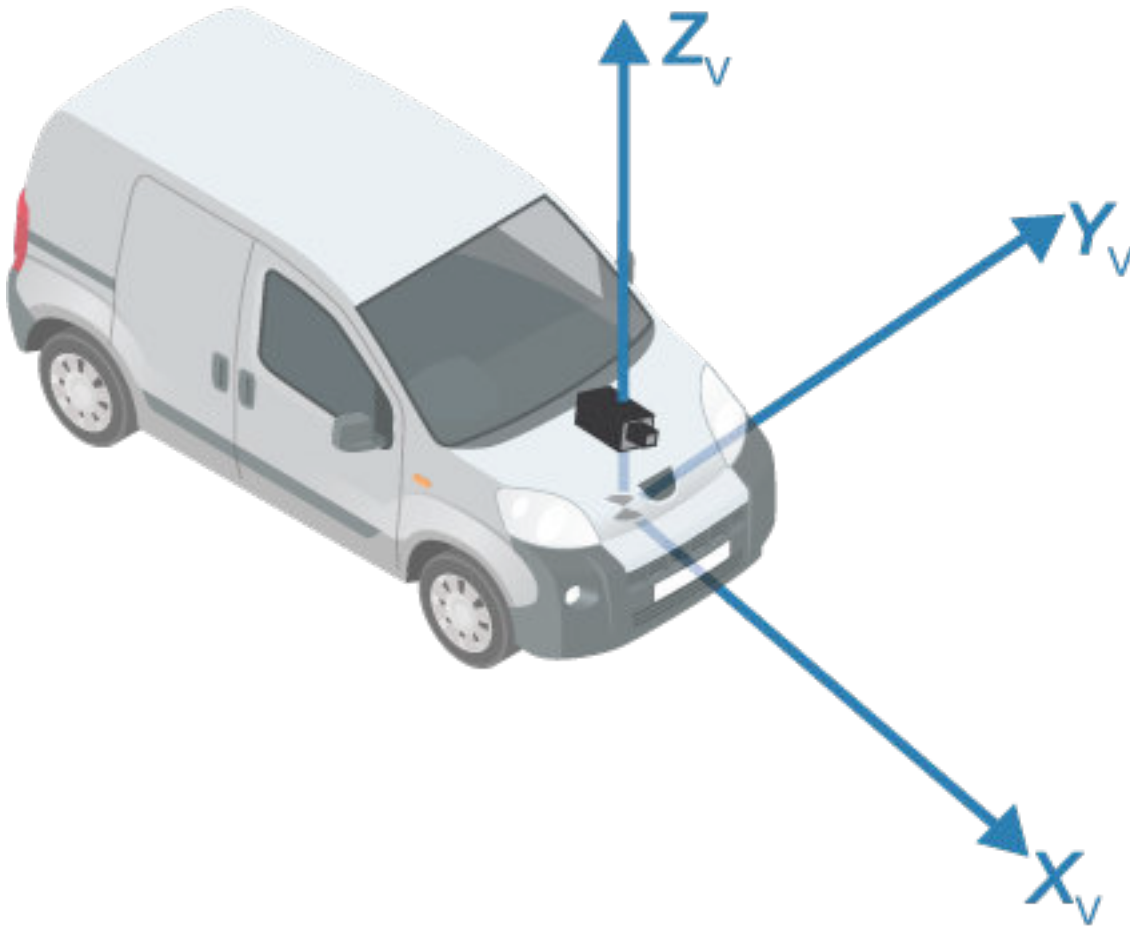

WorldUnits – World coordinate system units

'meters' | character vector | string scalar

World coordinate system units, specified as a character vector or string scalar. This property only stores the unit type and does not affect any calculations. Any text is valid.

You can set this property when you create the object. After you create the object, this property is read-only.

Object Functions

imageToVehicle Convert image coordinates to vehicle coordinates
vehicleToImage Convert vehicle coordinates to image coordinates

Examples

Create Monocular Camera Object

Create a forward-facing monocular camera sensor mounted on an ego vehicle. Examine an image captured from the camera and determine locations within the image in both vehicle and image coordinates.

Set the intrinsic parameters of the camera. Specify the focal length, the principal point of the image plane, and the output image size. Units are in pixels. Save the intrinsics as a `cameraIntrinsics` object.

```
focalLength = [800 800];  
principalPoint = [320 240];  
imageSize = [480 640];
```

```
intrinsics = cameraIntrinsics(focalLength,principalPoint,imageSize);
```

Specify the position of the camera. Position the camera 2.18 meters above the ground with a 14-degree pitch toward the ground.

```
height = 2.18;  
pitch = 14;
```

Define a monocular camera sensor using the intrinsic camera parameters and the position of the camera. Load an image from the camera.

```
sensor = monoCamera(intrinsics,height,'Pitch',pitch);
```

```
Ioriginal = imread('road.png');  
figure  
imshow(Ioriginal)  
title('Original Image')
```

Original Image



Determine the image coordinates of a point 10 meters directly in front of the camera. The X-axis points forward from the camera and the Y-axis points to the left.

```
xyVehicleLoc1 = [10 0];  
xyImageLoc1 = vehicleToImage(sensor,xyVehicleLoc1)
```

```
xyImageLoc1 = 1x2  
    320.0000    216.2296
```

Display the point on the image.

```
IvehicleToImage = insertMarker(Ioriginal,xyImageLoc1);  
IvehicleToImage = insertText(IvehicleToImage,xyImageLoc1 + 5,'10 meters');  
figure  
imshow(IvehicleToImage)  
title('Vehicle-to-Image Point')
```

Vehicle-to-Image Point



Determine the vehicle coordinates of a point that lies on the road surface in the image.

```
xyImageLoc2 = [300 300];
xyVehicleLoc2 = imageToVehicle(sensor,xyImageLoc2)
```

```
xyVehicleLoc2 = 1×2
    6.5959    0.1732
```

The point is about 6.6 meters in front of the vehicle and about 0.17 meters to the left of the vehicle center.

Display the vehicle coordinates of the point on the image.

```
IimageToVehicle = insertMarker(Ioriginal,xyImageLoc2);
displayText = sprintf('%.2f m, %.2f m',xyVehicleLoc2);
IimageToVehicle = insertText(IimageToVehicle,xyImageLoc2 + 5,displayText);
```

```
figure
imshow(IimageToVehicle)
title('Image-to-Vehicle Point')
```

Image-to-Vehicle Point



Generate Visual Detections from Monocular Camera

Create a vision sensor by using a monocular camera configuration, and generate detections from that sensor.

Specify the intrinsic parameters of the camera and create a `monoCamera` object from these parameters. The camera is mounted on top of an ego vehicle at a height of 1.5 meters above the ground and a pitch of 1 degree toward the ground.

```
focalLength = [800 800];  
principalPoint = [320 240];  
imageSize = [480 640];  
intrinsics = cameraIntrinsics(focalLength,principalPoint,imageSize);
```

```
height = 1.5;  
pitch = 1;  
monoCamConfig = monoCamera(intrinsics,height,'Pitch',pitch);
```

Create a vision detection generator using the monocular camera configuration.

```
visionSensor = visionDetectionGenerator(monoCamConfig);
```

Generate a driving scenario with an ego vehicle and two target cars. Position the first target car 30 meters directly in front of the ego vehicle. Position the second target car 20 meters in front of the ego vehicle but offset to the left by 3 meters.

```
scenario = drivingScenario;
egoVehicle = vehicle(scenario, 'ClassID', 1);
targetCar1 = vehicle(scenario, 'ClassID', 1, 'Position', [30 0 0]);
targetCar2 = vehicle(scenario, 'ClassID', 1, 'Position', [20 3 0]);
```

Use a bird's-eye plot to display the vehicle outlines and sensor coverage area.

```
figure
bep = birdsEyePlot('XLim', [0 50], 'YLim', [-20 20]);

olPlotter = outlinePlotter(bep);
[position, yaw, length, width, originOffset, color] = targetOutlines(egoVehicle);
plotOutline(olPlotter, position, yaw, length, width);

caPlotter = coverageAreaPlotter(bep, 'DisplayName', 'Coverage area', 'FaceColor', 'blue');
plotCoverageArea(caPlotter, visionSensor.SensorLocation, visionSensor.MaxRange, ...
    visionSensor.Yaw, visionSensor.FieldOfView(1))
```

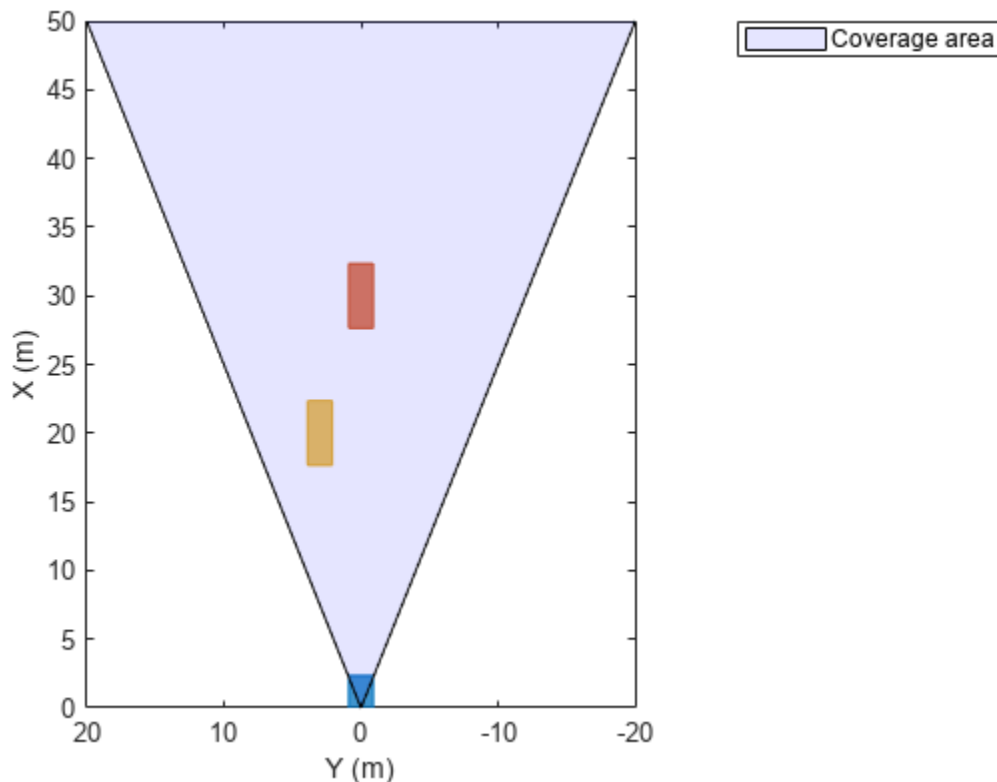

Obtain the poses of the target cars from the perspective of the ego vehicle. Use these poses to generate detections from the sensor.

```
poses = targetPoses(egoVehicle);
[dets, numValidDets] = visionSensor(poses, scenario.SimulationTime);
```

Display the (X,Y) positions of the valid detections. For each detection, the (X,Y) positions are the first two values of the Measurement field.

```
for i = 1:numValidDets
    XY = dets{i}.Measurement(1:2);
    detXY = sprintf('Detection %d: X = %.2f meters, Y = %.2f meters',i,XY);
    disp(detXY)
end
```

```
Detection 1: X = 19.09 meters, Y = 2.79 meters
Detection 2: X = 27.81 meters, Y = 0.08 meters
```

More About

Vehicle Coordinate System

In the vehicle coordinate system (X_V , Y_V , Z_V) defined by monoCamera:

- The X_V -axis points forward from the vehicle.
- The Y_V -axis points to the left, as viewed when facing forward.
- The Z_V -axis points up from the ground to maintain the right-handed coordinate system.

The default origin of this coordinate system is on the road surface, directly below the camera center. The focal point of the camera defines this center point.

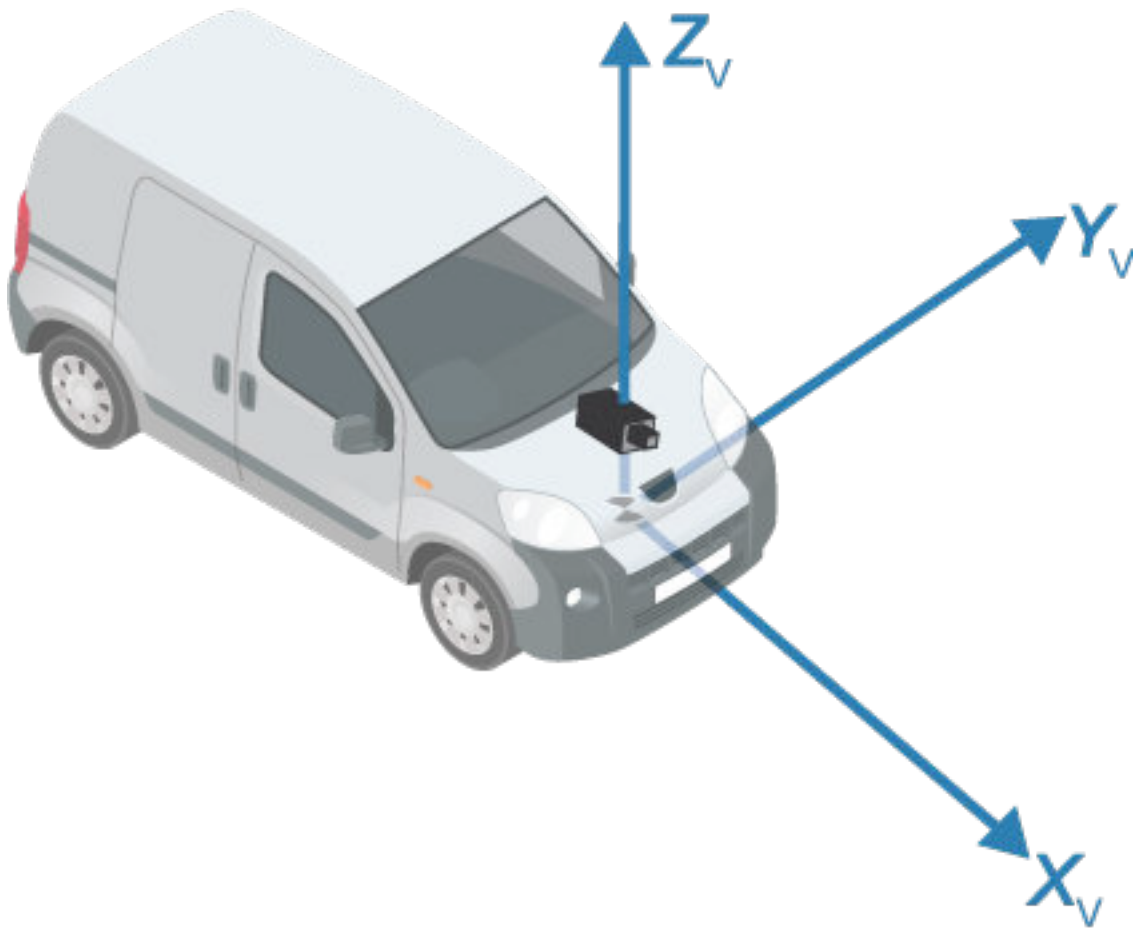

To change the placement of the origin within the vehicle coordinate system, update the `SensorLocation` property.

For more details about the vehicle coordinate system, see “Coordinate Systems in Automated Driving Toolbox”.

Angle Directions

The monocular camera sensor uses clockwise positive angle directions when looking in the positive direction of the Z -, Y -, and X -axes, respectively.

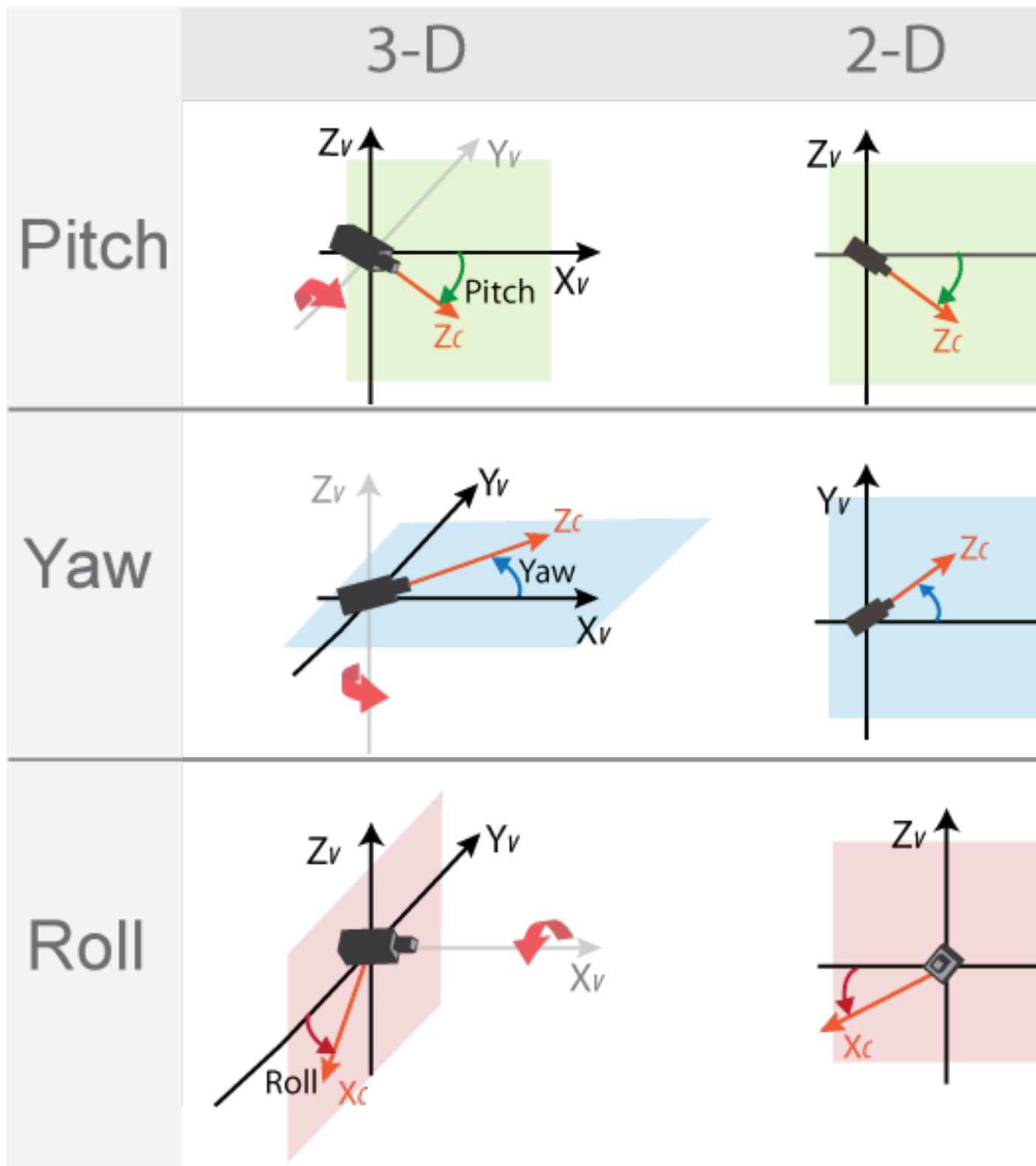

Version History

Introduced in R2017a

R2018a: Direction of yaw angle rotation adjusted

Behavior changed in R2018a

Starting in R2018a, the `monoCamera` object uses the correct direction of rotation for the yaw angle. When you look in the positive direction of the vehicle's Z-axis, the yaw angle is now positive in the clockwise direction. Previously, this angle was positive in the counterclockwise direction.

If you are using R2017b or earlier, to use the correct direction of rotation, update the yaw angle to its negative value. For example, to update the yaw angle for a `monoCamera` object named `sensor`, use this code:

```
sensor.Yaw = -sensor.Yaw;
```

Extended Capabilities

C/C++ Code Generation

Generate C and C++ code using MATLAB® Coder™.

See Also

Apps

Camera Calibrator

Functions

`estimateCameraParameters` | `extrinsics` | `estimateMonoCameraParameters`

Objects

`birdsEyeView` | `cameraParameters` | `cameraIntrinsics`

Topics

“Calibrate a Monocular Camera”

“Configure Monocular Fisheye Camera”

“Visual Perception Using Monocular Camera”

“Coordinate Systems in Automated Driving Toolbox”

vehicleToImage

Convert vehicle coordinates to image coordinates

Syntax

```
imagePoints = vehicleToImage(monoCam,vehiclePoints)
```

Description

`imagePoints = vehicleToImage(monoCam,vehiclePoints)` converts $[x\ y]$ or $[x\ y\ z]$ vehicle coordinates to $[x\ y]$ image coordinates by applying a projective transformation. The monocular camera object, `monoCam`, contains the camera parameters.

Examples

Create Monocular Camera Object

Create a forward-facing monocular camera sensor mounted on an ego vehicle. Examine an image captured from the camera and determine locations within the image in both vehicle and image coordinates.

Set the intrinsic parameters of the camera. Specify the focal length, the principal point of the image plane, and the output image size. Units are in pixels. Save the intrinsics as a `cameraIntrinsics` object.

```
focalLength = [800 800];  
principalPoint = [320 240];  
imageSize = [480 640];
```

```
intrinsics = cameraIntrinsics(focalLength,principalPoint,imageSize);
```

Specify the position of the camera. Position the camera 2.18 meters above the ground with a 14-degree pitch toward the ground.

```
height = 2.18;  
pitch = 14;
```

Define a monocular camera sensor using the intrinsic camera parameters and the position of the camera. Load an image from the camera.

```
sensor = monoCamera(intrinsics,height,'Pitch',pitch);
```

```
Ioriginal = imread('road.png');  
figure  
imshow(Ioriginal)  
title('Original Image')
```

Original Image



Determine the image coordinates of a point 10 meters directly in front of the camera. The X-axis points forward from the camera and the Y-axis points to the left.

```
xyVehicleLoc1 = [10 0];  
xyImageLoc1 = vehicleToImage(sensor,xyVehicleLoc1)
```

```
xyImageLoc1 = 1x2  
    320.0000    216.2296
```

Display the point on the image.

```
IvehicleToImage = insertMarker(Ioriginal,xyImageLoc1);  
IvehicleToImage = insertText(IvehicleToImage,xyImageLoc1 + 5,'10 meters');  
figure  
imshow(IvehicleToImage)  
title('Vehicle-to-Image Point')
```

Vehicle-to-Image Point



Determine the vehicle coordinates of a point that lies on the road surface in the image.

```
xyImageLoc2 = [300 300];
xyVehicleLoc2 = imageToVehicle(sensor,xyImageLoc2)
```

```
xyVehicleLoc2 = 1×2
    6.5959    0.1732
```

The point is about 6.6 meters in front of the vehicle and about 0.17 meters to the left of the vehicle center.

Display the vehicle coordinates of the point on the image.

```
IimageToVehicle = insertMarker(Ioriginal,xyImageLoc2);
displayText = sprintf('%.2f m, %.2f m',xyVehicleLoc2);
IimageToVehicle = insertText(IimageToVehicle,xyImageLoc2 + 5,displayText);
```

```
figure
imshow(IimageToVehicle)
title('Image-to-Vehicle Point')
```

Image-to-Vehicle Point



Input Arguments

monoCam — Monocular camera parameters

monoCamera object

Monocular camera parameters, specified as a monoCamera object.

vehiclePoints — Vehicle points

M -by-2 matrix | M -by-3 matrix

Vehicle points, specified as an M -by-2 or M -by-3 matrix containing M number of $[x\ y]$ or $[x\ y\ z]$ vehicle coordinates.

Output Arguments

imagePoints — Image points

M -by-2 matrix

Image points, returned as an M -by-2 matrix containing M number of $[x\ y]$ image coordinates.

More About

Vehicle Coordinate System

In the vehicle coordinate system (X_V , Y_V , Z_V) defined by `vehicleToImage`:

- The X_V -axis points forward from the vehicle.
- The Y_V -axis points to the left, as viewed when facing forward.
- The Z_V -axis points up from the ground to maintain the right-handed coordinate system.

The default origin of this coordinate system is on the road surface, directly below the camera center. The focal point of the camera defines this center point.

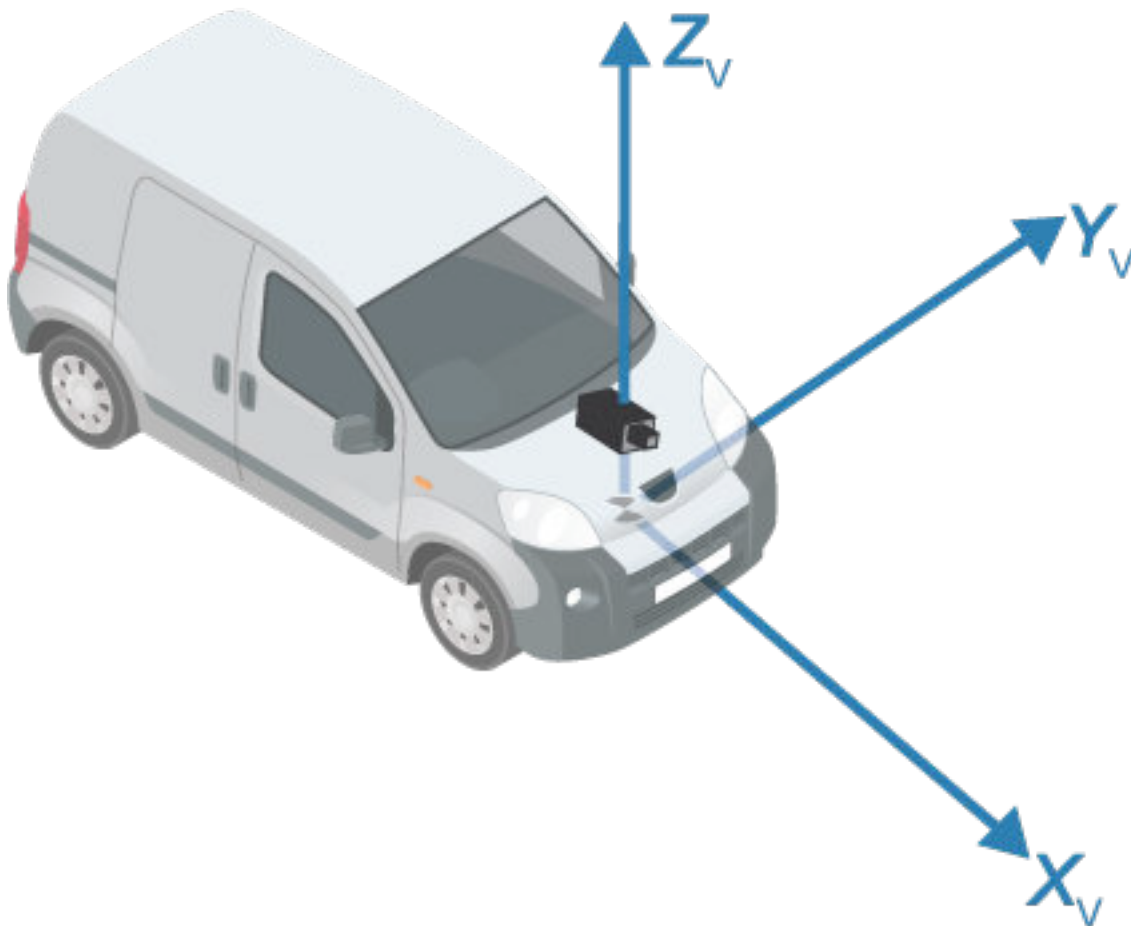

To change the placement of the origin within the vehicle coordinate system, update the `SensorLocation` property.

For more details about the vehicle coordinate system, see “Coordinate Systems in Automated Driving Toolbox”.

Angle Directions

The monocular camera sensor uses clockwise positive angle directions when looking in the positive direction of the Z -, Y -, and X -axes, respectively.

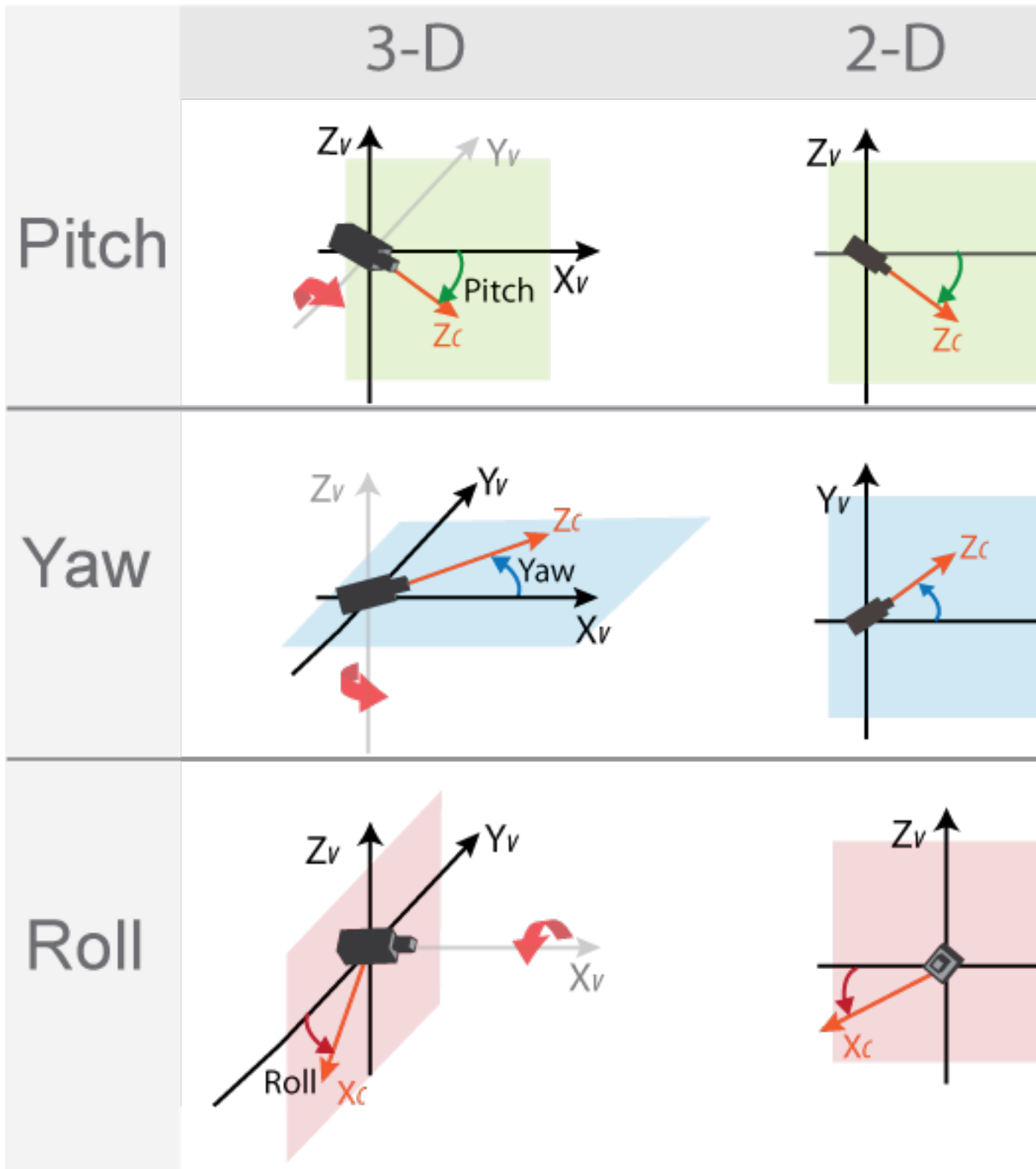

Version History

Introduced in R2017a

Extended Capabilities

C/C++ Code Generation

Generate C and C++ code using MATLAB® Coder™.

See Also

Objects

monoCamera

Functions

imageToVehicle

Topics

“Coordinate Systems in Automated Driving Toolbox”

imageToVehicle

Convert image coordinates to vehicle coordinates

Syntax

```
vehiclePoints = imageToVehicle(monoCam,imagePoints)
```

Description

`vehiclePoints = imageToVehicle(monoCam,imagePoints)` converts image coordinates to [x y] vehicle coordinates by applying a projective transformation. The monocular camera object, `monoCam`, contains the camera parameters.

Examples

Create Monocular Camera Object

Create a forward-facing monocular camera sensor mounted on an ego vehicle. Examine an image captured from the camera and determine locations within the image in both vehicle and image coordinates.

Set the intrinsic parameters of the camera. Specify the focal length, the principal point of the image plane, and the output image size. Units are in pixels. Save the intrinsics as a `cameraIntrinsics` object.

```
focalLength = [800 800];  
principalPoint = [320 240];  
imageSize = [480 640];
```

```
intrinsics = cameraIntrinsics(focalLength,principalPoint,imageSize);
```

Specify the position of the camera. Position the camera 2.18 meters above the ground with a 14-degree pitch toward the ground.

```
height = 2.18;  
pitch = 14;
```

Define a monocular camera sensor using the intrinsic camera parameters and the position of the camera. Load an image from the camera.

```
sensor = monoCamera(intrinsics,height,'Pitch',pitch);
```

```
Ioriginal = imread('road.png');  
figure  
imshow(Ioriginal)  
title('Original Image')
```

Original Image



Determine the image coordinates of a point 10 meters directly in front of the camera. The X-axis points forward from the camera and the Y-axis points to the left.

```
xyVehicleLoc1 = [10 0];  
xyImageLoc1 = vehicleToImage(sensor,xyVehicleLoc1)
```

```
xyImageLoc1 = 1x2  
    320.0000    216.2296
```

Display the point on the image.

```
IvehicleToImage = insertMarker(Ioriginal,xyImageLoc1);  
IvehicleToImage = insertText(IvehicleToImage,xyImageLoc1 + 5,'10 meters');  
figure  
imshow(IvehicleToImage)  
title('Vehicle-to-Image Point')
```

Vehicle-to-Image Point



Determine the vehicle coordinates of a point that lies on the road surface in the image.

```
xyImageLoc2 = [300 300];  
xyVehicleLoc2 = imageToVehicle(sensor,xyImageLoc2)
```

```
xyVehicleLoc2 = 1×2  
    6.5959    0.1732
```

The point is about 6.6 meters in front of the vehicle and about 0.17 meters to the left of the vehicle center.

Display the vehicle coordinates of the point on the image.

```
IimageToVehicle = insertMarker(Ioriginal,xyImageLoc2);  
displayText = sprintf('%.2f m, %.2f m',xyVehicleLoc2);  
IimageToVehicle = insertText(IimageToVehicle,xyImageLoc2 + 5,displayText);
```

```
figure  
imshow(IimageToVehicle)  
title('Image-to-Vehicle Point')
```

Image-to-Vehicle Point



Input Arguments

monoCam — Monocular camera parameters

monoCamera object

Monocular camera parameters, specified as a monoCamera object.

imagePoints — Image points

M -by-2 matrix

Image points, specified as an M -by-2 matrix containing M number of $[x\ y]$ image coordinates.

Output Arguments

vehiclePoints — Vehicle points

M -by-2 matrix

Vehicle points, returned as an M -by-2 matrix containing M number of $[x\ y]$ vehicle coordinates.

Version History

Introduced in R2017a

Extended Capabilities

C/C++ Code Generation

Generate C and C++ code using MATLAB® Coder™.

See Also

Objects

monoCamera

Functions

vehicleToImage

Topics

“Coordinate Systems in Automated Driving Toolbox”

vision.labeler.loading.MultiSignalSource class

Package: vision.labeler.loading vision.labeler.loading vision.labeler.loading
vision.labeler.loading vision.labeler.loading vision.labeler.loading

Superclasses: matlab.mixin.Heterogeneous

Interface for loading signal data into Ground Truth Labeler app

Description

The `vision.labeler.loading.MultiSignalSource` class creates an interface for loading signals from a data source into the **Ground Truth Labeler** app. The data source can be a file format or any custom source.

The interface created using this class enables you to customize the panel for loading custom data sources in the Add/Remove Signal dialog box of the app. The figure shows a sample loading panel.

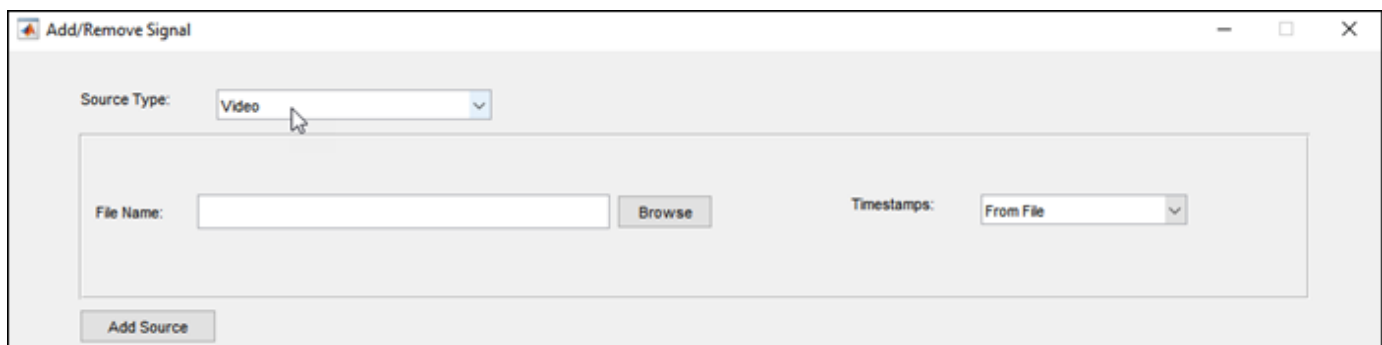

The class also provides an interface to read frames from loaded signals. The app renders these frames for labeling.

To define a custom class to load a data source into the app, follow these steps.

- 1 Create a class that inherits from the `vision.labeler.loading.MultiSignalSource` class. The class definition must have this format, where `customSourceClass` is the name of your custom data source class.

```
classdef customSourceClass < vision.labeler.loading.MultiSignalSource
```

- 2 Save the class to this folder, where `matlabroot` is the full path to your MATLAB installation folder as returned by the `matlabroot` function.

```
<matlabroot>\toolbox\vision\vision\+vision\+labeler\+loading
```

Alternatively, create a `+vision/+labeler/+loading` folder structure, add these folders to the MATLAB search path, and save the class to the `+vision/+labeler/+loading` folder. The **Ground Truth Labeler** app recognizes data source classes in folders with this path only.

- 3 Define the class properties and methods required to load the data source into the app. This table shows the predefined custom classes that you can use as starting points for defining these properties and methods.

Class	Data Source Loaded by Class	Command to View Class Source Code
vision.labeler.loading.VideoSource	Video file	edit vision.labeler.loading.VideoSource
vision.labeler.loading.ImageSequenceSource	Image sequence folder	edit vision.labeler.loading.ImageSequenceSource
vision.labeler.loading.VelodyneLidarSource	Velodyne packet capture (PCAP) file	edit vision.labeler.loading.VelodyneLidarSource
vision.labeler.loading.RosbagSource	Rosbag file	edit vision.labeler.loading.RosbagSource
vision.labeler.loading.PointCloudSequenceSource	Point cloud sequence folder	edit vision.labeler.loading.PointCloudSequenceSource
vision.labeler.loading.CustomImageSource	Custom image format	edit vision.labeler.loading.CustomImageSource

For an explanation of the required properties and methods used for defining a custom data source class, see the “Create Class for Loading Custom Ground Truth Data Sources” example.

The `vision.labeler.loading.MultiSignalSource` class is a `handle` class.

Class Attributes

Abstract true

For information on class attributes, see “Class Attributes”.

Properties

Name — Name of source type

`string scalar`

Name of the type of source that this class loads, specified as a string scalar.

Attributes:

GetAccess	public
Abstract	true
Constant	true
NonCopyable	true

Description — Description of class functionality

`string scalar`

Description of the functionality that this class provides, specified as a string scalar.

Attributes:

GetAccess	public
Abstract	true
Constant	true
NonCopyable	true

SourceName — Name of data source

string scalar

Name of the data source, specified as a string scalar. Typically, SourceName is the name of the file from which the signal is loaded.

Attributes:

GetAccess	public
SetAccess	protected

SourceParams — Parameters for loading signals from data source

structure

Parameters for loading signals from the data source into the app, specified as a structure. The fields of this structure contain values that the loadSource method requires to load the signal.

Attributes:

GetAccess	public
SetAccess	protected

SignalName — Names of signals in data source

string vector

Names of the signals that can be loaded from the data source, specified as a string vector.

Attributes:

GetAccess	public
SetAccess	protected

SignalType — Types of signals in data source

vector of vision.labeler.loading.SignalType enumerations

Types of the signals that can be loaded from the data source, specified as a vector of vision.labeler.loading.SignalType enumerations. Each signal listed in the SignalName property is of the type in the corresponding position of SignalType.

Attributes:

GetAccess	public
SetAccess	protected

Timestamp — Timestamps of signals in data source

cell array of duration vectors

Timestamps of the signals that can be loaded from the data source, specified as a cell array of duration vectors. Each signal listed in the SignalName property has the timestamps in the corresponding position of Timestamp.

Attributes:

GetAccess	public
SetAccess	protected

NumSignals — Number of signals in data source

nonnegative integer

Number of signals that can be read from the data source, specified as a nonnegative integer. NumSignals is equal to the number of signals in the SignalName property.

Attributes:

GetAccess	public
SetAccess	public
Dependent	true
NonCopyable	true

Methods**Public Methods**

customizeLoadPanel	<p>customizeLoadPanel(sourceObj, panel)</p> <p>Customize the loading panel for the data source object. In the loading dialog box of the app, this method is invoked when you select the data source type from the Source Type list.</p> <table border="1" data-bbox="862 1108 1479 1161"> <tr> <td>Abstract</td> <td>true</td> </tr> </table>	Abstract	true
Abstract	true		
getLoadPanelData	<p>[sourceName, sourceParams] = getLoadPanelData(sourceObj)</p> <p>Obtain the data needed to load the data source object currently selected in the loading panel. In the loading dialog box of the app, this method is invoked when you add a source. The method returns these outputs.</p> <ul style="list-style-type: none"> • sourceName is a string capturing the name of the data source object. • sourceParams is a structure with fields containing the parameters required to load the data source object. <p>Both of these outputs are passed to the LoadSource method.</p> <table border="1" data-bbox="862 1675 1479 1717"> <tr> <td>Abstract</td> <td>true</td> </tr> </table>	Abstract	true
Abstract	true		

loadSource	<p>loadSource(sourceObj, sourceName, sourceParams)</p> <p>Load a data source object into the app. In the loading dialog box of the app, this method is invoked after you add a source and the <code>getLoadPanelData</code> method executes successfully. This method is also invoked when you load the data source object into the MATLAB workspace. When you load the data source object, MATLAB expects that the source has the name <code>sourceName</code> and parameters <code>sourceParams</code> that are needed to load that source and read data from it.</p> <table border="1" data-bbox="862 667 1472 716"> <tr> <td>Abstract</td> <td>true</td> </tr> </table>	Abstract	true
Abstract	true		
readFrame	<p>frame = readFrame(sourceObj, signalName, tsIndex)</p> <p>Read a frame of data from a signal contained in a data source object at the specified timestamp index. The index must be in the bounds of the length of the timestamps for that signal.</p> <table border="1" data-bbox="862 919 1472 968"> <tr> <td>Abstract</td> <td>true</td> </tr> </table>	Abstract	true
Abstract	true		
loadPanelChecker	<p>loadPanelChecker</p> <p>Check the load panel for the loading dialog box of the app. This method opens a dialog box similar to the loading dialog box that you open from the Open menu on the app toolbar. Use this method to preview how the <code>customizeLoadPanel</code> method populates the loading panel for the selected data source object.</p> <table border="1" data-bbox="862 1262 1472 1302"> <tr> <td>Static</td> <td>true</td> </tr> </table>	Static	true
Static	true		

Version History

Introduced in R2020a

See Also

Apps

Ground Truth Labeler

Classes

vision.labeler.AutomationAlgorithm | driving.connector.Connector

Topics

“Sources vs. Signals in Ground Truth Labeling”

“Create Class for Loading Custom Ground Truth Data Sources”

vision.labeler.loading.VideoSource class

Package: vision.labeler.loading vision.labeler.loading vision.labeler.loading
vision.labeler.loading vision.labeler.loading vision.labeler.loading
Superclasses: vision.labeler.loading.MultiSignalSource

Load signals from video sources into Ground Truth Labeler app

Description

The `vision.labeler.loading.VideoSource` class creates an interface for loading signals from video data sources into the **Ground Truth Labeler** app. In the Add/Remove Signal dialog box of the app, when **Source Type** is set to Video, this class controls the parameters in that dialog box.

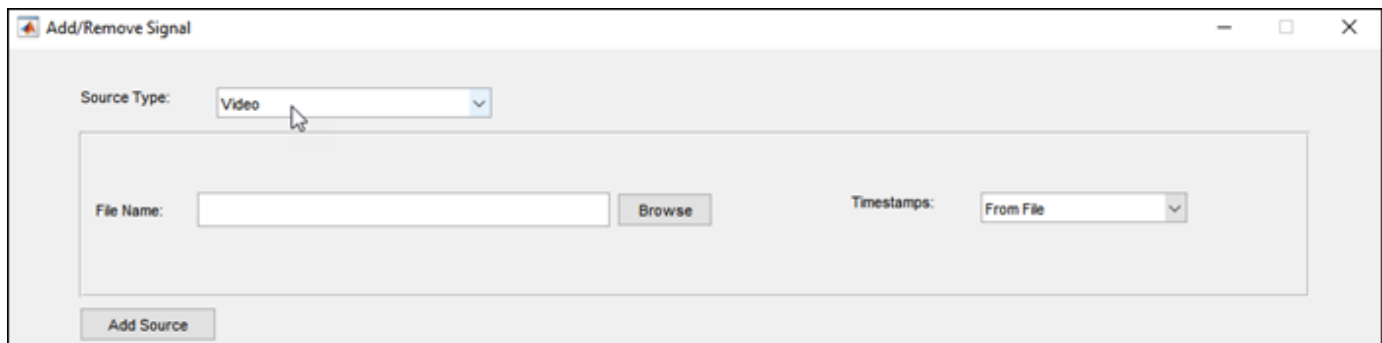

To access this dialog box, in the app, select **Import > Add Signals**.

The default implementation of this class loads the video formats accepted by the `VideoReader` object.

The `vision.labeler.loading.VideoSource` class is a `handle` class.

Creation

When you export labels from a **Ground Truth Labeler** app session that contains video sources, the exported `groundTruthMultisignal` object stores instances of this class in its `DataSource` property.

To create a `VideoSource` object programmatically, such as when programmatically creating a `groundTruthMultisignal` object, use the `vision.labeler.loading.VideoSource` function (described here).

Syntax

```
vidSource = vision.labeler.loading.VideoSource
```

Description

`vidSource = vision.labeler.loading.VideoSource` creates a `VideoSource` object for loading signals from video data sources. To specify the data source and the parameters required to load the source, use the `loadSource` method.

Properties

Name — Name of source type

"Video" (default) | string scalar

Name of the type of source that this class loads, specified as a string scalar.

Attributes:

GetAccess	public
Constant	true
NonCopyable	true

Description — Description of class functionality

"A video reader" (default) | string scalar

Description of the functionality that this class provides, specified as a string scalar.

Attributes:

GetAccess	public
Constant	true
NonCopyable	true

SourceName — Name of data source

[] (default) | string scalar

Name of the data source, specified as a string scalar. Typically, `SourceName` is the name of the file from which the signal is loaded.

Attributes:

GetAccess	public
SetAccess	protected

SourceParams — Parameters for loading video signal from data source

[] (default) | structure

Parameters for loading a video signal from a data source, specified as a structure.

This table describes the required and optional fields of the `SourceParams` structure.

Field	Description	Required or Optional
Timestamps	<p>Timestamps for the video signal, specified as a cell array containing a single <code>duration</code> vector of timestamps.</p> <p>In the Add/Remove Signal dialog box of the app, if you set the Timestamps parameter to From Workspace and read the timestamps from a variable in the MATLAB workspace, then the <code>SourceParams</code> property stores these timestamps in the <code>Timestamps</code> field.</p>	<p>Optional</p> <p>In the Add/Remove Signal dialog box of the app, if you set the Timestamps parameter to From File and read the timestamps from the video file, then the structure does not include this field, and the <code>SourceParams</code> property is empty, <code>[]</code>.</p>

Attributes:

```
GetAccess          public
SetAccess          protected
```

SignalName — Names of signals in data source

`[]` (default) | string vector

Names of the signals that can be loaded from the data source, specified as a string vector.

Attributes:

```
GetAccess          public
SetAccess          protected
```

SignalType — Types of signals in data source

`[]` (default) | vector of `vision.labeler.loading.SignalType` enumerations

Types of the signals that can be loaded from the data source, specified as a vector of `vision.labeler.loading.SignalType` enumerations. Each signal listed in the `SignalName` property is of the type in the corresponding position of `SignalType`.

Attributes:

```
GetAccess          public
SetAccess          protected
```

Timestamp — Timestamps of signals in data source

`[]` (default) | cell array of `duration` vectors

Timestamps of the signals that can be loaded from the data source, specified as a cell array of `duration` vectors. Each signal listed in the `SignalName` property has the timestamps in the corresponding position of `Timestamp`.

Attributes:

```
GetAccess          public
SetAccess          protected
```

NumSignals — Number of signals in data source

0 (default) | integer

Number of signals that can be read from the data source, specified as a nonnegative integer. NumSignals is equal to the number of signals in the SignalName property.

Attributes:

GetAccess	public
SetAccess	public
Dependent	true
NonCopyable	true

Methods**Public Methods**

customizeLoadPanel	<p>customizeLoadPanel(sourceObj, panel)</p> <p>Customize the loading panel for the data source object. In the loading dialog box of the app, this method is invoked when you select the data source type from the Source Type list.</p>
getLoadPanelData	<p>[sourceName, sourceParams] = getLoadPanelData(sourceObj)</p> <p>Obtain the data needed to load the data source object currently selected in the loading panel. In the loading dialog box of the app, this method is invoked when you add a source. The method returns these outputs.</p> <ul style="list-style-type: none"> • sourceName is a string capturing the name of the data source object. • sourceParams is a structure with fields containing the parameters required to load the data source object. <p>Both of these outputs are passed to the loadSource method.</p>
loadSource	<p>loadSource(sourceObj, sourceName, sourceParams)</p> <p>Load a data source object into the app. In the loading dialog box of the app, this method is invoked after you add a source and the getLoadPanelData method executes successfully. This method is also invoked when you load the data source object into the MATLAB workspace. When you load the data source object, MATLAB expects that the source has the name sourceName and parameters sourceParams that are needed to load that source and read data from it.</p>

readFrame	<pre>frame = readFrame(sourceObj,signalName,tsIndex)</pre> <p>Read a frame of data from a signal contained in a data source object at the specified timestamp index. The index must be in the bounds of the length of the timestamps for that signal.</p>		
loadPanelChecker	<pre>loadPanelChecker</pre> <p>Check the load panel for the loading dialog box of the app. This method opens a dialog box similar to the loading dialog box that you open from the Open menu on the app toolbar. Use this method to preview how the <code>customizeLoadPanel</code> method populates the loading panel for the selected data source object.</p> <table border="1" data-bbox="863 724 1476 762"> <tr> <td data-bbox="863 724 1166 762">Static</td> <td data-bbox="1172 724 1476 762">true</td> </tr> </table>	Static	true
Static	true		

Examples

Create Video Source

Create a video source from a video on the MATLAB® search path. Load the source name into the `VideoSource` object. The video has no source parameters needed to load it, so `sourceParams` is empty.

```
sourceName = 'caltech_cordova1.avi';
sourceParams = [];

vidSource = vision.labeler.loading.VideoSource;
loadSource(vidSource,sourceName,sourceParams);
```

Read the first frame from the video. Display the frame.

```
signalName = vidSource.SignalName;
I = readFrame(vidSource,signalName,1);

figure
imshow(I)
```



Tips

- You can use this class as a starting point for creating a custom data source loading class. To view the source code for this class, use this command:

```
edit vision.labeler.loading.VideoSource
```

Version History

Introduced in R2020a

See Also

Apps

Ground Truth Labeler

Classes

[vision.labeler.loading.ImageSequenceSource](#) |
[vision.labeler.loading.VelodyneLidarSource](#) |

```
vision.labeler.loading.RosbagSource |  
vision.labeler.loading.PointCloudSequenceSource |  
vision.labeler.loading.CustomImageSource |  
vision.labeler.loading.MultiSignalSource
```

Topics

“Sources vs. Signals in Ground Truth Labeling”

“Create Class for Loading Custom Ground Truth Data Sources”

vision.labeler.loading.ImageSequenceSource class

Package: vision.labeler.loading vision.labeler.loading vision.labeler.loading
 vision.labeler.loading vision.labeler.loading vision.labeler.loading
Superclasses: vision.labeler.loading.MultiSignalSource

Load signals from image sequence sources into Ground Truth Labeler app

Description

The `vision.labeler.loading.ImageSequenceSource` class creates an interface for loading signals from image sequence data sources into the **Ground Truth Labeler** app. In the Add/Remove Signal dialog box of the app, when **Source Type** is set to **Image Sequence**, this class controls the parameters in that dialog box.

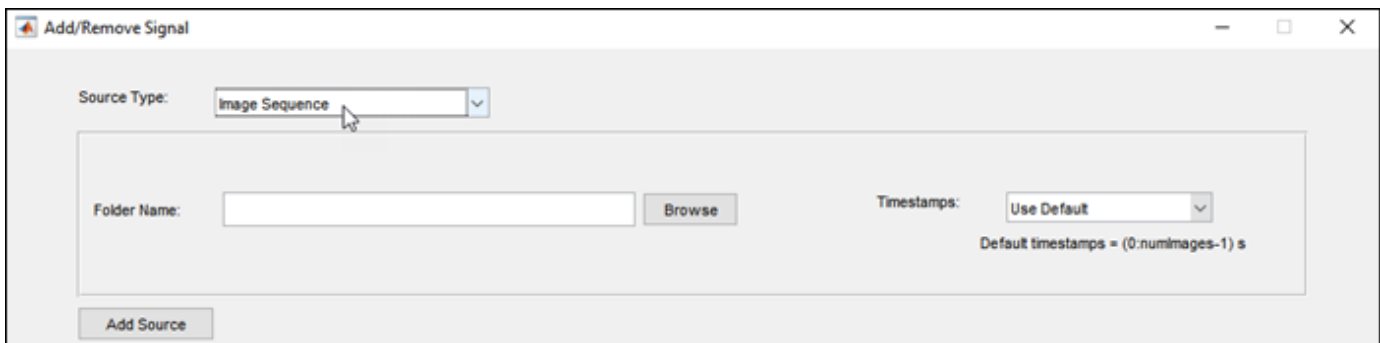

To access this dialog box, in the app, select **Import > Add Signals**.

The default implementation of this class loads the image formats that can be read from an `ImageDatastore` object.

The `vision.labeler.loading.ImageSequenceSource` class is a handle class.

Creation

When you export labels from a **Ground Truth Labeler** app session that contains image sequence sources, the exported `groundTruthMultisignal` object stores instances of this class in its `DataSource` property.

To create an `ImageSequenceSource` object programmatically, such as when programmatically creating a `groundTruthMultisignal` object, use the `vision.labeler.loading.ImageSequenceSource` function (described here).

Syntax

```
imseqSource = vision.labeler.loading.ImageSequenceSource
```

Description

`imseqSource = vision.labeler.loading.ImageSequenceSource` creates an `ImageSequenceSource` object for loading signals from image sequence data sources. To specify the data source and the parameters required to load the source, use the `loadSource` method.

Properties

Name — Name of source type

"Image Sequence" (default) | string scalar

Name of the type of source that this class loads, specified as a string scalar.

Attributes:

<code>GetAccess</code>	<code>public</code>
<code>Constant</code>	<code>true</code>
<code>NonCopyable</code>	<code>true</code>

Description — Description of class functionality

"An image sequence reader" (default) | string scalar

Description of the functionality that this class provides, specified as a string scalar.

Attributes:

<code>GetAccess</code>	<code>public</code>
<code>Constant</code>	<code>true</code>
<code>NonCopyable</code>	<code>true</code>

SourceName — Name of data source

[] (default) | string scalar

Name of the data source, specified as a string scalar. Typically, `SourceName` is the name of the file from which the signal is loaded.

Attributes:

<code>GetAccess</code>	<code>public</code>
<code>SetAccess</code>	<code>protected</code>

SourceParams — Parameters for loading image sequence signal from data source

[] (default) | structure

Parameters for loading an image sequence signal from a data source, specified as a structure.

This table describes the required and optional fields of the `SourceParams` structure.

Field	Description	Required or Optional
Timestamps	<p>Timestamps for the image sequence signal, specified as a cell array containing a single duration vector of timestamps.</p> <p>In the Add/Remove Signal dialog box of the app, if you set the Timestamps parameter to From Workspace and read the timestamps from a variable in the MATLAB workspace, then the SourceParams property stores these timestamps in the Timestamps field.</p>	<p>Optional</p> <p>If you set the Timestamps parameter to Use Default and use the default timestamps for image sequence signals, then the structure does not include this field, and the SourceParams property is empty, <code>[]</code>. For image sequence signals, the default timestamp duration vector has elements from 0 seconds to the number of valid image files minus 1. Units are in seconds.</p>

Attributes:

GetAccess public
SetAccess protected

SignalName — Names of signals in data source

`[]` (default) | string vector

Names of the signals that can be loaded from the data source, specified as a string vector.

Attributes:

GetAccess public
SetAccess protected

SignalType — Types of signals in data source

`[]` (default) | vector of `vision.labeler.loading.SignalType` enumerations

Types of the signals that can be loaded from the data source, specified as a vector of `vision.labeler.loading.SignalType` enumerations. Each signal listed in the **SignalName** property is of the type in the corresponding position of **SignalType**.

Attributes:

GetAccess public
SetAccess protected

Timestamp — Timestamps of signals in data source

`[]` (default) | cell array of duration vectors

Timestamps of the signals that can be loaded from the data source, specified as a cell array of duration vectors. Each signal listed in the **SignalName** property has the timestamps in the corresponding position of **Timestamp**.

Attributes:

GetAccess public
SetAccess protected

NumSignals — Number of signals in data source

0 (default) | integer

Number of signals that can be read from the data source, specified as a nonnegative integer. NumSignals is equal to the number of signals in the SignalName property.

Attributes:

GetAccess	public
SetAccess	public
Dependent	true
NonCopyable	true

Methods**Public Methods**

customizeLoadPanel	<p>customizeLoadPanel(sourceObj, panel)</p> <p>Customize the loading panel for the data source object. In the loading dialog box of the app, this method is invoked when you select the data source type from the Source Type list.</p>
getLoadPanelData	<p>[sourceName, sourceParams] = getLoadPanelData(sourceObj)</p> <p>Obtain the data needed to load the data source object currently selected in the loading panel. In the loading dialog box of the app, this method is invoked when you add a source. The method returns these outputs.</p> <ul style="list-style-type: none"> • sourceName is a string capturing the name of the data source object. • sourceParams is a structure with fields containing the parameters required to load the data source object. <p>Both of these outputs are passed to the loadSource method.</p>
loadSource	<p>loadSource(sourceObj, sourceName, sourceParams)</p> <p>Load a data source object into the app. In the loading dialog box of the app, this method is invoked after you add a source and the getLoadPanelData method executes successfully. This method is also invoked when you load the data source object into the MATLAB workspace. When you load the data source object, MATLAB expects that the source has the name sourceName and parameters sourceParams that are needed to load that source and read data from it.</p>

readFrame	<pre>frame = readFrame(sourceObj, signalName, tsIndex)</pre> <p>Read a frame of data from a signal contained in a data source object at the specified timestamp index. The index must be in the bounds of the length of the timestamps for that signal.</p>		
loadPanelChecker	<pre>loadPanelChecker</pre> <p>Check the load panel for the loading dialog box of the app. This method opens a dialog box similar to the loading dialog box that you open from the Open menu on the app toolstrip. Use this method to preview how the <code>customizeLoadPanel</code> method populates the loading panel for the selected data source object.</p> <table border="1" data-bbox="863 724 1476 766"> <tr> <td data-bbox="863 724 1166 766">Static</td> <td data-bbox="1172 724 1476 766">true</td> </tr> </table>	Static	true
Static	true		

Examples

Create Image Sequence Source

Specify the path to a folder containing an image sequence.

```
imseqFolder = fullfile(toolboxdir('driving'),'drivingdata','roadSequence');
```

Load the timestamps corresponding to the sequence.

```
load(fullfile(imseqFolder,'timeStamps.mat'))
```

Create an image sequence source. Load the folder path and timestamps into the `ImageSequenceSource` object.

```
sourceName = imseqFolder;
sourceParams = struct;
sourceParams.Timestamps = timeStamps;
```

```
imseqSource = vision.labeler.loading.ImageSequenceSource;
loadSource(imseqSource,sourceName,sourceParams);
```

Read the first frame in the sequence. Display the frame.

```
signalName = imseqSource.SignalName;
I = readFrame(imseqSource,signalName,1);
```

```
figure
imshow(I)
```



Tips

- You can this class as a starting point for creating a custom data source loading class. To view the source code for this class, use this command:

```
edit vision.labeler.loading.ImageSequenceSource
```

Version History

Introduced in R2020a

See Also

Apps

Ground Truth Labeler

Classes

[vision.labeler.loading.VideoSource](#) | [vision.labeler.loading.VelodyneLidarSource](#) | [vision.labeler.loading.RosbagSource](#) |

vision.labeler.loading.PointCloudSequenceSource |
vision.labeler.loading.CustomImageSource

Topics

“Sources vs. Signals in Ground Truth Labeling”

“Create Class for Loading Custom Ground Truth Data Sources”

vision.labeler.loading.VelodyneLidarSource class

Package: vision.labeler.loading vision.labeler.loading vision.labeler.loading
 vision.labeler.loading vision.labeler.loading vision.labeler.loading
Superclasses: vision.labeler.loading.MultiSignalSource

Load signals from Velodyne lidar sources into Ground Truth Labeler app

Description

The `vision.labeler.loading.VelodyneLidarSource` class creates an interface for loading signals from Velodyne packet capture (PCAP) lidar data sources into the **Ground Truth Labeler** app. In the Add/Remove Signal dialog box of the app, when **Source Type** is set to Velodyne Lidar, this class controls the parameters in that dialog box.

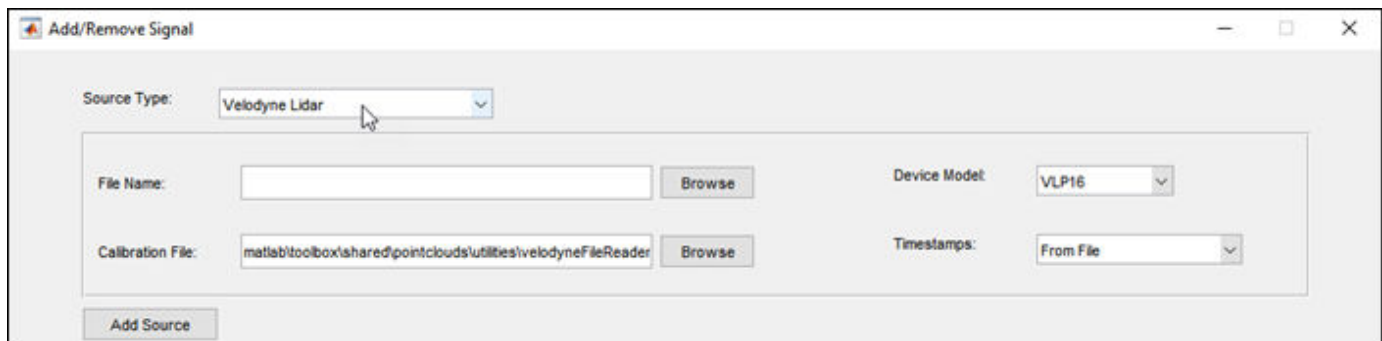

To access this dialog box, in the app, select **Import > Add Signals**.

The default implementation of this class loads Velodyne PCAP files from the device models accepted by the `velodyneFileReader` function.

The `vision.labeler.loading.VelodyneLidarSource` class is a handle class.

Creation

When you export labels from a **Ground Truth Labeler** app session that contains Velodyne lidar sources, the exported `groundTruthMultisignal` object stores instances of this class in its `DataSource` property.

To create a `VelodyneLidarSource` object programmatically, such as when programmatically creating a `groundTruthMultisignal` object, use the `vision.labeler.loading.VelodyneLidarSource` function (described here).

Syntax

```
velodyneSource = vision.labeler.loading.VelodyneLidarSource
```

Description

`velodyneSource = vision.labeler.loading.VelodyneLidarSource` creates a `VelodyneLidarSource` object for loading signals from Velodyne lidar data sources. To specify the data source and the parameters required to load the source, use the `loadSource` method.

Properties

Name — Name of source type

"Velodyne Lidar" (default) | string scalar

Name of the type of source that this class loads, specified as a string scalar.

Attributes:

GetAccess	public
Constant	true
NonCopyable	true

Description — Description of class functionality

"A Velodyne file reader" (default) | string scalar

Description of the functionality that this class provides, specified as a string scalar.

Attributes:

GetAccess	public
Constant	true
NonCopyable	true

SourceName — Name of data source

[] (default) | string scalar

Name of the data source, specified as a string scalar. Typically, `SourceName` is the name of the file from which the signal is loaded.

Attributes:

GetAccess	public
SetAccess	protected

SourceParams — Parameters for loading Velodyne lidar signal from data source

[] (default) | structure

Parameters for loading a Velodyne lidar signal from a data source, specified as a structure.

This table describes the required and optional fields of the `SourceParams` structure.

Field	Description	Required or Optional
Timestamps	<p>Timestamps for the Velodyne lidar signal, specified as a cell array containing a single duration vector of timestamps.</p> <p>In the Add/Remove Signal dialog box of the app, if you set the Timestamps parameter to From Workspace and read the timestamps from a variable in the MATLAB workspace, then the SourceParams property stores these timestamps in the Timestamps field.</p>	<p>Optional</p> <p>In the Add/Remove Signal dialog box of the app, if you set the Timestamps parameter to From File and read the timestamps from the Velodyne PCAP file, then the structure does not include this field.</p>
DeviceModel	<p>Velodyne device model name, specified as one of these options.</p> <ul style="list-style-type: none"> • 'VLP16' (default) — VLP-16 device model • 'PuckLITE' — Puck LITE device model • 'PuckHiRes' — Puck Hi-Res device model • 'VLP32C' — VLP-32C device model • 'HDL32E' — HDL-32E device model • 'HDL64E' — HDL-64E device model • 'VLS-128' — VLS-128 device model <p>If you specify the incorrect device model for your Velodyne PCAP file, the app loads an improperly calibrated point cloud.</p> <p>In the Add/Remove Signal dialog box of the app, select the device model from the Device Model parameter. The Calibration File parameter updates to the calibration file of the selected device model.</p>	<p>Required</p>

Field	Description	Required or Optional
CalibrationFile	<p>Name of the Velodyne calibration XML file, specified as a character vector or string scalar.</p> <p>To specify one of the calibration files included with your MATLAB installation, at the MATLAB command prompt, enter this code. Replace <code><DeviceModel></code> with the name of the device model that you specify in the <code>DeviceModel</code> field of this structure (without quotes).</p> <pre>calibrationFile = fullfile(... matlabroot,'toolbox', ... 'shared','pointclouds','utilities', ... 'velodyneFileReaderConfiguration', ... '<DeviceModel>.xml')</pre> <p>By default, the <code>CalibrationFile</code> field is set to the full path to the <code>VLP16.xml</code> file, which is the calibration file for the VLP-16 device model.</p> <p>In the Add/Remove Signal dialog box of the app, when you change the Device Model parameter selection, the Calibration File parameter updates to the corresponding calibration file for the selected device model. You can also browse for or enter a path to a different calibration file in the Calibration File box.</p>	Required

For more details on device models and calibration files, see the `velodyneFileReader` object reference page.

Attributes:

<code>GetAccess</code>	public
<code>SetAccess</code>	protected

SignalName — Names of signals in data source

[] (default) | string vector

Names of the signals that can be loaded from the data source, specified as a string vector.

Attributes:

GetAccess	public
SetAccess	protected

SignalType — Types of signals in data source

[] (default) | vector of `vision.labeler.loading.SignalType` enumerations

Types of the signals that can be loaded from the data source, specified as a vector of `vision.labeler.loading.SignalType` enumerations. Each signal listed in the `SignalName` property is of the type in the corresponding position of `SignalType`.

Attributes:

GetAccess	public
SetAccess	protected

Timestamp — Timestamps of signals in data source

[] (default) | cell array of duration vectors

Timestamps of the signals that can be loaded from the data source, specified as a cell array of duration vectors. Each signal listed in the `SignalName` property has the timestamps in the corresponding position of `Timestamp`.

Attributes:

GetAccess	public
SetAccess	protected

NumSignals — Number of signals in data source

0 (default) | integer

Number of signals that can be read from the data source, specified as a nonnegative integer. `NumSignals` is equal to the number of signals in the `SignalName` property.

Attributes:

GetAccess	public
SetAccess	public
Dependent	true
NonCopyable	true

Methods**Public Methods**

<code>customizeLoadPanel</code>	<code>customizeLoadPanel(sourceObj, panel)</code> Customize the loading panel for the data source object. In the loading dialog box of the app, this method is invoked when you select the data source type from the Source Type list.
---------------------------------	--

getLoadPanelData	<pre>[sourceName,sourceParams] = getLoadPanelData(sourceObj)</pre> <p>Obtain the data needed to load the data source object currently selected in the loading panel. In the loading dialog box of the app, this method is invoked when you add a source. The method returns these outputs.</p> <ul style="list-style-type: none"> • <code>sourceName</code> is a string capturing the name of the data source object. • <code>sourceParams</code> is a structure with fields containing the parameters required to load the data source object. <p>Both of these outputs are passed to the <code>loadSource</code> method.</p>		
loadSource	<pre>loadSource(sourceObj,sourceName,sourceParams)</pre> <p>Load a data source object into the app. In the loading dialog box of the app, this method is invoked after you add a source and the <code>getLoadPanelData</code> method executes successfully. This method is also invoked when you load the data source object into the MATLAB workspace. When you load the data source object, MATLAB expects that the source has the name <code>sourceName</code> and parameters <code>sourceParams</code> that are needed to load that source and read data from it.</p>		
readFrame	<pre>frame = readFrame(sourceObj,signalName,tsIndex)</pre> <p>Read a frame of data from a signal contained in a data source object at the specified timestamp index. The index must be in the bounds of the length of the timestamps for that signal.</p>		
loadPanelChecker	<pre>loadPanelChecker</pre> <p>Check the load panel for the loading dialog box of the app. This method opens a dialog box similar to the loading dialog box that you open from the Open menu on the app toolbar. Use this method to preview how the <code>customizeLoadPanel</code> method populates the loading panel for the selected data source object.</p> <table border="1" data-bbox="862 1619 1479 1665"> <tr> <td data-bbox="862 1619 1167 1665">Static</td> <td data-bbox="1172 1619 1479 1665">true</td> </tr> </table>	Static	true
Static	true		

Examples

Create Velodyne Lidar Source

Specify the name of the Velodyne® lidar data source, a packet capture (PCAP) file.

```
sourceName = fullfile(toolboxdir('vision'),'visiondata', ...  
    'lidarData_ConstructionRoad.pcap');
```

Specify information needed to load the source, including the device model of the lidar and the calibration file.

```
sourceParams = struct;  
sourceParams.DeviceModel = 'HDL32E';  
sourceParams.CalibrationFile = fullfile(matlabroot,'toolbox','shared', ...  
    'pointclouds','utilities','velodyneFileReaderConfiguration', ...  
    'HDL32E.xml');
```

Create the Velodyne lidar data source. Load the data source path, device model, and calibration file path into the VelodyneLidarSource object.

```
velodyneSource = vision.labeler.loading.VelodyneLidarSource;  
loadSource(velodyneSource,sourceName,sourceParams);
```

Read the first frame from the source. Display the frame.

```
signalName = velodyneSource.SignalName;  
pc = readFrame(velodyneSource,signalName,1);
```

```
figure  
pcshow(pc)
```

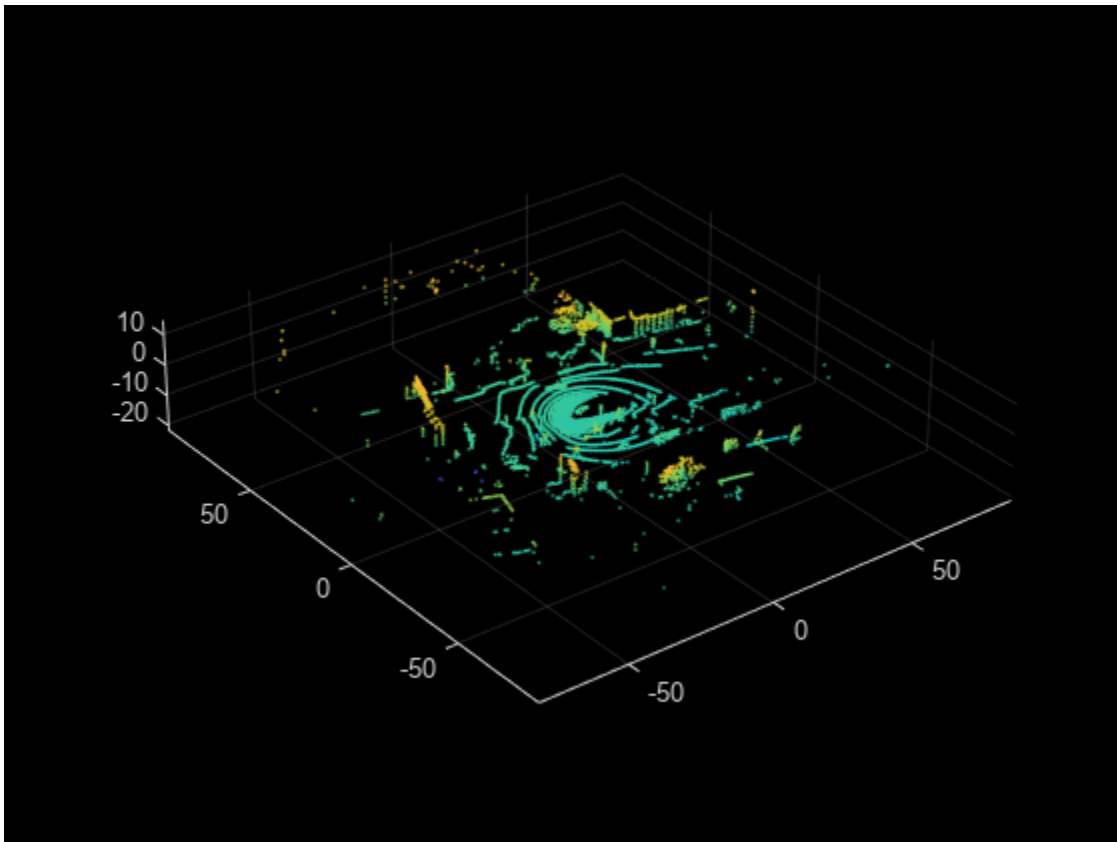

Tips

- You can use this class as a starting point for creating a custom data source loading class. To view the source code for this class, use this command:

```
edit vision.labeler.loading.VelodyneLidarSource
```

Version History

Introduced in R2020a

See Also

Apps

[Ground Truth Labeler](#)

Classes

[vision.labeler.loading.VideoSource](#) | [vision.labeler.loading.ImageSequenceSource](#)
| [vision.labeler.loading.RosbagSource](#) |
[vision.labeler.loading.PointCloudSequenceSource](#) |
[vision.labeler.loading.CustomImageSource](#)

Topics

[“Sources vs. Signals in Ground Truth Labeling”](#)

[“Create Class for Loading Custom Ground Truth Data Sources”](#)

vision.labeler.loading.RosbagSource class

Package: vision.labeler.loading vision.labeler.loading vision.labeler.loading
 vision.labeler.loading vision.labeler.loading vision.labeler.loading
Superclasses: vision.labeler.loading.MultiSignalSource

Load signals from rosbag sources into Ground Truth Labeler app

Description

The `vision.labeler.loading.RosbagSource` class creates an interface for loading signals from rosbag files into the **Ground Truth Labeler** app. In the Add/Remove Signal dialog box of the app, when **Source Type** is set to Rosbag, this class controls the parameters in that dialog box.



To access this dialog box, in the app, select **Import > Add Signals**.

The default implementation of this class loads signals from these ROS message types:

- `sensor_msgs/Image`
- `sensor_msgs/CompressedImage`
- `sensor_msgs/PointCloud2`

Note This class requires ROS Toolbox.

The `vision.labeler.loading.RosbagSource` class is a handle class.

Creation

When you export labels from a **Ground Truth Labeler** app session that contains rosbag sources, the exported `groundTruthMultisignal` object stores instances of this class in its `DataSource` property.

To create a `RosbagSource` object programmatically, such as when programmatically creating a `groundTruthMultisignal` object, use the `vision.labeler.loading.RosbagSource` function (described here).

Syntax

```
rosbagSource = vision.labeler.loading.RosbagSource
```

Description

`rosbagSource = vision.labeler.loading.RosbagSource` creates a `RosbagSource` object for loading signals from rosbag data sources. To specify the data source and the parameters required to load the source, use the `loadSource` method.

Properties

Name — Name of source type

"Rosbag" (default) | string scalar

Name of the type of source that this class loads, specified as a string scalar.

Attributes:

GetAccess	public
Constant	true
NonCopyable	true

Description — Description of class functionality

"A rosbag reader" (default) | string scalar

Description of the functionality that this class provides, specified as a string scalar.

Attributes:

GetAccess	public
Constant	true
NonCopyable	true

SourceName — Name of data source

[] (default) | string scalar

Name of the data source, specified as a string scalar. Typically, `SourceName` is the name of the file from which the signal is loaded.

Attributes:

GetAccess	public
SetAccess	protected

SourceParams — Parameters for loading signals from rosbag data source

[] (default) | empty structure

Parameters for loading signals from a rosbag data source, specified as an empty structure. When you load image or lidar signals from a rosbag, do not specify the signal timestamps or any other parameters. The `loadSource` method reads these parameters from the rosbag.

Attributes:

GetAccess	public
SetAccess	protected

SignalName — Names of signals in data source

[] (default) | string vector

Names of the signals that can be loaded from the data source, specified as a string vector.

Attributes:

GetAccess	public
SetAccess	protected

SignalType — Types of signals in data source[] (default) | vector of `vision.labeler.loading.SignalType` enumerations

Types of the signals that can be loaded from the data source, specified as a vector of `vision.labeler.loading.SignalType` enumerations. Each signal listed in the `SignalName` property is of the type in the corresponding position of `SignalType`.

Attributes:

GetAccess	public
SetAccess	protected

Timestamp — Timestamps of signals in data source

[] (default) | cell array of duration vectors

Timestamps of the signals that can be loaded from the data source, specified as a cell array of duration vectors. Each signal listed in the `SignalName` property has the timestamps in the corresponding position of `Timestamp`.

Attributes:

GetAccess	public
SetAccess	protected

NumSignals — Number of signals in data source

0 (default) | integer

Number of signals that can be read from the data source, specified as a nonnegative integer. `NumSignals` is equal to the number of signals in the `SignalName` property.

Attributes:

GetAccess	public
SetAccess	public
Dependent	true
NonCopyable	true

Methods

Public Methods

customizeLoadPanel	<pre>customizeLoadPanel(sourceObj, panel)</pre> <p>Customize the loading panel for the data source object. In the loading dialog box of the app, this method is invoked when you select the data source type from the Source Type list.</p>
getLoadPanelData	<pre>[sourceName, sourceParams] = getLoadPanelData(sourceObj)</pre> <p>Obtain the data needed to load the data source object currently selected in the loading panel. In the loading dialog box of the app, this method is invoked when you add a source. The method returns these outputs.</p> <ul style="list-style-type: none"> • <code>sourceName</code> is a string capturing the name of the data source object. • <code>sourceParams</code> is a structure with fields containing the parameters required to load the data source object. <p>Both of these outputs are passed to the <code>loadSource</code> method.</p>
loadSource	<pre>loadSource(sourceObj, sourceName, sourceParams)</pre> <p>Load a data source object into the app. In the loading dialog box of the app, this method is invoked after you add a source and the <code>getLoadPanelData</code> method executes successfully. This method is also invoked when you load the data source object into the MATLAB workspace. When you load the data source object, MATLAB expects that the source has the name <code>sourceName</code> and parameters <code>sourceParams</code> that are needed to load that source and read data from it.</p>
readFrame	<pre>frame = readFrame(sourceObj, signalName, tsIndex)</pre> <p>Read a frame of data from a signal contained in a data source object at the specified timestamp index. The index must be in the bounds of the length of the timestamps for that signal.</p>

loadPanelChecker	<p>loadPanelChecker</p> <p>Check the load panel for the loading dialog box of the app. This method opens a dialog box similar to the loading dialog box that you open from the Open menu on the app toolbar. Use this method to preview how the <code>customizeLoadPanel</code> method populates the loading panel for the selected data source object.</p> <table border="1" data-bbox="857 541 1484 588"> <tr> <td data-bbox="857 541 1169 588">Static</td> <td data-bbox="1169 541 1484 588">true</td> </tr> </table>	Static	true
Static	true		

Tips

- You can use this class as a starting point for creating a custom data source loading class. To view the source code for this class, use this command:

```
edit vision.labeler.loading.RosbagSource
```

Version History

Introduced in R2020a

See Also

Apps

Ground Truth Labeler

Classes

vision.labeler.loading.VideoSource | vision.labeler.loading.ImageSequenceSource
 | vision.labeler.loading.VelodyneLidarSource |
 vision.labeler.loading.PointCloudSequenceSource |
 vision.labeler.loading.CustomImageSource

Topics

“Sources vs. Signals in Ground Truth Labeling”

“Create Class for Loading Custom Ground Truth Data Sources”

vision.labeler.loading.PointCloudSequenceSource class

Package: vision.labeler.loading vision.labeler.loading vision.labeler.loading
vision.labeler.loading vision.labeler.loading vision.labeler.loading

Superclasses: vision.labeler.loading.MultiSignalSource

Load signals from point cloud sequence sources into Ground Truth Labeler app

Description

The `vision.labeler.loading.PointCloudSequenceSource` class creates an interface for loading signals from point cloud sequence data sources into the **Ground Truth Labeler** app. In the Add/Remove Signal dialog box of the app, when **Source Type** is set to Point Cloud Sequence, this class controls the parameters in that dialog box.

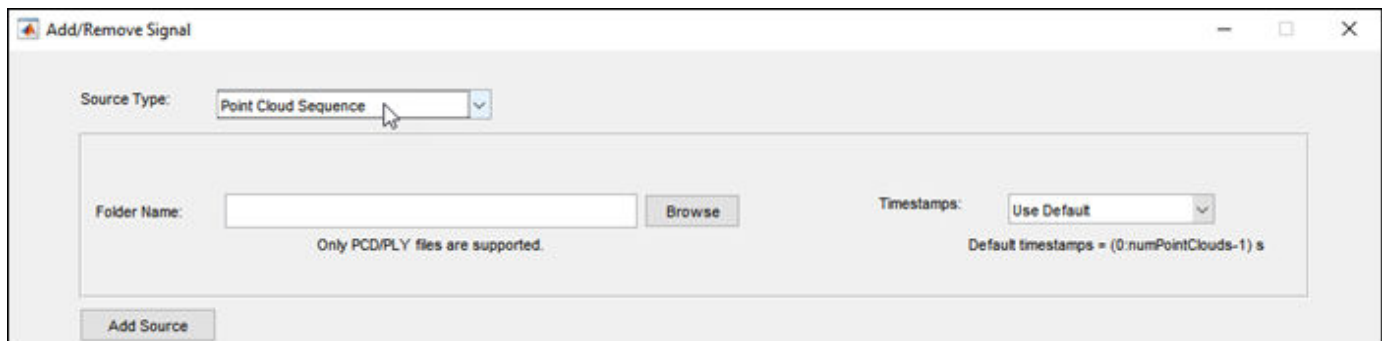

To access this dialog box, in the app, select **Import > Add Signals**.

The default implementation of this class loads point cloud sequences composed of PCD or PLY files.

The `vision.labeler.loading.PointCloudSequenceSource` class is a `handle` class.

Creation

When you export labels from a **Ground Truth Labeler** app session that contains point cloud sequence sources, the exported `groundTruthMultisignal` object stores instances of this class in its `DataSource` property.

To create a `PointCloudSequenceSource` object programmatically, such as when programmatically creating a `groundTruthMultisignal` object, use the `vision.labeler.loading.PointCloudSequenceSource` function (described here).

Syntax

```
pcseqSource = vision.labeler.loading.PointCloudSequenceSource
```

Description

`pcseqSource = vision.labeler.loading.PointCloudSequenceSource` creates a `PointCloudSequenceSource` object for loading signals from point cloud sequence data sources. To specify the data source and the parameters required to load the source, use the `loadSource` method.

Properties

Name — Name of source type

"Point Cloud Sequence" (default) | string scalar

Name of the type of source that this class loads, specified as a string scalar.

Attributes:

GetAccess	public
Constant	true
NonCopyable	true

Description — Description of class functionality

"A PointCloud sequence reader" (default) | string scalar

Description of the functionality that this class provides, specified as a string scalar.

Attributes:

GetAccess	public
Constant	true
NonCopyable	true

SourceName — Name of data source

[] (default) | string scalar

Name of the data source, specified as a string scalar. Typically, `SourceName` is the name of the file from which the signal is loaded.

Attributes:

GetAccess	public
SetAccess	protected

SourceParams — Parameters for loading point cloud sequence signal from data source

[] (default) | structure

Parameters for loading a point cloud sequence signal from a data source, specified as a structure.

This table describes the required and optional fields of the `SourceParams` structure.

Field	Description	Required or Optional
Timestamps	<p>Timestamps for the point cloud sequence signal, specified as a cell array containing a single duration vector of timestamps.</p> <p>In the Add/Remove Signal dialog box of the app, if you set the Timestamps parameter to From Workspace and read the timestamps from a variable in the MATLAB workspace, then the SourceParams property stores these timestamps in the Timestamps field.</p>	<p>Optional</p> <p>If you set the Timestamps parameter to Use Default and use the default timestamps for point cloud sequence signals, then the structure does not include this field, and the SourceParams property is empty, []. For point cloud sequence signals, the default timestamp duration vector has elements from 0 to the number of valid point cloud files minus 1. Units are in seconds.</p>

Attributes:

GetAccess public
SetAccess protected

SignalName — Names of signals in data source

[] (default) | string vector

Names of the signals that can be loaded from the data source, specified as a string vector.

Attributes:

GetAccess public
SetAccess protected

SignalType — Types of signals in data source

[] (default) | vector of `vision.labeler.loading.SignalType` enumerations

Types of the signals that can be loaded from the data source, specified as a vector of `vision.labeler.loading.SignalType` enumerations. Each signal listed in the **SignalName** property is of the type in the corresponding position of **SignalType**.

Attributes:

GetAccess public
SetAccess protected

Timestamp — Timestamps of signals in data source

[] (default) | cell array of duration vectors

Timestamps of the signals that can be loaded from the data source, specified as a cell array of duration vectors. Each signal listed in the **SignalName** property has the timestamps in the corresponding position of **Timestamp**.

Attributes:

GetAccess public
SetAccess protected

NumSignals — Number of signals in data source

0 (default) | integer

Number of signals that can be read from the data source, specified as a nonnegative integer. NumSignals is equal to the number of signals in the SignalName property.

Attributes:

GetAccess	public
SetAccess	public
Dependent	true
NonCopyable	true

Methods**Public Methods**

customizeLoadPanel	<p>customizeLoadPanel(sourceObj, panel)</p> <p>Customize the loading panel for the data source object. In the loading dialog box of the app, this method is invoked when you select the data source type from the Source Type list.</p>
getLoadPanelData	<p>[sourceName, sourceParams] = getLoadPanelData(sourceObj)</p> <p>Obtain the data needed to load the data source object currently selected in the loading panel. In the loading dialog box of the app, this method is invoked when you add a source. The method returns these outputs.</p> <ul style="list-style-type: none"> • sourceName is a string capturing the name of the data source object. • sourceParams is a structure with fields containing the parameters required to load the data source object. <p>Both of these outputs are passed to the loadSource method.</p>
loadSource	<p>loadSource(sourceObj, sourceName, sourceParams)</p> <p>Load a data source object into the app. In the loading dialog box of the app, this method is invoked after you add a source and the getLoadPanelData method executes successfully. This method is also invoked when you load the data source object into the MATLAB workspace. When you load the data source object, MATLAB expects that the source has the name sourceName and parameters sourceParams that are needed to load that source and read data from it.</p>

readFrame	<pre>frame = readFrame(sourceObj, signalName, tsIndex)</pre> <p>Read a frame of data from a signal contained in a data source object at the specified timestamp index. The index must be in the bounds of the length of the timestamps for that signal.</p>		
loadPanelChecker	<pre>loadPanelChecker</pre> <p>Check the load panel for the loading dialog box of the app. This method opens a dialog box similar to the loading dialog box that you open from the Open menu on the app toolstrip. Use this method to preview how the <code>customizeLoadPanel</code> method populates the loading panel for the selected data source object.</p> <table border="1" data-bbox="863 722 1476 760"> <tr> <td data-bbox="863 722 1167 760">Static</td> <td data-bbox="1174 722 1476 760">true</td> </tr> </table>	Static	true
Static	true		

Examples

Create Point Cloud Sequence Source

Specify the path to a folder containing a point cloud sequence.

```
pcSeqFolder = fullfile(toolboxdir('driving'),'drivingdata',...
    'lidarSequence');
```

Load the timestamps that correspond to the sequence.

```
load(fullfile(pcSeqFolder, 'timestamps.mat'));
```

Create a point cloud sequence source. Load the folder path and timestamps into the `PointCloudSequenceSource` object.

```
sourceName = pcSeqFolder;
sourceParams = struct;
sourceParams.Timestamps = timestamps;
```

```
pcseqSource = vision.labeler.loading.PointCloudSequenceSource;
loadSource(pcseqSource, sourceName, sourceParams);
```

Read the first frame in the sequence. Display the frame.

```
signalName = pcseqSource.SignalName;
pc = readFrame(pcseqSource, signalName, 1);
```

```
figure
pcshow(pc)
```

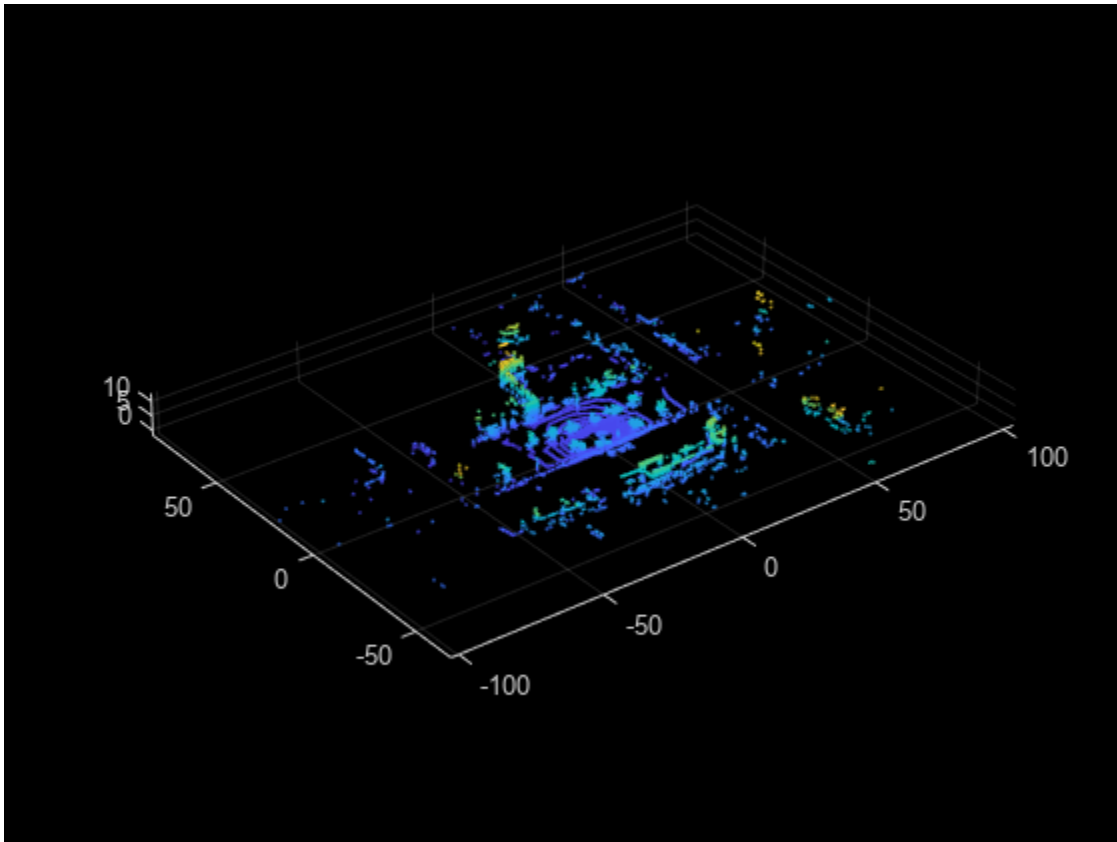

Tips

- You can use this class as a starting point for creating a custom data source loading class. To view the source code for this class, use this command:

```
edit vision.labeler.loading.PointCloudSequenceSource
```

Version History

Introduced in R2020a

See Also

Apps

Ground Truth Labeler

Classes

`vision.labeler.loading.VideoSource` | `vision.labeler.loading.ImageSequenceSource` | `vision.labeler.loading.VelodyneLidarSource` | `vision.labeler.loading.RosbagSource` | `vision.labeler.loading.CustomImageSource`

Topics

“Sources vs. Signals in Ground Truth Labeling”

“Create Class for Loading Custom Ground Truth Data Sources”

vision.labeler.loading.CustomImageSource class

Package: vision.labeler.loading vision.labeler.loading vision.labeler.loading
vision.labeler.loading vision.labeler.loading vision.labeler.loading

Superclasses: vision.labeler.loading.MultiSignalSource

Load signals from custom image sources into Ground Truth Labeler app

Description

The `vision.labeler.loading.CustomImageSource` class creates an interface for loading signals from custom image data sources into the **Ground Truth Labeler** app. In the Add/Remove Signal dialog box of the app, when **Source Type** is set to Custom Image, this class controls the parameters in that dialog box.

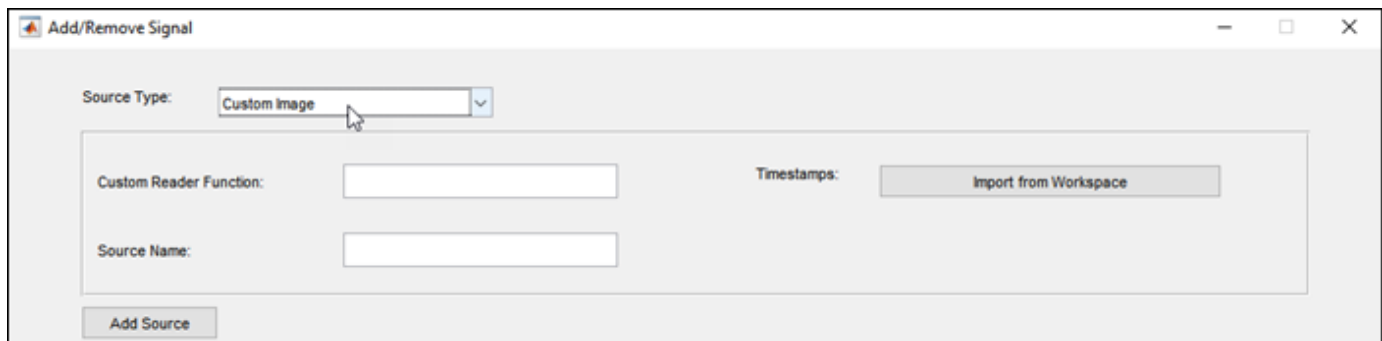

To access this dialog box, in the app, select **Import > Add Signals**.

The `vision.labeler.loading.CustomImageSource` class is a handle class.

Creation

When you export labels from a **Ground Truth Labeler** app session that contains custom image sources, the exported `groundTruthMultisignal` object stores instances of this class in its `DataSource` property.

To create a `CustomImageSource` object programmatically, such as when programmatically creating a `groundTruthMultisignal` object, use the `vision.labeler.loading.CustomImageSource` function (described here).

Syntax

```
customImgSource = vision.labeler.loading.CustomImageSource
```

Description

`customImgSource = vision.labeler.loading.CustomImageSource` creates a `CustomImageSource` object for loading signals from custom image data sources. To specify the data source and the parameters required to load the source, use the `loadSource` method.

Properties

Name — Name of source type

"Custom Image" (default) | string scalar

Name of the type of source that this class loads, specified as a string scalar.

Attributes:

GetAccess	public
Constant	true
NonCopyable	true

Description — Description of class functionality

"A custom image source reader" (default) | string scalar

Description of the functionality that this class provides, specified as a string scalar.

Attributes:

GetAccess	public
Constant	true
NonCopyable	true

SourceName — Name of data source

[] (default) | string scalar

Name of the data source, specified as a string scalar. Typically, SourceName is the name of the file from which the signal is loaded.

Attributes:

GetAccess	public
SetAccess	protected

SourceParams — Parameters for loading custom image signal from data source

[] (default) | structure

Parameters for loading a custom image signal from a data source, specified as a structure.

This table describes the required and optional fields of the SourceParams structure.

Field	Description	Required or Optional
FunctionHandle	Custom reader function for reading images from the data source, specified as a function handle. In the Add/Remove Signal dialog box of the app, specify this function handle in the Custom Reader Function parameter. For details on creating a custom reader function, see “Use Custom Image Source Reader for Labeling”.	Required
Timestamps	Timestamps for the custom image signal, specified as a cell array containing a single duration vector of timestamps. (For data sources that contain multiple signals, the Timestamps cell array contains one duration vector per signal with timestamps that are loaded from the MATLAB workspace.) In the Add/Remove Signal dialog box of the app, when you click the Import from Workspace button to read the timestamps from a variable in the MATLAB workspace, then the SourceParams property stores these timestamps in the Timestamps field.	Required

Attributes:

GetAccess	public
SetAccess	protected

SignalName — Names of signals in data source

[] (default) | string vector

Names of the signals that can be loaded from the data source, specified as a string vector.

Attributes:

GetAccess	public
SetAccess	protected

SignalType — Types of signals in data source

[] (default) | vector of vision.labeler.loading.SignalType enumerations

Types of the signals that can be loaded from the data source, specified as a vector of `vision.labeler.loading.SignalType` enumerations. Each signal listed in the `SignalName` property is of the type in the corresponding position of `SignalType`.

Attributes:

GetAccess public
SetAccess protected

Timestamp — Timestamps of signals in data source

`[]` (default) | cell array of duration vectors

Timestamps of the signals that can be loaded from the data source, specified as a cell array of duration vectors. Each signal listed in the `SignalName` property has the timestamps in the corresponding position of `Timestamp`.

Attributes:

GetAccess public
SetAccess protected

NumSignals — Number of signals in data source

`0` (default) | integer

Number of signals that can be read from the data source, specified as a nonnegative integer. `NumSignals` is equal to the number of signals in the `SignalName` property.

Attributes:

GetAccess public
SetAccess public
Dependent true
NonCopyable true

Methods

Public Methods

<code>customizeLoadPanel</code>	<code>customizeLoadPanel(sourceObj, panel)</code> Customize the loading panel for the data source object. In the loading dialog box of the app, this method is invoked when you select the data source type from the Source Type list.
---------------------------------	--

<p>getLoadPanelData</p>	<p>[sourceName,sourceParams] = getLoadPanelData(sourceObj)</p> <p>Obtain the data needed to load the data source object currently selected in the loading panel. In the loading dialog box of the app, this method is invoked when you add a source. The method returns these outputs.</p> <ul style="list-style-type: none"> • sourceName is a string capturing the name of the data source object. • sourceParams is a structure with fields containing the parameters required to load the data source object. <p>Both of these outputs are passed to the loadSource method.</p>		
<p>loadSource</p>	<p>loadSource(sourceObj,sourceName,sourceParams)</p> <p>Load a data source object into the app. In the loading dialog box of the app, this method is invoked after you add a source and the getLoadPanelData method executes successfully. This method is also invoked when you load the data source object into the MATLAB workspace. When you load the data source object, MATLAB expects that the source has the name sourceName and parameters sourceParams that are needed to load that source and read data from it.</p>		
<p>readFrame</p>	<p>frame = readFrame(sourceObj,signalName,tsIndex)</p> <p>Read a frame of data from a signal contained in a data source object at the specified timestamp index. The index must be in the bounds of the length of the timestamps for that signal.</p>		
<p>loadPanelChecker</p>	<p>loadPanelChecker</p> <p>Check the load panel for the loading dialog box of the app. This method opens a dialog box similar to the loading dialog box that you open from the Open menu on the app toolstrip. Use this method to preview how the customizeLoadPanel method populates the loading panel for the selected data source object.</p> <table border="1" data-bbox="862 1619 1479 1667"> <tr> <td data-bbox="862 1619 1166 1667">Static</td> <td data-bbox="1170 1619 1479 1667">true</td> </tr> </table>	Static	true
Static	true		

Examples

Create Custom Image Source

Specify the path to a folder containing a sequence of road images.

```
imageFolder = fullfile(toolboxdir('driving'),'drivingdata','roadSequence');
```

Store the images in an image datastore. The **Ground Truth Labeler** app and `groundTruthMultisignal` object do not natively support image datastores, so it is considered a custom image data source.

```
imds = imageDatastore(imageFolder);
```

Write a reader function, `readerFcn`, to read images from the datastore. The first input argument to the reader function, `sourceName`, is not used. The second input argument, `currentTimestamp`, is converted from a duration scalar to a 1-based index. This format is compatible with reading images from the datastore.

```
readerFcn = @(~,idx)readimage(imds,seconds(idx));
```

Create a custom image source. Load the source name, reader function, and first five timestamps of the datastore into the `CustomImageSource` object.

```
sourceName = imageFolder;  
sourceParams = struct();  
sourceParams.FunctionHandle = readerFcn;  
sourceParams.Timestamps = seconds(1:5);  
customImgSource = vision.labeler.loading.CustomImageSource;  
loadSource(customImgSource,sourceName,sourceParams)
```

Read the first frame in the sequence. Display the frame.

```
signalName = customImgSource.SignalName;  
I = readFrame(customImgSource,signalName,1);  
figure  
imshow(I)
```



Tips

- You can this class as a starting point for creating a custom data source loading class. To view the source code for this class, use this command:

```
edit vision.labeler.loading.CustomImageSource
```

Version History

Introduced in R2020a

See Also

Apps

Ground Truth Labeler

Classes

[vision.labeler.loading.VideoSource](#) | [vision.labeler.loading.ImageSequenceSource](#)
| [vision.labeler.loading.VelodyneLidarSource](#) |

vision.labeler.loading.RosbagSource |
vision.labeler.loading.PointCloudSequenceSource

Topics

“Sources vs. Signals in Ground Truth Labeling”

“Create Class for Loading Custom Ground Truth Data Sources”

vision.labeler.loading.SignalType

Signal type enumerations for labeling

Description

The `vision.labeler.loading.SignalType` enumerations enable you to specify the types of signals used in the **Ground Truth Labeler** app. When selecting signals from a `groundTruthMultisignal` object by using the `selectLabelsBySignalType` function, use these enumerations to select labels of a specific signal type.

Creation

Syntax

```
vision.labeler.loading.SignalType.Image  
vision.labeler.loading.SignalType.PointCloud  
vision.labeler.loading.SignalType.Time
```

Description

`vision.labeler.loading.SignalType.Image` creates an enumeration of signal type `Image`. Use this enumeration to specify image signals obtained from sources such as videos or image sequences.

`vision.labeler.loading.SignalType.PointCloud` creates an enumeration of signal type `PointCloud`. Use this enumeration to specify lidar point cloud signals obtained from sources such as Velodyne packet capture (PCAP) files.

`vision.labeler.loading.SignalType.Time` creates an enumeration of signal type `Time`. Scene labels are `Time` signals and are of type `duration`. You cannot load `Time` signals into the **Ground Truth Labeler** app.

Examples

Select Ground Truth Labels by Signal Type

Select ground truth labels from a `groundTruthMultisignal` object by specifying a signal type.

Load a `groundTruthMultisignal` object containing ROI and scene label data for a video and corresponding lidar point cloud sequence. The helper function used to load this object is attached to the example as a supporting file.

```
gTruth = helperLoadGTruthVideoLidar;
```

Inspect the label definitions. The object contains definitions for image, point cloud, and time signals.

```
gTruth.LabelDefinitions
```

```
ans =
```

```
5x7 table
```

Name	SignalType	LabelType	Group	Description	LabelColor
{'car' }	Image	Rectangle	{'Vehicles'}	{0x0 char}	{[0.5862 0.8276 0.3103]}
{'car' }	PointCloud	Cuboid	{'Vehicles'}	{0x0 char}	{[0.5862 0.8276 0.3103]}
{'truck'}	Image	Rectangle	{'Vehicles'}	{0x0 char}	{[0.5172 0.5172]}
{'truck'}	PointCloud	Cuboid	{'Vehicles'}	{0x0 char}	{[0.5172 0.5172]}
{'sunny'}	Time	Scene	{'None' }	{0x0 char}	{[0 0.7241 0.655]}

Inspect the ROI labels. The object contains labels for the lidar point cloud sequence and the video.

```
gTruth.ROILabelData
```

```
ans =
```

```
ROILabelData with properties:
```

```
video_01_city_c2s_fcw_10s: [204x2 timetable]
lidarSequence: [34x2 timetable]
```

Create a new `groundTruthMultisignal` object that contains labels for only point cloud signals.

```
signalTypes = vision.labeler.loading.SignalType.PointCloud;
gtLabel = selectLabelsBySignalType(gTruth,signalTypes);
```

For the original and new objects, inspect the first five rows of label data for the lidar point cloud sequence. Because lidar signals are of type `PointCloud`, the new object contains the same label data for the lidar sequence as the original object.

```
lidarLabels = gTruth.ROILabelData.lidarSequence;
lidarLabelsSelection = gtLabel.ROILabelData.lidarSequence;
```

```
numrows = 5;
head(lidarLabels,numrows)
head(lidarLabelsSelection,numrows)
```

Time	car	truck
0 sec	{1x1 struct}	{1x0 struct}
0.29926 sec	{1x1 struct}	{1x0 struct}
0.59997 sec	{1x1 struct}	{1x0 struct}
0.8485 sec	{1x1 struct}	{1x0 struct}
1.1484 sec	{1x1 struct}	{1x0 struct}

Time	car	truck
0 sec	{1x1 struct}	{1x0 struct}
0.29926 sec	{1x1 struct}	{1x0 struct}
0.59997 sec	{1x1 struct}	{1x0 struct}

```
0.8485 sec    {1x1 struct}    {1x0 struct}
1.1484 sec    {1x1 struct}    {1x0 struct}
```

For the original and new objects, inspect the first five rows of label data for the video. Because video signals are of type `Image`, the new object contains no label data for the video.

```
videoLabels = gTruth.R0ILabelData.video_01_city_c2s_fcw_10s;
videoLabelsSelection = gtLabel.R0ILabelData.video_01_city_c2s_fcw_10s;
```

```
head(videoLabels,numrows)
head(videoLabelsSelection,numrows)
```

Time	car	truck
0 sec	{1x3 struct}	{1x0 struct}
0.05 sec	{1x3 struct}	{1x0 struct}
0.1 sec	{1x3 struct}	{1x0 struct}
0.15 sec	{1x3 struct}	{1x0 struct}
0.2 sec	{1x3 struct}	{1x0 struct}

Time
0 sec
0.05 sec
0.1 sec
0.15 sec
0.2 sec

Version History

Introduced in R2020a

See Also

Apps

Ground Truth Labeler

Objects

labelDefinitionCreatorMultisignal | groundTruthMultisignal | labelType | attributeType

Functions

selectLabelsBySignalType

Topics

“Create Class for Loading Custom Ground Truth Data Sources”

sim3d.Editor

Interface to the Unreal Engine project

Description

Use the `sim3d.Editor` class to interface with the Unreal Editor.

To develop scenes with the Unreal Editor and co-simulate with Simulink, you need the Automated Driving Toolbox Interface for Unreal Engine 4 Projects support package. The support package contains an Unreal Engine project that allows you to customize the Automated Driving Toolbox scenes. For information about the support package, see “Customize Unreal Engine Scenes for Automated Driving”.

Creation

Syntax

```
sim3d.Editor(project)
```

Description

MATLAB creates an `sim3d.Editor` object for the Unreal Editor project specified in `sim3d.Editor(project)`.

Input Arguments

project — Project path and name

string array

Project path and name.

Example: "C:\Local\AutoVrtlEnv\AutoVrtlEnv.uproject"

Data Types: string

Properties

Uproject — Project path and name

string array

This property is read-only.

Project path and name with Unreal Engine project file extension.

Example: "C:\Local\AutoVrtlEnv\AutoVrtlEnv.uproject"

Data Types: string

Object Functions

open Open the Unreal Editor

Examples

Open Project in Unreal Editor

Open an Unreal Engine project in the Unreal Editor.

Create an instance of the `sim3d.Editor` class for the Unreal Engine project located in `C:\Local\AutoVrtlEnv\AutoVrtlEnv.uproject`.

```
editor = sim3d.Editor(fullfile("C:\Local\AutoVrtlEnv\AutoVrtlEnv.uproject"))
```

Open the project in the Unreal Editor.

```
editor.open();
```

Version History

Introduced in R2020a

See Also

Topics

“Customize Unreal Engine Scenes for Automated Driving”

open

Open the Unreal Editor

Syntax

```
[status,result] = open(sim3dEditorObj)
```

Description

[status,result] = open(sim3dEditorObj) opens the Unreal Engine project in the Unreal Editor.

To develop scenes with the Unreal Editor and co-simulate with Simulink, you need the Automated Driving Toolbox Interface for Unreal Engine 4 Projects support package. The support package contains an Unreal Engine project that allows you to customize the Automated Driving Toolbox scenes. For information about the support package, see “Customize Unreal Engine Scenes for Automated Driving”.

Input Arguments

sim3dEditorObj — sim3d.Editor object

sim3d.Editor object

sim3d.Editor object for the Unreal Engine project.

Output Arguments

status — Command exit status

0 | nonzero integer

Command exit status, returned as either 0 or a nonzero integer. When the command is successful, status is 0. Otherwise, status is a nonzero integer.

- If command includes the ampersand character (&), then status is the exit status when command starts
- If command does not include the ampersand character (&), then status is the exit status upon command completion.

result — Output of operating system command

character vector

Output of the operating system command, returned as a character vector. The system shell might not properly represent non-Unicode® characters.

Version History

Introduced in R2020a

See Also

sim3d.Editor

Topics

“Customize Unreal Engine Scenes for Automated Driving”

multiObjectTracker

Track objects using GNN assignment

Description

The `multiObjectTracker` System object initializes, confirms, predicts, corrects, and deletes the tracks of moving objects. Inputs to the multi-object tracker are detection reports generated by an `objectDetection` object, `drivingRadarDataGenerator` object, or `visionDetectionGenerator` object. The multi-object tracker accepts detections from multiple sensors and assigns them to tracks using a global nearest neighbor (GNN) criterion. Each detection is assigned to a separate track. If the detection cannot be assigned to any track, based on the `AssignmentThreshold` property, the tracker creates a new track. The tracks are returned in a structure array.

A new track starts in a *tentative* state. If enough detections are assigned to a tentative track, its status changes to *confirmed*. If the detection is a known classification (the `ObjectClassID` field of the returned track is nonzero), that track can be confirmed immediately. For details on the multi-object tracker properties used to confirm tracks, see “Algorithms” on page 4-1139.

When a track is confirmed, the multi-object tracker considers that track to represent a physical object. If detections are not added to the track within a specifiable number of updates, the track is deleted.

The tracker also estimates the state vector and state vector covariance matrix for each track using a Kalman filter. These state vectors are used to predict a track's location in each frame and determine the likelihood of each detection being assigned to each track.

To track objects using a multi-object tracker:

- 1 Create the `multiObjectTracker` object and set its properties.
- 2 Call the object with arguments, as if it were a function.

To learn more about how System objects work, see [What Are System Objects?](#)

Creation

Syntax

```
tracker = multiObjectTracker  
tracker = multiObjectTracker(Name,Value)
```

Description

`tracker = multiObjectTracker` creates a `multiObjectTracker` System object with default property values.

`tracker = multiObjectTracker(Name,Value)` sets properties on page 4-1130 for the multi-object tracker using one or more name-value pairs. For example,

`multiObjectTracker('FilterInitializationFcn',@initcvkf,'MaxNumTracks',100)` creates a multi-object tracker that uses a constant-velocity, unscented Kalman filter and maintains a maximum of 100 tracks. Enclose each property name in quotes.

Properties

Unless otherwise indicated, properties are *nontunable*, which means you cannot change their values after calling the object. Objects lock when you call them, and the `release` function unlocks them.

If a property is *tunable*, you can change its value at any time.

For more information on changing property values, see *System Design in MATLAB Using System Objects*.

TrackerIndex — Unique tracker identifier

0 (default) | nonnegative integer

Unique tracker identifier, specified as a nonnegative integer. This property is used as the `SourceIndex` in the tracker outputs, and distinguishes tracks that come from different trackers in a multiple-tracker system. You must specify this property as a positive integer to use the track outputs as inputs to a track fuser.

Example: 1

FilterInitializationFcn — Kalman filter initialization function

@initcvkf (default) | function handle | character vector | string scalar

Kalman filter initialization function, specified as a function handle or as a character vector or string scalar of the name of a valid Kalman filter initialization function.

Automated Driving Toolbox supplies several initialization functions that you can use to specify `FilterInitializationFcn`.

Initialization Function	Function Definition
<code>initcvekf</code>	Initialize constant-velocity extended Kalman filter.
<code>initcvkf</code>	Initialize constant-velocity linear Kalman filter.
<code>initcvukf</code>	Initialize constant-velocity unscented Kalman filter.
<code>initcaekf</code>	Initialize constant-acceleration extended Kalman filter.
<code>initcakf</code>	Initialize constant-acceleration linear Kalman filter.
<code>initcaukf</code>	Initialize constant-acceleration unscented Kalman filter.
<code>initctekf</code>	Initialize constant-turnrate extended Kalman filter.
<code>initctukf</code>	Initialize constant-turnrate unscented Kalman filter.

You can also write your own initialization function. The input to this function must be a detection report created by `objectDetection`. The output of this function must be a Kalman filter object:

`trackingKF`, `trackingEKF`, or `trackingUKF`. To guide you in writing this function, you can examine the details of the supplied functions from within MATLAB. For example:

```
type initcvkf
```

Data Types: `function_handle` | `char` | `string`

AssignmentThreshold — Detection assignment threshold

`30*[1 Inf]` (default) | positive scalar | 1-by-2 vector of positive values

Detection assignment threshold (or gating threshold), specified as a positive scalar or an 1-by-2 vector of $[C_1, C_2]$, where $C_1 \leq C_2$. If specified as a scalar, the specified value, *val*, will be expanded to $[val, Inf]$.

Initially, the tracker executes a *coarse* estimation for the normalized distance between all the tracks and detections. The tracker only calculates the accurate normalized distance for the combinations whose coarse normalized distance is less than C_2 . Also, the tracker can only assign a detection to a track if their *accurate* normalized distance is less than C_1 . See the `distance` function used with tracking filters (for example, `trackingEKF`) for an explanation of the distance calculation.

Tips:

- Increase the value of C_2 if there are combinations of track and detection that should be calculated for assignment but are not. Decrease it if cost calculation takes too much time.
- Increase the value of C_1 if there are detections that should be assigned to tracks but are not. Decrease it if there are detections that are assigned to tracks they should not be assigned to (too far away).

MaxNumTracks — Maximum number of tracks

`200` (default) | positive integer

Maximum number of tracks that the tracker can maintain, specified as a positive integer.

Data Types: `double`

MaxNumSensors — Maximum number of sensors

`20` (default) | positive integer

Maximum number of sensors that can be connected to the tracker, specified as a positive integer. When you specify detections as input to the multi-object tracker, `MaxNumSensors` must be greater than or equal to the highest `SensorIndex` value in the `detections` cell array of `objectDetection` objects used to update the multi-object tracker. This property determines how many sets of `ObjectAttributes` fields each output track can have.

Data Types: `double`

MaxNumDetections — Maximum number of detections

`Inf` (default) | positive integer

Maximum number of detections that the tracker can take as inputs, specified as a positive integer.

Data Types: `single` | `double`

OOSMHandling — Handle out-of-sequence measurement (OOSM)

'Terminate' (default) | 'Neglect'

Handle out-of-sequence measurement (OOSM), specified as 'Terminate' or 'Neglect'. Each detection has a timestamp associated with it, t_d , and the tracker has its own timestamp, t_t , which is updated in each call. The tracker considers a measurement as an OOSM if $t_d < t_t$.

When the property is specified as

- 'Terminate' — The tracker stops running when it encounters any out-of-sequence measurements.
- 'Neglect' — The tracker neglects any out-of-sequence measurements and continues to run.

Tunable: Yes

ConfirmationThreshold — Threshold for track confirmation

[2 3] (default) | two-element vector of non-decreasing positive integers

Threshold for track confirmation, specified as a two-element vector of non-decreasing positive integers, [M N], where M is less than or equal to N. A track is confirmed if it receives at least M detections in the last N updates.

- When setting M, take into account the probability of object detection for the sensors. The probability of detection depends on factors such as occlusion or clutter. You can reduce M when tracks fail to be confirmed or increase M when too many false detections are assigned to tracks.
- When setting N, consider the number of times you want the tracker to update before it makes a confirmation decision. For example, if a tracker updates every 0.05 seconds, and you allow 0.5 seconds to make a confirmation decision, set $N = 10$.

Example: [3 5]

Data Types: double

DeletionThreshold — Threshold for track deletion

[5 5] (default) | two-element vector of positive non-decreasing integers

Threshold for track deletion, specified as a two-element vector of positive non-decreasing integers [P Q], where P is less than or equal to Q. If a confirmed track is not assigned to any detection P times in the last Q tracker updates, then the track is deleted.

- Decrease Q (or increase P) if tracks should be deleted earlier.
- Increase Q (or decrease P) if tracks should be kept for a longer time before deletion.

Example: [3 5]

Data Types: single | double

HasCostMatrixInput — Enable cost matrix input

false (default) | true

Enable a cost matrix as input to the multiObjectTracker System object or to the updateTracks function, specified as false or true.

Data Types: logical

HasDetectableTrackIDsInput — Enable input of detectable track IDs

false (default) | true

Enable the input of detectable track IDs at each object update, specified as false or true. Set this property to true if you want to provide a list of detectable track IDs. This list tells the tracker of all

tracks that the sensors are expected to detect and, optionally, the probability of detection for each track.

Data Types: `logical`

StateParameters — Parameters of track state reference frame

`struct([])` (default) | `struct array`

Parameters of the track state reference frame, specified as a structure or a structure array. The tracker passes its `StateParameters` property values to the `StateParameters` property of the generated tracks. You can use these parameters to define the reference frame in which the track is reported or other desirable attributes of the generated tracks.

For example, you can use the following structure to define a rectangular reference frame whose origin position is at `[10 10 0]` meters and whose origin velocity is `[2 -2 0]` meters per second with respect to the scenario frame.

Field Name	Value
Frame	"Rectangular"
Position	[10 10 0]
Velocity	[2 -2 0]

Tunable: Yes

Data Types: `struct`

NumTracks — Number of tracks maintained by multi-object tracker

`nonnegative integer`

This property is read-only.

Number of tracks maintained by the multi-object tracker, specified as a nonnegative integer.

Data Types: `double`

NumConfirmedTracks — Number of confirmed tracks

`nonnegative integer`

This property is read-only.

Number of confirmed tracks, specified as a nonnegative integer. The `IsConfirmed` fields of the output track structures indicate which tracks are confirmed.

Data Types: `double`

Usage

To update tracks, call the created multi-object tracker with arguments, as if it were a function (described here). Alternatively, update tracks by using the `updateTracks` function, specifying the multi-object tracker as an input argument.

Syntax

```
confirmedTracks = tracker(detections,time)
```

```
[confirmedTracks,tentativeTracks] = tracker(detections,time)
[confirmedTracks,tentativeTracks,allTracks] = tracker(detections,time)
[ ___ ] = tracker(detections,time,costMatrix)
[ ___ ] = tracker( ___ ,detectableTrackIDs)
```

Description

`confirmedTracks = tracker(detections,time)` creates, updates, and deletes tracks in the multi-object tracker and returns details about the confirmed tracks. Updates are based on the specified list of `detections`, and all tracks are updated to the specified time. Each element in the returned `confirmedTracks` corresponds to a single track.

`[confirmedTracks,tentativeTracks] = tracker(detections,time)` also returns `tentativeTracks` containing details about the tentative tracks.

`[confirmedTracks,tentativeTracks,allTracks] = tracker(detections,time)` also returns `allTracks` containing details about all the confirmed and tentative tracks. The tracks are returned in the order by which the tracker internally maintains them. You can use this output to help you calculate the cost matrix, an optional input argument.

`[___] = tracker(detections,time,costMatrix)` specifies a cost matrix, returning any of the outputs from preceding syntaxes.

To specify a cost matrix, set the `HasCostMatrixInput` property of the `multiObjectTracker` System object to `true`.

`[___] = tracker(___ ,detectableTrackIDs)` also specifies a list of expected detectable tracks given by `detectableTrackIDs`. This argument can be used with any of the previous input syntaxes.

To enable this syntax, set the `HasDetectableTrackIDsInput` property to `true`.

Input Arguments

detections – Detection list

cell array of `objectDetection` objects

Detection list, specified as a cell array of `objectDetection` objects. The `Time` property value of each `objectDetection` object must be less than or equal to the current time of update, `time`, and greater than the previous time value used to update the multi-object tracker.

time – Time of update

real scalar

Time of update, specified as a real scalar. The tracker updates all tracks to this time. Units are in seconds.

`time` must be greater than or equal to the largest `Time` property value of the `objectDetection` objects in the input `detections` list. `time` must increase in value with each update to the multi-object tracker.

Data Types: `double`

costMatrix – Cost matrix

N_T -by- N_D matrix

Cost matrix, specified as a real-valued N_T -by- N_D matrix, where N_T is the number of existing tracks, and N_D is the number of current detections. The rows of the cost matrix correspond to the existing tracks. The columns correspond to the detections. Tracks are ordered as they appear in the list of tracks in the `allTracks` output argument of the previous update to the multi-object tracker.

In the first update to the multi-object tracker, or when the tracker has no previous tracks, assign the cost matrix a size of $[0, N_D]$. The cost must be calculated so that lower costs indicate a higher likelihood that the tracker assigns a detection to a track. To prevent certain detections from being assigned to certain tracks, use `Inf`.

Dependencies

To enable specification of the cost matrix when updating tracks, set the `HasCostMatrixInput` property of the tracker to `true`

Data Types: `double`

detectableTrackIDs — Detectable track IDs

real-valued M -by-1 vector | real-valued M -by-2 matrix

Detectable track IDs, specified as a real-valued M -by-1 vector or M -by-2 matrix. Detectable tracks are tracks that the sensors expect to detect. The first column of the matrix contains a list of track IDs that the sensors report as detectable. The optional second column contains the detection probability for the track. The detection probability is either reported by a sensor or, if not reported, obtained from the `DetectionProbability` property.

Tracks whose identifiers are not included in `detectableTrackIDs` are considered as undetectable. The track deletion logic does not count the lack of detection as a 'missed detection' for track deletion purposes.

Dependencies

To enable this input argument, set the `detectableTrackIDs` property to `true`.

Data Types: `single` | `double`

Output Arguments

confirmedTracks — Confirmed tracks

array of `objectTrack` objects | array of structures

Confirmed tracks, returned as an array of `objectTrack` objects in MATLAB, and returned as an array of structures in code generation. In code generation, the field names of the returned structure are same with the property names of `objectTrack`.

A track is confirmed if it satisfies the confirmation threshold specified in the `ConfirmationThreshold` property. In that case, the `IsConfirmed` property of the object or field of the structure is `true`.

Data Types: `struct` | `object`

tentativeTracks — Tentative tracks

array of `objectTrack` objects | array of structures

Tentative tracks, returned as an array of `objectTrack` objects in MATLAB, and returned as an array of structures in code generation. In code generation, the field names of the returned structure are same with the property names of `objectTrack`.

A track is tentative if it does not satisfy the confirmation threshold specified in the `ConfirmationThreshold` property. In that case, the `IsConfirmed` property of the object or field of the structure is `false`.

Data Types: `struct` | `object`

allTracks – All tracks

array of `objectTrack` objects | array of structures

All tracks, returned as an array of `objectTrack` objects in MATLAB, and returned as an array of structures in code generation. In code generation, the field names of the returned structure are same with the property names of `objectTrack`. All tracks consists of confirmed and tentative tracks.

Data Types: `struct` | `object`

Object Functions

To use an object function, specify the System object as the first input argument. For example, to release system resources of a System object named `obj`, use this syntax:

```
release(obj)
```

Specific to multiObjectTracker

<code>updateTracks</code>	Update multi-object tracker with new detections
<code>initializeTrack</code>	Initialize new track
<code>confirmTrack</code>	Confirm tentative track
<code>deleteTrack</code>	Delete existing track
<code>getTrackFilterProperties</code>	Obtain filter properties of track from multi-object tracker
<code>setTrackFilterProperties</code>	Set filter properties of track from multi-object tracker
<code>predictTracksToTime</code>	Predict track state

Common to All System Objects

<code>step</code>	Run System object algorithm
<code>release</code>	Release resources and allow changes to System object property values and input characteristics
<code>clone</code>	Create duplicate System object
<code>isLocked</code>	Determine if System object is in use
<code>reset</code>	Reset internal states of System object

Examples

Track Single Object Using Multi-Object Tracker

Create a `multiObjectTracker` System object™ using the default filter initialization function for a 2-D constant-velocity model. For this motion model, the state vector is $[x;vx;y;vy]$.

```
tracker = multiObjectTracker('ConfirmationThreshold',[4 5], ...  
    'DeletionThreshold',10);
```

Create a detection by specifying an `objectDetection` object. To use this detection with the multi-object tracker, enclose the detection in a cell array.

```

dettime = 1.0;
det = { ...
    objectDetection(dettime,[10; -1], ...
        'SensorIndex',1, ...
        'ObjectAttributes',{'ExampleObject',1}) ...
    };

```

Update the multi-object tracker with this detection by using the `updateTracks` function. The time at which you update the multi-object tracker must be greater than or equal to the time at which the object was detected.

```

updatetime = 1.25;
[confirmedTracks,tentativeTracks,allTracks] = updateTracks(tracker,det,updatetime);

```

Create another detection of the same object and update the multi-object tracker, this time by calling the tracker itself instead of using `updateTracks`. The tracker maintains only one track.

```

dettime = 1.5;
det = { ...
    objectDetection(dettime,[10.1; -1.1], ...
        'SensorIndex',1, ...
        'ObjectAttributes',{'ExampleObject',1}) ...
    };
updatetime = 1.75;
[confirmedTracks,tentativeTracks,allTracks] = tracker(det,updatetime);

```

Determine whether the track has been verified by checking the number of confirmed tracks.

```

numConfirmed = tracker.NumConfirmedTracks
numConfirmed = 0

```

Examine the position and velocity of the tracked object. Because the track has not been confirmed, get the position and velocity from the `tentativeTracks` structure.

```

positionSelector = [1 0 0 0; 0 0 1 0];
velocitySelector = [0 1 0 0; 0 0 0 1];
position = getTrackPositions(tentativeTracks,positionSelector)

position = 1x2

    10.1426    -1.1426

velocity = getTrackVelocities(tentativeTracks,velocitySelector)

velocity = 1x2

    0.1852    -0.1852

```

Confirm and Delete Track in Multi-Object Tracker

Create a sequence of detections of a moving object. Track the detections using a `multiObjectTracker` System object™. Observe how the tracks switch from tentative to confirmed and then to deleted.

Create a multi-object tracker using the `initcakf` filter initialization function. The tracker models 2-D constant-acceleration motion. For this motion model, the state vector is $[x;vx;ax;y;vy;ay]$.

```
tracker = multiObjectTracker('FilterInitializationFcn',@initcakf, ...
    'ConfirmationThreshold',[3 4], 'DeletionThreshold',[6 6]);
```

Create a sequence of detections of a moving target using `objectDetection`. To use these detections with the `multiObjectTracker`, enclose the detections in a cell array.

```
dt = 0.1;
pos = [10; -1];
vel = [10; 5];
for detno = 1:2
    time = (detno-1)*dt;
    det = { ...
        objectDetection(time,pos, ...
            'SensorIndex',1, ...
            'ObjectAttributes',{'ExampleObject',1}) ...
        };
    [confirmedTracks,tentativeTracks,allTracks] = tracker(det,time);
    pos = pos + vel*dt;
    meas = pos;
end
```

Verify that the track has not been confirmed yet by checking the number of confirmed tracks.

```
numConfirmed = tracker.NumConfirmedTracks
```

```
numConfirmed = 0
```

Because the track is not confirmed, get the position and velocity from the `tentativeTracks` structure.

```
positionSelector = [1 0 0 0 0 0; 0 0 0 1 0 0];
velocitySelector = [0 1 0 0 0 0; 0 0 0 0 1 0];
position = getTrackPositions(tentativeTracks,positionSelector)
```

```
position = 1x2
```

```
    10.6669    -0.6665
```

```
velocity = getTrackVelocities(tentativeTracks,velocitySelector)
```

```
velocity = 1x2
```

```
     3.3473     1.6737
```

Add more detections to confirm the track.

```
for detno = 3:5
    time = (detno-1)*dt;
    det = { ...
        objectDetection(time,pos, ...
            'SensorIndex',1, ...
            'ObjectAttributes',{'ExampleObject',1}) ...
        };
    [confirmedTracks,tentativeTracks,allTracks] = tracker(det,time);
```

```

    pos = pos + vel*dt;
    meas = pos;
end

```

Verify that the track has been confirmed, and display the position and velocity vectors for that track.

```

numConfirmed = tracker.NumConfirmedTracks

numConfirmed = 1

position = getTrackPositions(confirmedTracks,positionSelector)

position = 1x2

    13.8417    0.9208

velocity = getTrackVelocities(confirmedTracks,velocitySelector)

velocity = 1x2

    9.4670    4.7335

```

Let the tracker run but do not add new detections. The existing track is deleted.

```

for detno = 6:20
    time = (detno-1)*dt;
    det = {};
    [confirmedTracks,tentativeTracks,allTracks] = tracker(det,time);
    pos = pos + vel*dt;
    meas = pos;
end

```

Verify that the tracker has no tentative or confirmed tracks.

```

isempty(allTracks)

ans = logical
     1

```

Algorithms

When you pass detections into a multi-object tracker, the System object:

- Attempts to assign the input detections to existing tracks, based on the `AssignmentThreshold` property of the multi-object tracker.
- Creates new tracks from unassigned detections.
- Updates already assigned tracks and possibly confirms them, based on the `ConfirmationThreshold` property of the tracker.
- Deletes tracks that have no assigned detections, based on the `DeletionThreshold` property of the tracker.

Version History

Introduced in R2017a

R2020a: Track output format changed

Behavior changed in R2020a

Starting from R2020a, the track output format of `multiObjectTracker` changes from `track` structure to `objectTrack`. As a result, when you load a `multiObjectTracker` created in an earlier version of MATLAB, you need to release the tracker first so that it can allow `objectTrack` as the track output format.

Extended Capabilities

C/C++ Code Generation

Generate C and C++ code using MATLAB® Coder™.

Usage notes and limitations:

- See “System Objects in MATLAB Code Generation” (MATLAB Coder).
- All the detections used with the tracker must have fields with the same sizes and types.
- The `objectDetection` structure must have an `ObjectAttributes` field. The value of this field can be an empty structure, a structure, or a cell containing a structure. The structure for all detections must have the same fields and the values in these fields must always have the same size and type. The form of the structure cannot change during simulation.
- The first update to the tracker must contain at least one detection.
- When the filter initialization function returns a `trackingEKF` or `trackingUKF` object and when the `MaxNumDetections` property is specified as a finite integer, the tracker supports non-dynamic memory allocation code generation.

See Also

Functions

`assignDetectionsToTracks` | `getTrackPositions` | `getTrackVelocities`

Objects

`objectDetection` | `drivingScenario` | `trackingKF` | `trackingEKF` | `trackingUKF` | `drivingRadarDataGenerator` | `visionDetectionGenerator`

Topics

“Multiple Object Tracking Tutorial”

“Track Multiple Vehicles Using a Camera”

deleteTrack

Delete existing track

Syntax

```
deleted = deleteTrack(tracker, trackID)
```

Description

`deleted = deleteTrack(tracker, trackID)` deletes the track specified by `trackID` in the tracker.

Examples

Delete track in multiObjectTracker

Create a track using detections in a `multiObjectTracker` tracker.

```
tracker = multiObjectTracker
tracker =
  multiObjectTracker with properties:
      TrackerIndex: 0
      FilterInitializationFcn: 'initcvkf'
      AssignmentThreshold: [30 Inf]
      MaxNumTracks: 200
      MaxNumDetections: Inf
      MaxNumSensors: 20
      OOSMHandling: 'Terminate'
      ConfirmationThreshold: [2 3]
      DeletionThreshold: [5 5]
      HasCostMatrixInput: false
      HasDetectableTrackIDsInput: false
      StateParameters: [1x1 struct]
      NumTracks: 0
      NumConfirmedTracks: 0

detection1 = objectDetection(0,[1;1;1]);
detection2 = objectDetection(1,[1.1;1.2;1.1]);
tracker(detection1,0);
tracker(detection2,1)

ans =
  objectTrack with properties:
```

```
        TrackID: 1
        BranchID: 0
    SourceIndex: 0
        UpdateTime: 1
            Age: 2
                State: [6x1 double]
    StateCovariance: [6x6 double]
    StateParameters: [1x1 struct]
    ObjectClassID: 0
ObjectClassProbabilities: 1
        TrackLogic: 'History'
    TrackLogicState: [1 1 0 0 0]
        IsConfirmed: 1
            IsCoasted: 0
                IsSelfReported: 1
    ObjectAttributes: [1x1 struct]
```

Delete the first track.

```
deleted1 = deleteTrack(tracker,1)

deleted1 = logical
         1
```

Uncomment the following to delete a nonexistent track. A warning will be issued.

```
% deleted2 = deleteTrack(tracker,2)
```

Input Arguments

tracker — Multi-object tracker

multiObjectTracker System object

Multi-object tracker, specified as a multiObjectTracker System object.

trackID — Track identifier

positive integer

Track identifier, specified as a positive integer.

Example: 21

Output Arguments

deleted — Indicate if track was successfully deleted

1 | 0

Indicate if the track was successfully deleted or not, returned as 1 or 0. If the track specified by the trackID input existed and was successfully deleted, it returns as 1. If the track did not exist, a warning is issued and it returns as 0.

Version History

Introduced in R2020a

See Also

`multiObjectTracker` | `initializeTrack`

initializeTrack

Initialize new track

Syntax

```
trackID = initializeTrack(tracker, track)
trackID = initializeTrack(tracker, track, filter)
```

Description

`trackID = initializeTrack(tracker, track)` initializes a new track in the tracker. The tracker must be updated at least once before initializing a track. If the track is initialized successfully, the tracker assigns the output `trackID` to the track, sets the `UpdateTime` of the track equal to the last step time in the tracker, and synchronizes the data in the input `track` to the initialized track.

A warning is issued if the tracker already maintains the maximum number of tracks specified by its `MaxNumTracks` property. In this case, the `trackID` is returned as 0, which indicates a failure to initialize the track.

`trackID = initializeTrack(tracker, track, filter)` initializes a new track in the tracker, using a specified tracking filter, `filter`.

Examples

Initialize Track in multiObjectTracker

Create a multi-object tracker and update the tracker with detections at $t = 0$ and $t = 1$ second.

```
tracker = multiObjectTracker

tracker =
  multiObjectTracker with properties:

        TrackerIndex: 0
  FilterInitializationFcn: 'initcvkf'
  AssignmentThreshold: [30 Inf]
        MaxNumTracks: 200
  MaxNumDetections: Inf
        MaxNumSensors: 20

        OOSMHandling: 'Terminate'

  ConfirmationThreshold: [2 3]
  DeletionThreshold: [5 5]

        HasCostMatrixInput: false
  HasDetectableTrackIDsInput: false
        StateParameters: [1x1 struct]

        NumTracks: 0
```

```
NumConfirmedTracks: 0
```

```
detection1 = objectDetection(0,[1;1;1]);
detection2 = objectDetection(1,[1.1;1.2;1.1]);
tracker(detection1,0);
currentTrack = tracker(detection2,1);
```

As seen from the NumTracks property, the tracker now maintains one track.

```
tracker
```

```
tracker =
  multiObjectTracker with properties:

    TrackerIndex: 0
    FilterInitializationFcn: 'initcvkf'
    AssignmentThreshold: [30 Inf]
    MaxNumTracks: 200
    MaxNumDetections: Inf
    MaxNumSensors: 20

    OOSMHandling: 'Terminate'

    ConfirmationThreshold: [2 3]
    DeletionThreshold: [5 5]

    HasCostMatrixInput: false
    HasDetectableTrackIDsInput: false
    StateParameters: [1x1 struct]

    NumTracks: 1
    NumConfirmedTracks: 1
```

Create a new track using the objectTrack object.

```
newTrack = objectTrack()
```

```
newTrack =
  objectTrack with properties:

    TrackID: 1
    BranchID: 0
    SourceIndex: 1
    UpdateTime: 0
    Age: 1
    State: [6x1 double]
    StateCovariance: [6x6 double]
    StateParameters: [1x1 struct]
    ObjectClassID: 0
    ObjectClassProbabilities: 1
    TrackLogic: 'History'
    TrackLogicState: 1
    IsConfirmed: 1
    IsCoasted: 0
    IsSelfReported: 1
    ObjectAttributes: [1x1 struct]
```

Initialize a track in the GNN tracker object using the newly created track.

```
trackID = initializeTrack(tracker,newTrack)
```

```
trackID = uint32  
        2
```

As seen from the NumTracks property, the tracker now maintains two tracks.

```
tracker
```

```
tracker =  
    multiObjectTracker with properties:  
  
        TrackerIndex: 0  
    FilterInitializationFcn: 'initcvkf'  
    AssignmentThreshold: [30 Inf]  
        MaxNumTracks: 200  
    MaxNumDetections: Inf  
        MaxNumSensors: 20  
  
        OOSMHandling: 'Terminate'  
  
    ConfirmationThreshold: [2 3]  
        DeletionThreshold: [5 5]  
  
        HasCostMatrixInput: false  
    HasDetectableTrackIDsInput: false  
        StateParameters: [1x1 struct]  
  
        NumTracks: 2  
    NumConfirmedTracks: 2
```

Input Arguments

tracker — Multi-object tracker

multiObjectTracker System object

Multi-object tracker, specified as a multiObjectTracker System object.

track — New track to be initialized

objectTrack object | structure

New track to be initialized, specified as an objectTrack object or a structure. If specified as a structure, the name, variable type, and data size of the fields of the structure must be the same as the name, variable type, and data size of the corresponding properties of the objectTrack object.

Data Types: struct | object

filter — Filter object

trackingKF | trackingEKF | trackingUKF

Filter object, specified as a trackingKF, trackingEKF, or trackingUKF object.

Output Arguments

trackID — Track identifier

nonnegative integer

Track identifier, returned as a nonnegative integer. `trackID` is returned as 0 if the `track` is not initialized successfully.

Example: 2

Version History

Introduced in R2020a

See Also

`multiObjectTracker`

getTrackFilterProperties

Obtain filter properties of track from multi-object tracker

Syntax

```
values = getTrackFilterProperties(tracker,trackID,property)
values = getTrackFilterProperties(tracker,trackID,property1,...,propertyN)
```

Description

`values = getTrackFilterProperties(tracker,trackID,property)` returns the tracking filter property values for a specific track within a multi-object tracker. `trackID` is the ID of that specific track.

`values = getTrackFilterProperties(tracker,trackID,property1,...,propertyN)` returns multiple property values. You can specify the properties in any order.

Examples

Display and Set Tracking Filter Properties in Multi-Object Tracker

Create a `multiObjectTracker` System object™ using a constant-acceleration, linear Kalman filter for all tracks.

```
tracker = multiObjectTracker('FilterInitializationFcn',@initcakf, ...
    'ConfirmationParameters',[4 5],'DeletionThreshold',[9 9]);
```

Create two detections and generate tracks for these detections.

```
detection1 = objectDetection(1.0,[10; 10]);
detection2 = objectDetection(1.0,[1000; 1000]);
[~,tracks] = tracker([detection1 detection2],1.1)
```

`tracks=2x1 object`
2x1 `objectTrack` array with properties:

```
TrackID
BranchID
SourceIndex
UpdateTime
Age
State
StateCovariance
StateParameters
ObjectClassID
ObjectClassProbabilities
TrackLogic
TrackLogicState
IsConfirmed
IsCoasted
IsSelfReported
```

ObjectAttributes

Get filter property values for the first track. Display the process noise values.

```
values = getTrackFilterProperties(tracker,1, 'MeasurementNoise', 'ProcessNoise', 'MotionModel');
values{2}

ans = 2×2

     1     0
     0     1
```

Set new values for this property by doubling the process noise for the first track. Display the updated process noise values.

```
setTrackFilterProperties(tracker,1, 'ProcessNoise', 2*values{2});
values = getTrackFilterProperties(tracker,1, 'ProcessNoise');
values{1}

ans = 2×2

     2     0
     0     2
```

Input Arguments

tracker — Multi-object tracker

multiObjectTracker System object

Multi-object tracker, specified as a multiObjectTracker System object.

trackID — Track ID

positive integer

Track ID, specified as a positive integer. `trackID` must be a valid track in `tracker`.

property — Tracking filter property

character vector | string scalar

Tracking filter property to return values for, specified as a character vector or string scalar. `property` must be a valid property of the tracking filter used by `tracker`. Valid tracking filters are `trackingKF`, `trackingEKF`, and `trackingUKF`.

You can specify additional properties in any order.

Example: 'MeasurementNoise', 'ProcessNoise'

Data Types: char | string

Output Arguments

values — Tracking filter property values

cell array

Tracking filter property values, returned as a cell array. Each element in the cell array corresponds to the values of a specified property. `getTrackFilterProperties` returns the values in the same order in which you specified the corresponding properties.

Version History

Introduced in R2017a

See Also

Objects

`multiObjectTracker` | `trackingKF` | `trackingEKF` | `trackingUKF`

Functions

`updateTracks` | `setTrackFilterProperties`

predictTracksToTime

Predict track state

Syntax

```
predictedtracks = predictTracksToTime(tracker, trackID, time)
predictedtracks = predictTracksToTime(tracker, category, time)
predictedtracks = predictTracksToTime(tracker, category,
time, 'WithCovariance', tf)
```

Description

`predictedtracks = predictTracksToTime(tracker, trackID, time)` returns the predicted tracks, `predictedtracks`, of the tracker, at the specified time, `time`. The tracker or fuser must be updated at least once before calling this object function. Use `isLocked(tracker)` to test whether the tracker or fuser has been updated.

Note This function only outputs the predicted tracks and does not update the internal track states of the tracker.

`predictedtracks = predictTracksToTime(tracker, category, time)` returns all predicted tracks for a specified category, `category`, of tracked objects.

`predictedtracks = predictTracksToTime(tracker, category, time, 'WithCovariance', tf)` also allows you to specify whether to predict the state covariance of each track or not by setting the `tf` flag to `true` or `false`. Predicting the covariance slows down the prediction process and increases the computation cost, but it provides the predicted track state covariance in addition to the predicted state. The default is `false`.

Examples

Predict Track State in multiObjectTracker

Create a track from a detection at time $t = 0$ second and predict it to $t = 1$ second.

```
tracker = multiObjectTracker;
detection = objectDetection(0, [0;0;0]);
tracker(detection, 0);
predictedtracks = predictTracksToTime(tracker, 'all', 1)
```

```
predictedtracks =
    objectTrack with properties:
```

```
        TrackID: 1
        BranchID: 0
    SourceIndex: 0
        UpdateTime: 1
            Age: 1
```

```
        State: [6x1 double]
    StateCovariance: [6x6 double]
    StateParameters: [1x1 struct]
        ObjectClassID: 0
ObjectClassProbabilities: 1
        TrackLogic: 'History'
    TrackLogicState: [1 0 0 0 0]
        IsConfirmed: 0
        IsCoasted: 0
        IsSelfReported: 1
    ObjectAttributes: [1x1 struct]
```

Input Arguments

tracker — Multi-object tracker

multiObjectTracker System object

Multi-object tracker, specified as a multiObjectTracker System object.

trackID — Track identifier

positive integer

Track identifier, specified as a positive integer. Only the track specified by the trackID is predicted in the tracker.

Example: 15

Data Types: single | double

time — Prediction time

scalar

Prediction time, specified as a scalar. The states of tracks are predicted to this time. The time must be greater than the time input to the tracker in the previous track update. Units are in seconds.

Example: 1.0

Data Types: single | double

category — Track categories

'all' | 'confirmed' | 'tentative'

Track categories, specified as 'all', 'confirmed', or 'tentative'. You can choose to predict all tracks, only confirmed tracks, or only tentative tracks.

Data Types: char

Output Arguments

predictedtracks — List of predicted track or branch states

array of objectTrack objects | array of structures

List of tracks or branches, returned as:

- An array of `objectTrack` objects in the MATLAB interpreted mode.
- An array of structures in the code generation mode. The field names of the structures are the same as the names of properties in `objectTrack`.

Data Types: `struct` | `object`

Version History

Introduced in R2020a

See Also

`multiObjectTracker`

setTrackFilterProperties

Set filter properties of track from multi-object tracker

Syntax

```
setTrackFilterProperties(tracker, trackID, property, value)
setTrackFilterProperties(tracker,
trackID, property1, value1, ..., propertyN, valueN)
```

Description

`setTrackFilterProperties(tracker, trackID, property, value)` sets the specified tracking filter property to the indicated value for a specific track within the multi-object tracker. `trackID` is the ID of that specific track.

`setTrackFilterProperties(tracker, trackID, property1, value1, ..., propertyN, valueN)` sets multiple property values. You can specify the property-value pairs in any order.

Examples

Display and Set Tracking Filter Properties in Multi-Object Tracker

Create a `multiObjectTracker` System object™ using a constant-acceleration, linear Kalman filter for all tracks.

```
tracker = multiObjectTracker('FilterInitializationFcn', @initcakf, ...
    'ConfirmationParameters', [4 5], 'DeletionThreshold', [9 9]);
```

Create two detections and generate tracks for these detections.

```
detection1 = objectDetection(1.0, [10; 10]);
detection2 = objectDetection(1.0, [1000; 1000]);
[~, tracks] = tracker([detection1 detection2], 1.1)
```

`tracks=2x1 object`
2x1 `objectTrack` array with properties:

```
TrackID
BranchID
SourceIndex
UpdateTime
Age
State
StateCovariance
StateParameters
ObjectClassID
ObjectClassProbabilities
TrackLogic
TrackLogicState
IsConfirmed
```

```
IsCoasted
IsSelfReported
ObjectAttributes
```

Get filter property values for the first track. Display the process noise values.

```
values = getTrackFilterProperties(tracker,1,'MeasurementNoise','ProcessNoise','MotionModel');
values{2}
```

```
ans = 2×2
```

```
    1    0
    0    1
```

Set new values for this property by doubling the process noise for the first track. Display the updated process noise values.

```
setTrackFilterProperties(tracker,1,'ProcessNoise',2*values{2});
values = getTrackFilterProperties(tracker,1,'ProcessNoise');
values{1}
```

```
ans = 2×2
```

```
    2    0
    0    2
```

Input Arguments

tracker — Multi-object tracker

multiObjectTracker System object

Multi-object tracker, specified as a multiObjectTracker System object.

trackID — Track ID

positive integer

Track ID, specified as a positive integer. trackID must be a valid track in tracker.

property — Tracking filter property

character vector | string scalar

Tracking filter property to set values for, specified as a character vector or string scalar. property must be a valid property of the tracking filter used by tracker. Valid tracking filters are trackingKF, trackingEKF, and trackingUKF.

You can specify additional property-value pairs in any order.

Example: 'MeasurementNoise',eye(2,2),'MotionModel','2D Constant Acceleration'

Data Types: char | string

value — Value to set tracking filter property to

valid MATLAB expression

Value to set the corresponding tracking filter property to, specified as a MATLAB expression. `value` must be a valid value of the corresponding property.

You can specify additional property-value pairs in any order.

Example: `'MeasurementNoise',eye(2,2),'MotionModel','2D Constant Acceleration'`

Version History

Introduced in R2017a

See Also

Objects

`multiObjectTracker` | `trackingKF` | `trackingEKF` | `trackingUKF`

Functions

`updateTracks` | `getTrackFilterProperties`

updateTracks

Update multi-object tracker with new detections

Syntax

```
confirmedTracks = updateTracks(tracker,detections,time)
[confirmedTracks,tentativeTracks] = updateTracks(tracker,detections,time)
[confirmedTracks,tentativeTracks,allTracks] = updateTracks(tracker,
detections,time)
[ ___ ] = updateTracks(tracker,detections,time,costMatrix)
[ ___ ] = updateTracks( ___,detectableTrackIDs)
```

Description

`confirmedTracks = updateTracks(tracker,detections,time)` creates, updates, and deletes tracks in the `multiObjectTracker` System object, `tracker`. Updates are based on the specified list of `detections`, and all tracks are updated to the specified time. Each element in the returned `confirmedTracks` corresponds to a single track.

`[confirmedTracks,tentativeTracks] = updateTracks(tracker,detections,time)` also returns `tentativeTracks` containing details about the tentative tracks.

`[confirmedTracks,tentativeTracks,allTracks] = updateTracks(tracker,detections,time)` also returns `allTracks` containing details about all confirmed and tentative tracks. The tracks are returned in the order by which the tracker internally maintains them. You can use this output to help you calculate the cost matrix, an optional input argument.

`[___] = updateTracks(tracker,detections,time,costMatrix)` specifies a cost matrix, returning any of the outputs from preceding syntaxes.

To specify a cost matrix, set the `HasCostMatrixInput` property of `tracker` to `true`.

`[___] = updateTracks(___,detectableTrackIDs)` also specifies a list of expected detectable tracks given by `detectableTrackIDs`. This argument can be used with any of the previous input syntaxes.

To enable this syntax, set the `HasDetectableTrackIDsInput` property to `true`.

Examples

Track Single Object Using Multi-Object Tracker

Create a `multiObjectTracker` System object™ using the default filter initialization function for a 2-D constant-velocity model. For this motion model, the state vector is $[x;vx;y;vy]$.

```
tracker = multiObjectTracker('ConfirmationThreshold',[4 5], ...
'DeletionThreshold',10);
```

Create a detection by specifying an `objectDetection` object. To use this detection with the multi-object tracker, enclose the detection in a cell array.

```
dettime = 1.0;
det = { ...
    objectDetection(dettime,[10; -1], ...
        'SensorIndex',1, ...
        'ObjectAttributes',{'ExampleObject',1}) ...
    };
```

Update the multi-object tracker with this detection by using the `updateTracks` function. The time at which you update the multi-object tracker must be greater than or equal to the time at which the object was detected.

```
updatetime = 1.25;
[confirmedTracks,tentativeTracks,allTracks] = updateTracks(tracker,det,updatetime);
```

Create another detection of the same object and update the multi-object tracker, this time by calling the tracker itself instead of using `updateTracks`. The tracker maintains only one track.

```
dettime = 1.5;
det = { ...
    objectDetection(dettime,[10.1; -1.1], ...
        'SensorIndex',1, ...
        'ObjectAttributes',{'ExampleObject',1}) ...
    };
updatetime = 1.75;
[confirmedTracks,tentativeTracks,allTracks] = tracker(det,updatetime);
```

Determine whether the track has been verified by checking the number of confirmed tracks.

```
numConfirmed = tracker.NumConfirmedTracks
numConfirmed = 0
```

Examine the position and velocity of the tracked object. Because the track has not been confirmed, get the position and velocity from the `tentativeTracks` structure.

```
positionSelector = [1 0 0 0; 0 0 1 0];
velocitySelector = [0 1 0 0; 0 0 0 1];
position = getTrackPositions(tentativeTracks,positionSelector)
```

```
position = 1×2
    10.1426    -1.1426
```

```
velocity = getTrackVelocities(tentativeTracks,velocitySelector)
```

```
velocity = 1×2
    0.1852    -0.1852
```

Input Arguments

tracker — Multi-object tracker

`multiObjectTracker` System object

Multi-object tracker, specified as a `multiObjectTracker` System object.

detections — Detection listcell array of `objectDetection` objects

Detection list, specified as a cell array of `objectDetection` objects. The `Time` property value of each `objectDetection` object must be less than or equal to the current time of update, `time`, and greater than the previous time value used to update the multi-object tracker.

time — Time of update

real scalar

Time of update, specified as a real scalar. The tracker updates all tracks to this time. Units are in seconds.

`time` must be greater than or equal to the largest `Time` property value of the `objectDetection` objects in the input `detections` list. `time` must increase in value with each update to the multi-object tracker.

Data Types: `double`**costMatrix — Cost matrix** N_T -by- N_D matrix

Cost matrix, specified as a real-valued N_T -by- N_D matrix, where N_T is the number of existing tracks, and N_D is the number of current detections. The rows of the cost matrix correspond to the existing tracks. The columns correspond to the detections. Tracks are ordered as they appear in the list of tracks in the `allTracks` output argument of the previous update to the multi-object tracker.

In the first update to the multi-object tracker, or when the tracker has no previous tracks, assign the cost matrix a size of $[0, N_D]$. The cost must be calculated so that lower costs indicate a higher likelihood that the tracker assigns a detection to a track. To prevent certain detections from being assigned to certain tracks, use `Inf`.

Dependencies

To enable specification of the cost matrix when updating tracks, set the `HasCostMatrixInput` property of the tracker to `true`

Data Types: `double`**detectableTrackIDs — Detectable track IDs**real-valued M -by-1 vector | real-valued M -by-2 matrix

Detectable track IDs, specified as a real-valued M -by-1 vector or M -by-2 matrix. Detectable tracks are tracks that the sensors expect to detect. The first column of the matrix contains a list of track IDs that the sensors report as detectable. The optional second column contains the detection probability for the track. The detection probability is either reported by a sensor or, if not reported, obtained from the `DetectionProbability` property.

Tracks whose identifiers are not included in `detectableTrackIDs` are considered as undetectable. The track deletion logic does not count the lack of detection as a 'missed detection' for track deletion purposes.

Dependencies

To enable this input argument, set the `detectableTrackIDs` property to `true`.

Data Types: `single` | `double`

Output Arguments

confirmedTracks — Confirmed tracks

array of `objectTrack` objects | array of structures

Confirmed tracks, returned as an array of `objectTrack` objects in MATLAB, and returned as an array of structures in code generation. In code generation, the field names of the returned structure are same with the property names of `objectTrack`.

A track is confirmed if it satisfies the confirmation threshold specified in the `ConfirmationThreshold` property. In that case, the `IsConfirmed` property of the object or field of the structure is `true`.

Data Types: `struct` | `object`

tentativeTracks — Tentative tracks

array of `objectTrack` objects | array of structures

Tentative tracks, returned as an array of `objectTrack` objects in MATLAB, and returned as an array of structures in code generation. In code generation, the field names of the returned structure are same with the property names of `objectTrack`.

A track is tentative if it does not satisfy the confirmation threshold specified in the `ConfirmationThreshold` property. In that case, the `IsConfirmed` property of the object or field of the structure is `false`.

Data Types: `struct` | `object`

allTracks — All tracks

array of `objectTrack` objects | array of structures

All tracks, returned as an array of `objectTrack` objects in MATLAB, and returned as an array of structures in code generation. In code generation, the field names of the returned structure are same with the property names of `objectTrack`. All tracks consists of confirmed and tentative tracks.

Data Types: `struct` | `object`

Algorithms

When you pass detections into `updateTracks`, the function:

- Attempts to assign the input detections to existing tracks, based on the `AssignmentThreshold` property of the multi-object tracker.
- Creates new tracks from unassigned detections.
- Updates already assigned tracks and possibly confirms them, based on the `ConfirmationThreshold` property of the tracker.
- Deletes tracks that have no assigned detections, based on the `DeletionThreshold` property of the tracker.

Version History

Introduced in R2017a

See Also

Objects

[multiObjectTracker](#) | [objectDetection](#)

Functions

[setTrackFilterProperties](#) | [getTrackFilterProperties](#)

confirmTrack

Confirm tentative track

Syntax

```
confirmed = confirmTrack(tracker,trackID)
```

Description

`confirmed = confirmTrack(tracker,trackID)` confirms a tentative track with the specified track ID in the tracker.

Examples

Confirm Track

Create a `multiObjectTracker` System object.

```
tracker = multiObjectTracker;
```

Create one `objectDetection` object and use it to update the tracker.

```
detection1 = objectDetection(0,[1;1;1]);  
[confirmedTracks,tentativeTracks]=tracker(detection1,0)
```

```
confirmedTracks =
```

```
    0x1 objectTrack array with properties:
```

```
    TrackID  
    BranchID  
    SourceIndex  
    UpdateTime  
    Age  
    State  
    StateCovariance  
    StateParameters  
    ObjectClassID  
    ObjectClassProbabilities  
    TrackLogic  
    TrackLogicState  
    IsConfirmed  
    IsCoasted  
    IsSelfReported  
    ObjectAttributes
```

```
tentativeTracks =  
    objectTrack with properties:
```

```
        TrackID: 1  
        BranchID: 0
```

```

        SourceIndex: 0
        UpdateTime: 0
        Age: 1
        State: [6x1 double]
        StateCovariance: [6x6 double]
        StateParameters: [1x1 struct]
        ObjectClassID: 0
ObjectClassProbabilities: 1
        TrackLogic: 'History'
        TrackLogicState: [1 0 0 0 0]
        IsConfirmed: 0
        IsCoasted: 0
        IsSelfReported: 1
ObjectAttributes: [1x1 struct]

```

From the results, the tracker does not maintain any confirmed tracks and only maintains one tentative track.

Confirm the tentative track using the `confirmTrack` object function.

```

confirmed = confirmTrack(tracker,1)

confirmed = logical
         1

```

Input Arguments

tracker — Multi-object tracker

`multiObjectTracker` System object

Multi-object tracker, specified as a `multiObjectTracker` System object.

trackID — Track identifier

positive integer

Track identifier, specified as a positive integer.

Example: 21

Output Arguments

confirmed — Indicate if track is successfully confirmed

true or logical 1 | false or logical 0

Indicate if the track is successfully confirmed, returned as a logical 1 (true) or 0 (false). If the tentative track specified by the `trackID` input exists, the function confirms the track and returns 1. If the tentative track does not exist, the function issues a warning and returns 0.

Version History

Introduced in R2022b

Extended Capabilities

C/C++ Code Generation

Generate C and C++ code using MATLAB® Coder™.

acfObjectDetectorMonoCamera

Detect objects in monocular camera using aggregate channel features

Description

The `acfObjectDetectorMonoCamera` contains information about an aggregate channel features (ACF) object detector that is configured for use with a monocular camera sensor. To detect objects in an image that was captured by the camera, pass the detector to the `detect` function.

Creation

- 1 Create an `acfObjectDetector` object by calling the `trainACFObjectDetector` function with training data.

```
detector = trainACFObjectDetector(trainingData,...);
```

Alternatively, create a pretrained detector using functions such as `vehicleDetectorACF` or `peopleDetectorACF`.

- 2 Create a `monoCamera` object to model the monocular camera sensor.

```
sensor = monoCamera(...);
```

- 3 Create an `acfObjectDetectorMonoCamera` object by passing the detector and sensor as inputs to the `configureDetectorMonoCamera` function. The configured detector inherits property values from the original detector.

```
configuredDetector = configureDetectorMonoCamera(detector,sensor,...);
```

Properties

ModelName — Name of classification model

character vector | string scalar

Name of the classification model, specified as a character vector or string scalar. By default, the name is set to the heading of the second column of the `trainingData` table specified in the `trainACFObjectDetector` function. You can modify this name after creating your `acfObjectDetectorMonoCamera` object.

Example: 'stopSign'

ObjectTrainingSize — Size of training images

[height width] vector

This property is read-only.

Size of training images, specified as a [height width] vector.

Example: [100 100]

NumWeakLearners — Number of weak learners

integer

This property is read-only.

Number of weak learners used in the detector, specified as an integer. `NumWeakLearners` is less than or equal to the maximum number of weak learners for the last training stage. To restrict this maximum, you can use the 'MaxWeakLearners' name-value pair in the `trainACFObjectDetector` function.

Camera — Camera configuration

`monoCamera` object

This property is read-only.

Camera configuration, specified as a `monoCamera` object. The object contains the camera intrinsics, the location, the pitch, yaw, and roll placement, and the world units for the parameters. Use the intrinsics to transform the object points in the image to world coordinates, which you can then compare to the values in the `WorldObjectSize` property.

WorldObjectSize — Range of object widths and lengths

`[minWidth maxWidth]` vector | `[minWidth maxWidth; minLength maxLength]` matrix

This property is read-only.

Range of object widths and lengths in world units, specified as a `[minWidth maxWidth]` vector or `[minWidth maxWidth; minLength maxLength]` matrix. Specifying the range of object lengths is optional.

Object Functions

`detect` Detect objects using ACF object detector configured for monocular camera

Examples

Detect Vehicles Using Monocular Camera and ACF

Configure an ACF object detector for use with a monocular camera mounted on an ego vehicle. Use this detector to detect vehicles within video frames captured by the camera.

Load an `acfObjectDetector` object pretrained to detect vehicles.

```
detector = vehicleDetectorACF;
```

Model a monocular camera sensor by creating a `monoCamera` object. This object contains the camera intrinsics and the location of the camera on the ego vehicle.

```
focalLength = [309.4362 344.2161]; % [fx fy]
principalPoint = [318.9034 257.5352]; % [cx cy]
imageSize = [480 640]; % [mrows ncols]
height = 2.1798; % height of camera above ground, in meters
pitch = 14; % pitch of camera, in degrees
intrinsics = cameraIntrinsics(focalLength,principalPoint,imageSize);

monCam = monoCamera(intrinsics,height,'Pitch',pitch);
```

Configure the detector for use with the camera. Limit the width of detected objects to a typical range for vehicle widths: 1.5-2.5 meters. The configured detector is an `acfObjectDetectorMonoCamera` object.

```
vehicleWidth = [1.5 2.5];  
detectorMonoCam = configureDetectorMonoCamera(detector, monCam, vehicleWidth);
```

Load a video captured from the camera, and create a video reader and player.

```
videoFile = fullfile(toolboxdir('driving'),'drivingdata','caltech_washington1.avi');  
reader = VideoReader(videoFile);  
videoPlayer = vision.VideoPlayer('Position',[29 597 643 386]);
```

Run the detector in a loop over the video. Annotate the video with the bounding boxes for the detections and the detection confidence scores.

```
cont = hasFrame(reader);  
while cont  
    I = readFrame(reader);  
  
    % Run the detector.  
    [bboxes,scores] = detect(detectorMonoCam,I);  
    if ~isempty(bboxes)  
        I = insertObjectAnnotation(I, ...  
                                   'rectangle',bboxes, ...  
                                   scores, ...  
                                   'Color','g');  
    end  
    videoPlayer(I)  
    % Exit the loop if the video player figure is closed.  
    cont = hasFrame(reader) && isOpen(videoPlayer);  
end  
  
release(videoPlayer);
```

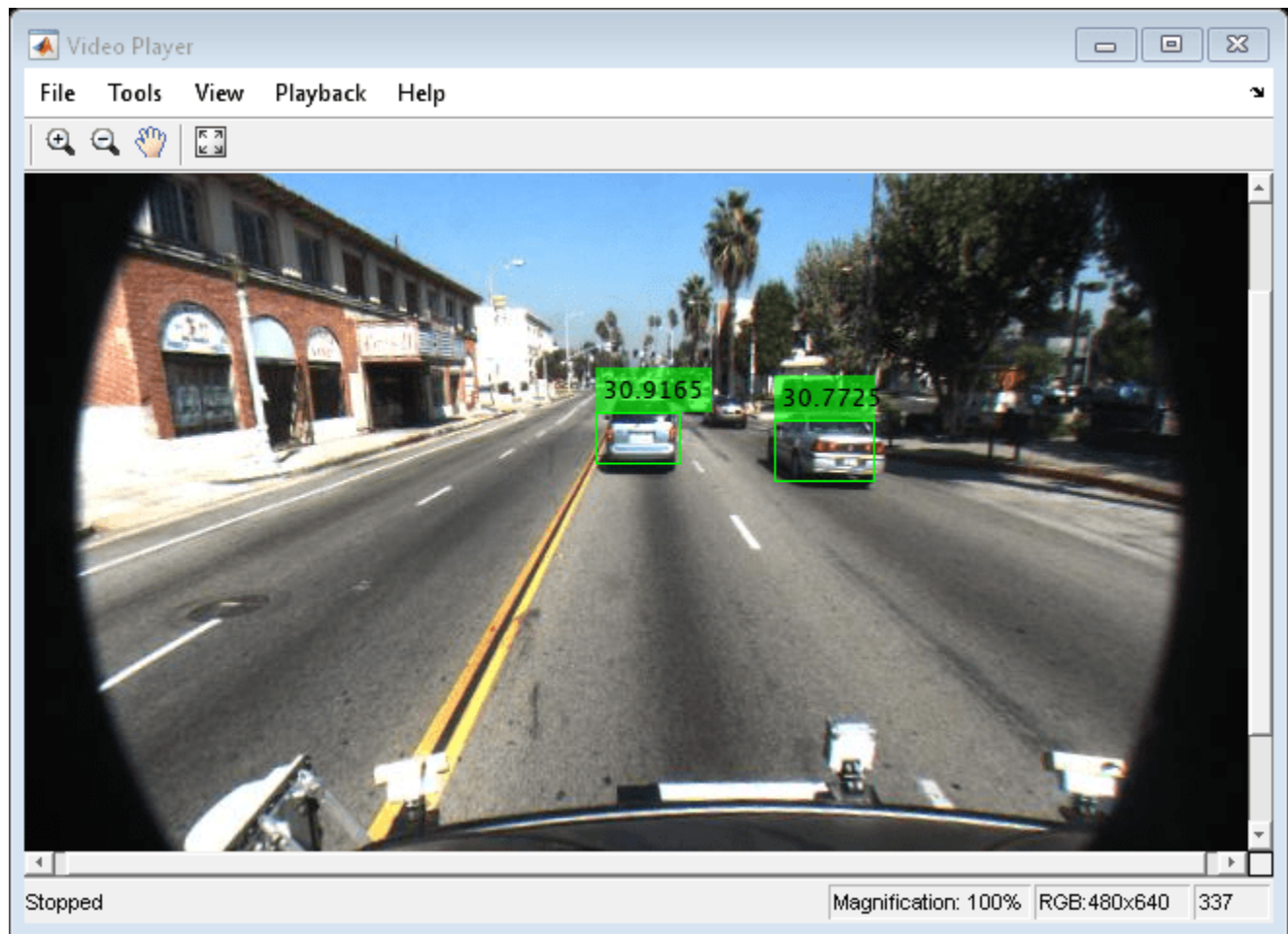

Version History

Introduced in R2017a

Extended Capabilities

C/C++ Code Generation

Generate C and C++ code using MATLAB® Coder™.

This function supports C/C++ code generation with the limitations:

- Supports code generation (requires MATLAB Coder™) only in generic MATLAB Host Computer target platform.

See Also

Apps

Ground Truth Labeler

Functions

trainACFObjectDetector | configureDetectorMonoCamera | vehicleDetectorACF |
peopleDetectorACF

Objects

monoCamera

detect

Detect objects using ACF object detector configured for monocular camera

Syntax

```
bboxes = detect(detector,I)
[bboxes,scores] = detect(detector,I)
[ ___ ]= detect(detector,I,roi)
[ ___ ] = detect( ___ ,Name,Value)
```

Description

`bboxes = detect(detector,I)` detects objects within image `I` using an aggregate channel features (ACF) object detector configured for a monocular camera. The locations of objects detected are returned as a set of bounding boxes.

`[bboxes,scores] = detect(detector,I)` also returns the detection confidence scores for each bounding box.

`[___]= detect(detector,I,roi)` detects objects within the rectangular search region specified by `roi`, using any of the preceding syntaxes.

`[___] = detect(___ ,Name,Value)` specifies options using one or more `Name,Value` pair arguments. For example, `detect(detector,I,'WindowStride',2)` sets the stride of the sliding window used to detect objects to 2.

Examples

Detect Vehicles Using Monocular Camera and ACF

Configure an ACF object detector for use with a monocular camera mounted on an ego vehicle. Use this detector to detect vehicles within video frames captured by the camera.

Load an `acfObjectDetector` object pretrained to detect vehicles.

```
detector = vehicleDetectorACF;
```

Model a monocular camera sensor by creating a `monoCamera` object. This object contains the camera intrinsics and the location of the camera on the ego vehicle.

```
focalLength = [309.4362 344.2161]; % [fx fy]
principalPoint = [318.9034 257.5352]; % [cx cy]
imageSize = [480 640]; % [mrows ncols]
height = 2.1798; % height of camera above ground, in meters
pitch = 14; % pitch of camera, in degrees
intrinsics = cameraIntrinsics(focalLength,principalPoint,imageSize);

monCam = monoCamera(intrinsics,height,'Pitch',pitch);
```

Configure the detector for use with the camera. Limit the width of detected objects to a typical range for vehicle widths: 1.5-2.5 meters. The configured detector is an `acfObjectDetectorMonoCamera` object.

```
vehicleWidth = [1.5 2.5];  
detectorMonoCam = configureDetectorMonoCamera(detector, monCam, vehicleWidth);
```

Load a video captured from the camera, and create a video reader and player.

```
videoFile = fullfile(toolboxdir('driving'),'drivingdata','caltech_washington1.avi');  
reader = VideoReader(videoFile);  
videoPlayer = vision.VideoPlayer('Position',[29 597 643 386]);
```

Run the detector in a loop over the video. Annotate the video with the bounding boxes for the detections and the detection confidence scores.

```
cont = hasFrame(reader);  
while cont  
    I = readFrame(reader);  
  
    % Run the detector.  
    [bboxes,scores] = detect(detectorMonoCam,I);  
    if ~isempty(bboxes)  
        I = insertObjectAnnotation(I, ...  
                                   'rectangle',bboxes, ...  
                                   scores, ...  
                                   'Color','g');  
    end  
    videoPlayer(I)  
    % Exit the loop if the video player figure is closed.  
    cont = hasFrame(reader) && isOpen(videoPlayer);  
end  
  
release(videoPlayer);
```

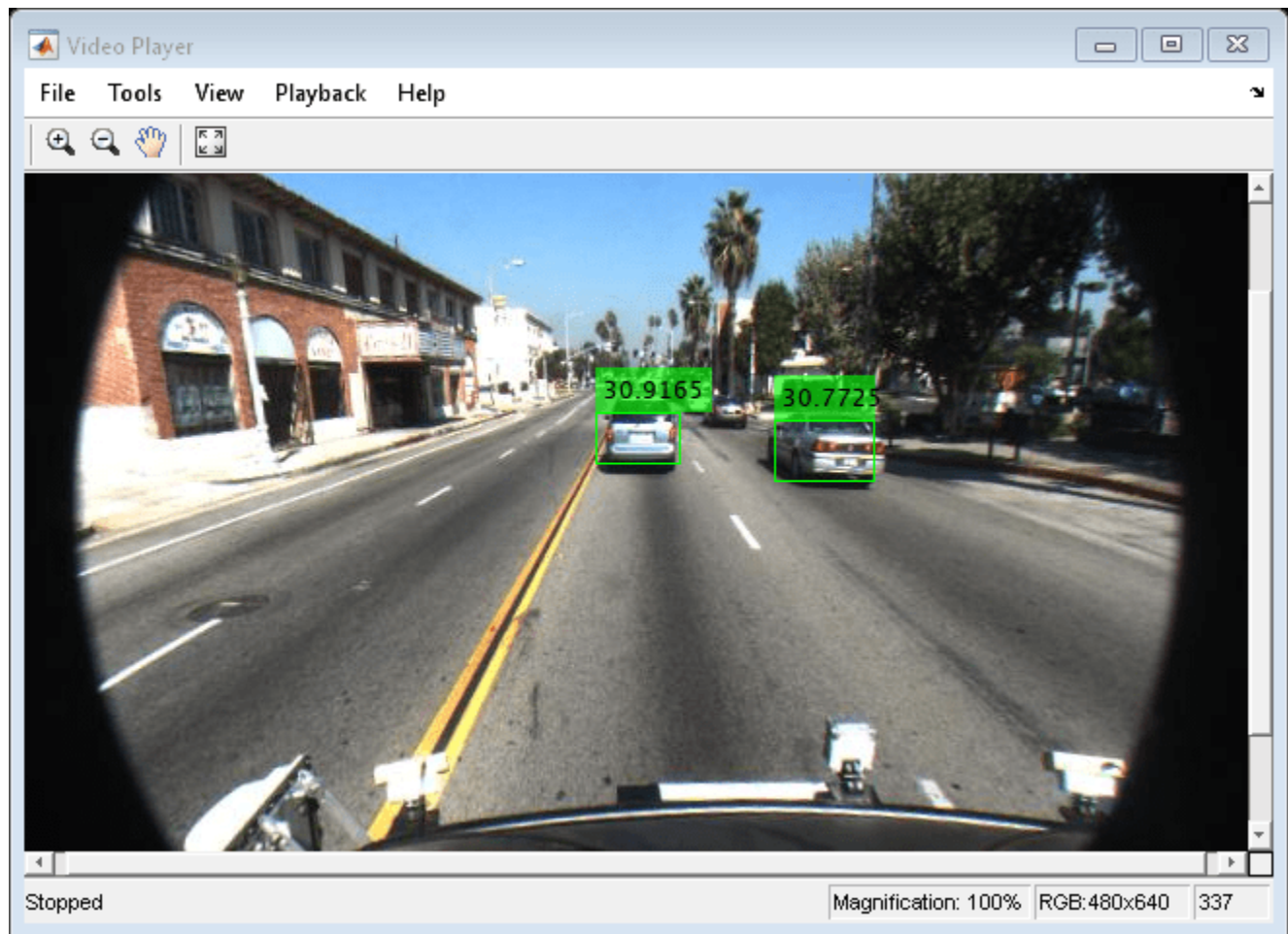

Input Arguments

detector — ACF object detector configured for monocular camera

acfObjectDetectorMonoCamera object

ACF object detector configured for a monocular camera, specified as an `acfObjectDetectorMonoCamera` object. To create this object, use the `configureDetectorMonoCamera` function with a `monoCamera` object and trained `acfObjectDetector` object as inputs.

I — Input image

grayscale image | RGB image

Input image, specified as a real, nonsparse, grayscale or RGB image.

Data Types: `uint8` | `uint16` | `int16` | `double` | `single`

ds — Datastore

datastore object

Datastore, specified as a `datastore` object containing a collection of images. Each image must be a grayscale or RGB. The function processes only the first column of the datastore, which must contain

images and must be cell arrays or tables with multiple columns. Therefore, `datastore read` function must return image data in the first column.

roi — Search region of interest

`[x y width height]` vector

Search region of interest, specified as an `[x y width height]` vector. The vector specifies the upper left corner and size of a region in pixels.

Name-Value Pair Arguments

Specify optional pairs of arguments as `Name1=Value1, ..., NameN=ValueN`, where `Name` is the argument name and `Value` is the corresponding value. Name-value arguments must appear after other arguments, but the order of the pairs does not matter.

Before R2021a, use commas to separate each name and value, and enclose Name in quotes.

Example: `WindowStride=2` sets the stride of the sliding window used to detects objects to 2.

NumScaleLevels — Number of scale levels per octave

8 (default) | positive integer

Number of scale levels per octave, specified a positive integer. Each octave is a power-of-two downscaling of the image. To detect people at finer scale increments, increase this number. Recommended values are in the range [4, 8].

WindowStride — Stride for sliding window

4 (default) | positive integer

Stride for the sliding window, specified as a positive integer. This value indicates the distance for the function to move the window in both the `x` and `y` directions. The sliding window scans the images for object detection.

SelectStrongest — Select strongest bounding box for each object

`true` (default) | `false`

Select the strongest bounding box for each detected object, specified as `true` or `false`.

- `true` — Return the strongest bounding box per object. To select these boxes, `detect` calls the `selectStrongestBbox` function, which uses nonmaximal suppression to eliminate overlapping bounding boxes based on their confidence scores.
- `false` — Return all detected bounding boxes. You can then create your own custom operation to eliminate overlapping bounding boxes.

MinSize — Minimum region size

`[height width]` vector

Minimum region size that contains a detected object, specified as a vector of the form `[height width]`. Units are in pixels.

By default, `MinSize` is the smallest object that the trained `detector` can detect.

MaxSize — Maximum region size

`size(I)` (default) | `[height width]` vector

Maximum region size that contains a detected object, specified as a vector of the form [*height width*]. Units are in pixels.

To reduce computation time, set this value to the known maximum region size for the objects being detected in the image. By default, 'MaxSize' is set to the height and width of the input image, *I*.

Threshold — Classification accuracy threshold

-1 (default) | numeric scalar

Classification accuracy threshold, specified as a numeric scalar. Recommended values are in the range [-1, 1]. During multiscale object detection, the threshold value controls the accuracy and speed for classifying image subregions as either objects or nonobjects. To speed up the performance at the risk of missing true detections, increase this threshold.

Output Arguments

bboxes — Location of objects detected within image

M-by-4 matrix

Location of objects detected within the input image, returned as an *M*-by-4 matrix, where *M* is the number of bounding boxes. Each row of **bboxes** contains a four-element vector of the form [*x y width height*]. This vector specifies the upper left corner and size of that corresponding bounding box in pixels.

scores — Detection confidence scores

M-by-1 vector

Detection confidence scores, returned as an *M*-by-1 vector, where *M* is the number of bounding boxes. Scores are returned in the range [-inf inf]. A higher score indicates higher confidence in the detection.

detectionResults — Detection results

3-column table

Detection results, returned as a 3-column table with variable names, *Boxes*, *Scores*, and *Labels*. The *Boxes* column contains *M*-by-4 matrices, of *M* bounding boxes for the objects found in the image. Each row contains a bounding box as a 4-element vector in the format [*x,y,width,height*]. The format specifies the upper-left corner location and size in pixels of the bounding box in the corresponding image.

Version History

Introduced in R2017a

See Also

Apps

Ground Truth Labeler

Functions

trainACFObjectDetector | configureDetectorMonoCamera | selectStrongestBbox

Objects

acfObjectDetector | monoCamera

fastRCNNObjectDetectorMonoCamera

Detect objects in monocular camera using Fast R-CNN deep learning detector

Description

The `fastRCNNObjectDetectorMonoCamera` object contains information about a Fast R-CNN (regions with convolutional neural networks) object detector that is configured for use with a monocular camera sensor. To detect objects in an image that was captured by the camera, pass the detector to the `detect` function. To classify image regions, pass the detector to the `classifyRegions` function.

When using `detect` or `classifyRegions` with `fastRCNNObjectDetectorMonoCamera`, use of a CUDA®-enabled NVIDIA® GPU is highly recommended. The GPU reduces computation time significantly. Usage of the GPU requires Parallel Computing Toolbox™. For information about the supported compute capabilities, see “GPU Computing Requirements” (Parallel Computing Toolbox).

Creation

- 1 Create a `fastRCNNObjectDetector` object by calling the `trainFastRCNNObjectDetector` function with training data (requires Deep Learning Toolbox).

```
detector = trainFastRCNNObjectDetector(trainingData,...);
```
- 2 Create a `monoCamera` object to model the monocular camera sensor.

```
sensor = monoCamera(...);
```
- 3 Create a `fastRCNNObjectDetectorMonoCamera` object by passing the detector and sensor as inputs to the `configureDetectorMonoCamera` function. The configured detector inherits property values from the original detector.

```
configuredDetector = configureDetectorMonoCamera(detector,sensor,...);
```

Properties

ModelName — Name of classification model

character vector | string scalar

Name of the classification model, specified as a character vector or string scalar. By default, the name is set to the heading of the second column of the `trainingData` table specified in the `trainFastRCNNObjectDetector` function. You can modify this name after creating your `fastRCNNObjectDetectorMonoCamera` object.

Example: 'stopSign'

Network — Trained Fast R-CNN object detection network

object

This property is read-only.

Trained Fast R-CNN detection network, specified as an object. This object stores the layers that define the convolutional neural network used within the Fast R-CNN detector. This network classifies region proposals produced by the `RegionProposalFcn` property.

RegionProposalFcn — Region proposal method

function handle

Region proposal method, specified as a function handle.

ClassNames — Object class names

cell array

This property is read-only.

Names of the object classes that the Fast R-CNN detector was trained to find, specified as a cell array. This property is set by the `trainingData` input argument for the `trainFastRCNNObjectDetector` function. Specify the class names as part of the `trainingData` table.

MinObjectSize — Minimum object size supported

[height width] vector

This property is read-only.

Minimum object size supported by the Fast R-CNN network, specified as a *[height width]* vector. The minimum size depends on the network architecture.

Camera — Camera configuration

monoCamera object

This property is read-only.

Camera configuration, specified as a `monoCamera` object. The object contains the camera intrinsics, the location, the pitch, yaw, and roll placement, and the world units for the parameters. Use the intrinsics to transform the object points in the image to world coordinates, which you can then compare to the values in the `WorldObjectSize` property.

WorldObjectSize — Range of object widths and lengths

[minWidth maxWidth] vector | *[minWidth maxWidth; minLength maxLength]* matrix

This property is read-only.

Range of object widths and lengths in world units, specified as a *[minWidth maxWidth]* vector or *[minWidth maxWidth; minLength maxLength]* matrix. Specifying the range of object lengths is optional.

Object Functions

<code>detect</code>	Detect objects using Fast R-CNN object detector configured for monocular camera
<code>classifyRegions</code>	Classify objects in image regions using Fast R-CNN object detector configured for monocular camera

Version History

Introduced in R2017a

See Also

Apps

Ground Truth Labeler

Functions

`configureDetectorMonoCamera` | `trainFastRCNNObjectDetector`

Objects

`fastRCNNObjectDetector` | `monoCamera`

Topics

“Getting Started with R-CNN, Fast R-CNN, and Faster R-CNN”

detect

Detect objects using Fast R-CNN object detector configured for monocular camera

Syntax

```
bboxes = detect(detector,I)
[bboxes,scores] = detect(detector,I)
[ ___,labels] = detect(detector,I)
[ ___ ] = detect( ___,roi)
detectionResults = detect(detector,ds)
[ ___ ] = detect( ___,Name,Value)
```

Description

`bboxes = detect(detector,I)` detects objects within image `I` using a Fast R-CNN (regions with convolutional neural networks) object detector configured for a monocular camera. The locations of objects detected are returned as a set of bounding boxes.

When using this function, use of a CUDA-enabled NVIDIA GPU is highly recommended. The GPU reduces computation time significantly. Usage of the GPU requires Parallel Computing Toolbox. For information about the supported compute capabilities, see “GPU Computing Requirements” (Parallel Computing Toolbox).

`[bboxes,scores] = detect(detector,I)` also returns the detection confidence scores for each bounding box.

`[___,labels] = detect(detector,I)` also returns a categorical array of labels assigned to the bounding boxes, using any of the preceding syntaxes. The labels used for object classes are defined during training using the `trainFastRCNNObjectDetector` function.

`[___] = detect(___,roi)` detects objects within the rectangular search region specified by `roi`.

`detectionResults = detect(detector,ds)` detects objects within the series of images returned by the `read` function of the input datastore.

`[___] = detect(___,Name,Value)` specifies options using one or more `Name,Value` pair arguments. For example, `detect(detector,I,'NumStrongestRegions',1000)` limits the number of strongest region proposals to 1000.

Input Arguments

detector — Fast R-CNN object detector configured for monocular camera

`fastRCNNObjectDetectorMonoCamera` object

Fast R-CNN object detector configured for a monocular camera, specified as a `fastRCNNObjectDetectorMonoCamera` object. To create this object, use the `configureDetectorMonoCamera` function with a `monoCamera` object and trained `fastRCNNObjectDetector` object as inputs.

I — Input image*H-by-W-by-C-by-B* numeric array of images

Input image, specified as an *H-by-W-by-C-by-B* numeric array of images. Images must be real, nonsparse, grayscale or RGB image.

- *H* — Height in pixels.
- *W* — Width in pixels
- *C* — The channel size in each image must be equal to the network's input channel size. For example, for grayscale images, *C* must be equal to 1. For RGB color images, it must be equal to 3.
- *B* — Number of images in the array.

The detector is sensitive to the range of the input image. Therefore, ensure that the input image range is similar to the range of the images used to train the detector. For example, if the detector was trained on `uint8` images, rescale this input image to the range [0, 255] by using the `im2uint8` or `rescale` function. The size of this input image should be comparable to the sizes of the images used in training. If these sizes are very different, the detector has difficulty detecting objects because the scale of the objects in the input image differs from the scale of the objects the detector was trained to identify. Consider whether you used the `SmallestImageDimension` property during training to modify the size of training images.

Data Types: `uint8` | `uint16` | `int16` | `double` | `single` | `logical`

ds — Datastore

datastore object

Datastore, specified as a `datastore` object containing a collection of images. Each image must be a grayscale, RGB, or multichannel image. The function processes only the first column of the datastore, which must contain images and must be cell arrays or tables with multiple columns.

roi — Search region of interest*[x y width height]* vector

Search region of interest, specified as a four-element vector of the form *[x y width height]*. The vector specifies the upper left corner and size of a region in pixels.

Name-Value Pair Arguments

Specify optional pairs of arguments as `Name1=Value1, ..., NameN=ValueN`, where `Name` is the argument name and `Value` is the corresponding value. Name-value arguments must appear after other arguments, but the order of the pairs does not matter.

Before R2021a, use commas to separate each name and value, and enclose Name in quotes.

Example: `'NumStrongestRegions', 1000`

NumStrongestRegions — Maximum number of strongest region proposals2000 (default) | positive integer | `Inf`

Maximum number of strongest region proposals, specified as the comma-separated pair consisting of `'NumStrongestRegions'` and a positive integer. Reduce this value to speed up processing time at the cost of detection accuracy. To use all region proposals, specify this value as `Inf`.

SelectStrongest — Select strongest bounding box`true` (default) | `false`

Select the strongest bounding box for each detected object, specified as the comma-separated pair consisting of 'SelectStrongest' and either `true` or `false`.

- `true` — Return the strongest bounding box per object. To select these boxes, `detect` calls the `selectStrongestBboxMulticlass` function, which uses nonmaximal suppression to eliminate overlapping bounding boxes based on their confidence scores.

For example:

```
selectStrongestBboxMulticlass(bbox,scores, ...
    'RatioType','Min', ...
    'OverlapThreshold',0.5);
```

- `false` — Return all detected bounding boxes. You can then create your own custom operation to eliminate overlapping bounding boxes.

MinSize — Minimum region size

[height width] vector

Minimum region size that contains a detected object, specified as the comma-separated pair consisting of 'MinSize' and a *[height width]* vector. Units are in pixels.

By default, `MinSize` is the smallest object that the trained `detector` can detect.

MaxSize — Maximum region size

`size(I)` (default) | *[height width]* vector

Maximum region size that contains a detected object, specified as the comma-separated pair consisting of 'MaxSize' and a *[height width]* vector. Units are in pixels.

To reduce computation time, set this value to the known maximum region size for the objects being detected in the image. By default, 'MaxSize' is set to the height and width of the input image, `I`.

MiniBatchSize — Minimum batch size

128 (default) | scalar

Minimum batch size, specified as the comma-separated pair consisting of 'MiniBatchSize' and a scalar value. Use the `MiniBatchSize` to process a large collection of images. Images are grouped into minibatches and processed as a batch to improve computation efficiency. Increase the minibatch size to decrease processing time. Decrease the size to use less memory.

ExecutionEnvironment — Hardware resource

'auto' (default) | 'gpu' | 'cpu'

Hardware resource on which to run the detector, specified as the comma-separated pair consisting of 'ExecutionEnvironment' and 'auto', 'gpu', or 'cpu'.

- 'auto' — Use a GPU if it is available. Otherwise, use the CPU.
- 'gpu' — Use the GPU. To use a GPU, you must have Parallel Computing Toolbox and a CUDA enabled NVIDIA GPU. If a suitable GPU is not available, the function returns an error. For information about the supported compute capabilities, see “GPU Computing Requirements” (Parallel Computing Toolbox).
- 'cpu' — Use the CPU.

Output Arguments

bboxes — Location of objects detected

M-by-4 matrix | *B*-by-1 cell array

Location of objects detected within the input image or images, returned as an *M*-by-4 matrix or a *B*-by-1 cell array. *M* is the number of bounding boxes in an image, and *B* is the number of *M*-by-4 matrices when the input contains an array of images.

Each row of `bboxes` contains a four-element vector of the form `[x y width height]`. This vector specifies the upper left corner and size of that corresponding bounding box in pixels.

scores — Detection scores

M-by-1 vector | *B*-by-1 cell array

Detection confidence scores, returned as an *M*-by-1 vector or a *B*-by-1 cell array. *M* is the number of bounding boxes in an image, and *B* is the number of *M*-by-1 vectors when the input contains an array of images. A higher score indicates higher confidence in the detection.

labels — Labels for bounding boxes

M-by-1 categorical array | *B*-by-1 cell array

Labels for bounding boxes, returned as an *M*-by-1 categorical array or a *B*-by-1 cell array. *M* is the number of labels in an image, and *B* is the number of *M*-by-1 categorical arrays when the input contains an array of images. You define the class names used to label the objects when you train the input detector.

detectionResults — Detection results

3-column table

Detection results, returned as a 3-column table with variable names, *Boxes*, *Scores*, and *Labels*. The *Boxes* column contains *M*-by-4 matrices, of *M* bounding boxes for the objects found in the image. Each row contains a bounding box as a 4-element vector in the format `[x,y,width,height]`. The format specifies the upper-left corner location and size in pixels of the bounding box in the corresponding image.

Version History

Introduced in R2017a

See Also

Apps

Ground Truth Labeler

Functions

`configureDetectorMonoCamera` | `trainFastRCNNObjectDetector` | `selectStrongestBboxMulticlass`

Objects

`monoCamera` | `fastRCNNObjectDetectorMonoCamera`

classifyRegions

Classify objects in image regions using Fast R-CNN object detector configured for monocular camera

Syntax

```
[labels,scores] = classifyRegions(detector,I,rois)
[labels,scores,allScores] = classifyRegions(detector,I,rois)
[___] = classifyRegions(___,'ExecutionEnvironment',resource)
```

Description

`[labels,scores] = classifyRegions(detector,I,rois)` classifies objects within the regions of interest of image `I`, using a Fast R-CNN (regions with convolutional neural networks) object detector configured for a monocular camera. For each region, `classifyRegions` returns the class label with the corresponding highest classification score.

When using this function, use of a CUDA enabled NVIDIA GPU is highly recommended. The GPU reduces computation time significantly. Usage of the GPU requires Parallel Computing Toolbox. For information about the supported compute capabilities, see “GPU Computing Requirements” (Parallel Computing Toolbox).

`[labels,scores,allScores] = classifyRegions(detector,I,rois)` also returns all the classification scores of each region. The scores are returned in an M -by- N matrix of M regions and N class labels.

`[___] = classifyRegions(___,'ExecutionEnvironment',resource)` specifies the hardware resource used to classify objects within image regions. You can use this name-value pair with any of the preceding syntaxes.

Input Arguments

detector — Fast R-CNN object detector configured for monocular camera

`fastRCNNObjectDetectorMonoCamera` object

Fast R-CNN object detector configured for a monocular camera, specified as a `fastRCNNObjectDetectorMonoCamera` object. To create this object, use the `configureDetectorMonoCamera` function with a `monoCamera` object and trained `fastRCNNObjectDetector` object as inputs.

I — Input image

grayscale image | RGB image

Input image, specified as a real, nonsparse, grayscale or RGB image.

Data Types: `uint8` | `uint16` | `int16` | `double` | `single`

rois — Regions of interest

M -by-4 matrix

Regions of interest within the image, specified as an M -by-4 matrix defining M rectangular regions. Each row contains a four-element vector of the form $[x \ y \ width \ height]$. This vector specifies the upper left corner and size of a region in pixels.

resource — Hardware resource

'auto' (default) | 'gpu' | 'cpu'

Hardware resource used to classify image regions, specified as 'ExecutionEnvironment' and 'auto', 'gpu', or 'cpu'.

- 'auto' — Use a GPU if it is available. Otherwise, use the CPU.
- 'gpu' — Use the GPU. To use a GPU, you must have Parallel Computing Toolbox and a CUDA enabled NVIDIA GPU. If a suitable GPU is not available, the function returns an error. For information about the supported compute capabilities, see “GPU Computing Requirements” (Parallel Computing Toolbox).
- 'cpu' — Use the CPU.

Example: 'ExecutionEnvironment', 'cpu'

Output Arguments

labels — Classification labels of regions

M -by-1 categorical array

Classification labels of regions, returned as an M -by-1 categorical array. M is the number of regions of interest in `rois`. Each class name in `labels` corresponds to a classification score in `scores` and a region of interest in `rois`. `classifyRegions` obtains the class names from the input detector.

scores — Highest classification score per region

M -by-1 vector of values in the range [0, 1]

Highest classification score per region, returned as an M -by-1 vector of values in the range [0, 1]. M is the number of regions of interest in `rois`. Each classification score in `scores` corresponds to a class name in `labels` and a region of interest in `rois`. A higher score indicates higher confidence in the classification.

allScores — All classification scores per region

M -by- N matrix of values in the range [0, 1]

All classification scores per region, returned as an M -by- N matrix of values in the range [0, 1]. M is the number of regions in `rois`. N is the number of class names stored in the input detector. Each row of classification scores in `allScores` corresponds to a region of interest in `rois`. A higher score indicates higher confidence in the classification.

Version History

Introduced in R2017a

See Also

Apps

Ground Truth Labeler

Functions

configureDetectorMonoCamera | trainFastRCNNObjectDetector

Objects

monoCamera | fastRCNNObjectDetectorMonoCamera

fasterRCNNObjectDetectorMonoCamera

Detect objects in monocular camera using Faster R-CNN deep learning detector

Description

The `fasterRCNNObjectDetectorMonoCamera` object contains information about a Faster R-CNN (regions with convolutional neural networks) object detector that is configured for use with a monocular camera sensor. To detect objects in an image that was captured by the camera, pass the detector to the `detect` function.

When using the `detect` function with `fasterRCNNObjectDetectorMonoCamera`, use of a CUDA enabled NVIDIA GPU is highly recommended. The GPU reduces computation time significantly. Usage of the GPU requires Parallel Computing Toolbox. For information about the supported compute capabilities, see “GPU Computing Requirements” (Parallel Computing Toolbox).

Creation

- 1 Create a `fasterRCNNObjectDetector` object by calling the `trainFasterRCNNObjectDetector` function with training data (requires Deep Learning Toolbox).

```
detector = trainFasterRCNNObjectDetector(trainingData,...);
```

Alternatively, create a pretrained detector by using the `vehicleDetectorFasterRCNN` function.

- 2 Create a `monoCamera` object to model the monocular camera sensor.

```
sensor = monoCamera(...);
```

- 3 Create a `fasterRCNNObjectDetectorMonoCamera` object by passing the detector and sensor as inputs to the `configureDetectorMonoCamera` function. The configured detector inherits property values from the original detector.

```
configuredDetector = configureDetectorMonoCamera(detector,sensor,...);
```

Properties

ModelName — Name of classification model

character vector | string scalar

This property is read-only.

Name of the classification model, specified as a character vector or string scalar. By default, the name is set to the heading of the second column of the `trainingData` table specified in the `trainFasterRCNNObjectDetector` function. You can modify this name after creating your `fasterRCNNObjectDetectorMonoCamera` object.

Network — Trained Fast R-CNN object detection network

DAGNetwork object

This property is read-only.

Trained Fast R-CNN object detection network, specified as a `DAGNetwork` object. This object stores the layers that define the convolutional neural network used within the Faster R-CNN detector.

AnchorBoxes — Size of anchor boxes

M-by-2 matrix

This property is read-only.

Size of anchor boxes, specified as an *M*-by-2 matrix, where each row is in the format [*height width*]. This value is set during training.

ClassNames — Object class names

cell array

This property is read-only.

Names of the object classes that the Faster R-CNN detector was trained to find, specified as a cell array. This property is set by the `trainingData` input argument for the `trainFasterRCNNObjectDetector` function. Specify the class names as part of the `trainingData` table.

MinObjectSize — Minimum object size supported

[*height width*] vector

This property is read-only.

Minimum object size supported by the Faster R-CNN network, specified as a [*height width*] vector. The minimum size depends on the network architecture.

Camera — Camera configuration

`monoCamera` object

This property is read-only.

Camera configuration, specified as a `monoCamera` object. The object contains the camera intrinsics, the location, the pitch, yaw, and roll placement, and the world units for the parameters. Use the intrinsics to transform the object points in the image to world coordinates, which you can then compare to the values in the `WorldObjectSize` property.

WorldObjectSize — Range of object widths and lengths

[*minWidth maxWidth*] vector | [*minWidth maxWidth; minLength maxLength*] matrix

This property is read-only.

Range of object widths and lengths in world units, specified as a [*minWidth maxWidth*] vector or [*minWidth maxWidth; minLength maxLength*] matrix. Specifying the range of object lengths is optional.

Object Functions

`detect` Detect objects using Faster R-CNN object detector configured for monocular camera

Examples

Detect Vehicles Using Monocular Camera and Faster R-CNN

Configure a Faster R-CNN object detector for use with a monocular camera mounted on an ego vehicle. Use this detector to detect vehicles within an image captured by the camera.

Load a `fasterRCNNObjectDetector` object pretrained to detect vehicles.

```
detector = vehicleDetectorFasterRCNN;
```

Model a monocular camera sensor by creating a `monoCamera` object. This object contains the camera intrinsics and the location of the camera on the ego vehicle.

```
focalLength = [309.4362 344.2161]; % [fx fy]
principalPoint = [318.9034 257.5352]; % [cx cy]
imageSize = [480 640]; % [mrows ncols]
height = 2.1798; % height of camera above ground, in meters
pitch = 14; % pitch of camera, in degrees
intrinsics = cameraIntrinsics(focalLength,principalPoint,imageSize);
```

```
monCam = monoCamera(intrinsics,height,'Pitch',pitch);
```

Configure the detector for use with the camera. Limit the width of detected objects to a typical range for vehicle widths: 1.5-2.5 meters. The configured detector is a `fasterRCNNObjectDetectorMonoCamera` object.

```
vehicleWidth = [1.5 2.5];
detectorMonoCam = configureDetectorMonoCamera(detector,monCam,vehicleWidth);
```

Read in an image captured by the camera.

```
I = imread('carsinfront.png');
imshow(I)
```



Detect the vehicles in the image by using the detector. Annotate the image with the bounding boxes for the detections and the detection confidence scores.

```
[bboxes,scores] = detect(detectorMonoCam,I);  
I = insertObjectAnnotation(I, 'rectangle',bboxes,scores, 'Color', 'g');  
imshow(I)
```



Version History

Introduced in R2017a

See Also

Apps

Ground Truth Labeler

Functions

`configureDetectorMonoCamera` | `trainFasterRCNNObjectDetector` | `vehicleDetectorFasterRCNN`

Objects

`fasterRCNNObjectDetector` | `monoCamera`

Topics

"Getting Started with R-CNN, Fast R-CNN, and Faster R-CNN"

detect

Detect objects using Faster R-CNN object detector configured for monocular camera

Syntax

```
bboxes = detect(detector,I)
[bboxes,scores] = detect(detector,I)
[ ___,labels] = detect(detector,I)
[ ___ ] = detect( ___,roi)
detectionResults = detect(detector,ds)
[ ___ ] = detect( ___,Name,Value)
```

Description

`bboxes = detect(detector,I)` detects objects within image `I` using a Faster R-CNN (regions with convolutional neural networks) object detector configured for a monocular camera. The locations of objects detected are returned as a set of bounding boxes.

When using this function, use of a CUDA-enabled NVIDIA GPU is highly recommended. The GPU reduces computation time significantly. Usage of the GPU requires Parallel Computing Toolbox. For information about the supported compute capabilities, see “GPU Computing Requirements” (Parallel Computing Toolbox).

`[bboxes,scores] = detect(detector,I)` also returns the detection confidence scores for each bounding box.

`[___,labels] = detect(detector,I)` also returns a categorical array of labels assigned to the bounding boxes, using any of the preceding syntaxes. The labels used for object classes are defined during training using the `trainFasterRCNNObjectDetector` function.

`[___] = detect(___,roi)` detects objects within the rectangular search region specified by `roi`.

`detectionResults = detect(detector,ds)` detects objects within the series of images returned by the `read` function of the input datastore.

`[___] = detect(___,Name,Value)` specifies options using one or more `Name,Value` pair arguments. For example, `detect(detector,I,'NumStrongestRegions',1000)` limits the number of strongest region proposals to 1000.

Examples

Detect Vehicles Using Monocular Camera and Faster R-CNN

Configure a Faster R-CNN object detector for use with a monocular camera mounted on an ego vehicle. Use this detector to detect vehicles within an image captured by the camera.

Load a `fasterRCNNObjectDetector` object pretrained to detect vehicles.

```
detector = vehicleDetectorFasterRCNN;
```

Model a monocular camera sensor by creating a `monoCamera` object. This object contains the camera intrinsics and the location of the camera on the ego vehicle.

```
focalLength = [309.4362 344.2161]; % [fx fy]
principalPoint = [318.9034 257.5352]; % [cx cy]
imageSize = [480 640]; % [mrows ncols]
height = 2.1798; % height of camera above ground, in meters
pitch = 14; % pitch of camera, in degrees
intrinsics = cameraIntrinsics(focalLength,principalPoint,imageSize);
```

```
monCam = monoCamera(intrinsics,height,'Pitch',pitch);
```

Configure the detector for use with the camera. Limit the width of detected objects to a typical range for vehicle widths: 1.5-2.5 meters. The configured detector is a `fasterRCNNObjectDetectorMonoCamera` object.

```
vehicleWidth = [1.5 2.5];
detectorMonoCam = configureDetectorMonoCamera(detector,monCam,vehicleWidth);
```

Read in an image captured by the camera.

```
I = imread('carsinfront.png');
imshow(I)
```



Detect the vehicles in the image by using the detector. Annotate the image with the bounding boxes for the detections and the detection confidence scores.

```
[bboxes,scores] = detect(detectorMonoCam,I);  
I = insertObjectAnnotation(I, 'rectangle',bboxes,scores, 'Color', 'g');  
imshow(I)
```



Input Arguments

detector — **Faster R-CNN object detector configured for monocular camera**

`fasterRCNNObjectDetectorMonoCamera` object

Faster R-CNN object detector configured for a monocular camera, specified as a `fasterRCNNObjectDetectorMonoCamera` object. To create this object, use the `configureDetectorMonoCamera` function with a `monoCamera` object and trained `fasterRCNNObjectDetector` object as inputs.

I — **Input image**

H-by-W-by-C-by-B numeric array of images

Input image, specified as an *H-by-W-by-C-by-B* numeric array of images. Images must be real, nonsparse, grayscale or RGB image.

- *H* — Height in pixels.
- *W* — Width in pixels
- *C* — The channel size in each image must be equal to the network's input channel size. For example, for grayscale images, *C* must be equal to 1. For RGB color images, it must be equal to 3.

- *B* — Number of images in the array.

The detector is sensitive to the range of the input image. Therefore, ensure that the input image range is similar to the range of the images used to train the detector. For example, if the detector was trained on `uint8` images, rescale this input image to the range `[0, 255]` by using the `im2uint8` or `rescale` function. The size of this input image should be comparable to the sizes of the images used in training. If these sizes are very different, the detector has difficulty detecting objects because the scale of the objects in the input image differs from the scale of the objects the detector was trained to identify. Consider whether you used the `SmallestImageDimension` property during training to modify the size of training images.

Data Types: `uint8` | `uint16` | `int16` | `double` | `single` | `logical`

ds — Datastore

`datastore` object

Datastore, specified as a `datastore` object containing a collection of images. Each image must be a grayscale, RGB, or multichannel image. The function processes only the first column of the datastore, which must contain images and must be cell arrays or tables with multiple columns.

roi — Search region of interest

`[x y width height]` vector

Search region of interest, specified as a four-element vector of the form `[x y width height]`. The vector specifies the upper left corner and size of a region in pixels.

Name-Value Pair Arguments

Specify optional pairs of arguments as `Name1=Value1, ..., NameN=ValueN`, where `Name` is the argument name and `Value` is the corresponding value. Name-value arguments must appear after other arguments, but the order of the pairs does not matter.

Before R2021a, use commas to separate each name and value, and enclose Name in quotes.

Example: `'NumStrongestRegions',1000`

NumStrongestRegions — Maximum number of strongest region proposals

2000 (default) | positive integer | `Inf`

Maximum number of strongest region proposals, specified as the comma-separated pair consisting of `'NumStrongestRegions'` and a positive integer. Reduce this value to speed up processing time at the cost of detection accuracy. To use all region proposals, specify this value as `Inf`.

SelectStrongest — Select strongest bounding box

`true` (default) | `false`

Select the strongest bounding box for each detected object, specified as the comma-separated pair consisting of `'SelectStrongest'` and either `true` or `false`.

- `true` — Return the strongest bounding box per object. To select these boxes, `detect` calls the `selectStrongestBboxMulticlass` function, which uses nonmaximal suppression to eliminate overlapping bounding boxes based on their confidence scores.

For example:

```
selectStrongestBboxMulticlass(bbox,scores, ...
    'RatioType','Min', ...
    'OverlapThreshold',0.5);
```

- `false` — Return all detected bounding boxes. You can then create your own custom operation to eliminate overlapping bounding boxes.

MinSize — Minimum region size

[height width] vector

Minimum region size that contains a detected object, specified as the comma-separated pair consisting of 'MinSize' and a *[height width]* vector. Units are in pixels.

By default, MinSize is the smallest object that the trained `detector` can detect.

MaxSize — Maximum region size

`size(I)` (default) | *[height width]* vector

Maximum region size that contains a detected object, specified as the comma-separated pair consisting of 'MaxSize' and a *[height width]* vector. Units are in pixels.

To reduce computation time, set this value to the known maximum region size for the objects being detected in the image. By default, 'MaxSize' is set to the height and width of the input image, `I`.

MiniBatchSize — Minimum batch size

128 (default) | scalar

Minimum batch size, specified as the comma-separated pair consisting of 'MiniBatchSize' and a scalar value. Use the `MiniBatchSize` to process a large collection of images. Images are grouped into minibatches and processed as a batch to improve computation efficiency. Increase the minibatch size to decrease processing time. Decrease the size to use less memory.

ExecutionEnvironment — Hardware resource

'auto' (default) | 'gpu' | 'cpu'

Hardware resource on which to run the detector, specified as the comma-separated pair consisting of 'ExecutionEnvironment' and 'auto', 'gpu', or 'cpu'.

- 'auto' — Use a GPU if it is available. Otherwise, use the CPU.
- 'gpu' — Use the GPU. To use a GPU, you must have Parallel Computing Toolbox and a CUDA enabled NVIDIA GPU. If a suitable GPU is not available, the function returns an error. For information about the supported compute capabilities, see “GPU Computing Requirements” (Parallel Computing Toolbox).
- 'cpu' — Use the CPU.

Output Arguments

bboxes — Location of objects detected

M-by-4 matrix | *B*-by-1 cell array

Location of objects detected within the input image or images, returned as an *M*-by-4 matrix or a *B*-by-1 cell array. *M* is the number of bounding boxes in an image, and *B* is the number of *M*-by-4 matrices when the input contains an array of images.

Each row of `bboxes` contains a four-element vector of the form `[x y width height]`. This vector specifies the upper left corner and size of that corresponding bounding box in pixels.

scores — Detection scores

M-by-1 vector | *B*-by-1 cell array

Detection confidence scores, returned as an *M*-by-1 vector or a *B*-by-1 cell array. *M* is the number of bounding boxes in an image, and *B* is the number of *M*-by-1 vectors when the input contains an array of images. A higher score indicates higher confidence in the detection.

labels — Labels for bounding boxes

M-by-1 categorical array | *B*-by-1 cell array

Labels for bounding boxes, returned as an *M*-by-1 categorical array or a *B*-by-1 cell array. *M* is the number of labels in an image, and *B* is the number of *M*-by-1 categorical arrays when the input contains an array of images. You define the class names used to label the objects when you train the input detector.

detectionResults — Detection results

3-column table

Detection results, returned as a 3-column table with variable names, *Boxes*, *Scores*, and *Labels*. The *Boxes* column contains *M*-by-4 matrices, of *M* bounding boxes for the objects found in the image. Each row contains a bounding box as a 4-element vector in the format `[x,y,width,height]`. The format specifies the upper-left corner location and size in pixels of the bounding box in the corresponding image.

Version History

Introduced in R2017a

See Also

Apps

Ground Truth Labeler

Functions

`configureDetectorMonoCamera` | `trainFasterRCNNObjectDetector` | `selectStrongestBboxMulticlass`

Objects

`monoCamera` | `fasterRCNNObjectDetectorMonoCamera`

yolov2ObjectDetectorMonoCamera

Detect objects in monocular camera using YOLO v2 deep learning detector

Description

The `yolov2ObjectDetectorMonoCamera` object contains information about you only look once version 2 (YOLO v2) object detector that is configured for use with a monocular camera sensor. To detect objects in an image captured by the camera, pass the detector to the `detect` object function.

When using the `detect` object function with a `yolov2ObjectDetectorMonoCamera` object, use of a CUDA-enabled NVIDIA GPU is highly recommended. The GPU reduces computation time significantly. Usage of the GPU requires Parallel Computing Toolbox. For information about the supported compute capabilities, see “GPU Computing Requirements” (Parallel Computing Toolbox).

Creation

- 1 Create a `yolov2ObjectDetector` object by calling the `trainYOLOv2ObjectDetector` function with training data (requires Deep Learning Toolbox).

```
detector = trainYOLOv2ObjectDetector(trainingData, ____);
```

- 2 Create a `monoCamera` object to model the monocular camera sensor.

```
sensor = monoCamera(____);
```

- 3 Create a `yolov2ObjectDetectorMonoCamera` object by passing the detector and sensor as inputs to the `configureDetectorMonoCamera` function. The configured detector inherits property values from the original detector.

```
configuredDetector = configureDetectorMonoCamera(detector, sensor, ____);
```

Properties

Camera — Camera configuration

`monoCamera` object

This property is read-only.

Camera configuration, specified as a `monoCamera` object. The object contains the camera intrinsics, the location, the pitch, yaw, and roll placement, and the world units for the parameters. Use the intrinsics to transform the object points in the image to world coordinates, which you can then compare to the values in the `WorldObjectSize` property.

WorldObjectSize — Range of object widths and lengths

[minWidth maxWidth] vector | *[minWidth maxWidth; minLength maxLength]* matrix

This property is read-only.

Range of object widths and lengths in world units, specified as a *[minWidth maxWidth]* vector or *[minWidth maxWidth; minLength maxLength]* matrix. Specifying the range of object lengths is optional.

ModelName — Name of classification model

character vector | string scalar

Name of the classification model, specified as a character vector or string scalar. By default, the name is set to the heading of the second column of the `trainingData` table specified in the `trainYOLOv2ObjectDetector` function. You can modify this name after creating the `yolov2ObjectDetectorMonoCamera` object.

Network — Trained YOLO v2 object detection network

DAGNetwork object

This property is read-only.

Trained YOLO v2 object detection network, specified as a DAGNetwork object. This object stores the layers that are used within the YOLO v2 object detector.

ClassNames — Names of object classes

cell array of character vectors

This property is read-only.

Names of the object classes that the YOLO v2 object detector was trained to find, specified as a cell array of character vectors. This property is set by the `trainingData` input argument for the `trainYOLOv2ObjectDetector` function. Specify the class names as part of the `trainingData` table.

AnchorBoxes — Size of anchor boxes*M*-by-2 matrix

This property is read-only.

Size of anchor boxes, specified as an *M*-by-2 matrix, where each row is of form [*height width*]. This value specifies the height and width of *M* anchor boxes. This property is set by the `AnchorBoxes` property of the output layer in the YOLO v2 network.

The anchor boxes are defined when creating the YOLO v2 network by using the `yolov2Layers` function. Alternatively, if you create the YOLO v2 network layer-by-layer, the anchor boxes are defined by using the `yolov2OutputLayer` function.

Object Functions

`detect` Detect objects using YOLO v2 object detector configured for monocular camera

Examples**Detect Vehicles Using Monocular Camera and YOLO v2**

Configure a YOLO v2 object detector for use with a monocular camera mounted on an ego vehicle. Use this detector to detect vehicles within an image captured by the camera.

Load a `yolov2ObjectDetector` object pretrained to detect vehicles.

```
detector = vehicleDetectorYOLOv2;
```

Model a monocular camera sensor by creating a `monoCamera` object. This object contains the camera intrinsics and the location of the camera on the ego vehicle.

```
focalLength = [309.4362 344.2161]; % [fx fy]
principalPoint = [318.9034 257.5352]; % [cx cy]
imageSize = [480 640]; % [mrows ncols]
height = 2.1798; % height of camera above ground, in meters
pitch = 14; % pitch of camera, in degrees
intrinsics = cameraIntrinsics(focalLength,principalPoint,imageSize);

sensor = monoCamera(intrinsics,height,'Pitch',pitch);
```

Configure the detector for use with the camera. Limit the width of detected objects to 2-3 meters. The configured detector is a `yolov2ObjectDetectorMonoCamera` object.

```
vehicleWidth = [2 3];
detectorMonoCam = configureDetectorMonoCamera(detector,sensor,vehicleWidth);
```

Read in an image captured by the camera.

```
I = imread('carsinfront.png');
```

Detect the vehicles in the image by using the detector. Annotate the image with the bounding boxes for the detections and the detection confidence scores.

```
[bboxes,scores,labels] = detect(detectorMonoCam,I);
I = insertObjectAnnotation(I,'rectangle',bboxes,scores,'Color','g');
imshow(I)
```



Display the labels for detected bounding boxes. The labels specify the class names of the detected objects.

```
disp(labels)
    vehicle
    vehicle
    vehicle
    vehicle
```

Version History

Introduced in R2019a

See Also

Apps

Ground Truth Labeler

Functions

configureDetectorMonoCamera | trainYOLOv2objectDetector

Objects

yoLov2ObjectDetector | monoCamera

Topics

“Getting Started with YOLO v2”

“Object Detection Using YOLO v2 Deep Learning”

detect

Detect objects using YOLO v2 object detector configured for monocular camera

Syntax

```
bboxes = detect(detector,I)
[bboxes,scores] = detect(detector,I)
[ ___,labels] = detect(detector,I)
[ ___ ] = detect( ___,roi)
detectionResults = detect(detector,ds)
[ ___ ] = detect( ___,Name,Value)
```

Description

`bboxes = detect(detector,I)` detects objects within image `I` using you only look once version 2 (YOLO v2) object detector configured for a monocular camera. The locations of objects detected are returned as a set of bounding boxes.

When using this function, use of a CUDA-enabled NVIDIA GPU is highly recommended. The GPU reduces computation time significantly. Usage of the GPU requires Parallel Computing Toolbox. For information about the supported compute capabilities, see “GPU Computing Requirements” (Parallel Computing Toolbox).

`[bboxes,scores] = detect(detector,I)` also returns the detection confidence scores for each bounding box.

`[___,labels] = detect(detector,I)` returns a categorical array of labels assigned to the bounding boxes in addition to the output arguments from the previous syntax. The labels used for object classes are defined during training using the `trainYOLOv2ObjectDetector` function.

`[___] = detect(___,roi)` detects objects within the rectangular search region specified by `roi`. Use output arguments from any of the previous syntaxes. Specify input arguments from any of the previous syntaxes.

`detectionResults = detect(detector,ds)` detects objects within the series of images returned by the `read` function of the input datastore.

`[___] = detect(___,Name,Value)` also specifies options using one or more `Name,Value` pair arguments in addition to the input arguments in any of the preceding syntaxes.

Examples

Detect Vehicles in Traffic Scenes from Monocular Video Using YOLO v2

Configure a YOLO v2 object detector for detecting vehicles within a video captured by a monocular camera.

Load a `yolov2ObjectDetector` object pretrained to detect vehicles.

```
vehicleDetector = load('yolov2VehicleDetector.mat','detector');
detector = vehicleDetector.detector;
```

Model a monocular camera sensor by creating a `monoCamera` object. This object contains the camera intrinsics and the location of the camera on the ego vehicle.

```
focalLength = [309.4362 344.2161]; % [fx fy]
principalPoint = [318.9034 257.5352]; % [cx cy]
imageSize = [480 640]; % [mrows ncols]
height = 2.1798; % Height of camera above ground, in meters
pitch = 14; % Pitch of camera, in degrees
intrinsics = cameraIntrinsics(focalLength,principalPoint,imageSize);
```

```
sensor = monoCamera(intrinsics,height,'Pitch',pitch);
```

Configure the detector for use with the camera. Limit the width of detected objects to 1.5-2.5 meters. The configured detector is a `yolov2ObjectDetectorMonoCamera` object.

```
vehicleWidth = [1.5 2.5];
detectorMonoCam = configureDetectorMonoCamera(detector,sensor,vehicleWidth);
```

Set up the video reader and read the input monocular video.

```
videoFile = '05_highway_lanechange_25s.mp4';
reader = VideoReader(videoFile);
```

Create a video player to display the video and the output detections.

```
videoPlayer = vision.DeployableVideoPlayer();
```

Detect vehicles in the video by using the detector. Specify the detection threshold as 0.6. Annotate the video with the bounding boxes for the detections, labels, and detection confidence scores.

```
cont = hasFrame(reader);
while cont
    I = readFrame(reader);
    [bboxes,scores,labels] = detect(detectorMonoCam,I,'Threshold',0.6); % Run the YOLO v2 object
    if ~isempty(bboxes)
        displayLabel = strcat(cellstr(labels),':',num2str(scores));
        I = insertObjectAnnotation(I,'rectangle',bboxes,displayLabel);
    end
    step(videoPlayer, I);
    cont = hasFrame(reader) && isOpen(videoPlayer); % Exit the loop if the video player figure w
end
```

Input Arguments

detector — YOLO v2 object detector configured for monocular camera

`yolov2ObjectDetectorMonoCamera` object

YOLO v2 object detector configured for monocular camera, specified as a `yolov2ObjectDetectorMonoCamera` object. To create this object, use the `configureDetectorMonoCamera` function with a `monoCamera` object and trained `yolov2ObjectDetector` object as inputs.

I — Input image*H-by-W-by-C-by-B* numeric array of images

Input image, specified as an *H-by-W-by-C-by-B* numeric array of images. Images must be real, nonsparse, grayscale or RGB image.

- *H* — Height in pixels.
- *W* — Width in pixels
- *C* — The channel size in each image must be equal to the network's input channel size. For example, for grayscale images, *C* must be equal to 1. For RGB color images, it must be equal to 3.
- *B* — Number of images in the array.

The detector is sensitive to the range of the input image. Therefore, ensure that the input image range is similar to the range of the images used to train the detector. For example, if the detector was trained on `uint8` images, rescale this input image to the range [0, 255] by using the `im2uint8` or `rescale` function. The size of this input image should be comparable to the sizes of the images used in training. If these sizes are very different, the detector has difficulty detecting objects because the scale of the objects in the input image differs from the scale of the objects the detector was trained to identify. Consider whether you used the `SmallestImageDimension` property during training to modify the size of training images.

Data Types: `uint8` | `uint16` | `int16` | `double` | `single` | `logical`

ds — Datastore

datastore object

Datastore, specified as a `datastore` object containing a collection of images. Each image must be a grayscale, RGB, or multichannel image. The function processes only the first column of the datastore, which must contain images and must be cell arrays or tables with multiple columns.

roi — Search region of interest*[x y width height]* vector

Search region of interest, specified as a four-element vector of the form *[x y width height]*. The vector specifies the upper left corner and size of a region in pixels.

Name-Value Pair Arguments

Specify optional pairs of arguments as `Name1=Value1, ..., NameN=ValueN`, where `Name` is the argument name and `Value` is the corresponding value. Name-value arguments must appear after other arguments, but the order of the pairs does not matter.

Before R2021a, use commas to separate each name and value, and enclose Name in quotes.

Example: `detect(detector,I,'Threshold',0.25)`

Threshold — Detection threshold

0.5 (default) | scalar in the range [0, 1]

Detection threshold, specified as a comma-separated pair consisting of `'Threshold'` and a scalar in the range [0, 1]. Detections that have scores less than this threshold value are removed. To reduce false positives, increase this value.

SelectStrongest — Select strongest bounding box`true` (default) | `false`

Select the strongest bounding box for each detected object, specified as the comma-separated pair consisting of 'SelectStrongest' and true or false.

- `true` — Returns the strongest bounding box per object. The method calls the `selectStrongestBboxMulticlass` function, which uses nonmaximal suppression to eliminate overlapping bounding boxes based on their confidence scores.

By default, the `selectStrongestBboxMulticlass` function is called as follows

```
selectStrongestBboxMulticlass(bbox,scores,...
                             'RatioType','Min',...
                             'OverlapThreshold',0.5);
```

- `false` — Return all the detected bounding boxes. You can then write your own custom method to eliminate overlapping bounding boxes.

MinSize — Minimum region size

[1 1] (default) | vector of the form [*height width*]

Minimum region size, specified as the comma-separated pair consisting of 'MinSize' and a vector of the form [*height width*]. Units are in pixels. The minimum region size defines the size of the smallest region containing the object.

By default, 'MinSize' is 1-by-1.

MaxSize — Maximum region size

size(I) (default) | vector of the form [*height width*]

Maximum region size, specified as the comma-separated pair consisting of 'MaxSize' and a vector of the form [*height width*]. Units are in pixels. The maximum region size defines the size of the largest region containing the object.

By default, 'MaxSize' is set to the height and width of the input image, I. To reduce computation time, set this value to the known maximum region size for the objects that can be detected in the input test image.

ExecutionEnvironment — Hardware resource

'auto' (default) | 'gpu' | 'cpu'

Hardware resource on which to run the detector, specified as the comma-separated pair consisting of 'ExecutionEnvironment' and 'auto', 'gpu', or 'cpu'.

- 'auto' — Use a GPU if it is available. Otherwise, use the CPU.
- 'gpu' — Use the GPU. To use a GPU, you must have Parallel Computing Toolbox and a CUDA-enabled NVIDIA GPU. If a suitable GPU is not available, the function returns an error. For information about the supported compute capabilities, see “GPU Computing Requirements” (Parallel Computing Toolbox).
- 'cpu' — Use the CPU.

Acceleration — Performance optimization

'auto' (default) | 'mex' | 'none'

Performance optimization, specified as the comma-separated pair consisting of 'Acceleration' and one of the following:

- 'auto' — Automatically apply a number of optimizations suitable for the input network and hardware resource.
- 'mex' — Compile and execute a MEX function. This option is available when using a GPU only. Using a GPU requires Parallel Computing Toolbox and a CUDA enabled NVIDIA GPU. If Parallel Computing Toolbox or a suitable GPU is not available, then the function returns an error. For information about the supported compute capabilities, see “GPU Computing Requirements” (Parallel Computing Toolbox).
- 'none' — Disable all acceleration.

The default option is 'auto'. If 'auto' is specified, MATLAB will apply a number of compatible optimizations. If you use the 'auto' option, MATLAB does not ever generate a MEX function.

Using the 'Acceleration' options 'auto' and 'mex' can offer performance benefits, but at the expense of an increased initial run time. Subsequent calls with compatible parameters are faster. Use performance optimization when you plan to call the function multiple times using new input data.

The 'mex' option generates and executes a MEX function based on the network and parameters used in the function call. You can have several MEX functions associated with a single network at one time. Clearing the network variable also clears any MEX functions associated with that network.

The 'mex' option is only available for input data specified as a numeric array, cell array of numeric arrays, table, or image datastore. No other types of datastore support the 'mex' option.

The 'mex' option is only available when you are using a GPU. You must also have a C/C++ compiler installed. For setup instructions, see “MEX Setup” (GPU Coder).

'mex' acceleration does not support all layers. For a list of supported layers, see “Supported Layers” (GPU Coder).

Output Arguments

bboxes — Location of objects detected

M-by-4 matrix | *B*-by-1 cell array

Location of objects detected within the input image or images, returned as an *M*-by-4 matrix or a *B*-by-1 cell array. *M* is the number of bounding boxes in an image, and *B* is the number of *M*-by-4 matrices when the input contains an array of images.

Each row of **bboxes** contains a four-element vector of the form [*x* *y* *width* *height*]. This vector specifies the upper left corner and size of that corresponding bounding box in pixels.

scores — Detection scores

M-by-1 vector | *B*-by-1 cell array

Detection confidence scores, returned as an *M*-by-1 vector or a *B*-by-1 cell array. *M* is the number of bounding boxes in an image, and *B* is the number of *M*-by-1 vectors when the input contains an array of images. A higher score indicates higher confidence in the detection.

labels — Labels for bounding boxes

M-by-1 categorical array | *B*-by-1 cell array

Labels for bounding boxes, returned as an *M*-by-1 categorical array or a *B*-by-1 cell array. *M* is the number of labels in an image, and *B* is the number of *M*-by-1 categorical arrays when the input

contains an array of images. You define the class names used to label the objects when you train the input detector.

detectionResults — **Detection results**

3-column table

Detection results, returned as a 3-column table with variable names, *Boxes*, *Scores*, and *Labels*. The *Boxes* column contains *M*-by-4 matrices, of *M* bounding boxes for the objects found in the image. Each row contains a bounding box as a 4-element vector in the format [*x*,*y*,*width*,*height*]. The format specifies the upper-left corner location and size in pixels of the bounding box in the corresponding image.

Version History

Introduced in R2019a

See Also

Apps

Ground Truth Labeler

Functions

configureDetectorMonoCamera | trainYOLOv2ObjectDetector |
selectStrongestBboxMulticlass | evaluateDetectionMissRate |
evaluateDetectionPrecision

Objects

monoCamera | yolov2ObjectDetectorMonoCamera

yolov3ObjectDetectorMonoCamera

Detect objects in monocular camera using YOLO v3 deep learning detector

Description

The `yolov3ObjectDetectorMonoCamera` object contains information about a you only look once version 3 (YOLO v3) object detector that is configured for use with a monocular camera sensor. To detect objects in an image captured by the camera, pass the detector to the `detect` object function.

When you use the `detect` object function with a `yolov3ObjectDetectorMonoCamera` object, use of a CUDA-enabled NVIDIA GPU is highly recommended. The GPU reduces computation time significantly. Usage of the GPU requires Parallel Computing Toolbox. For information about the supported compute capabilities, see “GPU Computing Requirements” (Parallel Computing Toolbox).

Creation

- 1 Create a `yolov3ObjectDetector` object by using YOLO v3 deep learning networks trained on a COCO data set (requires Deep Learning Toolbox and Computer Vision Toolbox™ Model for YOLO v3 Object Detection).

```
detector = yolov3ObjectDetector("darknet53-coco");
```

Alternatively, you can create a `yolov3ObjectDetector` object by using a custom pretrained YOLO v3 network. For more information, see `yolov3ObjectDetector`.

- 2 Create a `monoCamera` object to model the monocular camera sensor.

```
sensor = monoCamera(____);
```

- 3 Create a `yolov3ObjectDetectorMonoCamera` object by passing the detector and sensor as inputs to the `configureDetectorMonoCamera` function. The configured detector inherits property values from the original detector.

```
configuredDetector = configureDetectorMonoCamera(detector,sensor,____);
```

Properties

Camera — Camera configuration

`monoCamera` object

This property is read-only.

Camera configuration, specified as a `monoCamera` object. The object contains the camera intrinsics, the location, the pitch, yaw, and roll placement, and the world units for the parameters. Use the intrinsics to transform the object points in the image to world coordinates, which you can then compare to the values in the `WorldObjectSize` property.

WorldObjectSize — Range of object widths and lengths

`[minWidth maxWidth]` vector | `[minWidth maxWidth; minLength maxLength]` matrix

This property is read-only.

Range of object widths and lengths in world units, specified as a [*minWidth* *maxWidth*] vector or [*minWidth* *maxWidth*; *minLength* *maxLength*] matrix. Specifying the range of object lengths is optional.

ModelName — Name for object detector

character vector | string scalar

Name for the object detector, stored as a character vector or string scalar. By default, the name is set to the `ModelName` property value of `yoloV3ObjectDetector` object specified at the input. You can modify this name after creating the `yoloV3ObjectDetectorMonoCamera` object.

Data Types: `char` | `string`

Network — Trained YOLO v3 object detection network

`dlnetwork` object

This property is read-only.

Trained YOLO v3 object detection network, stored as a `dlnetwork` object. This object stores the layers that are used within the YOLO v3 object detector.

ClassNames — Names of object classes

categorical vector

This property is read-only.

Names of the object classes that the YOLO v3 object detector was trained to find, stored as a categorical vector. This property is set by the `classes` input argument of `yoloV3ObjectDetector` object.

Data Types: `categorical`

AnchorBoxes — Size of anchor boxes

N -by-1 cell array

This property is read-only.

Size of anchor boxes, stored as an N -by-1 cell array. N is the number of output layers in the YOLO v3 deep learning network. Each cell contains an M -by-2 matrix, where M is the number of anchor boxes in that layer. Each row in the M -by-2 matrix denotes the size of an anchor box in the form [*height* *width*]. This property is set by the `aboxes` input argument of the `yoloV3ObjectDetector` object.

Data Types: `cell`

InputSize — Image sizes used for training

vector

This property is read-only.

Image size used for training, stored as a vector of form [*height* *width*] or [*height* *width* *channels*].

Data Types: `double`

Object Functions

`detect` Detect objects using YOLO v3 object detector configured for monocular camera

Examples

Detect Objects Using Monocular Camera and YOLO v3

Configure a YOLO v3 object detector for use with a monocular camera mounted on an ego vehicle. Use this detector to detect vehicles and stop signs within an image captured by the camera.

Load a `yolov3ObjectDetector` object pretrained on the COCO data set.

```
detector = yolov3ObjectDetector;
```

Model a monocular camera sensor by creating a `monoCamera` object. This object contains the camera intrinsics and the location of the camera on the ego vehicle.

```
focalLength = [309.4362 344.2161]; % [fx fy]
principalPoint = [318.9034 257.5352]; % [cx cy]
imageSize = [480 640]; % [mrows ncols]
height = 2.1798; % height of camera above ground, in meters
pitch = 14; % pitch of camera, in degrees
intrinsics = cameraIntrinsics(focalLength,principalPoint,imageSize);
```

```
sensor = monoCamera(intrinsics,height,Pitch=pitch);
```

Configure the detector for use with the camera. Limit the width of detected objects to 1.5-2.5 meters. The configured detector is a `yolov3ObjectDetectorMonoCamera` object.

```
vehicleWidth = [1.5 2.5];
detectorMonoCam = configureDetectorMonoCamera(detector,sensor,vehicleWidth);
```

Read an image captured by the camera.

```
I = imread("object-detection-test.png");
```

Detect the vehicles and stop signs in the image by using the detector. Annotate the image with the bounding boxes for the detections and the class labels.

```
[bboxes,scores,labels] = detect(detectorMonoCam,I);
I = insertObjectAnnotation(I,"rectangle",bboxes,labels,Color="green");
imshow(I)
```



Version History

Introduced in R2023a

See Also

Apps

Ground Truth Labeler

Functions

configureDetectorMonoCamera

Objects

yolov3objectDetector | monoCamera

Topics

“Getting Started with YOLO v3”

“Object Detection Using YOLO v3 Deep Learning”

detect

Detect objects using YOLO v3 object detector configured for monocular camera

Syntax

```
bboxes = detect(detector,I)
[bboxes,scores] = detect(detector,I)
[ ___,labels] = detect(detector,I)
[ ___ ] = detect( ___,roi)
detectionResults = detect(detector,ds)
[ ___ ] = detect( ___,Name=Value)
```

Description

`bboxes = detect(detector,I)` detects objects within image `I` using a you only look once version 3 (YOLO v3) object detector configured for a monocular camera. The function returns the locations of detected objects as a set of bounding boxes.

Using this function with CUDA-enabled NVIDIA GPU is highly recommended. A GPU reduces computation time significantly. Using a GPU requires Parallel Computing Toolbox. For information about the supported compute capabilities, see “GPU Computing Requirements” (Parallel Computing Toolbox).

`[bboxes,scores] = detect(detector,I)` also returns the detection confidence scores for each bounding box.

`[___,labels] = detect(detector,I)` returns a categorical array of labels assigned to the bounding boxes in addition to the output arguments from the previous syntax. The labels used for object classes are defined during creation of the detector.

`[___] = detect(___,roi)` detects objects within the rectangular search region specified by `roi` using input and output arguments from any of the previous syntaxes.

`detectionResults = detect(detector,ds)` detects objects within the series of images returned by the `read` function of the input datastore.

`[___] = detect(___,Name=Value)` also specifies options using one or more name-value arguments.

Examples

Detect Objects Using Monocular Camera and YOLO v3

Configure a YOLO v3 object detector for use with a monocular camera mounted on an ego vehicle. Use this detector to detect vehicles and stop signs within an image captured by the camera.

Load a `yolov3objectDetector` object pretrained on the COCO data set.

```
detector = yolov3objectDetector;
```

Model a monocular camera sensor by creating a `monoCamera` object. This object contains the camera intrinsics and the location of the camera on the ego vehicle.

```
focalLength = [309.4362 344.2161]; % [fx fy]
principalPoint = [318.9034 257.5352]; % [cx cy]
imageSize = [480 640]; % [mrows ncols]
height = 2.1798; % height of camera above ground, in meters
pitch = 14; % pitch of camera, in degrees
intrinsics = cameraIntrinsics(focalLength,principalPoint,imageSize);

sensor = monoCamera(intrinsics,height,Pitch=pitch);
```

Configure the detector for use with the camera. Limit the width of detected objects to 1.5-2.5 meters. The configured detector is a `yolov3objectDetectorMonoCamera` object.

```
vehicleWidth = [1.5 2.5];
detectorMonoCam = configureDetectorMonoCamera(detector,sensor,vehicleWidth);
```

Read an image captured by the camera.

```
I = imread("object-detection-test.png");
```

Detect the vehicles and stop signs in the image by using the detector. Annotate the image with the bounding boxes for the detections and the class labels.

```
[bboxes,scores,labels] = detect(detectorMonoCam,I);
I = insertObjectAnnotation(I,"rectangle",bboxes,labels,Color="green");
imshow(I)
```



Input Arguments

detector — YOLO v3 object detector configured for monocular camera

`yolov3objectDetectorMonoCamera` object

YOLO v3 object detector configured for a monocular camera, specified as a `yolov3objectDetectorMonoCamera` object. To create this object, use the `configureDetectorMonoCamera` function with a `monoCamera` object and `yolov3objectDetector` object as inputs.

I — Input image

H-by-W-by-C-by-B numeric array of images

Input image, specified as an *H-by-W-by-C-by-B* numeric array of images. Images must be real, nonsparse, grayscale or RGB images.

- *H* — Height in pixels.
- *W* — Width in pixels.
- *C* — The channel size in each image must be equal to the network input channel size. For example, for grayscale images, *C* must be equal to 1. For RGB color images, it must be equal to 3.

- *B* — Number of images in the array.

The detector is sensitive to the range of the input image. Therefore, ensure that the input image range is similar to the range of the images used to train the detector. For example, if the detector was trained on `uint8` images, rescale this input image to the range `[0, 255]` by using the `im2uint8` or `rescale` function. The size of this input image must be comparable to the sizes of the images used in training. If these sizes are very different, the detector has difficulty detecting objects because the scale of the objects in the input image differs from the scale of the objects the detector was trained to identify.

Data Types: `uint8` | `uint16` | `int16` | `double` | `single` | `logical`

ds — Datastore

`datastore` object

Datastore, specified as a `datastore` object containing a collection of images. Each image must be a grayscale, RGB, or multichannel image. The function processes only the first column of the datastore, which must contain images and must be cell arrays or tables with multiple columns.

roi — Search region of interest

`[x y width height]` vector

Search region of interest, specified as a four-element vector of the form `[x y width height]`. The vector specifies the upper left corner and size of a region in pixels.

Name-Value Pair Arguments

Specify optional pairs of arguments as `Name1=Value1, ..., NameN=ValueN`, where `Name` is the argument name and `Value` is the corresponding value. Name-value arguments must appear after other arguments, but the order of the pairs does not matter.

Example: `detect(detector,I,Threshold=0.25)`

Threshold — Detection threshold

`0.5` (default) | scalar in the range `[0, 1]`

Detection threshold, specified as a scalar in the range `[0, 1]`. The function removes detections that have scores less than this threshold value. To reduce false positives, increase this value.

SelectStrongest — Option to select strongest bounding box

`true` (default) | `false`

Option to select the strongest bounding box for each detected object, specified as `true` or `false`.

- `true` — Return the strongest bounding box per object using the `selectStrongestBboxMulticlass` function, which uses nonmaximal suppression to eliminate overlapping bounding boxes based on their confidence scores.

By default, the `selectStrongestBboxMulticlass` function is called as follows:

```
selectStrongestBboxMulticlass(bbox,scores, ...
                             RatioType="Union", ...
                             OverlapThreshold=0.5);
```

- `false` — Return all the detected bounding boxes. You can then write your own custom method to eliminate overlapping bounding boxes.

MinSize — Minimum region size`[1 1]` (default) | two-element vector

Minimum region size, specified as a vector of the form `[height width]`. Units are in pixels. The minimum region size defines the size of the smallest region containing the object.

MaxSize — Maximum region size`size(I)` (default) | two-element vector

Maximum region size, specified as a vector of the form `[height width]`. Units are in pixels. The maximum region size defines the size of the largest region containing the object.

By default, `MaxSize` is set to the height and width of the input image, `I`. To reduce computation time, set this value to the known maximum region size for the objects that can be detected in the input test image.

MiniBatchSize — Minimum batch size

128 (default) | scalar

Minimum batch size, specified as a scalar. Specify the `MiniBatchSize` argument to process a large collection of images. Images are grouped into mini-batches and processed as a batch to improve computation efficiency. Use a large mini-batch size to decrease processing time. Use a small mini-batch size to use less memory.

ExecutionEnvironment — Hardware resource`"auto"` (default) | `"gpu"` | `"cpu"`

Hardware resource on which to run the detector, specified as one of these values:

- `"auto"` — Use a GPU if one is available. Otherwise, use the CPU.
- `"gpu"` — Use the GPU. To use a GPU, you must have Parallel Computing Toolbox and a CUDA-enabled NVIDIA GPU. If a suitable GPU is not available, the function returns an error. For information about the supported compute capabilities, see “GPU Computing Requirements” (Parallel Computing Toolbox).
- `"cpu"` — Use the CPU.

Acceleration — Performance optimization`"auto"` (default) | `"mex"` | `"none"`

Performance optimization, specified as one of these values:

- `"auto"` — Automatically apply a number of optimizations suitable for the input network and hardware resource.
- `"mex"` — Compile and execute a MEX function. This option is available when you use a GPU only. Using a GPU requires Parallel Computing Toolbox and a CUDA enabled NVIDIA GPU. If Parallel Computing Toolbox or a suitable GPU is not available, then the function returns an error. For information about the supported compute capabilities, see “GPU Computing Requirements” (Parallel Computing Toolbox).
- `"none"` — Disable all acceleration.

The default option is `"auto"`. If `"auto"` is specified, MATLAB applies a number of compatible optimizations. If you use the `"auto"` option, MATLAB does not ever generate a MEX function.

Using the "auto" and "mex" options can offer performance benefits, but at the expense of an increased initial run time. Subsequent calls with compatible parameters are faster. Use performance optimization when you plan to call the function multiple times using new input data.

The "mex" option generates and executes a MEX function based on the network and parameters used in the function call. You can have several MEX functions associated with a single network at one time. Clearing the network variable also clears any MEX functions associated with that network.

The "mex" option is available only for input data specified as a numeric array, cell array of numeric arrays, table, or image datastore. No other types of datastore support the "mex" option.

The "mex" option is only available when you are using a GPU. You must also have a C/C++ compiler installed. For setup instructions, see "MEX Setup" (GPU Coder).

The "mex" acceleration does not support all layers. For a list of supported layers, see "Supported Layers" (GPU Coder).

Output Arguments

bboxes — Locations of detected objects

M-by-4 matrix

Locations of detected objects within the input image or images, returned as an *M*-by-4 matrix. *M* is the number of bounding boxes in an image.

Each row of **bboxes** contains a four-element vector of the form [*x* *y* *width* *height*]. This vector specifies the upper left corner and size of that corresponding bounding box in pixels.

scores — Detection scores

M-by-1 vector

Detection confidence scores, returned as an *M*-by-1 vector. *M* is the number of bounding boxes in an image. The detection score values lie between 0 and 1. A higher score indicates greater confidence in the detection.

labels — Labels for bounding boxes

M-by-1 categorical array

Labels for bounding boxes, returned as an *M*-by-1 categorical array. *M* is the number of labels in an image. You define the class names used to label the objects when you train the input detector.

detectionResults — Detection results

3-column table

Detection results, returned as a 3-column table with the variable names *Boxes*, *Scores*, and *Labels*. The *Boxes* column contains *M*-by-4 matrices of *M* bounding boxes for the objects found in the image. Each row contains a bounding box as a 4-element vector in the format [*x*,*y*,*width*,*height*]. The format specifies the upper left corner location and size in pixels of the bounding box in the corresponding image.

Version History

Introduced in R2023a

See Also

Apps

[Ground Truth Labeler](#)

Functions

[configureDetectorMonoCamera](#) | [selectStrongestBboxMulticlass](#) | [evaluateDetectionMissRate](#) | [evaluateDetectionPrecision](#)

Objects

[monoCamera](#) | [yolov3ObjectDetectorMonoCamera](#)

yolov4ObjectDetectorMonoCamera

Detect objects in monocular camera using YOLO v4 deep learning detector

Description

The `yolov4ObjectDetectorMonoCamera` object contains information about you only look once version 4 (YOLO v4) object detector that is configured for use with a monocular camera sensor. To detect objects in an image captured by the camera, pass the detector to the `detect` object function.

When using the `detect` object function with a `yolov4ObjectDetectorMonoCamera` object, use of a CUDA-enabled NVIDIA GPU is highly recommended. The GPU reduces computation time significantly. Usage of the GPU requires Parallel Computing Toolbox. For information about the supported compute capabilities, see “GPU Computing Requirements” (Parallel Computing Toolbox).

Creation

- 1 Create a `yolov4ObjectDetector` object by calling the `trainYOLOv4ObjectDetector` function with training data (requires Deep Learning Toolbox).

```
detector = trainYOLOv4ObjectDetector(trainingData, ____);
```

- 2 Create a `monoCamera` object to model the monocular camera sensor.

```
sensor = monoCamera(____);
```

- 3 Create a `yolov4ObjectDetectorMonoCamera` object by passing the detector and sensor as inputs to the `configureDetectorMonoCamera` function. The configured detector inherits property values from the original detector.

```
configuredDetector = configureDetectorMonoCamera(detector, sensor, ____);
```

Properties

Camera — Camera configuration

`monoCamera` object

This property is read-only.

Camera configuration, specified as a `monoCamera` object. The object contains the camera intrinsics, the location, the pitch, yaw, and roll placement, and the world units for the parameters. Use the intrinsics to transform the object points in the image to world coordinates, which you can then compare to the values in the `WorldObjectSize` property.

WorldObjectSize — Range of object widths and lengths

[minWidth maxWidth] vector | *[minWidth maxWidth; minLength maxLength]* matrix

This property is read-only.

Range of object widths and lengths in world units, specified as a *[minWidth maxWidth]* vector or *[minWidth maxWidth; minLength maxLength]* matrix. Specifying the range of object lengths is optional.

ModelName — Name of classification model

character vector | string scalar

Name of the classification model, specified as a character vector or string scalar. By default, the name is set to the `ModelName` property value of `yolov4ObjectDetector` object specified at the input. You can modify this name after creating the `yolov4ObjectDetectorMonoCamera` object.

Network — Trained YOLO v4 object detection network

dlnetwork object

This property is read-only.

Trained YOLO v4 object detection network, specified as a `dlnetwork` object. This object stores the layers that are used within the YOLO v4 object detector.

ClassNames — Names of object classes

cell array of character vectors

This property is read-only.

Names of the object classes that the YOLO v4 object detector was trained to find, specified as a cell array of character vectors. This property is set by the `ClassNames` property value of `yolov4ObjectDetector` object specified at the input.

AnchorBoxes — Size of anchor boxes*N*-by-1 cell array

This property is read-only.

Size of anchor boxes, specified as an *N*-by-1 cell array. *N* is the number of output layers in the YOLO v4 deep learning network. Each cell contains an *M*-by-2 matrix, where *M* is the number of anchor boxes in that layer. Each row in the *M*-by-2 matrix denotes the size of an anchor box in the form [*height width*]. This property is set by the `AnchorBoxes` property value of `yolov4ObjectDetector` object specified at the input.

The anchor boxes are defined when creating the YOLO v4 network by using the `yolov4ObjectDetector`

Object Functions

`detect` Detect objects using YOLO v4 object detector configured for monocular camera

Examples**Detect Vehicles in Traffic Scenes from Monocular Video Using YOLO v4**

Configure a YOLO v4 object detector for use with a monocular camera mounted on an ego vehicle. Use this detector to detect vehicles within a video captured by the camera.

Load a `yolov4ObjectDetector` object pretrained to detect vehicles.

```
detector = yolov4ObjectDetector("csp-darknet53-coco");
```

Model a monocular camera sensor by creating a `monoCamera` object. This object contains the camera intrinsics and the location of the camera on the ego vehicle.

```
focalLength = [309.4362 344.2161]; % [fx fy]
principalPoint = [318.9034 257.5352]; % [cx cy]
imageSize = [480 640]; % [mrows ncols]
height = 2.1798; % height of camera above ground, in meters
pitch = 14; % pitch of camera, in degrees
intrinsics = cameraIntrinsics(focalLength,principalPoint,imageSize);

sensor = monoCamera(intrinsics,height,Pitch=pitch);
```

Configure the detector for use with the camera. Limit the width of detected objects to 1.5-2.5 meters. The configured detector is a `yolov4objectDetectorMonoCamera` object.

```
vehicleWidth = [1.5 2.5];
detectorMonoCam = configureDetectorMonoCamera(detector,sensor,vehicleWidth);
```

Set up the video reader and read the input monocular video.

```
videoFile = '05_highway_lanechange_25s.mp4';
reader = VideoReader(videoFile);
```

Create a video player to display the detection results. Detect the vehicles in each frame by using the configured detector. Annotate the video frames with the bounding boxes for the detections and the detection confidence scores.

```
videoPlayer = vision.VideoPlayer();
while hasFrame(reader)
    frame = readFrame(reader);
    % Run the detector
    [bboxes,scores,labels] = detect(detectorMonoCam,frame,Threshold=0.6);
    if ~isempty(bboxes)
        frame = insertObjectAnnotation(frame,"Rectangle",bboxes,labels,Color="green");
    end
    step(videoPlayer,frame);
end
```

Close the video player.

```
release(videoPlayer);
```

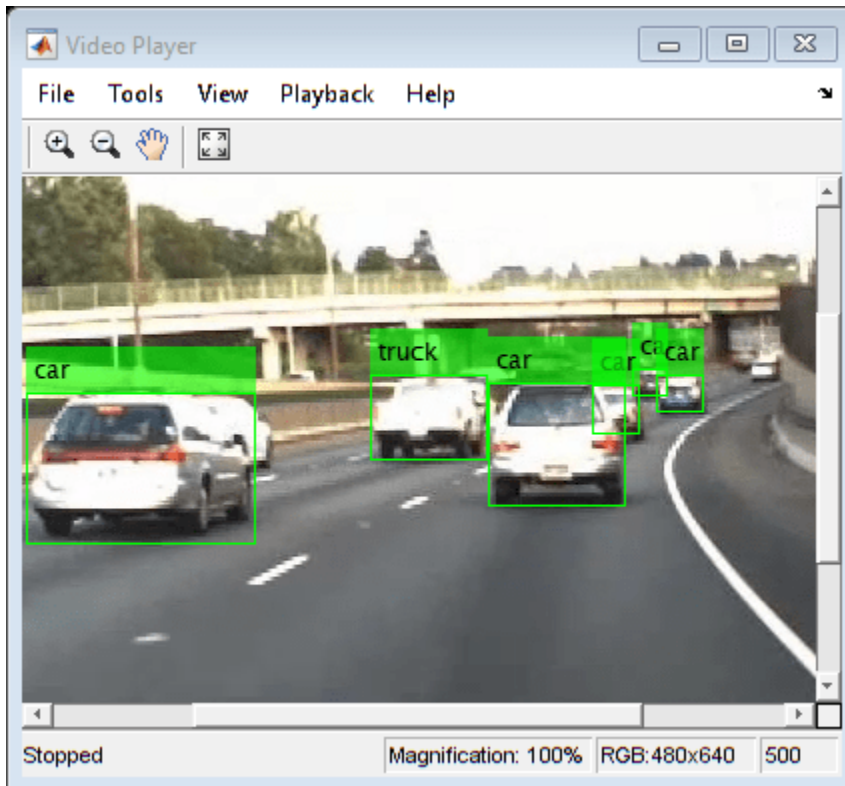
Version History

Introduced in R2022a

See Also

Apps

Ground Truth Labeler

Functions

`configureDetectorMonoCamera` | `trainYOLOv4objectDetector`

Objects

`monoCamera` | `yolov4objectDetector`

detect

Detect objects using YOLO v4 object detector configured for monocular camera

Syntax

```
bboxes = detect(detector,I)
[bboxes,scores] = detect(detector,I)
[ ___, labels] = detect(detector,I)
[ ___ ] = detect( ___, roi)
detectionResults = detect(detector,ds)
[ ___ ] = detect( ___, Name, Value)
```

Description

`bboxes = detect(detector,I)` detects objects within image `I` using you only look once version 4 (YOLO v4) object detector configured for a monocular camera. The locations of objects detected are returned as a set of bounding boxes.

When using this function, use of a CUDA-enabled NVIDIA GPU is highly recommended. The GPU reduces computation time significantly. Usage of the GPU requires Parallel Computing Toolbox. For information about the supported compute capabilities, see “GPU Computing Requirements” (Parallel Computing Toolbox).

`[bboxes,scores] = detect(detector,I)` also returns the detection confidence scores for each bounding box.

`[___, labels] = detect(detector,I)` returns a categorical array of labels assigned to the bounding boxes in addition to the output arguments from the previous syntax. The labels used for object classes are defined during training using the `trainYOLOv4objectDetector` function.

`[___] = detect(___, roi)` detects objects within the rectangular search region specified by `roi`. Use output arguments from any of the previous syntaxes. Specify input arguments from any of the previous syntaxes.

`detectionResults = detect(detector,ds)` detects objects within the series of images returned by the `read` function of the input datastore.

`[___] = detect(___, Name, Value)` also specifies options using one or more `Name, Value` pair arguments in addition to the input arguments in any of the preceding syntaxes.

Examples

Detect Cars Using Monocular Camera and YOLO v4

Load a pretrained `yolov4objectDetector` object.

```
detector = yolov4objectDetector("csp-darknet53-coco");
```

Model a monocular camera sensor by creating a `monoCamera` object. This object contains the camera intrinsics and the location of the camera on the ego vehicle.

```
focalLength = [309.4362 344.2161]; % [fx fy]
principalPoint = [318.9034 257.5352]; % [cx cy]
imageSize = [480 640]; % [mrows ncols]
height = 2.1798; % height of camera above ground, in meters
pitch = 14; % pitch of camera, in degrees
intrinsics = cameraIntrinsics(focalLength,principalPoint,imageSize);
```

```
sensor = monoCamera(intrinsics,height,Pitch=pitch);
```

Configure the detector for use with the camera. Limit the width of detected objects to 1.5-2.5 meters. The configured detector is a `yolov4objectDetectorMonoCamera` object.

```
vehicleWidth = [1.5 2.5];
detectorMonoCam = configureDetectorMonoCamera(detector,sensor,vehicleWidth);
```

Read in an image captured by the camera.

```
I = imread("carsinfront.png");
```

Detect the cars in the image by using the detector. Annotate the image with the bounding boxes for the detections and the detection confidence scores.

```
[bboxes,scores,labels] = detect(detectorMonoCam,I);
I = insertObjectAnnotation(I,"Rectangle",bboxes,scores,Color="yellow");
imshow(I)
```



Display the labels for detected bounding boxes. The labels specify the class names of the detected objects.

```
disp(labels)
```

```
car  
car  
car  
car  
car
```

Input Arguments

detector — YOLO v4 object detector configured for monocular camera

`yolov4objectDetectorMonoCamera` object

YOLO v4 object detector configured for monocular camera, specified as a `yolov4objectDetectorMonoCamera` object. To create this object, use the `configureDetectorMonoCamera` function with a `monoCamera` object and trained `yolov4objectDetector` object as inputs.

I — Input image*H-by-W-by-C-by-B* numeric array of images

Input image, specified as an *H-by-W-by-C-by-B* numeric array of images. Images must be real, nonsparse, grayscale or RGB image.

- *H* — Height in pixels.
- *W* — Width in pixels
- *C* — The channel size in each image must be equal to the network's input channel size. For example, for grayscale images, *C* must be equal to 1. For RGB color images, it must be equal to 3.
- *B* — Number of images in the array.

The detector is sensitive to the range of the input image. Therefore, ensure that the input image range is similar to the range of the images used to train the detector. For example, if the detector was trained on `uint8` images, rescale this input image to the range [0, 255] by using the `im2uint8` or `rescale` function. The size of this input image should be comparable to the sizes of the images used in training. If these sizes are very different, the detector has difficulty detecting objects because the scale of the objects in the input image differs from the scale of the objects the detector was trained to identify. Consider whether you used the `SmallestImageDimension` property during training to modify the size of training images.

Data Types: `uint8` | `uint16` | `int16` | `double` | `single` | `logical`

ds — Datastore

datastore object

Datastore, specified as a `datastore` object containing a collection of images. Each image must be a grayscale, RGB, or multichannel image. The function processes only the first column of the datastore, which must contain images and must be cell arrays or tables with multiple columns.

roi — Search region of interest*[x y width height]* vector

Search region of interest, specified as a four-element vector of the form *[x y width height]*. The vector specifies the upper left corner and size of a region in pixels.

Name-Value Pair Arguments

Specify optional pairs of arguments as `Name1=Value1, ..., NameN=ValueN`, where `Name` is the argument name and `Value` is the corresponding value. Name-value arguments must appear after other arguments, but the order of the pairs does not matter.

Before R2021a, use commas to separate each name and value, and enclose Name in quotes.

Example: `detect(detector,I,'Threshold',0.25)`

Threshold — Detection threshold

0.5 (default) | scalar in the range [0, 1]

Detection threshold, specified as a comma-separated pair consisting of `'Threshold'` and a scalar in the range [0, 1]. Detections that have scores less than this threshold value are removed. To reduce false positives, increase this value.

SelectStrongest — Select strongest bounding box`true` (default) | `false`

Select the strongest bounding box for each detected object, specified as the comma-separated pair consisting of 'SelectStrongest' and true or false.

- `true` — Returns the strongest bounding box per object. The method calls the `selectStrongestBboxMulticlass` function, which uses nonmaximal suppression to eliminate overlapping bounding boxes based on their confidence scores.

By default, the `selectStrongestBboxMulticlass` function is called as follows

```
selectStrongestBboxMulticlass(bbox, scores, ...
                             'RatioType', 'Min', ...
                             'OverlapThreshold', 0.5);
```

- `false` — Return all the detected bounding boxes. You can then write your own custom method to eliminate overlapping bounding boxes.

MinSize — Minimum region size

[1 1] (default) | vector of the form [*height width*]

Minimum region size, specified as the comma-separated pair consisting of 'MinSize' and a vector of the form [*height width*]. Units are in pixels. The minimum region size defines the size of the smallest region containing the object.

By default, 'MinSize' is 1-by-1.

MaxSize — Maximum region size

size(I) (default) | vector of the form [*height width*]

Maximum region size, specified as the comma-separated pair consisting of 'MaxSize' and a vector of the form [*height width*]. Units are in pixels. The maximum region size defines the size of the largest region containing the object.

By default, 'MaxSize' is set to the height and width of the input image, I. To reduce computation time, set this value to the known maximum region size for the objects that can be detected in the input test image.

MiniBatchSize — Minimum batch size

128 (default) | scalar

Minimum batch size, specified as a scalar value. Use the `MiniBatchSize` to process a large collection of image. Images are grouped into minibatches and processed as a batch to improve computation efficiency. Increase the minibatch size to decrease processing time. Decrease the size to use less memory.

ExecutionEnvironment — Hardware resource

'auto' (default) | 'gpu' | 'cpu'

Hardware resource on which to run the detector, specified as the comma-separated pair consisting of 'ExecutionEnvironment' and 'auto', 'gpu', or 'cpu'.

- 'auto' — Use a GPU if it is available. Otherwise, use the CPU.
- 'gpu' — Use the GPU. To use a GPU, you must have Parallel Computing Toolbox and a CUDA-enabled NVIDIA GPU. If a suitable GPU is not available, the function returns an error. For information about the supported compute capabilities, see “GPU Computing Requirements” (Parallel Computing Toolbox).

- 'cpu' — Use the CPU.

Acceleration — Performance optimization

'auto' (default) | 'mex' | 'none'

Performance optimization, specified as the comma-separated pair consisting of 'Acceleration' and one of the following:

- 'auto' — Automatically apply a number of optimizations suitable for the input network and hardware resource.
- 'mex' — Compile and execute a MEX function. This option is available when using a GPU only. Using a GPU requires Parallel Computing Toolbox and a CUDA enabled NVIDIA GPU. If Parallel Computing Toolbox or a suitable GPU is not available, then the function returns an error. For information about the supported compute capabilities, see “GPU Computing Requirements” (Parallel Computing Toolbox).
- 'none' — Disable all acceleration.

The default option is 'auto'. If 'auto' is specified, MATLAB will apply a number of compatible optimizations. If you use the 'auto' option, MATLAB does not ever generate a MEX function.

Using the 'Acceleration' options 'auto' and 'mex' can offer performance benefits, but at the expense of an increased initial run time. Subsequent calls with compatible parameters are faster. Use performance optimization when you plan to call the function multiple times using new input data.

The 'mex' option generates and executes a MEX function based on the network and parameters used in the function call. You can have several MEX functions associated with a single network at one time. Clearing the network variable also clears any MEX functions associated with that network.

The 'mex' option is only available for input data specified as a numeric array, cell array of numeric arrays, table, or image datastore. No other types of datastore support the 'mex' option.

The 'mex' option is only available when you are using a GPU. You must also have a C/C++ compiler installed. For setup instructions, see “MEX Setup” (GPU Coder).

'mex' acceleration does not support all layers. For a list of supported layers, see “Supported Layers” (GPU Coder).

Output Arguments

bboxes — Location of objects detected

M-by-4 matrix

Location of objects detected within the input image or images, returned as an *M*-by-4 matrix. *M* is the number of bounding boxes in an image.

Each row of **bboxes** contains a four-element vector of the form [*x* *y* *width* *height*]. This vector specifies the upper left corner and size of that corresponding bounding box in pixels.

scores — Detection scores

M-by-1 vector

Detection confidence scores, returned as an *M*-by-1 vector. *M* is the number of bounding boxes in an image. The value of detection score lies between 0 and 1. A higher score indicates higher confidence in the detection.

Labels — Labels for bounding boxes

M-by-1 categorical array

Labels for bounding boxes, returned as an *M*-by-1 categorical array. *M* is the number of labels in an image. You define the class names used to label the objects when you train the input detector.

detectionResults — Detection results

3-column table

Detection results, returned as a 3-column table with variable names, *Boxes*, *Scores*, and *Labels*. The *Boxes* column contains *M*-by-4 matrices, of *M* bounding boxes for the objects found in the image. Each row contains a bounding box as a 4-element vector in the format `[x,y,width,height]`. The format specifies the upper-left corner location and size in pixels of the bounding box in the corresponding image.

Version History

Introduced in R2022a

See Also**Apps**

Ground Truth Labeler

Functions

`configureDetectorMonoCamera` | `selectStrongestBboxMulticlass` |
`evaluateDetectionMissRate` | `evaluateDetectionPrecision`

Objects

`monoCamera`

ssdObjectDetectorMonoCamera

Detect objects in monocular camera using SSD deep learning detector

Description

The `ssdObjectDetectorMonoCamera` detects objects from an image, using a single shot detector (SSD) object detector. To detect objects in an image, pass the trained detector to the `detect` function.

Creation

- 1 Create a `ssdObjectDetector` object by calling the `trainSSDObjectDetector` function with training data (requires Deep Learning Toolbox).

```
detector = trainSSDObjectDetector(trainingData, ____);
```
- 2 Create a `monoCamera` object to model the monocular camera sensor.

```
sensor = monoCamera(____);
```
- 3 Create a `ssdObjectDetectorMonoCamera` object by passing the detector and sensor as inputs to the `configureDetectorMonoCamera` function. The configured detector inherits property values from the original detector.

```
configuredDetector = configureDetectorMonoCamera(detector, sensor, ____);
```

Properties

Camera — Camera configuration

`monoCamera` object

This property is read-only.

Camera configuration, specified as a `monoCamera` object. The object contains the camera intrinsics, the location, the pitch, yaw, and roll placement, and the world units for the parameters. Use the intrinsics to transform the object points in the image to world coordinates, which you can then compare to the values in the `WorldObjectSize` property.

WorldObjectSize — Range of object widths and lengths

`[minWidth maxWidth]` vector | `[minWidth maxWidth; minLength maxLength]` matrix

This property is read-only.

Range of object widths and lengths in world units, specified as a `[minWidth maxWidth]` vector or `[minWidth maxWidth; minLength maxLength]` matrix. Specifying the range of object lengths is optional.

ModelName — Name of classification model

character vector | string scalar

Name of the classification model, specified as a character vector or string scalar. You can modify this name after creating the `ssdObjectDetectorMonoCamera` object.

Network — Trained SSD object detection network

DAGNetwork object

This property is read-only.

Trained SSD object detection network, specified as a DAGNetwork object. This object stores the layers that are used within the SSD object detector.

AnchorBoxes — Size of anchor boxes

P -by-1 cell array

This property is read-only.

Size of anchor boxes, specified as a P -by-1 cell array for P number of feature extraction layers used for object detection in the SSD network. Each element of the array contains an M -by-2 matrix of anchor box sizes, in the format [*height width*]. Each cell can contain a different number of anchor boxes. This value is set during training.

ClassNames — Names of object classes

cell array of character vectors

This property is read-only.

Names of the object classes that the SSD object detector was trained to find, specified as a cell array of character vectors. This property is set by the `trainingData` input argument for the `trainSSDObjectDetector` function. Specify the class names as part of the `trainingData` table.

Object Functions

`detect` Detect objects using SSD object detector configured for monocular camera

Examples

Detect Vehicles Using Monocular Camera and SSD

Configure an SSD object detector for use with a monocular camera mounted on an ego vehicle. Use this detector to detect vehicles within an image captured by the camera.

Load an `ssdObjectDetector` object pretrained to detect vehicles.

```
vehicleDetector = load('ssdVehicleDetector.mat','detector');  
detector = vehicleDetector.detector;
```

Model a monocular camera sensor by creating a `monoCamera` object. This object contains the camera intrinsics and the location of the camera on the ego vehicle.

```
focalLength = [309.4362 344.2161]; % [fx fy]  
principalPoint = [318.9034 257.5352]; % [cx cy]  
imageSize = [480 640]; % [mrows ncols]  
height = 2.1798; % height of camera above ground, in meters  
pitch = 14; % pitch of camera, in degrees
```

```
intrinsics = cameraIntrinsics(focalLength,principalPoint,imageSize);
```

```
sensor = monoCamera(intrinsics,height,'Pitch',pitch);
```

Configure the detector for use with the camera. Limit the width of detected objects to 1.5 - 2.5 meters. The configured detector is an `ssdObjectDetectorMonoCamera` object.

```
vehicleWidth = [1.5 2.5];
```

```
detectorMonoCam = configureDetectorMonoCamera(detector,sensor,vehicleWidth);
```

Read an image captured by the camera.

```
I = imread('highwayCars.png');
```

Detect the vehicles in the image by using the detector. Annotate the image with the bounding boxes for the detections and the detection confidence scores.

```
[bboxes,scores,labels] = detect(detectorMonoCam,I,'Threshold',0.6);  
I = insertObjectAnnotation(I,'rectangle',bboxes,scores,'Color','g');  
imshow(I)
```



Display the labels for detected bounding boxes. The labels specify the class names of the detected objects.

```
disp(labels)
```

```
    vehicle  
    vehicle
```

Version History

Introduced in R2020a

See Also

Apps

Ground Truth Labeler

Functions

configureDetectorMonoCamera | **trainSSDObjectDetector**

Objects

ssdObjectDetector | **monoCamera**

Topics

“Getting Started with SSD Multibox Detection”

“Create SSD Object Detection Network”

“Object Detection Using SSD Deep Learning”

detect

Detect objects using SSD object detector configured for monocular camera

Syntax

```
bboxes = detect(detector,I)
[bboxes,scores] = detect(detector,I)
[ ___,labels] = detect(detector,I)
[ ___ ] = detect( ___,roi)

detectionResults = detect(detector,ds)

[ ___ ] = detect( ___,Name,Value)
```

Description

`bboxes = detect(detector,I)` detects objects within image `I` using an SSD (single shot detection convolutional neural networks) multibox object detector configured for a monocular camera. The locations of objects detected are returned as a set of bounding boxes.

When using this function, use of a CUDA-enabled NVIDIA GPU. The GPU reduces computation time significantly. Usage of the GPU requires Parallel Computing Toolbox. For information about the supported compute capabilities, see “GPU Computing Requirements” (Parallel Computing Toolbox).

`[bboxes,scores] = detect(detector,I)` also returns the detection confidence scores for each bounding box.

`[___,labels] = detect(detector,I)` also returns a categorical array of labels assigned to the bounding boxes, using either of the preceding syntaxes. The labels used for object classes are defined during training using the `trainSSDObjectDetector` function.

`[___] = detect(___,roi)` detects objects within the rectangular search region specified by `roi`. Use output arguments from any of the previous syntaxes. Specify input arguments from any of the previous syntaxes.

`detectionResults = detect(detector,ds)` detects objects within the series of images returned by the `read` function of the input datastore.

`[___] = detect(___,Name,Value)` specifies options using one or more `Name,Value` pair arguments. For example, `detect(detector,I,'Threshold',0.75)` sets the detection score threshold to 0.75. Any detections with a lower score are removed.

Examples

Detect Vehicles Using Monocular Camera and SSD

Configure an SSD object detector for use with a monocular camera mounted on an ego vehicle. Use this detector to detect vehicles within an image captured by the camera.

Load an `ssdObjectDetector` object pretrained to detect vehicles.

```
vehicleDetector = load('ssdVehicleDetector.mat','detector');  
detector = vehicleDetector.detector;
```

Model a monocular camera sensor by creating a `monoCamera` object. This object contains the camera intrinsics and the location of the camera on the ego vehicle.

```
focalLength = [309.4362 344.2161]; % [fx fy]  
principalPoint = [318.9034 257.5352]; % [cx cy]  
imageSize = [480 640]; % [mrows ncols]  
height = 2.1798; % height of camera above ground, in meters  
pitch = 14; % pitch of camera, in degrees  
intrinsics = cameraIntrinsics(focalLength,principalPoint,imageSize);  
  
sensor = monoCamera(intrinsics,height,'Pitch',pitch);
```

Configure the detector for use with the camera. Limit the width of detected objects to 1.5 - 2.5 meters. The configured detector is an `ssdObjectDetectorMonoCamera` object.

```
vehicleWidth = [1.5 2.5];  
detectorMonoCam = configureDetectorMonoCamera(detector,sensor,vehicleWidth);
```

Read an image captured by the camera.

```
I = imread('highwayCars.png');
```

Detect the vehicles in the image by using the detector. Annotate the image with the bounding boxes for the detections and the detection confidence scores.

```
[bboxes,scores,labels] = detect(detectorMonoCam,I,'Threshold',0.6);  
I = insertObjectAnnotation(I,'rectangle',bboxes,scores,'Color','g');  
imshow(I)
```



Display the labels for detected bounding boxes. The labels specify the class names of the detected objects.

```
disp(labels)
    vehicle
    vehicle
```

Input Arguments

detector — SSD multibox object detector

SSDObjectDetector object

SSD multibox object detector, specified as an `ssdObjectDetector` object. To create this object, call the `trainSSDObjectDetector` function with training data as input.

I — Input image

H-by-*W*-by-*C*-by-*B* numeric array of images

Input image, specified as an *H*-by-*W*-by-*C*-by-*B* numeric array of images. Images must be real, nonsparse, grayscale or RGB image.

- H — Height in pixels.
- W — Width in pixels
- C — The channel size in each image must be equal to the network's input channel size. For example, for grayscale images, C must be equal to 1. For RGB color images, it must be equal to 3.
- B — Number of images in the array.

The detector is sensitive to the range of the input image. Therefore, ensure that the input image range is similar to the range of the images used to train the detector. For example, if the detector was trained on `uint8` images, rescale this input image to the range `[0, 255]` by using the `im2uint8` or `rescale` function. The size of this input image should be comparable to the sizes of the images used in training. If these sizes are very different, the detector has difficulty detecting objects because the scale of the objects in the input image differs from the scale of the objects the detector was trained to identify. Consider whether you used the `SmallestImageDimension` property during training to modify the size of training images.

Data Types: `uint8` | `uint16` | `int16` | `double` | `single` | `logical`

ds — Datastore

`datastore` object

Datastore, specified as a `datastore` object containing a collection of images. Each image must be a grayscale, RGB, or multichannel image. The function processes only the first column of the datastore, which must contain images and must be cell arrays or tables with multiple columns.

roi — Search region of interest

`[x y width height]` vector

Search region of interest, specified as a four-element vector of the form `[x y width height]`. The vector specifies the upper left corner and size of a region in pixels.

Name-Value Pair Arguments

Specify optional pairs of arguments as `Name1=Value1, ..., NameN=ValueN`, where `Name` is the argument name and `Value` is the corresponding value. Name-value arguments must appear after other arguments, but the order of the pairs does not matter.

Before R2021a, use commas to separate each name and value, and enclose `Name` in quotes.

Example: `'SelectStrongest', true`

Threshold — Detection threshold

`0.5` (default) | scalar

Detection threshold, specified as a scalar in the range `[0, 1]`. Detections that have scores less than this threshold value are removed. To reduce false positives, increase this value.

SelectStrongest — Select strongest bounding box

`true` (default) | `false`

Select the strongest bounding box for each detected object, specified as the comma-separated pair consisting of `'SelectStrongest'` and either `true` or `false`.

- `true` — Return the strongest bounding box per object. To select these boxes, `detect` calls the `selectStrongestBboxMulticlass` function, which uses nonmaximal suppression to eliminate overlapping bounding boxes based on their confidence scores.

For example:

```
selectStrongestBboxMulticlass(bbox,scores, ...
    'RatioType','Min', ...
    'OverlapThreshold',0.5);
```

- `false` — Return all detected bounding boxes. You can then create your own custom operation to eliminate overlapping bounding boxes.

MinSize — Minimum region size

`[1 1]` (default) | [*height width*] vector

Minimum region size that contains a detected object, specified as the comma-separated pair consisting of `'MinSize'`, and [*height width*] vector. Units are in pixels.

To reduce computation time, set this value to the known minimum region size for the objects being detected in the image. By default, `'MinSize'` is set to `[1 1]`.

MaxSize — Maximum region size

`size(I)` (default) | [*height width*] vector

Maximum region size that contains a detected object, specified as the comma-separated pair consisting of `'MaxSize'` and a [*height width*] vector. Units are in pixels.

To reduce computation time, set this value to the known maximum region size for the objects being detected in the image. By default, `'MaxSize'` is set to the height and width of the input image, `I`.

MiniBatchSize — Minimum batch size

`128` (default) | scalar

Minimum batch size, specified as the comma-separated pair consisting of `'MiniBatchSize'` and a scalar value. Use the `MiniBatchSize` to process a large collection of images. Images are grouped into minibatches and processed as a batch to improve computation efficiency. Increase the minibatch size to decrease processing time. Decrease the size to use less memory.

ExecutionEnvironment — Hardware resource

`'auto'` (default) | `'gpu'` | `'cpu'`

Hardware resource on which to run the detector, specified as the comma-separated pair consisting of `'ExecutionEnvironment'` and `'auto'`, `'gpu'`, or `'cpu'`.

- `'auto'` — Use a GPU if it is available. Otherwise, use the CPU.
- `'gpu'` — Use the GPU. To use a GPU, you must have Parallel Computing Toolbox and a CUDA enabled NVIDIA GPU. If a suitable GPU is not available, the function returns an error. For information about the supported compute capabilities, see “GPU Computing Requirements” (Parallel Computing Toolbox).
- `'cpu'` — Use the CPU.

Output Arguments

bboxes — Location of objects detected

M-by-4 matrix | *B*-by-1 cell array

Location of objects detected within the input image or images, returned as an M -by-4 matrix or a B -by-1 cell array. M is the number of bounding boxes in an image, and B is the number of M -by-4 matrices when the input contains an array of images.

Each row of `bboxes` contains a four-element vector of the form `[x y width height]`. This vector specifies the upper left corner and size of that corresponding bounding box in pixels.

scores — Detection scores

M -by-1 vector | B -by-1 cell array

Detection confidence scores, returned as an M -by-1 vector or a B -by-1 cell array. M is the number of bounding boxes in an image, and B is the number of M -by-1 vectors when the input contains an array of images. A higher score indicates higher confidence in the detection.

labels — Labels for bounding boxes

M -by-1 categorical array | B -by-1 cell array

Labels for bounding boxes, returned as an M -by-1 categorical array or a B -by-1 cell array. M is the number of labels in an image, and B is the number of M -by-1 categorical arrays when the input contains an array of images. You define the class names used to label the objects when you train the input detector.

detectionResults — Detection results

3-column table

Detection results, returned as a 3-column table with variable names, *Boxes*, *Scores*, and *Labels*. The *Boxes* column contains M -by-4 matrices, of M bounding boxes for the objects found in the image. Each row contains a bounding box as a 4-element vector in the format `[x,y,width,height]`. The format specifies the upper-left corner location and size in pixels of the bounding box in the corresponding image.

Version History

Introduced in R2020a

See Also

Apps

Ground Truth Labeler

Functions

`configureDetectorMonoCamera` | `selectStrongestBboxMulticlass` |
`evaluateDetectionMissRate` | `evaluateDetectionPrecision`

Objects

`monoCamera`

Topics

“Object Detection Using SSD Deep Learning”
“Create SSD Object Detection Network”
“Datastores for Deep Learning” (Deep Learning Toolbox)

pathPlannerRRT

Configure RRT* path planner

Description

The pathPlannerRRT object configures a vehicle path planner based on the optimal rapidly exploring random tree (RRT*) algorithm. An RRT* path planner explores the environment around the vehicle by constructing a tree of random collision-free poses.

Once the pathPlannerRRT object is configured, use the `plan` function to plan a path from the start pose to the goal.

Creation

Syntax

```
planner = pathPlannerRRT(costmap)
planner = pathPlannerRRT(costmap,Name,Value)
```

Description

`planner = pathPlannerRRT(costmap)` returns a pathPlannerRRT object for planning a vehicle path. `costmap` is a `vehicleCostmap` object specifying the environment around the vehicle. `costmap` sets the `Costmap` property value.

`planner = pathPlannerRRT(costmap,Name,Value)` sets properties on page 4-1241 of the path planner by using one or more name-value pair arguments. For example, `pathPlanner(costmap, 'GoalBias', 0.5)` sets the `GoalBias` property to a probability of 0.5. Enclose each property name in quotes.

Properties

Costmap — Costmap of vehicle environment

`vehicleCostmap` object

Costmap of the vehicle environment, specified as a `vehicleCostmap` object. The costmap is used for collision checking of the randomly generated poses. Specify this costmap when creating your pathPlannerRRT object using the `costmap` input.

GoalTolerance — Tolerance around goal pose

[0.5 0.5 5] (default) | [`xTol`, `yTol`, `θTol`] vector

Tolerance around the goal pose, specified as an [`xTol`, `yTol`, `θTol`] vector. The path planner finishes planning when the vehicle reaches the goal pose within these tolerances for the (x , y) position and the orientation angle, θ . The `xTol` and `yTol` values are in the same world units as the `vehicleCostmap`. `θTol` is in degrees.

GoalBias — Probability of selecting goal pose

0.1 (default) | real scalar in the range [0, 1]

Probability of selecting the goal pose instead of a random pose, specified as a real scalar in the range [0, 1]. Large values accelerate reaching the goal at the risk of failing to circumnavigate obstacles.

ConnectionMethod — Method used to connect poses

'Dubins' (default) | 'Reeds-Shepp'

Method used to calculate the connection between consecutive poses, specified as 'Dubins' or 'Reeds-Shepp'. Use 'Dubins' if only forward motions are allowed.

The 'Dubins' method contains a sequence of three primitive motions, each of which is one of these types:

- Straight (forward)
- Left turn at the maximum steering angle of the vehicle (forward)
- Right turn at the maximum steering angle of the vehicle (forward)

If you use this connection method, then the segments of the planned vehicle path are stored as an array of `driving.DubinsPathSegment` objects.

The 'Reeds-Shepp' method contains a sequence of three to five primitive motions, each of which is one of these types:

- Straight (forward or reverse)
- Left turn at the maximum steering angle of the vehicle (forward or reverse)
- Right turn at the maximum steering angle of the vehicle (forward or reverse)

If you use this connection method, then the segments of the planned vehicle path are stored as an array of `driving.ReedsSheppPathSegment` objects.

The `MinTurningRadius` property determines the maximum steering angle.

ConnectionDistance — Maximum distance between poses

5 (default) | positive real scalar

Maximum distance between two connected poses, specified as a positive real scalar. `pathPlannerRRT` computes the connection distance along the path between the two poses, with turns included. Larger values result in longer path segments between poses.

MinTurningRadius — Minimum turning radius of vehicle

4 (default) | positive real scalar

Minimum turning radius of the vehicle, specified as a positive real scalar. This value corresponds to the radius of the turning circle at the maximum steering angle. Larger values limit the maximum steering angle for the path planner, and smaller values result in sharper turns. The default value is calculated using a wheelbase of 2.8 meters with a maximum steering angle of 35 degrees.

MinIterations — Minimum number of planner iterations

100 (default) | positive integer

Minimum number of planner iterations for exploring the costmap, specified as a positive integer. Increasing this value increases the sampling of alternative paths in the costmap.

MaxIterations — Maximum number of planner iterations`10000 (default) | positive integer`

Maximum number of planner iterations for exploring the costmap, specified as a positive integer. Increasing this value increases the number of samples for finding a valid path. If a valid path is not found, the path planner exits after exceeding this maximum.

ApproximateSearch — Enable approximate nearest neighbor search`true (default) | false`

Enable approximate nearest neighbor search, specified as `true` or `false`. Set this value to `true` to use a faster, but approximate, search algorithm. Set this value to `false` to use an exact search algorithm at the cost of increased computation time.

Object Functions

`plan` Plan vehicle path using RRT* path planner
`plot` Plot path planned by RRT* path planner

Examples**Plan Path to Parking Spot**

Plan a vehicle path to a parking spot by using the RRT* algorithm.

Load a costmap of a parking lot. Plot the costmap to see the parking lot and inflated areas for the vehicle to avoid.

```
data = load('parkingLotCostmapReducedInflation.mat');  
costmap = data.parkingLotCostmapReducedInflation;  
plot(costmap)
```

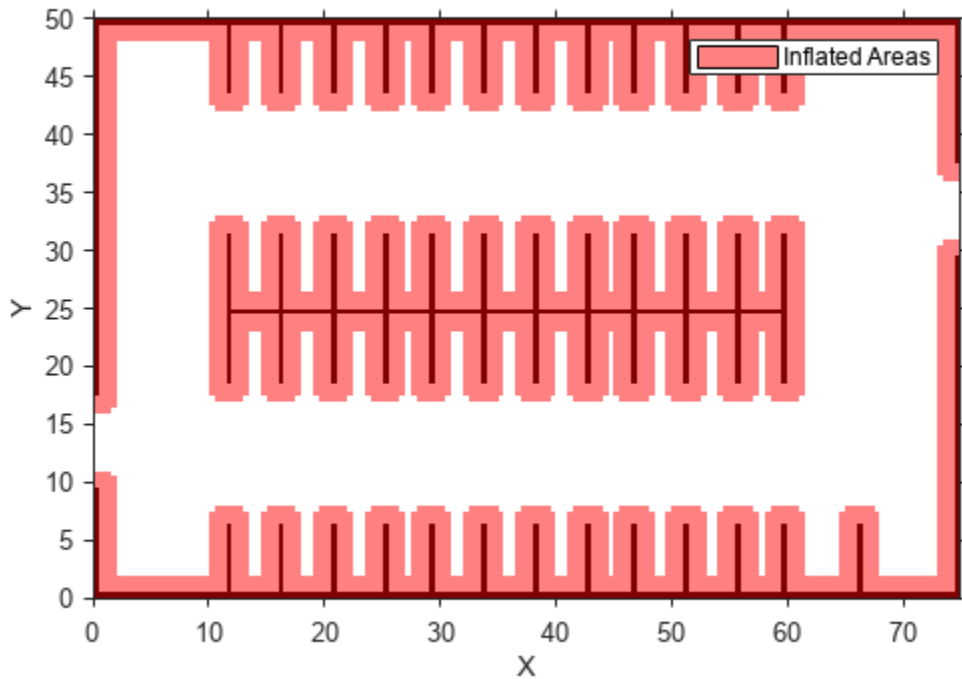

Define start and goal poses for the path planner as $[x, y, \theta]$ vectors. World units for the (x,y) locations are in meters. World units for the θ orientation values are in degrees.

```
startPose = [11, 10, 0]; % [meters, meters, degrees]
goalPose = [31.5, 17, 90];
```

Create an RRT* path planner to plan a path from the start pose to the goal pose.

```
planner = pathPlannerRRT(costmap);
refPath = plan(planner, startPose, goalPose);
```

Plot the planned path.

```
plot(planner)
```

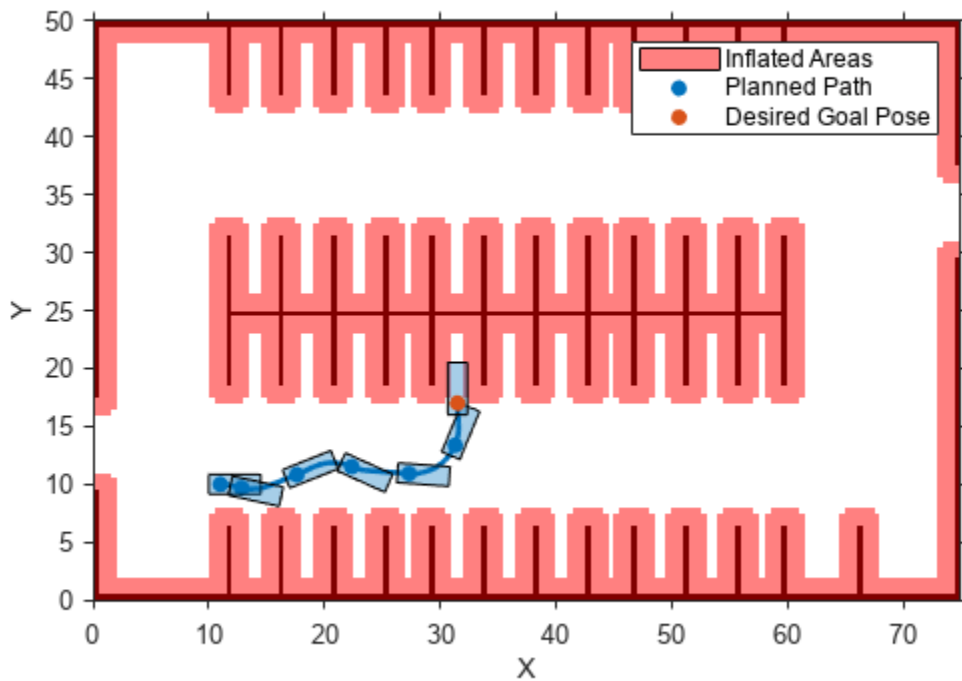

Plan Path and Check Its Validity

Plan a vehicle path through a parking lot by using the optimal rapidly exploring random tree (RRT*) algorithm. Check that the path is valid, and then plot the transition poses along the path.

Load a costmap of a parking lot. Plot the costmap to see the parking lot and inflated areas for the vehicle to avoid.

```
data = load('parkingLotCostmap.mat');  
costmap = data.parkingLotCostmap;  
plot(costmap)
```

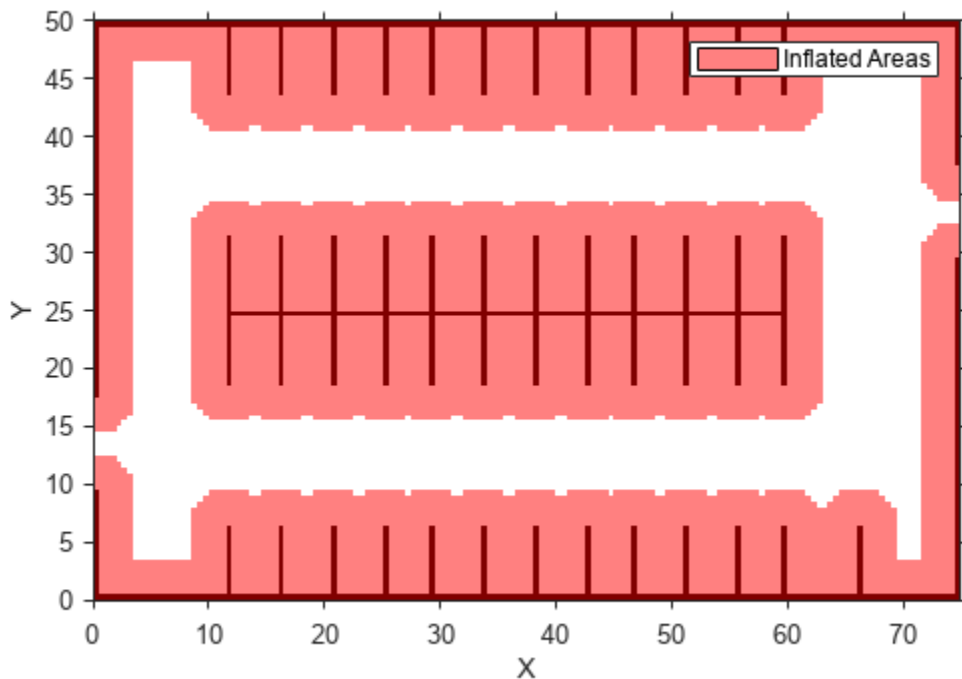

Define start and goal poses for the vehicle as $[x, y, \theta]$ vectors. World units for the (x,y) locations are in meters. World units for the θ orientation angles are in degrees.

```
startPose = [4, 4, 90]; % [meters, meters, degrees]
goalPose = [30, 13, 0];
```

Use a `pathPlannerRRT` object to plan a path from the start pose to the goal pose.

```
planner = pathPlannerRRT(costmap);
refPath = plan(planner,startPose,goalPose);
```

Check that the path is valid.

```
isPathValid = checkPathValidity(refPath,costmap)
isPathValid = logical
    1
```

Interpolate the transition poses along the path.

```
transitionPoses = interpolate(refPath);
```

Plot the planned path and the transition poses on the costmap.

```
hold on
plot(refPath,'DisplayName','Planned Path')
scatter(transitionPoses(:,1),transitionPoses(:,2),[],'filled', ...
```



```
'DisplayName','Transition Poses')
hold off
```

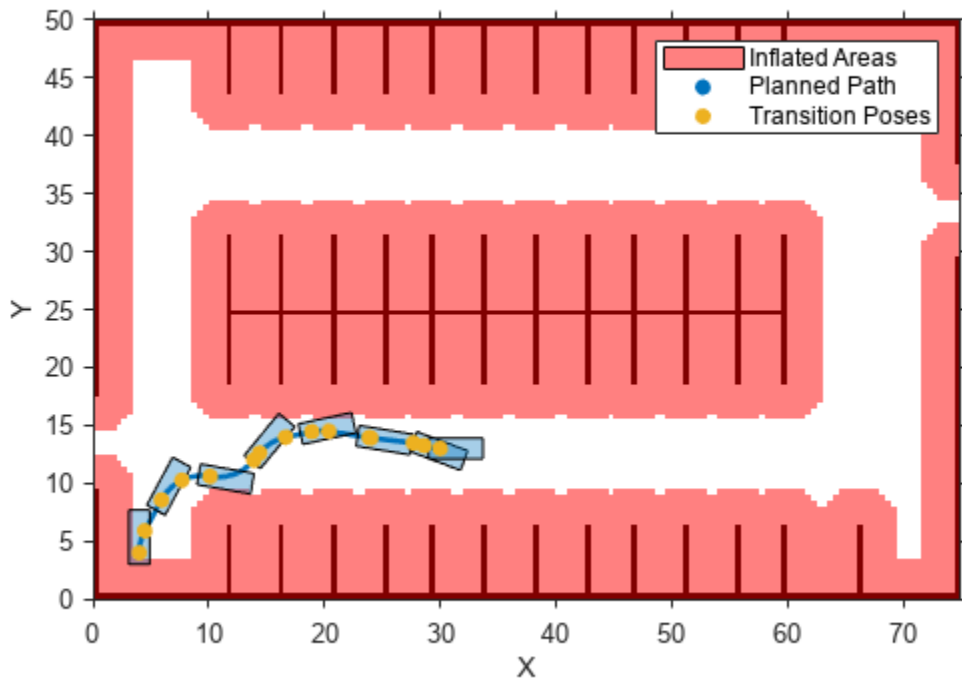

Tips

- Updating any of the properties of the planner clears the planned path from pathPlannerRRT. Calling `plot` displays only the costmap until a path is planned using `plan`.
- To improve performance, the pathPlannerRRT object uses an approximate nearest neighbor search. This search technique checks only \sqrt{N} nodes, where N is the number of nodes to search. To use exact nearest neighbor search, set the `ApproximateSearch` property to `false`.
- The Dubins and Reeds-Shepp connection methods are assumed to be kinematically feasible and ignore inertial effects. These methods make the path planner suitable for low velocity environments, where inertial effects of wheel forces are small.

Version History

Introduced in R2018a

References

- [1] Karaman, Sertac, and Emilio Frazzoli. "Optimal Kinodynamic Motion Planning Using Incremental Sampling-Based Methods." *49th IEEE Conference on Decision and Control (CDC)*. 2010.

[2] Shkel, Andrei M., and Vladimir Lumelsky. "Classification of the Dubins Set." *Robotics and Autonomous Systems*. Vol. 34, Number 4, 2001, pp. 179-202.

[3] Reeds, J. A., and L. A. Shepp. "Optimal paths for a car that goes both forwards and backwards." *Pacific Journal of Mathematics*. Vol. 145, Number 2, 1990, pp. 367-393.

Extended Capabilities

C/C++ Code Generation

Generate C and C++ code using MATLAB® Coder™.

Usage notes and limitations:

- The `ConnectionMethod`, `MinIterations`, `MaxIterations`, and `ApproximateSearch` properties must be compile-time constants.

See Also

Functions

`plan` | `plot` | `checkPathValidity` | `lateralControllerStanley` | `smoothPathSpline`

Blocks

Lateral Controller Stanley

Objects

`vehicleCostmap` | `driving.Path`

Topics

"Automated Parking Valet"

plan

Plan vehicle path using RRT* path planner

Syntax

```
refPath = plan(planner, startPose, goalPose)
[refPath, tree] = plan(planner, startPose, goalPose)
```

Description

`refPath = plan(planner, startPose, goalPose)` plans a vehicle path from `startPose` to `goalPose` using the input `pathPlannerRRT` object. This object configures an optimal rapidly exploring random tree (RRT*) path planner.

`[refPath, tree] = plan(planner, startPose, goalPose)` also returns the exploration tree, `tree`.

Examples

Plan Path to Parking Spot

Plan a vehicle path to a parking spot by using the RRT* algorithm.

Load a costmap of a parking lot. Plot the costmap to see the parking lot and inflated areas for the vehicle to avoid.

```
data = load('parkingLotCostmapReducedInflation.mat');
costmap = data.parkingLotCostmapReducedInflation;
plot(costmap)
```

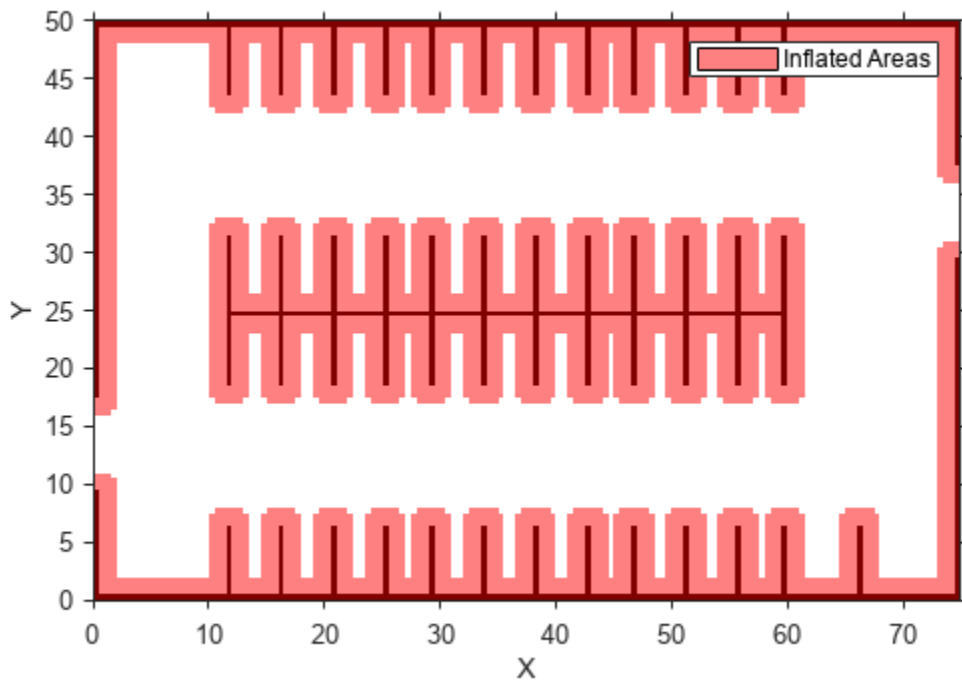

Define start and goal poses for the path planner as $[x, y, \theta]$ vectors. World units for the (x,y) locations are in meters. World units for the θ orientation values are in degrees.

```
startPose = [11, 10, 0]; % [meters, meters, degrees]
goalPose = [31.5, 17, 90];
```

Create an RRT* path planner to plan a path from the start pose to the goal pose.

```
planner = pathPlannerRRT(costmap);
refPath = plan(planner, startPose, goalPose);
```

Plot the planned path.

```
plot(planner)
```

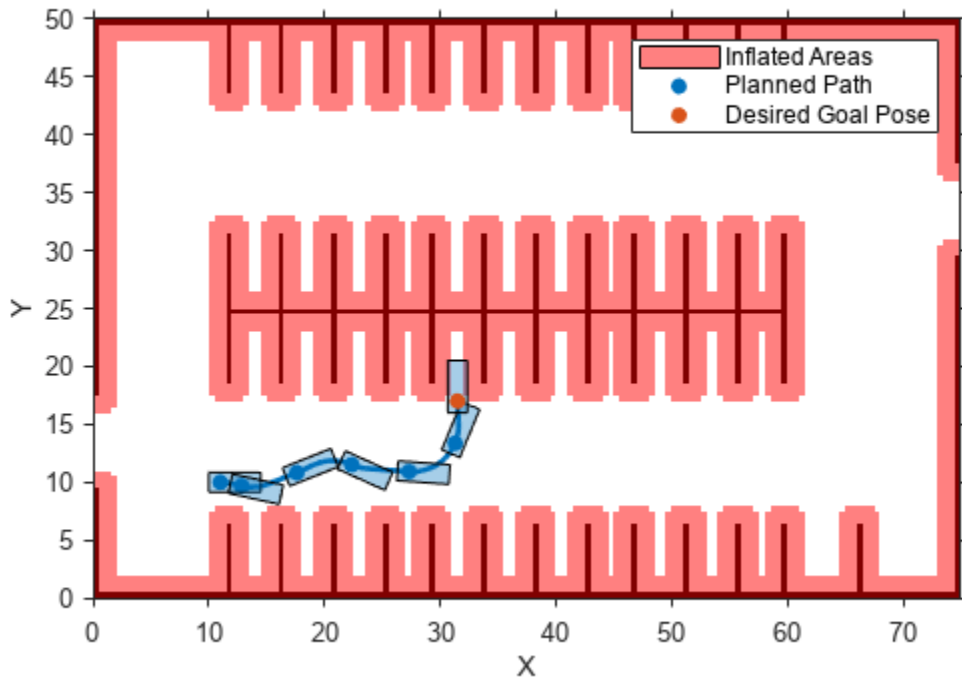

Input Arguments

planner — RRT* path planner

pathPlannerRRT object

RRT* path planner, specified as a pathPlannerRRT object.

startPose — Initial pose of vehicle

$[x, y, \theta]$ vector

Initial pose of the vehicle, specified as an $[x, y, \theta]$ vector. x and y are in world units, such as meters. θ is in degrees.

goalPose — Goal pose of vehicle

$[x, y, \theta]$ vector

Goal pose of the vehicle, specified as an $[x, y, \theta]$ vector. x and y are in world units, such as meters. θ is in degrees.

The vehicle achieves its goal pose when the last pose in the path is within the GoalTolerance property of planner.

Output Arguments

refPath — Planned vehicle path

`driving.Path` object

Planned vehicle path, returned as a `driving.Path` object containing reference poses along the planned path. If planning was unsuccessful, the path has no poses. To check if the path is still valid due to costmap updates, use the `checkPathValidity` function.

tree — Exploration tree

`digraph` object

Exploration tree, returned as a `digraph` object. Nodes within `tree` represent explored vehicle poses. Edges within `tree` represent the distance between connected nodes.

Version History

Introduced in R2018a

Extended Capabilities

C/C++ Code Generation

Generate C and C++ code using MATLAB® Coder™.

Usage notes and limitations:

- The optional `tree` output argument, a `digraph` object, is not supported.

See Also

Functions

`plot` | `checkPathValidity`

Objects

`pathPlannerRRT` | `vehicleCostmap` | `driving.Path` | `digraph`

Topics

“Automated Parking Valet”

plot

Plot path planned by RRT* path planner

Syntax

```
plot(planner)
plot(planner,Name,Value)
```

Description

`plot(planner)` plots the path planned by the input `pathPlannerRRT` object. When specified as an input to the `plan` function, this object plans a path using the rapidly exploring random tree (RRT*) algorithm. If a path has not been planned using `plan`, or if properties of the `pathPlannerRRT` planner have changed since using `plan`, then `plot` displays only the costmap of `planner`.

`plot(planner,Name,Value)` specifies options using one or more name-value pair arguments. For example, `plot(planner,'Tree','on')` plots the poses explored by the RRT* path planner.

Examples

Plan Path to Parking Spot

Plan a vehicle path to a parking spot by using the RRT* algorithm.

Load a costmap of a parking lot. Plot the costmap to see the parking lot and inflated areas for the vehicle to avoid.

```
data = load('parkingLotCostmapReducedInflation.mat');
costmap = data.parkingLotCostmapReducedInflation;
plot(costmap)
```

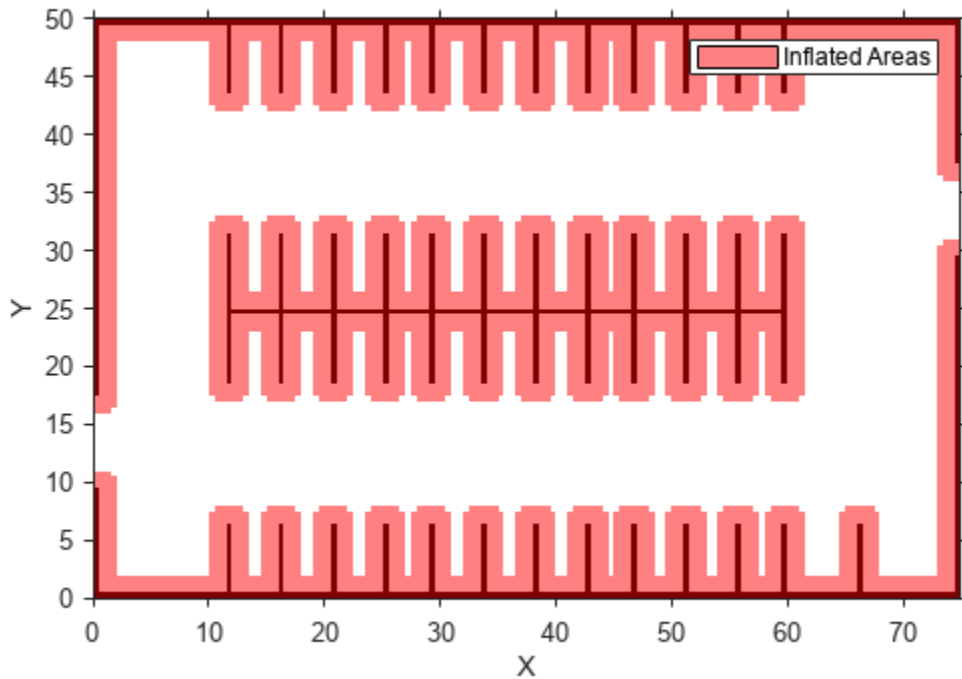

Define start and goal poses for the path planner as $[x, y, \theta]$ vectors. World units for the (x,y) locations are in meters. World units for the θ orientation values are in degrees.

```
startPose = [11, 10, 0]; % [meters, meters, degrees]
goalPose = [31.5, 17, 90];
```

Create an RRT* path planner to plan a path from the start pose to the goal pose.

```
planner = pathPlannerRRT(costmap);
refPath = plan(planner, startPose, goalPose);
```

Plot the planned path.

```
plot(planner)
```

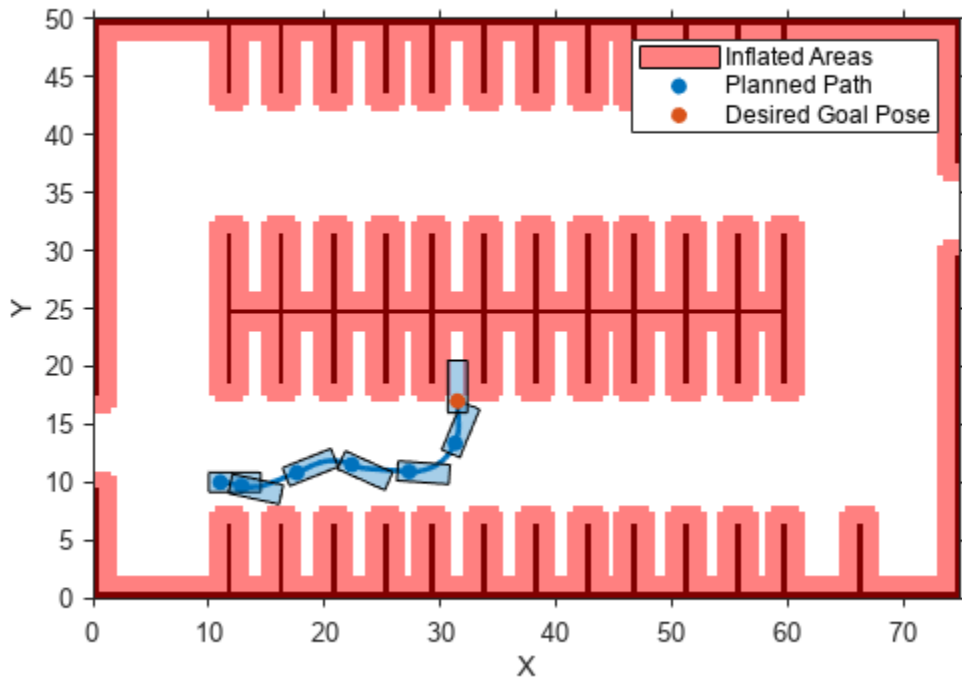
Input Arguments

planner — RRT* path planner

pathPlannerRRT object

RRT* path planner, specified as a pathPlannerRRT object.

Name-Value Pair Arguments

Specify optional pairs of arguments as Name1=Value1, ..., NameN=ValueN, where Name is the argument name and Value is the corresponding value. Name-value arguments must appear after other arguments, but the order of the pairs does not matter.

Before R2021a, use commas to separate each name and value, and enclose Name in quotes.

Example: 'Vehicle', 'off'

Parent — Axes object

axes object

Axes object in which to draw the plot, specified as the comma-separated pair consisting of 'Parent' and an axes object. If you do not specify Parent, a new figure is created.

Tree — Display exploration tree

'off' (default) | 'on'

Display exploration tree, specified as the comma-separated pair consisting of 'Tree' and 'off' or 'on'. Setting this value to 'on' displays the poses explored by the RRT* path planner, planner.

Vehicle — Display vehicle

'on' (default) | 'off'

Display vehicle, specified as the comma-separated pair consisting of 'Vehicle' and 'on' or 'off'. Setting this value to 'off' disables the vehicle displayed along the path planned by the RRT* path planner, planner.

Version History

Introduced in R2018a

See Also

Functions

plan | checkPathValidity

Objects

pathPlannerRRT | vehicleCostmap | driving.Path

Topics

“Automated Parking Valet”

roadrunner

Start RoadRunner application using MATLAB

Description

A `roadrunner` object enables you to perform common workflow tasks in the RoadRunner application, such as opening, closing, and saving scenes and projects, from the MATLAB command line. You can also use object functions to import data from files and export scenes from RoadRunner to other formats.

Before you create a `roadrunner` object for the first time, you must install RoadRunner and activate your RoadRunner license interactively. For more information, see “Install and Activate RoadRunner” (RoadRunner).

The `roadrunner` object requires a license for Automated Driving Toolbox.

Creation

Syntax

```
rrApp = roadrunner(projectFolder)
rrApp = roadrunner(projectFolder,Name=Value)
```

Description

`rrApp = roadrunner(projectFolder)` starts RoadRunner from the default installation folder location, and opens a new scene in an existing project at the location specified by `projectFolder`.

`rrApp = roadrunner(projectFolder,Name=Value)` also uses a name-value argument to set the Properties of the `roadrunner` object.

Input Arguments

projectFolder — RoadRunner project folder path

character vector | string scalar

RoadRunner project folder path, specified as a character vector or string scalar. For details about the RoadRunner project folder structure, see “RoadRunner Project and Scene System” (RoadRunner).

Example: `roadrunner("C:\My Project")` opens the project located in the C:\My Project folder in the RoadRunner application on a Windows® machine.

Data Types: `char` | `string`

Properties

InstallationFolder — Location of local RoadRunner installation folder

character vector | string scalar

Location of local RoadRunner installation folder, specified as a character vector or string scalar.

These are the default RoadRunner installation locations on Windows and Linux® platforms:

- Windows - C:\Program Files\RoadRunner_R20NNx\bin\win64
- Linux, Ubuntu® - /usr/local/RoadRunner_R20NNx/bin/glnxa64

R20NNx is the release version you are using. To customize the default value of the RoadRunner installation folder, use the MATLAB settings API.

Data Types: `char` | `string`

NoDisplay — Start RoadRunner in console mode

`false` or `0` (default) | `true` or `1`

Start RoadRunner in console mode in a non-graphical environment, specified as `logical 0` (`false`) or `logical 1` (`true`). For more details on starting RoadRunner in console mode, see “Control RoadRunner Programmatically in Console Mode” (RoadRunner).

Data Types: `logical`

Ports — Start RoadRunner on specified apiPort and cosimPort

`matrix`

Start RoadRunner on specified `apiPort` and `cosimPort`, specified as a matrix of size 1-by-2. RoadRunner API server port (`apiPort`) and RoadRunner Scenario simulation API server port (`cosimPort`) are automatically assigned by default when you launch the RoadRunner application. The server runs locally at `localhost:port` after you open a RoadRunner project. If the ports assigned are not free, a connection error occurs. In this case, you can explicitly assign values to `apiPort` and `cosimPort` using the `roadrunner` object or the `connect` function.

Example: `rrApp= roadrunner(projectFolder,Ports= [54321, 54322])` starts RoadRunner and RoadRunner Scenario on `apiPort` and `cosimPort` 54321 and 54322 respectively.

Data Types: `int`

Object Functions

Project

<code>newProject</code>	Create new RoadRunner project using MATLAB
<code>openProject</code>	Open RoadRunner project using MATLAB
<code>saveProject</code>	Save RoadRunner project using MATLAB

Scenes

<code>newScene</code>	Create new RoadRunner scene using MATLAB
<code>openScene</code>	Open RoadRunner scene using MATLAB
<code>saveScene</code>	Save RoadRunner scene using MATLAB
<code>exportScene</code>	Export RoadRunner scene using MATLAB
<code>exportCustomFormat</code>	Export RoadRunner scene to custom format using MATLAB
<code>importScene</code>	Import scene into RoadRunner using MATLAB

Scenarios

<code>newScenario</code>	Create new scenario in RoadRunner Scenario using MATLAB
<code>openScenario</code>	Open scenario in RoadRunner Scenario using MATLAB
<code>saveScenario</code>	Save scenario in RoadRunner Scenario using MATLAB
<code>exportScenario</code>	Export scenario from RoadRunner Scenario using MATLAB
<code>importScenario</code>	Import file into RoadRunner Scenario using MATLAB
<code>createSimulation</code>	Create RoadRunner Scenario simulation using MATLAB
<code>getScenarioVariable</code>	Get the value of RoadRunner scenario variable using MATLAB
<code>setScenarioVariable</code>	Set RoadRunner scenario variable using MATLAB
<code>remapAnchor</code>	Remap road anchor in RoadRunner Scenario in MATLAB

Connect, Close and Status

<code>roadrunner.connect</code>	Connect to open instance of RoadRunner using MATLAB
<code>close</code>	Close RoadRunner using MATLAB
<code>status</code>	Get current status of RoadRunner using MATLAB

Examples

Start RoadRunner Application from Default Installation Folder

Specify the path to an existing project using the `projectFolder` variable. For example, this code shows the path to a project, on a Windows® machine, located at `C:\RR\MyProject`.

```
projectFolder = "C:\RR\MyProject";
```

Create a `roadrunner` object and open RoadRunner by specifying your project as the location where you want to create a scene. This example assumes that RoadRunner is installed in its default location.

```
rrApp = roadrunner(projectFolder);
```

Change Default RoadRunner Installation Folder Settings

Modify the default RoadRunner installation folder settings by using the MATLAB `settings` function.

You can specify a value for the `InstallationFolder` property of a `roadrunner` object that persists across MATLAB sessions, or for a given MATLAB session, using the `settings` function.

To set a persistent default value for the `InstallationFolder` property, edit the value of `PersonalValue`. The specified value persists across multiple MATLAB sessions for an individual user.

```
s = settings;
s.roadrunner.application.InstallationFolder.PersonalValue = "C:\Program Files\RoadRunner R2022a\
```

You can also set a temporary default value for the `InstallationFolder` property. The specified value persists for only the current MATLAB session, and is cleared at the end of the session.

```
s = settings;
s.roadrunner.application.InstallationFolder.TemporaryValue = "C:\MyRoadRunner Install\bin\win64"
```

Start Multiple RoadRunner Application Instances Simultaneously

Open multiple RoadRunner applications by creating multiple instances of the `roadrunner` object. You can use each instance to programmatically interact with the RoadRunner application that it opens. The scenes used in this code are included in RoadRunner projects by default.

Open a first instance of RoadRunner by specifying the `Lane Keep` project. In this example, the project is located on the path `C:\RR\Lane Keep`.

```
rrApp1 = roadrunner("C:\RR\Lane Keep");
```

Open the `FourWaySignal` scene in the first project.

```
openScene(rrApp1, "FourWaySignal.rrscene");
```

Open a second instance of RoadRunner by specifying the `USCity` project. In this example, the project is located on the path `C:\RR\USCity`.

```
rrApp2 = roadrunner("C:\RR\USCity");
```

Open the `SanAntonio` scene in the second project

```
openScene(rrApp2, "SanAntonio.rrscene");
```

Start RoadRunner Application in Console Mode

Specify the path to an existing project using the `projectFolder` variable. For example, this code shows the path to a project, on a Windows® machine, located at `C:\RR\MyProject`.

```
projectFolder = "C:\RR\MyProject";
```

Create a `roadrunner` object and open RoadRunner by specifying your project as the location where you want to create a scene. This example assumes that RoadRunner is installed in its default location. Specify the `NoDisplay` property to launch the application in console mode using a non-graphical terminal.

```
rrApp = roadrunner(projectFolder, InstallationFolder="C:\Program Files\RoadRunner R2022b\bin\win64");
```

Limitations

- The `roadrunner` object and its associated functions are supported only in RoadRunner R2022a and later.
- The project you specify using the `projectFolder` argument, when creating the `roadrunner` object must already exist.
- The `projectFolder` argument and “`InstallationFolder`” on page 4-0 property do not support Unicode characters in the path.

Tips

- Deleting the `roadrunner` object from the MATLAB workspace does not close the RoadRunner application associated with it. You must manually close the RoadRunner application. Also, exiting

from the current MATLAB session does not close any RoadRunner applications created by `roadrunner`.

Version History

Introduced in R2022a

See Also

`roadrunner.connect` | `newProject` | `openProject` | `newScenario` | `openScenario` | `close`

Topics

“RoadRunner Project and Scene System” (RoadRunner)

“RoadRunner Scenario Fundamentals” (RoadRunner Scenario)

“Export Multiple Scenes Using MATLAB”

“Convert Scenes Between Formats Using MATLAB Functions”

roadrunner.connect

Connect to open instance of RoadRunner using MATLAB

Syntax

```
rrApp = roadrunner.connect  
rrApp = roadrunner.connect(apiPort)  
rrApp = roadrunner.connect(apiPort,cosimPort)
```

Description

`rrApp = roadrunner.connect` returns an `rrApp` object for the most recently opened instance of RoadRunner.

`rrApp = roadrunner.connect(apiPort)` returns an `rrApp` object for an open RoadRunner application running an API server on the specified IP network port, `apiPort`.

`rrApp = roadrunner.connect(apiPort,cosimPort)` returns an `rrApp` object for an open RoadRunner application. It optionally specifies the scenario simulation API server port using `cosimPort`.

Examples

Connect to Open RoadRunner Instance

Connect to the last opened instance of RoadRunner application using MATLAB.

Use the `connect` function to connect to the last opened instance of RoadRunner. This call returns an object `rrApp` that provides functions for performing basic workflow tasks such as opening, closing, and saving scenes and projects.

```
rrApp = roadrunner.connect();
```

Connect to RoadRunner Instance on Specified IP Network Port

Connect to an open instance of RoadRunner application running on the specified IP Network Port.

Call the `connect` function and pass it the `apiPort` as an argument. This call returns an `rrApp` object for an open RoadRunner application running on API server on the specified IP network port.

```
apiPort = 28703;  
rrApp = roadrunner.connect(apiPort);
```

Connect to RoadRunner Instance Using IP Network and Scenario Simulation Ports

Connect to an open instance of RoadRunner application running on the specified IP network and scenario simulation API server ports.

Call the `connect` function and pass it the `apiPort` and `cosimPort` as arguments. The `apiPort` specifies the IP network port and the `cosimPort` specifies the scenario simulation API server port respectively for the RoadRunner application. This call returns an `rrApp` object for an open RoadRunner application running on API server on the specified IP network and scenario simulation ports.

```
apiPort = 35707;
cosimPort = 35706;
rrApp = roadrunner.connect(apiPort,cosimPort);
```

Input Arguments

apiPort — IP network port for RoadRunner API server

35707 (default)

IP network port for RoadRunner API server, specified as a default value of 35707. This server receives commands from the RoadRunner service methods for importing and exporting scenes and scenarios. The API server runs locally at `localhost:apiPort` after you open a RoadRunner project. Specify `apiPort` as an integer in the range [1024, 65535]. If `apiPort` is unspecified, a default value of 35707 is used for connecting.

Example: `roadrunner.connect(54321)`

Data Types: `int`

cosimPort — IP network port for RoadRunner Scenario co-simulation server

35706 (default)

IP network port for RoadRunner Scenario co-simulation server, specified as a default value of 35706. This server receives commands for co-simulation with MATLAB and Simulink and with external simulators such as CARLA (requires RoadRunner Scenario). Specify `cosimPort` as an integer in the range [1024, 65535]. If `apiPort` is unspecified, a default value of 35706 is used for connecting.

Example: `roadrunner.connect(54321,54322)`

Data Types: `int`

Output Arguments

rrApp — RoadRunner application

`roadrunner` object

RoadRunner application associated with a project, returned as a `roadrunner` object. This object provides functions for performing common workflow tasks such as opening, closing, and saving scenes and projects. `rrApp` provides functions that support importing data from files and exporting scenes to other formats from RoadRunner.

Version History

Introduced in R2022a

See Also

roadrunner | newProject | newScene | newScenario

Topics

“Export Multiple Scenes Using MATLAB”

“Convert Scenes Between Formats Using MATLAB Functions”

close

Close RoadRunner using MATLAB

Syntax

```
close(rrApp)
```

Description

`close(rrApp)` closes the specified RoadRunner instance `rrApp` from the MATLAB command line.

Examples

Open and Close RoadRunner Instance

Open a project in RoadRunner using the `roadrunner` function by specifying the location in which to create a project. This example assumes that RoadRunner is installed in its default location in Windows.

Specify the path to an existing project. For example, this code shows the path to a project located on `C:\RR\MyProject`. The function returns a `roadrunner` object, `rrApp`, that provides functions for performing basic workflow tasks such as opening, closing, and saving scenes and projects.

```
projectFolder = "C:\RR\MyProject";  
rrApp = roadrunner(projectFolder);
```

Close the RoadRunner instance `rrApp`.

```
close(rrApp);
```

Input Arguments

rrApp — RoadRunner application

`roadrunner` object

RoadRunner application associated with a project, specified as a `roadrunner` object. This object provides functions for performing common workflow tasks such as opening, closing, and saving scenes and projects. `rrApp` provides functions that support importing data from files and exporting scenes to other formats from RoadRunner.

Tips

- If you open a RoadRunner instance using a `roadrunner` object and close it interactively, the object continues to exist in the MATLAB workspace. You must delete it manually.
- Function calls made to a `roadrunner` object after closing the associated RoadRunner instance return an error.

- Closing a RoadRunner instance by using the `close` function deletes the associated `roadrunner` object.

Version History

Introduced in R2022a

See Also

`roadrunner` | `newProject` | `newScene` | `newScenario`

Topics

“Export Multiple Scenes Using MATLAB”

“Convert Scenes Between Formats Using MATLAB Functions”

createSimulation

Create RoadRunner Scenario simulation using MATLAB

Syntax

```
rrSim = createSimulation(rrApp)
```

Description

`rrSim = createSimulation(rrApp)` creates and returns a scenario simulation object for the current scenario.

Examples

Create Scenario Simulation

Create a scenario simulation object in RoadRunner Scenario using MATLAB.

Call the `roadrunner` function and pass in the location where you want to create the project. This example assumes that RoadRunner is installed in its default location in Windows.

Specify the path to an existing project. For example, this code shows the path to a project located at "C:\RR\MyProject". This call returns an object `rrApp` that provides functions for performing basic workflow tasks such as opening, closing, and saving scenes and projects

```
projectFolder = "C:\RR\MyProject";  
rrApp = roadrunner(projectFolder);
```

Open an existing scenario in RoadRunner Scenario by calling the `openScenario` function and passing it the `rrApp` object and the specific scenario filename that you want to open. This call opens the desired scenario in the RoadRunner Scenario application through MATLAB.

```
filename = "MyScenario.rrscenario";  
openScenario(rrApp, filename);
```

Create a scenario simulation object by calling the `createSimulation` function and passing it the `rrApp` object. This call returns a simulation object `rrSim` for the current scenario, through which you can control the simulation programatically.

```
rrSim = createSimulation(rrApp);
```

```
Connection status: 1
```

```
Connected to RoadRunner Scenario server on localhost:61720, with client id {fb457314-9501-4395-a
```

Input Arguments

rrApp — RoadRunner application

roadrunner object

RoadRunner application associated with a project, specified as a `roadrunner` object. This object provides functions for performing common workflow tasks such as opening, closing, and saving scenes and projects. `rrApp` provides functions that support importing data from files and exporting scenes to other formats from RoadRunner.

Output Arguments

rrSim — RoadRunner Scenario simulation object

`Simulink.ScenarioSimulation` object

RoadRunner Scenario simulation object, specified as a `Simulink.ScenarioSimulation` object. This object enables you to control a simulation, access and modify the runtime parameters of a simulation, and report custom diagnostic messages during a simulation.

Version History

Introduced in R2022a

See Also

`roadrunner` | `Simulink.ScenarioSimulation` | `getScenarioVariable` | `setScenarioVariable` | `close`

Topics

“RoadRunner Scenario Fundamentals” (RoadRunner Scenario)
“Simulate a RoadRunner Scenario Using MATLAB Functions”

exportCustomFormat

Export RoadRunner scene to custom format using MATLAB

Syntax

```
exportCustomFormat(rrApp, filename, formatname)
```

Description

`exportCustomFormat(rrApp, filename, formatname)` exports the current RoadRunner scene to a custom format specified using the `ExportConfigurations.xml` file. To specify a custom configuration, follow these steps:

- 1 Create an XML file that configures the details of the custom export format.
- 2 Save the XML file to the Project folder of the RoadRunner project that you want to contain the export option and name it `ExportConfigurations.xml`.

For more details on creating the `ExportConfigurations.xml` file, see “Export Custom Formats” (RoadRunner).

Examples

Export RoadRunner Scene using Custom Format

Open a project in RoadRunner using the `roadrunner` function by specifying the location in which to create a project. This example assumes that RoadRunner is installed in its default location in Windows.

Specify the path to an existing project. For example, this code shows the path to a project located on `C:\RR\MyProject`. The function returns a `roadrunner` object, `rrApp`, that provides functions for performing basic workflow tasks such as opening, closing, and saving scenes and projects.

```
projectFolder = "C:\RR\MyProject";  
rrApp = roadrunner(projectFolder);
```

Open an existing scene in RoadRunner.

```
filename = "FourWaySignal.rrscene";  
openScene(rrApp, filename);
```

Create an `ExportConfigurations.xml` file to configure custom export format. Then, use the `exportCustomFormat` function to export the currently open RoadRunner scene to the custom format specified in the `ExportConfigurations.xml` file.

```
customfilename = "customExport.zip";  
formatname = "My Custom Format";  
exportCustomFormat(rrApp, customfilename, formatname);
```

Input Arguments

rrApp — RoadRunner application

roadrunner object

RoadRunner application associated with a project, specified as a `roadrunner` object. This object provides functions for performing common workflow tasks such as opening, closing, and saving scenes and projects. `rrApp` provides functions that support importing data from files and exporting scenes to other formats from RoadRunner.

filename — File path for exported RoadRunner scene

character vector | string scalar

File path for exported RoadRunner scene, specified as a character vector or string scalar. This argument specifies the absolute or relative file path for the exported file. If you specify a relative path, then the exported file is saved relative to the `Exports` folder of the current project. If any folders in the specified path do not exist, RoadRunner tries to create them. `filename` must include the extension of the exported file.

Example: "customExport.zip"

Data Types: `char` | `string`

formatname — Custom export format name

character vector | string scalar

Custom export format name, specified as a character vector or string scalar. This argument specifies the configuration name of your custom export format in the `ExportConfigurations.xml` file. The format name is case sensitive.

Example: "My Custom Format"

Data Types: `char` | `string`

Version History

Introduced in R2022a

See Also

`roadrunner` | `exportScene` | `exportScenario` | `close`

Topics

"Export Multiple Scenes Using MATLAB"

"Convert Scenes Between Formats Using MATLAB Functions"

exportScenario

Export scenario from RoadRunner Scenario using MATLAB

Syntax

```
exportScenario(rrApp, filename, formatname)
exportScenario(rrApp, filename, formatname, exportoptions)
```

Description

`exportScenario(rrApp, filename, formatname)` exports a scenario file to one of the file formats that RoadRunner supports.

`exportScenario(rrApp, filename, formatname, exportoptions)` sets options for export using `exportoptions`. The export options configuration is specified as one of the export options objects compatible with the format name specified in the `formatname` argument. You can export only ASAM OpenSCENARIO files.

Examples

Export Scenario

Export a scenario from RoadRunner Scenario using MATLAB.

Call the `roadrunner` function and pass in the location where you want to create the project. This example assumes that RoadRunner is installed in its default location in Windows.

Specify the path to an existing project. For example, this code shows the path to a project located at "C:\RR\MyProject". This call returns an object `rrApp` that provides functions for performing basic workflow tasks such as opening, closing, and saving scenes and projects.

```
projectFolder = "C:\RR\MyProject";
rrApp = roadrunner(projectFolder);
```

Open a scenario in the project by calling the `openScenario` function. You must pass the `rrApp` object and the RoadRunner scenario you wish to open as input arguments while calling the `openScenario` function. This example uses the 'FourWaySignal.rrscenario' scenario, which is one of the scenario included by default in RoadRunner projects and is located in the `Scenarios` folder of the project.

```
scenarioname = "MyScenario.rrscenario";
openScenario(rrApp, scenarioname);
```

Before exporting the file, set export options by creating an `openScenarioExportOptions` object to enable export of signals and objects from the file.

```
options = openScenarioExportOptions(OpenDriveOptions=openDriveExportOptions(OpenDriveVersion = 1
```

Once the scenario opens successfully, call the `exportScenario` function to export the scenario to ASAM OpenSCENARIO®. Pass `rrApp`, the scenario filename of the scenario, the export format, and the export options as input arguments to the function.

```
filename = "FourWaySignal.xosc";  
formatname = "OpenSCENARIO";  
exportScenario(rrApp, filename, formatname, options);
```

Input Arguments

rrApp — RoadRunner application

`roadrunner` object

RoadRunner application associated with a project, specified as a `roadrunner` object. This object provides functions for performing common workflow tasks such as opening, closing, and saving scenes and projects. `rrApp` provides functions that support importing data from files and exporting scenes to other formats from RoadRunner.

filename — File path to the exported file

character vector | string scalar

File path to the exported file, specified as a character vector or string scalar. `filename` is absolute or relative to the exported file. If you specify a relative path, then the exported file is saved relative to the `Exports` folder of the current project. If any folders in the path are missing, RoadRunner tries to create them. `filename` can include the extension for the exported file or have no extension. If it has no extension, then RoadRunner appends the extension of the format specified by the `formatname` to the file name before exporting the scenario.

Example: While calling `exportScenario(rrApp, "FourWaySignal.xosc", "OpenSCENARIO", options)`, `"FourWaySignal.xosc"` represents the file name of the exported file, which is relative to the `Exports` folder of the current project.

Data Types: `char` | `string`

formatname — Export format name

character vector | string scalar

Export format name, specified as a character vector or string scalar. This argument specifies the export format name corresponding to a valid RoadRunner export format. Format name options are case-insensitive. RoadRunner only supports ASAM OpenSCENARIO format.

Example: While calling `exportScenario(rrApp, "FourWaySignal.xosc", "OpenSCENARIO", options)`, `OpenSCENARIO` specifies that the file will be exported to ASAM OpenSCENARIO format.

Data Types: `char` | `string`

exportoptions — Export options configuration

`exportoptions` object

Export options configuration, specified as one of the export options objects compatible with the format name specified in the `formatname` argument. This argument specifies the options that can be used with `export`. Only `openScenarioExportOptions` and `openScenario2ExportOptions` objects are supported.

Export Format Options Object	Description	Properties	
<p>openScenarioExportOptions</p>	<p>Specifies options for exporting RoadRunner scene and scenario to ASAM OpenSCENARIO.</p> <p>openScenarioExportOptions (Name=Value) creates an export options configuration object for the ASAM OpenSCENARIO format with properties specified as one or more name-value arguments. If a default property value is "auto", the RoadRunner application determines what value to use and sets the property to that value.</p>	<p>OpenScenarioVersion</p>	<p>The version to export as ASAM OpenSCENARIO 1.0 or ASAM OpenSCENARIO 1.1, specified as a scalar double.</p> <p>Default: "auto"</p>
		<p>SceneGraphFormatName</p>	<p>Format of scene graph file to export, specified as a string or character vector. Only OpenSceneGraph format is supported. Specify this option to export a new scene graph file for the scenario. To reuse an existing scene graph file, specify the file in the SceneGraphFileName property.</p> <p>Default: "auto"</p>
		<p>SceneGraphFileName</p>	<p>Name of previously exported scene graph file, specified as a string or character vector. Specify this option to reuse an</p>

Export Format Options Object	Description	Properties	
			<p>existing scene, which can speed up the export process. If SceneGraphFormatName is specified, then this property is ignored and a new scene graph file is generated.</p> <p>Default: "auto"</p>
		OpenSceneGraphOptions	<p>Export options for the OpenSceneGraph file, specified as an openScenarioExportOptions object.</p> <p>Default: "auto"</p>
		OpenDriveOptions	<p>Export options for the ASAM OpenDRIVE file, specified as an openDriveExportOptions object.</p> <p>Default: "auto".</p>
		<p>Example: options = openScenarioExportOptions(OpenDriveOptions = openDriveExportOptions(ExportObjects=true));</p>	

Export Format Options Object	Description	Properties	
openScenario2ExportOptions	<p>Specifies options for exporting RoadRunner scene and scenario to ASAM OpenSCENARIO 2.0.</p> <p>openScenario2ExportOptions (Name=Value) creates an export options configuration object for the ASAM OpenSCENARIO 2.0 format with properties specified as one or more name-value arguments. If a default property value is "auto", the RoadRunner application determines what value to use and sets the property to that value.</p>	OpenDriveOptions	<p>Export options for the ASAM OpenDRIVE file, specified as an openDriveExportOptions object.</p> <p>Default: "auto".</p>
		<p>Example: options = openScenario2ExportOptions(OpenDriveOptions = openDriveExportOptions(ExportObjects=true));</p>	

Data Types: char | string

Version History

Introduced in R2022a

See Also

roadrunner | importScenario | openScenario | close

Topics

"RoadRunner Scenario Fundamentals" (RoadRunner Scenario)

"Simulate a RoadRunner Scenario Using MATLAB Functions"

exportScene

Export RoadRunner scene using MATLAB

Syntax

```
exportScene(rrApp, filename, formatname)
exportScene(rrApp, filename, formatname, exportoptions)
```

Description

`exportScene(rrApp, filename, formatname)` exports the RoadRunner scene file to one of the file formats supported by RoadRunner.

`exportScene(rrApp, filename, formatname, exportoptions)` specifies an export option configuration, `exportoptions`.

Examples

Export Scene from RoadRunner to ASAM OpenDRIVE®

Export a scene from a RoadRunner project to the ASAM OpenDRIVE format using MATLAB®.

Open a project in RoadRunner using the `roadrunner` function by specifying the location in which to create a project. This example assumes that RoadRunner is installed in its default location in Windows.

Specify the path to an existing project. For example, this code shows the path to a project located on `C:\RR\MyProject`. The function returns a `roadrunner` object, `rrApp`, that provides functions for performing basic workflow tasks such as opening, closing, and saving scenes and projects.

```
projectFolder = "C:\RR\MyProject";
rrApp = roadrunner(projectFolder);
```

Open a scene in the project by using the `openScene` function with the `roadrunner` object and the RoadRunner scene you wish to open as input arguments. This example uses the `FourWaySignal.rrscene` scene, which is one of the scenes included by default in RoadRunner projects, and is located in the `Scenes` folder of the project.

```
sceneName = "FourWaySignal.rrscene";
openScene(rrApp, sceneName);
```

Set export options by creating an `openDriveExportOptions` object to enable export of signals and objects from the file.

```
options = openDriveExportOptions(OpenDriveVersion=1.5, ExportSignals=true, ExportObjects=true);
```

Use the `exportScene` function to export the scene to ASAM OpenDRIVE. Specify your `roadrunner` object, the name of the file to which you want to export the scene, the export format, and the export options as input arguments to the `exportScene` function.

```
filename = "FourWaySignal.xodr";
formatname = "OpenDRIVE";
exportScene(rrApp, filename, formatname, options);
```

Input Arguments

rrApp — RoadRunner application

roadrunner object

RoadRunner application associated with a project, specified as a roadrunner object. This object provides functions for performing common workflow tasks such as opening, closing, and saving scenes and projects. rrApp provides functions that support importing data from files and exporting scenes to other formats from RoadRunner.

filename — File path for the exported RoadRunner scene

character vector | string scalar

File path for the exported RoadRunner scene, specified as a character vector or string scalar. This argument specifies the absolute or relative file path of the file to which you are exporting the scene from the RoadRunner project. If you specify a relative path, then the path is relative to the Exports folder of the current project. If you specify an absolute path, then RoadRunner exports the scene to a file in the exact location specified. If any folders in the path are missing, RoadRunner tries to create them. filename can include the extension for the exported file or have no extension. If it has no extension, then RoadRunner appends the extension of the format specified by the formatname to the file name before exporting the scene.

Example: `exportScene(rrApp, "FourWaySignal.xodr", "OpenDRIVE", options)`, "FourWaySignal.xodr" represents the file name of the exported file, which is relative to the Exports folder of the current project.

Data Types: char | string

formatname — Export format name

character vector | string scalar

Export format name, specified as a character vector or string scalar. This argument specifies the format name corresponding to a valid RoadRunner format. Format name options are case-insensitive. Supported formats are: AutoCAD®, Filmbox, glTF™, OpenFlight, OpenSceneGraph, ASAM OpenDRIVE, USD, Apollo, CARLA, Metamoto®, Unity®, Unreal, GeoJSON, and VTD.

Example: While calling `exportScene(rrApp, "FourWaySignal.xodr", "OpenDRIVE", options)`, "OpenDRIVE" specifies that the file will be exported to ASAM OpenDRIVE format.

Data Types: char | string

exportoptions — Export options configuration

valid export options object

Export options configuration, specified as one of the export options objects compatible with the specified format formatname. This argument specifies the options used when exporting the specified scene.

Export Formats	Description	Properties	
apolloExportOptions	<p>Options for exporting a RoadRunner scene to Apollo.</p> <p>apolloExportOptions (Name=Value) creates an export options configuration object for the Apollo format, with properties specified as one or more name-value arguments.</p> <p>If a default property value is "auto", the RoadRunner application determines what value to use and sets the property to that value.</p>	ApolloVersion	<p>Apollo version to export to, specified as 3 or 5, respectively.</p> <p>Default: "auto"</p>
		DatabaseVersion	<p>Identifier for the exported scene, specified as a numeric scalar. This property is useful for versioning exports of the same scene.</p> <p>Default: "auto"</p>
		DatabaseName	<p>Name of the exported scene, specified as a string scalar or character vector.</p> <p>Default: "auto"</p>
		DrivingSide	<p>Driving side of the exported scene, specified as: "Unspecified", "Left", or "Right".</p> <p>Default: "auto"</p>
		ExportSignals	<p>Export all signals and signs mapped to junctions as <signal> entries, specified as a logical 1</p>

Export Formats	Description	Properties	
			(true) or 0 (false). Default: "auto"
		ExportObjects	Export all props as <object> entries, specified as a logical 1 (true) or 0 (false). Default: "auto"
		ClampDistances	Clamp distances in the RoadRunner scene to multiples of 1 cm, specified as a logical 1 (true) or 0 (false). Specifying this property as true can prevent RoadRunner from exporting very short roads. Default: "auto"
		Example: options = apolloExportOptions(DrivingSide="Right");	

Export Formats	Description	Properties	
autocadExportOptions	<p>Options for exporting a RoadRunner scene to AutoCAD.</p> <p><code>autocadExportOptions(Name=Value)</code> creates an export options configuration object for the AutoCAD format, with properties specified as one or more name-value arguments.</p> <p>If a default property value is "auto", the RoadRunner application determines what value to use and sets the property to that value.</p>	SplitMeshes	<p>Split meshes by their segmentation type, specified as a logical 1 (true) or 0 (false).</p> <p>Default: "auto"</p>
		ResizeTextu reDimension s	<p>Resize the dimensions of exported textures by rounding them up to the next highest power of two, specified as a logical 1 (true) or 0 (false).</p> <p>Default: "auto"</p>
		TilesExport Options	<p>Options for splitting meshes per tile, specified as a <code>tilesExportOptions</code> object.</p> <p>Default: "auto"</p>
		<p>Example: <code>options = autocadExportOptions(SplitMeshes=true);</code></p>	

Export Formats	Description	Properties	
tilesExportOptions	<p>Options for exporting tiles.</p> <p><code>tilesExportOptions(Name=Value)</code> creates an options configuration object for exporting tiles, with properties specified as one or more name-value arguments. These fields correspond to options in the AutoCAD, Filmbox, glTF, OpenFlight, OpenSceneGraph, and USD export options.</p> <p>If a default property value is "auto", the RoadRunner application determines what value to use and sets the property to that value.</p>	TileSize	<p>The size of exported tiles, specified as a two element double vector.</p> <p>Default: "auto"</p>
		TileCenter	<p>The center location of exported tiles, specified as a two element double vector.</p> <p>Default: "auto"</p>
		ExportIndividualTiles	<p>Export each tile as a separate file, specified as a logical 1 (true) or 0 (false).</p> <p>Default: "auto"</p>
		<p>Example: <code>options = tilesExportOptions(TileSize=[100 100]);</code></p>	

Export Formats	Description	Properties	
<p>carlaExportOptions</p>	<p>Options for exporting a RoadRunner scene to CARLA.</p> <p><code>carlaExportOptions(Name=Value)</code> creates an export options configuration object for the CARLA format, with properties specified as one or more name-value arguments.</p> <p>If a default property value is "auto", the RoadRunner application determines what value to use and sets the property to that value.</p>	<p>UnrealDatasmithOptions</p>	<p>Options for exporting a UnrealDatasmith file, specified as a <code>unrealDatasmithExportOptions</code> object.</p> <p>Default: "auto"</p>
		<p>OpenDriveOptions</p>	<p>Options for exporting an ASAM OpenDRIVE file, specified as an <code>openDriveExportOptions</code> object.</p> <p>Default: "auto"</p>
		<p>Example: <code>options = carlaExportOptions(UnrealDatasmithOptions=unrealDatasmithExportOptions(SplitMeshes=true));</code></p>	

Export Formats	Description	Properties	
carlaFilmboxExportOptions	<p>Options for exporting a RoadRunner scene to CARLA.</p> <p><code>carlaFilmboxExportOptions(Name=Value)</code> creates an export options configuration object for the CARLA format, with properties specified as one or more name-value arguments.</p> <p>If a default property value is "auto", the RoadRunner application determines what value to use and sets the property to that value.</p>	OpenDriveOptions Options for exporting an ASAM OpenDRIVE file, specified as an <code>openDriveExportOptions</code> object. Default: "auto"	
		FilmboxOptions Options for exporting a Filmbox file, specified as a <code>filmboxExportOptions</code> object. Default: "auto"	
		Example: <code>options = carlaFilmboxExportOptions(FilmboxOptions=filmboxExportOptions(SplitMeshes=true));</code>	

Export Formats	Description	Properties	
<p>datasmithRoadExportOptions</p>	<p>Options for exporting a RoadRunner scene to DatasmithRoad.</p> <p><code>datasmithRoadExportOptions(Name=Value)</code> creates an export options configuration object for the DatasmithRoad format, with properties specified as one or more name-value arguments.</p> <p>If a default property value is "auto", the RoadRunner application determines what value to use and sets the property to that value.</p>	<p>UnrealDatasmithOptions</p>	<p>Options for exporting a Unreal Datasmith file, specified as a <code>unrealDatasmithExportOptions</code> object.</p> <p>Default: "auto"</p>
		<p>OpenDriveOptions</p>	<p>Options for exporting an ASAM OpenDRIVE file, specified as an <code>openDriveExportOptions</code> object.</p> <p>Default: "auto"</p>
		<p>Example: <code>options = datasmithRoadExportOptions(UnrealDatasmithOptions=unrealDatasmithExportOptions(SplitMeshes=true));</code></p>	

Export Formats	Description	Properties	
filmboxExportOptions	<p>Options for exporting a RoadRunner scene to Filmbox.</p> <p><code>filmboxExportOptions(Name=Value)</code> creates an export options configuration object for the Filmbox format, with properties specified as one or more name-value arguments.</p> <p>If a default property value is "auto", the RoadRunner application determines what value to use and sets the property to that value.</p>	SplitMeshes	<p>Split meshes by their segmentation type, specified as a logical 1 (true) or 0 (false).</p> <p>Default: "auto"</p>
		ResizeTextu reDimension s	<p>Resize the dimensions of exported textures by rounding them up to the next highest power of two, specified as a logical 1 (true) or 0 (false).</p> <p>Default: "auto"</p>
		EmbedTextur es	<p>Embed the exported textures inside the exported file, specified as a logical 1 (true) or 0 (false).</p> <p>Default: "auto"</p>
		TilesExport Options	<p>Options to split meshes per tile, specified as a <code>tilesExportOptions</code> object.</p> <p>Default: "auto"</p>
		<p>Example: <code>options = filmboxExportOptions(Res</code></p>	

Export Formats	Description	Properties	
		izeTextureDimensions=true);	
geoJSONExportOptions	<p>Options for exporting a RoadRunner scene to GeoJSON.</p> <p>geoJSONExportOptions(Name=Value) creates an export options configuration object for the GeoJSON format, with properties specified as one or more name-value arguments.</p> <p>If a default property value is "auto", the RoadRunner application determines what value to use and sets the property to that value.</p>	ReduceFileSize	<p>Removes new lines from the exported GeoJSON file and decreases its size, specified as a logical 1 (true) or 0 (false).</p> <p>Default: "auto"</p>
		<p>Example: options = geoJSONExportOptions(ReduceFileSize=true);</p>	

Export Formats	Description	Properties	
glTFExportOptions	<p>Options for exporting a RoadRunner scene to glTF.</p> <p><code>glTFExportOptions(Name=Value)</code> creates an export options configuration object for the glTF format, with properties specified as one or more name-value arguments.</p> <p>If a default property value is "auto", the RoadRunner application determines what value to use and sets the property to that value.</p>	SplitMeshes	<p>Split meshes by their segmentation type, specified as a logical 1 (true) or 0 (false).</p> <p>Default: "auto"</p>
		ResizeTextu reDimension s	<p>Resize the dimensions of exported textures by rounding them up to the next highest power of two, specified as a logical 1 (true) or 0 (false).</p> <p>Default: "auto"</p>
		TilesExport Options	<p>Options for splitting split meshes per tile, specified as a <code>tilesExportOptions</code> object.</p> <p>Default: "auto"</p>
		<p>Example: <code>options = glTFExportOptions(SplitMeshes=true);</code></p>	

Export Formats	Description	Properties	
<p>metamotoExportOptions</p>	<p>Options for exporting a RoadRunner scene to Metamoto.</p> <p>metamotoExportOptions (Name=Value) creates an export options configuration object for the Metamoto format, with properties specified as one or more name-value arguments.</p> <p>If a default property value is "auto", the RoadRunner application determines what value to use and sets the property to that value.</p>	<p>FilmboxOptions</p>	<p>Options for exporting a Filmbox file, specified as a filmboxExportOptions object.</p> <p>Default: "auto"</p>
		<p>OpenDriveOptions</p>	<p>Options for exporting an ASAM OpenDRIVE file, specified as an openDriveExportOptions object.</p> <p>Default: "auto"</p>
		<p>GeoJSONOptions</p>	<p>Options for exporting a GeoJSON file, specified as a geoJSONExportOptions object.</p> <p>Default: "auto"</p>
		<p>Example: options = metamotoExportOptions(GeoJSONOptions=geoJSONExportOptions(ReduceFileSize=true));</p>	

Export Formats	Description	Properties	
openDriveExportOptions	<p>Options for exporting a RoadRunner scene to ASAM OpenDRIVE.</p> <p><code>openDriveExportOptions(Name=Value)</code> creates an export options configuration object for the ASAM OpenDRIVE format, with properties specified as one or more name-value arguments.</p> <p>If a default property value is "auto", the RoadRunner application determines what value to use and sets the property to that value.</p>	OpenDriveVersion	<p>ASAM OpenDRIVE version to export to, specified as 1.4, 1.5, or 1.6, specified as a scalar double.</p> <p>Default: 1.6</p>
		DatabaseVersion	<p>Identifier for the exported scene, specified as a numeric scalar. This property is useful for versioning exports of the same scene.</p> <p>Default: 0.</p>
		DatabaseName	<p>Name of the exported scene, specified as a string scalar or character vector.</p> <p>Default: "auto"</p>
		DrivingSide	<p>Driving side of the exported scene, specified as: "Unspecified", "Left", or "Right".</p> <p>Default: "auto"</p>
		ExportMarkingsAsLine	<p>Export additional lane marking data (spacing, dash length, and individual paint strip</p>

Export Formats	Description	Properties	
			widths) using the <line> definition in ASAM OpenDRIVE, specified as a logical 1 (true) or 0 (false). Default: "auto"
		ExportSignals	Export all signals and signs mapped to junctions as <signal> entries, specified as a logical 1 (true) or 0 (false). Default: "auto"
		ExportOpenCRG	Export to ASAM OpenCRG® file, specified as a logical 1 (true) or 0 (false). Default: "auto"
		ExportObjects	Export all props as <object> entries, specified as a logical 1 (true) or 0 (false). Default: "auto"
		ExportHeadingOffsetRel	Export the <hoffset> (heading

Export Formats	Description	Properties	
		ativeToOrientation	offset) values of <signal> entries as being relative to <orientation>, which is the direction of travel of the road that the signal applies to, specified as a logical 1 (true) or 0 (false). Default: "auto"
		ExportConflictPoints	Export an <object> entry for every point in a junction where two roads intersect, specified as a logical 1 (true) or 0 (false). Default: "auto"
		ExportSceneOriginReference	Export a reference point origin at 0,0 in the scene, specified as a logical 1 (true) or 0 (false). Default: "auto"
		ClampDistances	Clamp distances in the RoadRunner scene to multiples of 1 cm, specified

Export Formats	Description	Properties
		<p>as a logical 1 (true) or 0 (false). Specifying this property as true can prevent RoadRunner from exporting very short roads.</p> <p>Default: "auto"</p> <p>Example: options = openDriveExportOptions(ExportSignals=true);</p>

Export Formats	Description	Properties	
openFlightExportOptions	<p>Options for exporting a RoadRunner scene to OpenFlight.</p> <p><code>openFlightExportOptions(Name=Value)</code> creates an export options configuration object for the OpenFlight format, with properties specified as one or more name-value arguments.</p> <p>If a default property value is "auto", the RoadRunner application determines what value to use and sets the property to that value.</p>	SplitMeshes	<p>Split meshes by their segmentation type, specified as a logical 1 (true) or 0 (false).</p> <p>Default: "auto"</p>
		ResizeTextu reDimension s	<p>Resize the dimensions of exported textures by rounding them up to the next highest power of two, specified as a logical 1 (true) or 0 (false).</p> <p>Default: "auto"</p>
		TilesExport Options	<p>Options for splitting meshes per tile, specified as a <code>tilesExportOptions</code> object.</p> <p>Default: "auto"</p>
		<p>Example: <code>options = openFlightExportOptions(SplitMeshes=true);</code></p>	

Export Formats	Description	Properties	
<p>openSceneGraphExportOptions</p>	<p>Options for exporting a RoadRunner scene to OpenSceneGraph.</p> <p>openSceneGraphExportOptions (Name=Value) creates an export options configuration object for the OpenSceneGraph format, with properties specified as one or more name-value arguments.</p> <p>If a default property value is "auto", the RoadRunner application determines what value to use and sets the property to that value.</p>	SplitMeshes	<p>Split meshes by their segmentation type, specified as a logical 1 (true) or 0 (false).</p> <p>Default: "auto"</p>
		ResizeTextures	<p>Resize the dimensions of exported textures by rounding them up to the next highest power of two, specified as a logical 1 (true) or 0 (false).</p> <p>Default: "auto"</p>
		EmbedTextures	<p>Embed the exported textures inside the exported file, specified as a logical 1 (true) or 0 (false).</p> <p>Default: "auto"</p>
		TilesExportOptions	<p>Options for splitting meshes per tile, specified as a tilesExportOptions object.</p> <p>Default: "auto"</p>

Export Formats	Description	Properties	
		Example: options = openSceneGraphExportOptions(SplitMeshes=true);	
unityExportOptions	<p>Options for exporting a RoadRunner scene to Unity.</p> <p>unityExportOptions(Name=Value) creates an export options configuration object for the Unity format, with properties specified as one or more name-value arguments.</p> <p>If a default property value is "auto", the RoadRunner application determines what value to use and sets the property to that value.</p>	FilmboxOptions	<p>Options for exporting a Filmbox file, specified as a filmboxExportOptions object.</p> <p>Default: "auto"</p>
		OpenDriveOptions	<p>Options for exporting an ASAM OpenDRIVE file, specified as an openDriveExportOptions object.</p> <p>Default: "auto"</p>
		Example: options = unityExportOptions(FilmboxOptions=filmboxExportOptions(EmbedTextures=true));	

Export Formats	Description	Properties	
<p>unrealExportOptions</p>	<p>Options for exporting a RoadRunner scene to Unreal.</p> <p>unrealExportOptions (Name=Value) creates an export options configuration object for the Unreal format, with properties specified as one or more name-value arguments.</p> <p>If a default property value is "auto", the RoadRunner application determines what value to use and sets the property to that value.</p>	<p>FilmboxOptions</p>	<p>Options for exporting a Filmbox file, specified as a filmboxExportOptions object.</p> <p>Default: "auto"</p>
		<p>OpenDriveOptions</p>	<p>Options for exporting an ASAM OpenDRIVE file, specified as an openDriveExportOptions object.</p> <p>Default: "auto"</p>
		<p>Example: options = unrealExportOptions(FilmboxOptions=filmboxExportOptions(EmbedTextures=true));</p>	

Export Formats	Description	Properties	
<p>unrealDatasmithExportOptions</p>	<p>Options for exporting a RoadRunner scene to UnrealDatasmith.</p> <p>unrealDatasmithExportOptions(Name=Value) creates an export options configuration object for the UnrealDatasmith format, with properties specified as one or more name-value arguments.</p> <p>If a default property value is "auto", the RoadRunner application determines what value to use and sets the property to that value.</p>	<p>SplitMeshes</p>	<p>Split meshes by their segmentation type, specified as a logical 1 (true) or 0 (false).</p> <p>Default: "auto"</p>
		<p>ResizeTextureDimensions</p>	<p>Resize the dimensions of exported textures by rounding them up to the next highest power of two, specified as a logical 1 (true) or 0 (false).</p> <p>Default: "auto"</p>
		<p>TilesExportOptions</p>	<p>Options for splitting meshes per tile, specified as a tilesExportOptions object.</p> <p>Default: "auto"</p>
		<p>Example: options = unrealDatasmithExportOptions(ResizeTextureDimensions=true);</p>	

Export Formats	Description	Properties	
usdExportOptions	<p>Options for exporting a RoadRunner scene to USD.</p> <p>usdExportOptions(Name=Value) creates an export options configuration object for the USD format, with properties specified as one or more name-value arguments.</p> <p>If a default property value is "auto", the RoadRunner application determines what value to use and sets the property to that value.</p>	SplitMeshes	<p>Split meshes by their segmentation type, specified as a logical 1 (true) or 0 (false).</p> <p>Default: "auto"</p>
		ResizeTextu reDimension s	<p>Resize the dimensions of exported textures by rounding them up to the next highest power of two, specified as a logical 1 (true) or 0 (false).</p> <p>Default: "auto"</p>
		TilesExport Options	<p>Options for splitting meshes per tile, specified as a tilesExportOptions object.</p> <p>Default: "auto"</p>
		<p>Example: options = usdExportOptions(SplitMeshes=true);</p>	

Export Formats	Description	Properties	
vtdExportOptions	<p>Options for exporting a RoadRunner scene to VTD.</p> <p>vtdExportOptions(Name=Value) creates an export options configuration object for the VTD format, with properties specified as one or more name-value arguments.</p> <p>If a default property value is "auto", the RoadRunner application determines what value to use and sets the property to that value.</p>	OpenSceneGraphOptions	Options for export an OpenSceneGraph file, specified as an openSceneGraphExportOptions object. Default: "auto"
		OpenDriveOptions	Options for export an ASAM OpenDRIVE file, specified as an openDriveExportOptions object. Default: "auto"
		<p>Example: options = vtdExportOptions(OpenDriveOptions=openDriveExportOptions(ExportObjects=true));</p>	

Data Types: char | string

Version History

Introduced in R2022a

See Also

roadrunner | openScene | exportCustomFormat | importScene | close

Topics

"Export Multiple Scenes Using MATLAB"

"Convert Scenes Between Formats Using MATLAB Functions"

getScenarioVariable

Get the value of RoadRunner scenario variable using MATLAB

Syntax

```
value = getScenarioVariable(rrApp,name)
```

Description

`value = getScenarioVariable(rrApp,name)` returns the value of a variable in the current scenario with the specified name.

Examples

Get Scenario Variable

Get a scenario variable in RoadRunner Scenario using MATLAB.

Call the `roadrunner` function and pass in the location where you want to create the project. This example assumes that RoadRunner is installed in its default location in Windows.

Specify the path to an existing project. For example, this code shows the path to a project located at "C:\RR\MyProject". This call returns an object `rrApp` that provides functions for performing basic workflow tasks such as opening, closing, and saving scenes and projects

```
projectFolder = "C:\RR\MyProject";  
rrApp = roadrunner(projectFolder);
```

Open an existing scenario in RoadRunner Scenario by calling the `openScenario` function and passing it the `rrApp` object and the specific scenario filename that you want to open. This call opens the desired scenario in the RoadRunner Scenario application through MATLAB.

```
filename = "MyScenario.rrscenario";  
openScenario(rrApp,filename);
```

Get the value of a scenario variable. Call the `getScenarioVariable` function and pass it the `rrApp` object and the variable whose value you want to retrieve. For example, this call retrieves a value of 17.88 as the initial speed of the Ambulance in the scenario, `MyScenario`. This example has an existing variable, `Ambulance_InitialSpeed`.

```
name = "Ambulance_InitialSpeed";  
value = getScenarioVariable(rrApp,name);
```

Input Arguments

rrApp — RoadRunner application

roadrunner object

RoadRunner application associated with a project, specified as a `roadrunner` object. This object provides functions for performing common workflow tasks such as opening, closing, and saving scenes and projects. `rrApp` provides functions that support importing data from files and exporting scenes to other formats from RoadRunner.

name — Name of variable to retrieve value

character vector | string scalar

Name of variable to retrieve value, specified as a character vector or string scalar. If the specified variable does not exist in the scenario, it results in an error. For more details on creating variables in a scenario, see “Generate Scenario Variations” (RoadRunner Scenario).

Example: `getScenarioVariable(rrApp,"Ambulance_InitialSpeed");` retrieves the initial speed of the Ambulance vehicle.

Output Arguments**value — Value assigned to variable**

character vector | string scalar

Value assigned to variable, returned as a character vector or string scalar.

Example: `getScenarioVariable(rrApp,"Ambulance_InitialSpeed");` retrieves the initial speed as 17.88 m/s assigned of the Ambulance vehicle.

Version History

Introduced in R2022a

See Also

`roadrunner` | `setScenarioVariable` | `close`

Topics

“RoadRunner Scenario Fundamentals” (RoadRunner Scenario)

“Simulate a RoadRunner Scenario Using MATLAB Functions”

importScenario

Import file into RoadRunner Scenario using MATLAB

Syntax

```
importScenario(rrApp, filename, formatname)
importScenario(rrApp, filename, formatname, importoptions)
```

Description

`importScenario(rrApp, filename, formatname)` imports an ASAM OpenSCENARIO file or a trajectory in a CSV file into the currently opened scenario.

`importScenario(rrApp, filename, formatname, importoptions)` sets additional import options using `importoptions` argument. This syntax is valid only when importing an ASAM OpenSCENARIO file.

Examples

Import Scenario

Import a scenario in RoadRunner Scenario using MATLAB.

Call the `roadrunner` function and pass in the location where you want to create the project. This example assumes that RoadRunner is installed in its default location in Windows.

Specify the path to an existing project. For example, this code shows the path to a project located at "C:\RR\MyProject". This call returns an object `rrApp` that provides functions for performing basic workflow tasks such as opening, closing, and saving scenes and projects.

```
projectFolder = "C:\RR\MyProject";
rrApp = roadrunner(projectFolder);
```

Open a new scenario in the current project by calling the `newScenario` function and passing it the `rrApp` object. This call opens a blank scenario in the currently opened project.

```
newScenario(rrApp);
```

Before importing the ASAM OpenSCENARIO® file, set import options by creating an `openScenarioImportOptions` object to enable import of signals from the file.

```
options = openScenarioImportOptions(OpenDriveOptions = openDriveImportOptions(ImportSignals=true));
```

Call the `importScenario` function and pass the `rrApp` object, the filename, and the `options` object as input arguments. This function call imports data from the specified filename into the currently opened scenario.

```
filename = "C:\RR\MyProject\Assets\FourWaySignal.xosc";
formatname = "OpenSCENARIO";
importScenario(rrApp, filename, formatname, options);
```

Input Arguments

rrApp — RoadRunner application

roadrunner object

RoadRunner application associated with a project, specified as a roadrunner object. This object provides functions for performing common workflow tasks such as opening, closing, and saving scenes and projects. rrApp provides functions that support importing data from files and exporting scenes to other formats from RoadRunner.

filename — Path of file which is to be imported

character vector | string scalar

Path of file which is to be imported, specified as a character vector or string scalar. filename is absolute or relative path to the file to be imported. If you specify a relative path, then you must specify a path to a file in the Assets folder of the current project.

Example: While calling `importScenario(rrApp, "C:\RR\MyProject\Assets\FourWaySignal.xosc", "OpenSCENARIO", importoptions)`, "C:\RR\MyProject\Assets\FourWaySignal.xosc" represents the file path of the file to be imported, which is relative to the Assets folder of the current project.

Data Types: char | string

formatname — Import format name

"OpenSCENARIO" | "CSV Trajectory"

Import format name, specified as "OpenSCENARIO" or "CSV Trajectory". Format name options are case-insensitive.

- "OpenSCENARIO" — Import ASAM OpenSCENARIO file
- "CSV Trajectory" — Import vehicle trajectory from a CSV file

Example: While calling `importScenario(rrApp, "C:\RR\MyProject\Assets\FourWaySignal.xosc", "OpenSCENARIO", importoptions)`, OpenSCENARIO specifies that the file will be imported to ASAM OpenSCENARIO format.

Data Types: char | string

importoptions — Import options configuration

openScenarioImportOptions object

Import options configuration, specified as an openScenarioImportOptions object compatible with the file specified in the filename argument. You can specify this argument only when the value of formatname is "OpenSCENARIO".

Import Format Options Object	Description	Properties	
<p>openScenarioImportOptions</p>	<p>Specifies options for importing ASAM OpenSCENARIO file into RoadRunner scenario.</p> <p>openScenarioImportOptions (Name=Value) creates an import options configuration object for the ASAM OpenSCENARIO format with properties specified as one or more name-value arguments. If a default property value is "auto", the RoadRunner application determines what value to use and sets the property to that value.</p>	<p>OpenDriveOptions</p>	<p>Options to import an ASAM OpenDRIVE file, specified as an openDriveImportOptions object.</p> <p>Default: "auto".</p>
		<p>Example: options = openScenarioImportOptions(OpenDriveOptions = openDriveImportOptions(ImportSignals=true));</p>	

Version History

Introduced in R2022a

See Also

roadrunner | exportScenario | close

Topics

“RoadRunner Scenario Fundamentals” (RoadRunner Scenario)
 “Simulate a RoadRunner Scenario Using MATLAB Functions”

importScene

Import scene into RoadRunner using MATLAB

Syntax

```
importScene(rrApp,filename,formatname)
importScene(rrApp,filename,formatname,importoptions)
```

Description

`importScene(rrApp,filename,formatname)` imports data from a file specified by `filename` into the currently open scene. The specified file must be in a format RoadRunner supports.

`importScene(rrApp,filename,formatname,importoptions)` sets options for import using the `importoptions` argument.

Examples

Import Scene from ASAM OpenDRIVE® File to RoadRunner

Open a project in RoadRunner using the `roadrunner` function by specifying the location in which to create a project. This example assumes that RoadRunner is installed in its default location in Windows.

Specify the path to an existing project. For example, this code shows the path to a project located on `C:\RR\MyProject`. The function returns a `roadrunner` object, `rrApp`, that provides functions for performing basic workflow tasks such as opening, closing, and saving scenes and projects.

```
projectFolder = "C:\RR\MyProject";
rrApp = roadrunner(projectFolder);
```

Open a new scene in the current project. The `newScene` function opens a blank scene in the currently open project.

```
newScene(rrApp);
```

Set import options by creating an `openDriveImportOptions` object that disables the import of signals and objects from the file.

```
options = openDriveImportOptions(ImportSignals=false,ImportObjects=false);
```

Specify the path to an ASAM OpenDRIVE file. Then, use the `importScene` function to import data from the specified ASAM OpenDRIVE file into the blank open scene.

```
filename = "C:\RR\MyProject\Exports\FourWaySignal.xodr";
formatname = "OpenDRIVE";
importScene(rrApp,filename,formatname,options);
```

Input Arguments

rrApp — RoadRunner application

roadrunner object

RoadRunner application associated with a project, specified as a `roadrunner` object. This object provides functions for performing common workflow tasks such as opening, closing, and saving scenes and projects. `rrApp` provides functions that support importing data from files and exporting scenes to other formats from RoadRunner.

filename — Path of file to import into RoadRunner

character vector | string scalar

Path of file to import into RoadRunner, specified as a character vector or string scalar. This argument specifies the absolute or relative file path of the file to import. If you specify a relative path, then the path is relative to the `Assets` folder of the current project.

Example: `importScene(rrApp, "C:\RR\MyProject\Exports\FourWaySignal.xodr", "OpenDRIVE", options)`, `"C:\RR\MyProject\Exports\FourWaySignal.xodr"` represents the absolute file path of the file to be imported.

Data Types: `char` | `string`

formatname — Import format name

character vector | string scalar

Import format name, specified as a character vector or string scalar. This value must correspond to a valid import format supported by RoadRunner. Format name options are case-insensitive. RoadRunner supports only ASAM OpenDRIVE format.

Example: `importScene(rrApp, "FourWaySignal.xodr", "OpenDRIVE", options)`
"OpenDRIVE" specifies that the imported file `FourWaySignal.xodr` is in the ASAM OpenDRIVE format.

Data Types: `char` | `string`

importoptions — Import options configuration

valid export options object

Import options configuration, specified as one of the import options objects compatible with the file specified in the `filename` argument. Supported objects are:

- `openDRIVEImportOptions`
- `roadrunnerHDMMapImportOptions`

Import Formats	Description	Properties	
openDriveImportOptions	<p>Options for importing ASAM OpenDRIVE files into RoadRunner scene.</p> <p><code>openDriveImportOptions(Name=Value)</code> creates an import options configuration object for the ASAM OpenDRIVE format, with properties specified as one or more name-value arguments.</p> <p>If a default property value is "auto", the RoadRunner application determines what value to use and sets the property to that value.</p>	ImportObjects	<p>Map all <object> entries in the imported file to props or markings, specified as a logical 1 (true) or 0 (false).</p> <p>Default: 0</p>
		ImportHeadingOffsetRelativeToOrientation	<p>Import the <hOffset> (heading offset) values of <signal> entries as being relative to <orientation>, which is the direction of travel of the road that the signal applies to. By default, the heading offset is relative to the heading of the road, regardless of the direction of travel, specified as a logical 1 (true) or 0 (false)</p> <p>Default: auto</p>
		LaneOptions	<p>Lane import options specified as a laneImportOptions object.</p>
		Offset	<p>Offset of the imported ASAM</p>

Import Formats	Description	Properties	
			OpenDRIVE scene, relative to the center of the RoadRunner scene, specified as a three-element vector of form [x y z]. Values are in meters.
		Projection	Projection of the imported ASAM OpenDRIVE scene, specified as a projectionImportOptions. If the file does not have projection information, then RoadRunner uses the projection of the scene. If both the scene and the file do not have projection information, then RoadRunner uses the Transverse Mercator projection centered at 0 degrees latitude and longitude.
		ImportSignals	Map all <signal> entries in the imported file to signals or signs, specified as a logical 1

Import Formats	Description	Properties	
			(true) or 0 (false). Default: "auto"
		ProjectionMode	Projection mode, specified as : "Unspecified", "FullProjection", "TranslateOnly", "NoProjection".
		Example: options = openDriveImportOptions(ImportSignals=true);	

Import Formats	Description	Properties	
laneImportOptions	<p>laneImportOptions (Name=Value) creates an options configuration object, with properties specified as one or more name-value arguments.</p> <p>If a default property value is "auto", the RoadRunner application determines what value to use and sets the property to that value.</p>	ConvertShoulderToCurb	<p>Specify this property as logical 1 (true) to import lanes with "curb" markings and type "shoulder" as type "curb" if this option is enabled. Otherwise, the function imports these lanes as type "shoulder", specified as a logical 1 (true) or 0 (false)</p> <p>Default: "auto"</p>
		ConvertLaneHeights	<p>Map all <height> entries to imported lanes, specified as a logical 1 (true) or 0 (false)</p> <p>Default: "auto"</p>
		MedianLaneType	<p>Map all <lane> types as "median" or "raised median", specified as: "Unspecified", "Median", "RaisedMedian".</p> <p>Default: "auto"</p>

Import Formats	Description	Properties	
		<p>Example:</p> <pre>options = laneImportOptions(Median LaneType="RaisedMedian") ; creates a lane import options object that maps all lanes as a raised median lane type.</pre>	
projectionImportOptions	<p>projectionImportOptions(Name=Value) creates an options configuration object for a map projection with properties specified as one or more name-value arguments.</p> <p>If a default property value is "auto", the RoadRunner application determines what value to use and sets the property to that value.</p>	<p>Projection</p>	<p>Geospatial projection and datum used to represent spatial coordinates in the map. This property supports valid WKT (including ESRI WKT) or PROJ.4 projection strings. Specified as a string scalar or character vector.</p> <p>Default: "auto"</p>
		<p>Example:</p> <pre>options = projectionImportOptions(Projection="utm +zone=11 +datum=WGS84 + units=m +no_defs +ellps=WGS84 +towgs84=0,0,"); creates projection a projection import options object that uses a PROJ.4 projection string.</pre>	

Import Formats	Description	Properties	
<p>roadrunnerHDMapImportOptions</p>	<p>Options for importing RoadRunner HD Map files into RoadRunner scene.</p> <p>roadrunnerHDMapImportOptions(Name=Value) creates an import options configuration object for the RoadRunner HD Map format with properties specified as one or more name-value arguments.</p> <p>If a default property value is "auto", the RoadRunner application determines what value to use and sets the property to that value.</p>	<p>ImportStep</p>	<p>Import step, specified as one of the following strings: "Unspecified" or "Load".</p> <p>Default: "auto"</p>
		<p>LoadOptions</p>	<p>Load options, specified as roadrunnerHDMapLoadOptions.</p> <p>Default: "auto"</p>
		<p>BuildOptions</p>	<p>Load options, specified as roadrunnerHDMapBuildOptions.</p> <p>Default: "auto"</p>
		<p>Example:</p> <pre>options = roadrunnerHDMapImportOptions(ImportStep="Load"); creates a RoadRunner HD map import options that loads the map.</pre>	

Import Formats	Description	Properties	
roadrunnerHDMapLoadOptions	<p>Options for loading RoadRunner HD Map files into RoadRunner scene.</p> <p>roadrunnerHDMapLoadOptions (Name=Value) creates an options configuration object for loading the RoadRunner HD Map format with properties specified as one or more name-value arguments.</p> <p>If a default property value is "auto", the RoadRunner application determines what value to use and sets the property to that value.</p>	Offset	Offset of the imported HD map, relative to the center of the RoadRunner scene, specified as a 3-element vector.
		Projection	Projection of the imported HD map scene, specified as a projectionImportOptions. If the projection is not set, then RoadRunner uses the file's projection. If the file does not have projection information, then RoadRunner uses the projection of the scene. If both the scene and the file do not have projection information, then RoadRunner uses the Transverse Mercator projection centered at 0 degrees latitude and longitude.
		Example:	

Import Formats	Description	Properties
		options = roadrunnerHDMapLoadOptions(Offset=[0 10 0]); creates a RoadRunner HD map load options with the specified offset.

Import Formats	Description	Properties	
roadrunnerHDMaPBuildOptions	<p>Options for building RoadRunner HD Map files into RoadRunner scene.</p> <p>roadrunnerHDMaPBuildOptions (Name=Value) creates an options configuration object for building the RoadRunner HD Map format with properties specified as one or more name-value arguments.</p> <p>If a default property value is "auto", the RoadRunner application determines what value to use and sets the property to that value.</p>	FitCrossSections	Fit cross sections, specified as a logical 1 (true) or 0 (false) . Default: "auto"
		DetectAsphaltSurfaces	Detect asphalt surfaces, specified as a logical 1 (true) or 0 (false) . Default: "auto"
		ClearSceneOfExistingData	Clear the scene of existing data , specified as a logical 1 (true) or 0 (false) . Default: "auto"
		CurvatureBlend	Position of fit arcs used from transition from line to arc, specified as a scalar double value. Default: "auto"
		AutoDetectBridgesOptions	Options to auto detect bridges, specified as a autoDetectBridgesOptions. Default: "auto"
		Example:	

Import Formats	Description	Properties				
		options = roadrunnerHDMaPBuildOptions(DetectAsphaltSurface=true); creates a RoadRunner HD map build options that detects asphalt surfaces.				
autoDetectBridgesOptions	<p>Options for auto detecting bridges.</p> <p>autoDetectBridgesOptions(Name=Value) creates an options configuration object for auto detecting bridges when building the RoadRunner HD Map. Properties specified as one or more name-value arguments.</p> <p>If a default property value is "auto", the RoadRunner application determines what value to use and sets the property to that value.</p>	<table border="1"> <tr> <td>BridgeSpanInflation</td> <td>Length of the bridge span specified as a scalar double value.</td> </tr> <tr> <td colspan="2">Default: "auto"</td> </tr> </table> <p>Example:</p> <p>options = autoDetectBridgesOptions(BridgeSpanInflation=35); creates options that set bridge span inflation.</p>	BridgeSpanInflation	Length of the bridge span specified as a scalar double value.	Default: "auto"	
BridgeSpanInflation	Length of the bridge span specified as a scalar double value.					
Default: "auto"						

Version History

Introduced in R2022a

See Also

roadrunner | openScene | exportScene | close

Topics

"Export Multiple Scenes Using MATLAB"

"Convert Scenes Between Formats Using MATLAB Functions"

newProject

Create new RoadRunner project using MATLAB

Syntax

```
newProject(rrApp,projectFolder)
newProject(rrApp,projectFolder,Name=Value)
```

Description

`newProject(rrApp,projectFolder)` creates a new RoadRunner project folder in the location specified by `projectFolder`. RoadRunner creates the specified folder, also attempting to create any folders in the specified file path that do not already exist. If a folder with the same name already exists in the specified location, then RoadRunner returns an error.

`newProject(rrApp,projectFolder,Name=Value)` sets options using one or more name-value arguments.

Examples

Create New RoadRunner Project

Open a project in RoadRunner using the `roadrunner` function by specifying the location in which to create a project. This example assumes that RoadRunner is installed in its default location in Windows.

Specify the path to an existing project. For example, this code shows the path to a project located on `C:\RR\MyProject`. The function returns a `roadrunner` object, `rrApp`, that provides functions for performing basic workflow tasks such as opening, closing, and saving scenes and projects.

```
projectFolder = "C:\RR\MyProject";
rrApp = roadrunner(projectFolder,InstallationFolder='C:\Program Files\RoadRunner R2023a\bin\win64');
```

Specify a location for a new project folder. Use the `newProject` function to create a new RoadRunner project in the specified location. The name of the project folder determines the name of the new project.

```
newProjectFolder = "C:\My New Project";
newProject(rrApp,newProjectFolder);
```

Input Arguments

rrApp — RoadRunner application

`roadrunner` object

RoadRunner application associated with a project, specified as a `roadrunner` object. This object provides functions for performing common workflow tasks such as opening, closing, and saving

scenes and projects. `rrApp` provides functions that support importing data from files and exporting scenes to other formats from RoadRunner.

projectFolder — RoadRunner project folder path

character vector | string scalar

RoadRunner project folder path, specified as a character vector or string scalar. Use this argument to specify the project folder in which to create a new scene when opening RoadRunner. For details about the RoadRunner project folder structure, see “RoadRunner Project and Scene System” (RoadRunner).

Example: `roadrunner("C:\My New Project")` specifies to create a new scene in the `My New Project` folder when opening RoadRunner on a Windows machine.

Data Types: `char` | `string`

Name-Value Pair Arguments

Example: `newProject(rrApp,"C:\RR\nMyProject",AssetLibraries="RoadRunner_Asset_Library")`

Specify optional pairs of arguments as `Name1=Value1, ..., NameN=ValueN`, where `Name` is the argument name and `Value` is the corresponding value. Name-value arguments must appear after other arguments, but the order of the pairs does not matter.

AssetLibraries — RoadRunner asset libraries

character vector | string scalar

RoadRunner asset libraries to include in the new project, specified as a character vector or string scalar. The only valid entry is `"RoadRunner_Asset_Library"`, which includes the RoadRunner Asset Library assets in the project. If you do not specify `AssetLibraries`, then RoadRunner includes only the assets that come installed with RoadRunner projects by default.

Data Types: `char` | `string`

Version History

Introduced in R2022a

See Also

`roadrunner` | `openProject` | `saveProject`

Topics

“Export Multiple Scenes Using MATLAB”

“Convert Scenes Between Formats Using MATLAB Functions”

newScenario

Create new scenario in RoadRunner Scenario using MATLAB

Syntax

```
newScenario(rrApp)
```

Description

`newScenario(rrApp)` creates a new scenario in the current RoadRunner scene. You must create or load a new scene before creating a new scenario.

Examples

Create New RoadRunner Scenario

Create a new scenario in RoadRunner Scenario using MATLAB.

Start RoadRunner and open the project called "C:\RR\MyProject". Return the RoadRunner application object in `rrApp`. This example assumes that RoadRunner is installed in its default location in Windows. This call returns an object `rrApp` that provides functions for performing basic workflow tasks such as opening, closing, and saving scenes and projects.

```
projectFolder = "C:\RR\MyProject";  
rrApp = roadrunner(projectFolder);
```

Open an existing scene in RoadRunner. For example, open the `FourWaySignal` scene, which is one of the scenes included by default in RoadRunner projects.

```
filename = "FourWaySignal.rrscene";  
openScene(rrApp, filename);
```

Create a new, empty scenario in the scene using the `newScenario` function.

```
newScenario(rrApp);
```

Input Arguments

rrApp — RoadRunner application

roadrunner object

RoadRunner application associated with a project, specified as a `roadrunner` object. This object provides functions for performing common workflow tasks such as opening, closing, and saving scenes and projects. `rrApp` provides functions that support importing data from files and exporting scenes to other formats from RoadRunner.

Version History

Introduced in R2022a

See Also

roadrunner | openScenario | saveScenario | openScene | close

Topics

“RoadRunner Scenario Fundamentals” (RoadRunner Scenario)

“Simulate a RoadRunner Scenario Using MATLAB Functions”

newScene

Create new RoadRunner scene using MATLAB

Syntax

```
newScene(rrApp)
```

Description

`newScene(rrApp)` creates a new scene in the current RoadRunner project.

Examples

Create New Scene

Open a project in RoadRunner using the `roadrunner` function by specifying the location in which to create a project. This example assumes that RoadRunner is installed in its default location in Windows.

Specify the path to an existing project. For example, this code shows the path to a project located on `C:\RR\MyProject`. The function returns a `roadrunner` object, `rrApp`, that provides functions for performing basic workflow tasks such as opening, closing, and saving scenes and projects.

```
projectFolder = "C:\RR\MyProject";  
rrApp = roadrunner(projectFolder);
```

Create an empty scene in the current project.

```
newScene(rrApp);
```

Input Arguments

rrApp — RoadRunner application

`roadrunner` object

RoadRunner application associated with a project, specified as a `roadrunner` object. This object provides functions for performing common workflow tasks such as opening, closing, and saving scenes and projects. `rrApp` provides functions that support importing data from files and exporting scenes to other formats from RoadRunner.

Version History

Introduced in R2022a

See Also

`roadrunner` | `openScene` | `saveScene`

Topics

“Export Multiple Scenes Using MATLAB”

“Convert Scenes Between Formats Using MATLAB Functions”

openProject

Open RoadRunner project using MATLAB

Syntax

```
openProject(rrApp,projectFolder)
```

Description

`openProject(rrApp,projectFolder)` opens RoadRunner to a new scene in the specified project `projectFolder`. The project must already exist. If the specified project is already open, RoadRunner still opens a new scene.

Examples

Open Project

Open a project in RoadRunner using the `roadrunner` function by specifying the location in which to create a project. This example assumes that RoadRunner is installed in its default location in Windows.

Specify the path to an existing project. For example, this code shows the path to a project located on `C:\RR\MyProject`. The function returns a `roadrunner` object, `rrApp`, that provides functions for performing basic workflow tasks such as opening, closing, and saving scenes and projects.

```
projectFolder = "C:\RR\MyProject";  
rrApp = roadrunner(projectFolder);
```

Specify a different project folder. Use the `openProject` function to create a new scene in the second RoadRunner project.

```
newProjectFolder = "C:\My New Project";  
openProject(rrApp,newProjectFolder);
```

Input Arguments

rrApp — RoadRunner application

`roadrunner` object

RoadRunner application associated with a project, specified as a `roadrunner` object. This object provides functions for performing common workflow tasks such as opening, closing, and saving scenes and projects. `rrApp` provides functions that support importing data from files and exporting scenes to other formats from RoadRunner.

projectFolder — RoadRunner project folder path

character vector | string scalar

RoadRunner project folder path, specified as a character vector or string scalar. Use this argument to specify the project folder in which to create a new scene when opening RoadRunner. For details

about the RoadRunner project folder structure, see “RoadRunner Project and Scene System” (RoadRunner).

Example: `roadrunner("C:\My New Project")` specifies to create a new scene in the My New Project folder when opening RoadRunner on a Windows machine.

Data Types: `char` | `string`

Version History

Introduced in R2022a

See Also

`roadrunner` | `newProject` | `saveProject`

Topics

“Export Multiple Scenes Using MATLAB”

“Convert Scenes Between Formats Using MATLAB Functions”

openScenario

Open scenario in RoadRunner Scenario using MATLAB

Syntax

```
openScenario(rrApp, filename)
openScenario(rrApp, filename, keepCurrentScene)
```

Description

`openScenario(rrApp, filename)` opens the specified scenario in the RoadRunner scene in which it was previously saved. If no current scene is specified in the project, MATLAB returns an error.

`openScenario(rrApp, filename, keepCurrentScene)` specifies whether to open the specified scenario in the scene it was previously saved with or in the current scene, regardless of which scene it was previously saved with.

Examples

Open Scenario

Open a scenario in RoadRunner Scenario using MATLAB.

Start RoadRunner and open the project called "C:\RR\MyProject". Return the RoadRunner application object in `rrApp`. This example assumes that RoadRunner is installed in its default location in Windows. This call returns an object `rrApp` that provides functions for performing basic workflow tasks such as opening, closing, and saving scenes and projects.

```
projectFolder = "C:\RR\MyProject";
rrApp = roadrunner(projectFolder);
```

Open an existing scenario in RoadRunner Scenario by calling the `openScenario` function and passing it the `rrApp` object and the specific scenario `filename` that you want to open. This call opens the desired scenario in the RoadRunner Scenario application through MATLAB.

```
filename = "MyScenario.rscenario";
openScenario(rrApp, filename);
```

Input Arguments

rrApp — RoadRunner application

roadrunner object

RoadRunner application associated with a project, specified as a `roadrunner` object. This object provides functions for performing common workflow tasks such as opening, closing, and saving scenes and projects. `rrApp` provides functions that support importing data from files and exporting scenes to other formats from RoadRunner.

filename — RoadRunner scenario file name

character vector | string scalar

RoadRunner scenario file name, specified as a character vector or string scalar. If you specify this argument as a relative path, then the path is relative to the `Scenarios` folder of the current project. `filename` must end with either the `.rrscenario` extension or have no extension. If it has no extension, then RoadRunner appends the `.rrscenario` extension to `filename` before opening the scenario.

Example: `openScenario(rrApp, "MyScenario.rrscenario")` opens `MyScenario.rrscenario` from the `Scenarios` folder of the current project.

Data Types: `char` | `string`**keepCurrentScene — Open scenario in current scene**`false` or `0` (default) | `true` or `1`

Open scenario in current scene, specified as a numeric or logical `0` (`false`) or `1` (`true`). If you set `keepCurrentScene` to `true` and there is no current scene, then MATLAB returns an error. If you set `keepCurrentScene` to `false`, then RoadRunner opens the scene that the scenario was previously saved with and opens the scenario into that scene.

Data Types: `logical`

Version History

Introduced in R2022a

See Also

`roadrunner` | `newScenario` | `saveScenario` | `close`

Topics

“RoadRunner Scenario Fundamentals” (RoadRunner Scenario)
“Simulate a RoadRunner Scenario Using MATLAB Functions”

openScene

Open RoadRunner scene using MATLAB

Syntax

```
openScene(rrApp, filename)
```

Description

`openScene(rrApp, filename)` opens a specified scene file from the current RoadRunner project. If the specified scene does not belong to the current project, then RoadRunner determines the project to which the scene belongs and opens the scene from that project instead.

Examples

Open Scene in Current RoadRunner Project

Open a project in RoadRunner using the `roadrunner` function by specifying the location in which to create a project. This example assumes that RoadRunner is installed in its default location in Windows.

Specify the path to an existing project. For example, this code shows the path to a project located on `C:\RR\MyProject`. The function returns a `roadrunner` object, `rrApp`, that provides functions for performing basic workflow tasks such as opening, closing, and saving scenes and projects.

```
projectFolder = "C:\RR\MyProject";  
rrApp = roadrunner(projectFolder);
```

Open an existing scene in the current RoadRunner project.

```
filename = "FourWaySignal.rrscene";  
openScene(rrApp, filename);
```

Input Arguments

rrApp — RoadRunner application

`roadrunner` object

RoadRunner application associated with a project, specified as a `roadrunner` object. This object provides functions for performing common workflow tasks such as opening, closing, and saving scenes and projects. `rrApp` provides functions that support importing data from files and exporting scenes to other formats from RoadRunner.

filename — RoadRunner scene file to open

character vector | string scalar

RoadRunner scene file to open, specified as a character vector or string scalar. This argument specifies the absolute or relative path to the scene file you want to open. If you specify a relative path,

then the path is relative to the Scenes folder of the current project. `filename` must end with `.rrscene` or have no extension. If it has no extension, then RoadRunner appends the `.rrscene` extension to the file name before opening the scene.

Example: `openScene(rrApp, "FourWaySignal.rrscene")` open the `FourWaySignal.rrscene` scene file from the Scenes folder of the current project.

Data Types: `char` | `string`

Version History

Introduced in R2022a

See Also

`roadrunner` | `newScene` | `saveScene`

Topics

“Export Multiple Scenes Using MATLAB”

“Convert Scenes Between Formats Using MATLAB Functions”

saveProject

Save RoadRunner project using MATLAB

Syntax

```
saveProject(rrApp)
```

Description

`saveProject(rrApp)` saves the currently open scene in the specified RoadRunner instance to the current project.

Examples

Save Project

Open a project in RoadRunner using the `roadrunner` function by specifying the location in which to create a project. This example assumes that RoadRunner is installed in its default location in Windows.

Specify the path to an existing project. For example, this code shows the path to a project located on `C:\RR\MyProject`. The function returns a `roadrunner` object, `rrApp`, that provides functions for performing basic workflow tasks such as opening, closing, and saving scenes and projects..

```
projectFolder = "C:\RR\MyProject";  
rrApp = roadrunner(projectFolder);
```

Import an ASAM OpenDRIVE® file into RoadRunner by using the `importScene` function.

```
filename = "C:\RR\MyProject\Exports\FourWaySignal.xodr";  
importScene(rrApp, filename, "OpenDRIVE");
```

Save the modified assets in the project by using the `saveProject` function.

```
saveProject(rrApp);
```

Input Arguments

rrApp — RoadRunner application

`roadrunner` object

RoadRunner application associated with a project, specified as a `roadrunner` object. This object provides functions for performing common workflow tasks such as opening, closing, and saving scenes and projects. `rrApp` provides functions that support importing data from files and exporting scenes to other formats from RoadRunner.

Version History

Introduced in R2022a

See Also

`roadrunner` | `newProject` | `openProject` | `importScene`

Topics

“Export Multiple Scenes Using MATLAB”

“Convert Scenes Between Formats Using MATLAB Functions”

saveScenario

Save scenario in RoadRunner Scenario using MATLAB

Syntax

```
saveScenario(rrApp)
saveScenario(rrApp, filename)
```

Description

`saveScenario(rrApp)` saves the current scenario.

`saveScenario(rrApp, filename)` saves the current scenario to the specified file `filename`. RoadRunner also saves the current scene and project.

Examples

Save Scenario

Save a scenario in RoadRunner Scenario using MATLAB.

Start RoadRunner and open the project called "C:\RR\MyProject". Return the RoadRunner application object in `rrApp`. This example assumes that RoadRunner is installed in its default location in Windows. This call returns an object `rrApp` that provides functions for performing basic workflow tasks such as opening, closing, and saving scenes and projects.

```
projectFolder = "C:\RR\MyProject";
rrApp = roadrunner(projectFolder);
```

Open an existing scenario in RoadRunner Scenario by calling the `openScenario` function and passing it the `rrApp` object and the specific scenario `filename` that you want to open. This call opens the desired scenario in the RoadRunner Scenario application through MATLAB.

```
filename = "MyScenario.rrscenario";
openScenario(rrApp, filename);
```

Save the scenario to another file. Call the `saveScenario` function and pass it the `rrApp` object and the new `filename` with which you want to save the scenario. This call saves the scenario, the current scene and the project.

```
newFilename = "MyScenario1.rrscenario";
saveScenario(rrApp, newFilename);
```

Input Arguments

rrApp — RoadRunner application

roadrunner object

RoadRunner application associated with a project, specified as a `roadrunner` object. This object provides functions for performing common workflow tasks such as opening, closing, and saving scenes and projects. `rrApp` provides functions that support importing data from files and exporting scenes to other formats from RoadRunner.

filename — RoadRunner scenario file name

character vector | string scalar

RoadRunner scenario file name, specified as a character vector or string scalar. If you specify this argument as a relative path, then the path is relative to the `Scenarios` folder of the current project. If you do not specify `filename`, then RoadRunner saves the current scenario to its existing file. If you do not have a current scenario open, then RoadRunner returns an error. RoadRunner recursively creates any folders on the specified file path that do not already exist.

`filename` must end with `.rrscenario` extension or have no extension. If it has no extension, then RoadRunner appends the `.rrscenario` extension to the file name before saving the scenario. If the file being saved already exists, then RoadRunner overwrites it.

Example: `saveScenario(rrApp, "MyScenario1.rrscenario")` saves the current open scenario to the `MyScenario1.rrscenario` file in to the `Scenarios` folder of the current project.

Data Types: `char` | `string`

Version History

Introduced in R2022a

See Also

`roadrunner` | `newScenario` | `openScenario` | `close`

Topics

“RoadRunner Scenario Fundamentals” (RoadRunner Scenario)

“Simulate a RoadRunner Scenario Using MATLAB Functions”

saveScene

Save RoadRunner scene using MATLAB

Syntax

```
saveScene(rrApp)
saveScene(rrApp, filename)
```

Description

`saveScene(rrApp)` saves any modifications to the scene currently open in the specified RoadRunner instance. If you have modified any assets in the scene, then this function also saves the current project.

`saveScene(rrApp, filename)` saves any modifications to the specified scene filename. If you have modified any assets in the scene, then this function also saves the project to which the scene belongs.

Examples

Save RoadRunner Scene

Open a project in RoadRunner using the `roadrunner` function by specifying the location in which to create a project. This example assumes that RoadRunner is installed in its default location in Windows.

Specify the path to an existing project. For example, this code shows the path to a project located on `C:\RR\MyProject`. The function returns a `roadrunner` object, `rrApp`, that provides functions for performing basic workflow tasks such as opening, closing, and saving scenes and projects.

```
projectFolder = "C:\RR\MyProject";
rrApp = roadrunner(projectFolder);
```

Open an existing scene in the current RoadRunner project.

```
filename = "FourWaySignal.rrscene";
openScene(rrApp, filename);
```

Save the RoadRunner scene to a new location.

```
newFilename = "FourWaySignal1.rrscene";
saveScene(rrApp, newFilename);
```

Input Arguments

rrApp — RoadRunner application

`roadrunner` object

RoadRunner application associated with a project, specified as a `roadrunner` object. This object provides functions for performing common workflow tasks such as opening, closing, and saving

scenes and projects. `rrApp` provides functions that support importing data from files and exporting scenes to other formats from RoadRunner.

filename — RoadRunner scene file to open

character vector | string scalar

RoadRunner scene file to open, specified as a character vector or string scalar. This argument specifies the absolute or relative path to the scene file you want to save. If you specify a relative path, then the path is relative to the Scenes folder of the current project. If you do not have a scene open, then RoadRunner returns an error. If any folders in the specified file path do not exist, then RoadRunner creates them recursively. `filename` must end with `.rrscene` or have no extension. If it has no extension, then RoadRunner appends the `.rrscene` extension to the file name before opening the scene. If the file being saved already exists, then RoadRunner overwrites it.

Example: `saveScene(rrApp,"FourWaySignal1.rrscene")` saves "FourWaySignal1.rrscene" located in the Scenes folder of the current project.

Data Types: `char` | `string`

Version History

Introduced in R2022a

See Also

`roadrunner` | `newScene` | `openScene`

Topics

"Export Multiple Scenes Using MATLAB"

"Convert Scenes Between Formats Using MATLAB Functions"

setScenarioVariable

Set RoadRunner scenario variable using MATLAB

Syntax

```
setScenarioVariable(rrApp,name,value)
```

Description

`setScenarioVariable(rrApp,name,value)` sets a specified variable in the current scenario to the specified value.

Examples

Set Scenario Variable

Set a scenario variable in RoadRunner Scenario using MATLAB.

Call the `roadrunner` function and pass in the location where you want to create the project. This example assumes that RoadRunner is installed in its default location in Windows.

Specify the path to an existing project. For example, this code shows the path to a project located at "C:\RR\MyProject". This call returns an object `rrApp` that provides functions for performing basic workflow tasks such as opening, closing, and saving scenes and projects

```
projectFolder = "C:\RR\MyProject";  
rrApp = roadrunner(projectFolder);
```

Open an existing scenario in RoadRunner Scenario by calling the `openScenario` function and passing it the `rrApp` object and the specific scenario filename that you want to open. This call opens the desired scenario in the RoadRunner Scenario application through MATLAB.

```
filename = "MyScenario.rrscenario";  
openScenario(rrApp,filename);
```

Set the value of a scenario variable. Call the `setScenarioVariable` function and pass it the `rrApp` object, the variable whose value you want to set, and the value that you want to assign to the variable. For example, this call assigns a value of 17.88 as the initial speed of the Ambulance in the scenario, `MyScenario`.

```
name = "Ambulance_InitialSpeed";  
value = "17.88";  
setScenarioVariable(rrApp,name,value);
```

Input Arguments

rrApp — RoadRunner application

roadrunner object

RoadRunner application associated with a project, specified as a `roadrunner` object. This object provides functions for performing common workflow tasks such as opening, closing, and saving scenes and projects. `rrApp` provides functions that support importing data from files and exporting scenes to other formats from RoadRunner.

name — Name of variable to set

character vector | string scalar

Name of variable to set, specified as a character vector or string scalar. If the specified variable does not exist in the scenario, it results in an error. For more details on creating variables in a scenario, see “Generate Scenario Variations” (RoadRunner Scenario).

Example: `setScenarioVariable(rrApp,"Ambulance_InitialSpeed","17.88");` sets the initial speed of the Ambulance vehicle.

value — Value assigned to variable

character vector | string scalar

Value assigned to variable, specified as a character vector or string scalar. This argument specifies the new value to assign to the variable. Even if the variable value is numeric, you must specify `value` as a character vector or string scalar.

Example: `setScenarioVariable(rrApp,"Ambulance_InitialSpeed","17.88");` sets the initial speed of the Ambulance to 17.88 m/s.

Version History

Introduced in R2022a

See Also

`roadrunner` | `getScenarioVariable` | `close`

Topics

“RoadRunner Scenario Fundamentals” (RoadRunner Scenario)
“Simulate a RoadRunner Scenario Using MATLAB Functions”

status

Get current status of RoadRunner using MATLAB

Syntax

```
rrStatus = status(rrApp)
```

Description

`rrStatus = status(rrApp)` gets the status of the RoadRunner application. The function returns the project, the scene or scenario that is currently loaded and any unsaved changes in the project, scene, or scenario.

Examples

Retrieve Status of RoadRunner Application

Get the status of RoadRunner application.

Open a project in RoadRunner using the `roadrunner` function by specifying the location in which to create a project. This example assumes that RoadRunner is installed in its default location in Windows.

Specify the path to an existing project. For example, this code shows the path to a project located on `C:\RR\MyProject`. The function returns a `roadrunner` object, `rrApp`, that provides functions for performing basic workflow tasks such as opening, closing, and saving scenes and projects.

```
projectFolder = "C:\RR\MyProject";
rrApp = roadrunner(projectFolder, InstallationFolder='C:\Program Files\RoadRunner R2022b\bin\win
```

Open an existing scenario in RoadRunner Scenario by calling the `openScenario` function and passing it the `rrApp` object and the specific scenario filename that you want to open. This call opens the desired scenario in the RoadRunner Scenario application through MATLAB.

```
filename = "TrajectoryCutIn.rrscenario";
openScenario(rrApp, filename);
```

Get the status of the RoadRunner application by calling the `status` function and passing it the `rrApp` object. This call returns the current project, scenario and any unsaved changes in the project.

```
rrStatus = status(rrApp)

rrStatus = struct with fields:
    Project: [1x1 struct]
    Scene: [1x1 struct]
    Scenario: [1x1 struct]
```

View project, scene and scenario details from the status of the RoadRunner application.

```
rrStatus.Project
```

```
ans = struct with fields:
  UnsavedChanges: 0
  Filename: 'C:/RR/MyProject'
```

`rrStatus.Scene`

```
ans = struct with fields:
  UnsavedChanges: 1
  Filename: 'C:/RR/MyProject/Scenes/ScenarioBasic.rrscene'
```

`rrStatus.Scenario`

```
ans = struct with fields:
  UnsavedChanges: 0
  Filename: 'C:/RR/MyProject/Scenarios/TrajectoryCutIn.rrscenario'
```

Input Arguments

`rrApp` — RoadRunner application

roadrunner object

RoadRunner application associated with a project, specified as a `roadrunner` object. This object provides functions for performing common workflow tasks such as opening, closing, and saving scenes and projects. `rrApp` provides functions that support importing data from files and exporting scenes to other formats from RoadRunner.

Output Arguments

`rrStatus` — Status of RoadRunner application

struct

Status of the RoadRunner application, specified as a struct. The function returns the project, the scene or scenario that is currently loaded and any unsaved changes in the project.

Tips

- RoadRunner makes changes automatically to the scene or scenario in the following cases:
 - When you switch to **Scenario Editing**, RoadRunner quantizes the road network to eliminate small roads and lanes.
 - When you load a scene or a scenario from a previous release, RoadRunner updates the internal data.

In these cases, you will see unsaved changes in the response output of the `status` function call, despite having made no changes to the scene or scenario.

Version History

Introduced in R2022b

See Also

roadrunner | newProject | newScene | newScenario

Topics

“RoadRunner Project and Scene System” (RoadRunner)

“RoadRunner Scenario Fundamentals” (RoadRunner Scenario)

“Export Multiple Scenes Using MATLAB”

“Convert Scenes Between Formats Using MATLAB Functions”

remapAnchor

Remap road anchor in RoadRunner Scenario in MATLAB

Syntax

```
remapAnchor(rrApp, source, target)  
remapAnchor(rrApp, source, target, NewAnchorName=newName)
```

Description

`remapAnchor(rrApp, source, target)` remaps dependencies from a source anchor in the scenario to a different target road anchor. You can specify the name of the source anchor and the name or position of the target anchor.

`remapAnchor(rrApp, source, target, NewAnchorName=newName)` also sets the name of the target anchor when the target is specified as a position.

Examples

Remap Anchors in a Scenario

Remap road anchor to a target anchor

Open a project in RoadRunner using the `roadrunner` function by specifying the location in which to create a project. This example assumes that RoadRunner is installed in its default location in Windows.

Specify the path to an existing project. For example, this code shows the path to a project located on `C:\RR\MyProject`. The function returns a `roadrunner` object, `rrApp`, that provides functions for performing basic workflow tasks such as opening, closing, and saving scenes and projects.

```
projectFolder = "C:\RR\MyProject";  
rrApp = roadrunner(projectFolder, InstallationFolder='C:\Program Files\RoadRunner R2022b\bin\win
```

Open an existing scenario in RoadRunner Scenario by calling the `openScenario` function and passing it the `rrApp` object and the specific scenario filename that you want to open. This call opens the desired scenario in the RoadRunner Scenario application through MATLAB.

```
filename = "TrajectoryCutIn.rrscenario";  
openScenario(rrApp, filename);
```

Remap the source anchor to the target anchor by calling the `remapAnchor` function and passing it the `rrApp` object and the source anchor name, the target anchor name and the new anchor name.

```
remapAnchor(rrApp, "ScenarioStart", [-20 0 0], NewAnchorName="anchor3");
```

Input Arguments

rrApp — RoadRunner application

roadrunner object

RoadRunner application associated with a project, specified as a roadrunner object. This object provides functions for performing common workflow tasks such as opening, closing, and saving scenes and projects. rrApp provides functions that support importing data from files and exporting scenes to other formats from RoadRunner.

source — Source anchor in scenario

character vector | string scalar

Source anchor in scenario, specified as a character vector or string scalar.

target — Target anchor in scenario

character vector | string scalar | three-element numeric vector

Target anchor in scenario, specified as one of these values.

- A character vector or string scalar indicating the name of the target anchor. A name remap searches for a road anchor with matching name in the scenario and scene.
- A three-element numeric vector indicating the position of the target anchor relative to the center of the scene. A position remap creates a new road anchor on the road closest to the provided position. The distance between this position and the closest road in the scene must be greater than 25 meters.

newName — New anchor name for position remap

"" (default) | character vector | string scalar

New anchor name for a position remap, specified as a character vector or string scalar. If the value is not specified, the remapAnchor function uses the default value.

Version History

Introduced in R2022b

See Also

roadrunner | getScenarioVariable

Topics

“RoadRunner Scenario Fundamentals” (RoadRunner Scenario)

“Simulate a RoadRunner Scenario Using MATLAB Functions”

roadrunner.hdmap.AlignedReference

Provided information for linking objects in RoadRunner HD Maps using MATLAB

Description

The `roadrunner.hdmap.AlignedReference` object enables you to specify information for linking objects in RoadRunner HD Maps. This information is used to specify lane navigation. You can link a lane with lane boundaries and other lane. To specify the alignment between linked objects, you must follow these rules:

- Alignment must always be relative to the orientation of the object of interest.
- When the directions of two objects match, the alignment is forward. Otherwise, the alignment is backward.

Creation

Syntax

```
alref = roadrunner.hdmap.AlignedReference()  
alref = roadrunner.hdmap.AlignedReference(Name=Value)
```

Description

`alref = roadrunner.hdmap.AlignedReference()` creates an empty aligned reference.

`alref = roadrunner.hdmap.AlignedReference(Name=Value)` sets the properties of the aligned reference using name-value pairs.

Properties

Reference — ID of referenced object

`roadrunner.hdmap.Reference` object

ID of the referenced object, specified as a `roadrunner.hdmap.Reference` object.

Example: `ref= roadrunner.hdmap.Reference(ID="Lane2")` creates a referenced object with id Lane2.

Alignment — Type of alignment

character vector | string scalar

Type of alignment between linked objects, specified as a character vector or string scalar. The type of alignment is specified as one of the following strings: "Unspecified", "Forward", or "Backward".

Example: `alref= roadrunner.hdmap.AlignedReference(Reference=ref, Alignment="Forward")` creates the aligned reference for Lane2 with "Forward" alignment.

Data Types: `char` | `string`

Examples

Add Lane with Aligned Reference to RoadRunner HD Map

Create an empty RoadRunner HD Map by calling the `roadrunnerHDMAP` object.

```
rrMap = roadrunnerHDMAP()
rrMap =
  roadrunnerHDMAP with properties:
      Author: ""
      Projection: ""
      GeographicBoundary: [0x3 double]
      Lanes: [0x1 roadrunner.hdmap.Lane]
      LaneBoundaries: [0x1 roadrunner.hdmap.LaneBoundary]
      LaneGroups: [0x1 roadrunner.hdmap.LaneGroup]
      LaneMarkings: [0x1 roadrunner.hdmap.LaneMarking]
      Junctions: [0x1 roadrunner.hdmap.Junction]
      BarrierTypes: [0x1 roadrunner.hdmap.BarrierType]
      Barriers: [0x1 roadrunner.hdmap.Barrier]
      SignTypes: [0x1 roadrunner.hdmap.SignType]
      Signs: [0x1 roadrunner.hdmap.Sign]
```

Create the road lane using the `roadrunner.hdmap.Lane` object. Specify the lane information for the lane id, coordinates defining the lane geometry, driving direction, and lane type.

```
rLane = roadrunner.hdmap.Lane(ID="Lane1",Geometry=[-0.782 -1.56;50.78 23.43],TravelDirection="Forward")
rLane =
  Lane with properties:
      ID: "Lane1"
      Geometry: [2x2 double]
      TravelDirection: Forward
      LeftLaneBoundary: [0x0 roadrunner.hdmap.AlignedReference]
      RightLaneBoundary: [0x0 roadrunner.hdmap.AlignedReference]
      Predecessors: [0x1 roadrunner.hdmap.AlignedReference]
      Successors: [0x1 roadrunner.hdmap.AlignedReference]
      LaneType: Driving
```

Create an aligned reference to `Lane1` using the `roadrunner.hdmap.AlignedReference` object. For this example, specify the type of alignment as `Forward`.

```
ref = roadrunner.hdmap.Reference(ID="Lane1")
ref =
  Reference with properties:
      ID: "Lane1"

alref = roadrunner.hdmap.AlignedReference(Reference=ref,Alignment="Forward")
alref =
  AlignedReference with properties:
```

Reference: [1×1 roadrunner.hdmap.Reference]
Alignment: Forward

Version History

Introduced in R2022b

See Also

roadrunnerHDMMap | roadrunner.hdmap.Lane | roadrunner.hdmap.Reference

Topics

“Build Simple Roads Programmatically Using RoadRunner HD Map” (RoadRunner)

“Build Scenes from Custom Data Using RoadRunner HD Map” (RoadRunner)

roadrunner.hdmap.Barrier

Create barrier in RoadRunner HD Map using MATLAB

Description

A `roadrunner.hdmap.Barrier` object enables you to define the structure for representing barriers in a RoadRunner HD Map scene model.

Creation

Syntax

```
aBarrier = roadrunner.hdmap.Barrier()  
aBarrier = roadrunner.hdmap.Barrier(Name=Value)
```

Description

`aBarrier = roadrunner.hdmap.Barrier()` creates an empty barrier.

`aBarrier = roadrunner.hdmap.Barrier(Name=Value)` sets the properties of the barrier using name-value pairs.

Properties

ID — ID of barrier element

character vector | string scalar

ID of the barrier element, specified as a character vector or string scalar.

Example: `rrMap.Barriers = roadrunner.hdmap.Barrier(ID="Barrier1")` creates a barrier with id `Lane1` in a RoadRunner HD Map.

Data Types: `char` | `string`

Geometry — Base of barrier that extrusion is repeated over

three element vector

Base of barrier that extrusion is repeated over, specified as a three element vector, with double precision values.

Data Types: `double`

BarrierTypeReference — Type of barrier

`roadrunner.hdmap.Reference` object

Type of barrier, specified as a `roadrunner.hdmap.Reference` object.

FlipLaterally — Set flip barrier orientation

`true` or `1` | `false` or `0`

Set flip barrier orientation, specified as `logical 0 (false)` or `logical 1 (true)`. Set this field to `logical 1 (true)` to flip the orientation of barrier along the lateral direction. Use this field to flip the primary face of the extrusion geometry, such as the guard rails shown in these images.

Examples

Add Barrier to RoadRunner HD Map

Create an empty RoadRunner HD Map by calling the `roadrunnerHDMMap` object.

```
rrMap = roadrunnerHDMMap()

rrMap =
  roadrunnerHDMMap with properties:

    Author: ""
    Projection: ""
    GeographicBoundary: [0x3 double]
    Lanes: [0x1 roadrunner.hdmap.Lane]
    LaneBoundaries: [0x1 roadrunner.hdmap.LaneBoundary]
    LaneGroups: [0x1 roadrunner.hdmap.LaneGroup]
    LaneMarkings: [0x1 roadrunner.hdmap.LaneMarking]
    Junctions: [0x1 roadrunner.hdmap.Junction]
    BarrierTypes: [0x1 roadrunner.hdmap.BarrierType]
    Barriers: [0x1 roadrunner.hdmap.Barrier]
    SignTypes: [0x1 roadrunner.hdmap.SignType]
    Signs: [0x1 roadrunner.hdmap.Sign]
```

Create the barrier using the `roadrunner.hdmap.Barrier` object. Specify the barrier information for the barrier id.

```
rrMap.Barriers = roadrunner.hdmap.Barrier(ID="Barrier1")

rrMap =
  roadrunnerHDMMap with properties:

    Author: ""
    Projection: ""
    GeographicBoundary: [0x3 double]
    Lanes: [0x1 roadrunner.hdmap.Lane]
    LaneBoundaries: [0x1 roadrunner.hdmap.LaneBoundary]
    LaneGroups: [0x1 roadrunner.hdmap.LaneGroup]
    LaneMarkings: [0x1 roadrunner.hdmap.LaneMarking]
    Junctions: [0x1 roadrunner.hdmap.Junction]
    BarrierTypes: [0x1 roadrunner.hdmap.BarrierType]
    Barriers: [1x1 roadrunner.hdmap.Barrier]
    SignTypes: [0x1 roadrunner.hdmap.SignType]
    Signs: [0x1 roadrunner.hdmap.Sign]
```

Version History

Introduced in R2022b

See Also

roadrunnerHDMAP | roadrunner.hdmap.BarrierType

Topics

“Build Simple Roads Programmatically Using RoadRunner HD Map” (RoadRunner)

“Build Scenes from Custom Data Using RoadRunner HD Map” (RoadRunner)

roadrunner.hdmap.BarrierType

Create barrier types in RoadRunner HD Map using MATLAB

Description

A `roadrunner.hdmap.BarrierType` object enables you to define the barrier extrusion and the type information for a barrier in a RoadRunner HD Map scene model.

Creation

Syntax

```
aBarrierType = roadrunner.hdmap.BarrierType()  
aBarrierType = roadrunner.hdmap.BarrierType(Name=Value)
```

Description

`aBarrierType = roadrunner.hdmap.BarrierType()` creates an empty barrier type.

`aBarrierType = roadrunner.hdmap.BarrierType(Name=Value)` sets the properties of the barrier type using name-value pairs.

Properties

ID — ID of barrier type

character vector | string scalar

ID of the barrier type, specified as a character vector or string scalar. The `Barrier` object refers to this field to describe a barrier based on its extruded geometry.

Data Types: `char` | `string`

ExtrusionPath — Relative path for extrusion asset that defines type of barrier

`roadrunner.hdmap.RelativeAssetPath` object

Relative path for extrusion asset that defines type of barrier, specified as a `roadrunner.hdmap.RelativeAssetPath` object. The asset path points to the extrusion information of this barrier type.

Examples

Add Barrier Type to RoadRunner HD Map

Create an empty RoadRunner HD Map by calling the `roadrunnerHDMAP` object.

```
rrMap = roadrunnerHDMAP()
```

```

rrMap =
  roadrunnerHDMAP with properties:
    Author: ""
    GeoReference: [0 0]
    GeographicBoundary: [0x3 double]
    Lanes: [0x1 roadrunner.hdmap.Lane]
    LaneBoundaries: [0x1 roadrunner.hdmap.LaneBoundary]
    LaneGroups: [0x1 roadrunner.hdmap.LaneGroup]
    LaneMarkings: [0x1 roadrunner.hdmap.LaneMarking]
    Junctions: [0x1 roadrunner.hdmap.Junction]
    BarrierTypes: [0x1 roadrunner.hdmap.BarrierType]
    Barriers: [0x1 roadrunner.hdmap.Barrier]
    SignTypes: [0x1 roadrunner.hdmap.SignType]
    Signs: [0x1 roadrunner.hdmap.Sign]
    StaticObjectTypes: [0x1 roadrunner.hdmap.StaticObjectType]
    StaticObjects: [0x1 roadrunner.hdmap.StaticObject]

```

Create a extrusion path to an asset. In this example, create a relative path to a `constantSlopeBarrier` asset file. This path is relative to the Assets folder of your RoadRunner project

```
path = roadrunner.hdmap.RelativeAssetPath(AssetPath="/Assets/Extrusions/ConstantSlopeBarrier.rrect")
```

```

path =
  RelativeAssetPath with properties:
    AssetPath: "/Assets/Extrusions/ConstantSlopeBarrier.rrect"

```

Create the barrier type using the `roadrunner.hdmap.BarrierType` object. Specify the barrier type information for the barrier type id and the extrusion path.

```
rrMap.BarrierTypes = roadrunner.hdmap.BarrierType(ID="BarrierType1", ExtrusionPath=path)
```

```

rrMap =
  roadrunnerHDMAP with properties:
    Author: ""
    GeoReference: [0 0]
    GeographicBoundary: [0x3 double]
    Lanes: [0x1 roadrunner.hdmap.Lane]
    LaneBoundaries: [0x1 roadrunner.hdmap.LaneBoundary]
    LaneGroups: [0x1 roadrunner.hdmap.LaneGroup]
    LaneMarkings: [0x1 roadrunner.hdmap.LaneMarking]
    Junctions: [0x1 roadrunner.hdmap.Junction]
    BarrierTypes: [1x1 roadrunner.hdmap.BarrierType]
    Barriers: [0x1 roadrunner.hdmap.Barrier]
    SignTypes: [0x1 roadrunner.hdmap.SignType]
    Signs: [0x1 roadrunner.hdmap.Sign]
    StaticObjectTypes: [0x1 roadrunner.hdmap.StaticObjectType]
    StaticObjects: [0x1 roadrunner.hdmap.StaticObject]

```

Version History

Introduced in R2022b

See Also

roadrunnerHDMMap | `roadrunner.hdmap.Barrier`

Topics

"Build Simple Roads Programmatically Using RoadRunner HD Map" (RoadRunner)

"Build Scenes from Custom Data Using RoadRunner HD Map" (RoadRunner)

roadrunner.hdmap.Junction

Create junctions in RoadRunner HD Map using MATLAB

Description

A `roadrunner.hdmap.Junction` object enables you to define the structure for representing junctions in a RoadRunner HD Map scene model. Junctions represent a logical grouping of a set of lanes, typically involving a crossing (or convergence or divergence) between multiple roadways. Use this object to define the geometry and connectivity of lanes at a crossing between multiple roadways.

Creation

Syntax

```
aJunction = roadrunner.hdmap.Junction()  
aJunction = roadrunner.hdmap.Junction(Name=Value)
```

Description

`aJunction = roadrunner.hdmap.Junction()` creates an empty lane junction.

`aJunction = roadrunner.hdmap.Junction(Name=Value)` sets the properties of the junction using name-value pairs.

Properties

ID — ID of junction

character vector | string scalar

ID of the junction, specified as a character vector or string scalar.

Example: `rrMap.Junctions = roadrunner.hdmap.Junction(ID="Junction1")` creates a junction with id `Junction1` in a RoadRunner HD Map.

Data Types: `char` | `string`

Geometry — Geometry of junction object

matrix

Geometry of the junction object, specified as a matrix, with double precision values. The geometry of the junction object is represented by a set of non-overlapping polygons. The non-overlapping set can include polygons within holes of another polygon. A polygon has one exterior boundary, but it can have multiple holes within it. The matrix contains three-element vectors representing the polygons. For each polygon, the first vector contains the coordinates for the outer boundary of the polygon. The second vector contains the coordinates for the boundaries of holes within the polygon.

Data Types: `double`

Lanes — ID of connecting lanes

array of `roadrunner.hdmap.Reference` objects

ID of connecting lanes, specified as an array of `roadrunner.hdmap.Reference` objects. These lanes may connect topologically to other lanes enclosed in the junction. For example, a small roundabout (mini-circle) could be comprised of a single junction whose enclosed lanes include a ring formation.

Examples**Add Junction to RoadRunner HD Map**

Create an empty RoadRunner HD Map by calling the `roadrunnerHDMAP` object.

```
rrMap = roadrunnerHDMAP()
```

```
rrMap =  
roadrunnerHDMAP with properties:
```

```
    Author: ""  
    Projection: ""  
    GeographicBoundary: [0x3 double]  
        Lanes: [0x1 roadrunner.hdmap.Lane]  
    LaneBoundaries: [0x1 roadrunner.hdmap.LaneBoundary]  
    LaneGroups: [0x1 roadrunner.hdmap.LaneGroup]  
    LaneMarkings: [0x1 roadrunner.hdmap.LaneMarking]  
    Junctions: [0x1 roadrunner.hdmap.Junction]  
    BarrierTypes: [0x1 roadrunner.hdmap.BarrierType]  
    Barriers: [0x1 roadrunner.hdmap.Barrier]  
    SignTypes: [0x1 roadrunner.hdmap.SignType]  
    Signs: [0x1 roadrunner.hdmap.Sign]
```

Create the road lane marking using the `roadrunner.hdmap.Junction` object. Specify the junction information for the junction id.

```
rrMap.Junctions = roadrunner.hdmap.Junction(ID="Junction1")
```

```
rrMap =  
roadrunnerHDMAP with properties:
```

```
    Author: ""  
    Projection: ""  
    GeographicBoundary: [0x3 double]  
        Lanes: [0x1 roadrunner.hdmap.Lane]  
    LaneBoundaries: [0x1 roadrunner.hdmap.LaneBoundary]  
    LaneGroups: [0x1 roadrunner.hdmap.LaneGroup]  
    LaneMarkings: [0x1 roadrunner.hdmap.LaneMarking]  
    Junctions: [1x1 roadrunner.hdmap.Junction]  
    BarrierTypes: [0x1 roadrunner.hdmap.BarrierType]  
    Barriers: [0x1 roadrunner.hdmap.Barrier]  
    SignTypes: [0x1 roadrunner.hdmap.SignType]  
    Signs: [0x1 roadrunner.hdmap.Sign]
```

Version History

Introduced in R2022b

See Also

roadrunnerHDMAP | roadrunner.hdmap.Lane

Topics

"Build Simple Roads Programmatically Using RoadRunner HD Map" (RoadRunner)

"Build Scenes from Custom Data Using RoadRunner HD Map" (RoadRunner)

roadrunner.hdmap.Lane

Create lanes in RoadRunner HD Map using MATLAB

Description

A `roadrunner.hdmap.Lane` object enables you to define the structure for representing lanes in a RoadRunner HD Map scene model. You can create an empty lane in a RoadRunner HD Map and assign properties to the lane to describe its geometry, travel direction, lane boundaries, and lane type.

Creation

Syntax

```
aLane = roadrunner.hdmap.Lane()  
aLane = roadrunner.hdmap.Lane(Name=Value)
```

Description

`aLane = roadrunner.hdmap.Lane()` creates an empty lane.

`aLane = roadrunner.hdmap.Lane(Name=Value)` sets the properties of the lane using name-value pairs.

Properties

ID — ID of lane

character vector | string scalar

ID of the lane, specified as a character vector or string scalar.

Example: `rrMap.Lanes = roadrunner.hdmap.Lane(ID="Lane1")` creates a lane with id `Lane1` in a RoadRunner HD Map.

Data Types: `char` | `string`

Geometry — 3D coordinates of points representing center line of lane

three element vector

3D coordinates of points representing the center line of the lane, specified as a three element vector, with double precision values.

Example: `rrMap.Lanes(1) = roadrunner.hdmap.Lane(ID="Lane1", Geometry=[-0.782 -1.56; 50.78 23.43])` creates a lane with id `"Lane1"` and defines the coordinates for the lane geometry.

Data Types: `double`

TravelDirection — Direction of travel along the lane

character vector | string scalar

Direction of travel along the lane, specified as a character vector or string scalar. The direction of travel along the lane is specified as one of the following strings: "Unspecified", "Undirected", "Forward", "Backward", or "Bidirectional".

Example: `rrMap.Lanes(1) = roadrunner.hdmap.Lane(ID="Lane1", Geometry=[-0.782 -1.56;50.78 23.43], TravelDirection="Forward")` creates a lane with a lane id, coordinates defining lane geometry, and driving direction.

Data Types: `char` | `string`

LeftLaneBoundary — Linkage information for left boundary of lane

`roadrunner.hdmap.AlignedReference` object

Linkage information for the left boundary of the lane, specified as a `roadrunner.hdmap.AlignedReference` object.

RightLaneBoundary — Linkage information for right boundary of lane

`roadrunner.hdmap.AlignedReference` object

Linkage information for the right boundary of the lane, specified as a `roadrunner.hdmap.AlignedReference` object.

Predecessors — Linkage information for preceding lanes

`roadrunner.hdmap.AlignedReference` object

Linkage information for preceding lanes, specified as a `roadrunner.hdmap.AlignedReference` object.

Successors — Linkage information for succeeding lanes

`roadrunner.hdmap.AlignedReference` object

Linkage information for succeeding lanes, specified as a `roadrunner.hdmap.AlignedReference` object.

LaneType — Type of lane

character vector | string scalar

Type of lane, specified as a character vector or string scalar. The type of lane is specified as one of the following strings: "Unspecified", "Driving", "Shoulder", "Border", "Restricted", "Parking", "Curb", "Sidewalk", "CenterTurn" or "Biking".

Example: `rrMap.Lanes(1) = roadrunner.hdmap.Lane(ID="Lane1", Geometry=[-0.782 -1.56;50.78 23.43], LaneType="Driving", TravelDirection="Forward")` creates a lane with a lane id, coordinates defining lane geometry, lane type, and driving direction.

Data Types: `char` | `string`

Object Functions

<code>addPredecessor</code>	Add predecessor to lane in RoadRunner HD Map using MATLAB
<code>addSuccessor</code>	Add successor to lane in RoadRunner HD Map using MATLAB
<code>leftBoundary</code>	Set left boundary of lane in RoadRunner HD Map using MATLAB
<code>rightBoundary</code>	Set right boundary of lane in RoadRunner HD Map using MATLAB

Examples

Add Lane to RoadRunner HD Map

Create an empty RoadRunner HD Map by calling the `roadrunnerHDMMap` object.

```
rrMap = roadrunnerHDMMap()  
  
rrMap =  
  roadrunnerHDMMap with properties:  
  
      Author: ""  
      Projection: ""  
      GeographicBoundary: [0×3 double]  
      Lanes: [0×1 roadrunner.hdmap.Lane]  
      LaneBoundaries: [0×1 roadrunner.hdmap.LaneBoundary]  
      LaneGroups: [0×1 roadrunner.hdmap.LaneGroup]  
      LaneMarkings: [0×1 roadrunner.hdmap.LaneMarking]  
      Junctions: [0×1 roadrunner.hdmap.Junction]  
      BarrierTypes: [0×1 roadrunner.hdmap.BarrierType]  
      Barriers: [0×1 roadrunner.hdmap.Barrier]  
      SignTypes: [0×1 roadrunner.hdmap.SignType]  
      Signs: [0×1 roadrunner.hdmap.Sign]
```

Create the road lane using the `roadrunner.hdmap.Lane` object. Specify the lane information for the lane id, coordinates defining the lane geometry, driving direction, and lane type.

```
rrmap.Lane = roadrunner.hdmap.Lane(ID="Lane",Geometry=[-0.782 -1.56;50.78 23.43],TravelDirection=  
  
rrmap = struct with fields:  
  Lane: [1×1 roadrunner.hdmap.Lane]
```

Version History

Introduced in R2022b

See Also

`roadrunnerHDMMap` | `roadrunner.hdmap.LaneBoundary` | `roadrunner.hdmap.LaneGroup` | `roadrunner.hdmap.LaneMarking` | `roadrunner.hdmap.Junction`

Topics

“Build Simple Roads Programmatically Using RoadRunner HD Map” (RoadRunner)

“Build Scenes from Custom Data Using RoadRunner HD Map” (RoadRunner)

roadrunner.hdmap.LaneBoundary

Create lane boundary in RoadRunner HD Map using MATLAB

Description

A `roadrunner.hdmap.LaneBoundary` object enables you to define the border of a lane in a RoadRunner HD Map scene model. One or more lanes can optionally contain a reference to lane boundaries on either sides of the lane. Lane boundaries optionally contain definitions for parametric attributes. These attributes define the lane markings over a span. Multiple lane markings can be spanned over a lane boundary as a parametric range between [0,1] of the boundary's length.

Creation

Syntax

```
aLaneBoundary = roadrunner.hdmap.LaneBoundary()  
aLaneBoundary = roadrunner.hdmap.LaneBoundary(Name=Value)
```

Description

`aLaneBoundary = roadrunner.hdmap.LaneBoundary()` creates an empty lane boundary.

`aLaneBoundary = roadrunner.hdmap.LaneBoundary(Name=Value)` sets the properties of the lane boundary using name-value pairs.

Properties

ID — ID of lane boundary

character vector | string scalar

ID of the lane boundary, specified as a character vector or string scalar.

Example: `rrMap.LaneBoundaries = roadrunner.hdmap.LaneBoundary(ID="LaneBoundary1")` creates a lane boundary with id `Lane1Boundary` in a RoadRunner HD Map.

Data Types: `char` | `string`

Geometry — 3D coordinates of lane boundary points

three element vector

3D coordinates of the lane boundary points, specified as a three element vector, with double precision values.

Example: `rrMap.LanesBoundaries = roadrunner.hdmap.LaneBoundary(ID="LaneBoundary1", Geometry=[-0.782 -1.56;50.78 23.43])` creates a lane boundary with id `"LaneBoundary1"` and defines the coordinates for the lane boundary geometry.

Data Types: `double`

ParametricAttributes — Span-based parametric attributes to create lane markings

array of `roadrunner.hdmap.ParametricAttribution` objects

Span-based parametric attributes to create lane markings, specified as an array of `roadrunner.hdmap.ParametricAttribution` objects.

Examples**Add Lane Boundary to RoadRunner HD Map**

Create an empty RoadRunner HD Map by calling the `roadrunnerHDMMap` object.

```
rrMap = roadrunnerHDMMap()
```

```
rrMap =
  roadrunnerHDMMap with properties:
```

```

    Author: ""
    Projection: ""
    GeographicBoundary: [0×3 double]
        Lanes: [0×1 roadrunner.hdmap.Lane]
    LaneBoundaries: [0×1 roadrunner.hdmap.LaneBoundary]
        LaneGroups: [0×1 roadrunner.hdmap.LaneGroup]
    LaneMarkings: [0×1 roadrunner.hdmap.LaneMarking]
        Junctions: [0×1 roadrunner.hdmap.Junction]
    BarrierTypes: [0×1 roadrunner.hdmap.BarrierType]
        Barriers: [0×1 roadrunner.hdmap.Barrier]
    SignTypes: [0×1 roadrunner.hdmap.SignType]
        Signs: [0×1 roadrunner.hdmap.Sign]
```

Create the road lane boundary using the `roadrunner.hdmap.LaneBoundary` object. Specify the lane information for the lane id and coordinates defining the lane geometry.

```
rrMap.LaneBoundaries = roadrunner.hdmap.LaneBoundary(ID="LaneBoundary1", Geometry=[50 25; 100 50])
```

```
rrMap =
  roadrunnerHDMMap with properties:
```

```

    Author: ""
    Projection: ""
    GeographicBoundary: [0×3 double]
        Lanes: [0×1 roadrunner.hdmap.Lane]
    LaneBoundaries: [1×1 roadrunner.hdmap.LaneBoundary]
        LaneGroups: [0×1 roadrunner.hdmap.LaneGroup]
    LaneMarkings: [0×1 roadrunner.hdmap.LaneMarking]
        Junctions: [0×1 roadrunner.hdmap.Junction]
    BarrierTypes: [0×1 roadrunner.hdmap.BarrierType]
        Barriers: [0×1 roadrunner.hdmap.Barrier]
    SignTypes: [0×1 roadrunner.hdmap.SignType]
        Signs: [0×1 roadrunner.hdmap.Sign]
```

Version History

Introduced in R2022b

See Also

roadrunnerHDMap | roadrunner.hdmap.Lane

Topics

"Build Simple Roads Programmatically Using RoadRunner HD Map" (RoadRunner)

"Build Scenes from Custom Data Using RoadRunner HD Map" (RoadRunner)

roadrunner.hdmap.LaneGroup

Create lane groups in RoadRunner HD Map using MATLAB

Description

A `roadrunner.hdmap.LaneGroup` object enables you to define a group of lanes with similar geometry in a RoadRunner HD Map scene model. The `LaneGroup` geometry is used as a general approximation for the geometry of the lanes contained within that group. The hierarchy of the lane elements is defined as:

- A lane group contains references to lanes.
- A lane has references to its boundaries and its connected lanes.
- A lane boundary has references to the lane markings.

Creation

Syntax

```
aLaneGroup = roadrunner.hdmap.LaneGroup()  
aLaneGroup = roadrunner.hdmap.LaneGroup(Name=Value)
```

Description

`aLaneGroup = roadrunner.hdmap.LaneGroup()` creates an empty lane group collection.

`aLaneGroup = roadrunner.hdmap.LaneGroup(Name=Value)` sets the properties of the lane group collection using name-value pairs.

Properties

ID — ID of lane group

character vector | string scalar

ID of the lane group, specified as a character vector or string scalar.

Example: `rrMap.LaneGroups = roadrunner.hdmap.LaneGroup(ID="LaneGroup1")` creates a lane group with id `LaneGroup1` in a RoadRunner HD Map.

Data Types: `char` | `string`

Geometry — 3D coordinates of geometric shape of lane group

three element vector

3D coordinates of the geometric shape of the lane group, specified as a three element vector, with double precision values.

Example: `rrMap.LaneGroups = roadrunner.hdmap.LaneGroup(ID="LaneGroup1", Geometry=[-0.782 -1.56;50.78 23.43])` creates a lane group with id `"LaneGroup1"` and defines the coordinates for the geometric shape of the lane group.

Data Types: double

Lanes — Collection of lane references

array of `roadrunner.hdmap.AlignedReference` objects

Collection of lane references, specified as an array of `roadrunner.hdmap.AlignedReference` objects. This property defines the linkage information for lanes within the lane group.

Examples

Add Lane Group to RoadRunner HD Map

Create an empty RoadRunner HD Map by calling the `roadrunnerHDMAP` object.

```
rrMap = roadrunnerHDMAP()
```

```
rrMap =
  roadrunnerHDMAP with properties:
```

```

    Author: ""
    Projection: ""
    GeographicBoundary: [0x3 double]
        Lanes: [0x1 roadrunner.hdmap.Lane]
    LaneBoundaries: [0x1 roadrunner.hdmap.LaneBoundary]
    LaneGroups: [0x1 roadrunner.hdmap.LaneGroup]
    LaneMarkings: [0x1 roadrunner.hdmap.LaneMarking]
    Junctions: [0x1 roadrunner.hdmap.Junction]
    BarrierTypes: [0x1 roadrunner.hdmap.BarrierType]
    Barriers: [0x1 roadrunner.hdmap.Barrier]
    SignTypes: [0x1 roadrunner.hdmap.SignType]
    Signs: [0x1 roadrunner.hdmap.Sign]
```

Create the road lane group using the `roadrunner.hdmap.LaneGroup` object. Specify the lane information for the lane id.

```
rrMap.LaneGroups = roadrunner.hdmap.LaneGroup(ID="LaneGroup1")
```

```
rrMap =
  roadrunnerHDMAP with properties:
```

```

    Author: ""
    Projection: ""
    GeographicBoundary: [0x3 double]
        Lanes: [0x1 roadrunner.hdmap.Lane]
    LaneBoundaries: [0x1 roadrunner.hdmap.LaneBoundary]
    LaneGroups: [1x1 roadrunner.hdmap.LaneGroup]
    LaneMarkings: [0x1 roadrunner.hdmap.LaneMarking]
    Junctions: [0x1 roadrunner.hdmap.Junction]
    BarrierTypes: [0x1 roadrunner.hdmap.BarrierType]
    Barriers: [0x1 roadrunner.hdmap.Barrier]
    SignTypes: [0x1 roadrunner.hdmap.SignType]
    Signs: [0x1 roadrunner.hdmap.Sign]
```

Version History

Introduced in R2022b

See Also

roadrunnerHDMAP | roadrunner.hdmap.Lane | roadrunner.hdmap.LaneBoundary |
roadrunner.hdmap.LaneMarking

Topics

“Build Simple Roads Programmatically Using RoadRunner HD Map” (RoadRunner)

“Build Scenes from Custom Data Using RoadRunner HD Map” (RoadRunner)

roadrunner.hdmap.LaneMarking

Create lane markings in RoadRunner HD Map using MATLAB

Description

A `roadrunner.hdmap.LaneMarking` object enables you to define the road lane marking object in a RoadRunner HD Map scene model.

Creation

Syntax

```
aLaneMarking = roadrunner.hdmap.LaneMarking()  
aLaneMarking = roadrunner.hdmap.LaneMarking(Name=Value)
```

Description

`aLaneMarking = roadrunner.hdmap.LaneMarking()` creates an empty lane marking.

`aLaneMarking = roadrunner.hdmap.LaneMarking(Name=Value)` sets the properties of the lane marking using name-value pairs.

Properties

ID — ID of lane marking element

character vector | string scalar

ID of the lane marking element, specified as a character vector or string scalar. The ID can be referenced by the lane elements using `roadrunner.hdmap.MarkingReference` object.

Data Types: `char` | `string`

AssetPath — Relative path for lane marking asset

`roadrunner.hdmap.RelativeAssetPath` object

Relative path for lane marking asset, specified as a `roadrunner.hdmap.RelativeAssetPath` object. To define the lane markings on a span, `RelativeAssetPath` can be used to reference existing marking assets in the library.

Examples

Add Lane Marking to RoadRunner HD Map

Create an empty RoadRunner HD Map by calling the `roadrunnerHDMAP` object.

```
rrMap = roadrunnerHDMAP()
```

```
rrMap =  
  roadrunnerHDMAP with properties:  
  
    Author: ""  
    GeoReference: [0 0]  
    GeographicBoundary: []  
    Lanes: [0x1 roadrunner.hdmap.Lane]  
    LaneBoundaries: [0x1 roadrunner.hdmap.LaneBoundary]  
    LaneGroups: [0x1 roadrunner.hdmap.LaneGroup]  
    LaneMarkings: [0x1 roadrunner.hdmap.LaneMarking]  
    Junctions: [0x1 roadrunner.hdmap.Junction]  
    BarrierTypes: [0x1 roadrunner.hdmap.BarrierType]  
    Barriers: [0x1 roadrunner.hdmap.Barrier]  
    SignTypes: [0x1 roadrunner.hdmap.SignType]  
    Signs: [0x1 roadrunner.hdmap.Sign]  
    StaticObjectTypes: [0x1 roadrunner.hdmap.StaticObjectType]  
    StaticObjects: [0x1 roadrunner.hdmap.StaticObject]
```

Create a relative path to an asset. In this example, we create a relative path to the dashed single white asset. This path is relative to the `Assets` folder of your RoadRunner project.

```
path = roadrunner.hdmap.RelativeAssetPath(AssetPath="/Assets/Markings/DashedSingleWhite.rrlms")
```

```
path =  
  RelativeAssetPath with properties:  
  
    AssetPath: "/Assets/Markings/DashedSingleWhite.rrlms"
```

Create the road lane marking using the `roadrunner.hdmap.LaneMarking` object. Specify the lane marking information for the lane marking id and the asset path.

```
rrMap.LaneMarkings = roadrunner.hdmap.LaneMarking(ID="Dashed1", AssetPath=path)
```

```
rrMap =  
  roadrunnerHDMAP with properties:  
  
    Author: ""  
    GeoReference: [0 0]  
    GeographicBoundary: []  
    Lanes: [0x1 roadrunner.hdmap.Lane]  
    LaneBoundaries: [0x1 roadrunner.hdmap.LaneBoundary]  
    LaneGroups: [0x1 roadrunner.hdmap.LaneGroup]  
    LaneMarkings: [1x1 roadrunner.hdmap.LaneMarking]  
    Junctions: [0x1 roadrunner.hdmap.Junction]  
    BarrierTypes: [0x1 roadrunner.hdmap.BarrierType]  
    Barriers: [0x1 roadrunner.hdmap.Barrier]  
    SignTypes: [0x1 roadrunner.hdmap.SignType]  
    Signs: [0x1 roadrunner.hdmap.Sign]  
    StaticObjectTypes: [0x1 roadrunner.hdmap.StaticObjectType]  
    StaticObjects: [0x1 roadrunner.hdmap.StaticObject]
```

Version History

Introduced in R2022b

See Also

[roadrunnerHDMAP](#) | [roadrunner.hdmap.Lane](#) | [roadrunner.hdmap.LaneBoundary](#) | [roadrunner.hdmap.LaneGroup](#)

Topics

[“Build Simple Roads Programmatically Using RoadRunner HD Map” \(RoadRunner\)](#)

[“Build Scenes from Custom Data Using RoadRunner HD Map” \(RoadRunner\)](#)

roadrunner.hdmap.MarkingReference

Defines the information for linking lane boundary and lane marking in in RoadRunner HD Map using MATLAB

Description

A `roadrunner.hdmap.MarkingReference` object enables you to define the information for linking lane boundary and lane marking in a RoadRunner HD Map scene model.

Creation

Syntax

```
mrkref = roadrunner.hdmap.MarkingReference()  
mrkref = roadrunner.hdmap.MarkingReference(Name=Value)
```

Description

`mrkref = roadrunner.hdmap.MarkingReference()` creates an empty marking reference.

`mrkref = roadrunner.hdmap.MarkingReference(Name=Value)` sets the properties of the marking reference using name-value pairs.

Properties

MarkingID — ID of lane marking element

`roadrunner.hdmap.Reference` object

ID of the lane marking element, specified as a `roadrunner.hdmap.Reference` object.

FlipLaterally — Set flip marking orientation

`true` or `1` | `false` or `0`

Set flip marking orientation, specified as logical `0` (`false`) or logical `1` (`true`). Set this field to logical `1` (`true`) to flip the order of the lane marking stripes.

Examples

Create Marking Reference in RoadRunner HD Map

Create an reference for a marking asset.

```
ref = roadrunner.hdmap.Reference(ID="Dashed1")
```

```
ref =  
    Reference with properties:
```



```
ID: "Dashed1"
```

Create a marking reference for the marking to link the lane boundary and the lane marking.

```
mrkref = roadrunner.hdmap.MarkingReference(MarkingID=ref,FlipLaterally=true)
```

```
mrkref =
```

```
  MarkingReference with properties:
```

```
    MarkingID: [1x1 roadrunner.hdmap.Reference]
```

```
    FlipLaterally: 1
```

Version History

Introduced in R2022b

See Also

[roadrunnerHDMMap](#) | [roadrunner.hdmap.Lane](#) | [roadrunner.hdmap.LaneBoundary](#) | [roadrunner.hdmap.ParametricAttribution](#)

Topics

["Build Simple Roads Programmatically Using RoadRunner HD Map" \(RoadRunner\)](#)

["Build Scenes from Custom Data Using RoadRunner HD Map" \(RoadRunner\)](#)

roadrunner.hdmap.ParametricAttribution

Span-based parametric attributes

Description

A `roadrunner.hdmap.ParametricAttribution` object enables you to define the span-based parametric attributes for lane boundaries in a RoadRunner HD Map scene model.

Creation

Syntax

```
prmAttr = roadrunner.hdmap.ParametricAttribution()  
prmAttr = roadrunner.hdmap.ParametricAttribution(Name=Value)
```

Description

`prmAttr = roadrunner.hdmap.ParametricAttribution()` creates an empty parametric attribution for a lane boundary.

`prmAttr = roadrunner.hdmap.ParametricAttribution(Name=Value)` sets the properties of the parametric attribution for lane boundary using name-value pairs.

Properties

Span — Range for span-based attributes

two element vector

Range for span based attributes, specified as a two element vector [`spanStart` `spanEnd`]. Using this property, you can insert span nodes that define a range along a curve-based parent object. You can change attributes along the specified range. For example, you can specify a range for which to change a lane marking along a lane boundary. `spanStart` is the normalized distance in the range [0, 1] between the start of the current span and the start of the parent object. Use the length of the parent object to get the normalized value. `spanEnd` is the normalized distance in the range [0, 1] between the end of the current span and the start of the parent object. Use the length of the parent object to get the normalized value.

Data Types: double

MarkingReference — Reference to marking defined in RoadRunner HD Map

`roadrunner.hdmap.MarkingReference` object

Reference to marking defined in a RoadRunner HD Map, specified as a `roadrunner.hdmap.MarkingReference` object. This property defines the linking information for lane marking. You can specify ID, and offset attributes to place lane markings.

Examples

Create Parametric Attributes in RoadRunner HD Map

Create an reference for a marking asset.

```
ref = roadrunner.hdmap.Reference(ID="Dashed1")
```

```
ref =
  Reference with properties:
```

```
    ID: "Dashed1"
```

```
mrkref = roadrunner.hdmap.MarkingReference(MarkingID=ref)
```

```
mrkref =
  MarkingReference with properties:
```

```
    MarkingID: [1x1 roadrunner.hdmap.Reference]
    FlipLaterally: 0
```

Create a parametric attribution for the marking with reference id Dashed1

```
prmAttr = roadrunner.hdmap.ParametricAttribution(Span=[0.1 0.3], MarkingReference=mrkref)
```

```
prmAttr =
  ParametricAttribution with properties:
```

```
    Span: [0.1000 0.3000]
    MarkingReference: [1x1 roadrunner.hdmap.MarkingReference]
```

Version History

Introduced in R2022b

See Also

roadrunnerHDMAP | roadrunner.hdmap.Lane | roadrunner.hdmap.LaneBoundary

Topics

“Build Simple Roads Programmatically Using RoadRunner HD Map” (RoadRunner)

“Build Scenes from Custom Data Using RoadRunner HD Map” (RoadRunner)

roadrunner.hdmap.Reference

Defines id of referenced object in RoadRunner HD map using MATLAB

Description

The `roadrunner.hdmap.Reference` object holds the id to the object being referred to in RoadRunner HD Maps. For example, a Junction A can refer to Lane B by holding Lane B's id in its reference.

Creation

Syntax

```
ref = roadrunner.hdmap.Reference()  
ref = roadrunner.hdmap.Reference(Name=Value)
```

Description

`ref = roadrunner.hdmap.Reference()` creates an empty reference.

`ref = roadrunner.hdmap.Reference(Name=Value)` sets the properties of the reference using name-value pairs.

Properties

ID — ID of referenced object

character vector | string scalar

ID of the referenced object, specified as a character vector or string scalar object.

Example: `ref = roadrunner.hdmap.Reference(ID="Lane2")` creates a referenced object with id Lane2.

Data Types: `char` | `string`

Examples

Add Lane with Reference to RoadRunner HD Map

Create an empty RoadRunner HD Map by calling the `roadrunnerHDMMap` object.

```
rrMap = roadrunnerHDMMap()
```

```
rrMap =  
    roadrunnerHDMMap with properties:
```

```
    Author: ""
```

```

    Projection: ""
    GeographicBoundary: [0×3 double]
        Lanes: [0×1 roadrunner.hdmap.Lane]
    LaneBoundaries: [0×1 roadrunner.hdmap.LaneBoundary]
    LaneGroups: [0×1 roadrunner.hdmap.LaneGroup]
    LaneMarkings: [0×1 roadrunner.hdmap.LaneMarking]
    Junctions: [0×1 roadrunner.hdmap.Junction]
    BarrierTypes: [0×1 roadrunner.hdmap.BarrierType]
    Barriers: [0×1 roadrunner.hdmap.Barrier]
    SignTypes: [0×1 roadrunner.hdmap.SignType]
    Signs: [0×1 roadrunner.hdmap.Sign]

```

Create the road lane using the `roadrunner.hdmap.Lane` object. Specify the lane information for the lane id, coordinates defining the lane geometry, driving direction, and lane type.

```
rLane = roadrunner.hdmap.Lane(ID="Lane1",Geometry=[-0.782 -1.56;50.78 23.43],TravelDirection="Fo
```

```
rLane =
```

```
    Lane with properties:
```

```

        ID: "Lane1"
        Geometry: [2×2 double]
    TravelDirection: Forward
    LeftLaneBoundary: [0×0 roadrunner.hdmap.AlignedReference]
    RightLaneBoundary: [0×0 roadrunner.hdmap.AlignedReference]
    Predecessors: [0×1 roadrunner.hdmap.AlignedReference]
    Successors: [0×1 roadrunner.hdmap.AlignedReference]
    LaneType: Driving

```

Create a reference to `Lane1` using the `roadrunner.hdmap.Reference` object.

```
ref = roadrunner.hdmap.Reference(ID="Lane1")
```

```
ref =
```

```
    Reference with properties:
```

```

        ID: "Lane1"

```

Version History

Introduced in R2022b

See Also

`roadrunnerHDMMap` | `roadrunner.hdmap.Lane` | `roadrunner.hdmap.AlignedReference`

Topics

“Build Simple Roads Programmatically Using RoadRunner HD Map” (RoadRunner)

“Build Scenes from Custom Data Using RoadRunner HD Map” (RoadRunner)

roadrunner.hdmap.RelativeAssetPath

Defines relative path for lane marking asset in RoadRunner HD Map using MATLAB

Description

A `roadrunner.hdmap.RelativeAssetPath` object enables you to define the road lane marking object in a RoadRunner HD Map scene model. The `RelativeAssetPath` refers to the assets in the asset library by using the directory path relative to the project directory.

Creation

Syntax

```
assetPath = roadrunner.hdmap.RelativeAssetPath()  
assetPath = roadrunner.hdmap.RelativeAssetPath(Name=Value)
```

Description

`assetPath = roadrunner.hdmap.RelativeAssetPath()` creates an empty relative asset path.

`assetPath = roadrunner.hdmap.RelativeAssetPath(Name=Value)` sets the properties of the relative asset path using name-value pairs.

Properties

AssetPath — Relative path for asset in asset library

character vector | string scalar

Relative path for an asset in the asset library, specified as a character vector or string scalar.

Example: `"Assets/Markings/DashedSingleWhite.rrlms"` sets the path for the white dashed lane marking asset.

Data Types: `char` | `string`

Examples

Add an Asset to a Lane Marking in RoadRunner HD Map

Create an empty RoadRunner HD Map by calling the `roadrunnerHDMMap` object.

```
rrMap = roadrunnerHDMMap()
```

```
rrMap =  
    roadrunnerHDMMap with properties:
```

```
    Author: ""
```

```

    Projection: ""
  GeographicBoundary: [0x3 double]
    Lanes: [0x1 roadrunner.hdmap.Lane]
  LaneBoundaries: [0x1 roadrunner.hdmap.LaneBoundary]
  LaneGroups: [0x1 roadrunner.hdmap.LaneGroup]
  LaneMarkings: [0x1 roadrunner.hdmap.LaneMarking]
  Junctions: [0x1 roadrunner.hdmap.Junction]
  BarrierTypes: [0x1 roadrunner.hdmap.BarrierType]
  Barriers: [0x1 roadrunner.hdmap.Barrier]
  SignTypes: [0x1 roadrunner.hdmap.SignType]
  Signs: [0x1 roadrunner.hdmap.Sign]

```

Create a relative path to an asset. In this example, we create a relative path to the dashed single white asset. This path is relative to the `Assets` folder of your RoadRunner project.

```
path = roadrunner.hdmap.RelativeAssetPath(AssetPath="/Asset/Markings/DashedSingleWhite.rrlms")
```

```
path =
```

```
  RelativeAssetPath with properties:
```

```
    AssetPath: "/Asset/Markings/DashedSingleWhite.rrlms"
```

Create the road lane marking using the `roadrunner.hdmap.LaneMarking` object and add the asset as a lane marking.

```
rrMap.LaneMarkings = roadrunner.hdmap.LaneMarking(ID="Dashed1", AssetPath=path)
```

```
rrMap =
```

```
  roadrunnerHDMAP with properties:
```

```

    Author: ""
    Projection: ""
  GeographicBoundary: [0x3 double]
    Lanes: [0x1 roadrunner.hdmap.Lane]
  LaneBoundaries: [0x1 roadrunner.hdmap.LaneBoundary]
  LaneGroups: [0x1 roadrunner.hdmap.LaneGroup]
  LaneMarkings: [1x1 roadrunner.hdmap.LaneMarking]
  Junctions: [0x1 roadrunner.hdmap.Junction]
  BarrierTypes: [0x1 roadrunner.hdmap.BarrierType]
  Barriers: [0x1 roadrunner.hdmap.Barrier]
  SignTypes: [0x1 roadrunner.hdmap.SignType]
  Signs: [0x1 roadrunner.hdmap.Sign]

```

Version History

Introduced in R2022b

See Also

`roadrunnerHDMAP` | `roadrunner.hdmap.LaneMarking`

Topics

“Build Simple Roads Programmatically Using RoadRunner HD Map” (RoadRunner)

“Build Scenes from Custom Data Using RoadRunner HD Map” (RoadRunner)

roadrunner.hdmap.Sign

Create signs in RoadRunner HD Map using MATLAB

Description

A `roadrunner.hdmap.Sign` object enables you to define the road sign objects in a RoadRunner HD Map scene model.

Creation

Syntax

```
aSign = roadrunner.hdmap.Sign()
aSign = roadrunner.hdmap.Sign(Name=Value)
```

Description

`aSign = roadrunner.hdmap.Sign()` creates an empty sign.

`aSign = roadrunner.hdmap.Sign(Name=Value)` sets the properties of the sign using name-value pairs.

Properties

ID — ID of sign element

character vector | string scalar

ID of the sign element, specified as a character vector or string scalar.

Example: `rrMap.Signs = roadrunner.hdmap.Sign(ID="Sign1")` creates a sign with id `Sign1` in a RoadRunner HD Map.

Data Types: `char` | `string`

Geometry — Geometry of 3D stationary object representing the sign

three element vector

Geometry of the 3D stationary object representing the sign, specified as a three element vector, with double precision values. Sign is represented as an oriented bounding box.

Data Types: `double`

SignTypeReference — Type of sign

`roadrunner.hdmap.Reference` object

Type of sign, specified as a `roadrunner.hdmap.Reference` object.

Examples

Add Sign to RoadRunner HD Map

Create an empty RoadRunner HD Map by calling the `roadrunnerHDMMap` object.

```
rrMap = roadrunnerHDMMap()  
  
rrMap =  
  roadrunnerHDMMap with properties:  
  
      Author: ""  
      Projection: ""  
      GeographicBoundary: [0×3 double]  
      Lanes: [0×1 roadrunner.hdmap.Lane]  
      LaneBoundaries: [0×1 roadrunner.hdmap.LaneBoundary]  
      LaneGroups: [0×1 roadrunner.hdmap.LaneGroup]  
      LaneMarkings: [0×1 roadrunner.hdmap.LaneMarking]  
      Junctions: [0×1 roadrunner.hdmap.Junction]  
      BarrierTypes: [0×1 roadrunner.hdmap.BarrierType]  
      Barriers: [0×1 roadrunner.hdmap.Barrier]  
      SignTypes: [0×1 roadrunner.hdmap.SignType]  
      Signs: [0×1 roadrunner.hdmap.Sign]
```

Create the sign using the `roadrunner.hdmap.Sign` object. Specify the sign information for the sign id.

```
rrMap.Signs = roadrunner.hdmap.Sign(ID="Sign1")  
  
rrMap =  
  roadrunnerHDMMap with properties:  
  
      Author: ""  
      Projection: ""  
      GeographicBoundary: [0×3 double]  
      Lanes: [0×1 roadrunner.hdmap.Lane]  
      LaneBoundaries: [0×1 roadrunner.hdmap.LaneBoundary]  
      LaneGroups: [0×1 roadrunner.hdmap.LaneGroup]  
      LaneMarkings: [0×1 roadrunner.hdmap.LaneMarking]  
      Junctions: [0×1 roadrunner.hdmap.Junction]  
      BarrierTypes: [0×1 roadrunner.hdmap.BarrierType]  
      Barriers: [0×1 roadrunner.hdmap.Barrier]  
      SignTypes: [0×1 roadrunner.hdmap.SignType]  
      Signs: [1×1 roadrunner.hdmap.Sign]
```

Version History

Introduced in R2022b

See Also

`roadrunnerHDMMap` | `roadrunner.hdmap.SignType`

Topics

“Build Simple Roads Programmatically Using RoadRunner HD Map” (RoadRunner)

“Build Scenes from Custom Data Using RoadRunner HD Map” (RoadRunner)

roadrunner.hdmap.SignType

Create sign types in RoadRunner HD Map using MATLAB

Description

A `roadrunner.hdmap.SignType` object enables you to define the sign features and the type information for a sign in a RoadRunner HD Map scene model.

Creation

Syntax

```
aSignType = roadrunner.hdmap.SignType()  
aSignType = roadrunner.hdmap.SignType(Name=Value)
```

Description

`aSignType = roadrunner.hdmap.SignType()` creates an empty sign type.

`aSignType = roadrunner.hdmap.SignType(Name=Value)` sets the properties of the sign type using name-value pairs.

Properties

ID — ID of sign type

character vector | string scalar

ID of the sign type, specified as a character vector or string scalar. The `Sign` object refers to this field to describe the type of a sign.

Data Types: `char` | `string`

AssetPath — Relative path for image of sign or sign asset file

`roadrunner.hdmap.RelativeAssetPath` object

Relative path for an image of the sign or a sign asset file, specified as a `roadrunner.hdmap.RelativeAssetPath` object. The asset path points to the information about the sign type.

Examples

Add Sign Type to RoadRunner HD Map

Create an empty RoadRunner HD Map by calling the `roadrunnerHDMAP` object.

```
rrMap = roadrunnerHDMAP()
```

```

rrMap =
  roadrunnerHDMAP with properties:
    Author: ""
    GeoReference: [0 0]
    GeographicBoundary: [0x3 double]
    Lanes: [0x1 roadrunner.hdmap.Lane]
    LaneBoundaries: [0x1 roadrunner.hdmap.LaneBoundary]
    LaneGroups: [0x1 roadrunner.hdmap.LaneGroup]
    LaneMarkings: [0x1 roadrunner.hdmap.LaneMarking]
    Junctions: [0x1 roadrunner.hdmap.Junction]
    BarrierTypes: [0x1 roadrunner.hdmap.BarrierType]
    Barriers: [0x1 roadrunner.hdmap.Barrier]
    SignTypes: [0x1 roadrunner.hdmap.SignType]
    Signs: [0x1 roadrunner.hdmap.Sign]
    StaticObjectTypes: [0x1 roadrunner.hdmap.StaticObjectType]
    StaticObjects: [0x1 roadrunner.hdmap.StaticObject]

```

Create a relative path to an asset. In this example, create a relative path to a parking sign asset file from the RoadRunner Asset Library. This path is relative to the Assets folder of your RoadRunner project.

```
path = roadrunner.hdmap.RelativeAssetPath(AssetPath="/Assets/Signs/UK/Sign_Parking.svg")
```

```

path =
  RelativeAssetPath with properties:
    AssetPath: "/Assets/Signs/UK/Sign_Parking.svg"

```

Create the sign type using the `roadrunner.hdmap.SignType` object. Specify the sign type information for the sign type id and the asset path.

```
rrMap.SignTypes = roadrunner.hdmap.SignType(ID="SignType1", AssetPath=path)
```

```

rrMap =
  roadrunnerHDMAP with properties:
    Author: ""
    GeoReference: [0 0]
    GeographicBoundary: [0x3 double]
    Lanes: [0x1 roadrunner.hdmap.Lane]
    LaneBoundaries: [0x1 roadrunner.hdmap.LaneBoundary]
    LaneGroups: [0x1 roadrunner.hdmap.LaneGroup]
    LaneMarkings: [0x1 roadrunner.hdmap.LaneMarking]
    Junctions: [0x1 roadrunner.hdmap.Junction]
    BarrierTypes: [0x1 roadrunner.hdmap.BarrierType]
    Barriers: [0x1 roadrunner.hdmap.Barrier]
    SignTypes: [1x1 roadrunner.hdmap.SignType]
    Signs: [0x1 roadrunner.hdmap.Sign]
    StaticObjectTypes: [0x1 roadrunner.hdmap.StaticObjectType]
    StaticObjects: [0x1 roadrunner.hdmap.StaticObject]

```

Version History

Introduced in R2022b

See Also

roadrunnerHDMAP | roadrunner.hdmap.Sign

Topics

"Build Simple Roads Programmatically Using RoadRunner HD Map" (RoadRunner)

"Build Scenes from Custom Data Using RoadRunner HD Map" (RoadRunner)

roadrunner.hdmap.StaticObject

Create static objects for RoadRunner HD Map using MATLAB

Description

A `roadrunner.hdmap.StaticObject` object enables you to define the static object instances in a RoadRunner HD Map scene model. This object is used for props and road furniture that do not move.

Creation

Syntax

```
aStaticObject = roadrunner.hdmap.StaticObject()  
aStaticObject = roadrunner.hdmap.StaticObject(Name=Value)
```

Description

`aStaticObject = roadrunner.hdmap.StaticObject()` creates an empty `StaticObject`.

`aStaticObject = roadrunner.hdmap.StaticObject(Name=Value)` sets the properties of the `StaticObject` using name-value pairs.

Properties

ID — ID of StaticObjectelement

character vector | string scalar

ID of the `StaticObject` element, specified as a character vector or string scalar.

Example: `rrMap.StaticObjects = roadrunner.hdmap.StaticObject(ID="StaticObject1")` creates a `StaticObject` with id `StaticObject1` in a RoadRunner HD Map.

Data Types: `char` | `string`

Geometry — Geometry of the StaticObject

`GeoOrientedBoundingBox`

Geometry of the `StaticObject`, specified as a `GeoOrientedBoundingBox`. Static objects fit within an oriented bounding box. Objects should be scaled to fit the bound and then rotated. See `GeoOrientation3` for how to handle rotations of objects.

Data Types: `vector`

ObjectTypeReference — Type of StaticObject

`roadrunner.hdmap.Reference` object

Type of `StaticObject`, specified as a `roadrunner.hdmap.Reference` object.

Examples

Add Static Object to RoadRunner HD Map

Create an empty RoadRunner HD Map by calling the `roadrunnerHDMAP` object.

```
rrMap = roadrunnerHDMAP()
```

```
rrMap =
```

```
roadrunnerHDMAP with properties:
```

```

    Author: ""
    Projection: ""
    GeographicBoundary: [0x3 double]
    Lanes: [0x1 roadrunner.hdmap.Lane]
    LaneBoundaries: [0x1 roadrunner.hdmap.LaneBoundary]
    LaneGroups: [0x1 roadrunner.hdmap.LaneGroup]
    LaneMarkings: [0x1 roadrunner.hdmap.LaneMarking]
    Junctions: [0x1 roadrunner.hdmap.Junction]
    BarrierTypes: [0x1 roadrunner.hdmap.BarrierType]
    Barriers: [0x1 roadrunner.hdmap.Barrier]
    SignTypes: [0x1 roadrunner.hdmap.SignType]
    Signs: [0x1 roadrunner.hdmap.Sign]
    StaticObjectTypes: [0x1 roadrunner.hdmap.StaticObjectType]
    StaticObjects: [0x1 roadrunner.hdmap.StaticObject]

```

Create a static object using the `roadrunner.hdmap.StaticObject` object. Specify the static object information for the object id.

```
rrMap.StaticObjects = roadrunner.hdmap.StaticObject(ID="StaticObject1")
```

```
rrMap =
```

```
roadrunnerHDMAP with properties:
```

```

    Author: ""
    Projection: ""
    GeographicBoundary: [0x3 double]
    Lanes: [0x1 roadrunner.hdmap.Lane]
    LaneBoundaries: [0x1 roadrunner.hdmap.LaneBoundary]
    LaneGroups: [0x1 roadrunner.hdmap.LaneGroup]
    LaneMarkings: [0x1 roadrunner.hdmap.LaneMarking]
    Junctions: [0x1 roadrunner.hdmap.Junction]
    BarrierTypes: [0x1 roadrunner.hdmap.BarrierType]
    Barriers: [0x1 roadrunner.hdmap.Barrier]
    SignTypes: [0x1 roadrunner.hdmap.SignType]
    Signs: [0x1 roadrunner.hdmap.Sign]
    StaticObjectTypes: [0x1 roadrunner.hdmap.StaticObjectType]
    StaticObjects: [1x1 roadrunner.hdmap.StaticObject]

```

Version History

Introduced in R2022b

See Also

`roadrunnerHDMAP | roadrunner.hdmap.StaticObjectType`

Topics

“Build Simple Roads Programmatically Using RoadRunner HD Map” (RoadRunner)

“Build Scenes from Custom Data Using RoadRunner HD Map” (RoadRunner)

roadrunner.hdmap.StaticObjectType

Create static object types in RoadRunner HD Map using MATLAB

Description

A `roadrunner.hdmap.StaticObject` object enables you to define the static object and the type information for a static object in a RoadRunner HD Map scene model.

Creation

Syntax

```
aStaticObjectType = roadrunner.hdmap.StaticObjectType()
aStaticObjectType = roadrunner.hdmap.StaticObjectType(Name=Value)
```

Description

`aStaticObjectType = roadrunner.hdmap.StaticObjectType()` creates an empty `StaticObject` type.

`aStaticObjectType = roadrunner.hdmap.StaticObjectType(Name=Value)` sets the properties of the `StaticObject` type using name-value pairs.

Properties

ID — ID of StaticObject type

character vector | string scalar

ID of the `StaticObject` type, specified as a character vector or string scalar. The `StaticObject` object refers to this field to describe the type of a static object.

Data Types: `char` | `string`

AssetPath — Relative path for 3D mesh or prop asset file

`roadrunner.hdmap.RelativeAssetPath` object

Relative path for 3D mesh or prop asset file, specified as a `roadrunner.hdmap.RelativeAssetPath` object. The asset path points to the information about the static object type.

Examples

Add Static Object Type to RoadRunner HD Map

Create an empty RoadRunner HD Map by calling the `roadrunnerHDMAP` object.

```
rrMap = roadrunnerHDMAP()
```

```
rrMap =
  roadrunnerHDMAP with properties:
    Author: ""
    Projection: ""
    GeographicBoundary: [0x3 double]
    Lanes: [0x1 roadrunner.hdmap.Lane]
    LaneBoundaries: [0x1 roadrunner.hdmap.LaneBoundary]
    LaneGroups: [0x1 roadrunner.hdmap.LaneGroup]
    LaneMarkings: [0x1 roadrunner.hdmap.LaneMarking]
    Junctions: [0x1 roadrunner.hdmap.Junction]
    BarrierTypes: [0x1 roadrunner.hdmap.BarrierType]
    Barriers: [0x1 roadrunner.hdmap.Barrier]
    SignTypes: [0x1 roadrunner.hdmap.SignType]
    Signs: [0x1 roadrunner.hdmap.Sign]
    StaticObjectTypes: [0x1 roadrunner.hdmap.StaticObjectType]
    StaticObjects: [0x1 roadrunner.hdmap.StaticObject]
```

Create a relative path to an asset. In this example, we create a relative path to a prop asset file from the RoadRunner Asset Library. This path is relative to the `Assets` folder of your RoadRunner project.

```
path = roadrunner.hdmap.RelativeAssetPath(AssetPath="/Asset/Props/Trees/Eucalyptus_Sm01.fbx")
```

```
path =
  RelativeAssetPath with properties:
    AssetPath: "/Asset/Props/Trees/Eucalyptus_Sm01.fbx"
```

Create the static object type using the `roadrunner.hdmap.StaticObjectType` object. Specify the static object type information for the static object type id and the asset path.

```
rrMap.StaticObjectTypes = roadrunner.hdmap.StaticObjectType(ID="StaticObjectType1", AssetPath=path)
```

```
rrMap =
  roadrunnerHDMAP with properties:
    Author: ""
    Projection: ""
    GeographicBoundary: [0x3 double]
    Lanes: [0x1 roadrunner.hdmap.Lane]
    LaneBoundaries: [0x1 roadrunner.hdmap.LaneBoundary]
    LaneGroups: [0x1 roadrunner.hdmap.LaneGroup]
    LaneMarkings: [0x1 roadrunner.hdmap.LaneMarking]
    Junctions: [0x1 roadrunner.hdmap.Junction]
    BarrierTypes: [0x1 roadrunner.hdmap.BarrierType]
    Barriers: [0x1 roadrunner.hdmap.Barrier]
    SignTypes: [0x1 roadrunner.hdmap.SignType]
    Signs: [0x1 roadrunner.hdmap.Sign]
    StaticObjectTypes: [1x1 roadrunner.hdmap.StaticObjectType]
    StaticObjects: [0x1 roadrunner.hdmap.StaticObject]
```

Version History

Introduced in R2022b

See Also

`roadrunnerHDMap` | `roadrunner.hdmap.StaticObject`

Topics

“Build Simple Roads Programmatically Using RoadRunner HD Map” (RoadRunner)

“Build Scenes from Custom Data Using RoadRunner HD Map” (RoadRunner)

roadrunnerHDMap

Create RoadRunner HD Map using MATLAB

Description

A `roadrunnerHDMap` object enables you to create a RoadRunner HD Map using MATLAB. You can also populate the map with lanes, lane boundaries, lane markings, and junctions.

RoadRunner HD Map is a road data model for representing high-definition (HD) map data in a RoadRunner scene. This model defines a simple data structure to represent road layouts using lanes, lane boundaries, lane markings, and junctions. You can use the RoadRunner HD Map to create a binary file for your custom HD map data, import the binary file into RoadRunner, and build scenes.

Creation

Syntax

```
rrMap = roadrunnerHDMap()  
rrMap = roadrunnerHDMap(Name=Value)
```

Description

`rrMap = roadrunnerHDMap()` creates an empty RoadRunner HD Map. You can populate the map with lanes, lane boundaries, lane markings, and junctions using `roadrunnerHDMap` object properties. The data in the map is serialized using protocol buffers and saved in a binary format with the `.rrhd` extension using the `write` method. You can use the `read` method to read a file with `.rrhd` extension and populate an empty `roadrunnerHDMap` object.

`rrMap = roadrunnerHDMap(Name=Value)` sets the properties using name-value pairs.

Properties

Author — Name of map author

character vector | string scalar

Name of the map author, specified as a string scalar.

Example: `rrMap = roadrunnerHDMap(Author="Map Author")` creates a RoadRunner HD Map owned by "Map Author".

Data Types: `char` | `string`

GeoReference — Geographic coordinates of road network origin

row vector

Geographic coordinates of road network origin, specified as a row vector of the form `[lat, lon]` with two elements. `lat` represents the latitude of the coordinates in degrees and `lon` represents the longitude of the coordinates in degrees. These values are with respect to the WGS84 reference

ellipsoid, which is a standard ellipsoid used by GPS data. For more details, see “Coordinate Space and Georeferencing” (RoadRunner).

Data Types: `double`

GeographicBoundary — Spatial bounds of geometric data

`matrix`

Spatial bounds of the geometric data represented in the 3D coordinate space of the RoadRunner HD Map projection, specified as a 2-by-3 matrix of double precision. The elements in the matrix represent the minimum and the maximum position of a 3D axis-aligned box.

Example: `rrMap= roadrunnerHDMAP(Author="Map Author", GeographicBoundary=[-0.782 -3.13 0;101.565 50 0])` creates a RoadRunner HD Map owned by "Map Author". The spatial bounds of the geometric data in the 3D coordinate space of the map projection is specified by the double precision values of the parameter `GeographicBoundary`.

Data Types: `double`

Lanes — Lane properties of road

array of `roadrunner.hdmap.Lane` objects

Lane properties of a road, specified as an array of `roadrunner.hdmap.Lane` objects.

Example: `rrMap.Lanes(1)= roadrunner.hdmap.Lane(ID="Lane1", Geometry=[-0.782 -1.56;50.78 23.43], LaneType="Driving", TravelDirection="Forward")` adds this information about the lanes for the map: lane id, coordinates defining lane geometry, lane type, and driving direction.

LaneBoundaries — Boundaries of lane

array of `roadrunner.hdmap.LaneBoundary` objects

Boundaries of the lane, specified as an array of `roadrunner.hdmap.LaneBoundary` objects.

Example: `rrMap.LaneBoundaries(1)= roadrunner.hdmap.LaneBoundary(ID="LaneBoundary1", Geometry=[0 0;50 25])` adds the lane boundaries to the lane and defines the geometry for each lane boundary.

LaneGroups — Group of lanes with similar geometry

array of `roadrunner.hdmap.LaneGroup` objects

Group of lanes with similar geometry, specified as an array of `roadrunner.hdmap.LaneGroup` objects.

Example: `rrMap.LaneGroups= roadrunner.hdmap.LaneGroup(ID="LaneGroup1")` adds a lane group with an id "LaneGroup1" to the map.

LaneMarkings — Lane marking definitions

array of `roadrunner.hdmap.LaneMarking` objects

Lane marking definitions, specified as an array of `roadrunner.hdmap.LaneMarking` objects.

Example: `rrMap.LaneMarkings= roadrunner.hdmap.LaneMarking(ID="Dashed1", AssetPath="Assets/Markings/DashedSingleWhite.rrlms")` adds the "Dashed1" lane marking asset from its relative location to the lane.

Junctions — Road junction

array of `roadrunner.hdmap.Junction` objects

Road junctions in the map, specified as an array of `roadrunner.hdmap.Junction` objects.

Example: `rrMap.Junctions= roadrunner.hdmap.Junction(ID="Junction1")` adds a junction with id "Junction1" to the map.

BarrierTypes — Barrier types for barrier extrusion and type information

array of `roadrunner.hdmap.BarrierType` objects

Barrier types for barrier extrusion and type information, specified as an array of `roadrunner.hdmap.BarrierType` objects.

Example: `rrMap.BarrierTypes= roadrunner.hdmap.BarrierType(ID="BarrierType1", ExtrusionPath=path)` adds a barrier type with id "BarrierType1" for a barrier extrusion with the asset path, `path`, pointing to the extrusion information of this barrier type.

Barrier — Barriers in map

array of `roadrunner.hdmap.Barrier` objects

Barriers in the map, specified as an array of `roadrunner.hdmap.Barrier` objects.

Example: `rrMap.Barrier= roadrunner.hdmap.Barrier(ID="Barrier1")` adds a barrier with id "Barrier1" to the map.

SignTypes — Sign types of sign features and type information

array of `roadrunner.hdmap.SignType` objects

Sign types of sign features and type information, specified as an array of `roadrunner.hdmap.SignType` objects.

Example: `rrMap.SignTypes= roadrunner.hdmap.SignType(ID="SignType1", ExtrusionPath=AssetPath="Assets/Signs/UK/Sign_Parking.svg")` adds a sign type with id "SignType1" for a parking sign located on the relative path "Assets/Signs/UK/Sign_Parking.svg".

Signs — Signs in map

array of objects

Signs in the map, specified as an array of `roadrunner.hdmap.Sign` objects.

Example: `rrMap.Sign= roadrunner.hdmap.Sign(ID="Sign1")` adds a sign with id "Sign1" to the map.

StaticObjectType — Attributes of physical objects

array of `roadrunner.hdmap.StaticObjectType` objects

Attributes of physical objects (includes road furniture and props), specified as an array of `roadrunner.hdmap.StaticObjectType` objects.

Example: `rrMap.StaticObjectType= roadrunner.hdmap.StaticObjectType(ID="StaticObjectType1")` adds a static object type with id "StaticObjectType1" to the map.

StaticObject — Static objects in map

array of `roadrunner.hdmap.StaticObject` objects

Attributes of physical objects (includes road furniture and props), specified as an array of `roadrunner.hdmap.StaticObject` objects.

Example: `rrMap.StaticObject= roadrunner.hdmap.StaticObject(ID="StaticObject1")`
 adds a static object with id "StaticObject1" to the map.

Object Functions

`write` Write HD Map to binary file using MATLAB
`read` Read HD Map from binary file using MATLAB
`plot` Plot RoadRunner HD Map using MATLAB
`readCRS` Read coordinate reference system (CRS) data from RoadRunner HD map using MATLAB

Examples

Build a RoadRunner HD Map using Synthetic Data

Create a RoadRunner HD Map by calling the `roadrunnerHDMMap` object. The object returns a map with an author and spatial bounds of geometric data attributes.

```
rrMap = roadrunnerHDMMap(Author="Map Author",GeographicBoundary=[-0.782 -3.13 0;101.565 50 0]);
```

Create the road lanes using the `roadrunner.hdmap.Lane` object. Specify the lane information for the lane id, coordinates defining the lane geometry, driving direction, and lane type.

```
rrMap.Lanes(2) = roadrunner.hdmap.Lane(ID="Lane2",Geometry=[50.78 23.43;100.78 48.43],LaneType="D",DrivingDirection="Forward");
rrMap.Lanes(1) = roadrunner.hdmap.Lane(ID="Lane1",Geometry=[0.782 -1.56;50.78 23.43],LaneType="D",DrivingDirection="Forward");
```

Add connectivity information for Lane1 and Lane2. Specify alignment between the lanes by defining information about their predecessor and successor relationship.

```
addPredecessor(rrMap.Lanes(2),"Lane1",Alignment="Forward");
addSuccessor(rrMap.Lanes(1),"Lane2",Alignment="Forward");
```

Create the lane boundaries of the road using the `roadrunner.hdmap.LaneBoundary` object. Specify the lane boundary information for the lane id and the coordinates defining the lane geometry.

```
rrMap.LaneBoundaries(4) = roadrunner.hdmap.LaneBoundary(ID="LaneBoundary4",Geometry=[50 25; 100 50],LaneType="D",DrivingDirection="Forward");
rrMap.LaneBoundaries(3) = roadrunner.hdmap.LaneBoundary(ID="LaneBoundary3",Geometry=[51.565 21.8; 101.565 48.43],LaneType="D",DrivingDirection="Forward");
rrMap.LaneBoundaries(2) = roadrunner.hdmap.LaneBoundary(ID="LaneBoundary2",Geometry=[1.565 -3.13; 101.565 50],LaneType="D",DrivingDirection="Forward");
rrMap.LaneBoundaries(1) = roadrunner.hdmap.LaneBoundary(ID="LaneBoundary1",Geometry=[0 0; 50 25],LaneType="D",DrivingDirection="Forward");
```

Link the lane boundaries to the lanes. Define the left and the right lane boundaries for each lane, and specify alignment between lanes and lane boundaries.

```
leftBoundary(rrMap.Lanes(1),"LaneBoundary1",Alignment="Forward");
rightBoundary(rrMap.Lanes(1),"LaneBoundary2",Alignment="Forward");
leftBoundary(rrMap.Lanes(2),"LaneBoundary4",Alignment="Forward");
rightBoundary(rrMap.Lanes(2),"LaneBoundary3",Alignment="Forward");
```

Version History

Introduced in R2022b

See Also

`roadrunner`

Topics

“Build Simple Roads Programmatically Using RoadRunner HD Map”

“Build Scenes from Custom Data Using RoadRunner HD Map” (RoadRunner)

addPredecessor

Add predecessor to lane in RoadRunner HD Map using MATLAB

Syntax

```
aPredecessor = addPredecessor(aLane,predecessorID)
aPredecessor = addPredecessor(aLane,predecessorID,Name=Value)
```

Description

`aPredecessor = addPredecessor(aLane,predecessorID)` adds a predecessor with ID `predecessorID` to the `Predecessors` property of the lane and returns it.

`aPredecessor = addPredecessor(aLane,predecessorID,Name=Value)` sets options using one or more name-value arguments.

Examples

Add Predecessor to a Lane in RoadRunner HD Map

Create an empty RoadRunner HD Map by calling the `roadrunnerHDMMap` object.

```
rrMap = roadrunnerHDMMap()
```

```
rrMap =
  roadrunnerHDMMap with properties:
```

```

    Author: ""
  Projection: ""
GeographicBoundary: [0x3 double]
        Lanes: [0x1 roadrunner.hdmap.Lane]
LaneBoundaries: [0x1 roadrunner.hdmap.LaneBoundary]
  LaneGroups: [0x1 roadrunner.hdmap.LaneGroup]
LaneMarkings: [0x1 roadrunner.hdmap.LaneMarking]
  Junctions: [0x1 roadrunner.hdmap.Junction]
BarrierTypes: [0x1 roadrunner.hdmap.BarrierType]
    Barriers: [0x1 roadrunner.hdmap.Barrier]
  SignTypes: [0x1 roadrunner.hdmap.SignType]
        Signs: [0x1 roadrunner.hdmap.Sign]
```

Create two road lanes using the `roadrunner.hdmap.Lane` object. Specify the lane information for the lane id, coordinates defining the lane geometry, driving direction, and lane type.

```
rrMap.Lanes(2) = roadrunner.hdmap.Lane(ID="Lane2",Geometry=[-0.782 -1.56;50.78 23.43],TravelDire
```

```
rrMap =
  roadrunnerHDMMap with properties:
```

```

    Author: ""
  Projection: ""
```

```

    GeographicBoundary: [0×3 double]
        Lanes: [2×1 roadrunner.hdmap.Lane]
    LaneBoundaries: [0×1 roadrunner.hdmap.LaneBoundary]
    LaneGroups: [0×1 roadrunner.hdmap.LaneGroup]
    LaneMarkings: [0×1 roadrunner.hdmap.LaneMarking]
    Junctions: [0×1 roadrunner.hdmap.Junction]
    BarrierTypes: [0×1 roadrunner.hdmap.BarrierType]
    Barriers: [0×1 roadrunner.hdmap.Barrier]
    SignTypes: [0×1 roadrunner.hdmap.SignType]
    Signs: [0×1 roadrunner.hdmap.Sign]

rrMap.Lanes(1) = roadrunner.hdmap.Lane(ID="Lane1",Geometry=[-0.534 -2.43;25.78 46.43],TravelDirec

rrMap =
    roadrunnerHDMAP with properties:

        Author: ""
        Projection: ""
    GeographicBoundary: [0×3 double]
        Lanes: [2×1 roadrunner.hdmap.Lane]
    LaneBoundaries: [0×1 roadrunner.hdmap.LaneBoundary]
    LaneGroups: [0×1 roadrunner.hdmap.LaneGroup]
    LaneMarkings: [0×1 roadrunner.hdmap.LaneMarking]
    Junctions: [0×1 roadrunner.hdmap.Junction]
    BarrierTypes: [0×1 roadrunner.hdmap.BarrierType]
    Barriers: [0×1 roadrunner.hdmap.Barrier]
    SignTypes: [0×1 roadrunner.hdmap.SignType]
    Signs: [0×1 roadrunner.hdmap.Sign]

```

Add Lane1 as a predecessor to Lane2.

```
addPredecessor(rrMap.Lanes(2), "Lane1")
```

```
ans =
    AlignedReference with properties:

        Reference: [1×1 roadrunner.hdmap.Reference]
        Alignment: Unspecified

```

Input Arguments

aLane — Lane properties of road

roadrunner.hdmap.Lane object

Lane properties of a road, specified as a roadrunner.hdmap.Lane object.

Example: aLane= roadrunner.hdmap.Lane(ID="Lane1", Geometry=[-0.782 -1.56;50.78 23.43], LaneType="Driving", TravelDirection="Forward") creates a lane with properties lane id, coordinates defining lane geometry, lane type, and driving direction.

predecessorID — ID of predecessor lane

character vector | string scalar

ID of the predecessor lane, specified as a string.

Example: `addPredecessor(rrMap.Lanes(2),"Lane1")` assigns Lane1 as the predecessor of Lane2 in a RoadRunner HD Map.

Data Types: `char` | `string`

Name-Value Pair Arguments

Specify optional pairs of arguments as `Name1=Value1, . . . ,NameN=ValueN`, where `Name` is the argument name and `Value` is the corresponding value. Name-value arguments must appear after other arguments, but the order of the pairs does not matter.

Example:

Alignment — Type of alignment

`character vector` | `string scalar`

Type of alignment between linked objects, specified as a character vector or string scalar. The type of alignment is specified as one of the following strings: "Unspecified", "Forward", or "Backward".

Example: `alref= roadrunner.hdmap.AlignedReference(Reference=ref, Alignment="Forward")` creates the aligned reference for Lane2 with "Forward" alignment.

Data Types: `char` | `string`

Output Arguments

aPredecessor — Linkage information for preceding lanes

`roadrunner.hdmap.AlignedReference` object

Linkage information for preceding lanes, specified as a `roadrunner.hdmap.AlignedReference` object.

Version History

Introduced in R2022b

See Also

`roadrunnerHDMAP` | `roadrunner.hdmap.Lane` | `roadrunner.hdmap.AlignedReference` | `addSuccessor`

Topics

"Build Simple Roads Programmatically Using RoadRunner HD Map" (RoadRunner)
 "Build Scenes from Custom Data Using RoadRunner HD Map" (RoadRunner)

readCRS

Read coordinate reference system (CRS) data from RoadRunner HD map using MATLAB

Syntax

```
crs = readCRS(rrMap)
```

Description

`crs = readCRS(rrMap)` reads the coordinate reference system data from the RoadRunner HD map `rrMap`.

This function requires Mapping Toolbox.

Examples

Read CRS Data from RoadRunner HD Map

Create a RoadRunner HD map, represented by a `roadrunnerHDMMap` object. Specify an author and spatial bounds for the geometric data attributes of the map.

```
rrMap = roadrunnerHDMMap(Author="Map Author",GeographicBoundary=[-0.782 -3.13 0; 101.565 50 0]);
```

Read the CRS data from the RoadRunner HD map file using the `readCRS` function and generate a `projcrs` object.

```
crs = readCRS(rrMap);  
disp(crs)
```

```
projcrs with properties:
```

```
          Name: "WGS 84 / Transverse Mercator"  
    GeographicCRS: [1x1 geocrs]  
    ProjectionMethod: "Transverse Mercator"  
          LengthUnit: "meter"  
    ProjectionParameters: [1x1 map.crs.ProjectionParameters]
```

Input Arguments

rrMap — RoadRunner HD Map road data model

`roadrunnerHDMMap` object

RoadRunner HD Map road data model, specified as a `roadrunnerHDMMap` object. `rrMap` defines a simple data structure to represent road layouts using lanes, lane boundaries, lane markings, and junctions. This object provides functions that support reading, writing, and plotting HD map data.

Output Arguments

crs — Coordinate reference system

geocrs object | projcrs object

Coordinate reference system (CRS), returned as one of these objects:

- `geocrs` — Returned by a file that contains geographic CRS data.
- `projcrs` — Returned by a file that contains projected CRS data.

Version History

Introduced in R2023a

See Also

Objects

roadrunnerHDMap | roadrunner

Functions

read | plot | write

Topics

“Build Simple Roads Programmatically Using RoadRunner HD Map”

vehicleCostmap

Costmap representing planning space around vehicle

Description

The `vehicleCostmap` object creates a costmap that represents the planning search space around a vehicle. The costmap holds information about the environment, such as obstacles or areas that the vehicle cannot traverse. To check for collisions, the costmap inflates obstacles using the inflation radius specified in the `CollisionChecker` property. The costmap is used by path planning algorithms, such as `pathPlannerRRT`, to find collision-free paths for the vehicle to follow.

The costmap is stored as a 2-D grid of cells, often called an occupancy grid or occupancy map. Each grid cell in the costmap has a value in the range $[0, 1]$ representing the cost of navigating through that grid cell. The state of each grid cell is free, occupied, or unknown, as determined by the `FreeThreshold` and `OccupiedThreshold` properties.

The following figure shows a costmap with sample costs and grid cell states.

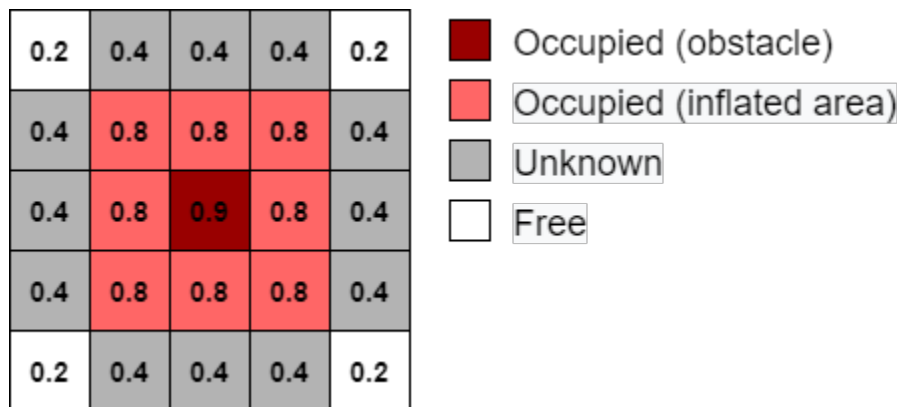

Creation

Syntax

```

costmap = vehicleCostmap(C)
costmap = vehicleCostmap(mapWidth, mapLength)
costmap = vehicleCostmap(mapWidth, mapLength, costVal)
costmap = vehicleCostmap(occMap)
costmap = vehicleCostmap( ____, 'MapLocation', mapLocation)
costmap = vehicleCostmap( ____, Name, Value)

```

Description

`costmap = vehicleCostmap(C)` creates a vehicle costmap using the cost values in matrix `C`.

`costmap = vehicleCostmap(mapWidth,mapLength)` creates a vehicle costmap representing an area of width `mapWidth` and length `mapLength` in world units. By default, each grid cell is in the unknown state.

`costmap = vehicleCostmap(mapWidth,mapLength,costVal)` also assigns a default cost, `costVal`, to each cell in the grid.

`costmap = vehicleCostmap(occMap)` creates a vehicle costmap from the occupancy map `occMap`. Use of this syntax requires Navigation Toolbox™.

`costmap = vehicleCostmap(____, 'MapLocation',mapLocation)` specifies in `mapLocation` the bottom-left corner coordinates of the costmap. Specify 'MapLocation', `mapLocation` after any of the preceding inputs and in any order among the Name, Value pair arguments.

`costmap = vehicleCostmap(____, Name, Value)` uses Name, Value pair arguments to specify the `FreeThreshold`, `OccupiedThreshold`, `CollisionChecker`, and `CellSize` properties. For example, `vehicleCostmap(C, 'CollisionChecker', ccConfig)` uses an `inflationCollisionChecker` object, `ccConfig`, to represent the vehicle shape and check for collisions. After you create the object, you can update all of these properties except `CellSize`.

Input Arguments

C — Cost values

matrix of real values in the range [0, 1]

Cost values, specified as a matrix of real values that are in the range [0, 1].

When creating a `vehicleCostmap` object, if you do not specify `C` or a uniform cost value, `costVal`, then the default cost value of each grid cell is $(FreeThreshold + OccupiedThreshold)/2$.

Data Types: `single` | `double`

mapWidth — Width of costmap

positive real scalar

Width of costmap, in world units, specified as a positive real scalar.

mapLength — Length of costmap

positive real scalar

Length of costmap, in world units, specified as a positive real scalar.

costVal — Uniform cost value

real scalar in the range [0, 1]

Uniform cost value applied to all cells in the costmap, specified as a real scalar in the range [0, 1].

When creating a `vehicleCostmap` object, if you do not specify `costVal` or a cost value matrix, `C`, then the default cost value of each grid cell is $(FreeThreshold + OccupiedThreshold)/2$.

occMap — Occupancy map

`occupancyMap` object | `binaryOccupancyMap` object

Occupancy map, specified as an `occupancyMap` or `binaryOccupancyMap` object. Use of this argument requires Navigation Toolbox.

mapLocation — Costmap location

`[0 0]` (default) | two-element real-valued vector of form `[mapX mapY]`

Costmap location, specified as a two-element real-valued vector of the form `[mapX mapY]`. This vector specifies the coordinate location of the bottom-left corner of the costmap.

Example: 'MapLocation', [8 8]

Properties**FreeThreshold — Threshold below which grid cell is free**

`0.2` (default) | real scalar in the range `[0, 1]`

Threshold below which a grid cell is free, specified as a real scalar in the range `[0, 1]`.

A grid cell with cost c can have one of these states:

- If $c < \text{FreeThreshold}$, the grid cell state is *free*.
- If $c \geq \text{FreeThreshold}$ and $c \leq \text{OccupiedThreshold}$, the grid cell state is *unknown*.
- If $c > \text{OccupiedThreshold}$, the grid cell state is *occupied*.

OccupiedThreshold — Threshold above which grid cell is occupied

`0.65` (default) | real scalar in the range `[0, 1]`

Threshold above which a grid cell is occupied, specified as a real scalar in the range `[0, 1]`.

A grid cell with cost c can have one of these states:

- If $c < \text{FreeThreshold}$, the grid cell state is *free*.
- If $c \geq \text{FreeThreshold}$ and $c \leq \text{OccupiedThreshold}$, the grid cell state is *unknown*.
- If $c > \text{OccupiedThreshold}$, the grid cell state is *occupied*.

CollisionChecker — Collision-checking configuration

`inflationCollisionChecker()` (default) | `InflationCollisionChecker` object

Collision-checking configuration, specified as an `InflationCollisionChecker` object. To create this object, use the `inflationCollisionChecker` function. Using the properties of the `InflationCollisionChecker` object, you can configure:

- The inflation radius used to inflate obstacles in the costmap
- The number of circles used to enclose the vehicle when calculating the inflation radius
- The placement of each circle along the longitudinal axis of the vehicle
- The dimensions of the vehicle

By default, `CollisionChecker` uses the default `InflationCollisionChecker` object, which is created using the syntax `inflationCollisionChecker()`. This collision-checking configuration encloses the vehicle in one circle.

MapExtent — Extent of costmap

four-element, nonnegative integer vector of form `[xmin xmax ymin ymax]`

This property is read-only.

Extent of costmap around the vehicle, specified as a four-element, nonnegative integer vector of the form $[xmin\ xmax\ ymin\ ymax]$.

- $xmin$ and $xmax$ describe the length of the map in world coordinates.
- $ymin$ and $ymax$ describe the width of the map in world coordinates.

CellSize — Side length of each square cell

1 (default) | positive real scalar

Side length of each square cell, in world units, specified as a positive real scalar. For example, a side length of 1 implies a grid where each cell is a square of size 1-by-1 meters. Smaller values improve the resolution of the search space at the cost of increased memory consumption.

You can specify `CellSize` when you create the `vehicleCostmap` object. However, after you create the object, `CellSize` becomes read-only.

MapSize — Size of costmap grid

two-element, positive integer vector of form $[nrows\ ncols]$

This property is read-only.

Size of costmap grid, specified as a two-element, positive integer vector of the form $[nrows\ ncols]$.

- $nrows$ is the number of grid cell rows in the costmap.
- $ncols$ is the number of grid cell columns in the costmap.

Object Functions

<code>checkFree</code>	Check vehicle costmap for collision-free poses or points
<code>checkOccupied</code>	Check vehicle costmap for occupied poses or points
<code>getCosts</code>	Get cost value of cells in vehicle costmap
<code>setCosts</code>	Set cost value of cells in vehicle costmap
<code>plot</code>	Plot vehicle costmap

Examples

Create and Populate a Vehicle Costmap

Create a 10-by-20 meter costmap that is divided into square cells of size 0.5-by-0.5 meters. Specify a default cost value of 0.5 for all cells.

```
mapWidth = 10;
mapLength = 20;
costVal = 0.5;
cellSize = 0.5;
```

```
costmap = vehicleCostmap(mapWidth,mapLength,costVal,'CellSize',cellSize)
```

```
costmap =
  vehicleCostmap with properties:
```

```
    FreeThreshold: 0.2000
  OccupiedThreshold: 0.6500
    CollisionChecker: [1x1 driving.costmap.InflationCollisionChecker]
```

```
CellSize: 0.5000  
MapSize: [40 20]  
MapExtent: [0 10 0 20]
```

Mark an obstacle on the costmap. Display the costmap.

```
occupiedVal = 0.9;  
xyPoint = [2,4];  
setCosts(costmap,xyPoint,occupiedVal)
```

```
plot(costmap)
```

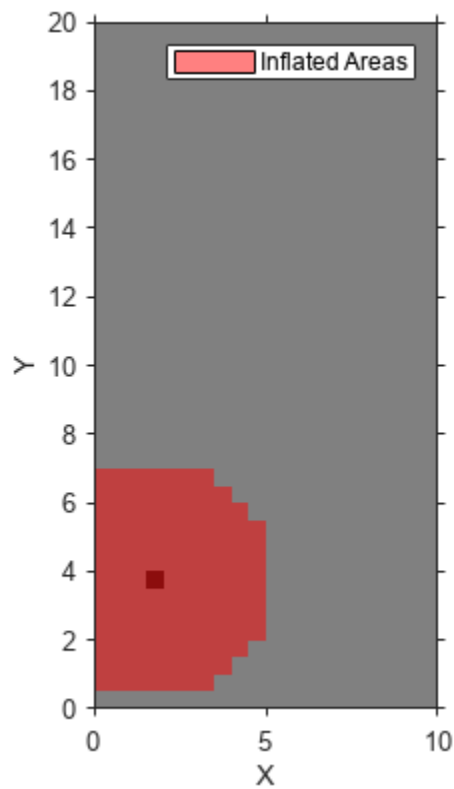

Mark an obstacle-free area on the costmap. Display the costmap again.

```
freeVal = 0.15;  
[X,Y] = meshgrid(3.5:cellSize:5,0.5:cellSize:1.5);  
setCosts(costmap,[X(:),Y(:)],freeVal)  
plot(costmap)
```

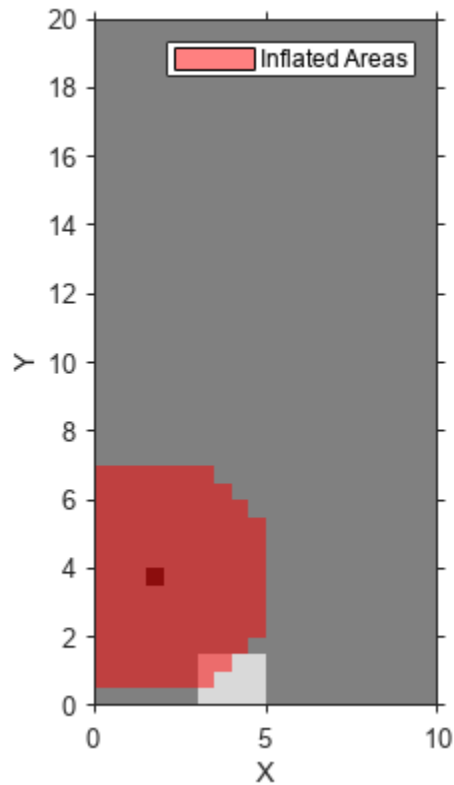

Plan Path Using A-Star Path Planners

Plan the shortest vehicle path to a parking spot using the A* grid algorithm. Then impose nonholonomic constraints on the vehicle and replan the path using the Hybrid A* algorithm.

Create Occupancy Map

Load a costmap of a parking lot. Create an `occupancyMap` (Navigation Toolbox) object using the properties of the costmap object. Visualize the occupancy map.

```
data = load('parkingLotCostmapReducedInflation.mat');
costmapObj = data.parkingLotCostmapReducedInflation;
resolution = 1/costmapObj.CellSize;
oMap = occupancyMap(costmapObj.Costmap, resolution);
oMap.FreeThreshold = costmapObj.FreeThreshold;
oMap.OccupiedThreshold = costmapObj.OccupiedThreshold;
show(oMap)
```

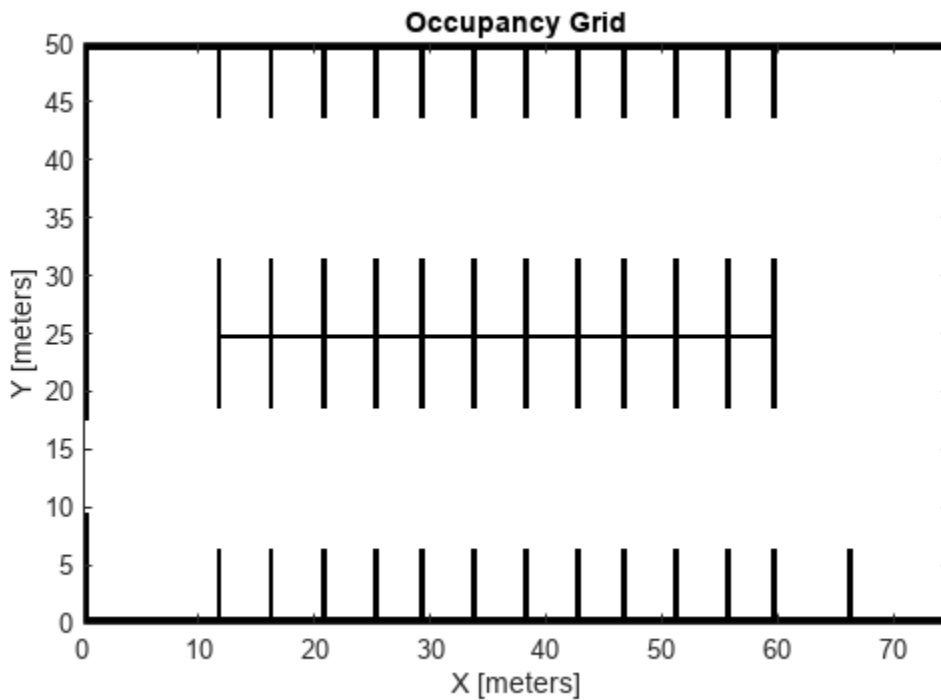

Plan Path Using A* Grid Planner

Use the occupancy map to create a `plannerAStarGrid` (Navigation Toolbox) object.

```
gridPlanner = plannerAStarGrid(oMap);
```

Define the start and goal positions in world coordinate frame. The origin of this coordinate frame is at the bottom-left corner of the map.

```
startPos = [11,10];  
goalPos  = [31.5,18];
```

Plan a path from the start point to the goal point in world coordinates.

```
path = plan(gridPlanner,startPos,goalPos,"world");
```

Visualize the path and the explored nodes using the `show` object function.

```
show(gridPlanner)
```

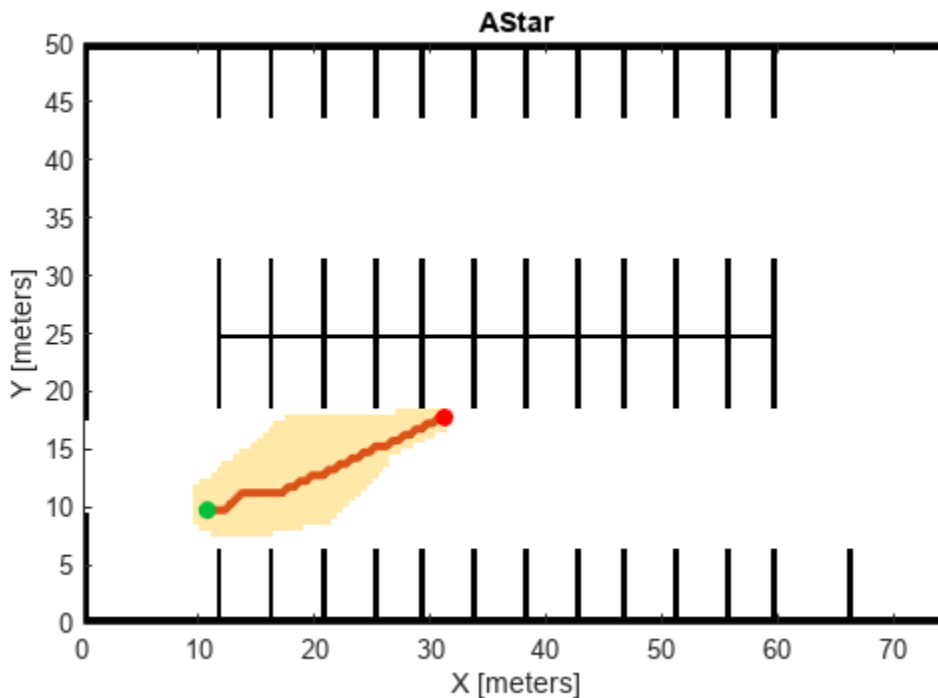

Impose Nonholonomic Constraints and Replan Using Hybrid A* Planner

Create a state validator object for validating planned path using collision checking. Assign the occupancy map to the state validator object.

```
validator = validatorOccupancyMap;
validator.Map = oMap;
```

Initialize a `plannerHybridAStar` (Navigation Toolbox) object with the state validator object. Impose the nonholonomic constraints of minimum turning radius and motion primitive length by specifying the `MinTurningRadius` and `MotionPrimitiveLength` properties of the planner.

```
hybridPlanner = plannerHybridAStar(validator,MinTurningRadius=4,MotionPrimitiveLength=6);
```

Define start and goal poses for the vehicle as $[x, y, \theta]$ vectors. x and y specify the position in meters, and θ specifies the orientation angle in radians.

```
startPose = [4 4 pi/2]; % [meters, meters, radians]
goalPose = [45 27 -pi/2];
```

Plan a path from the start pose to the goal pose.

```
refpath = plan(hybridPlanner,startPose,goalPose);
```

Visualize the path using `show` object function.

```
show(hybridPlanner)
```

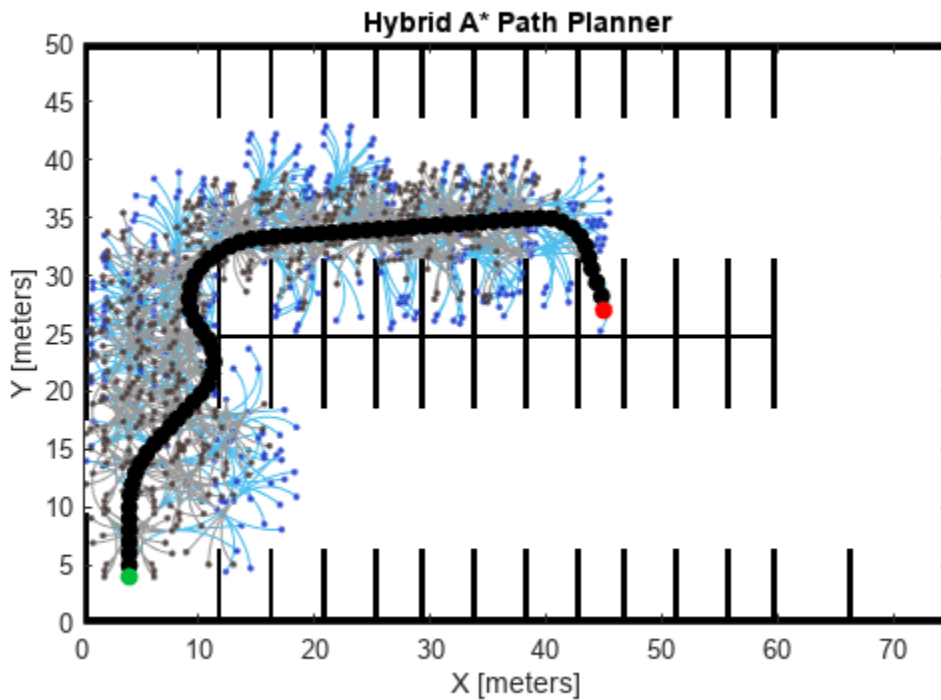

Algorithms

To simplify checking for whether a vehicle pose is in collision, `vehicleCostmap` inflates the size of obstacles. The collision-checking algorithm follows these steps:

- 1 Calculate the inflation radius, in world units, from the vehicle dimensions. The default inflation radius is equal to the radius of the smallest set of overlapping circles required to completely enclose the vehicle. The center points of the circles lie along the longitudinal axis of the vehicle. Increasing the number of circles decreases the inflation radius, which enables more precise collision checking.

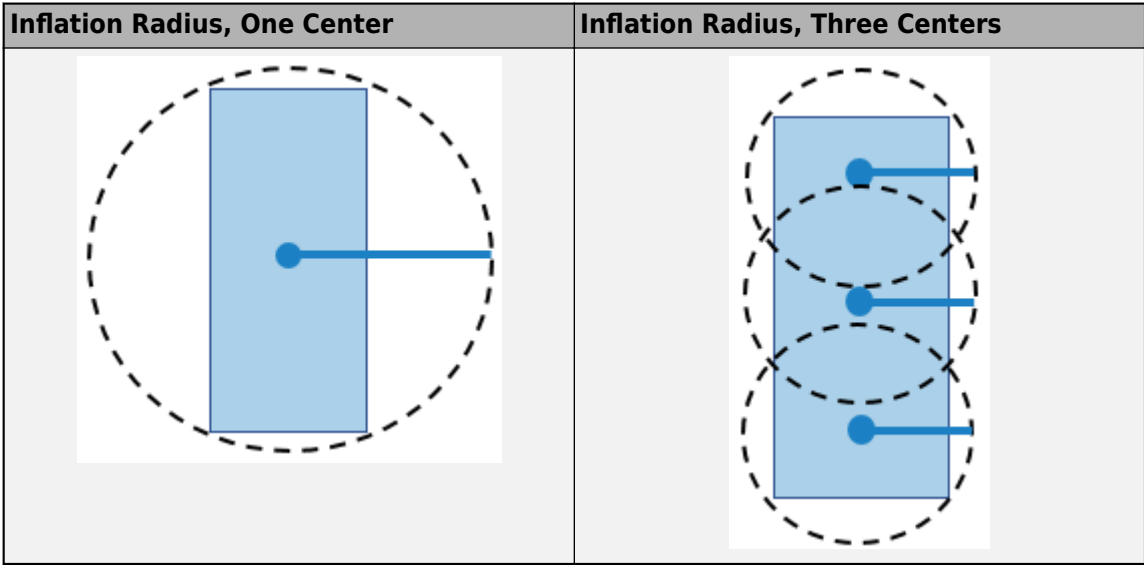

- 2 Convert the inflation radius to a number of grid cells, R . Round up noninteger values of R to the next largest integer.
- 3 Inflate the size of obstacles using R . Label all cells in the inflated area as occupied.

The diagrams show occupied cells in dark red. Cells in the inflated area are colored in light red. The solid black line shows the original inflation radius. In the diagram on the left, R is 3. In the diagram on the right, R is 2.

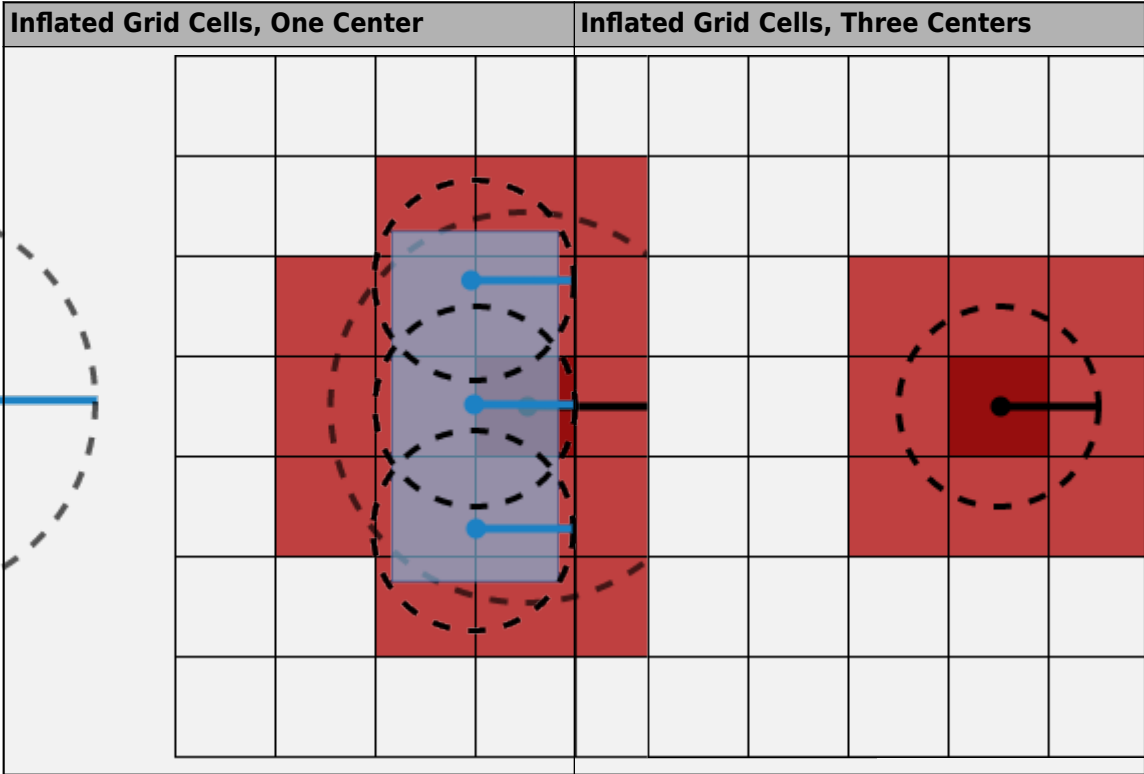

- 4 Check whether the center points of the vehicle lie on inflated grid cells.

- If any center point lies on an inflated grid cell, then the vehicle pose is *occupied*. The `checkOccupied` function returns `true`. An occupied pose does not necessarily mean a collision. For example, the vehicle might lie on an inflated grid cell but not on the grid cell that is actually occupied.
- If no center points lie on inflated grid cells, and the cost value of each cell containing a center point is less than `FreeThreshold`, then the vehicle pose is *free*. The `checkFree` function returns `true`.
- If no center points lie on inflated grid cells, and the cost value of any cell containing a center point is greater than `FreeThreshold`, then the vehicle pose is *unknown*. Both `checkFree` and `checkOccupied` return `false`.

The following poses are considered in collision because at least one center point is on an inflated area.

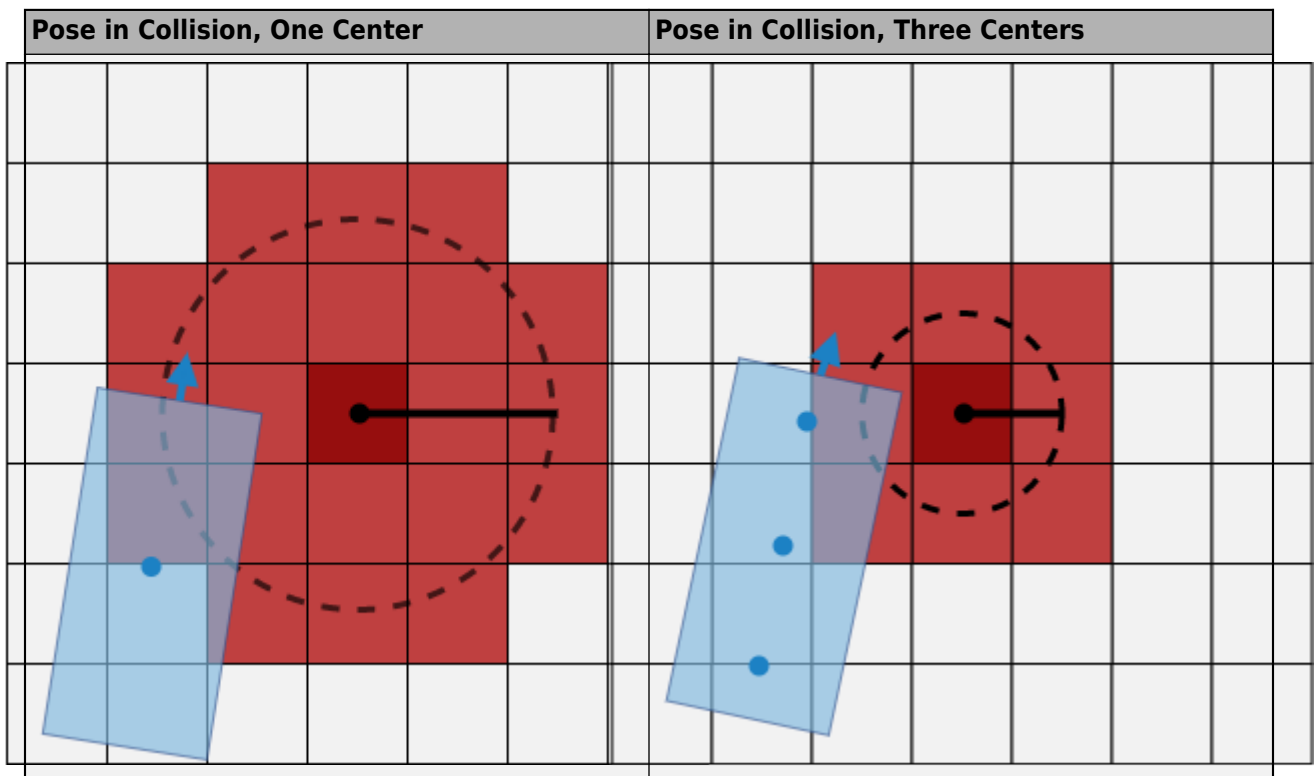

Version History

Introduced in R2018a

R2020b: InflationRadius and VehicleDimensions properties have been removed

Errors starting in R2020b

The `InflationRadius` and `VehicleDimensions` properties of the `vehicleCostmap` object have been removed. Follow this process instead:

- 1 Use the `inflationCollisionChecker` function to create an `InflationCollisionChecker` object, which has the `InflationRadius` and `VehicleDimensions` properties.

- Specify this object as the value of the `CollisionChecker` property of `vehicleCostmap`.

If you do specify these properties for `vehicleCostmap`, the object returns an error.

When the `vehicleCostmap` object was introduced in R2018a, this object inflated obstacles based on the specified inflation radius and vehicle dimensions only. The `InflationCollisionChecker` object, which is specified in the `CollisionChecker` property of `vehicleCostmap`, provides additional configuration options for inflating obstacles. For example, you can specify the number of circles used to compute the inflation radius, enabling more precise collision checking.

Update Code

The table shows a typical usage of the `InflationRadius` and `VehicleDimensions` properties of `vehicleCostmap`. It also shows how to update your code using the corresponding properties of an `InflationCollisionChecker` object.

Invalid Usage	Recommended Replacement
<pre>vehicleDims = vehicleDimensions(5,2); inflationRadius = 1.2; costmap = vehicleCostmap(C, ... 'VehicleDimensions',vehicleDims, ... 'InflationRadius',inflationRadius);</pre>	<pre>vehicleDims = vehicleDimensions(5,2); inflationRadius = 1.2; ccConfig = inflationCollisionChecker(vehicleDims, ... 'InflationRadius',inflationRadius); costmap = vehicleCostmap(C, ... 'CollisionChecker',ccConfig);</pre>

Extended Capabilities

C/C++ Code Generation

Generate C and C++ code using MATLAB® Coder™.

Usage notes and limitations:

- `occupancyMap` and `binaryOccupancyMap` inputs are not supported.
- The collision-checking configuration stored in the `CollisionChecker` property must be a compile-time constant.
- The `mapLocation` input argument must be a compile-time constant.

See Also

`pathPlannerRRT` | `inflationCollisionChecker`

Topics

“Automated Parking Valet”

“Create Occupancy Grid Using Monocular Camera and Semantic Segmentation”

checkFree

Check vehicle costmap for collision-free poses or points

Syntax

```
free = checkFree(costmap, vehiclePoses)
free = checkFree(costmap, xyPoints)
freeMat = checkFree(costmap)
```

Description

The `checkFree` function checks whether vehicle poses or points are free from obstacles on the vehicle costmap. Path planning algorithms use `checkFree` to check whether candidate vehicle poses along a path are navigable.

To simplify the collision check for a vehicle pose, `vehicleCostmap` inflates obstacles according to the vehicle's `InflationRadius`, as specified by the `CollisionChecker` property of the costmap. The collision checker calculates the inflation radius by enclosing the vehicle in a set of overlapping circles of radius R , where the centers of these circles lie along the longitudinal axis of the vehicle. The inflation radius is the minimum R needed to fully enclose the vehicle in these circles.

A vehicle pose is collision-free when the following conditions apply:

- None of the vehicle's circle centers lie on an inflated grid cell.
- The cost value of each containing a circle center is less than the `FreeThreshold` of the costmap.

For more details, see the algorithm on page 4-1404 on the `vehicleCostmap` reference page.

`free = checkFree(costmap, vehiclePoses)` checks whether the vehicle poses are free from collision with obstacles on the costmap.

`free = checkFree(costmap, xyPoints)` checks whether (x, y) points in `xyPoints` are free from collision with obstacles on the costmap.

`freeMat = checkFree(costmap)` returns a logical matrix that indicates whether each cell of the costmap is free.

Examples

Check If Sequence of Poses Is Collision-Free

Load a costmap from a parking lot.

```
data = load('parkingLotCostmap.mat');
parkMap = data.parkingLotCostmap;
plot(parkMap)
```

Create vehicle poses following a straight-line path. `x` and `y` are the (x,y) coordinates of the rear axle of the vehicle. `theta` is the angle of the rear axle with respect to the x -axis. Note that the dimensions

of the vehicle are stored in the `CollisionChecker.VehicleDimensions` property of the costmap, and that there is an offset between the rear axle of the vehicle and its center.

```
x = 4:0.25:6;
y = 3:0.25:5;
theta = repmat(45,size(x));
vehiclePoses = [x',y',theta'];
hold on
plot(x,y,'b.')
hold off
```

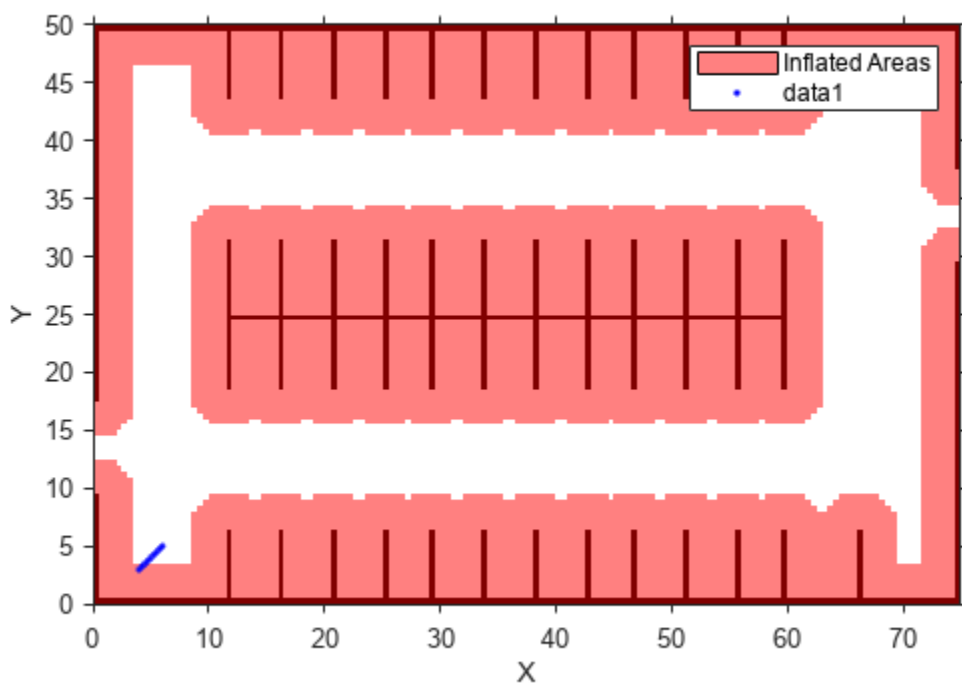

The first few (x,y) coordinates of the rear axle are within the inflated area. However, this does not imply a collision because the center of the vehicle may be outside the inflated area. Check if the poses are collision-free.

```
free = checkFree(parkMap,vehiclePoses)
```

```
free = 9x1 logical array
```

```
1
1
1
1
1
1
1
1
1
```

1

All values of `free` are 1 (`true`), so all poses are collision-free. The center of the vehicle does not enter the inflated area at any pose.

Input Arguments

costmap — Costmap

`vehicleCostmap` object

Costmap, specified as a `vehicleCostmap` object.

vehiclePoses — Vehicle poses

m -by-3 matrix of $[x, y, \theta]$ vectors

Vehicle poses, specified as an m -by-3 matrix of $[x, y, \theta]$ vectors. m is the number of poses.

x and y specify the location of the vehicle in world units, such as meters. This location is the center of the rear axle of the vehicle.

θ specifies the orientation angle of the vehicle in degrees with respect to the x -axis. θ is positive in the clockwise direction.

Example: `[3.4 2.6 0]` specifies a vehicle with the center of the rear axle at (3.4, 2.6) and an orientation angle of 0 degrees.

xyPoints — Points

M -by-2 real-valued matrix

Points, specified as an M -by-2 real-valued matrix that represents the (x, y) coordinates of M points.

Example: `[3.4 2.6]` specifies a single point at (3.4, 2.6)

Example: `[3 2; 3 3; 4 7]` specifies three points: (3, 2), (3, 3), and (4, 7)

Output Arguments

free — Vehicle pose or point is free

M -by-1 logical vector

Vehicle pose or point is free, returned as an M -by-1 logical vector. An element of `free` is 1 (`true`) when the corresponding vehicle pose in `vehiclePoses` or point in `xyPoints` is collision-free.

freeMat — Costmap cell is free

logical matrix

Costmap cell is free, returned as a logical matrix of the same size as the costmap grid. This size is specified by the `MapSize` property of the `costmap`. An element of `freeMat` is 1 (`true`) when the corresponding cell in `costmap` is unoccupied and the cost value of the cell is below the `FreeThreshold` of the costmap.

Tips

- If you specify a small value of `InflationRadius` that does not completely enclose the vehicle, then `checkFree` might report occupied poses as collision-free. To avoid this situation, the default value of `InflationRadius` completely encloses the vehicle.

Version History

Introduced in R2018a

Extended Capabilities

C/C++ Code Generation

Generate C and C++ code using MATLAB® Coder™.

See Also

Objects

`vehicleCostmap` | `pathPlannerRRT` | `inflationCollisionChecker`

Functions

`checkOccupied` | `checkPathValidity`

checkOccupied

Check vehicle costmap for occupied poses or points

Syntax

```
occ = checkOccupied(costmap,vehiclePoses)
occ = checkOccupied(costmap,xyPoints)
occMat = checkOccupied(costmap)
```

Description

The `checkOccupied` function checks whether vehicle poses or points are occupied by obstacles on the vehicle costmap. Path planning algorithms use `checkOccupied` to check whether candidate vehicle poses along a path are navigable.

To simplify the collision check for a vehicle pose, `vehicleCostmap` inflates obstacles according to the vehicle's `InflationRadius`, as specified by the `CollisionChecker` property of the costmap. The collision checker calculates the inflation radius by enclosing the vehicle in a set of overlapping circles of radius R , where the centers of these circles lie along the longitudinal axis of the vehicle. The inflation radius is the minimum R needed to fully enclose the vehicle in these circles. A vehicle pose is collision-free when none of the centers of these circles lie on an inflated grid cell. For more details, see the algorithm on page 4-1404 on the `vehicleCostmap` reference page.

`occ = checkOccupied(costmap,vehiclePoses)` checks whether the vehicle poses are occupied.

`occ = checkOccupied(costmap,xyPoints)` checks whether (x, y) points in `xyPoints` are occupied.

`occMat = checkOccupied(costmap)` returns a logical matrix that indicates whether each cell of the costmap is occupied.

Examples

Check If Sequence of Poses Enters Occupied Cell

Load a costmap from a parking lot.

```
data = load('parkingLotCostmap.mat');
parkMap = data.parkingLotCostmap;
plot(parkMap)
```

Create vehicle poses following a straight-line path. x and y are the (x,y) coordinates of the rear axle of the vehicle. θ is the angle of the rear axle with respect to the x -axis. Note that the dimensions of the vehicle are stored in the `vehicleDimensions` property of the costmap, and that there is an offset between the rear axle of the vehicle and its center.

```
x = 6:0.25:10;
y = repmat(5,size(x));
theta = zeros(size(x));
```

```

vehiclePoses = [x',y',theta'];
hold on
plot(x,y,'b.')
```

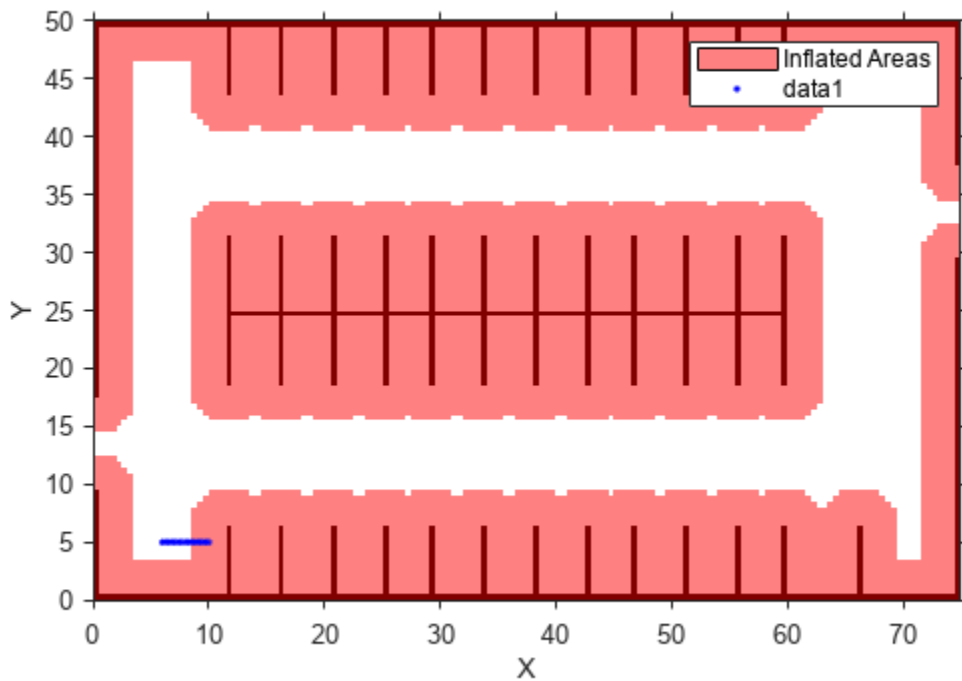

Check if the poses are occupied.

```
occ = checkOccupied(parkMap,vehiclePoses)
```

```
occ = 17x1 logical array
```

```

0
0
0
0
0
1
1
1
1
1
1
⋮
```

The vehicle poses are occupied beginning with the sixth pose. In other words, the center of the vehicle in the sixth pose lies within the inflation radius of an occupied grid cell.

Input Arguments

costmap — Costmap

vehicleCostmap object

Costmap, specified as a vehicleCostmap object.

vehiclePoses — Vehicle poses

m -by-3 matrix of $[x, y, \theta]$ vectors

Vehicle poses, specified as an m -by-3 matrix of $[x, y, \theta]$ vectors. m is the number of poses.

x and y specify the location of the vehicle in world units, such as meters. This location is the center of the rear axle of the vehicle.

θ specifies the orientation angle of the vehicle in degrees with respect to the x -axis. θ is positive in the clockwise direction.

Example: `[3.4 2.6 0]` specifies a vehicle with the center of the rear axle at (3.4, 2.6) and an orientation angle of 0 degrees.

xyPoints — Points

M -by-2 real-valued matrix

Points, specified as an M -by-2 real-valued matrix that represents the (x, y) coordinates of M points.

Example: `[3.4 2.6]` specifies a single point at (3.4, 2.6)

Example: `[3 2; 3 3; 4 7]` specifies three points: (3, 2), (3, 3), and (4, 7)

Output Arguments

occ — Vehicle pose or point is occupied

M -by-1 logical vector

Vehicle pose or point is occupied, returned as an M -by-1 logical vector. An element of `occ` is 1 (`true`) when the corresponding vehicle pose in `vehiclePoses` or planar point in `xyPoints` is occupied.

occMat — Costmap cell is occupied

logical matrix

Costmap cell is occupied, returned as a logical matrix of the same size as the costmap grid. This size is specified by the `MapSize` property of the `costmap`. An element of `occMat` is 1 (`true`) when the corresponding cell in `costmap` is occupied.

Version History

Introduced in R2018a

Extended Capabilities

C/C++ Code Generation

Generate C and C++ code using MATLAB® Coder™.

See Also

Objects

vehicleCostmap | pathPlannerRRT | inflationCollisionChecker

Functions

checkFree | checkPathValidity

getCosts

Get cost value of cells in vehicle costmap

Syntax

```
costVals = getCosts(costmap,xyPoints)
costMat = getCosts(costmap)
```

Description

`costVals = getCosts(costmap,xyPoints)` returns a vector, `costVals`, that contains the costs for the (x, y) points in `xyPoints` in the vehicle costmap.

`costMat = getCosts(costmap)` returns a matrix, `costMat`, that contains the cost of each cell in the costmap.

Examples

Get Cost Matrix and Set Cost Values

Create a 5-by-10 meter vehicle costmap. Cells have side length 1, in the world units of meters. Set the inflation radius to 1. Plot the costmap, and get the default cost matrix.

```
costmap = vehicleCostmap(5,10);
costmap.CollisionChecker.InflationRadius = 1;
plot(costmap)
title('Default Costmap')
```

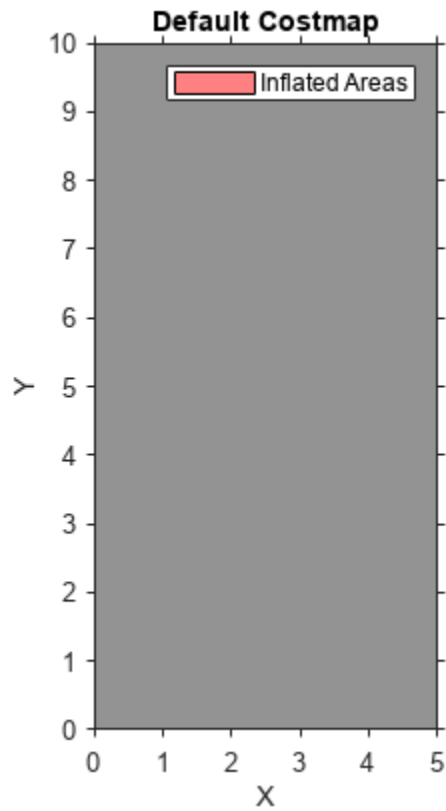

```
getCosts(costmap)
```

```
ans = 10x5
```

```

0.4250    0.4250    0.4250    0.4250    0.4250
0.4250    0.4250    0.4250    0.4250    0.4250
0.4250    0.4250    0.4250    0.4250    0.4250
0.4250    0.4250    0.4250    0.4250    0.4250
0.4250    0.4250    0.4250    0.4250    0.4250
0.4250    0.4250    0.4250    0.4250    0.4250
0.4250    0.4250    0.4250    0.4250    0.4250
0.4250    0.4250    0.4250    0.4250    0.4250
0.4250    0.4250    0.4250    0.4250    0.4250
0.4250    0.4250    0.4250    0.4250    0.4250

```

Mark an obstacle at the (x,y) coordinate (3,4) by increasing the cost of that cell.

```

setCosts(costmap, [3,4], 0.8);
plot(costmap)
title('Costmap with Obstacle at (3,4)')

```

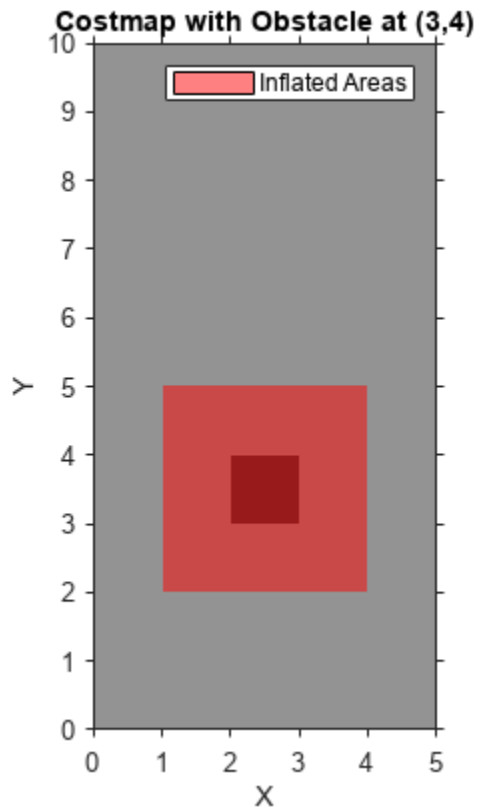

Get the cost of three cells: the cell with the obstacle, a cell adjacent to the obstacle, and a cell outside the inflation radius of the obstacle.

```
costVal = getCosts(costmap, [3 4; 2 4; 4 7])
```

```
costVal = 3×1
```

```
0.8000
0.4250
0.4250
```

Although the plot of the costmap displays the cell with the obstacle and its adjacent cells in shades of red, only the cell with the obstacle has a higher cost value of 0.8. The other cells still have the default cost value of 0.425.

Input Arguments

costmap — Costmap

vehicleCostmap object

Costmap, specified as a vehicleCostmap object.

xyPoints — Points

M -by-2 real-valued matrix

Points, specified as an M -by-2 real-valued matrix that represents the (x, y) coordinates of M points.

Example: `[3.4 2.6]` specifies a single point at (3.4, 2.6)

Example: `[3 2;3 3;4 7]` specifies three points: (3, 2), (3, 3), and (4, 7)

Output Arguments

costVals — Cost of points

M -element real-valued vector

Cost of points in `xyPoints`, returned as an M -element real-valued vector.

costMat — Cost of all cells

real-valued matrix

Cost of all cells in `costmap`, returned as a real-valued matrix of the same size as the costmap grid. This size is specified by the `MapSize` property of the costmap.

Version History

Introduced in R2018a

Extended Capabilities

C/C++ Code Generation

Generate C and C++ code using MATLAB® Coder™.

See Also

`setCosts` | `vehicleCostmap`

plot

Plot vehicle costmap

Syntax

```
plot(costmap)
plot(costmap,Name,Value)
```

Description

The `plot` function displays a vehicle costmap. The darkness of each cell is proportional to the cost value of the cell. Cells with low cost are bright, and cells containing obstacles with high cost are dark. Inflated areas are displayed with a red hue, and cells outside the inflated area are displayed in grayscale.

`plot(costmap)` plots the vehicle costmap in the current axes.

`plot(costmap,Name,Value)` plots the vehicle costmap using name-value pair arguments to specify the parent axes or to adjust the display of inflated areas.

Examples

Display a Vehicle on a Costmap

Load a costmap from a parking lot. Display the costmap.

```
data = load('parkingLotCostmap.mat');
parkMap = data.parkingLotCostmap;
plot(parkMap)
```

Create a template polyshape object with the dimensions of the car.

```
carDims = parkMap.CollisionChecker.VehicleDimensions
```

```
carDims =
    vehicleDimensions with properties:
```

```
    Length: 4.7000
    Width: 1.8000
    Height: 1.4000
    Wheelbase: 2.8000
    RearOverhang: 1
    FrontOverhang: 0.9000
    WorldUnits: 'meters'
```

```
ro = carDims.RearOverhang;
fo = carDims.FrontOverhang;
wb = carDims.Wheelbase;
hw = carDims.Width/2;
X = [-ro,wb+fo,wb+fo,-ro];
```

```
Y = [-hw, -hw, hw, hw];
templateShape = polyshape(X', Y');
```

Create a function handle to move the template to a specified vehicle pose. This move function translates the polyshape `s` to the coordinate `(x,y)` and then rotates the polyshape by an angle `theta` about the point `(x,y)`.

```
move = @(s,x,y,theta) rotate(translate(s,[x,y]), ...
    theta,[x,y]);
```

Move the car template to a pose.

```
carPose = [5,5,75];
carShape = move(templateShape, carPose(1), carPose(2), carPose(3));
```

Plot the car on the costmap.

```
hold on
plot(carShape)
```

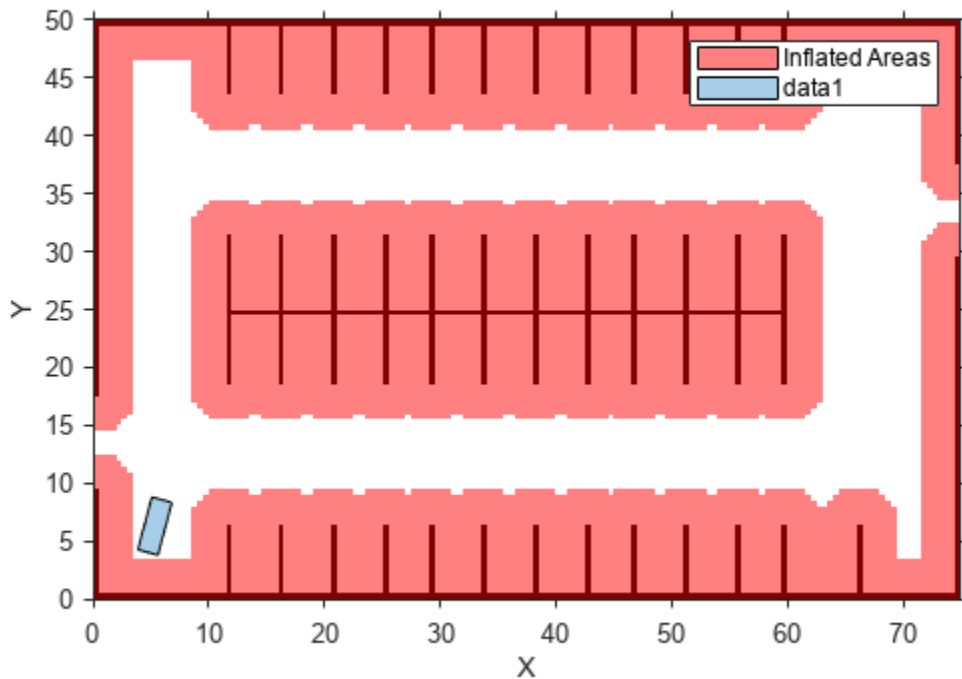

Input Arguments

costmap — Costmap

vehicleCostmap object

Costmap, specified as a vehicleCostmap object.

Name-Value Pair Arguments

Specify optional pairs of arguments as `Name1=Value1, ..., NameN=ValueN`, where `Name` is the argument name and `Value` is the corresponding value. Name-value arguments must appear after other arguments, but the order of the pairs does not matter.

Before R2021a, use commas to separate each name and value, and enclose Name in quotes.

Example: `'Inflation','off'`

Inflation — Display inflated areas

`'on'` (default) | `'off'`

Display inflated areas, specified as the comma-separated pair consisting of `'Inflation'` and one of the following.

- `'on'`—Cells in the inflated area have a red hue.
- `'off'`—Cells containing obstacles have a red hue, but other cells in the inflated area are displayed in grayscale.

Parent — Axes on which to plot costmap

axes handle

Axes on which to plot the costmap, specified as the comma-separated pair consisting of `'Parent'` and an axes handle. By default, `plot` uses the current axes handle, which is returned by the `gca` function.

Version History

Introduced in R2018a

See Also

`vehicleDimensions` | `polyshape` | `vehicleCostmap`

setCosts

Set cost value of cells in vehicle costmap

Syntax

```
setCosts(costmap,xyPoints,costVals)
```

Description

`setCosts(costmap,xyPoints,costVals)` sets the costs, `costVals`, for the (x, y) points in `xyPoints` in the vehicle costmap.

Examples

Mark Rectangular Obstacle on Vehicle Costmap

Create a 10-by-15 meter vehicle costmap. Cells have a side length of 1 meter.

```
costmap = vehicleCostmap(10,15);
```

Define a set of (x,y) coordinates that correspond to a 3-by-5 meter rectangle.

```
[x,y] = meshgrid(2:4,2:6);  
xyPoints = [x(:),y(:)];
```

Mark the rectangle as an obstacle by increasing the cost of its cells to 0.9.

```
costVal = 0.9;  
setCosts(costmap,xyPoints,costVal);  
plot(costmap)  
title('Costmap with Rectangular Obstacle')
```

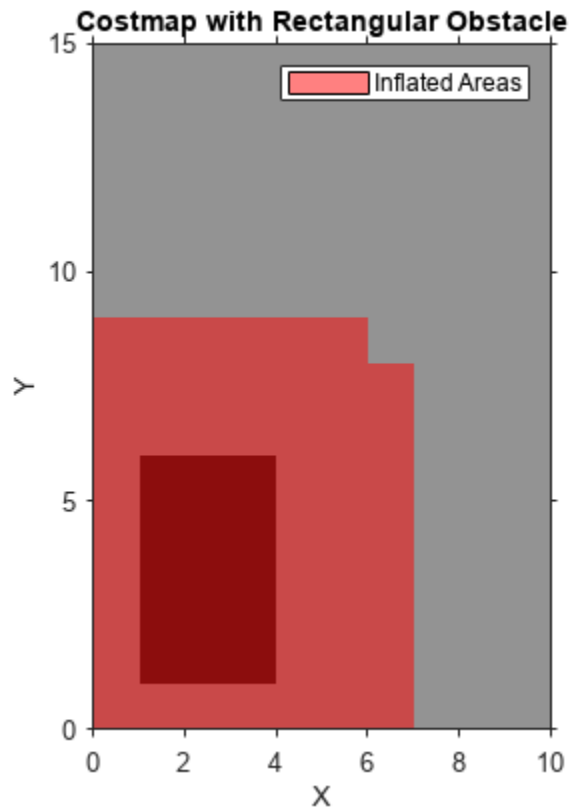

Input Arguments

costmap — Costmap

vehicleCostmap object

Costmap, specified as a vehicleCostmap object.

xyPoints — Points

M -by-2 real-valued matrix

Points, specified as an M -by-2 real-valued matrix that represents the (x, y) coordinates of M points.

Example: [3.4 2.6] specifies a single point at (3.4, 2.6)

Example: [3 2;3 3;4 7] specifies three points: (3, 2), (3, 3), and (4, 7)

costVals — Cost of points

M -element real-valued vector

Cost of points in xyPoints, specified as an M -element real-valued vector.

Example: 0.8 specifies the cost of a single point

Example: [0.2 0.5 0.8] specifies the cost of three points

Version History

Introduced in R2018a

Extended Capabilities

C/C++ Code Generation

Generate C and C++ code using MATLAB® Coder™.

See Also

`getCosts` | `vehicleCostmap`

addSuccessor

Add successor to lane in RoadRunner HD Map using MATLAB

Syntax

```
aSuccessor = addSuccessor(aLane, successorID)
aSuccessor = addSuccessor(aLane, successorID, Name=Value)
```

Description

`aSuccessor = addSuccessor(aLane, successorID)` adds a successor with ID `successorID` to the `Successors` property of the lane and returns it.

`aSuccessor = addSuccessor(aLane, successorID, Name=Value)` sets options using one or more name-value arguments.

Examples

Add Successor to a Lane in RoadRunner HD Map

Create an empty RoadRunner HD Map by calling the `roadrunnerHDMAP` object.

```
rrMap = roadrunnerHDMAP()

rrMap =
  roadrunnerHDMAP with properties:

    Author: ""
  Projection: ""
  GeographicBoundary: [0×3 double]
    Lanes: [0×1 roadrunner.hdmap.Lane]
  LaneBoundaries: [0×1 roadrunner.hdmap.LaneBoundary]
    LaneGroups: [0×1 roadrunner.hdmap.LaneGroup]
  LaneMarkings: [0×1 roadrunner.hdmap.LaneMarking]
    Junctions: [0×1 roadrunner.hdmap.Junction]
  BarrierTypes: [0×1 roadrunner.hdmap.BarrierType]
    Barriers: [0×1 roadrunner.hdmap.Barrier]
  SignTypes: [0×1 roadrunner.hdmap.SignType]
    Signs: [0×1 roadrunner.hdmap.Sign]
```

Create two road lanes using the `roadrunner.hdmap.Lane` object. Specify the lane information for the lane id, coordinates defining the lane geometry, driving direction, and lane type.

```
rrMap.Lanes(2) = roadrunner.hdmap.Lane(ID="Lane2", Geometry=[-0.782 -1.56; 50.78 23.43], TravelDirection=1, LaneType=1)

rrMap =
  roadrunnerHDMAP with properties:

    Author: ""
  Projection: ""
```

```

GeographicBoundary: [0×3 double]
  Lanes: [2×1 roadrunner.hdmap.Lane]
LaneBoundaries: [0×1 roadrunner.hdmap.LaneBoundary]
  LaneGroups: [0×1 roadrunner.hdmap.LaneGroup]
  LaneMarkings: [0×1 roadrunner.hdmap.LaneMarking]
  Junctions: [0×1 roadrunner.hdmap.Junction]
BarrierTypes: [0×1 roadrunner.hdmap.BarrierType]
  Barriers: [0×1 roadrunner.hdmap.Barrier]
  SignTypes: [0×1 roadrunner.hdmap.SignType]
  Signs: [0×1 roadrunner.hdmap.Sign]

```

```
rrMap.Lanes(1) = roadrunner.hdmap.Lane(ID="Lane1",Geometry=[-0.534 -2.43;25.78 46.43],TravelDire
```

```
rrMap =
```

```
roadrunnerHDMAP with properties:
```

```

  Author: ""
  Projection: ""
GeographicBoundary: [0×3 double]
  Lanes: [2×1 roadrunner.hdmap.Lane]
LaneBoundaries: [0×1 roadrunner.hdmap.LaneBoundary]
  LaneGroups: [0×1 roadrunner.hdmap.LaneGroup]
  LaneMarkings: [0×1 roadrunner.hdmap.LaneMarking]
  Junctions: [0×1 roadrunner.hdmap.Junction]
BarrierTypes: [0×1 roadrunner.hdmap.BarrierType]
  Barriers: [0×1 roadrunner.hdmap.Barrier]
  SignTypes: [0×1 roadrunner.hdmap.SignType]
  Signs: [0×1 roadrunner.hdmap.Sign]

```

Add Lane2 as a successor of Lane1.

```
addSuccessor(rrMap.Lanes(1), "Lane2")
```

```
ans =
```

```
AlignedReference with properties:
```

```

  Reference: [1×1 roadrunner.hdmap.Reference]
  Alignment: Unspecified

```

Input Arguments

aLane — Lane properties of road

roadrunner.hdmap.Lane object

Lane properties of a road, specified as a roadrunner.hdmap.Lane object.

Example: aLane= roadrunner.hdmap.Lane(ID="Lane1", Geometry=[-0.782 -1.56;50.78 23.43], LaneType="Driving", TravelDirection="Forward") creates a lane with properties lane id, coordinates defining lane geometry, lane type, and driving direction.

successorID — ID of successor lane

character vector | string scalar

ID of the successor lane, specified as a string.

Example: `addPredecessor(rrMap.Lanes(2),"Lane1")` assigns Lane1 as the predecessor of Lane2 in a RoadRunner HD Map.

Data Types: `char` | `string`

Name-Value Pair Arguments

Specify optional pairs of arguments as `Name1=Value1, ..., NameN=ValueN`, where `Name` is the argument name and `Value` is the corresponding value. Name-value arguments must appear after other arguments, but the order of the pairs does not matter.

Example:

Alignment — Type of alignment

`character vector` | `string scalar`

Type of alignment between linked objects, specified as a character vector or string scalar. The type of alignment is specified as one of the following strings: "Unspecified", "Forward", or "Backward".

Example: `alref= roadrunner.hdmap.AlignedReference(Reference=ref, Alignment="Forward")` creates the aligned reference for Lane2 with "Forward" alignment.

Data Types: `char` | `string`

Output Arguments

aSuccessor — Linkage information for succeeding lanes

`roadrunner.hdmap.AlignedReference` object

Linkage information for succeeding lanes, specified as a `roadrunner.hdmap.AlignedReference` object.

Version History

Introduced in R2022b

See Also

`roadrunnerHDMAP` | `roadrunner.hdmap.Lane` | `roadrunner.hdmap.AlignedReference` | `addPredecessor`

Topics

"Build Simple Roads Programmatically Using RoadRunner HD Map" (RoadRunner)

"Build Scenes from Custom Data Using RoadRunner HD Map" (RoadRunner)

leftBoundary

Set left boundary of lane in RoadRunner HD Map using MATLAB

Syntax

```
aLeftBoundary = leftBoundary(aLane, laneBoundaryID)
aLeftBoundary = leftBoundary(aLane, laneBoundaryID, Name=Value)
```

Description

`aLeftBoundary = leftBoundary(aLane, laneBoundaryID)` sets a boundary with ID `laneBoundaryID` to the `LeftLaneBoundary` property of the lane and returns it.

`aLeftBoundary = leftBoundary(aLane, laneBoundaryID, Name=Value)` sets options using one or more name-value arguments.

Examples

Set Left Boundary to a Lane in RoadRunner HD Map

Create an empty RoadRunner HD Map by calling the `roadrunnerHDMAP` object.

```
rrMap = roadrunnerHDMAP()

rrMap =
  roadrunnerHDMAP with properties:

    Author: ""
  Projection: ""
GeographicBoundary: [0x3 double]
      Lanes: [0x1 roadrunner.hdmap.Lane]
LaneBoundaries: [0x1 roadrunner.hdmap.LaneBoundary]
  LaneGroups: [0x1 roadrunner.hdmap.LaneGroup]
LaneMarkings: [0x1 roadrunner.hdmap.LaneMarking]
   Junctions: [0x1 roadrunner.hdmap.Junction]
BarrierTypes: [0x1 roadrunner.hdmap.BarrierType]
   Barriers: [0x1 roadrunner.hdmap.Barrier]
  SignTypes: [0x1 roadrunner.hdmap.SignType]
      Signs: [0x1 roadrunner.hdmap.Sign]
```

Add lane and lane boundary to the map.

```
rrMap.Lanes = roadrunner.hdmap.Lane(ID="Lane1")

rrMap =
  roadrunnerHDMAP with properties:

    Author: ""
  Projection: ""
GeographicBoundary: [0x3 double]
```

```

        Lanes: [1x1 roadrunner.hdmap.Lane]
LaneBoundaries: [0x1 roadrunner.hdmap.LaneBoundary]
    LaneGroups: [0x1 roadrunner.hdmap.LaneGroup]
    LaneMarkings: [0x1 roadrunner.hdmap.LaneMarking]
        Junctions: [0x1 roadrunner.hdmap.Junction]
BarrierTypes: [0x1 roadrunner.hdmap.BarrierType]
    Barriers: [0x1 roadrunner.hdmap.Barrier]
    SignTypes: [0x1 roadrunner.hdmap.SignType]
        Signs: [0x1 roadrunner.hdmap.Sign]

```

```
rrMap.LaneBoundaries = roadrunner.hdmap.LaneBoundary(ID="LaneBoundaryL")
```

```
rrMap =
    roadrunnerHDMAP with properties:
```

```

        Author: ""
        Projection: ""
GeographicBoundary: [0x3 double]
    Lanes: [1x1 roadrunner.hdmap.Lane]
LaneBoundaries: [1x1 roadrunner.hdmap.LaneBoundary]
    LaneGroups: [0x1 roadrunner.hdmap.LaneGroup]
    LaneMarkings: [0x1 roadrunner.hdmap.LaneMarking]
        Junctions: [0x1 roadrunner.hdmap.Junction]
BarrierTypes: [0x1 roadrunner.hdmap.BarrierType]
    Barriers: [0x1 roadrunner.hdmap.Barrier]
    SignTypes: [0x1 roadrunner.hdmap.SignType]
        Signs: [0x1 roadrunner.hdmap.Sign]

```

Set the left lane boundary of the lane using the `leftBoundary` function.

```
leftBoundary(rrMap.Lanes, "LaneBoundaryL");
```

Input Arguments

aLane — Lane properties of road

roadrunner.hdmap.Lane object

Lane properties of a road, specified as a `roadrunner.hdmap.Lane` object.

Example: `aLane= roadrunner.hdmap.Lane(ID="Lane1", Geometry=[-0.782 -1.56;50.78 23.43], LaneType="Driving", TravelDirection="Forward")` creates a lane with properties lane id, coordinates defining lane geometry, lane type, and driving direction.

laneBoundaryID — ID of left lane boundary

character vector | string scalar

ID of the left lane boundary, specified as a string.

Example: `leftBoundary(rrMap.Lanes, "LaneBoundaryL")` assigns the left boundary with an id `LaneBoundaryL` to a lane in a RoadRunner HD Map.

Data Types: char | string

Name-Value Pair Arguments

Specify optional pairs of arguments as `Name1=Value1, . . . , NameN=ValueN`, where `Name` is the argument name and `Value` is the corresponding value. Name-value arguments must appear after other arguments, but the order of the pairs does not matter.

Example:

Alignment — Type of alignment

character vector | string scalar

Type of alignment between linked objects, specified as a character vector or string scalar. The type of alignment is specified as one of the following strings: "Unspecified", "Forward", or "Backward".

Example: `a1ref= roadrunner.hdmap.AlignedReference(Reference=ref, Alignment="Forward")` creates the aligned reference for `Lane2` with "Forward" alignment.

Data Types: `char` | `string`

Output Arguments

aLeftBoundary — Linkage information for left boundary of lane

`roadrunner.hdmap.AlignedReference` object

Linkage information for the left boundary of the lane, specified as a `roadrunner.hdmap.AlignedReference` object.

Version History

Introduced in R2022b

See Also

`roadrunnerHDMAP` | `roadrunner.hdmap.Lane` | `roadrunner.hdmap.AlignedReference` | `rightBoundary`

Topics

"Build Simple Roads Programmatically Using RoadRunner HD Map" (RoadRunner)

"Build Scenes from Custom Data Using RoadRunner HD Map" (RoadRunner)

rightBoundary

Set right boundary of lane in RoadRunner HD Map using MATLAB

Syntax

```
aRightBoundary = rightBoundary(aLane, laneBoundaryID)
aRightBoundary = rightBoundary(aLane, laneBoundaryID, Name=Value)
```

Description

`aRightBoundary = rightBoundary(aLane, laneBoundaryID)` sets a boundary with ID `laneBoundaryID` to the `RightLaneBoundary` property of the lane and returns it.

`aRightBoundary = rightBoundary(aLane, laneBoundaryID, Name=Value)` sets options using one or more name-value arguments.

Examples

Set Right Boundary to a Lane in RoadRunner HD Map

Create an empty RoadRunner HD Map by calling the `roadrunnerHDMMap` object.

```
rrMap = roadrunnerHDMMap()
```

```
rrMap =
```

```
roadrunnerHDMMap with properties:
```

```
    Author: ""
  Projection: ""
GeographicBoundary: [0x3 double]
        Lanes: [0x1 roadrunner.hdmap.Lane]
LaneBoundaries: [0x1 roadrunner.hdmap.LaneBoundary]
   LaneGroups: [0x1 roadrunner.hdmap.LaneGroup]
LaneMarkings: [0x1 roadrunner.hdmap.LaneMarking]
   Junctions: [0x1 roadrunner.hdmap.Junction]
BarrierTypes: [0x1 roadrunner.hdmap.BarrierType]
     Barriers: [0x1 roadrunner.hdmap.Barrier]
   SignTypes: [0x1 roadrunner.hdmap.SignType]
         Signs: [0x1 roadrunner.hdmap.Sign]
```

Add lane and lane boundary to the map.

```
rrMap.Lanes = roadrunner.hdmap.Lane(ID="Lane1")
```

```
rrMap =
```

```
roadrunnerHDMMap with properties:
```

```
    Author: ""
  Projection: ""
GeographicBoundary: [0x3 double]
```

```

    Lanes: [1x1 roadrunner.hdmap.Lane]
  LaneBoundaries: [0x1 roadrunner.hdmap.LaneBoundary]
    LaneGroups: [0x1 roadrunner.hdmap.LaneGroup]
  LaneMarkings: [0x1 roadrunner.hdmap.LaneMarking]
    Junctions: [0x1 roadrunner.hdmap.Junction]
  BarrierTypes: [0x1 roadrunner.hdmap.BarrierType]
    Barriers: [0x1 roadrunner.hdmap.Barrier]
  SignTypes: [0x1 roadrunner.hdmap.SignType]
    Signs: [0x1 roadrunner.hdmap.Sign]

```

```
rrMap.LaneBoundaries = roadrunner.hdmap.LaneBoundary(ID="LaneBoundaryR")
```

```
rrMap =
  roadrunnerHDMAP with properties:
```

```

    Author: ""
    Projection: ""
  GeographicBoundary: [0x3 double]
    Lanes: [1x1 roadrunner.hdmap.Lane]
  LaneBoundaries: [1x1 roadrunner.hdmap.LaneBoundary]
    LaneGroups: [0x1 roadrunner.hdmap.LaneGroup]
  LaneMarkings: [0x1 roadrunner.hdmap.LaneMarking]
    Junctions: [0x1 roadrunner.hdmap.Junction]
  BarrierTypes: [0x1 roadrunner.hdmap.BarrierType]
    Barriers: [0x1 roadrunner.hdmap.Barrier]
  SignTypes: [0x1 roadrunner.hdmap.SignType]
    Signs: [0x1 roadrunner.hdmap.Sign]

```

Set the right lane boundary of the lane using the `rightBoundary` function.

```
rightBoundary(rrMap.Lanes, "LaneBoundaryR");
```

Input Arguments

aLane — Lane properties of road

roadrunner.hdmap.Lane object

Lane properties of a road, specified as a `roadrunner.hdmap.Lane` object.

Example: `aLane= roadrunner.hdmap.Lane(ID="Lane1", Geometry=[-0.782 -1.56;50.78 23.43], LaneType="Driving", TravelDirection="Forward")` creates a lane with properties lane id, coordinates defining lane geometry, lane type, and driving direction.

laneBoundaryID — ID of left lane boundary

character vector | string scalar

ID of the left lane boundary, specified as a string.

Example: `leftBoundary(rrMap.Lanes, "LaneBoundaryL")` assigns the left boundary with an id `LaneBoundaryL` to a lane in a RoadRunner HD Map.

Data Types: char | string

Name-Value Pair Arguments

Specify optional pairs of arguments as `Name1=Value1, . . . , NameN=ValueN`, where `Name` is the argument name and `Value` is the corresponding value. Name-value arguments must appear after other arguments, but the order of the pairs does not matter.

Example:

Alignment — Type of alignment

character vector | string scalar

Type of alignment between linked objects, specified as a character vector or string scalar. The type of alignment is specified as one of the following strings: "Unspecified", "Forward", or "Backward".

Example: `alref = roadrunner.hdmap.AlignedReference(Reference=ref, Alignment="Forward")` creates the aligned reference for `Lane2` with "Forward" alignment.

Data Types: `char` | `string`

Output Arguments

aRightBoundary — Linkage information for right boundary of lane

`roadrunner.hdmap.AlignedReference` object

Linkage information for the right boundary of the lane, specified as a `roadrunner.hdmap.AlignedReference` object.

Version History

Introduced in R2022b

See Also

`roadrunnerHDMAP` | `roadrunner.hdmap.Lane` | `roadrunner.hdmap.AlignedReference` | `leftBoundary`

Topics

"Build Simple Roads Programmatically Using RoadRunner HD Map" (RoadRunner)

"Build Scenes from Custom Data Using RoadRunner HD Map" (RoadRunner)

plot

Plot RoadRunner HD Map using MATLAB

Syntax

```
plot(rrMap)
plot(rrMap,Name=Value)
```

Description

`plot(rrMap)` plots the RoadRunner HD Map's lane centers, lane boundaries, lane group centers, and barriers.

`plot(rrMap,Name=Value)` specifies additional name-value pair arguments for the HD map.

Examples

Plot HD Map from Binary File

Create an empty RoadRunner HD Map by calling the `roadrunnerHDMMap` object.

```
rrMap = roadrunnerHDMMap;
```

Specify the name of the binary file you want to read. Use the `read` function to read the file specified by the argument `filename`.

```
filename = "C:\RR\MyProject\Scenes\MyMap.rrhd";
read(rrMap,filename)
rrMap
```

```
rrMap =
  roadrunnerHDMMap with properties:
```

```

    Author: "Map Author"
  Projection: ""
GeographicBoundary: [2x3 double]
      Lanes: [0x1 roadrunner.hdmap.Lane]
LaneBoundaries: [0x1 roadrunner.hdmap.LaneBoundary]
  LaneGroups: [0x1 roadrunner.hdmap.LaneGroup]
LaneMarkings: [0x1 roadrunner.hdmap.LaneMarking]
   Junctions: [0x1 roadrunner.hdmap.Junction]
BarrierTypes: [0x1 roadrunner.hdmap.BarrierType]
   Barriers: [0x1 roadrunner.hdmap.Barrier]
  SignTypes: [0x1 roadrunner.hdmap.SignType]
      Signs: [0x1 roadrunner.hdmap.Sign]
```

Plot the map.

```
plot(rrMap)
```

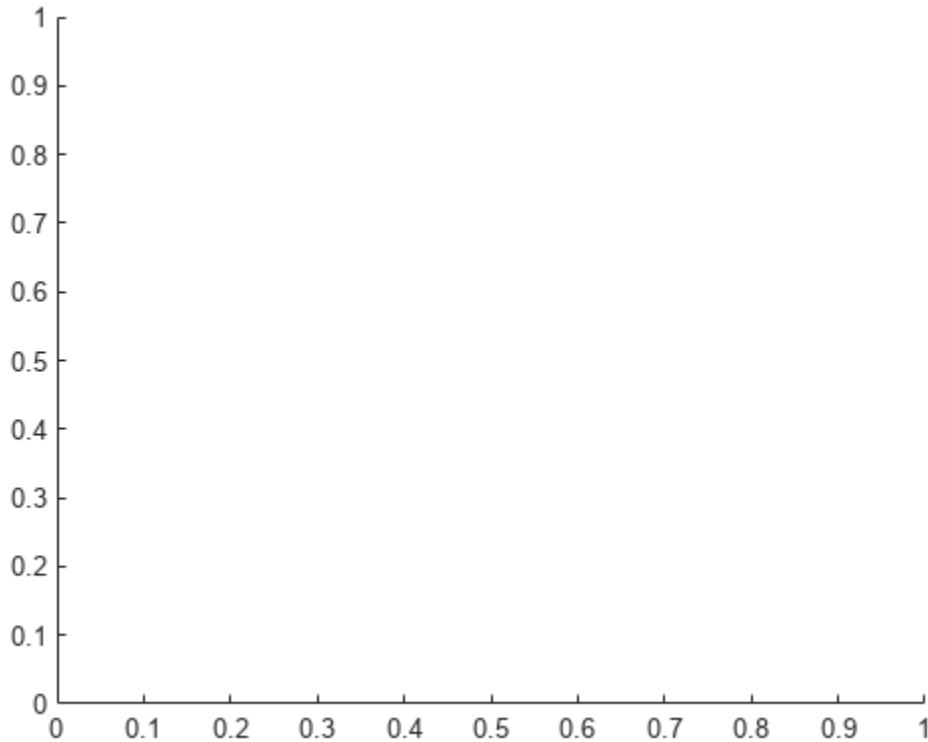

Input Arguments

rrMap — RoadRunner HD Map road data model

roadrunnerHDMap object

RoadRunner HD Map road data model, specified as a `roadrunnerHDMap` object. `rrMap` defines a simple data structure to represent road layouts using lanes, lane boundaries, lane markings, and junctions. This object provides functions that support reading, writing, and plotting HD map data.

Name-Value Pair Arguments

Specify optional pairs of arguments as `Name1=Value1, ..., NameN=ValueN`, where `Name` is the argument name and `Value` is the corresponding value. Name-value arguments must appear after other arguments, but the order of the pairs does not matter.

Example:

Parent — Handle to axes object

handle object

Handle to an axes object, specified as a handle object to contain the plot. If this property is not specified, the `plot` function generates a new figure.

ShowLaneGroups — Display lane group centers

false or 0 (default) | true or 1

Display lane group centers in the plot, specified as logical 0 (false) or logical 1 (true). If you set `ShowLaneGroups` to true, then the `plot` function displays the lane group centers in the plot.

ShowBarriers — Display barrier centers

false or 0 (default) | true or 1

Display barrier centers in the plot, specified as logical 0 (false) or logical 1 (true). If you set `ShowBarriers` to true, then the `plot` function displays the barrier centers in the plot.

ShowSigns — Display signs

false or 0 (default) | true or 1

Display signs in the plot, specified as logical 0 (false) or logical 1 (true). If you set `ShowSigns` to true, then the `plot` function displays the signs in the plot.

ShowStaticObjects — Display static objects

false or 0 (default) | true or 1

Display static objects in the plot, specified as logical 0 (false) or logical 1 (true). If you set `ShowStaticObjects` to true, then the `plot` function displays the static objects in the plot.

ShowLegend — Display legend

true or 1 (default) | false or 0

Display legend in the plot, specified as logical 1 (true) or logical 0 (false). If you set `ShowLegend` to false, then the `plot` function does not display the legend for the plot. A legend is not shown when the Parent name-value argument is specified.

ShowLineMarkers — Display line markers

true or 1 (default) | false or 0

Display line markers in the plot, specified as logical 1 (true) or logical 0 (false). If you set `ShowLineMarkers` to true, then the `plot` function displays the line markers for the plot.

Version History

Introduced in R2022b

See Also

Objects

`roadrunnerHDMMap` | `roadrunner`

Functions

`write` | `read`

Topics

“Build Simple Roads Programmatically Using RoadRunner HD Map” (RoadRunner)

read

Read HD Map from binary file using MATLAB

Syntax

```
read(rrMap, filename)
```

Description

`read(rrMap, filename)` reads the RoadRunner HD Map from a binary file specified by `filename` and populates the `rrMap` object with the map data. Specify the extension of the file as `.rrhd`.

Examples

Read HD Map from Binary File

Create an empty RoadRunner HD Map by calling the `roadrunnerHDMMap` object.

```
rrMap = roadrunnerHDMMap;
```

Specify the name of the binary file you want to read. Use the `read` function to read the file specified by the argument `filename`.

```
filename = "C:\RR\MyProject\Scenes\MyMap.rrhd";  
read(rrMap, filename);
```

Input Arguments

rrMap — RoadRunner HD Map road data model

`roadrunnerHDMMap` object

RoadRunner HD Map road data model, specified as a `roadrunnerHDMMap` object. `rrMap` defines a simple data structure to represent road layouts using lanes, lane boundaries, lane markings, and junctions. This object provides functions that support reading, writing, and plotting HD map data.

filename — File name to read map data from

character vector | string scalar

File name to read the map data from, specified as a character vector or string scalar. This argument specifies the absolute or relative path to the binary file you want to read. If you specify a relative path, then the path is relative to the `Scenes` folder of the current project. `filename` must end with `.rrhd`.

Example: `read(rrMap, "MyMap.rrhd")` reads the map data from the `MyMap.rrhd` binary file.

Data Types: `char` | `string`

Version History

Introduced in R2022b

See Also

Objects

roadrunnerHDMap | roadrunner

Functions

write | plot

Topics

“Build Simple Roads Programmatically Using RoadRunner HD Map” (RoadRunner)

write

Write HD Map to binary file using MATLAB

Syntax

```
write(rrMap,filename)
write(rrMap,filename,Name=Value)
```

Description

`write(rrMap,filename)` writes the RoadRunner HD Map in a binary file `filename`. Specify the extension of the file as `.rrhd`. You can import the file into RoadRunner by adding the file to a folder in the **Library Browser** and dragging it into the scene. You can then build the scene using the **Scene Builder Tool**.

`write(rrMap,filename,Name=Value)` sets options using one or more name-value arguments.

Examples

Write Map to a Binary File

Create a RoadRunner HD Map by calling the `roadrunnerHDMMap` object. Populate the map using your custom data. For example, this code specifies the author and the spatial bounds of the geometric data attributes for the map. The call to the `roadrunnerHDMMap` object returns a HD map with author and spatial bounds attributes.

```
rrMap = roadrunnerHDMMap(Author="Map Author",GeographicBoundary=[-0.782 -3.13 0;101.565 50 0])
```

```
rrMap =
```

```
roadrunnerHDMMap with properties:
```

```
    Author: "Map Author"
  Projection: ""
GeographicBoundary: [2x3 double]
        Lanes: [0x1 roadrunner.hdmap.Lane]
LaneBoundaries: [0x1 roadrunner.hdmap.LaneBoundary]
   LaneGroups: [0x1 roadrunner.hdmap.LaneGroup]
LaneMarkings: [0x1 roadrunner.hdmap.LaneMarking]
    Junctions: [0x1 roadrunner.hdmap.Junction]
BarrierTypes: [0x1 roadrunner.hdmap.BarrierType]
    Barriers: [0x1 roadrunner.hdmap.Barrier]
   SignTypes: [0x1 roadrunner.hdmap.SignType]
        Signs: [0x1 roadrunner.hdmap.Sign]
```

Specify the name of the binary file you want to write the map to. Use the `write` function to write the map data to the file specified by the argument `filename`.

```
filename = "MyMap.rrhd";
write(rrMap,filename)
```

Input Arguments

rrMap — RoadRunner HD Map road data model

roadrunnerHDMMap object

RoadRunner HD Map road data model, specified as a `roadrunnerHDMMap` object. `rrMap` defines a simple data structure to represent road layouts using lanes, lane boundaries, lane markings, and junctions. This object provides functions that support reading, writing, and plotting HD map data.

filename — File name to write map data to

character vector | string scalar

File name to write the map data to, specified as a character vector or string scalar. This argument specifies the absolute or relative path to the binary file you want to write the data to. If you specify a relative path, then the path is relative to the `Scenes` folder of the current project. `filename` must end with `.rrhd`.

Example: `write(rrMap, "MyMap.rrhd")` writes the map data to the `MyMap.rrhd` binary file.

Data Types: `char` | `string`

Name-Value Pair Arguments

Specify optional pairs of arguments as `Name1=Value1, ..., NameN=ValueN`, where `Name` is the argument name and `Value` is the corresponding value. Name-value arguments must appear after other arguments, but the order of the pairs does not matter.

Example:

WKT — WKT projection string

character vector | string scalar

WKT projection string, specified as a character vector or string scalar.

PROJ4 — PROJ.4 projection string

character vector | string scalar

A PROJ.4 projection string, specified as a character vector or string scalar.

Version History

Introduced in R2022b

See Also

Objects

`roadrunnerHDMMap` | `roadrunner`

Functions

`read` | `plot`

Topics

“Build Simple Roads Programmatically Using RoadRunner HD Map” (RoadRunner)

vehicleDimensions

Store vehicle dimensions

Description

The `vehicleDimensions` object stores vehicle dimensions. The figure shows the dimensions that are included in the `vehicleDimensions`.

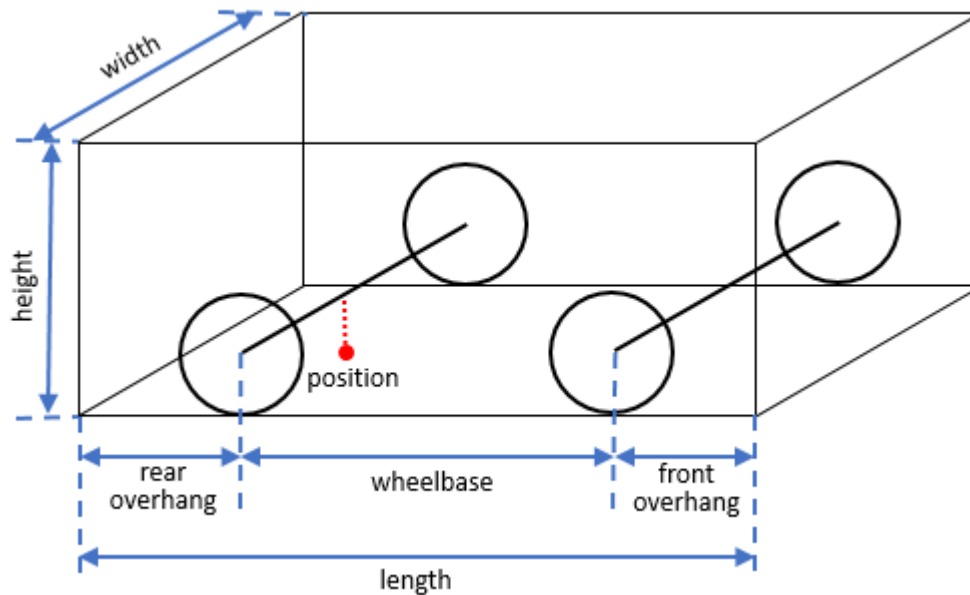

The position of the vehicle is often represented as a single point located on the ground at the center of the rear axle, as indicated by the red dot in the figure. This position corresponds to the natural center of rotation of the vehicle.

The table lists typical vehicle types and their corresponding dimensions.

Vehicle Classification	Length	Width	Height	Wheelbase	Front Overhang	Rear Overhang
Automobile (sedan)	4.7 m	1.8 m	1.4 m	2.8 m	0.9 m	1.0 m
Motorcycle	2.2 m	0.6 m	1.5 m	1.51 m	0.37 m	0.32 m

Creation

Syntax

```
vdims = vehicleDimensions
```

```
vdims = vehicleDimensions(l,w,h)
vdims = vehicleDimensions( ____,Name,Value)
```

Description

`vdims = vehicleDimensions` creates a `vehicleDimensions` object with a default length of 4.7 m, width of 1.8 m, and height of 1.4 m.

`vdims = vehicleDimensions(l,w,h)` creates a `vehicleDimensions` object and sets the `Length`, `Width`, and `Height` properties.

`vdims = vehicleDimensions(____,Name,Value)` uses one or more name-value pair arguments to set the `Wheelbase`, `FrontOverhang`, `RearOverhang`, and `WorldUnits` properties. `Name` is the property name and `Value` is the corresponding value. `Name` must appear inside single quotes (' '). You can specify several name and value pair arguments in any order as `Name1,Value1, ...,NameN,ValueN`.

Properties

Length — Length of vehicle

4.7 (default) | positive real scalar

Length of vehicle, specified as a positive real scalar.

Data Types: double

Width — Width of vehicle

1.8 (default) | positive real scalar

Width of vehicle, specified as a positive real scalar.

Data Types: double

Height — Height of vehicle

1.4 (default) | positive real scalar

Height of vehicle, specified as a positive real scalar.

Data Types: double

FrontOverhang — Front overhang of vehicle

0.9 (default) | real scalar

Front overhang of vehicle, specified as a real scalar. The front overhang is the distance between the front of the vehicle and the front axle. `FrontOverhang` can be negative.

Data Types: double

RearOverhang — Rear overhang of vehicle

1.0 (default) | real scalar

Rear overhang of vehicle, specified as a real scalar. The rear overhang is the distance between the rear of the vehicle and the rear axle. `RearOverhang` can be negative.

Data Types: double

Wheelbase — Distance between axles

2.8 (default) | positive real scalar

The distance between the front and rear axles of the vehicle, specified as a positive real scalar.

Data Types: double

WorldUnits — Units of measurement

'meters' (default) | character array

Units of measurement, specified as a character array. The units do not affect the values of measurements.

Examples

Specify Dimensions of a Motorcycle

Store the dimensions of a motorcycle with length 2.2, width 0.6, and height 1.5 meters. Also specify the distance that the motorcycle extends ahead of the front axle and behind the rear axle.

```
vdims = vehicleDimensions(2.2,0.6,1.5, ...  
    'FrontOverhang',0.37,'RearOverhang',0.32)
```

```
vdims =  
    vehicleDimensions with properties:
```

```
    Length: 2.2000  
    Width: 0.6000  
    Height: 1.5000  
    Wheelbase: 1.5100  
    RearOverhang: 0.3200  
    FrontOverhang: 0.3700  
    WorldUnits: 'meters'
```

Tips

- The Length of the vehicle is the sum of the Wheelbase, FrontOverhang, and RearOverhang. If you change FrontOverhang, then the value of Wheelbase automatically adjusts to keep Length constant. Any change resulting in a negative wheelbase causes an error.
- You can use the vehicle dimensions to define a vehicleCostmap that represents the planning search space around a vehicle. Path planning algorithms, such as pathPlannerRRT, use vehicle dimensions to find a path for the vehicle to follow.

Version History

Introduced in R2018a

Extended Capabilities

C/C++ Code Generation

Generate C and C++ code using MATLAB® Coder™.

Usage notes and limitations:

- All inputs to `vehicleDimensions` must be compile-time constants.

See Also

`vehicleCostmap` | `vehicle`

objectDetection

Report for single object detection

Description

An `objectDetection` object contains an object detection report that was obtained by a sensor for a single object. You can use the `objectDetection` output as the input to trackers such as `multiObjectTracker`.

Creation

Syntax

```
detection = objectDetection(time, measurement)
detection = objectDetection( ____, Name, Value)
```

Description

`detection = objectDetection(time, measurement)` creates an object detection at the specified time from the specified measurement.

Tip To create an empty `objectDetection` object, use `objectDetection.empty()`.

`detection = objectDetection(____, Name, Value)` creates a detection object with properties specified as one or more `Name, Value` pair arguments. Any unspecified properties have default values. You cannot specify the `Time` or `Measurement` properties using `Name, Value` pairs.

Input Arguments

time — Detection time

nonnegative real scalar

Detection time, specified as a nonnegative real scalar. This argument sets the `Time` property.

measurement — Object measurement

real-valued N -element vector

Object measurement, specified as a real-valued N -element vector, where N is the dimension of the measurement vector. This argument sets the `Measurement` property.

If you use `objectDetection` with a custom filter initialization function, you can define the measurement in any format as long as it agrees with the filter definition.

If you use `objectDetection` with a built-in filter initialization function such as `initcvekf`, the measurement definition follows these rules.

- For a complete 3-D position measurement in a rectangular coordinate system, the general form is [x y z]. If you want to include velocity measurement as [x y z vx vy vz], you must specify the HasVelocity field in the MeasurementParameters property as true.

Note Some filter initialization functions such as `initcvkf` can accept a 1-D measurement in the form of `x` or a 2-D measurement in the form of `[x y]`.

- To specify a measurement in the spherical coordinate system, the `Frame` field in the `MeasurementParameters` property must be "Spherical". For a complete 3-D spherical measurement, the general form is [azimuth elevaton range rangeRate]. To let a filter interpret such a 3-D spherical measurement, specify the `HasAzimuth`, `HasElevation`, `HasRange`, and `HasVelocity` fields in the `MeasurementParameters` property all as true.
 - To remove azimuth from the complete 3-D spherical measurement, set `HasAzimuth` to false.
 - To remove elevation from the complete 3-D spherical measurement, set `HasElevation` to false.
 - To remove range from the complete 3-D spherical measurement, set `HasRange` to false.
 - To remove rangeRate from the complete 3-D spherical measurement, set `HasVelocity` to false.

For more details, see the "Convert Detections to objectDetection Format" and "Initialize Tracking Filter Using objectDetection" on page 4-1452 examples.

Output Arguments

detection — Detection report

`objectDetection` object

Detection report for a single object, returned as an `objectDetection` object. An `objectDetection` object contains these properties:

Property	Definition
Time	Measurement time
Measurement	Object measurements
MeasurementNoise	Measurement noise covariance matrix
SensorIndex	Unique ID of the sensor
ObjectClassID	Object classification
MeasurementParameters	Parameters used by initialization functions of nonlinear Kalman tracking filters
ObjectAttributes	Additional information passed to tracker

Properties

Time — Detection time

nonnegative real scalar

Detection time, specified as a nonnegative real scalar. You cannot set this property as a name-value pair. Use the `time` input argument instead.

Example: 5.0

Data Types: double

Measurement — Object measurement

real-valued N -element vector

Object measurement, specified as a real-valued N -element vector. You cannot set this property as a name-value pair. Use the `measurement` input argument instead.

Example: [1.0; -3.4]

Data Types: double | single

MeasurementNoise — Measurement noise covariance

scalar | real positive semi-definite symmetric N -by- N matrix

Measurement noise covariance, specified as a scalar or a real positive semi-definite symmetric N -by- N matrix. N is the number of elements in the measurement vector. For the scalar case, the matrix is a square diagonal N -by- N matrix having the same data interpretation as the measurement.

Example: [5.0, 1.0; 1.0, 10.0]

Data Types: double | single

SensorIndex — Sensor identifier

1 | positive integer

Sensor identifier, specified as a positive integer. The sensor identifier lets you distinguish between different sensors and must be unique to the sensor.

Example: 5

Data Types: double

ObjectClassID — Object class identifier

0 (default) | nonnegative integer

Object class identifier, specified as a nonnegative integer. Use this property to distinguish detections generated from different kinds of objects. For example, use 1 for objects of type "car", and 2 for objects of type "pedestrian". The value 0 denotes an unknown object type.

When you specify this property as a nonzero integer, you can use the `ObjectClassParameters` property to specify the detection classifier statistics.

Example: 1

Data Types: double

ObjectClassParameters — Parameters for detection classifier

[] (default) | structure

Parameters for detection classifier, specified as a structure. The structure can contain any field. For class fusion with a multi-object tracker, such as the `trackerGNN` System object, you can specify the `ConfusionMatrix` field as follows.

Field Name	Description
ConfusionMatrix	<p>Confusion matrix of the detection classifier, specified as an N-by-N real-valued matrix, where N is the number of possible object classes. The (i,j) element of the matrix represents the weight or probability that the classifier classifies the detection as class j if the true class of the detection is class i.</p> <p>For example, if the classifier outputs two classes and makes right classification 95% of the time, specify this matrix as $[0.95 \ 0.05; \ 0.05 \ 0.95]$.</p>

Data Types: struct

MeasurementParameters — Measurement function parameters

{ } (default) | structure array | cell containing structure array | cell array

Measurement function parameters that convert from filter state to measurement, specified as a structure array, a cell containing a structure array, or a cell array.

When you use a custom measurement function in a tracking filter, you can define the measurement in any format as long as it agrees with the definition of the custom measurement function.

When you use a built-in measurement function, such as `cvmeas` and `ctmeas`, in a tracking filter, you can use a structure with these fields to define measurements in rectangular or spherical coordinate frame.

Field	Description	Example
Frame	<p>Frame used to report measurements, specified as one of these values:</p> <ul style="list-style-type: none"> 'Rectangular' — Detections are reported in rectangular coordinates. 'Spherical' — Detections are reported in spherical coordinates. 	'spherical'
OriginPosition	Position offset of the origin of the frame relative to the parent frame, specified as an $[x \ y \ z]$ real-valued vector.	$[0 \ 0 \ 0]$
OriginVelocity	Velocity offset of the origin of the frame relative to the parent frame, specified as a $[vx \ vy \ vz]$ real-valued vector.	$[0 \ 0 \ 0]$

Field	Description	Example
Orientation	Frame rotation matrix, specified as a 3-by-3 real-valued orthonormal matrix.	[1 0 0; 0 1 0; 0 0 1]
HasAzimuth	Logical scalar indicating if azimuth is included in the measurement. This field is not relevant when the Frame field is 'Spherical'.	1
HasElevation	Logical scalar indicating if elevation information is included in the measurement. For measurements reported in a rectangular frame, and if HasElevation is false, the reported measurements assume 0 degrees of elevation.	1
HasRange	Logical scalar indicating if range is included in the measurement. This field is not relevant when the Frame is 'Spherical'.	1
HasVelocity	Logical scalar indicating if the reported detections include velocity measurements. For a measurement reported in the rectangular frame, if HasVelocity is false, the measurements are reported as [x y z]. If HasVelocity is true, the measurement is reported as [x y z vx vy vz]. For a measurement reported in the spherical frame, if HasVelocity is true, the measurement contains range-rate information.	1

Field	Description	Example
IsParentToChild	Logical scalar indicating if <code>Orientation</code> performs a frame rotation from the parent coordinate frame to the child coordinate frame. When <code>IsParentToChild</code> is false, then <code>Orientation</code> performs a frame rotation from the child coordinate frame to the parent coordinate frame.	0

For more details of using `MeasurementParameters`, see the

- “Initialize Tracking Filter Using `objectDetection`” on page 4-1452 example for initializing a tracking filter.
- “Convert Detections to `objectDetection` Format” example for defining an `objectDetection` object, especially for multiple coordinate transformations using an array of measurement parameter structures.

ObjectAttributes – Object attributes

{ } (default) | cell array | structure array

Object attributes passed through the tracker, specified as a cell array or a structure array. These attributes are added to the output of the `multiObjectTracker` but not used by the tracker.

Example: `{[10,20,50,100], 'radar1'}`

Example: `struct('myProperty',2)`

Examples

Create Detection from Position Measurement

Create a detection from a position measurement. The detection is made at a timestamp of one second from a position measurement of `[100;250;10]` in Cartesian coordinates.

```
detection = objectDetection(1,[100;250;10])
```

```
detection =
  objectDetection with properties:
        Time: 1
    Measurement: [3x1 double]
  MeasurementNoise: [3x3 double]
      SensorIndex: 1
    ObjectClassID: 0
  ObjectClassParameters: []
  MeasurementParameters: {}
    ObjectAttributes: {}
```

Create Detection With Measurement Noise

Create an `objectDetection` from a time and position measurement. The detection is made at a time of one second for an object position measurement of `[100;250;10]`. Add measurement noise and set other properties using Name-Value pairs.

```
detection = objectDetection(1,[100;250;10], 'MeasurementNoise',10, ...  
    'SensorIndex',1, 'ObjectAttributes', {'Example object',5})
```

```
detection =  
    objectDetection with properties:  
  
        Time: 1  
        Measurement: [3x1 double]  
        MeasurementNoise: [3x3 double]  
        SensorIndex: 1  
        ObjectClassID: 0  
        ObjectClassParameters: []  
        MeasurementParameters: {}  
        ObjectAttributes: {'Example object' [5]}
```

Initialize Tracking Filter Using `objectDetection`

You can use an `objectDetection` object to initialize a tracking filter.

Initialize Constant Velocity `trackingKF` with Rectangular Detection

To initialize a `trackingKF` object with a constant velocity model, you use the `initcvkf` function.

Create a 2-D object detection and initialize a `trackingKF` object using the detection.

```
detection = objectDetection(0,[1 2]);  
filter = initcvkf(detection);  
filter.State'
```

```
ans = 1x4
```

```
1 0 2 0
```

From the result, the `initcvkf` function recognized the dimension of the system and initialized a 2-D filter in which the state is $[x \ vx \ y \ vy]$, setting the velocity states vx and vy to 0.

You can also initialize a 3-D `trackingKF` object by using a 3-D object detection.

```
detection = objectDetection(0,[1 2 3]);  
filter = initcvkf(detection);  
filter.State'
```

```
ans = 1x6
```

```
1 0 2 0 3 0
```

From the result, the `initcvkf` function initialized a 3-D filter in which the state is `[x vx y vy z vz]`.

Initialize Constant Velocity trackingEKF with Rectangular Detection

To initialize a `trackingEKF` object with a constant velocity model, you use the `initcvkf` function. The `initcvkf` function requires the detection to be 3-D and always initializes a 3-D `trackingEKF` object.

Create a 3-D object detection and initialize the `trackingEKF` object with the detection.

```
detection = objectDetection(0,[1 2 3]);
filter = initcvkf(detection);
filter.State' % [x vx y vy z vz]
```

```
ans = 1×6
```

```
1 0 2 0 3 0
```

From the result, the function assumes zero velocities when they are unspecified. You can also include velocity information in the measurement of the detection. Use the measurement parameters to let the `initcvkf` function recognize the velocity state by setting the `HasVelocity` field as `true`.

```
mp = struct(Frame="Rectangular", ...
    OriginPosition = zeros(1,3), ...
    OriginVelocity = zeros(1,3), ...
    Orientation = eye(3),...
    HasVelocity = true,...
    IsParentToChild = true);
detection = objectDetection(0,[1 2 3 0.1 0.2 0.3], ...
    MeasurementParameters=mp);
filter = initcvkf(detection);
filter.State' % [x vx y vy z vz]
```

```
ans = 1×6
```

```
1.0000 0.1000 2.0000 0.2000 3.0000 0.3000
```

From the result, the function successfully initialized the velocities.

Initialize Constant Velocity trackingEKF with Spherical Detection

You can also initialize a `trackingEKF` object with a spherical detection. First, create a spherical detection with an azimuth of 45 degrees, an elevation of 60 degrees, and a range of 2 meters. Specify its measurement parameter to describe the format of the measurement.

```
mp = struct(Frame="Spherical", ...
    OriginPosition = zeros(1,3), ...
    OriginVelocity = zeros(1,3), ...
    Orientation = eye(3),...
    HasAzimuth = true,...
    HasElevation = true,...
    HasRange = true,...
    HasVelocity = false,...
    IsParentToChild = true);
detection = objectDetection(0,[45 60 2], ...
```

```

    MeasurementParameters=mp);
filter = initcvkf(detection);
filter.State' % [x vx y vy z vz]

ans = 1x6

    0.7071         0    0.7071         0    1.7321         0

```

From the results, the filter state is as expected and the position coordinate is $[\frac{\sqrt{2}}{2} \frac{\sqrt{2}}{2} \sqrt{3}]$.

You can also enable range-rate measurement by setting the `HasVelocity` field of the measurement parameter to `true`. After that, set the range-rate to be 0.2 m/s in the detection.

```

mp = struct(Frame="Spherical", ...
    OriginPosition = zeros(1,3), ...
    OriginVelocity = zeros(1,3), ...
    Orientation = eye(3), ...
    HasAzimuth = true, ...
    HasElevation = true, ...
    HasRange = true, ...
    HasVelocity = true, ...
    IsParentToChild = true);
detection = objectDetection(0, [45 60 2 0.2], ...
    MeasurementParameters=mp);
filter = initcvkf(detection);
filter.State' % [x vx y vy z vz]

ans = 1x6

    0.7071    0.0707    0.7071    0.0707    1.7321    0.1732

```

From the results, the function initialized the filter with the expected velocities.

Version History

Introduced in R2017a

R2022b: Specify class confusion matrix

Using the new `ObjectClassParameters` property, you can specify detection class statistics in the form of a confusion matrix.

Extended Capabilities

C/C++ Code Generation

Generate C and C++ code using MATLAB® Coder™.

When passing an `objectDetection` object to a tracker, the `ObjectAttributes` property must be specified as a structure or a structure array and must not be specified as a cell.

See Also

Objects

[multiObjectTracker](#) | [drivingRadarDataGenerator](#) | [visionDetectionGenerator](#) | [trackingKF](#) | [trackingEKF](#) | [trackingUKF](#)

trackingKF

Linear Kalman filter for object tracking

Description

A `trackingKF` object is a discrete-time linear Kalman filter used to track states, such as positions and velocities of objects that can be encountered in an automated driving scenario. Such objects include automobiles, pedestrians, bicycles, and stationary structures or obstacles.

A Kalman filter is a recursive algorithm for estimating the evolving state of a process when measurements are made on the process. The filter assumes the state-space model, including the state model and the measurement model, is linear. When the process noise and measurement noise are Gaussian and the motion model is linear, the Kalman filter is optimal. For a brief description of the linear Kalman filter algorithm, see "Linear Kalman Filters".

You can use a `trackingKF` object in these ways:

- Set the `MotionModel` property to one of predefined state transition models. See the `MotionModel` property for details on these models.
 - "1D Constant Velocity"
 - "1D Constant Acceleration"
 - "2D Constant Velocity"
 - "2D Constant Acceleration"
 - "3D Constant Velocity"
 - "3D Constant Acceleration"
- Explicitly set the motion model. Set the `MotionModel` property to "Custom", and then use the `StateTransitionModel` and `MeasurementModel` properties to specify the state transition matrix and measurement matrix, respectively. Optionally, you can specify control inputs by specifying the `ControlModel` property.

Creation

Syntax

```
filter = trackingKF
filter = trackingKF("MotionModel",model)
filter = trackingKF(A,H)
filter = trackingKF(A,H,B)
filter = trackingKF( ___,Name,Value)
```

Description

`filter = trackingKF` creates a discrete-time linear Kalman filter object for estimating the state of a 2-D, constant-velocity, moving object. The function sets the `MotionModel` property of the filter to "2D Constant Velocity".

`filter = trackingKF("MotionModel",model)` sets the `MotionModel` property to a predefined motion model, `model`. In this case, the filter initializes the state as a double-precision zero vector based on the dimension of the motion model. The filter also configures the `MeasurementModel` property so that the measurement model returns position measurements.

`filter = trackingKF(A,H)` specifies the `StateTransitionModel` and the `MeasurementModel` properties to `A` and `H`, respectively. The function sets the `MotionModel` property to "Custom".

`filter = trackingKF(A,H,B)` sets the `ControlModel` property to the specified `B`. The function sets the `MotionModel` property to "Custom".

`filter = trackingKF(____,Name,Value)` configures the properties of the Kalman filter by using one or more name-value arguments and any of the previous syntaxes. Any unspecified properties take default values. Enclose each property name in quotes.

Properties

State — Kalman filter state

0 (default) | real-valued scalar | real-valued M -element vector

Kalman filter state, specified as a real-valued M -element vector, where M is the size of the state vector. For information on the typical size of the state vector for each motion model, see the `MotionModel` property. If you specify the initial state as a scalar, the filter extends the state to an M -by-1 vector.

To use the filter with single-precision, floating-point variables, specify the `MotionModel` property as a predefined model and specify `State` as a single-precision vector variable. For example:

```
filter = trackingKF("MotionModel","2D Constant Velocity","State",single([1; 2; 3; 4]))
```

Example: [200; 0.2; -40; -0.01]

Data Types: single | double

StateCovariance — State estimation error covariance

1 (default) | positive scalar | positive-definite real-valued M -by- M matrix

State estimation error covariance, specified as a positive scalar or a positive-definite real-valued M -by- M matrix, where M is the size of the state vector. If you specify a scalar, the property value is the product of the specified scalar and an M -by- M identity matrix. The matrix represents the uncertainty in the state, and each diagonal element of the matrix represents the variance of the corresponding state component. The off-diagonal elements represent cross-covariance between different state components.

Example: [20 0.1; 0.1 1]

Data Types: double

MotionModel — Kalman filter motion model

"Custom" | "1D Constant Velocity" | "2D Constant Velocity" | "3D Constant Velocity" | "1D Constant Acceleration" | "2D Constant Acceleration" | "3D Constant Acceleration"

Kalman filter motion model, specified as "Custom" or one of these predefined models:

- "1D Constant Velocity"
- "1D Constant Acceleration"
- "2D Constant Velocity"
- "2D Constant Acceleration"
- "3D Constant Velocity"
- "3D Constant Acceleration"

If you specify the property as one of the predefined motion models, the filter uses this state-space model:

$$x(k + 1) = A(k)x(k) + G(k)w(k)$$

$$z(k) = H(k)x(k) + v(k)$$

where k is the discrete time step, x is the state, A is the state transition matrix, w is the process noise, G is the process noise gain matrix, H is the measurement matrix, v is the measurement noise, and z is the measurement. Note that the size of the gain matrix G is M -by- $M/2$, and the size of the process noise w is $M/2$, where M is the size of the state x .

Motion Model	State Vector x	State Transition Matrix (A)	Gain Matrix (G)
"1D Constant Velocity"	$[x; vx]$	$[1 \ dt; \ 0 \ 1]$	$[dt^2/2; \ dt]$
"2D Constant Velocity"	$[x; vx; y; vy]$	Block diagonal matrix with the $[1 \ dt; \ 0 \ 1]$ block repeated for the x and y spatial dimensions	Kronecker product of $\text{kron}(\text{eye}(2), [dt^2/2; \ dt])$
"3D Constant Velocity"	$[x; vx; y; vy; z; vz]$	Block diagonal matrix with the $[1 \ dt; \ 0 \ 1]$ block repeated for the x , y , and z spatial dimensions.	Kronecker product of $\text{kron}(\text{eye}(3), [dt^2/2; \ dt])$
"1D Constant Acceleration"	$[x; vx; ax]$	$[1 \ dt \ dt^2/2; \ 0 \ 1 \ dt; \ 0 \ 0 \ 1]$	$[dt^2/2; \ dt; \ 1]$
"2D Constant Acceleration"	$[x; vx; ax; y; vy; ay]$	Block diagonal matrix with $[1 \ dt \ dt^2/2; \ 0 \ 1 \ dt; \ 0 \ 0 \ 1]$ blocks repeated for the x and y spatial dimensions	Kronecker product of $\text{kron}(\text{eye}(2), [dt^2/2; \ dt; \ 1])$
"3D Constant Acceleration"	$[x; vx, ax; y; vy; ay; z; vz; az]$	Block diagonal matrix with the $[1 \ dt \ 0.5*dt^2; \ 0 \ 1 \ dt; \ 0 \ 0 \ 1]$ block repeated for the x , y , and z spatial dimensions	Kronecker product of $\text{kron}(\text{eye}(3), [dt^2/2; \ dt; \ 1])$

In the table, `dt` is the time step specified in the `predict` object function. If you want process noise and measurement noise values different from the default values for the motion model, specify them in the `ProcessNoise` and `MeasurementNoise` properties, respectively.

If you specify `MotionModel` as "Custom", you must specify a state transition model matrix A and a measurement model matrix H as input arguments to the Kalman filter. You can optionally specify a control model matrix, B , as well. When you specify a custom motion model, the filter uses this state-space model:

$$\begin{aligned}x(k+1) &= A(k)x(k) + B(k)u(k) + w(k) \\z(k) &= H(k)x(k) + v(k)\end{aligned}$$

where u is the control input. In this case, the size of the process noise w is M , where M is the size of the state x . You can specify the covariance of w using the `ProcessNoise` property, and specify the covariance of v using the `MeasurementNoise` property.

Data Types: `char` | `string`

StateTransitionModel — State transition model between time steps

[1 1 0 0; 0 1 0 0; 0 0 1 1; 0 0 0 1] (default) | real-valued M -by- M matrix

State transition model between time steps, specified as a real-valued M -by- M matrix. M is the size of the state vector. In the absence of controls and noise, the state transition model predicts the state at a time step to the next time step.

Example: [1 1; 0 1]

Dependencies

To enable this property, set the `MotionModel` property to "Custom".

Data Types: `single` | `double`

ControlModel — Control model

M -by- L real-valued matrix

Control model, specified as an M -by- L matrix. M is the dimension of the state vector, and L is the number of controls or forces. The control model adds the effect of controls on the evolution of the state.

Note To use a control model, you must specify this property when constructing the filter object. You cannot change the size of the control model matrix after creating the filter.

Example: [.01 0.2]

Data Types: `single` | `double`

ProcessNoise — Covariance of process noise

1 (default) | nonnegative scalar | positive-semidefinite D -by- D matrix | positive-semidefinite M -by- M matrix

Covariance of process noise, specified as a nonnegative scalar, a positive-semidefinite D -by- D matrix, or a positive-semidefinite M -by- M matrix. Process noise represents the uncertainty of state propagation, and the filter assumes the process noise to be zero-mean Gaussian white noise.

- When the `MotionModel` property is specified as one of the predefined motion models, specify the `ProcessNoise` property as a positive-semidefinite D -by- D matrix, where D is the number of dimensions of the target motion. For example, $D = 2$ for the "2D Constant Velocity" or the "2D Constant Acceleration" motion model.

In this case, if you specify the `ProcessNoise` property as a nonnegative scalar, then the scalar extends to the diagonal elements of a diagonal covariance matrix, of size D -by- D .

- When the `MotionModel` property is specified as "Custom", specify the `ProcessNoise` property as a positive-semidefinite M -by- M matrix, where M is the size of the filter state. For example, $M = 6$ if you customize a 3-D motion model in which the state is (x, v_x, y, v_y, z, v_z) .

In this case, if you specify the `ProcessNoise` property as a nonnegative scalar, then the scalar extends to the diagonal elements of a diagonal covariance matrix, of size M -by- M .

Data Types: `single` | `double`

MeasurementModel — Measurement model from state vector

`[1 0 0 0; 0 0 1 0]` (default) | real-valued N -by- M matrix

Measurement model from the state vector, specified as a real-valued N -by- M matrix, where N is the size of the measurement vector and M is the size of the state vector. The measurement model is a linear matrix that determines measurements from the filter state.

Note You cannot change the size of the measurement model matrix after creating the filter.

Example: `[1 0.5 0.01; 1.0 1 0]`

Data Types: `single` | `double`

MeasurementNoise — Measurement noise covariance

1 (default) | positive scalar | positive-definite real-valued N -by- N matrix

Covariance of the measurement noise, specified as a positive scalar or a positive-definite, real-valued N -by- N matrix, where N is the size of the measurement vector. If you specify this property as a scalar, the property value is the product of the specified scalar and the N -by- N identity matrix. Measurement noise represents the uncertainty of the measurement and the filter assumes measurement noise to be zero-mean Gaussian white noise.

Example: `0.2`

Data Types: `single` | `double`

EnableSmoothing — Enable state smoothing

`false` (default) | `true`

Enable state smoothing, specified as `false` or `true`. Setting this property to `true` requires the Sensor Fusion and Tracking Toolbox license. When specified as `true`, you can:

- Use the `smooth` function, provided in Sensor Fusion and Tracking Toolbox, to smooth state estimates of the previous steps. Internally, the filter stores the results from previous steps to allow backward smoothing.
- Specify the maximum number of smoothing steps using the `MaxNumSmoothingSteps` property of the tracking filter.

MaxNumSmoothingSteps — Maximum number of smoothing steps

5 (default) | positive integer

Maximum number of backward smoothing steps, specified as a positive integer.

Dependencies

To enable this property, set the `EnableSmoothing` property to `true`.

MaxNumOOSMSteps — Maximum number of out-of-sequence measurement steps

0 (default) | nonnegative integer

Maximum number of out-of-sequence measurement (OOSM) steps, specified as a nonnegative integer.

- Setting this property to 0 disables the OOSM retrodiction capability of the filter object.
- Setting this property to a positive integer enables the OOSM retrodiction capability of the filter object. This option requires a Sensor Fusion and Tracking Toolbox license. Also, you cannot set the `MotionModel` property to "Custom". When you set this property as $N > 1$, the filter object saves the past state and state covariance history up to the last $N + 1$ corrections. You can use the OOSM and the `retrodict` and `retroCorrect` (or `retroCorrectJPDA` for multiple OOSMs) object functions to reduce the uncertainty of the estimated state.

Increasing the value of this property increases the amount of memory that must be allocated for the state history, but enables you to process OOSMs that arrive after longer delays. Note that the effect of the uncertainty reduction using an OOSM decreases as the delay becomes longer.

Object Functions

<code>predict</code>	Predict state and state estimation error covariance of linear Kalman filter
<code>correct</code>	Correct state and state estimation error covariance using tracking filter
<code>correctjpdo</code>	Correct state and state estimation error covariance using tracking filter and JPDA
<code>distance</code>	Distances between current and predicted measurements of tracking filter
<code>likelihood</code>	Likelihood of measurement from tracking filter
<code>clone</code>	Create duplicate tracking filter
<code>residual</code>	Measurement residual and residual noise from tracking filter
<code>initialize</code>	Initialize state and covariance of tracking filter
<code>tunableProperties</code>	Get tunable properties of filter
<code>setTunedProperties</code>	Set properties to tuned values

Examples**Create Constant-Velocity Linear Kalman Filter**

Create a linear Kalman filter that uses a 2D constant velocity motion model. Assume that the measurement consists of the xy -location of the object.

Specify the initial state estimate to have zero velocity.

```
x = 5.3;
y = 3.6;
initialState = [x;0;y;0];
KF = trackingKF('MotionModel','2D Constant Velocity','State',initialState);
```

Create measured positions for the object on a constant-velocity trajectory.

```
vx = 0.2;
vy = 0.1;
T = 0.5;
pos = [0:vx*T:2;
      5:vy*T:6]';
```

Predict and correct the state of the object.

```
for k = 1:size(pos,1)
    pstates(k,:) = predict(KF,T);
    cstates(k,:) = correct(KF,pos(k,:));
end
```

Plot the tracks.

```
plot(pos(:,1),pos(:,2),"k.",pstates(:,1),pstates(:,3),"+", ...
     cstates(:,1),cstates(:,3),"o")
xlabel("x [m]")
ylabel("y [m]")
grid
xt = [x-2, pos(1,1)+0.1, pos(end,1)+0.1];
yt = [y, pos(1,2), pos(end,2)];
text(xt,yt,["First measurement", "First position", "Last position"])
legend("Object position", "Predicted position", "Corrected position")
```

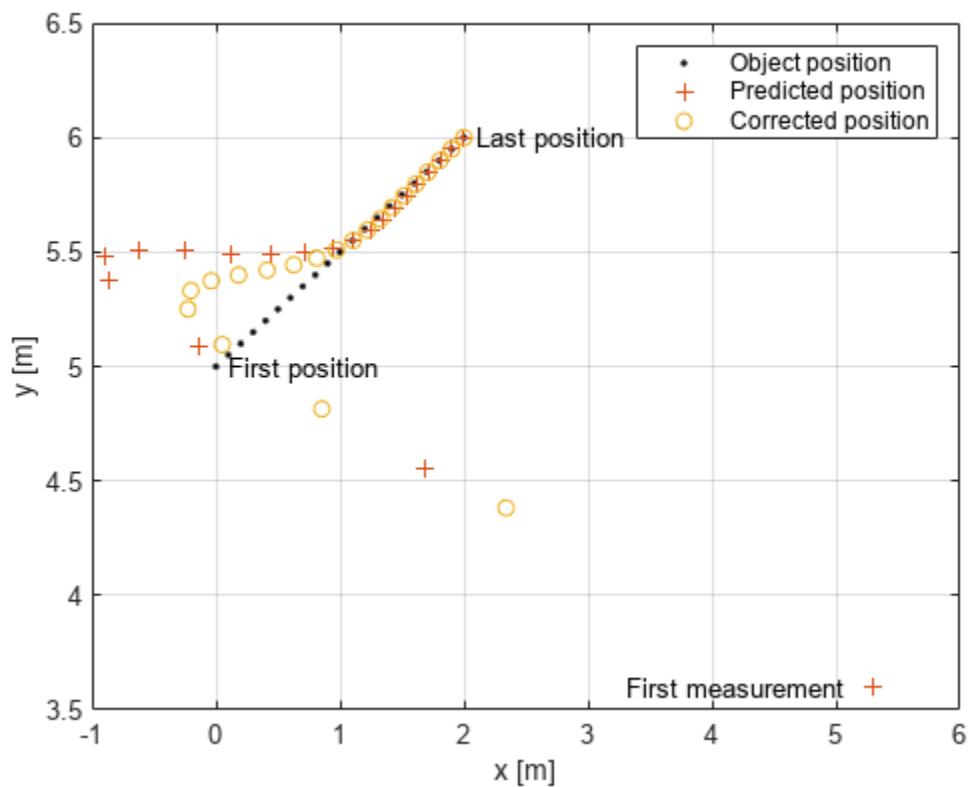

Use Custom trackingKF with Control Inputs

Specify a simulation time of 10 seconds with a time step of 1 second.

```
rng(2021) % For repeatable results
simulationTime = 20;
dt = 1;
tspan = 0:dt:simulationTime;
steps = length(tspan);
```

Specify the motion model as a 2-D constant velocity model with a state of $[x; vx; y; vy]$. The measurement is $[x; y]$.

```
A1D = [1 dt; 0 1];
A = kron(eye(2),A1D) % State transition model
```

A = 4×4

```
1 1 0 0
0 1 0 0
0 0 1 1
0 0 0 1
```

```
H1D = [1 0];
H = kron(eye(2),H1D) % Measurement model
```

H = 2×4

```
1 0 0 0
0 0 1 0
```

```
sigma = 0.2;
R = sigma^2*eye(2); % Measurement noise covariance
```

Specify a control model matrix.

```
B1D = [0; 1];
B = kron(eye(2),B1D) % Control model matrix
```

B = 4×2

```
0 0
1 0
0 0
0 1
```

Assume the control inputs are sinusoidal on the velocity components, vx and vy .

```
gain = 5;
Ux = gain*sin(tspan(2:end));
Uy = gain*cos(tspan(2:end));
U = [Ux; Uy]; % Control inputs
```

Assuming the true initial state is $[1 \ 1 \ 1 \ -1]$, simulate the system to obtain true states and measurements.

```

initialState = [1 1 1 -1]'; % [m m/s m m/s]
trueStates = NaN(4,steps);
trueStates(:,1) = initialState;

for i=2:steps
    trueStates(:,i) = A*trueStates(:,i-1) + B*U(:,i-1);
end

measurements = H*trueStates + chol(R)*randn(2,steps);

```

Visualize the true trajectory and the measurements.

```

figure
plot(trueStates(1,:),trueStates(3,:), "DisplayName", "Truth")
hold on
plot(measurements(1,:),measurements(2,:), "x", "DisplayName", "Measurements")
xlabel("x (m)")
ylabel("y (m)")
legend

```

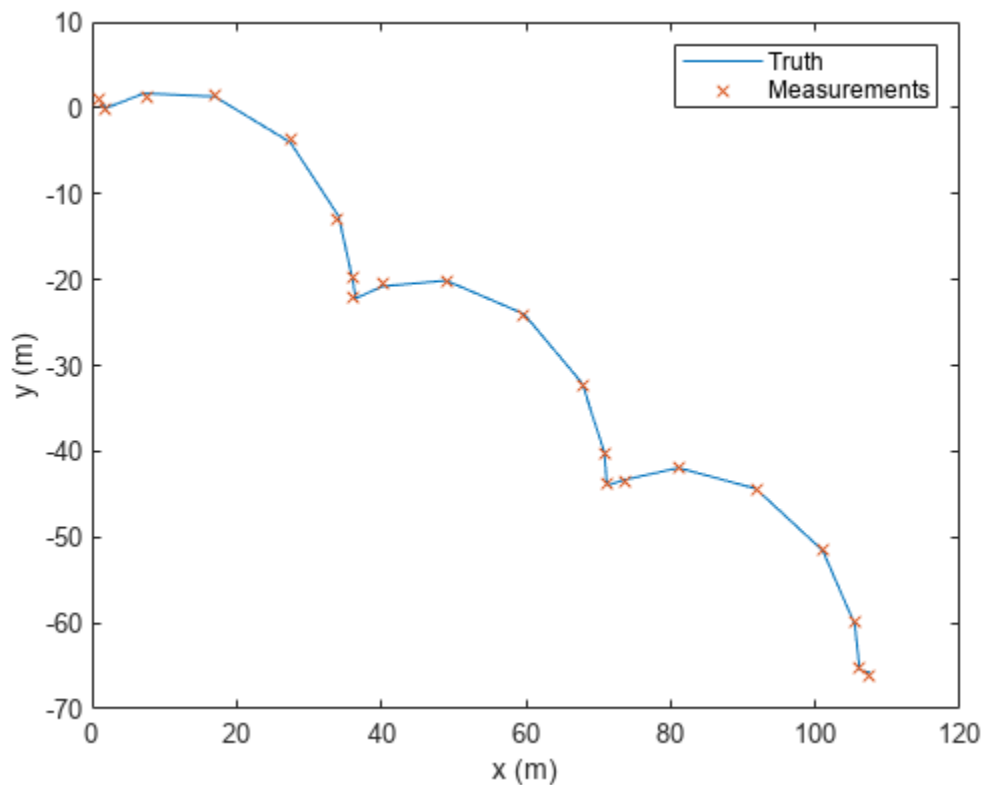

Create a trackingKF filter with a custom motion model. Enable the control input by specifying the control model. Specify the initial state in the filter based on the first measurement.

```

initialFilterState = [measurements(1,1); 0; measurements(2,1); 0];
filter = trackingKF("MotionModel", "Custom", ...
    "StateTransitionModel", A, ...
    "MeasurementModel", H, ...

```

```
"ControlModel",B, ...
"State",initialFilterState);
```

Estimate states by using the predict and correct object functions.

```
estimateStates = NaN(4,steps);
estimateStates(:,1) = initialFilterState;
for i = 2:steps
    predict(filter,U(:,i-1));
    estimateStates(:,i) = correct(filter,measurements(:,i));
end
```

Visualize the state estimates.

```
plot(estimateStates(1,:),estimateStates(3,:), "g", "DisplayName", "Estimates");
```

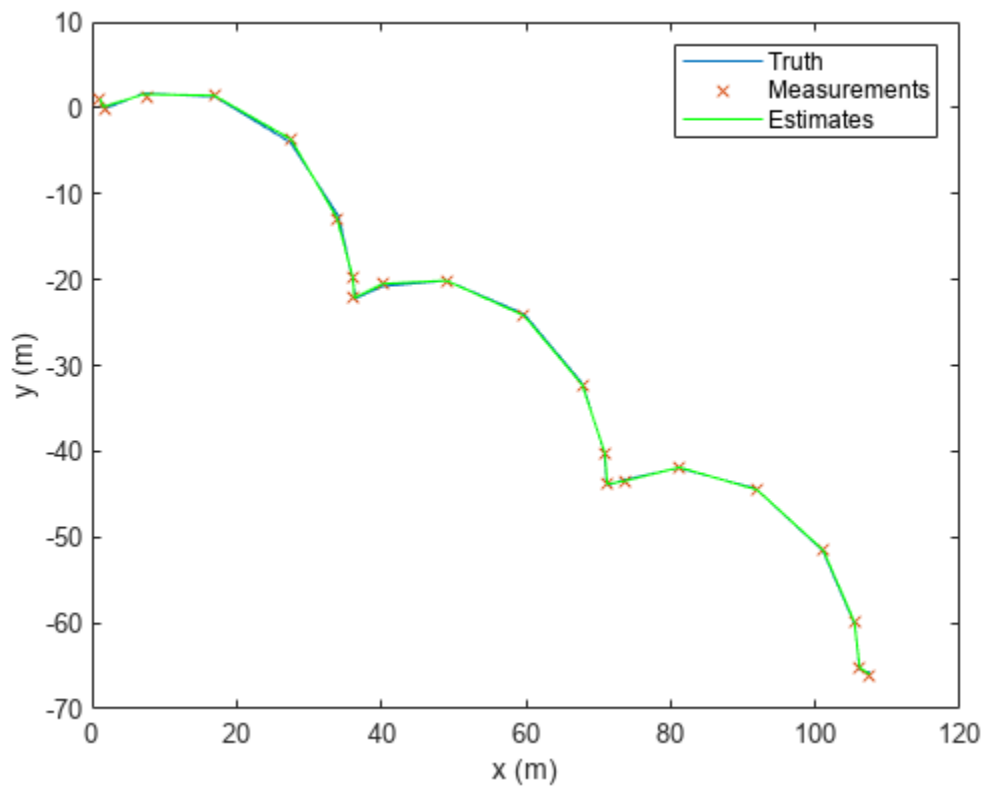

Version History

Introduced in R2017a

References

- [1] Brown, R.G. and P.Y.C. Wang. *Introduction to Random Signal Analysis and Applied Kalman Filtering*. 3rd Edition. New York: John Wiley & Sons, 1997.

[2] Kalman, R. E. "A New Approach to Linear Filtering and Prediction Problems." *Transaction of the ASME-Journal of Basic Engineering*, Vol. 82, Series D, March 1960, pp. 35-45.

[3] Blackman, Samuel. *Multiple-Target Tracking with Radar Applications*. Artech House. 1986.

Extended Capabilities

C/C++ Code Generation

Generate C and C++ code using MATLAB® Coder™.

Usage notes and limitations:

- If you create a `trackingKF` object, and you specify the `MotionModel` property as any value other than "Custom", then you must specify the state vector explicitly at construction time using the `State` property. The choice of motion model determines the size of the state vector, but motion models do not specify the data type such as double precision or single precision. Code generation requires both the size and data type.
- In code generation, after cloning the filter, you cannot change its `EnableSmoothing` property.
- In code generation, after calling the filter, you cannot change its `MaxNumOOSMSteps` property.
- The filter supports strict single-precision code generation.
- The filter supports non-dynamic memory allocation code generation.

See Also

Functions

`initcvkf` | `initcakf`

Objects

`trackingEKF` | `trackingUKF` | `trackingABF` | `multiObjectTracker`

Topics

"Linear Kalman Filters"

trackingABF

Alpha-beta filter for object tracking

Description

The `trackingABF` object represents an alpha-beta filter designed for object tracking for an object that follows a linear motion model and has a linear measurement model. Linear motion is defined by constant velocity or constant acceleration. Use the filter to predict the future location of an object, to reduce noise for a detected location, or to help associate multiple objects with their tracks.

Creation

Syntax

```
abf = trackingABF
abf = trackingABF(Name,Value)
```

Description

`abf = trackingABF` returns an alpha-beta filter for a discrete time, 2-D constant velocity system. The motion model is named `'2D Constant Velocity'` with the state defined as `[x; vx; y; vy]`.

`abf = trackingABF(Name,Value)` specifies the properties of the filter using one or more `Name,Value` pair arguments. Any unspecified properties take default values.

Properties

MotionModel — Model of target motion

```
'2D Constant Velocity' (default) | '1D Constant Velocity' | '3D Constant Velocity' |
'1D Constant Acceleration' | '2D Constant Acceleration' | '3D Constant
Acceleration'
```

Model of target motion, specified as a character vector or string. Specifying 1D, 2D, or 3D specifies the dimension of the target's motion. Specifying `Constant Velocity` assumes that the target motion is a constant velocity at each simulation step. Specifying `Constant Acceleration` assumes that the target motion is a constant acceleration at each simulation step.

Data Types: `char` | `string`

State — Filter state

real-valued M -element vector | scalar

Filter state, specified as a real-valued M -element vector. A scalar input is extended to an M -element vector. The state vector is the concatenated states from each dimension. For example, if `MotionModel` is set to `'3D Constant Acceleration'`, the state vector is in the form: `[x; x'; x''; y; y'; y''; z; z'; z'']` where `'` and `''` indicate first and second order derivatives, respectively.

If you want a filter with single-precision floating-point variables, specify `State` as a single-precision vector variable. For example,

```
filter = trackingABF('State',single([1;2;3;4]))
```

Example: [200;0.2;150;0.1;0;0.25]

Data Types: `single` | `double`

StateCovariance — State estimation error covariance

M-by-*M* matrix | scalar

State error covariance, specified as an *M*-by-*M* matrix, where *M* is the size of the filter state. A scalar input is extended to an *M*-by-*M* matrix. The covariance matrix represents the uncertainty in the filter state.

Example: `eye(6)`

ProcessNoise — Process noise covariance

D-by-*D* matrix | scalar

Process noise covariance, specified as a scalar or a *D*-by-*D* matrix, where *D* is the dimensionality of motion. For example, if `MotionModel` is '2D Constant Velocity', then *D* = 2. A scalar input is extended to a *D*-by-*D* matrix.

Example: [20 0.1; 0.1 1]

MeasurementNoise — Measurement noise covariance

D-by-*D* matrix | scalar

Measurement noise covariance, specified as a scalar or a *D*-by-*D* matrix, where *D* is the dimensionality of motion. For example, if `MotionModel` is '2D Constant Velocity', then *D* = 2. A scalar input is extended to a *M*-by-*M* matrix.

Example: [20 0.1; 0.1 1]

Coefficients — Alpha-beta filter coefficients

row vector | scalar

Alpha-beta filter coefficients, specified as a scalar or row vector. A scalar input is extended to a row vector. If you specify constant velocity in the `MotionModel` property, the coefficients are [alpha beta]. If you specify constant acceleration in the `MotionModel` property, the coefficients are [alpha beta gamma].

Example: [20 0.1]

EnableSmoothing — Enable state smoothing

`false` (default) | `true`

Enable state smoothing, specified as `false` or `true`. Setting this property to `true` requires the Sensor Fusion and Tracking Toolbox license. When specified as `true`, you can:

- Use the `smooth` function, provided in Sensor Fusion and Tracking Toolbox, to smooth state estimates of the previous steps. Internally, the filter stores the results from previous steps to allow backward smoothing.
- Specify the maximum number of smoothing steps using the `MaxNumSmoothingSteps` property of the tracking filter.

MaxNumSmoothingSteps — Maximum number of smoothing steps

5 (default) | positive integer

Maximum number of backward smoothing steps, specified as a positive integer.

Dependencies

To enable this property, set the `EnableSmoothing` property to `true`.

Object Functions

<code>predict</code>	Predict state and state estimation error covariance of tracking filter
<code>correct</code>	Correct state and state estimation error covariance using tracking filter
<code>correctjpda</code>	Correct state and state estimation error covariance using tracking filter and JPDA
<code>distance</code>	Distances between current and predicted measurements of tracking filter
<code>likelihood</code>	Likelihood of measurement from tracking filter
<code>clone</code>	Create duplicate tracking filter

Examples**Run trackingABF Filter**

This example shows how to create and run a `trackingABF` filter. Call the `predict` and `correct` functions to track an object and correct the state estimation based on measurements.

Create the filter. Specify the initial state.

```
state = [1;2;3;4];
abf = trackingABF('State',state);
```

Call `predict` to get the predicted state and covariance of the filter. Use a 0.5 sec time step.

```
[xPred,pPred] = predict(abf, 0.5);
```

Call `correct` with a given measurement.

```
meas = [1;1];
[xCorr,pCorr] = correct(abf, meas);
```

Continue to predict the filter state. Specify the desired time step in seconds if necessary.

```
[xPred,pPred] = predict(abf);           % Predict over 1 second
[xPred,pPred] = predict(abf,2);       % Predict over 2 seconds
```

Modify the filter coefficients and correct again with a new measurement.

```
abf.Coefficients = [0.4 0.2];
[xCorr,pCorr] = correct(abf,[8;14]);
```

Version History

Introduced in R2020a

References

- [1] Blackman, Samuel S. "*Multiple-target tracking with radar applications.*" Dedham, MA, Artech House, Inc., 1986, 463 p. (1986).
- [2] Bar-Shalom, Yaakov, X. Rong Li, and Thiagalingam Kirubarajan. *Estimation with applications to tracking and navigation: theory algorithms and software.* John Wiley & Sons, 2004.

Extended Capabilities

C/C++ Code Generation

Generate C and C++ code using MATLAB® Coder™.

See Also

Objects

`trackingKF` | `trackingEKF` | `trackingUKF` | `multiObjectTracker`

trackingEKF

Extended Kalman filter for object tracking

Description

A `trackingEKF` object is a discrete-time extended Kalman filter used to track dynamical states, such as positions and velocities of objects that can be encountered in an automated driving scenario. Such objects include automobiles, pedestrians, bicycles, and stationary structures or obstacles.

A Kalman filter is a recursive algorithm for estimating the evolving state of a process when measurements are made on the process. The extended Kalman filter can model the evolution of a state when the state follows a nonlinear motion model, when the measurements are nonlinear functions of the state, or when both conditions apply. The extended Kalman filter is based on the linearization of the nonlinear equations. This approach leads to a filter formulation similar to the linear Kalman filter, `trackingKF`.

The process and measurements can have Gaussian noise, which you can include in these ways:

- Add noise to both the process and the measurements. In this case, the sizes of the process noise and measurement noise must match the sizes of the state vector and measurement vector, respectively.
- Add noise in the state transition function, the measurement model function, or in both functions. In these cases, the corresponding noise sizes are not restricted.

See “Extended Kalman Filters” for more details.

Creation

Syntax

```
filter = trackingEKF
filter = trackingEKF(transitionfcn,measurementfcn,state)
filter = trackingEKF( ___,Name,Value)
```

Description

`filter = trackingEKF` creates an extended Kalman filter object for a discrete-time system by using default values for the `StateTransitionFcn`, `MeasurementFcn`, and `State` properties. The process and measurement noises are assumed to be additive.

`filter = trackingEKF(transitionfcn,measurementfcn,state)` specifies the state transition function, `transitionfcn`, the measurement function, `measurementfcn`, and the initial state of the system, `state`.

`filter = trackingEKF(___,Name,Value)` configures the properties of the extended Kalman filter object by using one or more `Name,Value` pair arguments and any of the previous syntaxes. Any unspecified properties have default values.

Properties

State — Kalman filter state

real-valued M -element vector

Kalman filter state, specified as a real-valued M -element vector, where M is the size of the filter state. The value of M is determined based on the motion model you use. For example, if you use a 2-D constant velocity model specified by `constvel`, in which the state is $[x; vx; y; vy]$, M is four.

If you want a filter with single-precision floating-point variables, specify `State` as a single-precision vector variable. For example,

```
filter = trackingEKF('State',single([1;2;3;4]))
```

Example: `[200; 0.2]`

Data Types: `single` | `double`

StateCovariance — State estimation error covariance

positive-definite real-valued M -by- M matrix

State error covariance, specified as a positive-definite real-valued M -by- M matrix where M is the size of the filter state. The covariance matrix represents the uncertainty in the filter state.

Example: `[20 0.1; 0.1 1]`

StateTransitionFcn — State transition function

function handle

State transition function, specified as a function handle. This function calculates the state vector at time step k from the state vector at time step $k - 1$. The function can take additional input parameters, such as control inputs or time step size. The function can also include noise values. You can use one of these functions as your state transition function.

Function Name	Function Purpose
<code>constvel</code>	Constant-velocity state update model
<code>constacc</code>	Constant-acceleration state update model
<code>constturn</code>	Constant turn-rate state update model

You can also write your own state transition function. The valid syntaxes for the state transition function depend on whether the filter has additive process noise. The table shows the valid syntaxes based on the value of the `HasAdditiveProcessNoise` property.

Valid Syntaxes (HasAdditiveProcessNoise = true)	Valid Syntaxes (HasAdditiveProcessNoise = false)
<code>x(k) = statetransitionfcn(x(k-1))</code> <code>x(k) = statetransitionfcn(x(k-1),parameters)</code> <ul style="list-style-type: none"> • <code>x(k)</code> is the state at time <code>k</code>. • <code>parameters</code> stands for all additional arguments required by the state transition function. 	<code>x(k) = statetransitionfcn(x(k-1),w(k-1))</code> <code>x(k) = statetransitionfcn(x(k-1),w(k-1),dt)</code> <code>x(k) = statetransitionfcn(__,parameters)</code> <ul style="list-style-type: none"> • <code>x(k)</code> is the state at time <code>k</code>. • <code>w(k)</code> is a value for the process noise at time <code>k</code>. • <code>dt</code> is the time step of the <code>trackingEKF</code> filter, specified in the most recent call to the <code>predict</code> function. The <code>dt</code> argument applies when you use the filter within a tracker and call the <code>predict</code> function with the filter to predict the state of the tracker at the next time step. For the nonadditive process noise case, the tracker assumes that you explicitly specify the time step by using this syntax: <code>predict(filter,dt)</code>. • <code>parameters</code> stands for all additional arguments required by the state transition function.

Example: @constacc

Data Types: function_handle

StateTransitionJacobianFcn — Jacobian of state transition function

function handle

Jacobian of the state transition function, specified as a function handle. This function has the same input arguments as the state transition function.

The valid syntaxes for the Jacobian of the state transition function depend on whether the filter has additive process noise. The table shows the valid syntaxes based on the value of the `HasAdditiveProcessNoise` property.

Valid Syntaxes (HasAdditiveProcessNoise = true)	Valid Syntaxes (HasAdditiveProcessNoise = false)
<p> <code>Jx(k) = statejacobianfcn(x(k))</code> <code>Jx(k) = statejacobianfcn(x(k),parameters)</code> </p> <ul style="list-style-type: none"> • $x(k)$ is the state at time k. • $Jx(k)$ denotes the Jacobian of the predicted state with respect to the previous state. This Jacobian is an M-by-M matrix at time k. The Jacobian function can take additional input parameters, such as control inputs or time-step size. • <code>parameters</code> stands for all additional arguments required by the Jacobian function, such as control inputs or time-step size. 	<p> <code>[Jx(k),Jw(k)] = statejacobianfcn(x(k),w(k))</code> <code>[Jx(k),Jw(k)] = statejacobianfcn(x(k),w(k),dt)</code> <code>[Jx(k),Jw(k)] = statejacobianfcn(__,parameters)</code> </p> <ul style="list-style-type: none"> • $x(k)$ is the state at time k • $w(k)$ is a sample Q-element vector of the process noise at time k. Q is the size of the process noise covariance. The process noise vector in the nonadditive case does not need to have the same dimensions as the state vector. • $Jx(k)$ denotes the Jacobian of the predicted state with respect to the previous state. This Jacobian is an M-by-M matrix at time k. The Jacobian function can take additional input parameters, such as control inputs or time-step size. • $Jw(k)$ denotes the M-by-Q Jacobian of the predicted state with respect to the process noise elements. • <code>dt</code> is the time step of the <code>trackingEKF</code> filter, <code>filter</code>, specified in the most recent call to the <code>predict</code> function. The <code>dt</code> argument applies when you use the filter within a tracker and call the <code>predict</code> function with the filter to predict the state of the tracker at the next time step. For the nonadditive process noise case, the tracker assumes that you explicitly specify the time step by using this syntax: <code>predict(filter,dt)</code>. • <code>parameters</code> stands for all additional arguments required by the Jacobian function, such as control inputs or time-step size.

If this property is not specified, the Jacobians are computed by numeric differencing at each call of the `predict` function. This computation can increase the processing time and numeric inaccuracy.

Example: `@constaccjac`

Data Types: `function_handle`

ProcessNoise — Process noise covariance

1 (default) | positive real scalar | positive-definite real-valued matrix

Process noise covariance, specified as a scalar or matrix.

- When `HasAdditiveProcessNoise` is `true`, specify the process noise covariance as a positive real scalar or a positive-definite real-valued M -by- M matrix. M is the dimension of the state vector. When specified as a scalar, the matrix is a multiple of the M -by- M identity matrix.

- When `HasAdditiveProcessNoise` is `false`, specify the process noise covariance as a Q -by- Q matrix. Q is the size of the process noise vector.

You must specify `ProcessNoise` before any call to the `predict` function. In later calls to `predict`, you can optionally specify the process noise as a scalar. In this case, the process noise matrix is a multiple of the Q -by- Q identity matrix.

Example: `[1.0 0.05; 0.05 2]`

HasAdditiveProcessNoise – Model additive process noise

`true` (default) | `false`

Option to model process noise as additive, specified as `true` or `false`. When this property is `true`, process noise is added to the state vector. Otherwise, noise is incorporated into the state transition function.

MeasurementFcn – Measurement model function

function handle

Measurement model function, specified as a function handle. The function accepts the M -element state vector as inputs and outputs the N -element measurement vector. You can use one of these functions as your measurement function.

Function Name	Function Purpose
<code>cvmeas</code>	Constant-velocity measurement model
<code>cameas</code>	Constant-acceleration measurement model
<code>ctmeas</code>	Constant turn-rate measurement model

You can also write your own measurement function.

- If `HasAdditiveMeasurementNoise` is `true`, specify the function using one of these syntaxes:

$$z(k) = \text{measurementfcn}(x(k))$$

$$z(k) = \text{measurementfcn}(x(k), \text{parameters})$$

$x(k)$ is the state at time k and $z(k)$ is the predicted measurement at time k . The `parameters` argument stands for all additional arguments required by the measurement function.

- If `HasAdditiveMeasurementNoise` is `false`, specify the function using one of these syntaxes:

$$z(k) = \text{measurementfcn}(x(k), v(k))$$

$$z(k) = \text{measurementfcn}(x(k), v(k), \text{parameters})$$

$x(k)$ is the state at time k and $v(k)$ is the measurement noise at time k . The `parameters` argument stands for all additional arguments required by the measurement function.

- If the `HasMeasurementWrapping` property is `true`, you must additionally return the measurement wrapping bounds, which the filter uses to wrap the measurement residuals, as the second output argument of the measurement function.

$$[z(k), \text{bounds}] = \text{measurementfcn}(_)$$

The function must return `bounds` as an M -by-2 real-valued matrix, where M is the size of $z(k)$. In each row, the first and second elements specify the lower and upper bounds, respectively, for the

corresponding measurement variable. You can use `-Inf` or `Inf` to represent that the variable does not have a lower or upper bound.

For example, consider a measurement function that returns the azimuth and range of a platform as `[azimuth; range]`. If the azimuth angle wraps between `-180` and `180` degrees while the range is unbounded and nonnegative, then specify the second output argument of the function as `[-180 180; 0 Inf]`.

Example: `@cameas`

Data Types: `function_handle`

MeasurementJacobianFcn — Jacobian of measurement function

`function handle`

Jacobian of the measurement function, specified as a function handle. The function has the same input arguments as the measurement function. The function can take additional input parameters, such as sensor position and orientation.

- If `HasAdditiveMeasurementNoise` is `true`, specify the Jacobian function using one of these syntaxes:

$$J_{mx}(k) = \text{measjacobianfcn}(x(k))$$

$$J_{mx}(k) = \text{measjacobianfcn}(x(k), \text{parameters})$$

$x(k)$ is the state at time k . $J_{mx}(k)$ denotes the N -by- M Jacobian of the measurement function with respect to the state. The `parameters` argument stands for all arguments required by the measurement function.

- If `HasAdditiveMeasurementNoise` is `false`, specify the Jacobian function using one of these syntaxes:

$$[J_{mx}(k), J_{mv}(k)] = \text{measjacobianfcn}(x(k), v(k))$$

$$[J_{mx}(k), J_{mv}(k)] = \text{measjacobianfcn}(x(k), v(k), \text{parameters})$$

$x(k)$ is the state at time k and $v(k)$ is an R -dimensional sample noise vector. $J_{mx}(k)$ denotes the N -by- M Jacobian of the measurement function with respect to the state. $J_{mv}(k)$ denotes the Jacobian of the N -by- R measurement function with respect to the measurement noise. The `parameters` argument stands for all arguments required by the measurement function.

If not specified, measurement Jacobians are computed using numerical differencing at each call to the `correct` function. This computation can increase processing time and numerical inaccuracy.

Example: `@cameasjac`

Data Types: `function_handle`

HasMeasurementWrapping — Wrapping of measurement residuals

`0` (default) | `false` or `0` | `true` or `1`

Wrapping of measurement residuals in the filter, specified as a logical `0` (`false`) or `1` (`true`). When specified as `true`, the measurement function specified in the `MeasurementFcn` property must return two output arguments:

- The first argument is the measurement, returned as an M -element real-valued vector.

- The second argument is the wrapping bounds, returned as an M -by-2 real-valued matrix, where M is the dimension of the measurement. In each row, the first and second elements are the lower and upper bounds for the corresponding measurement variable. You can use `-Inf` or `Inf` to represent that the variable does not have a lower or upper bound.

If you enable this property, the filter wraps the measurement residuals according to the measurement bounds, which helps prevent the filter from divergence caused by incorrect measurement residual values.

These measurement functions have predefined wrapping bounds:

- `cvmeas`
- `cameas`
- `ctmeas`

In these functions, the wrapping bounds are `[-180 180]` degrees for azimuth angle measurements and `[-90 90]` degrees for elevation angle measurements. Other measurements are not bounded.

Note You can specify this property only when constructing the filter.

MeasurementNoise — Measurement noise covariance

1 (default) | positive scalar | positive-definite real-valued matrix

Measurement noise covariance, specified as a positive scalar or positive-definite real-valued matrix.

- When `HasAdditiveMeasurementNoise` is `true`, specify the measurement noise covariance as a scalar or an N -by- N matrix. N is the size of the measurement vector. When specified as a scalar, the matrix is a multiple of the N -by- N identity matrix.
- When `HasAdditiveMeasurementNoise` is `false`, specify the measurement noise covariance as an R -by- R matrix. R is the size of the measurement noise vector.

You must specify `MeasurementNoise` before any call to the `correct` function. After the first call to `correct`, you can optionally specify the measurement noise as a scalar. In this case, the measurement noise matrix is a multiple of the R -by- R identity matrix.

Example: `0.2`

HasAdditiveMeasurementNoise — Model additive measurement noise

`true` (default) | `false`

Option to enable additive measurement noise, specified as `true` or `false`. When this property is `true`, noise is added to the measurement. Otherwise, noise is incorporated into the measurement function.

EnableSmoothing — Enable state smoothing

`false` (default) | `true`

Enable state smoothing, specified as `false` or `true`. Setting this property to `true` requires the Sensor Fusion and Tracking Toolbox license. When specified as `true`, you can:

- Use the `smooth` function, provided in Sensor Fusion and Tracking Toolbox, to smooth state estimates of the previous steps. Internally, the filter stores the results from previous steps to allow backward smoothing.

- Specify the maximum number of smoothing steps using the `MaxNumSmoothingSteps` property of the tracking filter.

MaxNumSmoothingSteps — Maximum number of smoothing steps

5 (default) | positive integer

Maximum number of backward smoothing steps, specified as a positive integer.

Dependencies

To enable this property, set the `EnableSmoothing` property to `true`.

MaxNumOOSMSteps — Maximum number of out-of-sequence measurement steps

0 (default) | nonnegative integer

Maximum number of out-of-sequence measurement (OOSM) steps, specified as a nonnegative integer.

- Setting this property to 0 disables the OOSM retrodiction capability of the filter object.
- Setting this property to a positive integer enables the OOSM retrodiction capability of the filter object. This option requires a Sensor Fusion and Tracking Toolbox license. When you set this property as $N > 1$, the filter object saves the past state and state covariance history up to the last $N + 1$ corrections. You can use the `OOSM` and the `retrodict` and `retroCorrect` (or `retroCorrectJPDA` for multiple OOSMs) object functions to reduce the uncertainty of the estimated state.

Increasing the value of this property increases the amount of memory that must be allocated for the state history, but enables you to process OOSMs that arrive after longer delays. Note that the effect of the uncertainty reduction using an OOSM decreases as the delay becomes longer.

Object Functions

<code>predict</code>	Predict state and state estimation error covariance of tracking filter
<code>correct</code>	Correct state and state estimation error covariance using tracking filter
<code>correctjpd</code>	Correct state and state estimation error covariance using tracking filter and JPDA
<code>distance</code>	Distances between current and predicted measurements of tracking filter
<code>likelihood</code>	Likelihood of measurement from tracking filter
<code>clone</code>	Create duplicate tracking filter
<code>residual</code>	Measurement residual and residual noise from tracking filter
<code>initialize</code>	Initialize state and covariance of tracking filter
<code>tunableProperties</code>	Get tunable properties of filter
<code>setTunedProperties</code>	Set properties to tuned values

Examples

Constant-Velocity Extended Kalman Filter

Create a two-dimensional `trackingEKF` object and use name-value pairs to define the `StateTransitionJacobianFcn` and `MeasurementJacobianFcn` properties. Use the predefined constant-velocity motion and measurement models and their Jacobians.

```
EKF = trackingEKF(@constvel,@cvmeas,[0;0;0;0], ...
    'StateTransitionJacobianFcn',@constveljac, ...
    'MeasurementJacobianFcn',@cvmeasjac);
```

Run the filter. Use the `predict` and `correct` functions to propagate the state. You may call `predict` and `correct` in any order and as many times you want. Specify the measurement in Cartesian coordinates.

```
measurement = [1;1;0];
[xpred, Ppred] = predict(EKF);
[xcorr, Pcorr] = correct(EKF,measurement);
[xpred, Ppred] = predict(EKF);
[xpred, Ppred] = predict(EKF)
```

xpred = 4×1

```
1.2500
0.2500
1.2500
0.2500
```

Ppred = 4×4

```
11.7500    4.7500         0         0
 4.7500    3.7500         0         0
         0         0    11.7500    4.7500
         0         0     4.7500    3.7500
```

More About

Filter Parameters

This table relates the filter model parameters to the object properties. M is the size of the state vector. N is the size of the measurement vector.

Filter Parameter	Description	Filter Property	Size
f	State transition function that specifies the equations of motion of the object. This function determines the state at time $k+1$ as a function of the state and the controls at time k . The state transition function depends on the time-increment of the filter.	StateTransitionFcn	Function returns M -element vector
h	Measurement function that specifies how the measurements are functions of the state and measurement noise.	MeasurementFcn	Function returns N -element vector
x_k	Estimate of the object state.	State	M -element vector

Filter Parameter	Description	Filter Property	Size
P_k	State error covariance matrix representing the uncertainty in the values of the state.	StateCovariance	M -by- M matrix
Q_k	Estimate of the process noise covariance matrix at step k . Process noise is a measure of the uncertainty in the dynamic model. It is assumed to be zero-mean white Gaussian noise.	ProcessNoise	M -by- M matrix when HasAdditiveProcessNoise is true. Q -by- Q matrix when HasAdditiveProcessNoise is false
R_k	Estimate of the measurement noise covariance at step k . Measurement noise reflects the uncertainty of the measurement. It is assumed to be zero-mean white Gaussian noise.	MeasurementNoise	N -by- N matrix when HasAdditiveMeasurementNoise is true. R -by- R when HasAdditiveMeasurementNoise is false.
F	Function determining Jacobian of propagated state with respect to previous state.	StateTransitionJacobianFcn	M -by- M matrix
H	Function determining Jacobians of measurement with respect to the state and measurement noise.	MeasurementJacobianFcn	N -by- M for state vector Jacobian and N -by- R for measurement vector Jacobian

Algorithms

The extended Kalman filter estimates the state of a process governed by this nonlinear stochastic equation:

$$x_{k+1} = f(x_k, u_k, w_k, t)$$

x_k is the state at step k . $f()$ is the state transition function. Random noise perturbations, w_k , can affect the object motion. The filter also supports a simplified form,

$$x_{k+1} = f(x_k, u_k, t) + w_k$$

To use the simplified form, set HasAdditiveProcessNoise to true.

In the extended Kalman filter, the measurements are also general functions of the state:

$$z_k = h(x_k, v_k, t)$$

$h(x_k, v_k, t)$ is the measurement function that determines the measurements as functions of the state. Typical measurements are position and velocity or some function of position and velocity. The measurements can also include noise, represented by v_k . Again, the filter offers a simpler formulation.

$$z_k = h(x_k, t) + v_k$$

To use the simplified form, set `HasAdditiveMeasurementNoise` to `true`.

These equations represent the actual motion and the actual measurements of the object. However, the noise contribution at each step is unknown and cannot be modeled deterministically. Only the statistical properties of the noise are known.

Version History

Introduced in R2017a

References

- [1] Brown, R.G. and P.Y.C. Wang. *Introduction to Random Signal Analysis and Applied Kalman Filtering*. 3rd Edition. New York: John Wiley & Sons, 1997.
- [2] Kalman, R. E. "A New Approach to Linear Filtering and Prediction Problems." *Transactions of the ASME-Journal of Basic Engineering*. Vol. 82, Series D, March 1960, pp. 35-45.
- [3] Blackman, Samuel and R. Popoli. *Design and Analysis of Modern Tracking Systems*. Artech House.1999.
- [4] Blackman, Samuel. *Multiple-Target Tracking with Radar Applications*. Artech House. 1986.

Extended Capabilities

C/C++ Code Generation

Generate C and C++ code using MATLAB® Coder™.

Usage notes and limitations:

- In code generation, after cloning the filter, you cannot change its `EnableSmoothing` property.
- In code generation, after calling the filter, you cannot change its `MaxNum00SMSteps` property.
- The filter supports strict single-precision code generation when the specified state transition function and measurement function both support single-precision code generation.
- The filter supports non-dynamic memory allocation code generation.

See Also

Functions

`constacc` | `constaccjac` | `cameas` | `cameasjac` | `constturn` | `constturnjac` | `ctmeas` | `ctmeasjac` | `constvel` | `constveljac` | `cvmeas` | `cvmeasjac` | `initcaekf` | `initcvekf` | `initctekf`

Objects

`trackingKF` | `trackingUKF` | `trackingABF` | `multiObjectTracker`

Topics

“Extended Kalman Filters”

trackingUKF

Unscented Kalman filter for object tracking

Description

The `trackingUKF` object is a discrete-time unscented Kalman filter used to track the positions and velocities of objects that can be encountered in an automated driving scenario. Such objects include automobiles, pedestrians, bicycles, and stationary structures or obstacles.

An unscented Kalman filter is a recursive algorithm for estimating the evolving state of a process when measurements are made on the process. The unscented Kalman filter can model the evolution of a state that obeys a nonlinear motion model. The measurements can also be nonlinear functions of the state, and the process and measurements can have noise.

Use an unscented Kalman filter when one of both of these conditions apply:

- The current state is a nonlinear function of the previous state.
- The measurements are nonlinear functions of the state.

The unscented Kalman filter estimates the uncertainty about the state, and its propagation through the nonlinear state and measurement equations, by using a fixed number of sigma points. Sigma points are chosen by using the unscented transformation, as parameterized by the Alpha, Beta, and Kappa properties.

Creation

Syntax

```
filter = trackingUKF
filter = trackingUKF(transitionfcn,measurementfcn,state)
filter = trackingUKF( ____,Name,Value)
```

Description

`filter = trackingUKF` creates an unscented Kalman filter object for a discrete-time system by using default values for the `StateTransitionFcn`, `MeasurementFcn`, and `State` properties. The process and measurement noises are assumed to be additive.

`filter = trackingUKF(transitionfcn,measurementfcn,state)` specifies the state transition function, `transitionfcn`, the measurement function, `measurementfcn`, and the initial state of the system, `state`.

`filter = trackingUKF(____,Name,Value)` configures the properties of the unscented Kalman filter object using one or more `Name,Value` pair arguments and any of the previous syntaxes. Any unspecified properties have default values.

Properties

State — Kalman filter state

real-valued M -element vector

Kalman filter state, specified as a real-valued M -element vector, where M is the size of the filter state.

If you want a filter with single-precision floating-point variables, specify `State` as a single-precision vector variable. For example,

```
filter = trackingUKF('State',single([1;2;3;4]))
```

Example: [200; 0.2]

Data Types: `single` | `double`

StateCovariance — State estimation error covariance

positive-definite real-valued M -by- M matrix

State error covariance, specified as a positive-definite real-valued M -by- M matrix where M is the size of the filter state. The covariance matrix represents the uncertainty in the filter state.

Example: [20 0.1; 0.1 1]

StateTransitionFcn — State transition function

function handle

State transition function, specified as a function handle. This function calculates the state vector at time step k from the state vector at time step $k - 1$. The function can take additional input parameters, such as control inputs or time step size. The function can also include noise values. You can use one of these functions as your state transition function.

Function Name	Function Purpose
<code>constvel</code>	Constant-velocity state update model
<code>constacc</code>	Constant-acceleration state update model
<code>constturn</code>	Constant turn-rate state update model

You can also write your own state transition function. The valid syntaxes for the state transition function depend on whether the filter has additive process noise. The table shows the valid syntaxes based on the value of the `HasAdditiveProcessNoise` property.

Valid Syntaxes (HasAdditiveProcessNoise = true)	Valid Syntaxes (HasAdditiveProcessNoise = false)
<code>x(k) = statetransitionfcn(x(k-1))</code> <code>x(k) = statetransitionfcn(x(k-1),parameters)</code> <ul style="list-style-type: none"> <code>x(k)</code> is the state at time <code>k</code>. <code>parameters</code> stands for all additional arguments required by the state transition function. 	<code>x(k) = statetransitionfcn(x(k-1),w(k-1))</code> <code>x(k) = statetransitionfcn(x(k-1),w(k-1),dt)</code> <code>x(k) = statetransitionfcn(__,parameters)</code> <ul style="list-style-type: none"> <code>x(k)</code> is the state at time <code>k</code>. <code>w(k)</code> is a value for the process noise at time <code>k</code>. <code>dt</code> is the time step of the <code>trackingUKF</code> filter, specified in the most recent call to the <code>predict</code> function. The <code>dt</code> argument applies when you use the filter within a tracker and call the <code>predict</code> function with the filter to predict the state of the tracker at the next time step. For the nonadditive process noise case, the tracker assumes that you explicitly specify the time step by using this syntax: <code>predict(filter,dt)</code>. <code>parameters</code> stands for all additional arguments required by the state transition function.

Example: `@constacc`

Data Types: `function_handle`

ProcessNoise — Process noise covariance

1 (default) | positive real scalar | positive-definite real-valued matrix

Process noise covariance, specified as a scalar or matrix.

- When `HasAdditiveProcessNoise` is `true`, specify the process noise covariance as a positive real scalar or a positive-definite real-valued M -by- M matrix. M is the dimension of the state vector. When specified as a scalar, the matrix is a multiple of the M -by- M identity matrix.
- When `HasAdditiveProcessNoise` is `false`, specify the process noise covariance as a Q -by- Q matrix. Q is the size of the process noise vector.

You must specify `ProcessNoise` before any call to the `predict` function. In later calls to `predict`, you can optionally specify the process noise as a scalar. In this case, the process noise matrix is a multiple of the Q -by- Q identity matrix.

Example: `[1.0 0.05; 0.05 2]`

HasAdditiveProcessNoise — Model additive process noise

`true` (default) | `false`

Option to model process noise as additive, specified as `true` or `false`. When this property is `true`, process noise is added to the state vector. Otherwise, noise is incorporated into the state transition function.

MeasurementFcn — Measurement model function

`function_handle`

Measurement model function, specified as a function handle. The function accepts the M -element state vector as inputs and outputs the N -element measurement vector. You can use one of these functions as your measurement function.

Function Name	Function Purpose
cvmeas	Constant-velocity measurement model
cameas	Constant-acceleration measurement model
ctmeas	Constant turn-rate measurement model

You can also write your own measurement function.

- If `HasAdditiveMeasurementNoise` is `true`, specify the function using one of these syntaxes:

```
z(k) = measurementfcn(x(k))
```

```
z(k) = measurementfcn(x(k),parameters)
```

$x(k)$ is the state at time k and $z(k)$ is the predicted measurement at time k . The `parameters` argument stands for all additional arguments required by the measurement function.

- If `HasAdditiveMeasurementNoise` is `false`, specify the function using one of these syntaxes:

```
z(k) = measurementfcn(x(k),v(k))
```

```
z(k) = measurementfcn(x(k),v(k),parameters)
```

$x(k)$ is the state at time k and $v(k)$ is the measurement noise at time k . The `parameters` argument stands for all additional arguments required by the measurement function.

- If the `HasMeasurementWrapping` property is `true`, you must additionally return the measurement wrapping bounds, which the filter uses to wrap the measurement residuals, as the second output argument of the measurement function.

```
[z(k),bounds] = measurementfcn(__)
```

The function must return `bounds` as an M -by-2 real-valued matrix, where M is the size of $z(k)$. In each row, the first and second elements specify the lower and upper bounds, respectively, for the corresponding measurement variable. You can use `-Inf` or `Inf` to represent that the variable does not have a lower or upper bound.

For example, consider a measurement function that returns the azimuth and range of a platform as `[azimuth; range]`. If the azimuth angle wraps between -180 and 180 degrees while the range is unbounded and nonnegative, then specify the second output argument of the function as `[-180 180; 0 Inf]`.

Example: `@cameas`

Data Types: `function_handle`

HasMeasurementWrapping — Wrapping of measurement residuals

0 (default) | `false` or 0 | `true` or 1

Wrapping of measurement residuals in the filter, specified as a logical 0 (`false`) or 1 (`true`). When specified as `true`, the measurement function specified in the `MeasurementFcn` property must return two output arguments:

- The first argument is the measurement, returned as an M -element real-valued vector.
- The second argument is the wrapping bounds, returned as an M -by-2 real-valued matrix, where M is the dimension of the measurement. In each row, the first and second elements are the lower and upper bounds for the corresponding measurement variable. You can use `-Inf` or `Inf` to represent that the variable does not have a lower or upper bound.

If you enable this property, the filter wraps the measurement residuals according to the measurement bounds, which helps prevent the filter from divergence caused by incorrect measurement residual values.

These measurement functions have predefined wrapping bounds:

- `cvmeas`
- `cameas`
- `ctmeas`

In these functions, the wrapping bounds are `[-180 180]` degrees for azimuth angle measurements and `[-90 90]` degrees for elevation angle measurements. Other measurements are not bounded.

Note You can specify this property only when constructing the filter.

MeasurementNoise — Measurement noise covariance

1 (default) | positive scalar | positive-definite real-valued matrix

Measurement noise covariance, specified as a positive scalar or positive-definite real-valued matrix.

- When `HasAdditiveMeasurementNoise` is `true`, specify the measurement noise covariance as a scalar or an N -by- N matrix. N is the size of the measurement vector. When specified as a scalar, the matrix is a multiple of the N -by- N identity matrix.
- When `HasAdditiveMeasurementNoise` is `false`, specify the measurement noise covariance as an R -by- R matrix. R is the size of the measurement noise vector.

You must specify `MeasurementNoise` before any call to the `correct` function. After the first call to `correct`, you can optionally specify the measurement noise as a scalar. In this case, the measurement noise matrix is a multiple of the R -by- R identity matrix.

Example: `0.2`

HasAdditiveMeasurementNoise — Model additive measurement noise

`true` (default) | `false`

Option to enable additive measurement noise, specified as `true` or `false`. When this property is `true`, noise is added to the measurement. Otherwise, noise is incorporated into the measurement function.

Alpha — Sigma point spread around state

`1.0e-3` (default) | positive scalar greater than 0 and less than or equal to 1

Sigma point spread around state, specified as a positive scalar greater than 0 and less than or equal to 1.

Beta — Distribution of sigma points

2 (default) | nonnegative scalar

Distribution of sigma points, specified as a nonnegative scalar. This parameter incorporates knowledge of the noise distribution of states for generating sigma points. For Gaussian distributions, setting `Beta` to 2 is optimal.

Kappa — Secondary scaling factor for generating sigma points

0 (default) | scalar from 0 to 3

Secondary scaling factor for generation of sigma points, specified as a scalar from 0 to 3. This parameter helps specify the generation of sigma points.

EnableSmoothing — Enable state smoothing

false (default) | true

Enable state smoothing, specified as `false` or `true`. Setting this property to `true` requires the Sensor Fusion and Tracking Toolbox license. When specified as `true`, you can:

- Use the `smooth` function, provided in Sensor Fusion and Tracking Toolbox, to smooth state estimates of the previous steps. Internally, the filter stores the results from previous steps to allow backward smoothing.
- Specify the maximum number of smoothing steps using the `MaxNumSmoothingSteps` property of the tracking filter.

MaxNumSmoothingSteps — Maximum number of smoothing steps

5 (default) | positive integer

Maximum number of backward smoothing steps, specified as a positive integer.

Dependencies

To enable this property, set the `EnableSmoothing` property to `true`.

Object Functions

<code>predict</code>	Predict state and state estimation error covariance of tracking filter
<code>correct</code>	Correct state and state estimation error covariance using tracking filter
<code>correctjpd</code>	Correct state and state estimation error covariance using tracking filter and JPDA
<code>distance</code>	Distances between current and predicted measurements of tracking filter
<code>likelihood</code>	Likelihood of measurement from tracking filter
<code>clone</code>	Create duplicate tracking filter
<code>residual</code>	Measurement residual and residual noise from tracking filter
<code>initialize</code>	Initialize state and covariance of tracking filter
<code>tunableProperties</code>	Get tunable properties of filter
<code>setTunedProperties</code>	Set properties to tuned values

Examples

Constant-Velocity Unscented Kalman Filter

Create a `trackingUKF` object using the predefined constant-velocity motion model, `constvel`, and the associated measurement model, `cvmeas`. These models assume that the state vector has the form $[x;vx;y;vy]$ and that the position measurement is in Cartesian coordinates, $[x;y;z]$. Set the sigma point spread property to `1e-2`.

```
filter = trackingUKF(@constvel,@cvmeas,[0;0;0;0], 'Alpha',1e-2);
```

Run the filter. Use the `predict` and `correct` functions to propagate the state. You can call `predict` and `correct` in any order and as many times as you want.

```
meas = [1;1;0];
[xpred, Ppred] = predict(filter);
[xcorr, Pcorr] = correct(filter,meas);
[xpred, Ppred] = predict(filter);
[xpred, Ppred] = predict(filter)
```

```
xpred = 4×1
```

```
1.2500
0.2500
1.2500
0.2500
```

```
Ppred = 4×4
```

```
11.7500    4.7500   -0.0000    0.0000
 4.7500    3.7500    0.0000   -0.0000
-0.0000    0.0000   11.7500    4.7500
 0.0000   -0.0000    4.7500    3.7500
```

More About

Filter Parameters

This table relates the filter model parameters to the object properties. M is the size of the state vector. N is the size of the measurement vector.

Model Parameter	Description	Filter Property	Size
f	State transition function that specifies the equations of motion of the object. This function determines the state at time $k+1$ as a function of the state and the controls at time k . The state transition function depends on the time-increment of the filter.	StateTransitionFcn	Function returns M -element vector
h	Measurement function that specifies how the measurements are functions of the state and measurement noise.	MeasurementFcn	Function returns N -element vector

Model Parameter	Description	Filter Property	Size
x_k	Estimate of the object state.	State	M
P_k	State error covariance matrix representing the uncertainty in the values of the state	StateCovariance	M -by- M
Q_k	Estimate of the process noise covariance matrix at step k . Process noise is measure of the uncertainty in your dynamic model and is assumed to be zero-mean white Gaussian noise	ProcessNoise	M -by- M when HasAdditiveProcessNoise is true. Q -by- Q when HasAdditiveProcessNoise is false.
R_k	Estimate of the measurement noise covariance at step k . Measurement noise reflects the uncertainty of the measurement and is assumed to be zero-mean white Gaussian noise.	MeasurementNoise	N -by- N when HasAdditiveMeasurementNoise is true. R -by- R when HasAdditiveMeasurementNoise is false.
α	Determines spread of sigma points.	Alpha	scalar
β	<i>A priori</i> knowledge of sigma point distribution.	Beta	scalar
κ	Secondary scaling parameter.	Kappa	scalar

Algorithms

The unscented Kalman filter estimates the state of a process governed by a nonlinear stochastic equation

$$x_{k+1} = f(x_k, u_k, w_k, t)$$

where x_k is the state at step k . $f()$ is the state transition function, u_k are the controls on the process. The motion may be affected by random noise perturbations, w_k . The filter also supports a simplified form,

$$x_{k+1} = f(x_k, u_k, t) + w_k$$

To use the simplified form, set HasAdditiveProcessNoise to true.

In the unscented Kalman filter, the measurements are also general functions of the state,

$$z_k = h(x_k, v_k, t)$$

where $h(x_k, v_k, t)$ is the measurement function that determines the measurements as functions of the state. Typical measurements are position and velocity or some function of these. The measurements can include noise as well, represented by v_k . Again the class offers a simpler formulation

$$z_k = h(x_k, t) + v_k$$

To use the simplified form, set `HasAdditiveMeasurementNoise` to `true`.

These equations represent the actual motion of the object and the actual measurements. However, the noise contribution at each step is unknown and cannot be modeled exactly. Only statistical properties of the noise are known.

Version History

Introduced in R2017a

References

- [1] Brown, R.G. and P.Y.C. Wang. *Introduction to Random Signal Analysis and Applied Kalman Filtering*. 3rd Edition. New York: John Wiley & Sons, 1997.
- [2] Kalman, R. E. "A New Approach to Linear Filtering and Prediction Problems." *Transactions of the ASME-Journal of Basic Engineering*. Vol. 82, Series D, March 1960, pp. 35-45.
- [3] Wan, Eric A. and R. van der Merwe. "The Unscented Kalman Filter for Nonlinear Estimation". *Adaptive Systems for Signal Processing, Communications, and Control*. AS-SPCC, IEEE, 2000, pp.153-158.
- [4] Wan, Merle. "The Unscented Kalman Filter." In *Kalman Filtering and Neural Networks*. Edited by Simon Haykin. John Wiley & Sons, Inc., 2001.
- [5] Sarkka S. "Recursive Bayesian Inference on Stochastic Differential Equations." Doctoral Dissertation. Helsinki University of Technology, Finland. 2006.
- [6] Blackman, Samuel. *Multiple-Target Tracking with Radar Applications*. Artech House, 1986.

Extended Capabilities

C/C++ Code Generation

Generate C and C++ code using MATLAB® Coder™.

Usage notes and limitations:

- Generated code uses an algorithm that is different from the algorithm that the `trackingUKF` object uses. You might see some numerical differences in the results obtained using the two methods.
- The filter supports strict single-precision code generation when the specified state transition function and measurement function both support single-precision code generation.
- The filter supports non-dynamic memory allocation code generation.

See Also

Functions

constacc | constaccjac | cameas | cameasjac | constturn | constturnjac | ctmeas |
ctmeasjac | constvel | constveljac | cvmeas | cvmeasjac | initcaukf | initcvukf |
initctukf

Objects

trackingKF | trackingEKF | trackingABF | multiObjectTracker

clone

Create duplicate tracking filter

Syntax

```
filterClone = clone(filter)
```

Description

`filterClone = clone(filter)` creates a copy of a tracking filter that has the same property values as the original filter.

Input Arguments

filter — Filter for object tracking

trackingKF object | trackingEKF object | trackingUKF object

Filter for object tracking, specified as one of these objects:

- trackingKF — Linear Kalman filter
- trackingEKF — Extended Kalman filter
- trackingUKF — Unscented Kalman filter
- trackingABF — Alpha-beta filter

Output Arguments

filterClone — Cloned filter

tracking filter object

Cloned filter, returned as a tracking filter object of the same type as `filter`. The cloned filter has the same properties as the original filter.

Version History

Introduced in R2017a

Extended Capabilities

C/C++ Code Generation

Generate C and C++ code using MATLAB® Coder™.

See Also

`correct` | `correctjpd` | `distance` | `initialize` | `likelihood` | `predict` | `residual`

correct

Correct state and state estimation error covariance using tracking filter

Syntax

```
[xcorr,Pcorr] = correct(filter,zmeas)
[xcorr,Pcorr] = correct(filter,zmeas,measparams)
[xcorr,Pcorr] = correct(filter,zmeas,zcov)
[xcorr,Pcorr,zcorr] = correct(filter,zmeas)
[xcorr,Pcorr,zcorr] = correct(filter,zmeas,zcov)

correct(filter, ___)
xcorr = correct(filter, ___)
```

Description

`[xcorr,Pcorr] = correct(filter,zmeas)` returns the corrected state, `xcorr`, and the corrected state estimation error covariance, `Pcorr`, for the next time step of the input tracking filter based on the current measurement, `zmeas`. The corrected values overwrite the internal state and state estimation error covariance of `filter`.

`[xcorr,Pcorr] = correct(filter,zmeas,measparams)` specifies additional parameters used by the measurement function that is defined in the `MeasurementFcn` property of `filter`. You can return any of the outputs from preceding syntaxes.

If `filter` is a `trackingKF` or `trackingABF` object, then you cannot use this syntax.

`[xcorr,Pcorr] = correct(filter,zmeas,zcov)` specifies additional measurement covariance, `zcov`, used in the `MeasurementNoise` property of `filter`.

You can use this syntax only when `filter` is a `trackingKF` object.

`[xcorr,Pcorr,zcorr] = correct(filter,zmeas)` also returns the correction of measurements, `zcorr`.

You can use this syntax only when `filter` is a `trackingABF` object.

`[xcorr,Pcorr,zcorr] = correct(filter,zmeas,zcov)` returns the correction of measurements, `zcorr`, and also specifies additional measurement covariance, `zcov`, used in the `MeasurementNoise` property of `filter`.

You can use this syntax only when `filter` is a `trackingABF` object.

`correct(filter, ___)` updates `filter` with the corrected state and state estimation error covariance without returning the corrected values. Specify the tracking filter and any of the input argument combinations from preceding syntaxes.

`xcorr = correct(filter, ___)` updates `filter` with the corrected state and state estimation error covariance but returns only the corrected state, `xcorr`.

Examples

Constant-Velocity Extended Kalman Filter

Create a two-dimensional `trackingEKF` object and use name-value pairs to define the `StateTransitionJacobianFcn` and `MeasurementJacobianFcn` properties. Use the predefined constant-velocity motion and measurement models and their Jacobians.

```
EKF = trackingEKF(@constvel,@cvmeas,[0;0;0;0], ...
    'StateTransitionJacobianFcn',@constveljac, ...
    'MeasurementJacobianFcn',@cvmeasjac);
```

Run the filter. Use the `predict` and `correct` functions to propagate the state. You may call `predict` and `correct` in any order and as many times you want. Specify the measurement in Cartesian coordinates.

```
measurement = [1;1;0];
[xpred, Ppred] = predict(EKF);
[xcorr, Pcorr] = correct(EKF,measurement);
[xpred, Ppred] = predict(EKF);
[xpred, Ppred] = predict(EKF)
```

xpred = 4×1

```
    1.2500
    0.2500
    1.2500
    0.2500
```

Ppred = 4×4

```
    11.7500    4.7500         0         0
     4.7500    3.7500         0         0
         0         0    11.7500    4.7500
         0         0     4.7500    3.7500
```

Input Arguments

filter — Filter for object tracking

`trackingKF` object | `trackingEKF` object | `trackingUKF` object

Filter for object tracking, specified as one of these objects:

- `trackingKF` — Linear Kalman filter
- `trackingEKF` — Extended Kalman filter
- `trackingUKF` — Unscented Kalman filter
- `trackingABF` — Alpha-beta filter

zmeas — Measurement of filter

vector | matrix

Measurement of the tracked object, specified as a vector or matrix.

Data Types: `single` | `double`

measparams — Measurement parameters

comma-separated list of arguments

Measurement function arguments, specified as a comma-separated list of arguments. These arguments are the same ones that are passed into the measurement function specified by the `MeasurementFcn` property of the tracking filter. If `filter` is a `trackingKF` or `trackingABF` object, then you cannot specify `measparams`.

Suppose you set `MeasurementFcn` to `@cameas`, and then call `correct`:

```
[xcorr,Pcorr] = correct(filter,frame,sensorpos,sensorvel)
```

The `correct` function internally calls the following:

```
meas = cameas(state,frame,sensorpos,sensorvel)
```

zcov — Measurement covariance

M -by- M matrix

Measurement covariance, specified as an M -by- M matrix, where M is the dimension of the measurement. The same measurement covariance matrix is assumed for all measurements in `zmeas`.

Data Types: `single` | `double`

Output Arguments

xcorr — Corrected state of filter

vector | matrix

Corrected state of the filter, specified as a vector or matrix. The `State` property of the input `filter` is overwritten with this value.

Pcorr — Corrected state covariance of filter

vector | matrix

Corrected state covariance of the filter, specified as a vector or matrix. The `StateCovariance` property of the input `filter` is overwritten with this value.

zcov — Corrected measurement of filter

vector | matrix

Corrected measurement of the filter, specified as a vector or matrix. You can return `zcov` only when `filter` is a `trackingABF` object.

Version History

Introduced in R2017a

Extended Capabilities

C/C++ Code Generation

Generate C and C++ code using MATLAB® Coder™.

See Also

`clone` | `correctjpd` | `distance` | `initialize` | `likelihood` | `predict` | `residual`

correctjpda

Correct state and state estimation error covariance using tracking filter and JPDA

Syntax

```
[xcorr,Pcorr] = correctjpda(filter,zmeas,jpdacoeffs)
```

```
[xcorr,Pcorr] = correctjpda(filter,zmeas,jpdacoeffs,measparams)
```

```
[xcorr,Pcorr] = correctjpda(filter,zmeas,jpdacoeffs,zcov)
```

```
[xcorr,Pcorr,zcorr] = correctjpda(filter,zmeas,jpdacoeffs)
```

```
[xcorr,Pcorr,zcorr] = correctjpda(filter,zmeas,jpdacoeffs,zcov)
```

Description

`[xcorr,Pcorr] = correctjpda(filter,zmeas,jpdacoeffs)` returns the corrected state, `xcorr`, and the corrected state estimation error covariance, `Pcorr`, for the next time step of the input tracking filter. The corrected values are based on a set of measurements, `zmeas`, and their joint probabilistic data association coefficients, `jpdacoeffs`. These values overwrite the internal state and state estimation error covariance of `filter`.

`[xcorr,Pcorr] = correctjpda(filter,zmeas,jpdacoeffs,measparams)` specifies additional parameters used by the measurement function that is defined in the `MeasurementFcn` property of the tracking filter object.

If `filter` is a `trackingKF` or `trackingABF` object, then you cannot use this syntax.

`[xcorr,Pcorr] = correctjpda(filter,zmeas,jpdacoeffs,zcov)` specifies additional measurement covariance, `zcov`, used in the `MeasurementNoise` property of `filter`.

You can use this syntax only when `filter` is a `trackingKF` object.

`[xcorr,Pcorr,zcorr] = correctjpda(filter,zmeas,jpdacoeffs)` also returns the correction of measurements, `zcorr`.

You can use this syntax only when `filter` is a `trackingABF` object.

`[xcorr,Pcorr,zcorr] = correctjpda(filter,zmeas,jpdacoeffs,zcov)` returns the correction of measurements, `zcorr`, and also specifies additional measurement covariance, `zcov`, used in the `MeasurementNoise` property of `filter`.

You can use this syntax only when `filter` is a `trackingABF` object.

Input Arguments

filter — Filter for object tracking

`trackingKF` object | `trackingEKF` object | `trackingUKF` object

Filter for object tracking, specified as one of these objects:

- `trackingKF` — Linear Kalman filter
- `trackingEKF` — Extended Kalman filter
- `trackingUKF` — Unscented Kalman filter
- `trackingABF` — Alpha-beta filter

zmeas — Measurements

M-by-*N* matrix

Measurements, specified as an *M*-by-*N* matrix, where *M* is the dimension of a single measurement, and *N* is the number of measurements.

Data Types: `single` | `double`

jpgdcoeffs — Joint probabilistic data association coefficients

(*N*+1)-element vector

Joint probabilistic data association coefficients, specified as an (*N*+1)-element vector. The *i*th (*i* = 1, ..., *N*) element of `jpgdcoeffs` is the joint probability that the *i*th measurement in `zmeas` is associated with the filter. The last element of `jpgdcoeffs` corresponds to the probability that no measurement is associated with the filter. The sum of all elements of `jpgdcoeffs` must equal 1.

Data Types: `single` | `double`

zcov — Measurement covariance

M-by-*M* matrix

Measurement covariance, specified as an *M*-by-*M* matrix, where *M* is the dimension of the measurement. The same measurement covariance matrix is assumed for all measurements in `zmeas`.

Data Types: `single` | `double`

measparams — Measurement parameters

comma-separated list of arguments

Measurement function arguments, specified as a comma-separated list of arguments. These arguments are the same ones that are passed into the measurement function specified by the `MeasurementFcn` property of the tracking filter. If `filter` is a `trackingKF` or `trackingABF` object, then you cannot specify `measparams`.

Suppose you set `MeasurementFcn` to `@cameas`, and then call `correctjpda`:

```
[xcorr,Pcorr] = correctjpda(filter,frame,sensorpos,sensorvel)
```

The `correctjpda` function internally calls the following:

```
meas = cameas(state,frame,sensorpos,sensorvel)
```

Output Arguments

xcorr — Corrected state

P-element vector

Corrected state, returned as a *P*-element vector, where *P* is the dimension of the estimated state. The corrected state represents the *a posteriori* estimate of the state vector, taking into account the current measurements and their associated probabilities.

Pcorr — Corrected state error covariancepositive-definite P -by- P matrix

Corrected state error covariance, returned as a positive-definite P -by- P matrix, where P is the dimension of the state estimate. The corrected state covariance matrix represents the *a posteriori* estimate of the state covariance matrix, taking into account the current measurements and their associated probabilities.

zcorr — Corrected measurements M -by- N matrix

Corrected measurements, returned as an M -by- N matrix, where M is the dimension of a single measurement, and N is the number of measurements. You can return `zcorr` only when `filter` is a `trackingABF` object.

More About**JPDA Correction Algorithm for Discrete Extended Kalman Filter**

In the measurement update of a regular Kalman filter, the filter usually only needs to update the state and covariance based on one measurement. For instance, the equations for measurement update of a discrete extended Kalman filter can be given as

$$\begin{aligned}x_k^+ &= x_k^- + K_k(y - h(x_k^-)) \\ P_k^+ &= P_k^- - K_k S_k K_k^T\end{aligned}$$

where x_k^- and x_k^+ are the a priori and a posteriori state estimates, respectively, K_k is the Kalman gain, y is the actual measurement, and $h(x_k^-)$ is the predicted measurement. P_k^- and P_k^+ are the a priori and a posteriori state error covariance matrices, respectively. The innovation matrix S_k is defined as

$$S_k = H_k P_k^- H_k^T$$

where H_k is the Jacobian matrix for the measurement function h .

In the workflow of a JPDA tracker, the filter needs to process multiple probable measurements y_i ($i = 1, \dots, N$) with varied probabilities of association β_i ($i = 0, 1, \dots, N$). Note that β_0 is the probability that no measurements is associated with the filter. The measurement update equations for a discrete extended Kalman filter used for a JPDA tracker are

$$\begin{aligned}x_k^+ &= x_k^- + K_k \sum_{i=1}^N \beta_i (y_i - h(x_k^-)) \\ P_k^+ &= P_k^- - (1 - \beta_0) K_k S_k K_k^T + P_k\end{aligned}$$

where

$$P_k = K_k \sum_{i=1}^N \left[\beta_i (y_i - h(x_k^-))(y_i - h(x_k^-))^T - (\delta y)(\delta y)^T \right] K_k^T$$

and

$$\delta y = \sum_{j=1}^N \beta_j (y_j - h(x_k^-))$$

Note that these equations only apply to `trackingEKF` and are not the exact equations used in other tracking filters.

Version History

Introduced in R2019a

References

- [1] Fortmann, T., Y. Bar-Shalom, and M. Scheffe. "Sonar Tracking of Multiple Targets Using Joint Probabilistic Data Association." *IEEE Journal of Ocean Engineering*. Vol. 8, Number 3, 1983, pp. 173-184.

Extended Capabilities

C/C++ Code Generation

Generate C and C++ code using MATLAB® Coder™.

Usage notes and limitations:

`correctjpd` supports only double-precision code generation, not single-precision.

See Also

`clone` | `correct` | `distance` | `initialize` | `likelihood` | `predict` | `residual`

distance

Distances between current and predicted measurements of tracking filter

Syntax

```
dist = distance(filter,zmeas)
dist = distance(filter,zmeas,measparams)
```

Description

`dist = distance(filter,zmeas)` computes the normalized distances between one or more current object measurements, `zmeas`, and the corresponding predicted measurements computed by the input `filter`. Use this function to assign measurements to tracks.

This distance computation takes into account the covariance of the predicted state and the measurement noise.

`dist = distance(filter,zmeas,measparams)` specifies additional parameters that are used by the `MeasurementFcn` of the filter.

If `filter` is a `trackingKF` or `trackingABF` object, then you cannot use this syntax.

Input Arguments

filter — Filter for object tracking

`trackingKF` object | `trackingEKF` object | `trackingUKF` object

Filter for object tracking, specified as one of these objects:

- `trackingKF` — Linear Kalman filter
- `trackingEKF` — Extended Kalman filter
- `trackingUKF` — Unscented Kalman filter
- `trackingABF` — Alpha-beta filter

zmeas — Measurements of tracked objects

matrix

Measurements of tracked objects, specified as a matrix. Each row of the matrix contains a measurement vector.

measparams — Parameters for measurement function

cell array

Parameters for measurement function, specified as a cell array. The parameters are passed to the measurement function that is defined in the `MeasurementFcn` property of the `filter`. If `filter` is a `trackingKF` or `trackingABF` object, then you cannot specify `measparams`.

Suppose you set the `MeasurementFcn` property of `filter` to `@cameas`, and then set these values:

```
measurementParams = {frame,sensorpos,sensorpos}
```

The `distance` function internally calls the following:

```
cameas (state, frame, sensorpos, sensorvel)
```

Output Arguments

dist – Distances between measurements

row vector

Distances between measurements, returned as a row vector. Each element corresponds to a distance between the predicted measurement in the input `filter` and a measurement contained in a row of `zmeas`.

Algorithms

The `distance` function computes the normalized distance between the filter object and a set of measurements. This distance computation is a variant of the Mahalanobis distance and takes into account the residual (the difference between the object measurement and the value predicted by the filter), the residual covariance, and the measurement noise.

Consider an extended Kalman filter with state x and measurement z . The equations used to compute the residual, z_{res} , and the residual covariance, S , are

$$\begin{aligned} z_{\text{res}} &= z - h(x), \\ S &= R + HPH^T, \end{aligned}$$

where:

- h is the measurement function defined in the `MeasurementFcn` property of the filter.
- R is the measurement noise covariance defined in the `MeasurementNoise` property of the filter.
- H is the Jacobian of the measurement function defined in the `MeasurementJacobianFcn` property of the filter.

The residual covariance calculation for other filters can vary slightly from the one shown because tracking filters have different ways of propagating the covariance to the measurement space. For example, instead of using the Jacobian of the measurement function to propagate the covariance, unscented Kalman filters sample the covariance, and then propagate the sampled points.

The equation for the Mahalanobis distance, d^2 , is

$$d^2 = z_{\text{res}}^T S^{-1} z_{\text{res}},$$

The distance function computes the normalized distance, d_n , as

$$d_n = d^2 + \log(|S|),$$

where $\log(|S|)$ is the logarithm of the determinant of residual covariance S .

The $\log(|S|)$ term accounts for tracks that are coasted, meaning that they are predicted but have not had an update for a long time. Tracks in this state can make S very large, resulting in a smaller Mahalanobis distance relative to the updated tracks. This difference in distance values can cause the coasted tracks to incorrectly take detections from the updated tracks. The $\log(|S|)$ term compensates for this effect by penalizing such tracks, whose predictions are highly uncertain.

Version History

Introduced in R2017a

Extended Capabilities

C/C++ Code Generation

Generate C and C++ code using MATLAB® Coder™.

See Also

`clone` | `correct` | `correctjpda` | `initialize` | `likelihood` | `predict` | `residual`

initialize

Initialize state and covariance of tracking filter

Syntax

```
initialize(filter, state, statecov)
initialize(filter, state, statecov, Name, Value)
```

Description

`initialize(filter, state, statecov)` initializes the filter by setting the `State` and `StateCovariance` properties of the filter with the corresponding `state` and `statecov` inputs.

`initialize(filter, state, statecov, Name, Value)` also initializes properties of `filter` by using one or more name-value pairs. Specify the name of the filter property and the value to which you want to initialize it. You cannot change the size or type of the properties that you initialize.

Input Arguments

filter — Filter for object tracking

`trackingKF` object | `trackingEKF` object | `trackingUKF` object

Filter for object tracking, specified as one of these objects:

- `trackingKF` — Linear Kalman filter
- `trackingEKF` — Extended Kalman filter
- `trackingUKF` — Unscented Kalman filter

state — Filter state

real-valued M -element vector

Filter state, specified as a real-valued M -element vector, where M is the size of the filter state.

Example: `[200; 0.2]`

Data Types: `double`

statecov — State estimation error covariance

positive-definite real-valued M -by- M matrix

State estimation error covariance, specified as a positive-definite real-valued M -by- M matrix. M is the size of the filter state. The covariance matrix represents the uncertainty in the filter state.

Example: `[20 0.1; 0.1 1]`

Version History

Introduced in R2018b

Extended Capabilities

C/C++ Code Generation

Generate C and C++ code using MATLAB® Coder™.

See Also

`clone` | `correct` | `correctjpda` | `distance` | `likelihood` | `predict` | `residual`

likelihood

Likelihood of measurement from tracking filter

Syntax

```
measlikelihood = likelihood(filter,zmeas)
measlikelihood = likelihood(filter,zmeas,measparams)
```

Description

`measlikelihood = likelihood(filter,zmeas)` returns the likelihood of a measurement, `zmeas`, that was produced by the specified filter, `filter`.

`measlikelihood = likelihood(filter,zmeas,measparams)` specifies additional parameters that are used by the `MeasurementFcn` of the filter.

If `filter` is a `trackingKF` or `trackingABF` object, then you cannot use this syntax.

Input Arguments

filter — Filter for object tracking

`trackingKF` object | `trackingEKF` object | `trackingUKF` object

Filter for object tracking, specified as one of these objects:

- `trackingKF` — Linear Kalman filter
- `trackingEKF` — Extended Kalman filter
- `trackingUKF` — Unscented Kalman filter
- `trackingABF` — Alpha-beta filter

zmeas — Current measurement of tracked object

vector | matrix

Current measurement of a tracked object, specified a vector or matrix.

measparams — Parameters for measurement function

cell array

Parameters for measurement function, specified as a cell array. The parameters are passed to the measurement function that is defined in the `MeasurementFcn` of the input filter. If `filter` is a `trackingKF` or `trackingABF` object, then you cannot specify `measparams`.

Output Arguments

measlikelihood — Likelihood of measurement

scalar

Likelihood of measurement, returned as a scalar.

Version History

Introduced in R2018a

Extended Capabilities

C/C++ Code Generation

Generate C and C++ code using MATLAB® Coder™.

See Also

`clone` | `correct` | `correctjpda` | `distance` | `initialize` | `predict` | `residual`

predict

Predict state and state estimation error covariance of tracking filter

Syntax

```
[xpred,Ppred] = predict(filter)
[xpred,Ppred] = predict(filter,dt)
[xpred,Ppred] = predict(filter,predparams)

[xpred,Ppred,zpred] = predict(filter)
[xpred,Ppred,zpred] = predict(filter,dt)

predict(filter,___)
xpred = predict(filter,___)
```

Description

`[xpred,Ppred] = predict(filter)` returns the predicted state, `xpred`, and the predicted state estimation error covariance, `Ppred`, for the next time step of the input tracking filter. The predicted values overwrite the internal state and state estimation error covariance of `filter`.

`[xpred,Ppred] = predict(filter,dt)` specifies the time step as a positive scalar in seconds, and returns one or more of the outputs from the preceding syntaxes.

`[xpred,Ppred] = predict(filter,predparams)` specifies additional prediction parameters used by the state transition function. The state transition function is defined in the `StateTransitionFcn` property of `filter`.

`[xpred,Ppred,zpred] = predict(filter)` also returns the predicted measurement at the next time step.

You can use this syntax only when `filter` is a `trackingABF` object.

`[xpred,Ppred,zpred] = predict(filter,dt)` returns the predicted state, state estimation error covariance, and measurement at the specified time step.

You can use this syntax only when `filter` is a `trackingABF` object.

`predict(filter,___)` updates `filter` with the predicted state and state estimation error covariance without returning the predicted values. Specify the tracking filter and any of the input argument combinations from preceding syntaxes.

`xpred = predict(filter,___)` updates `filter` with the predicted state and state estimation error covariance but returns only the predicted state, `xpred`.

Examples

Constant-Velocity Extended Kalman Filter

Create a two-dimensional `trackingEKF` object and use name-value pairs to define the `StateTransitionJacobianFcn` and `MeasurementJacobianFcn` properties. Use the predefined constant-velocity motion and measurement models and their Jacobians.

```
EKF = trackingEKF(@constvel,@cvmeas,[0;0;0;0], ...
    'StateTransitionJacobianFcn',@constveljac, ...
    'MeasurementJacobianFcn',@cvmeasjac);
```

Run the filter. Use the `predict` and `correct` functions to propagate the state. You may call `predict` and `correct` in any order and as many times you want. Specify the measurement in Cartesian coordinates.

```
measurement = [1;1;0];
[xpred, Ppred] = predict(EKF);
[xcorr, Pcorr] = correct(EKF,measurement);
[xpred, Ppred] = predict(EKF);
[xpred, Ppred] = predict(EKF)
```

xpred = 4×1

```
1.2500
0.2500
1.2500
0.2500
```

Ppred = 4×4

```
11.7500    4.7500         0         0
 4.7500    3.7500         0         0
         0         0    11.7500    4.7500
         0         0     4.7500    3.7500
```

Input Arguments

filter — Filter for object tracking

`trackingEKF` object | `trackingUKF` object

Filter for object tracking, specified as one of these objects:

- `trackingEKF` — Extended Kalman filter
- `trackingUKF` — Unscented Kalman filter
- `trackingABF` — Alpha-beta filter

To use the `predict` function with a `trackingKF` linear Kalman filter, see `predict` (`trackingKF`).

dt — Time step

positive scalar

Time step for next prediction, specified as a positive scalar in seconds.

predparams — Prediction parameters

comma-separated list of arguments

Prediction parameters used by the state transition function, specified as a comma-separated list of arguments. These arguments are the same arguments that are passed into the state transition function specified by the `StateTransitionFcn` property of the input `filter`.

Suppose you set the `StateTransitionFcn` property to `@constacc` and then call the `predict` function:

```
[xpred,Ppred] = predict(filter,dt)
```

The `predict` function internally calls the following:

```
state = constacc(state,dt)
```

Output Arguments

xpred — Predicted state of filter

vector | matrix

Predicted state of the filter, specified as a vector or matrix. The `State` property of the input `filter` is overwritten with this value.

Ppred — Predicted state covariance of filter

vector | matrix

Predicted state covariance of the filter, specified as a vector or matrix. The `StateCovariance` property of the input `filter` is overwritten with this value.

zpred — Predicted measurement

vector | matrix

Predicted measurement, specified as a vector or matrix. You can return `zpred` only when `filter` is a `trackingABF` object.

Version History

Introduced in R2017a

Extended Capabilities

C/C++ Code Generation

Generate C and C++ code using MATLAB® Coder™.

See Also

`clone` | `correct` | `correctjpd` | `distance` | `initialize` | `likelihood` | `residual`

predict

Predict state and state estimation error covariance of linear Kalman filter

Syntax

```
[xpred,Ppred] = predict(filter)
[xpred,Ppred] = predict(filter,dt)

[xpred,Ppred] = predict(filter)
[xpred,Ppred] = predict(filter,A)
[xpred,Ppred] = predict(filter,A,Q)

[xpred,Ppred] = predict(filter,u)
[xpred,Ppred] = predict(filter,u,A,B)
[xpred,Ppred] = predict(filter,u,A,B,Q)
```

Description

Syntaxes for Predefined Motion Model

Use these syntaxes if you specify a predefined motion model in the `MotionModel` property of the `trackingKF` object.

`[xpred,Ppred] = predict(filter)` returns the predicted state `xpred` and the predicted state estimation error covariance `Ppred` after one second using the motion model specified in the `filter`. The predicted values overwrite the internal state and state estimation error covariance of the `filter`.

`[xpred,Ppred] = predict(filter,dt)` predicts the state and state estimation error covariance at the specified time step `dt`.

Syntaxes for Custom Motion Model Without Control Input

Use these syntaxes if you specify the `MotionModel` property as "Custom" and do not use control inputs.

`[xpred,Ppred] = predict(filter)` returns the predicted state `xpred` and the predicted state estimation error covariance `Ppred` using the state transition matrix specified in the `StateTransitionModel` property of the `filter`. The predicted values overwrite the internal state and state estimation error covariance of the `filter`.

`[xpred,Ppred] = predict(filter,A)` specifies the state transition model `A`. Use this syntax when the state transition model is time-varying.

`[xpred,Ppred] = predict(filter,A,Q)` specifies the state transition model `A` and the process noise covariance `Q`. Use this syntax when the state transition model and the process noise are time-varying.

Syntaxes for Custom Motion Model with Control Input

Use these syntaxes if you specify the `MotionModel` property as "Custom" and use control inputs.

`[xpred,Ppred] = predict(filter,u)` returns the predicted state `xpred` and the predicted state estimation error covariance `Ppred` using the state transition model specified in the `StateTransitionModel` property of the `filter` and a control input `u`.

`[xpred,Ppred] = predict(filter,u,A,B)` specifies the force or control input `u`, the state transition model `A`, and the control model `B`. Use this syntax when the state transition model and control model are time-varying.

`[xpred,Ppred] = predict(filter,u,A,B,Q)` specifies the force or control input `u`, the state transition model `A`, the control model `B`, and the process noise covariance `Q`. Use this syntax when the state transition model, control model, and process noise are time-varying.

Examples

Create Constant-Velocity Linear Kalman Filter

Create a linear Kalman filter that uses a 2D constant velocity motion model. Assume that the measurement consists of the `xy`-location of the object.

Specify the initial state estimate to have zero velocity.

```
x = 5.3;
y = 3.6;
initialState = [x;0;y;0];
KF = trackingKF('MotionModel','2D Constant Velocity','State',initialState);
```

Create measured positions for the object on a constant-velocity trajectory.

```
vx = 0.2;
vy = 0.1;
T = 0.5;
pos = [0:vx*T:2;
       5:vy*T:6]';
```

Predict and correct the state of the object.

```
for k = 1:size(pos,1)
    pstates(k,:) = predict(KF,T);
    cstates(k,:) = correct(KF,pos(k,:));
end
```

Plot the tracks.

```
plot(pos(:,1),pos(:,2),"k.",pstates(:,1),pstates(:,3),"+", ...
      cstates(:,1),cstates(:,3),"o")
xlabel("x [m]")
ylabel("y [m]")
grid
xt = [x-2, pos(1,1)+0.1, pos(end,1)+0.1];
yt = [y, pos(1,2), pos(end,2)];
text(xt,yt,["First measurement","First position","Last position"])
legend("Object position","Predicted position","Corrected position")
```

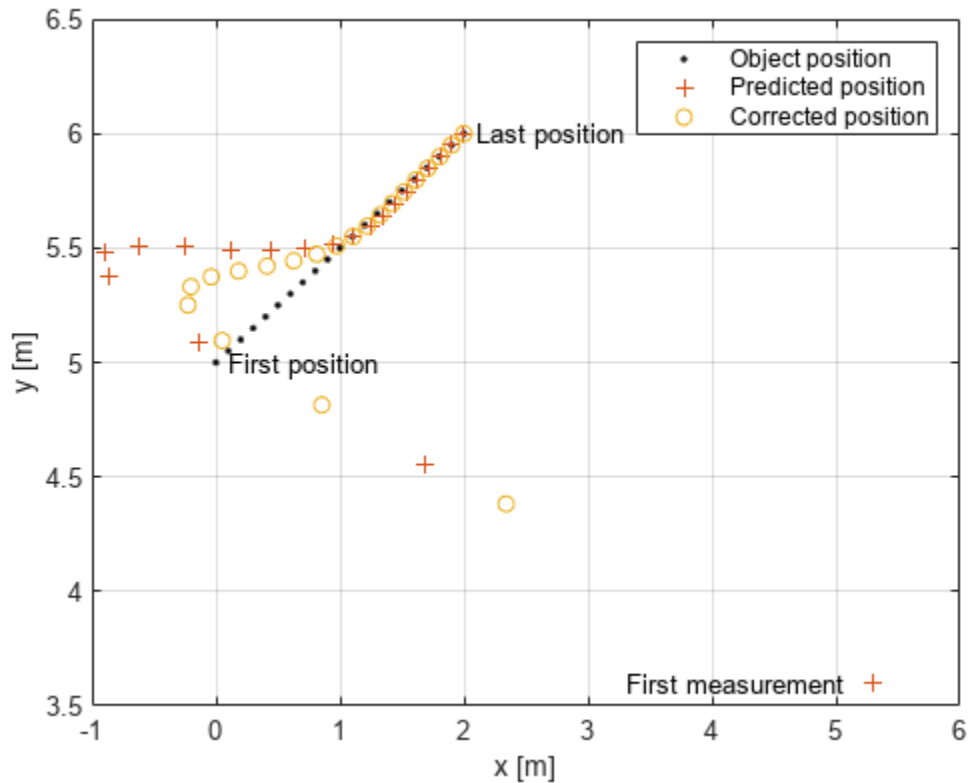

Use Custom trackingKF with Control Inputs

Specify a simulation time of 10 seconds with a time step of 1 second.

```
rng(2021) % For repeatable results
simulationTime = 20;
dt = 1;
tspan = 0:dt:simulationTime;
steps = length(tspan);
```

Specify the motion model as a 2-D constant velocity model with a state of $[x; vx; y; vy]$. The measurement is $[x; y]$.

```
A1D = [1 dt; 0 1];
A = kron(eye(2),A1D) % State transition model
```

```
A = 4x4
```

1	1	0	0
0	1	0	0
0	0	1	1
0	0	0	1

```
H1D = [1 0];
H = kron(eye(2),H1D) % Measurement model
```

H = 2×4

```

    1    0    0    0
    0    0    1    0

```

```

sigma = 0.2;
R = sigma^2*eye(2); % Measurement noise covariance

```

Specify a control model matrix.

```

B1D = [0; 1];
B = kron(eye(2),B1D) % Control model matrix

```

B = 4×2

```

    0    0
    1    0
    0    0
    0    1

```

Assume the control inputs are sinusoidal on the velocity components, vx and vy.

```

gain = 5;
Ux = gain*sin(tspan(2:end));
Uy = gain*cos(tspan(2:end));
U =[Ux; Uy]; % Control inputs

```

Assuming the true initial state is [1 1 1 -1], simulate the system to obtain true states and measurements.

```

initialState = [1 1 1 -1]'; % [m m/s m m/s]
trueStates = NaN(4,steps);
trueStates(:,1) = initialState;

for i=2:steps
    trueStates(:,i) = A*trueStates(:,i-1) + B*U(:,i-1);
end

measurements = H*trueStates + chol(R)*randn(2,steps);

```

Visualize the true trajectory and the measurements.

```

figure
plot(trueStates(1,:),trueStates(3,:),"DisplayName","Truth")
hold on
plot(measurements(1,:),measurements(2,:), "x", "DisplayName", "Measurements")
xlabel("x (m)")
ylabel("y (m)")
legend

```

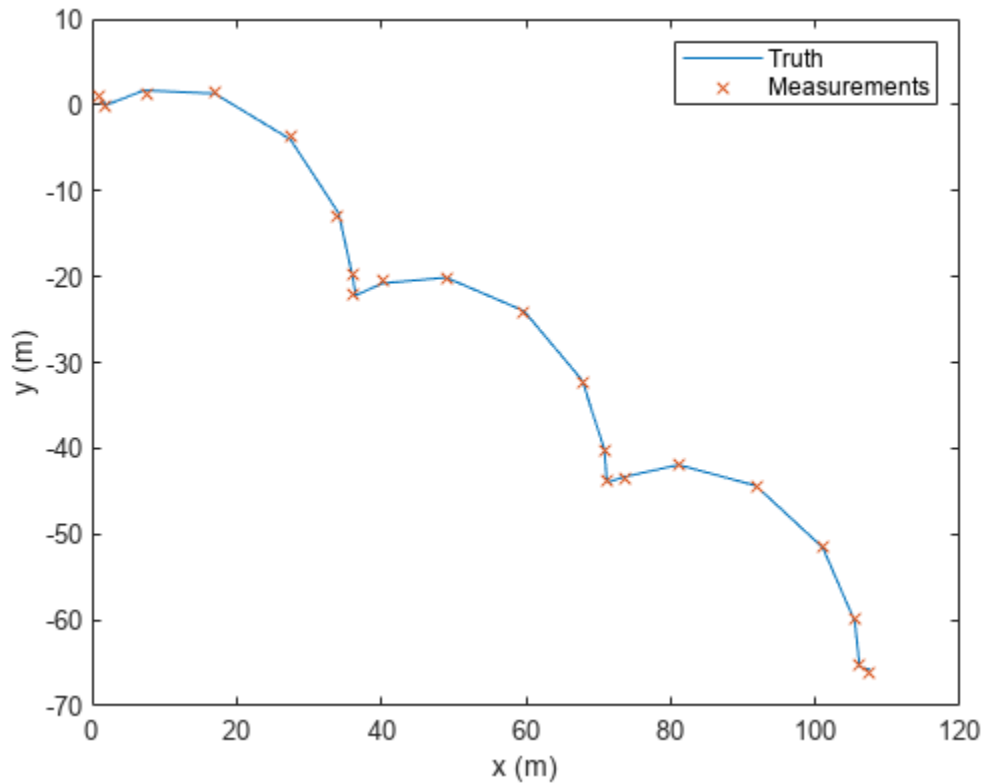

Create a `trackingKF` filter with a custom motion model. Enable the control input by specifying the control model. Specify the initial state in the filter based on the first measurement.

```
initialFilterState = [measurements(1,1); 0; measurements(2,1); 0];
filter = trackingKF("MotionModel","Custom", ...
    "StateTransitionModel",A, ...
    "MeasurementModel",H, ...
    "ControlModel",B, ...
    "State",initialFilterState);
```

Estimate states by using the `predict` and `correct` object functions.

```
estimateStates = NaN(4,steps);
estimateStates(:,1) = initialFilterState;
for i = 2:steps
    predict(filter,U(:,i-1));
    estimateStates(:,i) = correct(filter,measurements(:,i));
end
```

Visualize the state estimates.

```
plot(estimateStates(1,:),estimateStates(3,:), "g", "DisplayName", "Estimates");
```

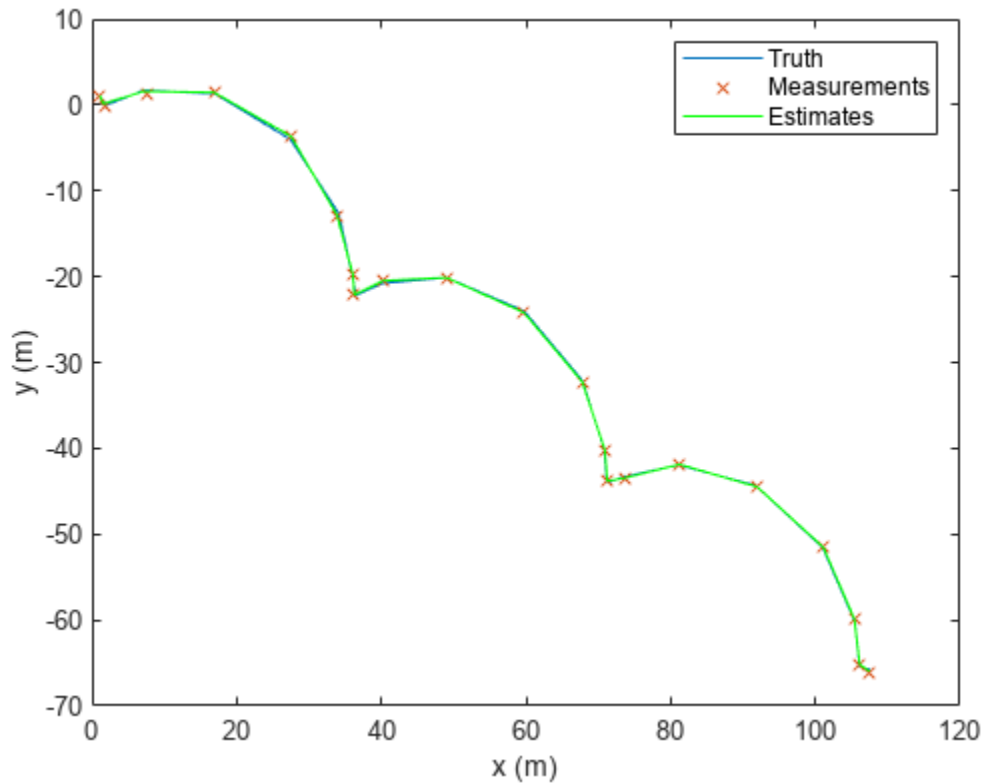

Input Arguments

filter — Linear Kalman filter for object tracking

trackingKF object

Linear Kalman filter for object tracking, specified as a trackingKF object.

dt — Time step

positive scalar

Time step, specified as a positive scalar. Units are in seconds.

A — State transition model

real-valued M -by- M matrix

State transition model, specified as a real-valued M -by- M matrix, where M is the size of the state vector.

Q — Covariance of process noise

nonnegative scalar | positive-semidefinite D -by- D matrix | positive-semidefinite M -by- M matrix

Covariance of process noise, specified as a nonnegative scalar, a positive-semidefinite D -by- D matrix, or a positive-semidefinite M -by- M matrix.

- When the `MotionModel` property of the `filter` is specified as one of the predefined motion models, specify `Q` as a positive-semidefinite D -by- D matrix, where D is the number of dimensions of the target motion. For example, $D = 2$ for the "2D Constant Velocity" or the "2D Constant Acceleration" motion model.

In this case, if you specify `Q` as a nonnegative scalar, then the scalar extends to the diagonal elements of a diagonal covariance matrix, whose size is D -by- D .

- When the `MotionModel` property of the `filter` is specified as "Custom", specify `Q` as a positive-semidefinite M -by- M matrix, where M is the size of the filter state. For example, $M = 6$ if you customize a 3-D motion model in which the state is (x, v_x, y, v_y, z, v_z) .

In this case, if you specify `Q` as a nonnegative scalar, then the scalar extends to the diagonal elements of a diagonal covariance matrix, whose size is M -by- M .

u — Control vector

real-valued L -element vector

Control vector, specified as a real-valued L -element vector.

B — Control model

real-valued M -by- L matrix

Control model, specified as a real-valued M -by- L matrix. M is the size of the state vector. L is the number of independent controls.

Output Arguments

xpred — Predicted state

real-valued M -element vector

Predicted state, returned as a real-valued M -element vector. The predicted state represents the deducible estimate of the state vector, propagated from the previous state using the state transition and control models.

Ppred — Predicted state error covariance matrix

real-valued M -by- M matrix

Predicted state covariance matrix, returned as a real-valued M -by- M matrix. M is the size of the state vector. The predicted state covariance matrix represents the deducible estimate of the covariance matrix vector. The filter propagates the covariance matrix from the previous estimate.

Version History

Introduced in R2017a

Extended Capabilities

C/C++ Code Generation

Generate C and C++ code using MATLAB® Coder™.

See Also

[clone](#) | [correct](#) | [correctjpda](#) | [distance](#) | [initialize](#) | [likelihood](#) | [residual](#)

residual

Measurement residual and residual noise from tracking filter

Syntax

```
[zres, rescov] = residual(filter, zmeas)
[zres, rescov] = residual(filter, zmeas, measparams)
```

Description

`[zres, rescov] = residual(filter, zmeas)` computes the residual and residual covariance of the current given measurement, `zmeas`, with the predicted measurement in the tracking filter, `filter`. This function applies to filters that assume a Gaussian distribution for noise.

`[zres, rescov] = residual(filter, zmeas, measparams)` specifies additional parameters that are used by the `MeasurementFcn` of the filter.

If `filter` is a `trackingKF` object, then you cannot use this syntax.

Input Arguments

filter — Filter for object tracking

`trackingKF` object | `trackingEKF` object | `trackingUKF` object

Filter for object tracking, specified as one of these objects:

- `trackingKF` — Linear Kalman filter
- `trackingEKF` — Extended Kalman filter
- `trackingUKF` — Unscented Kalman filter

zmeas — Current measurement of tracked object

vector | matrix

Current measurement of a tracked object, specified as a vector or matrix.

measparams — Parameters for measurement function

cell array

Parameters for measurement function, specified as a cell array. The parameters are passed to the measurement function that is defined in the `MeasurementFcn` property of the input `filter`. If `filter` is a `trackingKF` object, then you cannot specify `measparams`.

Output Arguments

zres — Residual between current and predicted measurement

matrix

Residual between current and predicted measurement, returned as a matrix.

rescov — Residual covariance matrix

Residual covariance, returned as a matrix.

Algorithms

The residual is the difference between a measurement and the value predicted by the filter. For Kalman filters, the residual calculation depends on whether the filter is linear or nonlinear.

Linear Kalman Filters

Given a linear Kalman filter with a current measurement of z , the residual z_{res} is defined as

$$z_{\text{res}} = z - Hx,$$

where:

- H is the measurement model set by the `MeasurementModel` property of the filter.
- x is the current filter state.

The covariance of the residual, S , is defined as

$$S = R + HPH^T,$$

where:

- P is the state covariance matrix.
- R is the measurement noise matrix set by the `MeasurementNoise` property of the filter.

Nonlinear Kalman Filters

Given a nonlinear Kalman filter with a current measurement of z , the residual z_{res} is defined as:

$$z_{\text{res}} = z - h(x),$$

where:

- h is the measurement function set by the `MeasurementFcn` property.
- x is the current filter state.

The covariance of the residual, S , is defined as:

$$S = R + R_p,$$

where:

- R is the measurement noise matrix set by the `MeasurementNoise` property of the filter.
- R_p is the state covariance matrix projected onto the measurement space.

Version History

Introduced in R2018a

Extended Capabilities

C/C++ Code Generation

Generate C and C++ code using MATLAB® Coder™.

See Also

`clone` | `correct` | `correctjpda` | `distance` | `initialize` | `likelihood` | `predict`

quaternion

Create a quaternion array

Description

A quaternion is a four-part hyper-complex number used in three-dimensional rotations and orientations.

A quaternion number is represented in the form $a + bi + cj + dk$, where a , b , c , and d parts are real numbers, and i , j , and k are the basis elements, satisfying the equation: $i^2 = j^2 = k^2 = ijk = -1$.

The set of quaternions, denoted by \mathbf{H} , is defined within a four-dimensional vector space over the real numbers, \mathbf{R}^4 . Every element of \mathbf{H} has a unique representation based on a linear combination of the basis elements, i , j , and k .

All rotations in 3-D can be described by an axis of rotation and angle about that axis. An advantage of quaternions over rotation matrices is that the axis and angle of rotation is easy to interpret. For example, consider a point in \mathbf{R}^3 . To rotate the point, you define an axis of rotation and an angle of rotation.

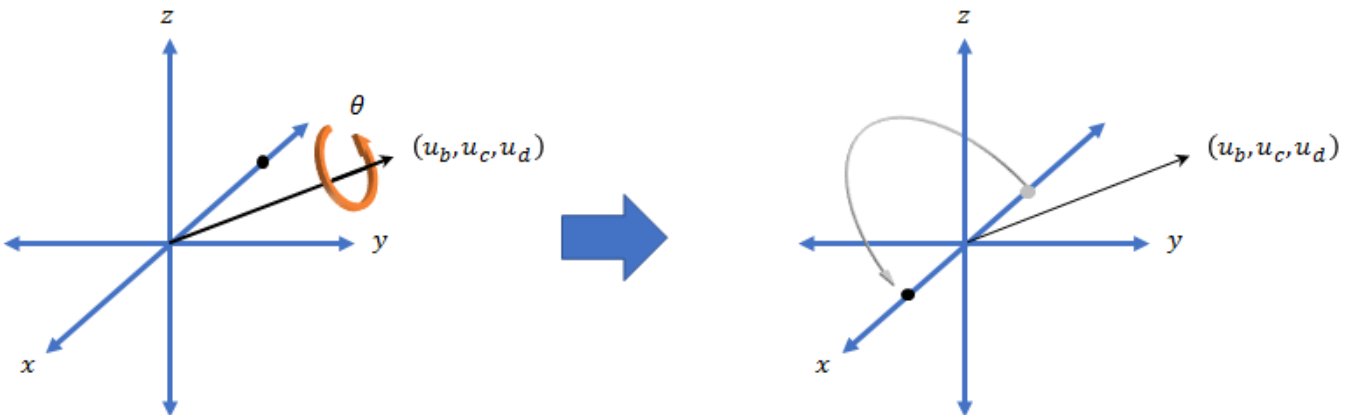

The quaternion representation of the rotation may be expressed as $q = \cos(\theta/2) + \sin(\theta/2)(u_b i + u_c j + u_d k)$, where θ is the angle of rotation and $[u_b, u_c, \text{ and } u_d]$ is the axis of rotation.

Creation

Syntax

```
quat = quaternion()
quat = quaternion(A,B,C,D)
quat = quaternion(matrix)
quat = quaternion(RV, 'rotvec')
```

```
quat = quaternion(RV, 'rotvecd')
quat = quaternion(RM, 'rotmat', PF)
quat = quaternion(E, 'euler', RS, PF)
quat = quaternion(E, 'eulerd', RS, PF)
```

Description

`quat = quaternion()` creates an empty quaternion.

`quat = quaternion(A,B,C,D)` creates a quaternion array where the four quaternion parts are taken from the arrays A, B, C, and D. All the inputs must have the same size and be of the same data type.

`quat = quaternion(matrix)` creates an N -by-1 quaternion array from an N -by-4 matrix, where each column becomes one part of the quaternion.

`quat = quaternion(RV, 'rotvec')` creates an N -by-1 quaternion array from an N -by-3 matrix of rotation vectors, RV. Each row of RV represents a rotation vector in radians.

`quat = quaternion(RV, 'rotvecd')` creates an N -by-1 quaternion array from an N -by-3 matrix of rotation vectors, RV. Each row of RV represents a rotation vector in degrees.

`quat = quaternion(RM, 'rotmat', PF)` creates an N -by-1 quaternion array from the 3-by-3-by- N array of rotation matrices, RM. PF can be either 'point' if the Euler angles represent point rotations or 'frame' for frame rotations.

`quat = quaternion(E, 'euler', RS, PF)` creates an N -by-1 quaternion array from the N -by-3 matrix, E. Each row of E represents a set of Euler angles in radians. The angles in E are rotations about the axes in sequence RS.

`quat = quaternion(E, 'eulerd', RS, PF)` creates an N -by-1 quaternion array from the N -by-3 matrix, E. Each row of E represents a set of Euler angles in degrees. The angles in E are rotations about the axes in sequence RS.

Input Arguments

A, B, C, D — Quaternion parts

comma-separated arrays of the same size

Parts of a quaternion, specified as four comma-separated scalars, matrices, or multi-dimensional arrays of the same size.

Example: `quat = quaternion(1,2,3,4)` creates a quaternion of the form $1 + 2i + 3j + 4k$.

Example: `quat = quaternion([1,5],[2,6],[3,7],[4,8])` creates a 1-by-2 quaternion array where `quat(1,1) = 1 + 2i + 3j + 4k` and `quat(1,2) = 5 + 6i + 7j + 8k`

Data Types: `single` | `double`

matrix — Matrix of quaternion parts

N -by-4 matrix

Matrix of quaternion parts, specified as an N -by-4 matrix. Each row represents a separate quaternion. Each column represents a separate quaternion part.

Example: `quat = quaternion(rand(10,4))` creates a 10-by-1 quaternion array.

Data Types: `single` | `double`

RV — Matrix of rotation vectors

N-by-3 matrix

Matrix of rotation vectors, specified as an *N*-by-3 matrix. Each row of **RV** represents the [X Y Z] elements of a rotation vector. A rotation vector is a unit vector representing the axis of rotation scaled by the angle of rotation in radians or degrees.

To use this syntax, specify the first argument as a matrix of rotation vectors and the second argument as the `'rotvec'` or `'rotvecd'`.

Example: `quat = quaternion(rand(10,3), 'rotvec')` creates a 10-by-1 quaternion array.

Data Types: `single` | `double`

RM — Rotation matrices

3-by-3 matrix | 3-by-3-by-*N* array

Array of rotation matrices, specified by a 3-by-3 matrix or 3-by-3-by-*N* array. Each page of the array represents a separate rotation matrix.

Example: `quat = quaternion(rand(3), 'rotmat', 'point')`

Example: `quat = quaternion(rand(3), 'rotmat', 'frame')`

Data Types: `single` | `double`

PF — Type of rotation matrix

`'point'` | `'frame'`

Type of rotation matrix, specified by `'point'` or `'frame'`.

Example: `quat = quaternion(rand(3), 'rotmat', 'point')`

Example: `quat = quaternion(rand(3), 'rotmat', 'frame')`

Data Types: `char` | `string`

E — Matrix of Euler angles

N-by-3 matrix

Matrix of Euler angles, specified by an *N*-by-3 matrix. If using the `'euler'` syntax, specify *E* in radians. If using the `'eulerd'` syntax, specify *E* in degrees.

Example: `quat = quaternion(E, 'euler', 'YZY', 'point')`

Example: `quat = quaternion(E, 'euler', 'XYZ', 'frame')`

Data Types: `single` | `double`

RS — Rotation sequence

character vector | scalar string

Rotation sequence, specified as a three-element character vector:

- `'YZY'`
- `'YXY'`
- `'ZYZ'`

- 'ZXZ'
- 'YXY'
- 'XZX'
- 'XYZ'
- 'YZX'
- 'ZXY'
- 'XZY'
- 'ZYX'
- 'YXZ'

Assume you want to determine the new coordinates of a point when its coordinate system is rotated using frame rotation. The point is defined in the original coordinate system as:

```
point = [sqrt(2)/2,sqrt(2)/2,0];
```

In this representation, the first column represents the x-axis, the second column represents the y-axis, and the third column represents the z-axis.

You want to rotate the point using the Euler angle representation [45,45,0]. Rotate the point using two different rotation sequences:

- If you create a quaternion rotator and specify the 'ZYX' sequence, the frame is first rotated 45° around the z-axis, then 45° around the new y-axis.

```
quatRotator = quaternion([45,45,0], 'eulerd', 'ZYX', 'frame');
newPointCoordinate = rotateframe(quatRotator,point)
```

```
newPointCoordinate =
    0.7071    -0.0000    0.7071
```

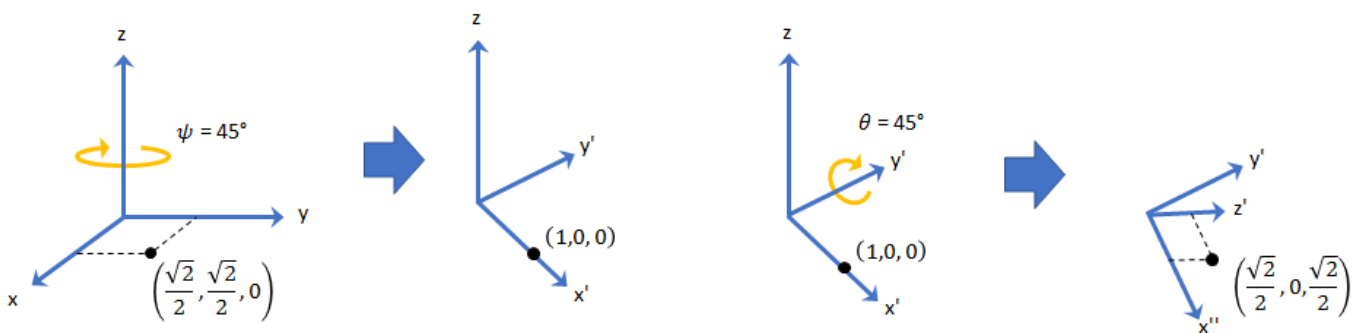

- If you create a quaternion rotator and specify the 'YZX' sequence, the frame is first rotated 45° around the y-axis, then 45° around the new z-axis.

```
quatRotator = quaternion([45,45,0], 'eulerd', 'YZX', 'frame');
newPointCoordinate = rotateframe(quatRotator,point)
```

```
newPointCoordinate =
    0.8536    0.1464    0.5000
```

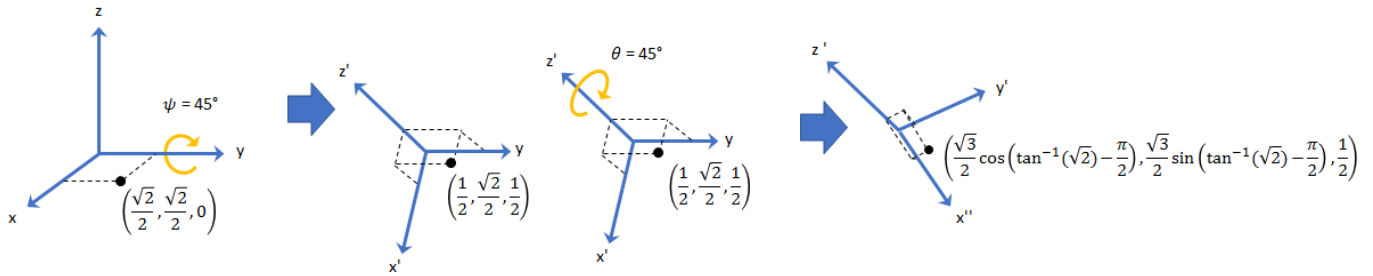
Data Types: char | string

Object Functions

angvel	Angular velocity from quaternion array
classUnderlying	Class of parts within quaternion
compact	Convert quaternion array to N-by-4 matrix
conj	Complex conjugate of quaternion
'	Complex conjugate transpose of quaternion array
dist	Angular distance in radians
euler	Convert quaternion to Euler angles (radians)
eulerd	Convert quaternion to Euler angles (degrees)
exp	Exponential of quaternion array
.\,ldivide	Element-wise quaternion left division
log	Natural logarithm of quaternion array
meanrot	Quaternion mean rotation
-	Quaternion subtraction
*	Quaternion multiplication
norm	Quaternion norm
normalize	Quaternion normalization
ones	Create quaternion array with real parts set to one and imaginary parts set to zero
parts	Extract quaternion parts
.^,power	Element-wise quaternion power
prod	Product of a quaternion array
randrot	Uniformly distributed random rotations
./,rdivide	Element-wise quaternion right division
rotateframe	Quaternion frame rotation
rotatepoint	Quaternion point rotation
rotmat	Convert quaternion to rotation matrix
rotvec	Convert quaternion to rotation vector (radians)
rotvecd	Convert quaternion to rotation vector (degrees)
slerp	Spherical linear interpolation
.*,times	Element-wise quaternion multiplication
'	Transpose a quaternion array
-	Quaternion unary minus
zeros	Create quaternion array with all parts set to zero

Examples

Create Empty Quaternion

```
quat = quaternion()
```

```
quat =  
    0x0 empty quaternion array
```

By default, the underlying class of the quaternion is a double.

```
classUnderlying(quat)
```

```
ans =  
'double'
```

Create Quaternion by Specifying Individual Quaternion Parts

You can create a quaternion array by specifying the four parts as comma-separated scalars, matrices, or multidimensional arrays of the same size.

Define quaternion parts as scalars.

```
A = 1.1;  
B = 2.1;  
C = 3.1;  
D = 4.1;  
quatScalar = quaternion(A,B,C,D)  
  
quatScalar = quaternion  
    1.1 + 2.1i + 3.1j + 4.1k
```

Define quaternion parts as column vectors.

```
A = [1.1;1.2];  
B = [2.1;2.2];  
C = [3.1;3.2];  
D = [4.1;4.2];  
quatVector = quaternion(A,B,C,D)  
  
quatVector = 2x1 quaternion array  
    1.1 + 2.1i + 3.1j + 4.1k  
    1.2 + 2.2i + 3.2j + 4.2k
```

Define quaternion parts as matrices.

```
A = [1.1,1.3; ...  
    1.2,1.4];  
B = [2.1,2.3; ...  
    2.2,2.4];  
C = [3.1,3.3; ...  
    3.2,3.4];  
D = [4.1,4.3; ...  
    4.2,4.4];  
quatMatrix = quaternion(A,B,C,D)  
  
quatMatrix = 2x2 quaternion array  
    1.1 + 2.1i + 3.1j + 4.1k    1.3 + 2.3i + 3.3j + 4.3k  
    1.2 + 2.2i + 3.2j + 4.2k    1.4 + 2.4i + 3.4j + 4.4k
```

Define quaternion parts as three dimensional arrays.

```

A = randn(2,2,2);
B = zeros(2,2,2);
C = zeros(2,2,2);
D = zeros(2,2,2);
quatMultiDimArray = quaternion(A,B,C,D)

quatMultiDimArray = 2x2x2 quaternion array
quatMultiDimArray(:,:,1) =

    0.53767 +      0i +      0j +      0k   -2.2588 +      0i +      0j +      0k
    1.8339 +      0i +      0j +      0k   0.86217 +      0i +      0j +      0k

quatMultiDimArray(:,:,2) =

    0.31877 +      0i +      0j +      0k   -0.43359 +      0i +      0j +      0k
   -1.3077 +      0i +      0j +      0k   0.34262 +      0i +      0j +      0k

```

Create Quaternion by Specifying Quaternion Parts Matrix

You can create a scalar or column vector of quaternions by specify an N -by-4 matrix of quaternion parts, where columns correspond to the quaternion parts A, B, C, and D.

Create a column vector of random quaternions.

```

quatParts = rand(3,4)

quatParts = 3x4

    0.8147    0.9134    0.2785    0.9649
    0.9058    0.6324    0.5469    0.1576
    0.1270    0.0975    0.9575    0.9706

quat = quaternion(quatParts)

quat = 3x1 quaternion array
    0.81472 + 0.91338i + 0.2785j + 0.96489k
    0.90579 + 0.63236i + 0.54688j + 0.15761k
    0.12699 + 0.09754i + 0.95751j + 0.97059k

```

To retrieve the `quatParts` matrix from quaternion representation, use `compact`.

```

retrievedquatParts = compact(quat)

retrievedquatParts = 3x4

    0.8147    0.9134    0.2785    0.9649
    0.9058    0.6324    0.5469    0.1576
    0.1270    0.0975    0.9575    0.9706

```

Create Quaternion by Specifying Rotation Vectors

You can create an N -by-1 quaternion array by specifying an N -by-3 matrix of rotation vectors in radians or degrees. Rotation vectors are compact spatial representations that have a one-to-one relationship with normalized quaternions.

Rotation Vectors in Radians

Create a scalar quaternion using a rotation vector and verify the resulting quaternion is normalized.

```
rotationVector = [0.3491,0.6283,0.3491];  
quat = quaternion(rotationVector,'rotvec')  
  
quat = quaternion  
      0.92124 + 0.16994i + 0.30586j + 0.16994k  
  
norm(quat)  
  
ans = 1.0000
```

You can convert from quaternions to rotation vectors in radians using the `rotvec` function. Recover the `rotationVector` from the quaternion, `quat`.

```
rotvec(quat)  
  
ans = 1×3  
      0.3491    0.6283    0.3491
```

Rotation Vectors in Degrees

Create a scalar quaternion using a rotation vector and verify the resulting quaternion is normalized.

```
rotationVector = [20,36,20];  
quat = quaternion(rotationVector,'rotvecd')  
  
quat = quaternion  
      0.92125 + 0.16993i + 0.30587j + 0.16993k  
  
norm(quat)  
  
ans = 1
```

You can convert from quaternions to rotation vectors in degrees using the `rotvecd` function. Recover the `rotationVector` from the quaternion, `quat`.

```
rotvecd(quat)  
  
ans = 1×3  
      20.0000    36.0000    20.0000
```

Create Quaternion by Specifying Rotation Matrices

You can create an N -by-1 quaternion array by specifying a 3-by-3-by- N array of rotation matrices. Each page of the rotation matrix array corresponds to one element of the quaternion array.

Create a scalar quaternion using a 3-by-3 rotation matrix. Specify whether the rotation matrix should be interpreted as a frame or point rotation.

```
rotationMatrix = [1 0      0; ...
                  0 sqrt(3)/2 0.5; ...
                  0 -0.5    sqrt(3)/2];
quat = quaternion(rotationMatrix, 'rotmat', 'frame')

quat = quaternion
    0.96593 + 0.25882i +      0j +      0k
```

You can convert from quaternions to rotation matrices using the `rotmat` function. Recover the `rotationMatrix` from the quaternion, `quat`.

```
rotmat(quat, 'frame')

ans = 3×3

    1.0000      0      0
         0    0.8660    0.5000
         0   -0.5000    0.8660
```

Create Quaternion by Specifying Euler Angles

You can create an N -by-1 quaternion array by specifying an N -by-3 array of Euler angles in radians or degrees.

Euler Angles in Radians

Use the `euler` syntax to create a scalar quaternion using a 1-by-3 vector of Euler angles in radians. Specify the rotation sequence of the Euler angles and whether the angles represent a frame or point rotation.

```
E = [pi/2,0,pi/4];
quat = quaternion(E, 'euler', 'ZYX', 'frame')

quat = quaternion
    0.65328 + 0.2706i + 0.2706j + 0.65328k
```

You can convert from quaternions to Euler angles using the `euler` function. Recover the Euler angles, `E`, from the quaternion, `quat`.

```
euler(quat, 'ZYX', 'frame')

ans = 1×3

    1.5708      0    0.7854
```

Euler Angles in Degrees

Use the `eulerd` syntax to create a scalar quaternion using a 1-by-3 vector of Euler angles in degrees. Specify the rotation sequence of the Euler angles and whether the angles represent a frame or point rotation.

```
E = [90,0,45];  
quat = quaternion(E, 'eulerd', 'ZYX', 'frame')  
  
quat = quaternion  
    0.65328 + 0.2706i + 0.2706j + 0.65328k
```

You can convert from quaternions to Euler angles in degrees using the `eulerd` function. Recover the Euler angles, `E`, from the quaternion, `quat`.

```
eulerd(quat, 'ZYX', 'frame')  
  
ans = 1×3  
    90.0000         0    45.0000
```

Quaternion Algebra

Quaternions form a noncommutative associative algebra over the real numbers. This example illustrates the rules of quaternion algebra.

Addition and Subtraction

Quaternion addition and subtraction occur part-by-part, and are commutative:

```
Q1 = quaternion(1,2,3,4)  
  
Q1 = quaternion  
    1 + 2i + 3j + 4k  
  
Q2 = quaternion(9,8,7,6)  
  
Q2 = quaternion  
    9 + 8i + 7j + 6k  
  
Q1plusQ2 = Q1 + Q2  
  
Q1plusQ2 = quaternion  
    10 + 10i + 10j + 10k  
  
Q2plusQ1 = Q2 + Q1  
  
Q2plusQ1 = quaternion  
    10 + 10i + 10j + 10k  
  
Q1minusQ2 = Q1 - Q2
```

```
Q1minusQ2 = quaternion
-8 - 6i - 4j - 2k
```

```
Q2minusQ1 = Q2 - Q1
```

```
Q2minusQ1 = quaternion
8 + 6i + 4j + 2k
```

You can also perform addition and subtraction of real numbers and quaternions. The first part of a quaternion is referred to as the *real* part, while the second, third, and fourth parts are referred to as the *vector*. Addition and subtraction with real numbers affect only the real part of the quaternion.

```
Q1plusRealNumber = Q1 + 5
```

```
Q1plusRealNumber = quaternion
6 + 2i + 3j + 4k
```

```
Q1minusRealNumber = Q1 - 5
```

```
Q1minusRealNumber = quaternion
-4 + 2i + 3j + 4k
```

Multiplication

Quaternion multiplication is determined by the products of the basis elements and the distributive law. Recall that multiplication of the basis elements, i , j , and k , are not commutative, and therefore quaternion multiplication is not commutative.

```
Q1timesQ2 = Q1 * Q2
```

```
Q1timesQ2 = quaternion
-52 + 16i + 54j + 32k
```

```
Q2timesQ1 = Q2 * Q1
```

```
Q2timesQ1 = quaternion
-52 + 36i + 14j + 52k
```

```
isequal(Q1timesQ2,Q2timesQ1)
```

```
ans = logical
0
```

You can also multiply a quaternion by a real number. If you multiply a quaternion by a real number, each part of the quaternion is multiplied by the real number individually:

```
Q1times5 = Q1*5
```

```
Q1times5 = quaternion
5 + 10i + 15j + 20k
```

Multiplying a quaternion by a real number is commutative.

```
isequal(Q1*5,5*Q1)
```

```
ans = logical  
     1
```

Conjugation

The complex conjugate of a quaternion is defined such that each element of the vector portion of the quaternion is negated.

Q1

```
Q1 = quaternion  
     1 + 2i + 3j + 4k
```

```
conj(Q1)
```

```
ans = quaternion  
     1 - 2i - 3j - 4k
```

Multiplication between a quaternion and its conjugate is commutative:

```
isequal(Q1*conj(Q1),conj(Q1)*Q1)
```

```
ans = logical  
     1
```

Quaternion Array Manipulation

You can organize quaternions into vectors, matrices, and multidimensional arrays. Built-in MATLAB® functions have been enhanced to work with quaternions.

Concatenate

Quaternions are treated as individual objects during concatenation and follow MATLAB rules for array manipulation.

```
Q1 = quaternion(1,2,3,4);  
Q2 = quaternion(9,8,7,6);
```

```
qVector = [Q1,Q2]
```

```
qVector = 1x2 quaternion array  
     1 + 2i + 3j + 4k     9 + 8i + 7j + 6k
```

```
Q3 = quaternion(-1,-2,-3,-4);  
Q4 = quaternion(-9,-8,-7,-6);
```

```
qMatrix = [qVector;Q3,Q4]
```

```
qMatrix = 2x2 quaternion array  
     1 + 2i + 3j + 4k     9 + 8i + 7j + 6k
```

$$\begin{matrix} -1 - 2i - 3j - 4k & -9 - 8i - 7j - 6k \end{matrix}$$

```
qMultiDimensionalArray(:,:,1) = qMatrix;
qMultiDimensionalArray(:,:,2) = qMatrix
```

```
qMultiDimensionalArray = 2x2x2 quaternion array
qMultiDimensionalArray(:,:,1) =
```

$$\begin{matrix} 1 + 2i + 3j + 4k & 9 + 8i + 7j + 6k \\ -1 - 2i - 3j - 4k & -9 - 8i - 7j - 6k \end{matrix}$$

```
qMultiDimensionalArray(:,:,2) =
```

$$\begin{matrix} 1 + 2i + 3j + 4k & 9 + 8i + 7j + 6k \\ -1 - 2i - 3j - 4k & -9 - 8i - 7j - 6k \end{matrix}$$

Indexing

To access or assign elements in a quaternion array, use indexing.

```
qLoc2 = qMultiDimensionalArray(2)
```

```
qLoc2 = quaternion
      -1 - 2i - 3j - 4k
```

Replace the quaternion at index two with a quaternion one.

```
qMultiDimensionalArray(2) = ones('quaternion')
```

```
qMultiDimensionalArray = 2x2x2 quaternion array
qMultiDimensionalArray(:,:,1) =
```

$$\begin{matrix} 1 + 2i + 3j + 4k & 9 + 8i + 7j + 6k \\ 1 + 0i + 0j + 0k & -9 - 8i - 7j - 6k \end{matrix}$$

```
qMultiDimensionalArray(:,:,2) =
```

$$\begin{matrix} 1 + 2i + 3j + 4k & 9 + 8i + 7j + 6k \\ -1 - 2i - 3j - 4k & -9 - 8i - 7j - 6k \end{matrix}$$

Reshape

To reshape quaternion arrays, use the reshape function.

```
qMatReshaped = reshape(qMatrix,4,1)
```

```
qMatReshaped = 4x1 quaternion array
      1 + 2i + 3j + 4k
      -1 - 2i - 3j - 4k
      9 + 8i + 7j + 6k
      -9 - 8i - 7j - 6k
```

Transpose

To transpose quaternion vectors and matrices, use the `transpose` function.

```
qMatTransposed = transpose(qMatrix)
```

```
qMatTransposed = 2x2 quaternion array
    1 + 2i + 3j + 4k   -1 - 2i - 3j - 4k
    9 + 8i + 7j + 6k   -9 - 8i - 7j - 6k
```

Permute

To permute quaternion vectors, matrices, and multidimensional arrays, use the `permute` function.

```
qMultiDimensionalArray
```

```
qMultiDimensionalArray = 2x2x2 quaternion array
qMultiDimensionalArray(:,:,1) =
```

```
    1 + 2i + 3j + 4k    9 + 8i + 7j + 6k
    1 + 0i + 0j + 0k   -9 - 8i - 7j - 6k
```

```
qMultiDimensionalArray(:,:,2) =
```

```
    1 + 2i + 3j + 4k    9 + 8i + 7j + 6k
   -1 - 2i - 3j - 4k   -9 - 8i - 7j - 6k
```

```
qMatPermute = permute(qMultiDimensionalArray,[3,1,2])
```

```
qMatPermute = 2x2x2 quaternion array
qMatPermute(:,:,1) =
```

```
    1 + 2i + 3j + 4k    1 + 0i + 0j + 0k
    1 + 2i + 3j + 4k   -1 - 2i - 3j - 4k
```

```
qMatPermute(:,:,2) =
```

```
    9 + 8i + 7j + 6k   -9 - 8i - 7j - 6k
    9 + 8i + 7j + 6k   -9 - 8i - 7j - 6k
```

Version History

Introduced in R2020a

Extended Capabilities

C/C++ Code Generation

Generate C and C++ code using MATLAB® Coder™.

See Also

Topics

“Rotations, Orientations, and Quaternions for Automated Driving”

objectTrack

Single object track report

Description

`objectTrack` captures the track information of a single object. `objectTrack` is the standard output format for trackers.

Creation

Syntax

```
track = objectTrack  
track = objectTrack(Name, Value)
```

Description

`track = objectTrack` creates an `objectTrack` object with default property values. An `objectTrack` object contains information like the age and state of a single track.

Tip To create an empty `objectTrack` object, use `objectTrack.empty()`.

`track = objectTrack(Name, Value)` allows you to set properties using one or more name-value pairs. Enclose each property name in single quotes.

Properties

TrackID — Unique track identifier

1 (default) | nonnegative integer

Unique track identifier, specified as a nonnegative integer. This property distinguishes different tracks.

Example: 2

BranchID — Unique track branch identifier

0 (default) | nonnegative integer

Unique track branch identifier, specified as a nonnegative integer. This property distinguishes different track branches.

Example: 1

SourceIndex — Index of source track reporting system

1 (default) | nonnegative integer

Index of source track reporting system, specified as a nonnegative integer. This property identifies the source that reports the track.

Example: 3

UpdateTime — Update time of track

0 (default) | nonnegative real scalar

Time at which the track was updated by a tracker, specified as a nonnegative real scalar.

Example: 1.2

Data Types: `single` | `double`

Age — Number of times track was updated

1 (default) | positive integer

Number of times the track was updated, specified as a positive integer. When a track is initialized, its **Age** is equal to 1. Any subsequent update with a hit or miss increases the track **Age** by 1.

Example: 2

State — Current state of track

`zeros(6,1)` (default) | real-valued N -element vector

The current state of the track at the **UpdateTime**, specified as a real-valued N -element vector, where N is the dimension of the state. The format of track state depends on the model used to track the object. For example, for 3-D constant velocity model used with `constvel`, the state vector is $[x; v_x; y; v_y; z; v_z]$.

Example: `[1 0.2 3 0.2]`

Data Types: `single` | `double`

StateCovariance — Current state uncertainty covariance of track

`eye(6,6)` (default) | real positive semidefinite symmetric N -by- N matrix

The current state uncertainty covariance of the track, specified as a real positive semidefinite symmetric N -by- N matrix, where N is the dimension of state specified in the **State** property.

Data Types: `single` | `double`

StateParameters — Parameters of the track state reference frame

`struct()` (default) | structure | structure array

Parameters of the track state reference frame, specified as a structure or a structure array. Use this property to define the track state reference frame and how to transform the track from the source coordinate system to the fuser coordinate system.

ObjectClassID — Object class identifier

0 (default) | nonnegative integer

Object class identifier, specified as a nonnegative integer. This property distinguishes between different user-defined object types. For example, you can use 1 for objects of type "car", and 2 for objects of type "pedestrian". 0 is reserved for unknown classification.

If you specify this property as a nonzero integer, you can use the **ObjectClassProbabilities** property to specify the classification probabilities.

Example: 3

ObjectClassProbabilities — Object classification probabilities

1 (default) | N -element vector of nonnegative scalars

Object classification probabilities of the track, specified as an N -element vector of nonnegative scalars. N is the total number of possible classes of the track. Each element must be a scalar in the range $[0\ 1]$, and the sum of all elements must be equal to 1. The i -th element of the vector corresponds to the probability that the track belongs to the class i .

Example: $[0.7\ 0.3]$

TrackLogic — Track confirmation and deletion logic type

'History' (default) | 'Integrated' | 'Score'

Confirmation and deletion logic type, specified as:

- 'History' - Track confirmation and deletion is based on the number of times the track has been assigned to a detection in the latest tracker updates.
- 'Score' - Track confirmation and deletion is based on a log-likelihood track score. A high score means that the track is more likely to be valid. A low score means that the track is more likely to be a false alarm.
- 'Integrated' - Track confirmation and deletion is based on the integrated probability of track existence.

TrackLogicState — State of track logic

1-by- M logical vector | 1-by-2 real-valued vector | nonnegative scalar

The current state of the track logic type. Based on the logic type specified in the `TrackLogic` property, the logic state is specified as:

- 'History' - A 1-by- M logical vector, where M is the number of latest track logical states recorded. `true` (1) values indicate hits, and `false` (0) values indicate misses. For example, $[1\ 0\ 1\ 1\ 1]$ represents four hits and one miss in the last five updates. The default value for logic state is 1.
- 'Score' - A 1-by-2 real-valued vector, $[cs, ms]$. cs is the current score, and ms is the maximum score. The default value is $[0, 0]$.
- 'Integrated' - A nonnegative scalar. The scalar represents the integrated probability of existence of the track. The default value is 0.5.

IsConfirmed — Indicate if track is confirmed

`true` (default) | `false`

Indicate if the track is confirmed, specified as `true` or `false`.

Data Types: `logical`

IsCoasted — Indicate if track is coasted

`false` (default) | `true`

Indicate if the track is coasted, specified as `true` or `false`. A track is coasted if its latest update is based on prediction instead of correction using detections.

Data Types: `logical`

IsSelfReported — Indicate if track is self reported

true (default) | false

Indicate if the track is self reported, specified as `true` or `false`. A track is self reported if it is reported from internal sources (senors, trackers, or fusers). To limit the propagation of rumors in a tracking system, use the value `false` if the track was updated by an external source.

Example: `false`Data Types: `logical`**ObjectAttributes — Object attributes**`struct()` (default) | structure

Object attributes passed by the tracker, specified as a structure.

Object Functions`toStruct` Convert `objectTrack` object to struct**Examples****Create Track Report using objectTrack**

Create a report of a track using `objectTrack`.

```
x = (1:6)';
P = diag(1:6);
track = objectTrack('State',x,'StateCovariance',P);
disp(track)
```

`objectTrack` with properties:

```

    TrackID: 1
    BranchID: 0
    SourceIndex: 1
    UpdateTime: 0
    Age: 1
    State: [6x1 double]
    StateCovariance: [6x6 double]
    StateParameters: [1x1 struct]
    ObjectClassID: 0
ObjectClassProbabilities: 1
    TrackLogic: 'History'
    TrackLogicState: 1
    IsConfirmed: 1
    IsCoasted: 0
    IsSelfReported: 1
    ObjectAttributes: [1x1 struct]
```

Version History**Introduced in R2020a**

R2022b: Represent track class probability

The `objectTrack` object has a new property, `ObjectClassProbabilities`, which represents the probabilities that the tracked target belongs to specific classes.

Extended Capabilities

C/C++ Code Generation

Generate C and C++ code using MATLAB® Coder™.

- The `TrackLogic` property can only be set during construction.

See Also

`objectDetection`

toStruct

Convert objectTrack object to struct

Syntax

```
S = toStruct(objTrack)
```

Description

`S = toStruct(objTrack)` converts an array of objectTrack objects, objTrack, to an array of structures whose fields are equivalent to the properties of objTrack.

Examples

Convert objectTrack to Struct

Create a report of a track using objectTrack.

```
x = (1:6)';
P = diag(1:6);
track = objectTrack('State', x, 'StateCovariance', P)
```

```
track =
  objectTrack with properties:
        TrackID: 1
        BranchID: 0
        SourceIndex: 1
        UpdateTime: 0
        Age: 1
        State: [6x1 double]
        StateCovariance: [6x6 double]
        StateParameters: [1x1 struct]
        ObjectClassID: 0
        ObjectClassProbabilities: 1
        TrackLogic: 'History'
        TrackLogicState: 1
        IsConfirmed: 1
        IsCoasted: 0
        IsSelfReported: 1
        ObjectAttributes: [1x1 struct]
```

Convert the track object to a structure.

```
S = toStruct(track)

S = struct with fields:
        TrackID: 1
        BranchID: 0
        SourceIndex: 1
```

```
        UpdateTime: 0
        Age: 1
        State: [6x1 double]
    StateCovariance: [6x6 double]
    StateParameters: [1x1 struct]
    ObjectClassID: 0
ObjectClassProbabilities: 1
    TrackLogic: 'History'
    TrackLogicState: 1
    IsConfirmed: 1
    IsCoasted: 0
    IsSelfReported: 1
ObjectAttributes: [1x1 struct]
```

Input Arguments

objTrack — Reports of object track

array of objectTrack object

Reports of object tracks, specified as an array of objectTrack objects.

Output Arguments

S — Structures converted from objectTrack

array of structure

Structures converted from objectTrack, returned as an array of structures. The dimension of the returned structure is same with the dimension of the objTrack input. The fields of each structure are equivalent to the properties of objectTrack.

Version History

Introduced in R2020a

Extended Capabilities

C/C++ Code Generation

Generate C and C++ code using MATLAB® Coder™.

See Also

objectTrack

classUnderlying

Class of parts within quaternion

Syntax

```
underlyingClass = classUnderlying(quat)
```

Description

`underlyingClass = classUnderlying(quat)` returns the name of the class of the parts of the quaternion `quat`.

Examples

Get Underlying Class of Quaternion

A quaternion is a four-part hyper-complex number used in three-dimensional representations. The four parts of the quaternion are of data type `single` or `double`.

Create two quaternions, one with an underlying data type of `single`, and one with an underlying data type of `double`. Verify the underlying data types by calling `classUnderlying` on the quaternions.

```
qSingle = quaternion(single([1,2,3,4]))
```

```
qSingle = quaternion
    1 + 2i + 3j + 4k
```

```
classUnderlying(qSingle)
```

```
ans =
'single'
```

```
qDouble = quaternion([1,2,3,4])
```

```
qDouble = quaternion
    1 + 2i + 3j + 4k
```

```
classUnderlying(qDouble)
```

```
ans =
'double'
```

You can separate quaternions into their parts using the `parts` function. Verify the parts of each quaternion are the correct data type. Recall that `double` is the default MATLAB® type.

```
[aS,bS,cS,dS] = parts(qSingle)
```

```
aS = single
    1
```

```
bS = single
    2

cS = single
    3

dS = single
    4

[aD,bD,cD,dD] = parts(qDouble)

aD = 1

bD = 2

cD = 3

dD = 4
```

Quaternions follow the same implicit casting rules as other data types in MATLAB. That is, a quaternion with underlying data type `single` that is combined with a quaternion with underlying data type `double` results in a quaternion with underlying data type `single`. Multiply `qDouble` and `qSingle` and verify the resulting underlying data type is `single`.

```
q = qDouble*qSingle;
classUnderlying(q)

ans =
'single'
```

Input Arguments

quat — Quaternion to investigate

scalar | vector | matrix | multi-dimensional array

Quaternion to investigate, specified as a quaternion or array of quaternions.

Data Types: quaternion

Output Arguments

underlyingClass — Underlying class of quaternion object

'single' | 'double'

Underlying class of quaternion, returned as the character vector 'single' or 'double'.

Data Types: char

Version History

Introduced in R2020a

Extended Capabilities

C/C++ Code Generation

Generate C and C++ code using MATLAB® Coder™.

See Also

Functions

`compact` | `parts`

Objects

`quaternion`

Topics

“Rotations, Orientations, and Quaternions for Automated Driving”

angvel

Angular velocity from quaternion array

Syntax

```
AV = angvel(Q,dt,'frame')
AV = angvel(Q,dt,'point')
[AV,qf] = angvel(Q,dt,fp,qi)
```

Description

`AV = angvel(Q,dt,'frame')` returns the angular velocity array from an array of quaternions, `Q`. The quaternions in `Q` correspond to frame rotation. The initial quaternion is assumed to represent zero rotation.

`AV = angvel(Q,dt,'point')` returns the angular velocity array from an array of quaternions, `Q`. The quaternions in `Q` correspond to point rotation. The initial quaternion is assumed to represent zero rotation.

`[AV,qf] = angvel(Q,dt,fp,qi)` allows you to specify the initial quaternion, `qi`, and the type of rotation, `fp`. It also returns the final quaternion, `qf`.

Examples

Generate Angular Velocity From Quaternion Array

Create an array of quaternions.

```
eulerAngles = [(0:10:90).',zeros(numel(0:10:90),2)];
q = quaternion(eulerAngles,'eulerd','ZYX','frame');
```

Specify the time step and generate the angular velocity array.

```
dt = 1;
av = angvel(q,dt,'frame') % units in rad/s
```

```
av = 10x3
```

```

0         0         0
0         0     0.1743
0         0     0.1743
0         0     0.1743
0         0     0.1743
0         0     0.1743
0         0     0.1743
0         0     0.1743
0         0     0.1743
0         0     0.1743
```

Input Arguments

Q — Quaternions

N-by-1 vector of quaternions

Quaternions, specified as an *N*-by-1 vector of quaternions.

Data Types: quaternion

dt — Time step

nonnegative scalar

Time step, specified as a nonnegative scalar.

Data Types: single | double

fp — Type of rotation

'frame' | 'point'

Type of rotation, specified as 'frame' or 'point'.

qi — Initial quaternion

quaternion

Initial quaternion, specified as a quaternion.

Data Types: quaternion

Output Arguments

AV — Angular velocity

N-by-3 real matrix

Angular velocity, returned as an *N*-by-3 real matrix. *N* is the number of quaternions given in the input *Q*. Each row of the matrix corresponds to an angular velocity vector.

qf — Final quaternion

quaternion

Final quaternion, returned as a quaternion. *qf* is the same as the last quaternion in the *Q* input.

Data Types: quaternion

Version History

Introduced in R2020a

Extended Capabilities

C/C++ Code Generation

Generate C and C++ code using MATLAB® Coder™.

See Also

quaternion

Topics

“Rotations, Orientations, and Quaternions for Automated Driving”

compact

Convert quaternion array to N -by-4 matrix

Syntax

```
matrix = compact(quat)
```

Description

`matrix = compact(quat)` converts the quaternion array, `quat`, to an N -by-4 matrix. The columns are made from the four quaternion parts. The i^{th} row of the matrix corresponds to `quat(i)`.

Examples

Convert Quaternion Array to Compact Representation of Parts

Create a scalar quaternion with random parts. Convert the parts to a 1-by-4 vector using `compact`.

```
randomParts = randn(1,4)
randomParts = 1×4
    0.5377    1.8339   -2.2588    0.8622

quat = quaternion(randomParts)
quat = quaternion
    0.53767 + 1.8339i - 2.2588j + 0.86217k

quatParts = compact(quat)
quatParts = 1×4
    0.5377    1.8339   -2.2588    0.8622
```

Create a 2-by-2 array of quaternions, then convert the representation to a matrix of quaternion parts. The output rows correspond to the linear indices of the quaternion array.

```
quatArray = [quaternion([1:4;5:8]), quaternion([9:12;13:16])]
quatArray = 2×2 quaternion array
    1 + 2i + 3j + 4k    9 + 10i + 11j + 12k
    5 + 6i + 7j + 8k    13 + 14i + 15j + 16k

quatArrayParts = compact(quatArray)
quatArrayParts = 4×4
```

1	2	3	4
5	6	7	8
9	10	11	12
13	14	15	16

Input Arguments

quat — Quaternion to convert

scalar | vector | matrix | multidimensional array

Quaternion to convert, specified as scalar, vector, matrix, or multidimensional array of quaternions.

Data Types: quaternion

Output Arguments

matrix — Quaternion in matrix form

N-by-4 matrix

Quaternion in matrix form, returned as an *N*-by-4 matrix, where $N = \text{numel}(\text{quat})$.

Data Types: single | double

Version History

Introduced in R2020a

Extended Capabilities

C/C++ Code Generation

Generate C and C++ code using MATLAB® Coder™.

See Also

Functions

parts | classUnderlying

Objects

quaternion

Topics

“Rotations, Orientations, and Quaternions for Automated Driving”

conj

Complex conjugate of quaternion

Syntax

```
quatConjugate = conj(quat)
```

Description

`quatConjugate = conj(quat)` returns the complex conjugate of the quaternion, `quat`.

If $q = a + bi + cj + dk$, the complex conjugate of q is $q^* = a - bi - cj - dk$. Considered as a rotation operator, the conjugate performs the opposite rotation. For example,

```
q = quaternion(deg2rad([16 45 30]), 'rotvec');
a = q*conj(q);
rotatepoint(a,[0,1,0])
```

```
ans =
```

```
    0    1    0
```

Examples

Complex Conjugate of Quaternion

Create a quaternion scalar and get the complex conjugate.

```
q = normalize(quaternion([0.9 0.3 0.3 0.25]))
q = quaternion
    0.87727 + 0.29242i + 0.29242j + 0.24369k
```

```
qConj = conj(q)
```

```
qConj = quaternion
    0.87727 - 0.29242i - 0.29242j - 0.24369k
```

Verify that a quaternion multiplied by its conjugate returns a quaternion one.

```
q*qConj
```

```
ans = quaternion
    1 + 0i + 0j + 0k
```

Input Arguments

quat — Quaternion

scalar | vector | matrix | multidimensional array

Quaternion to conjugate, specified as a scalar, vector, matrix, or array of quaternions.

Data Types: quaternion

Output Arguments

quatConjugate — Quaternion conjugate

scalar | vector | matrix | multidimensional array

Quaternion conjugate, returned as a quaternion or array of quaternions the same size as `quat`.

Data Types: quaternion

Version History

Introduced in R2020a

Extended Capabilities

C/C++ Code Generation

Generate C and C++ code using MATLAB® Coder™.

See Also

Functions

`norm` | `.*`, `times`

Objects

quaternion

Topics

“Rotations, Orientations, and Quaternions for Automated Driving”

ctranspose, '

Complex conjugate transpose of quaternion array

Syntax

```
quatTransposed = quat'
```

Description

`quatTransposed = quat'` returns the complex conjugate transpose of the quaternion, `quat`.

Examples

Vector Complex Conjugate Transpose

Create a vector of quaternions and compute its complex conjugate transpose.

```
quat = quaternion(randn(4,4))
```

```
quat = 4x1 quaternion array
    0.53767 + 0.31877i + 3.5784j + 0.7254k
    1.8339 - 1.3077i + 2.7694j - 0.063055k
   -2.2588 - 0.43359i - 1.3499j + 0.71474k
    0.86217 + 0.34262i + 3.0349j - 0.20497k
```

```
quatTransposed = quat'
```

```
quatTransposed = 1x4 quaternion array
    0.53767 - 0.31877i - 3.5784j - 0.7254k    1.8339 + 1.3077i - 2.7694j + 0.063055k
```

Matrix Complex Conjugate Transpose

Create a matrix of quaternions and compute its complex conjugate transpose.

```
quat = [quaternion(randn(2,4)), quaternion(randn(2,4))]
```

```
quat = 2x2 quaternion array
    0.53767 - 2.2588i + 0.31877j - 0.43359k    3.5784 - 1.3499i + 0.7254j + 0.71474k
    1.8339 + 0.86217i - 1.3077j + 0.34262k    2.7694 + 3.0349i - 0.063055j - 0.20497k
```

```
quatTransposed = quat'
```

```
quatTransposed = 2x2 quaternion array
    0.53767 + 2.2588i - 0.31877j + 0.43359k    1.8339 - 0.86217i + 1.3077j - 0.34262k
    3.5784 + 1.3499i - 0.7254j - 0.71474k    2.7694 - 3.0349i + 0.063055j + 0.20497k
```

Input Arguments

quat — Quaternion to transpose

scalar | vector | matrix

Quaternion to transpose, specified as a vector or matrix or quaternions. The complex conjugate transpose is defined for 1-D and 2-D arrays.

Data Types: quaternion

Output Arguments

quatTransposed — Conjugate transposed quaternion

scalar | vector | matrix

Conjugate transposed quaternion, returned as an N -by- M array, where `quat` was specified as an M -by- N array.

Data Types: quaternion

Version History

Introduced in R2020a

Extended Capabilities

C/C++ Code Generation

Generate C and C++ code using MATLAB® Coder™.

See Also

Functions

`transpose`, `'`

Objects

quaternion

Topics

“Rotations, Orientations, and Quaternions for Automated Driving”

dist

Angular distance in radians

Syntax

```
distance = dist(quatA,quatB)
```

Description

`distance = dist(quatA,quatB)` returns the angular distance in radians between two quaternions, `quatA` and `quatB`.

Examples

Calculate Quaternion Distance

Calculate the quaternion distance between a single quaternion and each element of a vector of quaternions. Define the quaternions using Euler angles.

```
q = quaternion([0,0,0], 'eulerd', 'zyx', 'frame')
```

```
q = quaternion
    1 + 0i + 0j + 0k
```

```
qArray = quaternion([0,45,0;0,90,0;0,180,0;0,-90,0;0,-45,0], 'eulerd', 'zyx', 'frame')
```

```
qArray = 5x1 quaternion array
    0.92388 +      0i + 0.38268j +      0k
    0.70711 +      0i + 0.70711j +      0k
    6.1232e-17 +      0i +      1j +      0k
    0.70711 +      0i - 0.70711j +      0k
    0.92388 +      0i - 0.38268j +      0k
```

```
quaternionDistance = rad2deg(dist(q,qArray))
```

```
quaternionDistance = 5x1
```

```
45.0000
90.0000
180.0000
90.0000
45.0000
```

If both arguments to `dist` are vectors, the quaternion distance is calculated between corresponding elements. Calculate the quaternion distance between two quaternion vectors.

```
angles1 = [30,0,15; ...
           30,5,15; ...
```

```

        30,10,15; ...
        30,15,15];
angles2 = [30,6,15; ...
          31,11,15; ...
          30,16,14; ...
          30.5,21,15.5];

qVector1 = quaternion(angles1, 'eulerd', 'zyx', 'frame');
qVector2 = quaternion(angles2, 'eulerd', 'zyx', 'frame');

rad2deg(dist(qVector1,qVector2))

ans = 4×1

    6.0000
    6.0827
    6.0827
    6.0287

```

Note that a quaternion represents the same rotation as its negative. Calculate a quaternion and its negative.

```

qPositive = quaternion([30,45,-60], 'eulerd', 'zyx', 'frame')

qPositive = quaternion
    0.72332 - 0.53198i + 0.20056j + 0.3919k

qNegative = -qPositive

qNegative = quaternion
    -0.72332 + 0.53198i - 0.20056j - 0.3919k

```

Find the distance between the quaternion and its negative.

```

dist(qPositive,qNegative)

ans = 0

```

The components of a quaternion may look different from the components of its negative, but both expressions represent the same rotation.

Input Arguments

quatA, quatB — Quaternions to calculate distance between

scalar | vector | matrix | multidimensional array

Quaternions to calculate distance between, specified as comma-separated quaternions or arrays of quaternions. `quatA` and `quatB` must have compatible sizes:

- `size(quatA) == size(quatB)`, or
- `numel(quatA) == 1`, or
- `numel(quatB) == 1`, or

- if $[A_{dim1}, \dots, A_{dimN}] = \text{size}(\text{quatA})$ and $[B_{dim1}, \dots, B_{dimN}] = \text{size}(\text{quatB})$, then for $i = 1:N$, either $A_{dimi} == B_{dimi}$ or $A_{dim} == 1$ or $B_{dim} == 1$.

If one of the quaternion arguments contains only one quaternion, then this function returns the distances between that quaternion and every quaternion in the other argument.

Data Types: quaternion

Output Arguments

distance — Angular distance (radians)

scalar | vector | matrix | multidimensional array

Angular distance in radians, returned as an array. The dimensions are the maximum of the union of $\text{size}(\text{quatA})$ and $\text{size}(\text{quatB})$.

Data Types: single | double

Algorithms

The `dist` function returns the angular distance between two quaternions.

A quaternion may be defined by an axis (u_b, u_c, u_d) and angle of rotation θ_q :

$$q = \cos\left(\frac{\theta_q}{2}\right) + \sin\left(\frac{\theta_q}{2}\right)(u_b i + u_c j + u_d k).$$

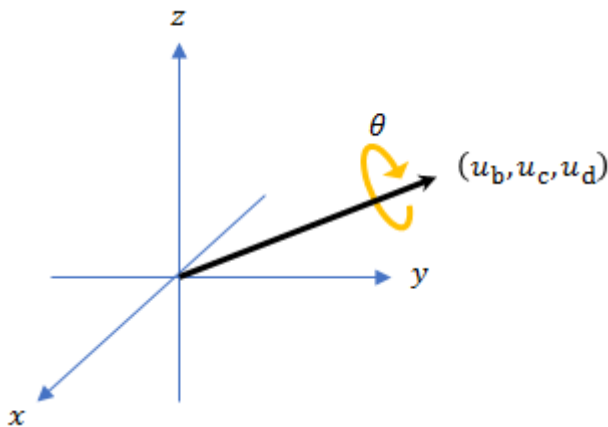

Given a quaternion in the form, $q = a + bi + cj + dk$, where a is the real part, you can solve for the angle of q as $\theta_q = 2\cos^{-1}(a)$.

Consider two quaternions, p and q , and the product $z = p * \text{conjugate}(q)$. As p approaches q , the angle of z goes to 0, and z approaches the unit quaternion.

The angular distance between two quaternions can be expressed as $\theta_z = 2\cos^{-1}(\text{real}(z))$.

Using the quaternion data type syntax, the angular distance is calculated as:

```
angularDistance = 2*acos(abs(parts(p*conj(q))));
```

Version History

Introduced in R2020a

Extended Capabilities

C/C++ Code Generation

Generate C and C++ code using MATLAB® Coder™.

See Also

Functions

parts | conj

Objects

quaternion

Topics

“Rotations, Orientations, and Quaternions for Automated Driving”

euler

Convert quaternion to Euler angles (radians)

Syntax

```
eulerAngles = euler(quat, rotationSequence, rotationType)
```

Description

`eulerAngles = euler(quat, rotationSequence, rotationType)` converts the quaternion, `quat`, to an N -by-3 matrix of Euler angles.

Examples

Convert Quaternion to Euler Angles in Radians

Convert a quaternion frame rotation to Euler angles in radians using the 'ZYX' rotation sequence.

```
quat = quaternion([0.7071 0.7071 0 0]);
eulerAnglesRadians = euler(quat, 'ZYX', 'frame')
```

```
eulerAnglesRadians = 1×3
    0         0    1.5708
```

Input Arguments

quat — Quaternion to convert to Euler angles

scalar | vector | matrix | multidimensional array

Quaternion to convert to Euler angles, specified as a scalar, vector, matrix, or multidimensional array of quaternions.

Data Types: quaternion

rotationSequence — Rotation sequence

'ZYX' | 'YZX' | 'ZYX' | 'ZYX' | 'ZYX' | 'ZYX' | 'ZYX' | 'ZYX' | 'ZYX' | 'ZYX' | 'ZYX' | 'ZYX'

Rotation sequence of Euler representation, specified as a character vector or string.

The rotation sequence defines the order of rotations about the axes. For example, if you specify a rotation sequence of 'YZX':

- 1 The first rotation is about the y-axis.
- 2 The second rotation is about the new z-axis.
- 3 The third rotation is about the new x-axis.

Data Types: char | string

rotationType — Type of rotation

'point' | 'frame'

Type of rotation, specified as 'point' or 'frame'.

In a point rotation, the frame is static and the point moves. In a frame rotation, the point is static and the frame moves. Point rotation and frame rotation define equivalent angular displacements but in opposite directions.

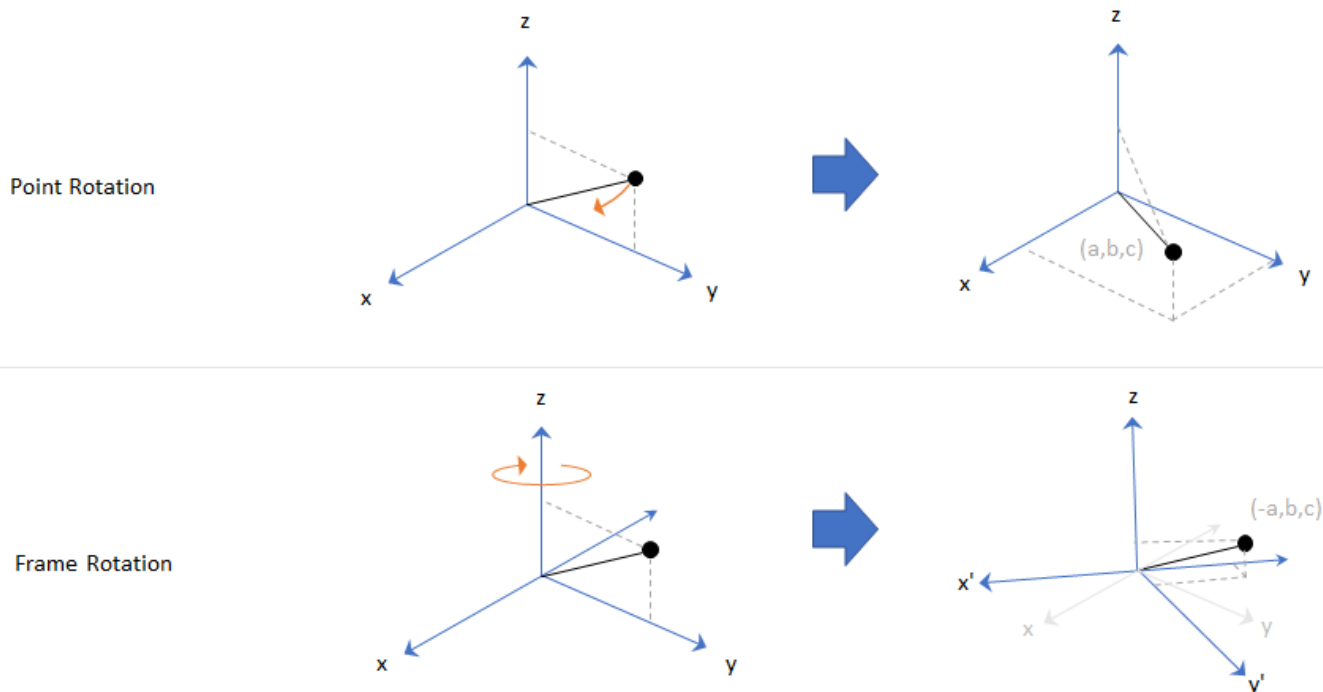

Data Types: char | string

Output Arguments**eulerAngles — Euler angle representation (radians)***N*-by-3 matrix

Euler angle representation in radians, returned as a *N*-by-3 matrix. *N* is the number of quaternions in the `quat` argument.

For each row of `eulerAngles`, the first element corresponds to the first axis in the rotation sequence, the second element corresponds to the second axis in the rotation sequence, and the third element corresponds to the third axis in the rotation sequence.

The data type of the Euler angles representation is the same as the underlying data type of `quat`.

Data Types: single | double

Version History

Introduced in R2020a

Extended Capabilities

C/C++ Code Generation

Generate C and C++ code using MATLAB® Coder™.

See Also

Functions

eulerd | rotateframe | rotatepoint

Objects

quaternion

Topics

“Rotations, Orientations, and Quaternions for Automated Driving”

eulerd

Convert quaternion to Euler angles (degrees)

Syntax

```
eulerAngles = eulerd(quat, rotationSequence, rotationType)
```

Description

`eulerAngles = eulerd(quat, rotationSequence, rotationType)` converts the quaternion, `quat`, to an N -by-3 matrix of Euler angles in degrees.

Examples

Convert Quaternion to Euler Angles in Degrees

Convert a quaternion frame rotation to Euler angles in degrees using the 'ZYX' rotation sequence.

```
quat = quaternion([0.7071 0.7071 0 0]);  
eulerAnglesDegrees = eulerd(quat, 'ZYX', 'frame')
```

```
eulerAnglesDegrees = 1×3  
    0         0    90.0000
```

Input Arguments

quat — Quaternion to convert to Euler angles

scalar | vector | matrix | multidimensional array

Quaternion to convert to Euler angles, specified as a scalar, vector, matrix, or multidimensional array of quaternions.

Data Types: quaternion

rotationSequence — Rotation sequence

'ZYX' | 'YZX' | 'ZYX' | 'ZYX' | 'ZYX' | 'ZYX' | 'ZYX' | 'ZYX' | 'ZYX' | 'ZYX' | 'ZYX' | 'ZYX'

Rotation sequence of Euler angle representation, specified as a character vector or string.

The rotation sequence defines the order of rotations about the axes. For example, if you specify a rotation sequence of 'YZX':

- 1 The first rotation is about the y-axis.
- 2 The second rotation is about the new z-axis.
- 3 The third rotation is about the new x-axis.

Data Types: char | string

rotationType — Type of rotation

'point' | 'frame'

Type of rotation, specified as 'point' or 'frame'.

In a point rotation, the frame is static and the point moves. In a frame rotation, the point is static and the frame moves. Point rotation and frame rotation define equivalent angular displacements but in opposite directions.

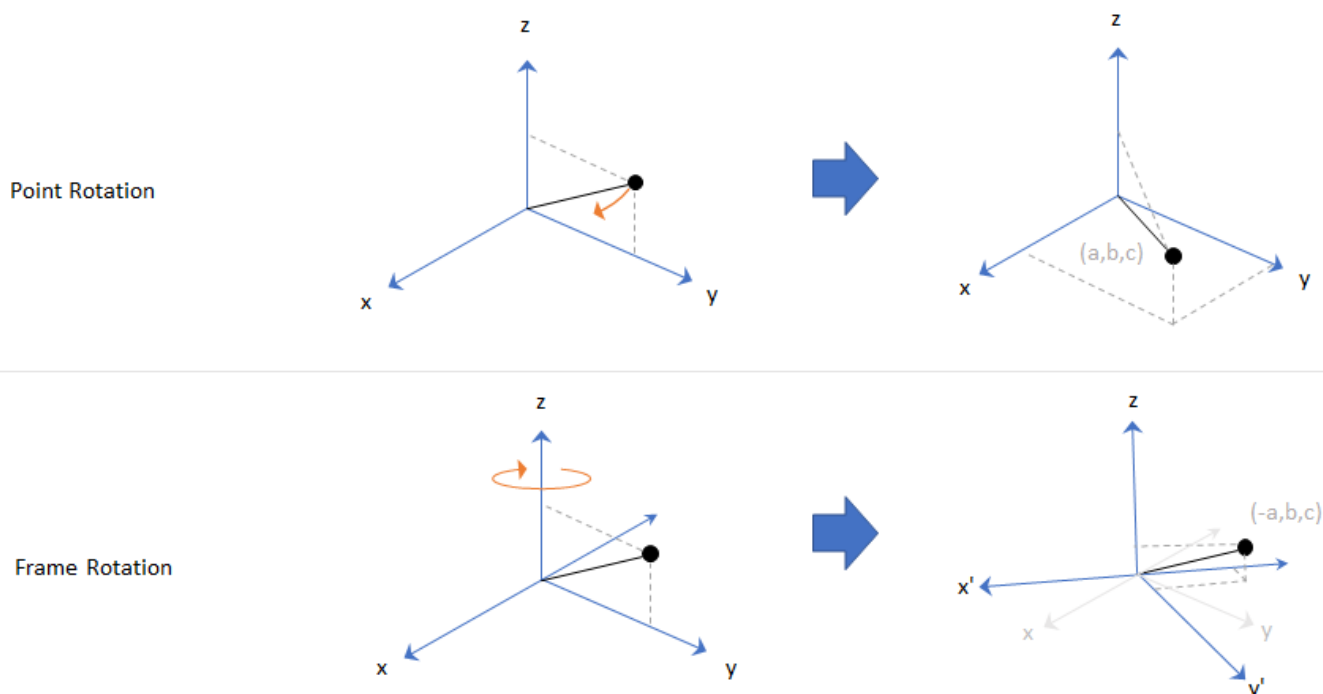

Data Types: char | string

Output Arguments**eulerAngles — Euler angle representation (degrees)** N -by-3 matrix

Euler angle representation in degrees, returned as a N -by-3 matrix. N is the number of quaternions in the `quat` argument.

For each row of `eulerAngles`, the first column corresponds to the first axis in the rotation sequence, the second column corresponds to the second axis in the rotation sequence, and the third column corresponds to the third axis in the rotation sequence.

The data type of the Euler angles representation is the same as the underlying data type of `quat`.

Data Types: single | double

Version History

Introduced in R2020a

Extended Capabilities

C/C++ Code Generation

Generate C and C++ code using MATLAB® Coder™.

See Also

Functions

euler | rotateframe | rotatepoint

Objects

quaternion

Topics

“Rotations, Orientations, and Quaternions for Automated Driving”

exp

Exponential of quaternion array

Syntax

$B = \text{exp}(A)$

Description

$B = \text{exp}(A)$ computes the exponential of the elements of the quaternion array A .

Examples

Exponential of Quaternion Array

Create a 4-by-1 quaternion array A .

```
A = quaternion(magic(4))
```

```
A = 4x1 quaternion array
    16 + 2i + 3j + 13k
     5 + 11i + 10j + 8k
     9 + 7i + 6j + 12k
     4 + 14i + 15j + 1k
```

Compute the exponential of A .

```
B = exp(A)
```

```
B = 4x1 quaternion array
    5.3525e+06 + 1.0516e+06i + 1.5774e+06j + 6.8352e+06k
    -57.359 - 89.189i - 81.081j - 64.865k
    -6799.1 + 2039.1i + 1747.8j + 3495.6k
    -6.66 + 36.931i + 39.569j + 2.6379k
```

Input Arguments

A — Input quaternion

scalar | vector | matrix | multidimensional array

Input quaternion, specified as a scalar, vector, matrix, or multidimensional array.

Data Types: quaternion

Output Arguments

B — Result

scalar | vector | matrix | multidimensional array

Result of quaternion exponential, returned as a scalar, vector, matrix, or multidimensional array.

Data Types: quaternion

Algorithms

Given a quaternion $A = a + bi + cj + dk = a + \bar{v}$, the exponential is computed by

$$\exp(A) = e^a \left(\cos\|\bar{v}\| + \frac{\bar{v}}{\|\bar{v}\|} \sin\|\bar{v}\| \right)$$

Version History

Introduced in R2020a

Extended Capabilities

C/C++ Code Generation

Generate C and C++ code using MATLAB® Coder™.

See Also

Functions

.^, power | log

Objects

quaternion

Topics

“Rotations, Orientations, and Quaternions for Automated Driving”

ldivide, .\

Element-wise quaternion left division

Syntax

`C = A.\B`

Description

`C = A.\B` performs quaternion element-wise division by dividing each element of quaternion B by the corresponding element of quaternion A.

Examples

Divide a Quaternion Array by a Real Scalar

Create a 2-by-1 quaternion array, and divide it element-by-element by a real scalar.

```
A = quaternion([1:4;5:8])
```

```
A = 2x1 quaternion array
    1 + 2i + 3j + 4k
    5 + 6i + 7j + 8k
```

```
B = 2;
C = A.\B
```

```
C = 2x1 quaternion array
    0.066667 - 0.133333i - 0.2j - 0.26667k
    0.057471 - 0.068966i - 0.08046j - 0.091954k
```

Divide a Quaternion Array by Another Quaternion Array

Create a 2-by-2 quaternion array, and divide it element-by-element by another 2-by-2 quaternion array.

```
q1 = quaternion([1:4;2:5;4:7;5:8]);
A = reshape(q1,2,2)
```

```
A = 2x2 quaternion array
    1 + 2i + 3j + 4k    4 + 5i + 6j + 7k
    2 + 3i + 4j + 5k    5 + 6i + 7j + 8k
```

```
q2 = quaternion(magic(4));
B = reshape(q2,2,2)
```

```
B = 2x2 quaternion array
    16 + 2i + 3j + 13k      9 + 7i + 6j + 12k
    5 + 11i + 10j + 8k     4 + 14i + 15j + 1k
```

```
C = A.\B
```

```
C = 2x2 quaternion array
    2.7 - 1.9i - 0.9j - 1.7k      1.5159 - 0.37302i - 0.15079j - 0.0238
    2.2778 + 0.46296i - 0.57407j + 0.092593k      1.2471 + 0.91379i - 0.33908j - 0.109
```

Input Arguments

A — Divisor

scalar | vector | matrix | multidimensional array

Divisor, specified as a quaternion, an array of quaternions, a real scalar, or an array of real numbers.

A and B must have compatible sizes. In the simplest cases, they can be the same size or one can be a scalar. Two inputs have compatible sizes if, for every dimension, the dimension sizes of the inputs are the same or one of the dimensions is 1.

Data Types: quaternion | single | double

B — Dividend

scalar | vector | matrix | multidimensional array

Dividend, specified as a quaternion, an array of quaternions, a real scalar, or an array of real numbers.

A and B must have compatible sizes. In the simplest cases, they can be the same size or one can be a scalar. Two inputs have compatible sizes if, for every dimension, the dimension sizes of the inputs are the same or one of the dimensions is 1.

Data Types: quaternion | single | double

Output Arguments

C — Result

scalar | vector | matrix | multidimensional array

Result of quaternion division, returned as a scalar, vector, matrix, or multidimensional array.

Data Types: quaternion

Algorithms

Quaternion Division

Given a quaternion $A = a_1 + a_2i + a_3j + a_4k$ and a real scalar p ,

$$C = p.\backslash A = \frac{a_1}{p} + \frac{a_2}{p}i + \frac{a_3}{p}j + \frac{a_4}{p}k$$

Note For a real scalar p , $A./p = A.\backslash p$.

Quaternion Division by a Quaternion Scalar

Given two quaternions A and B of compatible sizes, then

$$C = A.\backslash B = A^{-1}.*B = \left(\frac{\text{conj}(A)}{\text{norm}(A)^2} \right).*B$$

Version History

Introduced in R2020a

Extended Capabilities

C/C++ Code Generation

Generate C and C++ code using MATLAB® Coder™.

See Also

Functions

.*,times | conj | norm | ./,ldivide

Objects

quaternion

Topics

“Rotations, Orientations, and Quaternions for Automated Driving”

log

Natural logarithm of quaternion array

Syntax

```
B = log(A)
```

Description

`B = log(A)` computes the natural logarithm of the elements of the quaternion array `A`.

Examples

Logarithmic Values of Quaternion Array

Create a 3-by-1 quaternion array `A`.

```
A = quaternion(randn(3,4))
```

```
A = 3x1 quaternion array
    0.53767 + 0.86217i - 0.43359j + 2.7694k
    1.8339 + 0.31877i + 0.34262j - 1.3499k
   -2.2588 - 1.3077i + 3.5784j + 3.0349k
```

Compute the logarithmic values of `A`.

```
B = log(A)
```

```
B = 3x1 quaternion array
    1.0925 + 0.40848i - 0.20543j + 1.3121k
    0.8436 + 0.14767i + 0.15872j - 0.62533k
    1.6807 - 0.53829i + 1.473j + 1.2493k
```

Input Arguments

A — Input array

scalar | vector | matrix | multidimensional array

Input array, specified as a scalar, vector, matrix, or multidimensional array.

Data Types: quaternion

Output Arguments

B — Logarithm values

scalar | vector | matrix | multidimensional array

Quaternion natural logarithm values, returned as a scalar, vector, matrix, or multidimensional array.

Data Types: quaternion

Algorithms

Given a quaternion $A = a + \bar{v} = a + bi + cj + dk$, the logarithm is computed by

$$\log(A) = \log\|A\| + \frac{\bar{v}}{\|\bar{v}\|} \arccos \frac{a}{\|A\|}$$

Version History

Introduced in R2020a

Extended Capabilities

C/C++ Code Generation

Generate C and C++ code using MATLAB® Coder™.

See Also

Functions

exp | .^, power

Objects

quaternion

Topics

“Rotations, Orientations, and Quaternions for Automated Driving”

meanrot

Quaternion mean rotation

Syntax

```
quatAverage = meanrot(quat)
quatAverage = meanrot(quat,dim)
quatAverage = meanrot( ____,nanflag)
```

Description

`quatAverage = meanrot(quat)` returns the average rotation of the elements of `quat` along the first array dimension whose size not does equal 1.

- If `quat` is a vector, `meanrot(quat)` returns the average rotation of the elements.
- If `quat` is a matrix, `meanrot(quat)` returns a row vector containing the average rotation of each column.
- If `quat` is a multidimensional array, then `meanrot(quat)` operates along the first array dimension whose size does not equal 1, treating the elements as vectors. This dimension becomes 1 while the sizes of all other dimensions remain the same.

The `meanrot` function normalizes the input quaternions, `quat`, before calculating the mean.

`quatAverage = meanrot(quat,dim)` return the average rotation along dimension `dim`. For example, if `quat` is a matrix, then `meanrot(quat,2)` is a column vector containing the mean of each row.

`quatAverage = meanrot(____,nanflag)` specifies whether to include or omit NaN values from the calculation for any of the previous syntaxes. `meanrot(quat,'includenan')` includes all NaN values in the calculation while `mean(quat,'omitnan')` ignores them.

Examples

Quaternion Mean Rotation

Create a matrix of quaternions corresponding to three sets of Euler angles.

```
eulerAngles = [40 20 10; ...
               50 10 5; ...
               45 70 1];
```

```
quat = quaternion(eulerAngles,'eulerd','ZYX','frame');
```

Determine the average rotation represented by the quaternions. Convert the average rotation to Euler angles in degrees for readability.

```
quatAverage = meanrot(quat)
```



```

quatAverage = quaternion
    0.88863 - 0.062598i + 0.27822j + 0.35918k

eulerAverage = eulerd(quatAverage, 'ZYX', 'frame')

eulerAverage = 1×3

    45.7876    32.6452    6.0407

```

Average Out Rotational Noise

Use `meanrot` over a sequence of quaternions to average out additive noise.

Create a vector of $1e6$ quaternions whose distance, as defined by the `dist` function, from `quaternion(1,0,0,0)` is normally distributed. Plot the Euler angles corresponding to the noisy quaternion vector.

```

nrows = 1e6;
ax = 2*rand(nrows,3) - 1;
ax = ax./sqrt(sum(ax.^2,2));
ang = 0.5*randn(size(ax,1),1);
q = quaternion(ax.*ang, 'rotvec');

noisyEulerAngles = eulerd(q, 'ZYX', 'frame');

figure(1)

subplot(3,1,1)
plot(noisyEulerAngles(:,1))
title('Z-Axis')
ylabel('Rotation (degrees)')
hold on

subplot(3,1,2)
plot(noisyEulerAngles(:,2))
title('Y-Axis')
ylabel('Rotation (degrees)')
hold on

subplot(3,1,3)
plot(noisyEulerAngles(:,3))
title('X-Axis')
ylabel('Rotation (degrees)')
hold on

```

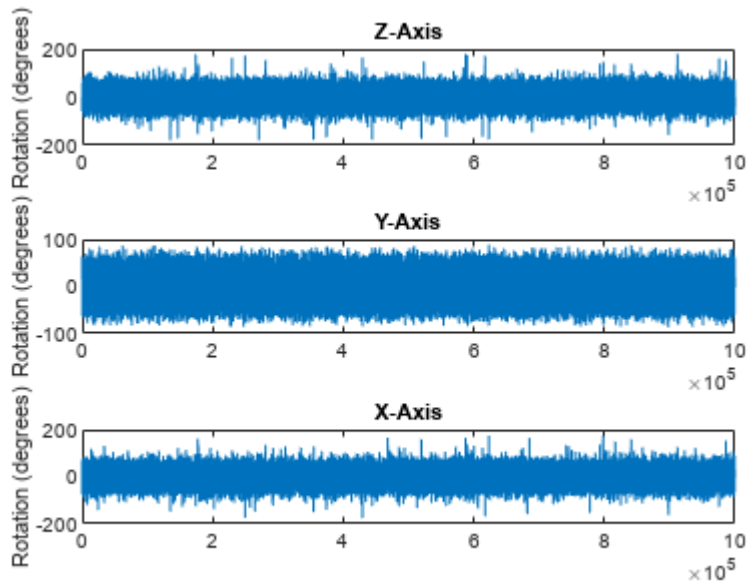

Use `meanrot` to determine the average quaternion given the vector of quaternions. Convert to Euler angles and plot the results.

```

qAverage = meanrot(q);
qAverageInEulerAngles = eulerd(qAverage, 'ZYX', 'frame');
figure(1)
subplot(3,1,1)
plot(ones(nrows,1)*qAverageInEulerAngles(:,1))
title('Z-Axis')
subplot(3,1,2)
plot(ones(nrows,1)*qAverageInEulerAngles(:,2))
title('Y-Axis')
subplot(3,1,3)
plot(ones(nrows,1)*qAverageInEulerAngles(:,3))
title('X-Axis')

```

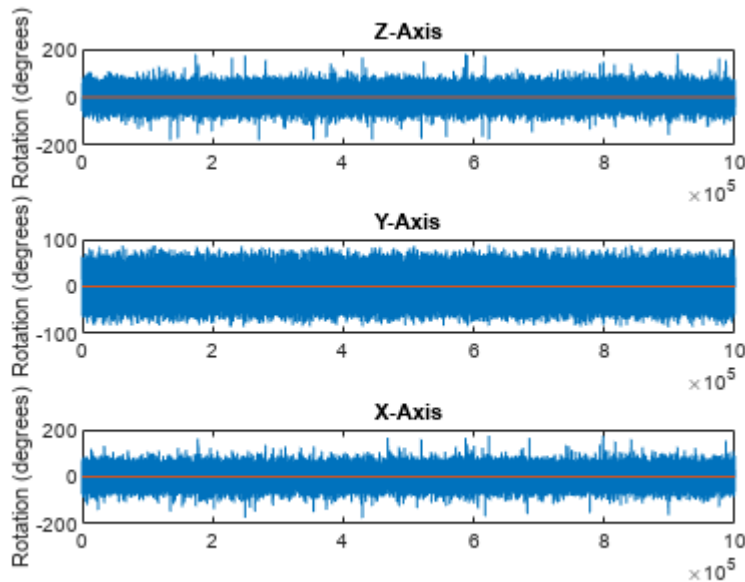

The meanrot Algorithm and Limitations

The meanrot Algorithm

The meanrot function outputs a quaternion that minimizes the squared Frobenius norm of the difference between rotation matrices. Consider two quaternions:

- q_0 represents no rotation.
- q_{90} represents a 90 degree rotation about the x-axis.

```
q0 = quaternion([0 0 0], 'eulerd', 'ZYX', 'frame');
q90 = quaternion([0 0 90], 'eulerd', 'ZYX', 'frame');
```

Create a quaternion sweep, q_{sweep} , that represents rotations from 0 to 180 degrees about the x-axis.

```
eulerSweep = (0:1:180)';
qSweep = quaternion([zeros(numel(eulerSweep),2), eulerSweep], ...
    'eulerd', 'ZYX', 'frame');
```

Convert q_0 , q_{90} , and q_{sweep} to rotation matrices. In a loop, calculate the metric to minimize for each member of the quaternion sweep. Plot the results and return the value of the Euler sweep that corresponds to the minimum of the metric.

```
r0 = rotmat(q0, 'frame');
r90 = rotmat(q90, 'frame');
rSweep = rotmat(qSweep, 'frame');

metricToMinimize = zeros(size(rSweep,3),1);
for i = 1:numel(qSweep)
    metricToMinimize(i) = norm((rSweep(:,:,i) - r0), 'fro').^2 + ...
        norm((rSweep(:,:,i) - r90), 'fro').^2;
end
```

```
plot(eulerSweep,metricToMinimize)
xlabel('Euler Sweep (degrees)')
ylabel('Metric to Minimize')
```

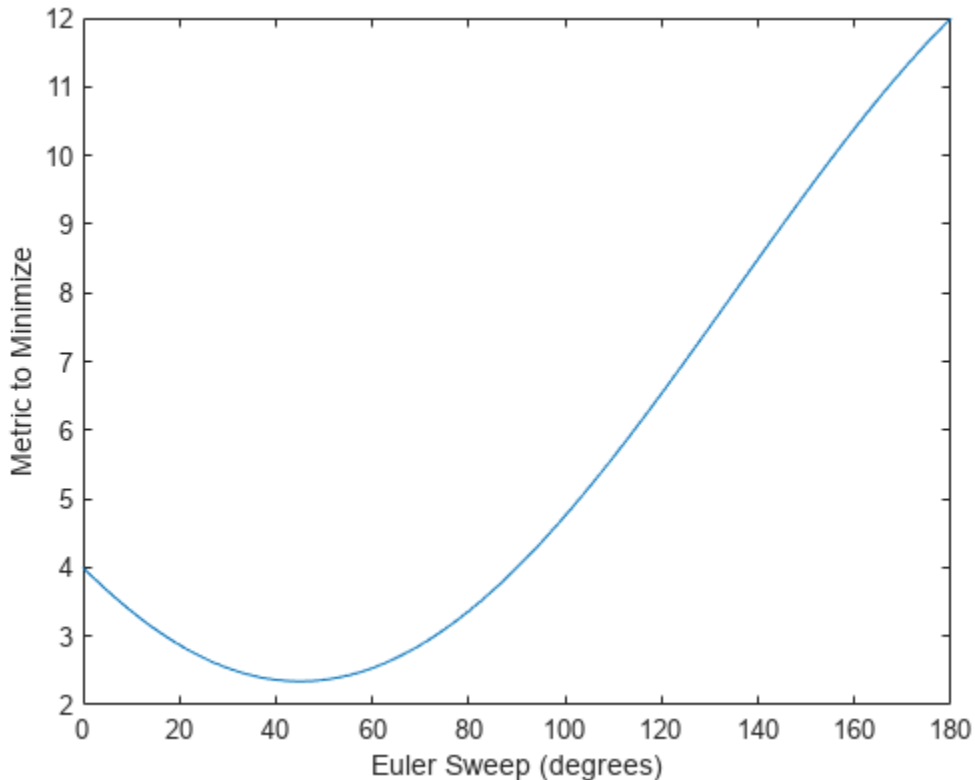

```
[~,eulerIndex] = min(metricToMinimize);
eulerSweep(eulerIndex)
```

```
ans = 45
```

The minimum of the metric corresponds to the Euler angle sweep at 45 degrees. That is, `meanrot` defines the average between `quaternion([0 0 0], 'ZYX', 'frame')` and `quaternion([0 0 90], 'ZYX', 'frame')` as `quaternion([0 0 45], 'ZYX', 'frame')`. Call `meanrot` with `q0` and `q90` to verify the same result.

```
eulerd(meanrot([q0,q90]), 'ZYX', 'frame')
```

```
ans = 1×3
```

```
0 0 45.0000
```

Limitations

The metric that `meanrot` uses to determine the mean rotation is not unique for quaternions significantly far apart. Repeat the experiment above for quaternions that are separated by 180 degrees.

```

q180 = quaternion([0 0 180], 'eulerd', 'ZYX', 'frame');
r180 = rotmat(q180, 'frame');

for i = 1:numel(qSweep)
    metricToMinimize(i) = norm((rSweep(:,:,i) - r0), 'fro').^2 + ...
        norm((rSweep(:,:,i) - r180), 'fro').^2;
end

plot(eulerSweep, metricToMinimize)
xlabel('Euler Sweep (degrees)')
ylabel('Metric to Minimize')

```

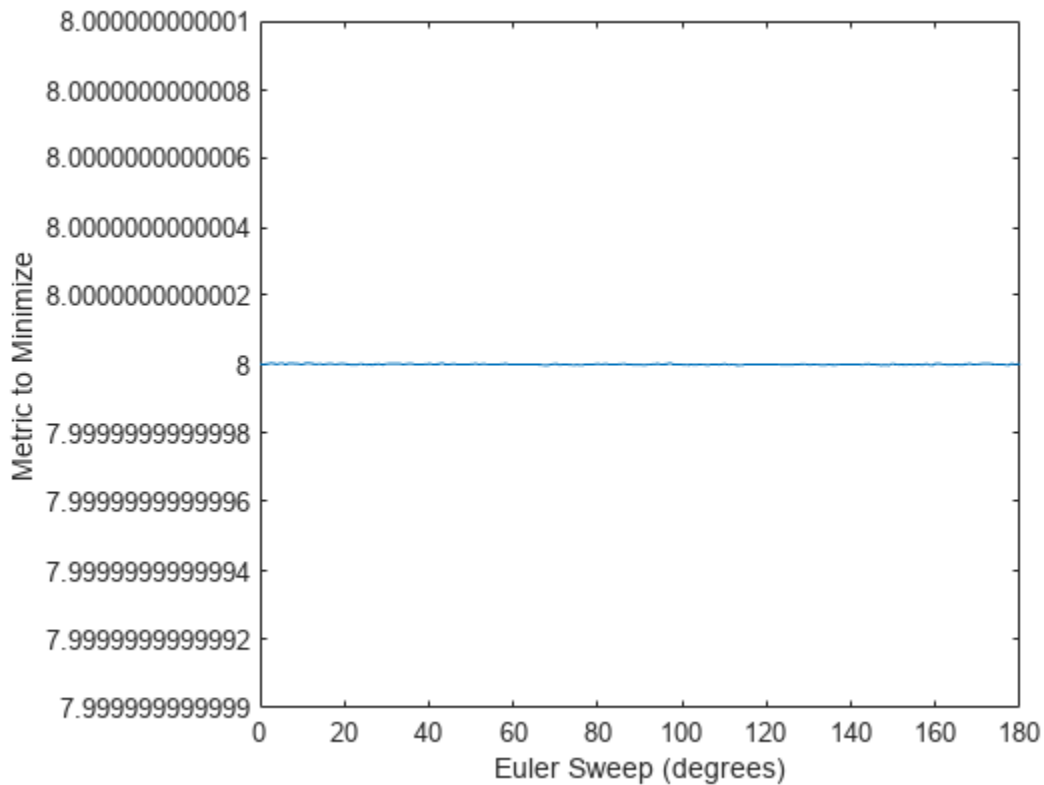

```

[~,eulerIndex] = min(metricToMinimize);
eulerSweep(eulerIndex)

```

```
ans = 159
```

Quaternion means are usually calculated for rotations that are close to each other, which makes the edge case shown in this example unlikely in real-world applications. To average two quaternions that are significantly far apart, use the `slerp` function. Repeat the experiment using `slerp` and verify that the quaternion mean returned is more intuitive for large distances.

```

qMean = slerp(q0,q180,0.5);
q0_q180 = eulerd(qMean, 'ZYX', 'frame')

q0_q180 = 1×3

```

```
0 0 90.0000
```

Input Arguments

quat — Quaternion

scalar | vector | matrix | multidimensional array

Quaternion for which to calculate the mean, specified as a scalar, vector, matrix, or multidimensional array of quaternions.

Data Types: quaternion

dim — Dimension to operate along

positive integer scalar

Dimension to operate along, specified as a positive integer scalar. If no value is specified, then the default is the first array dimension whose size does not equal 1.

Dimension `dim` indicates the dimension whose length reduces to 1. The `size(quatAverage, dim)` is 1, while the sizes of all other dimensions remain the same.

Data Types: double | single

nanflag — NaN condition

'includenan' (default) | 'omitnan'

NaN condition, specified as one of these values:

- 'includenan' -- Include NaN values when computing the mean rotation, resulting in NaN.
- 'omitnan' -- Ignore all NaN values in the input.

Data Types: char | string

Output Arguments

quatAverage — Quaternion average rotation

scalar | vector | matrix | multidimensional array

Quaternion average rotation, returned as a scalar, vector, matrix, or multidimensional array.

Data Types: single | double

Algorithms

`meanrot` determines a quaternion mean, \bar{q} , according to [1]. \bar{q} is the quaternion that minimizes the squared Frobenius norm of the difference between rotation matrices:

$$\bar{q} = \arg \min_{q \in S^3} \sum_{i=1}^n \|A(q) - A(q_i)\|_F^2$$

Version History

Introduced in R2020a

References

- [1] Markley, F. Landis, Yang Chen, John Lucas Crassidis, and Yaakov Oshman. "Average Quaternions." *Journal of Guidance, Control, and Dynamics*. Vol. 30, Issue 4, 2007, pp. 1193-1197.

Extended Capabilities

C/C++ Code Generation

Generate C and C++ code using MATLAB® Coder™.

See Also

Functions

`dist` | `slerp`

Objects

`quaternion`

Topics

"Rotations, Orientations, and Quaternions for Automated Driving"

minus, -

Quaternion subtraction

Syntax

$C = A - B$

Description

$C = A - B$ subtracts quaternion B from quaternion A using quaternion subtraction. Either A or B may be a real number, in which case subtraction is performed with the real part of the quaternion argument.

Examples

Subtract a Quaternion from a Quaternion

Quaternion subtraction is defined as the subtraction of the corresponding parts of each quaternion. Create two quaternions and perform subtraction.

```
Q1 = quaternion([1,0,-2,7]);  
Q2 = quaternion([1,2,3,4]);
```

```
Q1minusQ2 = Q1 - Q2
```

```
Q1minusQ2 = quaternion  
    0 - 2i - 5j + 3k
```

Subtract a Real Number from a Quaternion

Addition and subtraction of real numbers is defined for quaternions as acting on the real part of the quaternion. Create a quaternion and then subtract 1 from the real part.

```
Q = quaternion([1,1,1,1])
```

```
Q = quaternion  
    1 + 1i + 1j + 1k
```

```
Qminus1 = Q - 1
```

```
Qminus1 = quaternion  
    0 + 1i + 1j + 1k
```

Input Arguments

A — Input

scalar | vector | matrix | multidimensional array

Input, specified as a quaternion, array of quaternions, real number, or array of real numbers.

Data Types: quaternion | single | double

B — Input

scalar | vector | matrix | multidimensional array

Input, specified as a quaternion, array of quaternions, real number, or array of real numbers.

Data Types: quaternion | single | double

Output Arguments

C — Result

scalar | vector | matrix | multidimensional array

Result of quaternion subtraction, returned as a scalar, vector, matrix, or multidimensional array of quaternions.

Data Types: quaternion

Version History

Introduced in R2020a

Extended Capabilities

C/C++ Code Generation

Generate C and C++ code using MATLAB® Coder™.

See Also

Functions

-, uminus | .*, times | *, mtimes

Objects

quaternion

Topics

“Rotations, Orientations, and Quaternions for Automated Driving”

mtimes, *

Quaternion multiplication

Syntax

```
quatC = A*B
```

Description

`quatC = A*B` implements quaternion multiplication if either A or B is a quaternion. Either A or B must be a scalar.

You can use quaternion multiplication to compose rotation operators:

- To compose a sequence of frame rotations, multiply the quaternions in the order of the desired sequence of rotations. For example, to apply a p quaternion followed by a q quaternion, multiply in the order pq . The rotation operator becomes $(pq)^*v(pq)$, where v represents the object to rotate specified in quaternion form. $*$ represents conjugation.
- To compose a sequence of point rotations, multiply the quaternions in the reverse order of the desired sequence of rotations. For example, to apply a p quaternion followed by a q quaternion, multiply in the reverse order, qp . The rotation operator becomes $(qp)v(qp)^*$.

Examples

Multiply Quaternion Scalar and Quaternion Vector

Create a 4-by-1 column vector, A, and a scalar, b. Multiply A times b.

```
A = quaternion(randn(4,4))
```

```
A = 4x1 quaternion array
    0.53767 + 0.31877i + 3.5784j + 0.7254k
    1.8339 - 1.3077i + 2.7694j - 0.063055k
   -2.2588 - 0.43359i - 1.3499j + 0.71474k
    0.86217 + 0.34262i + 3.0349j - 0.20497k
```

```
b = quaternion(randn(1,4))
```

```
b = quaternion
   -0.12414 + 1.4897i + 1.409j + 1.4172k
```

```
C = A*b
```

```
C = 4x1 quaternion array
   -6.6117 + 4.8105i + 0.94224j - 4.2097k
   -2.0925 + 6.9079i + 3.9995j - 3.3614k
    1.8155 - 6.2313i - 1.336j - 1.89k
   -4.6033 + 5.8317i + 0.047161j - 2.791k
```

Input Arguments

A — Input

scalar | vector | matrix | multidimensional array

Input to multiply, specified as a quaternion, array of quaternions, real scalar, or array of real scalars.

If B is nonscalar, then A must be scalar.

Data Types: quaternion | single | double

B — Input

scalar | vector | matrix | multidimensional array

Input to multiply, specified as a quaternion, array of quaternions, real scalar, or array of real scalars.

If A is nonscalar, then B must be scalar.

Data Types: quaternion | single | double

Output Arguments

quatC — Quaternion product

scalar | vector | matrix | multidimensional array

Quaternion product, returned as a quaternion or array of quaternions.

Data Types: quaternion

Algorithms

Quaternion Multiplication by a Real Scalar

Given a quaternion

$$q = a_q + b_q i + c_q j + d_q k,$$

the product of q and a real scalar β is

$$\beta q = \beta a_q + \beta b_q i + \beta c_q j + \beta d_q k$$

Quaternion Multiplication by a Quaternion Scalar

The definition of the basis elements for quaternions,

$$i^2 = j^2 = k^2 = ijk = -1,$$

can be expanded to populate a table summarizing quaternion basis element multiplication:

	1	i	j	k
1	1	i	j	k
i	i	-1	k	-j

j	j	-k	-1	i
k	k	j	-i	-1

When reading the table, the rows are read first, for example: $ij = k$ and $ji = -k$.

Given two quaternions, $q = a_q + b_q i + c_q j + d_q k$, and $p = a_p + b_p i + c_p j + d_p k$, the multiplication can be expanded as:

$$\begin{aligned}
 z = pq &= (a_p + b_p i + c_p j + d_p k)(a_q + b_q i + c_q j + d_q k) \\
 &= a_p a_q + a_p b_q i + a_p c_q j + a_p d_q k \\
 &\quad + b_p a_q i + b_p b_q i^2 + b_p c_q ij + b_p d_q ik \\
 &\quad + c_p a_q j + c_p b_q ji + c_p c_q j^2 + c_p d_q jk \\
 &\quad + d_p a_q k + d_p b_q ki + d_p c_q kj + d_p d_q k^2
 \end{aligned}$$

You can simplify the equation using the quaternion multiplication table:

$$\begin{aligned}
 z = pq &= a_p a_q + a_p b_q i + a_p c_q j + a_p d_q k \\
 &\quad + b_p a_q i - b_p b_q + b_p c_q k - b_p d_q j \\
 &\quad + c_p a_q j - c_p b_q k - c_p c_q + c_p d_q i \\
 &\quad + d_p a_q k + d_p b_q j - d_p c_q i - d_p d_q
 \end{aligned}$$

Version History

Introduced in R2020a

References

- [1] Kuipers, Jack B. *Quaternions and Rotation Sequences: A Primer with Applications to Orbits, Aerospace, and Virtual Reality*. Princeton, NJ: Princeton University Press, 2007.

Extended Capabilities

C/C++ Code Generation

Generate C and C++ code using MATLAB® Coder™.

See Also

Functions

.*,times

Objects

quaternion

Topics

“Rotations, Orientations, and Quaternions for Automated Driving”

norm

Quaternion norm

Syntax

`N = norm(quat)`

Description

`N = norm(quat)` returns the norm of the quaternion, `quat`.

Given a quaternion of the form $Q = a + bi + cj + dk$, the norm of the quaternion is defined as $\text{norm}(Q) = \sqrt{a^2 + b^2 + c^2 + d^2}$.

Examples

Calculate Quaternion Norm

Create a scalar quaternion and calculate its norm.

```
quat = quaternion(1,2,3,4);
norm(quat)
```

```
ans = 5.4772
```

The quaternion norm is defined as the square root of the sum of the quaternion parts squared. Calculate the quaternion norm explicitly to verify the result of the `norm` function.

```
[a,b,c,d] = parts(quat);
sqrt(a^2+b^2+c^2+d^2)
```

```
ans = 5.4772
```

Input Arguments

quat — Quaternion

scalar | vector | matrix | multidimensional array

Quaternion for which to calculate the norm, specified as a scalar, vector, matrix, or multidimensional array of quaternions.

Data Types: quaternion

Output Arguments

N — Quaternion norm

scalar | vector | matrix | multidimensional array

Quaternion norm. If the input `quat` is an array, the output is returned as an array the same size as `quat`. Elements of the array are real numbers with the same data type as the underlying data type of the quaternion, `quat`.

Data Types: `single` | `double`

Version History

Introduced in R2020a

Extended Capabilities

C/C++ Code Generation

Generate C and C++ code using MATLAB® Coder™.

See Also

Functions

`normalize` | `parts` | `conj`

Objects

`quaternion`

Topics

“Rotations, Orientations, and Quaternions for Automated Driving”

normalize

Quaternion normalization

Syntax

```
quatNormalized = normalize(quat)
```

Description

`quatNormalized = normalize(quat)` normalizes the quaternion.

Given a quaternion of the form $Q = a + bi + cj + dk$, the normalized quaternion is defined as $Q/\sqrt{a^2 + b^2 + c^2 + d^2}$.

Examples

Normalize Elements of Quaternion Vector

Quaternions can represent rotations when normalized. You can use `normalize` to normalize a scalar, elements of a matrix, or elements of a multi-dimensional array of quaternions. Create a column vector of quaternions, then normalize them.

```
quatArray = quaternion([1,2,3,4; ...
                       2,3,4,1; ...
                       3,4,1,2]);
quatArrayNormalized = normalize(quatArray)

quatArrayNormalized = 3x1 quaternion array
    0.18257 + 0.36515i + 0.54772j + 0.7303k
    0.36515 + 0.54772i + 0.7303j + 0.18257k
    0.54772 + 0.7303i + 0.18257j + 0.36515k
```

Input Arguments

quat — Quaternion to normalize

scalar | vector | matrix | multidimensional array

Quaternion to normalize, specified as a scalar, vector, matrix, or multidimensional array of quaternions.

Data Types: quaternion

Output Arguments

quatNormalized — Normalized quaternion

scalar | vector | matrix | multidimensional array

Normalized quaternion, returned as a quaternion or array of quaternions the same size as `quat`.

Data Types: `quaternion`

Version History

Introduced in R2020a

Extended Capabilities

C/C++ Code Generation

Generate C and C++ code using MATLAB® Coder™.

See Also

Functions

`norm` | `.*`, `times` | `conj`

Objects

`quaternion`

Topics

“Rotations, Orientations, and Quaternions for Automated Driving”

ones

Create quaternion array with real parts set to one and imaginary parts set to zero

Syntax

```
quat0nes = ones('quaternion')
quat0nes = ones(n,'quaternion')
quat0nes = ones(sz,'quaternion')
quat0nes = ones(sz1,...,szN,'quaternion')

quat0nes = ones( ____, 'like', prototype, 'quaternion')
```

Description

`quat0nes = ones('quaternion')` returns a scalar quaternion with the real part set to 1 and the imaginary parts set to 0.

Given a quaternion of the form $Q = a + bi + cj + dk$, a quaternion one is defined as $Q = 1 + 0i + 0j + 0k$.

`quat0nes = ones(n,'quaternion')` returns an n-by-n quaternion matrix with the real parts set to 1 and the imaginary parts set to 0.

`quat0nes = ones(sz,'quaternion')` returns an array of quaternion ones where the size vector, `sz`, defines `size(q0nes)`.

Example: `ones([1,4,2],'quaternion')` returns a 1-by-4-by-2 array of quaternions with the real parts set to 1 and the imaginary parts set to 0.

`quat0nes = ones(sz1,...,szN,'quaternion')` returns a `sz1`-by-...-by-`szN` array of ones where `sz1,...,szN` indicates the size of each dimension.

`quat0nes = ones(____, 'like', prototype, 'quaternion')` specifies the underlying class of the returned quaternion array to be the same as the underlying class of the quaternion prototype.

Examples

Quaternion Scalar One

Create a quaternion scalar one.

```
quat0nes = ones('quaternion')

quat0nes = quaternion
          1 + 0i + 0j + 0k
```

Square Matrix of Quaternion Ones

Create an n-by-n matrix of quaternion ones.

```
n = 3;
quatOnes = ones(n, 'quaternion')

quatOnes = 3x3 quaternion array
    1 + 0i + 0j + 0k    1 + 0i + 0j + 0k    1 + 0i + 0j + 0k
    1 + 0i + 0j + 0k    1 + 0i + 0j + 0k    1 + 0i + 0j + 0k
    1 + 0i + 0j + 0k    1 + 0i + 0j + 0k    1 + 0i + 0j + 0k
```

Multidimensional Array of Quaternion Ones

Create a multidimensional array of quaternion ones by defining array dimensions in order. In this example, you create a 3-by-1-by-2 array. You can specify dimensions using a row vector or comma-separated integers. Specify the dimensions using a row vector and display the results:

```
dims = [3,1,2];
quatOnesSyntax1 = ones(dims, 'quaternion')
```

```
quatOnesSyntax1 = 3x1x2 quaternion array
quatOnesSyntax1(:,:,1) =
```

```
    1 + 0i + 0j + 0k
    1 + 0i + 0j + 0k
    1 + 0i + 0j + 0k
```

```
quatOnesSyntax1(:,:,2) =
```

```
    1 + 0i + 0j + 0k
    1 + 0i + 0j + 0k
    1 + 0i + 0j + 0k
```

Specify the dimensions using comma-separated integers, and then verify the equivalency of the two syntaxes:

```
quatOnesSyntax2 = ones(3,1,2, 'quaternion');
isequal(quatOnesSyntax1, quatOnesSyntax2)
```

```
ans = logical
     1
```

Underlying Class of Quaternion Ones

A quaternion is a four-part hyper-complex number used in three-dimensional rotations and orientations. You can specify the underlying data type of the parts as `single` or `double`. The default is `double`.

Create a quaternion array of ones with the underlying data type set to `single`.

```
quatOnes = ones(2,'like',single(1),'quaternion')
```

```
quatOnes = 2x2 quaternion array
    1 + 0i + 0j + 0k    1 + 0i + 0j + 0k
    1 + 0i + 0j + 0k    1 + 0i + 0j + 0k
```

Verify the underlying class using the `classUnderlying` function.

```
classUnderlying(quatOnes)
```

```
ans =
'single'
```

Input Arguments

n — Size of square quaternion matrix

integer value

Size of square quaternion matrix, specified as an integer value.

If `n` is zero or negative, then `quatOnes` is returned as an empty matrix.

Example: `ones(4,'quaternion')` returns a 4-by-4 matrix of quaternions with the real parts set to 1 and the imaginary parts set to 0.

Data Types: `single` | `double` | `int8` | `int16` | `int32` | `int64` | `uint8` | `uint16` | `uint32` | `uint64`

sz — Output size

row vector of integer values

Output size, specified as a row vector of integer values. Each element of `sz` indicates the size of the corresponding dimension in `quatOnes`. If the size of any dimension is 0 or negative, then `quatOnes` is returned as an empty array.

Data Types: `single` | `double` | `int8` | `int16` | `int32` | `int64` | `uint8` | `uint16` | `uint32` | `uint64`

prototype — Quaternion prototype

variable

Quaternion prototype, specified as a variable.

Example: `ones(2,'like',quat,'quaternion')` returns a 2-by-2 matrix of quaternions with the same underlying class as the prototype quaternion, `quat`.

Data Types: `quaternion`

sz1, ..., szN — Size of each dimension

two or more integer values

Size of each dimension, specified as two or more integers. If the size of any dimension is 0 or negative, then `quatOnes` is returned as an empty array.

Example: `ones(2,3,'quaternion')` returns a 2-by-3 matrix of quaternions with the real parts set to 1 and the imaginary parts set to 0.

Data Types: `single` | `double` | `int8` | `int16` | `int32` | `int64` | `uint8` | `uint16` | `uint32` | `uint64`

Output Arguments

quat0nes — Quaternion ones

`scalar` | `vector` | `matrix` | multidimensional array

Quaternion ones, returned as a scalar, vector, matrix, or multidimensional array of quaternions.

Given a quaternion of the form $Q = a + bi + cj + dk$, a quaternion one is defined as $Q = 1 + 0i + 0j + 0k$.

Data Types: `quaternion`

Version History

Introduced in R2020a

Extended Capabilities

C/C++ Code Generation

Generate C and C++ code using MATLAB® Coder™.

See Also

Functions

`zeros`

Objects

`quaternion`

Topics

“Rotations, Orientations, and Quaternions for Automated Driving”

parts

Extract quaternion parts

Syntax

```
[a,b,c,d] = parts(quat)
```

Description

`[a,b,c,d] = parts(quat)` returns the parts of the quaternion array as arrays, each the same size as `quat`.

Examples

Convert Quaternion to Matrix of Quaternion Parts

Convert a quaternion representation to parts using the `parts` function.

Create a two-element column vector of quaternions by specifying the parts.

```
quat = quaternion([1:4;5:8])
quat = 2x1 quaternion array
    1 + 2i + 3j + 4k
    5 + 6i + 7j + 8k
```

Recover the parts from the quaternion matrix using the `parts` function. The parts are returned as separate output arguments, each the same size as the input 2-by-1 column vector of quaternions.

```
[qA,qB,qC,qD] = parts(quat)
```

```
qA = 2x1
```

```
    1
    5
```

```
qB = 2x1
```

```
    2
    6
```

```
qC = 2x1
```

```
    3
    7
```

```
qD = 2x1
```

4
8

Input Arguments

quat — Quaternion

scalar | vector | matrix | multidimensional array

Quaternion, specified as a quaternion or array of quaternions.

Data Types: quaternion

Output Arguments

[a, b, c, d] — Quaternion parts

scalar | vector | matrix | multidimensional array

Quaternion parts, returned as four arrays: a, b, c, and d. Each part is the same size as quat.

Data Types: single | double

Version History

Introduced in R2020a

Extended Capabilities

C/C++ Code Generation

Generate C and C++ code using MATLAB® Coder™.

See Also

Functions

classUnderlying | compact

Objects

quaternion

Topics

“Rotations, Orientations, and Quaternions for Automated Driving”

power, .^

Element-wise quaternion power

Syntax

`C = A.^b`

Description

`C = A.^b` raises each element of `A` to the corresponding power in `b`.

Examples

Raise a Quaternion to a Real Scalar Power

Create a quaternion and raise it to a real scalar power.

```
A = quaternion(1,2,3,4)
```

```
A = quaternion
    1 + 2i + 3j + 4k
```

```
b = 3;
C = A.^b
```

```
C = quaternion
   -86 - 52i - 78j - 104k
```

Raise a Quaternion Array to Powers from a Multidimensional Array

Create a 2-by-1 quaternion array and raise it to powers from a 2-D array.

```
A = quaternion([1:4;5:8])
```

```
A = 2x1 quaternion array
    1 + 2i + 3j + 4k
    5 + 6i + 7j + 8k
```

```
b = [1 0 2; 3 2 1]
```

```
b = 2x3
```

```
    1    0    2
    3    2    1
```

```
C = A.^b
```

$C = 2 \times 3$ quaternion array

1 +	2i +	3j +	4k	1 +	0i +	0j +	0k	-28 +	4i +	6j +
-2110 -	444i -	518j -	592k	-124 +	60i +	70j +	80k	5 +	6i +	7j +

Input Arguments

A — Base

scalar | vector | matrix | multidimensional array

Base, specified as a scalar, vector, matrix, or multidimensional array.

Data Types: quaternion | single | double

b — Exponent

scalar | vector | matrix | multidimensional array

Exponent, specified as a real scalar, vector, matrix, or multidimensional array.

Data Types: single | double

Output Arguments

C — Result

scalar | vector | matrix | multidimensional array

Each element of quaternion A raised to the corresponding power in b, returned as a scalar, vector, matrix, or multidimensional array.

Data Types: quaternion

Algorithms

The polar representation of a quaternion $A = a + bi + cj + dk$ is given by

$$A = \|A\|(\cos\theta + \hat{u}\sin\theta)$$

where θ is the angle of rotation, and \hat{u} is the unit quaternion.

Quaternion A raised by a real exponent b is given by

$$P = A.^b = \|A\|^b(\cos(b\theta) + \hat{u}\sin(b\theta))$$

Version History

Introduced in R2020a

Extended Capabilities

C/C++ Code Generation

Generate C and C++ code using MATLAB® Coder™.

See Also

Functions

log | exp

Objects

quaternion

Topics

“Rotations, Orientations, and Quaternions for Automated Driving”

prod

Product of a quaternion array

Syntax

```
quatProd = prod(quat)
quatProd = prod(quat,dim)
```

Description

`quatProd = prod(quat)` returns the quaternion product of the elements of the array.

`quatProd = prod(quat,dim)` calculates the quaternion product along dimension `dim`.

Examples

Product of Quaternions in Each Column

Create a 3-by-3 array whose elements correspond to their linear indices.

```
A = reshape(quaternion(randn(9,4)),3,3)
```

```
A = 3x3 quaternion array
    0.53767 + 2.7694i + 1.409j - 0.30344k    0.86217 + 0.7254i - 1.2075j + 0.888
    1.8339 - 1.3499i + 1.4172j + 0.29387k    0.31877 - 0.063055i + 0.71724j - 1.147
    -2.2588 + 3.0349i + 0.6715j - 0.78728k    -1.3077 + 0.71474i + 1.6302j - 1.068
```

Find the product of the quaternions in each column. The length of the first dimension is 1, and the length of the second dimension matches `size(A,2)`.

```
B = prod(A)
```

```
B = 1x3 quaternion array
    -19.837 - 9.1521i + 15.813j - 19.918k    -5.4708 - 0.28535i + 3.077j - 1.2295k
```

Product of Specified Dimension of Quaternion Array

You can specify which dimension of a quaternion array to take the product of.

Create a 2-by-2-by-2 quaternion array.

```
A = reshape(quaternion(randn(8,4)),2,2,2);
```

Find the product of the elements in each page of the array. The length of the first dimension matches `size(A,1)`, the length of the second dimension matches `size(A,2)`, and the length of the third dimension is 1.

```

dim = 3;
B = prod(A,dim)

B = 2x2 quaternion array
    -2.4847 + 1.1659i - 0.37547j + 2.8068k    0.28786 - 0.29876i - 0.51231j - 4.2972k
    0.38986 - 3.6606i - 2.0474j - 6.047k    -1.741 - 0.26782i + 5.4346j + 4.1452k

```

Input Arguments

quat — Quaternion

scalar | vector | matrix | multidimensional array

Quaternion, specified as scalar, vector, matrix, or multidimensional array of quaternions.

Example: `quatProd = prod(quat)` calculates the quaternion product along the first non-singleton dimension of `quat`.

Data Types: quaternion

dim — Dimension

first non-singleton dimension (default) | positive integer

Dimension along which to calculate the quaternion product, specified as a positive integer. If `dim` is not specified, `prod` operates along the first non-singleton dimension of `quat`.

Data Types: single | double | int8 | int16 | int32 | int64 | uint8 | uint16 | uint32 | uint64

Output Arguments

quatProd — Quaternion product

positive integer

Quaternion product, returned as quaternion array with one less non-singleton dimension than `quat`.

For example, if `quat` is a 2-by-2-by-5 array,

- `prod(quat,1)` returns a 1-by-2-by-5 array.
- `prod(quat,2)` returns a 2-by-1-by-5 array.
- `prod(quat,3)` returns a 2-by-2 array.

Data Types: quaternion

Version History

Introduced in R2020a

Extended Capabilities

C/C++ Code Generation

Generate C and C++ code using MATLAB® Coder™.

See Also

Functions

`mtimes | .* , times`

Objects

`quaternion`

Topics

“Rotations, Orientations, and Quaternions for Automated Driving”

rdivide, ./

Element-wise quaternion right division

Syntax

$C = A ./ B$

Description

$C = A ./ B$ performs quaternion element-wise division by dividing each element of quaternion A by the corresponding element of quaternion B.

Examples

Divide a Quaternion Array by a Real Scalar

Create a 2-by-1 quaternion array, and divide it element-by-element by a real scalar.

```
A = quaternion([1:4;5:8])
```

```
A = 2x1 quaternion array
    1 + 2i + 3j + 4k
    5 + 6i + 7j + 8k
```

```
B = 2;
C = A./B
```

```
C = 2x1 quaternion array
    0.5 + 1i + 1.5j + 2k
    2.5 + 3i + 3.5j + 4k
```

Divide a Quaternion Array by Another Quaternion Array

Create a 2-by-2 quaternion array, and divide it element-by-element by another 2-by-2 quaternion array.

```
q1 = quaternion(magic(4));
A = reshape(q1,2,2)
```

```
A = 2x2 quaternion array
    16 + 2i + 3j + 13k    9 + 7i + 6j + 12k
    5 + 11i + 10j + 8k   4 + 14i + 15j + 1k
```

```
q2 = quaternion([1:4;3:6;2:5;4:7]);
B = reshape(q2,2,2)
```

B = 2x2 quaternion array

$$\begin{array}{cc} 1 + 2i + 3j + 4k & 2 + 3i + 4j + 5k \\ 3 + 4i + 5j + 6k & 4 + 5i + 6j + 7k \end{array}$$

C = A./B

C = 2x2 quaternion array

$$\begin{array}{cccc} 2.7 - & 0.1i - & 2.1j - & 1.7k \\ 1.8256 - 0.081395i + & 0.45349j - & 0.24419k & 2.2778 + 0.092593i - 0.46296j - 0.5740 \\ & & & 1.4524 - 0.5i + 1.0238j - 0.261 \end{array}$$

Input Arguments

A — Dividend

scalar | vector | matrix | multidimensional array

Dividend, specified as a quaternion, an array of quaternions, a real scalar, or an array of real numbers.

A and B must have compatible sizes. In the simplest cases, they can be the same size or one can be a scalar. Two inputs have compatible sizes if, for every dimension, the dimension sizes of the inputs are the same or one of the dimensions is 1.

Data Types: quaternion | single | double

B — Divisor

scalar | vector | matrix | multidimensional array

Divisor, specified as a quaternion, an array of quaternions, a real scalar, or an array of real numbers.

A and B must have compatible sizes. In the simplest cases, they can be the same size or one can be a scalar. Two inputs have compatible sizes if, for every dimension, the dimension sizes of the inputs are the same or one of the dimensions is 1.

Data Types: quaternion | single | double

Output Arguments

C — Result

scalar | vector | matrix | multidimensional array

Result of quaternion division, returned as a scalar, vector, matrix, or multidimensional array.

Data Types: quaternion

Algorithms

Quaternion Division

Given a quaternion $A = a_1 + a_2i + a_3j + a_4k$ and a real scalar p ,

$$C = A ./ p = \frac{a_1}{p} + \frac{a_2}{p}i + \frac{a_3}{p}j + \frac{a_4}{p}k$$

Note For a real scalar p , $A./p = A.\backslash p$.

Quaternion Division by a Quaternion Scalar

Given two quaternions A and B of compatible sizes,

$$C = A ./ B = A .* B^{-1} = A .* \left(\frac{\text{conj}(B)}{\text{norm}(B)^2} \right)$$

Version History

Introduced in R2020a

Extended Capabilities

C/C++ Code Generation

Generate C and C++ code using MATLAB® Coder™.

See Also

Functions

`conj` | `./`, `ldivide` | `norm` | `.*`, `times`

Objects

`quaternion`

Topics

“Rotations, Orientations, and Quaternions for Automated Driving”

randrot

Uniformly distributed random rotations

Syntax

```
R = randrot
R = randrot(m)
R = randrot(m1, ..., mN)
R = randrot([m1, ..., mN])
```

Description

`R = randrot` returns a unit quaternion drawn from a uniform distribution of random rotations.

`R = randrot(m)` returns an m -by- m matrix of unit quaternions drawn from a uniform distribution of random rotations.

`R = randrot(m1, ..., mN)` returns an $m1$ -by-...-by- mN array of random unit quaternions, where $m1, \dots, mN$ indicate the size of each dimension. For example, `randrot(3, 4)` returns a 3-by-4 matrix of random unit quaternions.

`R = randrot([m1, ..., mN])` returns an $m1$ -by-...-by- mN array of random unit quaternions, where $m1, \dots, mN$ indicate the size of each dimension. For example, `randrot([3, 4])` returns a 3-by-4 matrix of random unit quaternions.

Examples

Matrix of Random Rotations

Generate a 3-by-3 matrix of uniformly distributed random rotations.

```
r = randrot(3)
```

```
r = 3x3 quaternion array
```

```
    0.17446 + 0.59506i - 0.73295j + 0.27976k    0.69704 - 0.060589i + 0.68679j - 0.19699k
    0.21908 - 0.89875i - 0.298j + 0.23548k    -0.049744 + 0.59691i + 0.56459j + 0.56789k
    0.6375 + 0.49338i - 0.24049j + 0.54068k    0.2979 - 0.53568i + 0.31819j + 0.72329k
```

Create Uniform Distribution of Random Rotations

Create a vector of 500 random quaternions. Use `rotatepoint` to visualize the distribution of the random rotations applied to point (1, 0, 0).

```
q = randrot(500, 1);
```

```
pt = rotatepoint(q, [1 0 0]);
```



```
figure
scatter3(pt(:,1), pt(:,2), pt(:,3))
axis equal
```

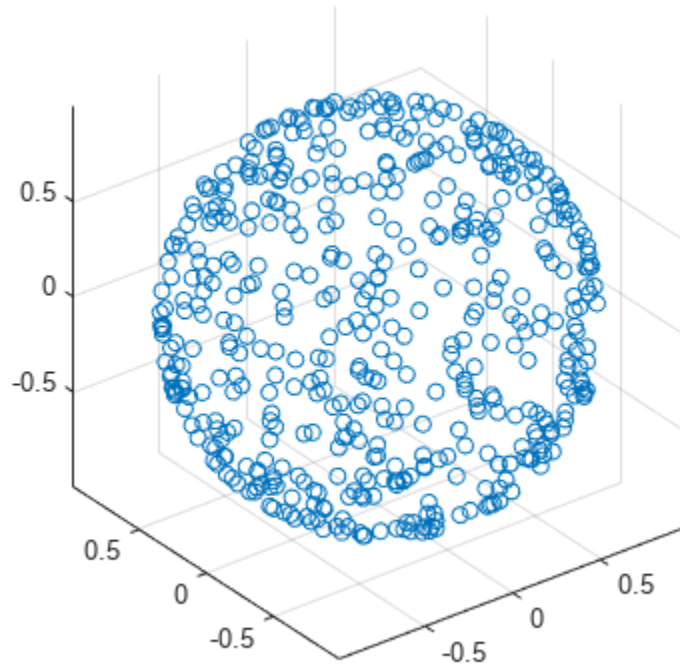

Input Arguments

m — Size of square matrix

integer

Size of square quaternion matrix, specified as an integer value. If *m* is 0 or negative, then *R* is returned as an empty matrix.

Data Types: single | double | int8 | int16 | int32 | int64 | uint8 | uint16 | uint32 | uint64

m1, ..., mN — Size of each dimension

two or more integer values

Size of each dimension, specified as two or more integer values. If the size of any dimension is 0 or negative, then *R* is returned as an empty array.

Example: `randrot(2,3)` returns a 2-by-3 matrix of random quaternions.

Data Types: single | double | int8 | int16 | int32 | int64 | uint8 | uint16 | uint32 | uint64

[m1, ..., mN] — Vector of size of each dimension

row vector of integer values

Vector of size of each dimension, specified as a row vector of two or more integer values. If the size of any dimension is 0 or negative, then R is returned as an empty array.

Example: `randrot([2,3])` returns a 2-by-3 matrix of random quaternions.

Data Types: `single` | `double` | `int8` | `int16` | `int32` | `int64` | `uint8` | `uint16` | `uint32` | `uint64`

Output Arguments

R — Random quaternions

`scalar` | `vector` | `matrix` | `multidimensional array`

Random quaternions, returned as a quaternion or array of quaternions.

Data Types: `quaternion`

Version History

Introduced in R2020a

References

[1] Shoemake, K. "Uniform Random Rotations." *Graphics Gems III* (K. David, ed.). New York: Academic Press, 1992.

Extended Capabilities

C/C++ Code Generation

Generate C and C++ code using MATLAB® Coder™.

See Also

`quaternion`

Topics

"Rotations, Orientations, and Quaternions for Automated Driving"

rotateframe

Quaternion frame rotation

Syntax

```
rotationResult = rotateframe(quat, cartesianPoints)
```

Description

`rotationResult = rotateframe(quat, cartesianPoints)` rotates the frame of reference for the Cartesian points using the quaternion, `quat`. The elements of the quaternion are normalized before use in the rotation.

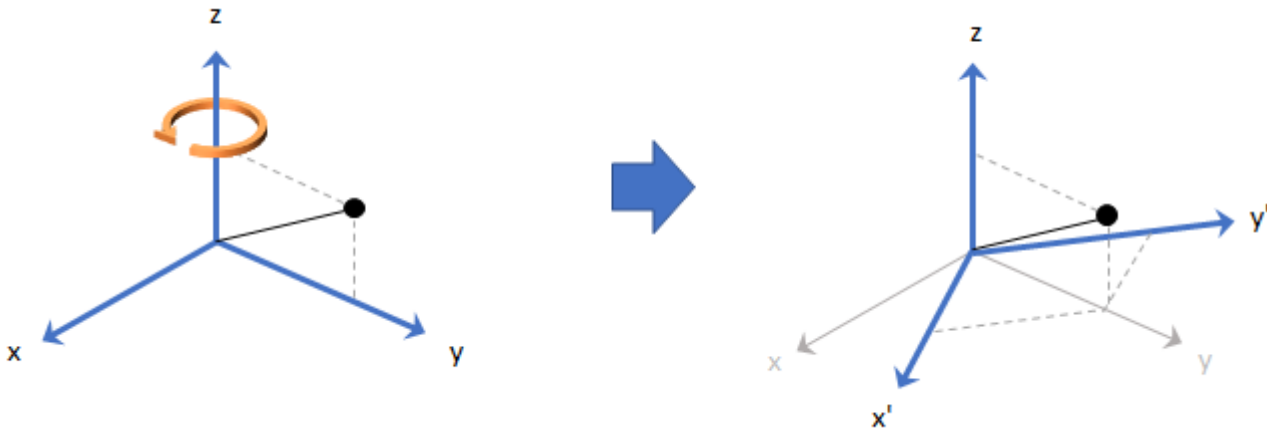

Examples

Rotate Frame Using Quaternion Vector

Define a point in three dimensions. The coordinates of a point are always specified in the order x , y , and z . For convenient visualization, define the point on the x - y plane.

```
x = 0.5;
y = 0.5;
z = 0;
plot(x,y, 'ko')
hold on
axis([-1 1 -1 1])
```

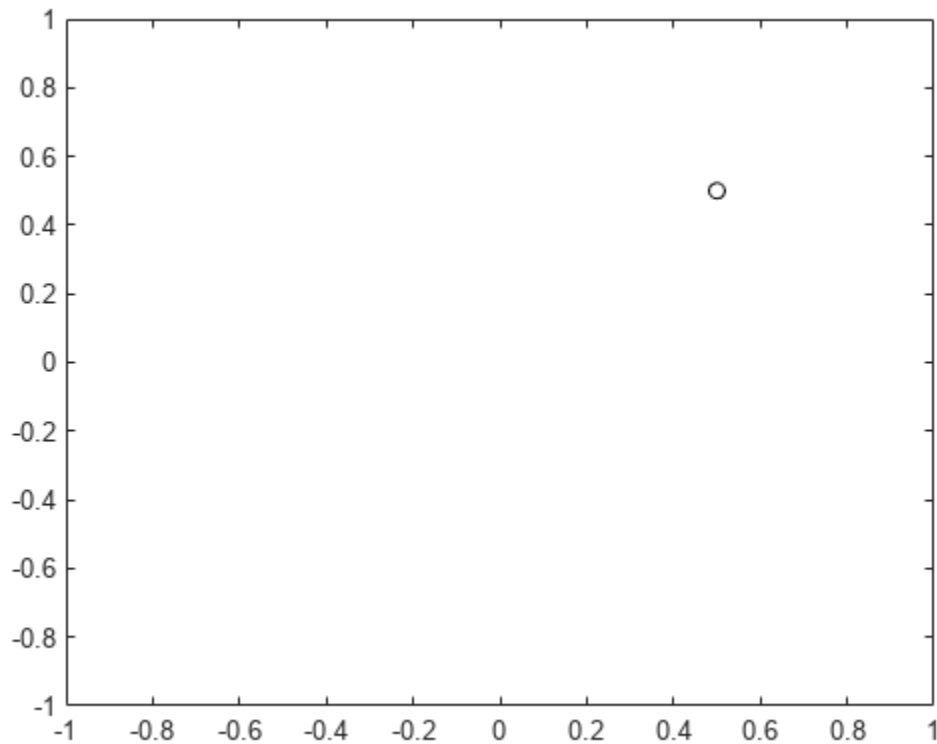

Create a quaternion vector specifying two separate rotations, one to rotate the frame 45 degrees and another to rotate the point -90 degrees about the z-axis. Use `rotateframe` to perform the rotations.

```
quat = quaternion([0,0,pi/4; ...
                  0,0,-pi/2], 'euler', 'XYZ', 'frame');
```

```
rereferencedPoint = rotateframe(quat, [x,y,z])
```

```
rereferencedPoint = 2x3
```

```
    0.7071    -0.0000     0
   -0.5000     0.5000     0
```

Plot the rereferenced points.

```
plot(rereferencedPoint(1,1),rereferencedPoint(1,2),'bo')
plot(rereferencedPoint(2,1),rereferencedPoint(2,2),'go')
```

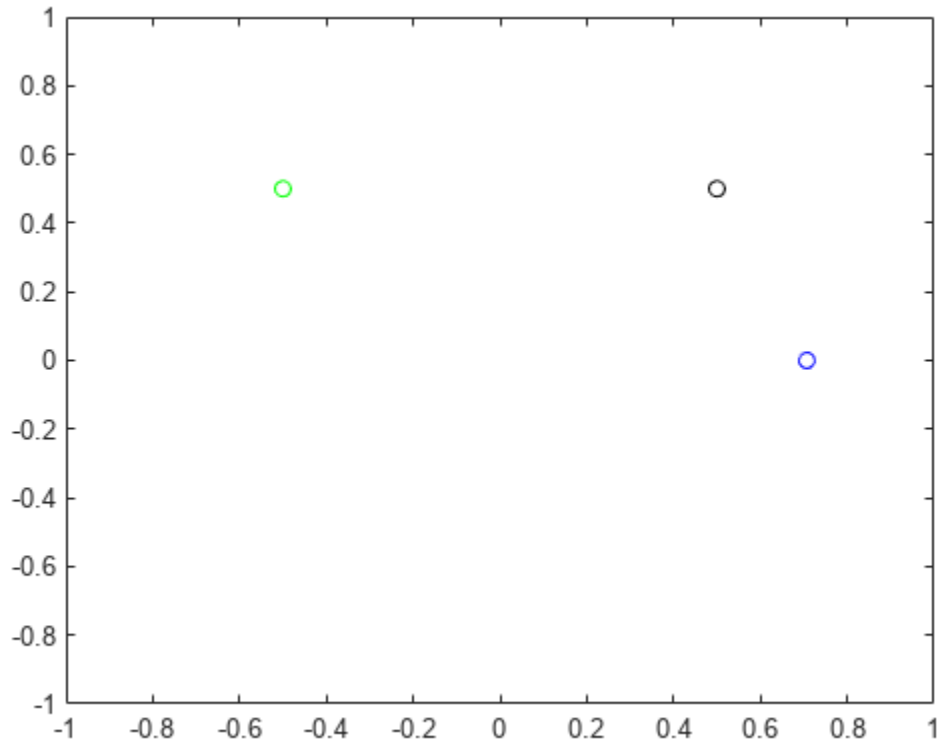

Rereference Group of Points using Quaternion

Define two points in three-dimensional space. Define a quaternion to rereference the points by first rotating the reference frame about the z-axis 30 degrees and then about the new y-axis 45 degrees.

```
a = [1,0,0];
b = [0,1,0];
quat = quaternion([30,45,0], 'eulerd', 'ZYX', 'point');
```

Use rotateframe to reference both points using the quaternion rotation operator. Display the result.

```
rP = rotateframe(quat,[a;b])
rP = 2x3
    0.6124    -0.3536    0.7071
    0.5000     0.8660   -0.0000
```

Visualize the original orientation and the rotated orientation of the points. Draw lines from the origin to each of the points for visualization purposes.

```
plot3(a(1),a(2),a(3), 'bo');
hold on
```

```

grid on
axis([-1 1 -1 1 -1 1])
xlabel('x')
ylabel('y')
zlabel('z')

plot3(b(1),b(2),b(3), 'ro');
plot3(rP(1,1),rP(1,2),rP(1,3), 'bd')
plot3(rP(2,1),rP(2,2),rP(2,3), 'rd')

plot3([0;rP(1,1)],[0;rP(1,2)],[0;rP(1,3)], 'k')
plot3([0;rP(2,1)],[0;rP(2,2)],[0;rP(2,3)], 'k')
plot3([0;a(1)],[0;a(2)],[0;a(3)], 'k')
plot3([0;b(1)],[0;b(2)],[0;b(3)], 'k')

```

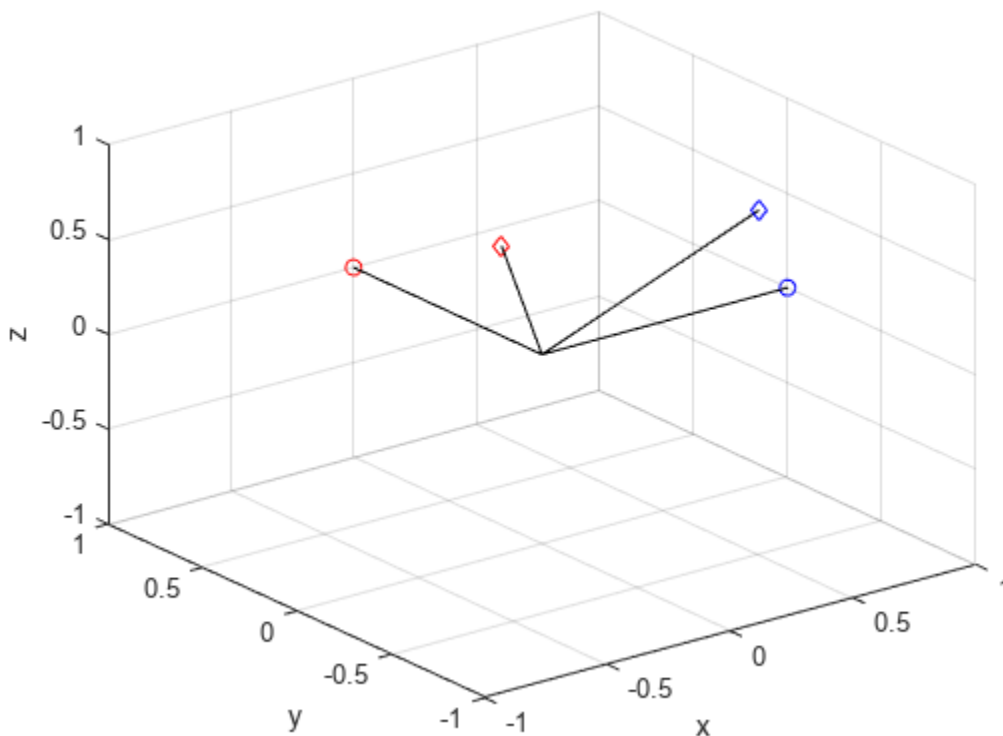

Input Arguments

quat — Quaternion that defines rotation

scalar | vector

Quaternion that defines rotation, specified as a scalar quaternion or vector of quaternions.

Data Types: quaternion

cartesianPoints — Three-dimensional Cartesian points

1-by-3 vector | N -by-3 matrix

Three-dimensional Cartesian points, specified as a 1-by-3 vector or N -by-3 matrix.

Data Types: `single` | `double`

Output Arguments

rotationResult — Re-referenced Cartesian points

vector | matrix

Cartesian points defined in reference to rotated reference frame, returned as a vector or matrix the same size as `cartesianPoints`.

The data type of the re-referenced Cartesian points is the same as the underlying data type of `quat`.

Data Types: `single` | `double`

Algorithms

Quaternion frame rotation re-references a point specified in \mathbf{R}^3 by rotating the original frame of reference according to a specified quaternion:

$$L_q(u) = q*uq$$

where q is the quaternion, $*$ represents conjugation, and u is the point to rotate, specified as a quaternion.

For convenience, the `rotateframe` function takes a point in \mathbf{R}^3 and returns a point in \mathbf{R}^3 . Given a function call with some arbitrary quaternion, $q = a + bi + cj + dk$, and arbitrary coordinate, $[x,y,z]$,

```
point = [x,y,z];
rereferencedPoint = rotateframe(q,point)
```

the `rotateframe` function performs the following operations:

- 1 Converts point $[x,y,z]$ to a quaternion:

$$u_q = 0 + xi + yj + zk$$

- 2 Normalizes the quaternion, q :

$$q_n = \frac{q}{\sqrt{a^2 + b^2 + c^2 + d^2}}$$

- 3 Applies the rotation:

$$v_q = q*u_qq$$

- 4 Converts the quaternion output, v_q , back to \mathbf{R}^3

Version History

Introduced in R2020a

Extended Capabilities

C/C++ Code Generation

Generate C and C++ code using MATLAB® Coder™.

See Also

Functions

rotatepoint

Objects

quaternion

Topics

“Rotations, Orientations, and Quaternions for Automated Driving”

rotatepoint

Quaternion point rotation

Syntax

```
rotationResult = rotatepoint(quat, cartesianPoints)
```

Description

`rotationResult = rotatepoint(quat, cartesianPoints)` rotates the Cartesian points using the quaternion, `quat`. The elements of the quaternion are normalized before use in the rotation.

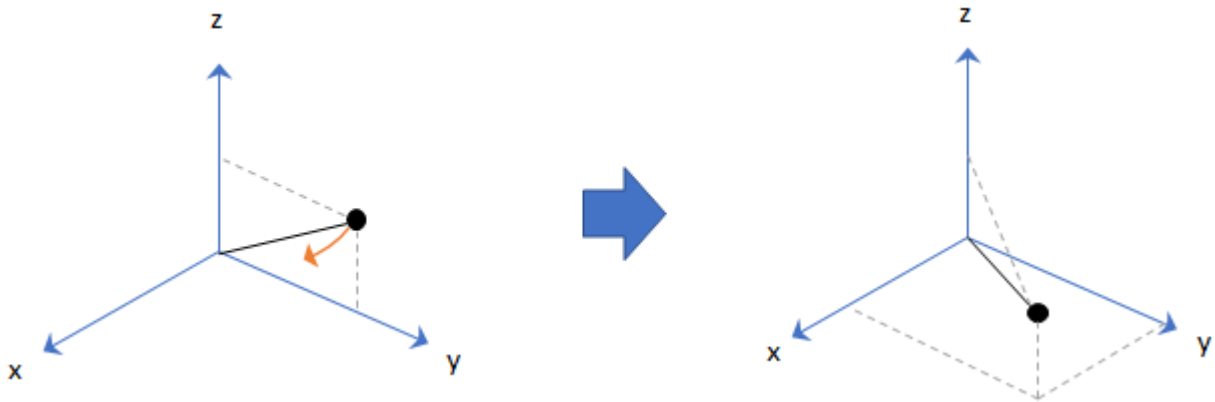

Examples

Rotate Point Using Quaternion Vector

Define a point in three dimensions. The coordinates of a point are always specified in order `x`, `y`, `z`. For convenient visualization, define the point on the `x-y` plane.

```
x = 0.5;  
y = 0.5;  
z = 0;  
  
plot(x,y, 'ko')  
hold on  
axis([-1 1 -1 1])
```

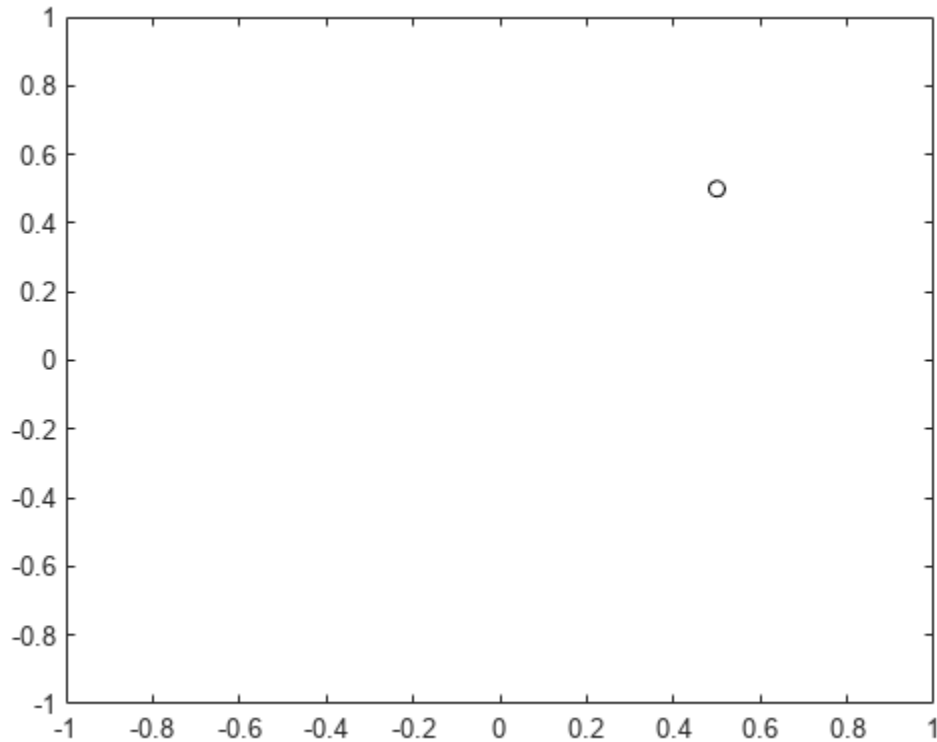

Create a quaternion vector specifying two separate rotations, one to rotate the point 45 and another to rotate the point -90 degrees about the z-axis. Use `rotatepoint` to perform the rotation.

```
quat = quaternion([0,0,pi/4; ...  
                 0,0,-pi/2], 'euler', 'XYZ', 'point');
```

```
rotatedPoint = rotatepoint(quat,[x,y,z])
```

```
rotatedPoint = 2x3
```

```
-0.0000    0.7071    0  
 0.5000   -0.5000    0
```

Plot the rotated points.

```
plot(rotatedPoint(1,1),rotatedPoint(1,2), 'bo')  
plot(rotatedPoint(2,1),rotatedPoint(2,2), 'go')
```

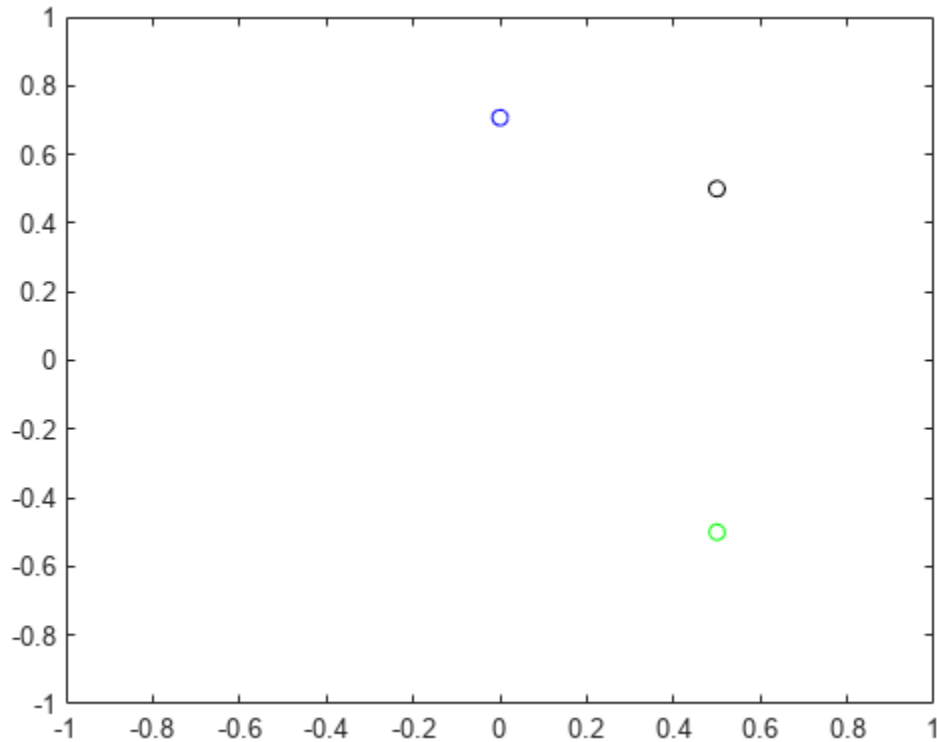

Rotate Group of Points Using Quaternion

Define two points in three-dimensional space. Define a quaternion to rotate the point by first rotating about the z-axis 30 degrees and then about the new y-axis 45 degrees.

```
a = [1,0,0];
b = [0,1,0];
quat = quaternion([30,45,0], 'eulerd', 'ZYX', 'point');
```

Use rotatepoint to rotate both points using the quaternion rotation operator. Display the result.

```
rP = rotatepoint(quat,[a;b])
rP = 2x3
    0.6124    0.5000   -0.6124
   -0.3536    0.8660    0.3536
```

Visualize the original orientation and the rotated orientation of the points. Draw lines from the origin to each of the points for visualization purposes.

```
plot3(a(1),a(2),a(3), 'bo');
hold on
```

```

grid on
axis([-1 1 -1 1 -1 1])
xlabel('x')
ylabel('y')
zlabel('z')

plot3(b(1),b(2),b(3), 'ro');
plot3(rP(1,1),rP(1,2),rP(1,3), 'bd')
plot3(rP(2,1),rP(2,2),rP(2,3), 'rd')

plot3([0;rP(1,1)],[0;rP(1,2)],[0;rP(1,3)], 'k')
plot3([0;rP(2,1)],[0;rP(2,2)],[0;rP(2,3)], 'k')
plot3([0;a(1)],[0;a(2)],[0;a(3)], 'k')
plot3([0;b(1)],[0;b(2)],[0;b(3)], 'k')

```

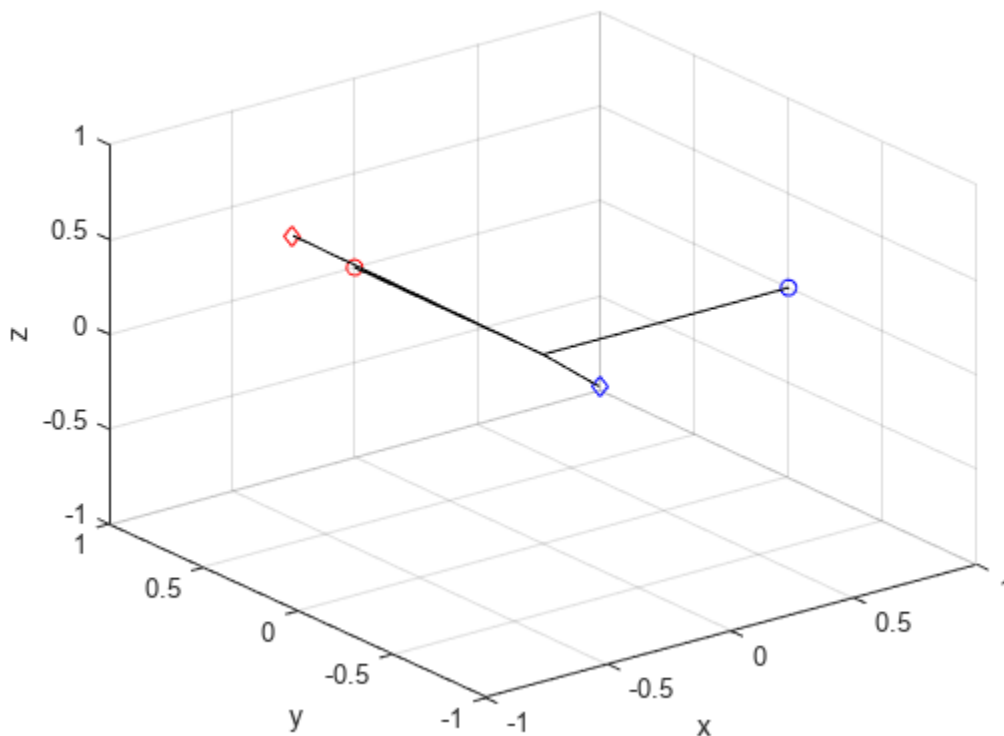

Input Arguments

quat — Quaternion that defines rotation

scalar | vector

Quaternion that defines rotation, specified as a scalar quaternion, row vector of quaternions, or column vector of quaternions.

Data Types: quaternion

cartesianPoints — Three-dimensional Cartesian points1-by-3 vector | N -by-3 matrix

Three-dimensional Cartesian points, specified as a 1-by-3 vector or N -by-3 matrix.

Data Types: `single` | `double`

Output Arguments**rotationResult — Repositioned Cartesian points**

vector | matrix

Rotated Cartesian points defined using the quaternion rotation, returned as a vector or matrix the same size as `cartesianPoints`.

Data Types: `single` | `double`

Algorithms

Quaternion point rotation rotates a point specified in \mathbf{R}^3 according to a specified quaternion:

$$L_q(u) = quq^*$$

where q is the quaternion, $*$ represents conjugation, and u is the point to rotate, specified as a quaternion.

For convenience, the `rotatepoint` function takes in a point in \mathbf{R}^3 and returns a point in \mathbf{R}^3 . Given a function call with some arbitrary quaternion, $q = a + bi + cj + dk$, and arbitrary coordinate, $[x,y,z]$, for example,

```
rereferencedPoint = rotatepoint(q,[x,y,z])
```

the `rotatepoint` function performs the following operations:

- 1 Converts point $[x,y,z]$ to a quaternion:

$$u_q = 0 + xi + yj + zk$$

- 2 Normalizes the quaternion, q :

$$q_n = \frac{q}{\sqrt{a^2 + b^2 + c^2 + d^2}}$$

- 3 Applies the rotation:

$$v_q = qu_qq^*$$

- 4 Converts the quaternion output, v_q , back to \mathbf{R}^3

Version History

Introduced in R2020a

Extended Capabilities

C/C++ Code Generation

Generate C and C++ code using MATLAB® Coder™.

See Also

Functions

rotateframe

Objects

quaternion

Topics

“Rotations, Orientations, and Quaternions for Automated Driving”

rotmat

Convert quaternion to rotation matrix

Syntax

```
rotationMatrix = rotmat(quat,rotationType)
```

Description

`rotationMatrix = rotmat(quat,rotationType)` converts the quaternion, `quat`, to an equivalent rotation matrix representation.

Examples

Convert Quaternion to Rotation Matrix for Point Rotation

Define a quaternion for use in point rotation.

```
theta = 45;
gamma = 30;
quat = quaternion([0,theta,gamma], 'eulerd', 'ZYX', 'point')

quat = quaternion
      0.8924 + 0.23912i + 0.36964j + 0.099046k
```

Convert the quaternion to a rotation matrix.

```
rotationMatrix = rotmat(quat, 'point')

rotationMatrix = 3×3

    0.7071    -0.0000    0.7071
    0.3536     0.8660   -0.3536
   -0.6124     0.5000     0.6124
```

To verify the rotation matrix, directly create two rotation matrices corresponding to the rotations about the *y*- and *x*-axes. Multiply the rotation matrices and compare to the output of `rotmat`.

```
theta = 45;
gamma = 30;

ry = [cosd(theta)  0          sind(theta) ; ...
      0            1          0          ; ...
      -sind(theta) 0          cosd(theta)];

rx = [1           0          0          ; ...
      0           cosd(gamma) -sind(gamma) ; ...
      0           sind(gamma)  cosd(gamma)];

rotationMatrixVerification = rx*ry
```

```
rotationMatrixVerification = 3×3  
  
    0.7071         0    0.7071  
    0.3536    0.8660   -0.3536  
   -0.6124    0.5000    0.6124
```

Convert Quaternion to Rotation Matrix for Frame Rotation

Define a quaternion for use in frame rotation.

```
theta = 45;  
gamma = 30;  
quat = quaternion([0,theta,gamma], 'eulerd', 'ZYX', 'frame')  
  
quat = quaternion  
    0.8924 + 0.23912i + 0.36964j - 0.099046k
```

Convert the quaternion to a rotation matrix.

```
rotationMatrix = rotmat(quat, 'frame')  
  
rotationMatrix = 3×3  
  
    0.7071   -0.0000   -0.7071  
    0.3536    0.8660    0.3536  
    0.6124   -0.5000    0.6124
```

To verify the rotation matrix, directly create two rotation matrices corresponding to the rotations about the y- and x-axes. Multiply the rotation matrices and compare to the output of rotmat.

```
theta = 45;  
gamma = 30;  
  
ry = [cosd(theta)  0          -sind(theta) ; ...  
      0           1           0          ; ...  
      sind(theta)  0          cosd(theta)];  
  
rx = [1          0          0          ; ...  
      0          cosd(gamma) sind(gamma) ; ...  
      0          -sind(gamma) cosd(gamma)];  
  
rotationMatrixVerification = rx*ry  
  
rotationMatrixVerification = 3×3  
  
    0.7071         0   -0.7071  
    0.3536    0.8660    0.3536  
    0.6124   -0.5000    0.6124
```

Convert Quaternion Vector to Rotation Matrices

Create a 3-by-1 normalized quaternion vector.

```
qVec = normalize( quaternion( randn(3,4)) );
```

Convert the quaternion array to rotation matrices. The pages of `rotmatArray` correspond to the linear index of `qVec`.

```
rotmatArray = rotmat(qVec, 'frame');
```

Assume `qVec` and `rotmatArray` correspond to a sequence of rotations. Combine the quaternion rotations into a single representation, then apply the quaternion rotation to arbitrarily initialized Cartesian points.

```
loc = normalize(randn(1,3));
quat = prod(qVec);
rotateframe(quat,loc)
```

```
ans = 1×3
```

```
    0.9524    0.5297    0.9013
```

Combine the rotation matrices into a single representation, then apply the rotation matrix to the same initial Cartesian points. Verify the quaternion rotation and rotation matrix result in the same orientation.

```
totalRotMat = eye(3);
for i = 1:size(rotmatArray,3)
    totalRotMat = rotmatArray(:,:,i)*totalRotMat;
end
totalRotMat*loc'
```

```
ans = 3×1
```

```
    0.9524
    0.5297
    0.9013
```

Input Arguments

quat — Quaternion to convert

scalar | vector | matrix | multidimensional array

Quaternion to convert, specified as a scalar, vector, matrix, or multidimensional array.

Data Types: quaternion

rotationType — Type or rotation

'frame' | 'point'

Type of rotation represented by the `rotationMatrix` output, specified as 'frame' or 'point'.

Data Types: char | string

Output Arguments

rotationMatrix — Rotation matrix representation

3-by-3 matrix | 3-by-3-by-*N* multidimensional array

Rotation matrix representation, returned as a 3-by-3 matrix or 3-by-3-by-*N* multidimensional array.

- If `quat` is a scalar, `rotationMatrix` is returned as a 3-by-3 matrix.
- If `quat` is non-scalar, `rotationMatrix` is returned as a 3-by-3-by-*N* multidimensional array, where `rotationMatrix(:, :, i)` is the rotation matrix corresponding to `quat(i)`.

The data type of the rotation matrix is the same as the underlying data type of `quat`.

Data Types: `single` | `double`

Algorithms

Given a quaternion of the form

$$q = a + bi + cj + dk,$$

the equivalent rotation matrix for frame rotation is defined as

$$\begin{bmatrix} 2a^2 - 1 + 2b^2 & 2bc + 2ad & 2bd - 2ac \\ 2bc - 2ad & 2a^2 - 1 + 2c^2 & 2cd + 2ab \\ 2bd + 2ac & 2cd - 2ab & 2a^2 - 1 + 2d^2 \end{bmatrix}.$$

The equivalent rotation matrix for point rotation is the transpose of the frame rotation matrix:

$$\begin{bmatrix} 2a^2 - 1 + 2b^2 & 2bc - 2ad & 2bd + 2ac \\ 2bc + 2ad & 2a^2 - 1 + 2c^2 & 2cd - 2ab \\ 2bd - 2ac & 2cd + 2ab & 2a^2 - 1 + 2d^2 \end{bmatrix}.$$

Version History

Introduced in R2020a

References

- [1] Kuipers, Jack B. *Quaternions and Rotation Sequences: A Primer with Applications to Orbits, Aerospace, and Virtual Reality*. Princeton, NJ: Princeton University Press, 2007.

Extended Capabilities

C/C++ Code Generation

Generate C and C++ code using MATLAB® Coder™.

See Also

Functions

rotvec | rotvecd | euler | eulerd

Objects

quaternion

Topics

“Rotations, Orientations, and Quaternions for Automated Driving”

rotvec

Convert quaternion to rotation vector (radians)

Syntax

```
rotationVector = rotvec(quat)
```

Description

`rotationVector = rotvec(quat)` converts the quaternion array, `quat`, to an N -by-3 matrix of equivalent rotation vectors in radians. The elements of `quat` are normalized before conversion.

Examples

Convert Quaternion to Rotation Vector in Radians

Convert a random quaternion scalar to a rotation vector in radians

```
quat = quaternion(randn(1,4));  
rotvec(quat)
```

```
ans = 1×3
```

```
    1.6866   -2.0774    0.7929
```

Input Arguments

quat — Quaternion to convert

scalar | vector | matrix | multidimensional array

Quaternion to convert, specified as scalar quaternion, vector, matrix, or multidimensional array of quaternions.

Data Types: quaternion

Output Arguments

rotationVector — Rotation vector (radians)

N -by-3 matrix

Rotation vector representation, returned as an N -by-3 matrix of rotations vectors, where each row represents the [X Y Z] angles of the rotation vectors in radians. The i th row of `rotationVector` corresponds to the element `quat(i)`.

The data type of the rotation vector is the same as the underlying data type of `quat`.

Data Types: single | double

Algorithms

All rotations in 3-D can be represented by a three-element axis of rotation and a rotation angle, for a total of four elements. If the rotation axis is constrained to be unit length, the rotation angle can be distributed over the vector elements to reduce the representation to three elements.

Recall that a quaternion can be represented in axis-angle form

$$q = \cos(\theta/2) + \sin(\theta/2)(xi + yj + zk),$$

where θ is the angle of rotation and $[x,y,z]$ represent the axis of rotation.

Given a quaternion of the form

$$q = a + bi + cj + dk,$$

you can solve for the rotation angle using the axis-angle form of quaternions:

$$\theta = 2\cos^{-1}(a).$$

Assuming a normalized axis, you can rewrite the quaternion as a rotation vector without loss of information by distributing θ over the parts b , c , and d . The rotation vector representation of q is

$$q_{rv} = \frac{\theta}{\sin(\theta/2)}[b, c, d].$$

Version History

Introduced in R2020a

Extended Capabilities

C/C++ Code Generation

Generate C and C++ code using MATLAB® Coder™.

See Also

Functions

rotvecd | euler | eulerd

Objects

quaternion

Topics

“Rotations, Orientations, and Quaternions for Automated Driving”

rotvecd

Convert quaternion to rotation vector (degrees)

Syntax

```
rotationVector = rotvecd(quat)
```

Description

`rotationVector = rotvecd(quat)` converts the quaternion array, `quat`, to an N -by-3 matrix of equivalent rotation vectors in degrees. The elements of `quat` are normalized before conversion.

Examples

Convert Quaternion to Rotation Vector in Degrees

Convert a random quaternion scalar to a rotation vector in degrees.

```
quat = quaternion(randn(1,4));  
rotvecd(quat)
```

```
ans = 1×3
```

```
    96.6345  -119.0274   45.4312
```

Input Arguments

quat — Quaternion to convert

scalar | vector | matrix | multidimensional array

Quaternion to convert, specified as scalar, vector, matrix, or multidimensional array of quaternions.

Data Types: quaternion

Output Arguments

rotationVector — Rotation vector (degrees)

N -by-3 matrix

Rotation vector representation, returned as an N -by-3 matrix of rotation vectors, where each row represents the $[x\ y\ z]$ angles of the rotation vectors in degrees. The i th row of `rotationVector` corresponds to the element `quat(i)`.

The data type of the rotation vector is the same as the underlying data type of `quat`.

Data Types: single | double

Algorithms

All rotations in 3-D can be represented by four elements: a three-element axis of rotation and a rotation angle. If the rotation axis is constrained to be unit length, the rotation angle can be distributed over the vector elements to reduce the representation to three elements.

Recall that a quaternion can be represented in axis-angle form

$$q = \cos(\theta/2) + \sin(\theta/2)(xi + yj + zk),$$

where θ is the angle of rotation in degrees, and $[x,y,z]$ represent the axis of rotation.

Given a quaternion of the form

$$q = a + bi + cj + dk,$$

you can solve for the rotation angle using the axis-angle form of quaternions:

$$\theta = 2\cos^{-1}(a).$$

Assuming a normalized axis, you can rewrite the quaternion as a rotation vector without loss of information by distributing θ over the parts b , c , and d . The rotation vector representation of q is

$$q_{rv} = \frac{\theta}{\sin(\theta/2)}[b, c, d].$$

Version History

Introduced in R2020a

Extended Capabilities

C/C++ Code Generation

Generate C and C++ code using MATLAB® Coder™.

See Also

Functions

rotvec | euler | eulerd

Objects

quaternion

Topics

“Rotations, Orientations, and Quaternions for Automated Driving”

slerp

Spherical linear interpolation

Syntax

```
q0 = slerp(q1,q2,T)
```

Description

`q0 = slerp(q1,q2,T)` spherically interpolates between `q1` and `q2` by the interpolation coefficient `T`. The function always chooses the shorter interpolation path between `q1` and `q2`.

Examples

Interpolate Between Two Quaternions

Create two quaternions with the following interpretation:

- 1 `a` = 45 degree rotation around the z-axis
- 2 `c` = -45 degree rotation around the z-axis

```
a = quaternion([45,0,0], 'eulerd', 'ZYX', 'frame');
c = quaternion([-45,0,0], 'eulerd', 'ZYX', 'frame');
```

Call `slerp` with the quaternions `a` and `c` and specify an interpolation coefficient of 0.5.

```
interpolationCoefficient = 0.5;
b = slerp(a,c,interpolationCoefficient);
```

The output of `slerp`, `b`, represents an average rotation of `a` and `c`. To verify, convert `b` to Euler angles in degrees.

```
averageRotation = eulerd(b, 'ZYX', 'frame')
averageRotation = 1×3
```

```
    0    0    0
```

The interpolation coefficient is specified as a normalized value between 0 and 1, inclusive. An interpolation coefficient of 0 corresponds to the `a` quaternion, and an interpolation coefficient of 1 corresponds to the `c` quaternion. Call `slerp` with coefficients 0 and 1 to confirm.

```
b = slerp(a,c,[0,1]);
eulerd(b, 'ZYX', 'frame')
```

```
ans = 2×3
```

```
45.0000    0    0
```



```
-45.0000    0    0
```

You can create smooth paths between quaternions by specifying arrays of equally spaced interpolation coefficients.

```
path = 0:0.1:1;
interpolatedQuaternions = slerp(a,c,path);
```

For quaternions that represent rotation only about a single axis, specifying interpolation coefficients as equally spaced results in quaternions equally spaced in Euler angles. Convert `interpolatedQuaternions` to Euler angles and verify that the difference between the angles in the path is constant.

```
k = eulerd(interpolatedQuaternions, 'ZYX', 'frame');
abc = abs(diff(k))
```

```
abc = 10x3
```

```
 9.0000    0    0
 9.0000    0    0
 9.0000    0    0
 9.0000    0    0
 9.0000    0    0
 9.0000    0    0
 9.0000    0    0
 9.0000    0    0
 9.0000    0    0
 9.0000    0    0
```

Alternatively, you can use the `dist` function to verify that the distance between the interpolated quaternions is consistent. The `dist` function returns angular distance in radians; convert to degrees for easy comparison.

```
def = rad2deg(dist(interpolatedQuaternions(2:end),interpolatedQuaternions(1:end-1)))
```

```
def = 1x10
```

```
 9.0000    9.0000    9.0000    9.0000    9.0000    9.0000    9.0000    9.0000    9.0000    9.
```

SLERP Minimizes Great Circle Path

The SLERP algorithm interpolates along a great circle path connecting two quaternions. This example shows how the SLERP algorithm minimizes the great circle path.

Define four quaternions:

- 1 q0 - quaternion indicating no rotation from the global frame
- 2 q179 - quaternion indicating a 179 degree rotation about the z-axis
- 3 q180 - quaternion indicating a 180 degree rotation about the z-axis

4 q181 - quaternion indicating a 181 degree rotation about the z-axis

```
q0 = ones(1, 'quaternion');  
q179 = quaternion([179,0,0], 'eulerd', 'ZYX', 'frame');  
q180 = quaternion([180,0,0], 'eulerd', 'ZYX', 'frame');  
q181 = quaternion([181,0,0], 'eulerd', 'ZYX', 'frame');
```

Use `slerp` to interpolate between `q0` and the three quaternion rotations. Specify that the paths are traveled in 10 steps.

```
T = linspace(0,1,10);  
q179path = slerp(q0,q179,T);  
q180path = slerp(q0,q180,T);  
q181path = slerp(q0,q181,T);
```

Plot each path in terms of Euler angles in degrees.

```
q179pathEuler = eulerd(q179path, 'ZYX', 'frame');  
q180pathEuler = eulerd(q180path, 'ZYX', 'frame');  
q181pathEuler = eulerd(q181path, 'ZYX', 'frame');  
  
plot(T,q179pathEuler(:,1), 'bo', ...  
      T,q180pathEuler(:,1), 'r*', ...  
      T,q181pathEuler(:,1), 'gd');  
legend('Path to 179 degrees', ...  
       'Path to 180 degrees', ...  
       'Path to 181 degrees')  
xlabel('Interpolation Coefficient')  
ylabel('Z-Axis Rotation (Degrees)')
```

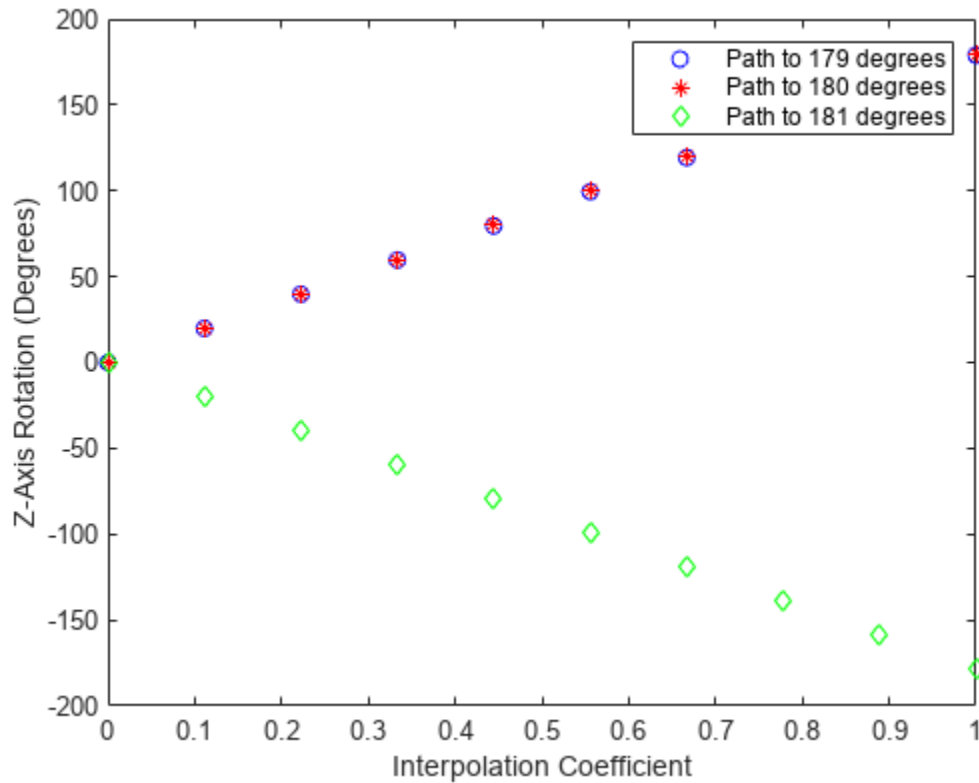

The path between q_0 and q_{179} is clockwise to minimize the great circle distance. The path between q_0 and q_{181} is counterclockwise to minimize the great circle distance. The path between q_0 and q_{180} can be either clockwise or counterclockwise, depending on numerical rounding.

Show Interpolated Quaternions on Sphere

Create two quaternions.

```
q1 = quaternion([75,-20,-10], 'eulerd', 'ZYX', 'frame');
q2 = quaternion([-45,20,30], 'eulerd', 'ZYX', 'frame');
```

Define the interpolation coefficient.

```
T = 0:0.01:1;
```

Obtain the interpolated quaternions.

```
quats = slerp(q1,q2,T);
```

Obtain the corresponding rotate points.

```
pts = rotatepoint(quats,[1 0 0]);
```

Show the interpolated quaternions on a unit sphere.

```
figure
[X,Y,Z] = sphere;
```

```
surf(X,Y,Z, 'FaceColor', [0.57 0.57 0.57])  
hold on;  
  
scatter3(pts(:,1),pts(:,2),pts(:,3))  
view([69.23 36.60])  
axis equal
```

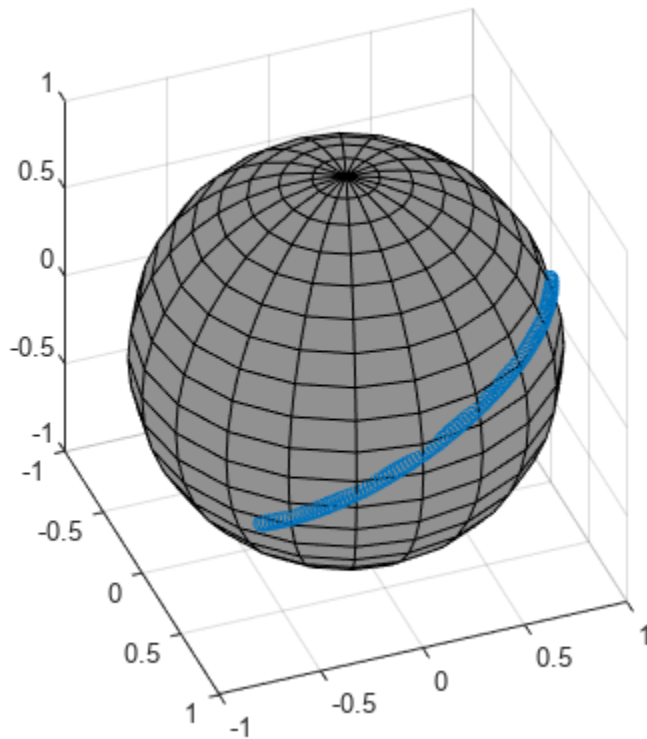

Note that the interpolated quaternions follow the shorter path from q_1 to q_2 .

Input Arguments

q1 – Quaternion

scalar | vector | matrix | multidimensional array

Quaternion to interpolate, specified as a scalar, vector, matrix, or multidimensional array of quaternions.

q_1 , q_2 , and T must have compatible sizes. In the simplest cases, they can be the same size or any one can be a scalar. Two inputs have compatible sizes if, for every dimension, the dimension sizes of the inputs are either the same or one of them is 1.

Data Types: quaternion

q2 – Quaternion

scalar | vector | matrix | multidimensional array

Quaternion to interpolate, specified as a scalar, vector, matrix, or multidimensional array of quaternions.

q_1 , q_2 , and T must have compatible sizes. In the simplest cases, they can be the same size or any one can be a scalar. Two inputs have compatible sizes if, for every dimension, the dimension sizes of the inputs are either the same or one of the dimension sizes is 1.

Data Types: quaternion

T — Interpolation coefficient

scalar | vector | matrix | multidimensional array

Interpolation coefficient, specified as a scalar, vector, matrix, or multidimensional array of numbers with each element in the range [0,1].

q_1 , q_2 , and T must have compatible sizes. In the simplest cases, they can be the same size or any one can be a scalar. Two inputs have compatible sizes if, for every dimension, the dimension sizes of the inputs are either the same or one of the dimension sizes is 1.

Data Types: single | double

Output Arguments

q0 — Interpolated quaternion

scalar | vector | matrix | multidimensional array

Interpolated quaternion, returned as a scalar, vector, matrix, or multidimensional array.

Data Types: quaternion

Algorithms

Quaternion **spherical linear interpolation** (SLERP) is an extension of linear interpolation along a plane to spherical interpolation in three dimensions. The algorithm was first proposed in [1]. Given two quaternions, q_1 and q_2 , SLERP interpolates a new quaternion, q_0 , along the great circle that connects q_1 and q_2 . The interpolation coefficient, T , determines how close the output quaternion is to either q_1 and q_2 .

The SLERP algorithm can be described in terms of sinusoids:

$$q_0 = \frac{\sin((1 - T)\theta)}{\sin(\theta)}q_1 + \frac{\sin(T\theta)}{\sin(\theta)}q_2$$

where q_1 and q_2 are normalized quaternions, and θ is half the angular distance between q_1 and q_2 .

Version History

Introduced in R2020a

References

- [1] Shoemake, Ken. "Animating Rotation with Quaternion Curves." *ACM SIGGRAPH Computer Graphics* Vol. 19, Issue 3, 1985, pp. 245–254.

Extended Capabilities

C/C++ Code Generation

Generate C and C++ code using MATLAB® Coder™.

See Also

Functions

`dist` | `meanrot`

Objects

`quaternion`

Topics

“Rotations, Orientations, and Quaternions for Automated Driving”

times, .*

Element-wise quaternion multiplication

Syntax

```
quatC = A.*B
```

Description

`quatC = A.*B` returns the element-by-element quaternion multiplication of quaternion arrays.

You can use quaternion multiplication to compose rotation operators:

- To compose a sequence of frame rotations, multiply the quaternions in the same order as the desired sequence of rotations. For example, to apply a p quaternion followed by a q quaternion, multiply in the order pq . The rotation operator becomes $(pq)^*v(pq)$, where v represents the object to rotate in quaternion form. `*` represents conjugation.
- To compose a sequence of point rotations, multiply the quaternions in the reverse order of the desired sequence of rotations. For example, to apply a p quaternion followed by a q quaternion, multiply in the reverse order, qp . The rotation operator becomes $(qp)v(qp)^*$.

Examples

Multiply Two Quaternion Vectors

Create two vectors, A and B, and multiply them element by element.

```
A = quaternion([1:4;5:8]);
B = A;
C = A.*B

C = 2x1 quaternion array
    -28 + 4i + 6j + 8k
   -124 + 60i + 70j + 80k
```

Multiply Two Quaternion Arrays

Create two 3-by-3 arrays, A and B, and multiply them element by element.

```
A = reshape(quaternion(randn(9,4)),3,3);
B = reshape(quaternion(randn(9,4)),3,3);
C = A.*B

C = 3x3 quaternion array
    0.60169 + 2.4332i - 2.5844j + 0.51646k   -0.49513 + 1.1722i + 4.4401j - 1.217k
   -4.2329 + 2.4547i + 3.7768j + 0.77484k   -0.65232 - 0.43112i - 1.4645j - 0.90073k
```

```
-4.4159 + 2.1926i + 1.9037j - 4.0303k    -2.0232 + 0.4205i - 0.17288j + 3.8529k    -
```

Note that quaternion multiplication is not commutative:

```
isequal(C,B.*A)
```

```
ans = logical
      0
```

Multiply Quaternion Row and Column Vectors

Create a row vector `a` and a column vector `b`, then multiply them. The 1-by-3 row vector and 4-by-1 column vector combine to produce a 4-by-3 matrix with all combinations of elements multiplied.

```
a = [zeros('quaternion'),ones('quaternion'),quaternion(randn(1,4))]
```

```
a = 1x3 quaternion array
      0 + 0i + 0j + 0k      1 + 0i + 0j + 0k      0
```

```
b = quaternion(randn(4,4))
```

```
b = 4x1 quaternion array
      0.31877 + 3.5784i + 0.7254j - 0.12414k
      -1.3077 + 2.7694i - 0.063055j + 1.4897k
      -0.43359 - 1.3499i + 0.71474j + 1.409k
      0.34262 + 3.0349i - 0.20497j + 1.4172k
```

```
a.*b
```

```
ans = 4x3 quaternion array
      0 + 0i + 0j + 0k      0.31877 + 3.5784i + 0.7254j - 0.12414k
      0 + 0i + 0j + 0k      -1.3077 + 2.7694i - 0.063055j + 1.4897k
      0 + 0i + 0j + 0k      -0.43359 - 1.3499i + 0.71474j + 1.409k
      0 + 0i + 0j + 0k      0.34262 + 3.0349i - 0.20497j + 1.4172k
```

Input Arguments

A — Array to multiply

scalar | vector | matrix | multidimensional array

Array to multiply, specified as a quaternion, an array of quaternions, a real scalar, or an array of real numbers.

A and B must have compatible sizes. In the simplest cases, they can be the same size or one can be a scalar. Two inputs have compatible sizes if, for every dimension, the dimension sizes of the inputs are the same or one of them is 1.

Data Types: quaternion | single | double

B – Array to multiply

scalar | vector | matrix | multidimensional array

Array to multiply, specified as a quaternion, an array of quaternions, a real scalar, or an array of real numbers.

A and B must have compatible sizes. In the simplest cases, they can be the same size or one can be a scalar. Two inputs have compatible sizes if, for every dimension, the dimension sizes of the inputs are the same or one of them is 1.

Data Types: quaternion | single | double

Output Arguments**quatC – Quaternion product**

scalar | vector | matrix | multidimensional array

Quaternion product, returned as a scalar, vector, matrix, or multidimensional array.

Data Types: quaternion

Algorithms**Quaternion Multiplication by a Real Scalar**

Given a quaternion,

$$q = a_q + b_q i + c_q j + d_q k,$$

the product of q and a real scalar β is

$$\beta q = \beta a_q + \beta b_q i + \beta c_q j + \beta d_q k$$

Quaternion Multiplication by a Quaternion Scalar

The definition of the basis elements for quaternions,

$$i^2 = j^2 = k^2 = ijk = -1,$$

can be expanded to populate a table summarizing quaternion basis element multiplication:

	1	i	j	k
1	1	i	j	k
i	i	-1	k	-j
j	j	-k	-1	i
k	k	j	-i	-1

When reading the table, the rows are read first, for example: $ij = k$ and $ji = -k$.

Given two quaternions, $q = a_q + b_q i + c_q j + d_q k$, and $p = a_p + b_p i + c_p j + d_p k$, the multiplication can be expanded as:

$$\begin{aligned}z &= pq = (a_p + b_p i + c_p j + d_p k)(a_q + b_q i + c_q j + d_q k) \\&= a_p a_q + a_p b_q i + a_p c_q j + a_p d_q k \\&\quad + b_p a_q i + b_p b_q i^2 + b_p c_q ij + b_p d_q ik \\&\quad + c_p a_q j + c_p b_q ji + c_p c_q j^2 + c_p d_q jk \\&\quad + d_p a_q k + d_p b_q ki + d_p c_q kj + d_p d_q k^2\end{aligned}$$

You can simplify the equation using the quaternion multiplication table.

$$\begin{aligned}z = pq &= a_p a_q + a_p b_q i + a_p c_q j + a_p d_q k \\&\quad + b_p a_q i - b_p b_q + b_p c_q k - b_p d_q j \\&\quad + c_p a_q j - c_p b_q k - c_p c_q + c_p d_q i \\&\quad + d_p a_q k + d_p b_q j - d_p c_q i - d_p d_q\end{aligned}$$

Version History

Introduced in R2020a

References

- [1] Kuipers, Jack B. *Quaternions and Rotation Sequences: A Primer with Applications to Orbits, Aerospace, and Virtual Reality*. Princeton, NJ: Princeton University Press, 2007.

Extended Capabilities

C/C++ Code Generation

Generate C and C++ code using MATLAB® Coder™.

See Also

Functions

prod | mtimes, *

Objects

quaternion

Topics

“Rotations, Orientations, and Quaternions for Automated Driving”

transpose, .'

Transpose a quaternion array

Syntax

`Y = quat.'`

Description

`Y = quat.'` returns the non-conjugate transpose of the quaternion array, `quat`.

Examples

Vector Transpose

Create a vector of quaternions and compute its nonconjugate transpose.

```
quat = quaternion(randn(4,4))
```

```
quat = 4x1 quaternion array
    0.53767 + 0.31877i + 3.5784j + 0.7254k
    1.8339 - 1.3077i + 2.7694j - 0.063055k
   -2.2588 - 0.43359i - 1.3499j + 0.71474k
    0.86217 + 0.34262i + 3.0349j - 0.20497k
```

```
quatTransposed = quat.'
```

```
quatTransposed = 1x4 quaternion array
    0.53767 + 0.31877i + 3.5784j + 0.7254k    1.8339 - 1.3077i + 2.7694j - 0.063055k
```

Matrix Transpose

Create a matrix of quaternions and compute its nonconjugate transpose.

```
quat = [quaternion(randn(2,4)), quaternion(randn(2,4))]
```

```
quat = 2x2 quaternion array
    0.53767 - 2.2588i + 0.31877j - 0.43359k    3.5784 - 1.3499i + 0.7254j + 0.71474k
    1.8339 + 0.86217i - 1.3077j + 0.34262k    2.7694 + 3.0349i - 0.063055j - 0.20497k
```

```
quatTransposed = quat.'
```

```
quatTransposed = 2x2 quaternion array
    0.53767 - 2.2588i + 0.31877j - 0.43359k    1.8339 + 0.86217i - 1.3077j + 0.34262k
    3.5784 - 1.3499i + 0.7254j + 0.71474k    2.7694 + 3.0349i - 0.063055j - 0.20497k
```

Input Arguments

quat — Quaternion array to transpose

vector | matrix

Quaternion array to transpose, specified as a vector or matrix of quaternions. `transpose` is defined for 1-D and 2-D arrays. For higher-order arrays, use `permute`.

Data Types: quaternion

Output Arguments

Y — Transposed quaternion array

vector | matrix

Transposed quaternion array, returned as an N -by- M array, where `quat` was specified as an M -by- N array.

Version History

Introduced in R2020a

Extended Capabilities

C/C++ Code Generation

Generate C and C++ code using MATLAB® Coder™.

See Also

Functions

`ctranspose`, '

Objects

quaternion

Topics

"Rotations, Orientations, and Quaternions for Automated Driving"

uMinus, -

Quaternion unary minus

Syntax

```
mQuat = -quat
```

Description

mQuat = -quat negates the elements of quat and stores the result in mQuat.

Examples

Negate Elements of Quaternion Matrix

Unary minus negates each part of a the quaternion. Create a 2-by-2 matrix, Q.

```
Q = quaternion(randn(2),randn(2),randn(2),randn(2))
```

Q = 2x2 quaternion array

```
    0.53767 + 0.31877i + 3.5784j + 0.7254k    -2.2588 - 0.43359i - 1.3499j + 0.7147k
    1.8339 - 1.3077i + 2.7694j - 0.063055k    0.86217 + 0.34262i + 3.0349j - 0.2049k
```

Negate the parts of each quaternion in Q.

```
R = -Q
```

R = 2x2 quaternion array

```
   -0.53767 - 0.31877i - 3.5784j - 0.7254k     2.2588 + 0.43359i + 1.3499j - 0.7147k
   -1.8339 + 1.3077i - 2.7694j + 0.063055k   -0.86217 - 0.34262i - 3.0349j + 0.2049k
```

Input Arguments

quat — Quaternion array

scalar | vector | matrix | multidimensional array

Quaternion array, specified as a scalar, vector, matrix, or multidimensional array.

Data Types: quaternion

Output Arguments

mQuat — Negated quaternion array

scalar | vector | matrix | multidimensional array

Negated quaternion array, returned as the same size as quat.

Data Types: quaternion

Version History

Introduced in R2020a

Extended Capabilities

C/C++ Code Generation

Generate C and C++ code using MATLAB® Coder™.

See Also

Functions

minus, -

Objects

quaternion

Topics

“Rotations, Orientations, and Quaternions for Automated Driving”

zeros

Create quaternion array with all parts set to zero

Syntax

```
quatZeros = zeros('quaternion')
quatZeros = zeros(n,'quaternion')
quatZeros = zeros(sz,'quaternion')
quatZeros = zeros(sz1,...,szN,'quaternion')

quatZeros = zeros( ____, 'like', prototype, 'quaternion')
```

Description

`quatZeros = zeros('quaternion')` returns a scalar quaternion with all parts set to zero.

`quatZeros = zeros(n,'quaternion')` returns an n-by-n matrix of quaternions.

`quatZeros = zeros(sz,'quaternion')` returns an array of quaternions where the size vector, `sz`, defines `size(quatZeros)`.

`quatZeros = zeros(sz1,...,szN,'quaternion')` returns a `sz1`-by-...-by-`szN` array of quaternions where `sz1`, ..., `szN` indicates the size of each dimension.

`quatZeros = zeros(____, 'like', prototype, 'quaternion')` specifies the underlying class of the returned quaternion array to be the same as the underlying class of the quaternion prototype.

Examples

Quaternion Scalar Zero

Create a quaternion scalar zero.

```
quatZeros = zeros('quaternion')

quatZeros = quaternion
           0 + 0i + 0j + 0k
```

Square Matrix of Quaternions

Create an n-by-n array of quaternion zeros.

```
n = 3;
quatZeros = zeros(n,'quaternion')

quatZeros = 3x3 quaternion array
           0 + 0i + 0j + 0k     0 + 0i + 0j + 0k     0 + 0i + 0j + 0k
```

```

0 + 0i + 0j + 0k    0 + 0i + 0j + 0k    0 + 0i + 0j + 0k
0 + 0i + 0j + 0k    0 + 0i + 0j + 0k    0 + 0i + 0j + 0k

```

Multidimensional Array of Quaternion Zeros

Create a multidimensional array of quaternion zeros by defining array dimensions in order. In this example, you create a 3-by-1-by-2 array. You can specify dimensions using a row vector or comma-separated integers.

Specify the dimensions using a row vector and display the results:

```

dims = [3,1,2];
quatZerosSyntax1 = zeros(dims, 'quaternion')

```

```

quatZerosSyntax1 = 3x1x2 quaternion array
quatZerosSyntax1(:,:,1) =

```

```

0 + 0i + 0j + 0k
0 + 0i + 0j + 0k
0 + 0i + 0j + 0k

```

```

quatZerosSyntax1(:,:,2) =

```

```

0 + 0i + 0j + 0k
0 + 0i + 0j + 0k
0 + 0i + 0j + 0k

```

Specify the dimensions using comma-separated integers, and then verify the equivalence of the two syntaxes:

```

quatZerosSyntax2 = zeros(3,1,2, 'quaternion');
isequal(quatZerosSyntax1, quatZerosSyntax2)

```

```

ans = logical
     1

```

Underlying Class of Quaternion Zeros

A quaternion is a four-part hyper-complex number used in three-dimensional representations. You can specify the underlying data type of the parts as `single` or `double`. The default is `double`.

Create a quaternion array of zeros with the underlying data type set to `single`.

```

quatZeros = zeros(2, 'like', single(1), 'quaternion')

```

```

quatZeros = 2x2 quaternion array
0 + 0i + 0j + 0k    0 + 0i + 0j + 0k
0 + 0i + 0j + 0k    0 + 0i + 0j + 0k

```

Verify the underlying class using the `classUnderlying` function.

```
classUnderlying(quatZeros)

ans =
'single'
```

Input Arguments

n — Size of square quaternion matrix

integer value

Size of square quaternion matrix, specified as an integer value. If `n` is 0 or negative, then `quatZeros` is returned as an empty matrix.

Example: `zeros(4, 'quaternion')` returns a 4-by-4 matrix of quaternion zeros.

Data Types: `single` | `double` | `int8` | `int16` | `int32` | `int64` | `uint8` | `uint16` | `uint32` | `uint64`

sz — Output size

row vector of integer values

Output size, specified as a row vector of integer values. Each element of `sz` indicates the size of the corresponding dimension in `quatZeros`. If the size of any dimension is 0 or negative, then `quatZeros` is returned as an empty array.

Example: `zeros([1,4,2], 'quaternion')` returns a 1-by-4-by-2 array of quaternion zeros.

Data Types: `single` | `double` | `int8` | `int16` | `int32` | `int64` | `uint8` | `uint16` | `uint32` | `uint64`

prototype — Quaternion prototype

variable

Quaternion prototype, specified as a variable.

Example: `zeros(2, 'like', quat, 'quaternion')` returns a 2-by-2 matrix of quaternions with the same underlying class as the prototype quaternion, `quat`.

Data Types: `quaternion`

sz1, ..., szN — Size of each dimension

two or more integer values

Size of each dimension, specified as two or more integers.

- If the size of any dimension is 0, then `quatZeros` is returned as an empty array.
- If the size of any dimension is negative, then it is treated as 0.

Example: `zeros(2,3, 'quaternion')` returns a 2-by-3 matrix of quaternion zeros.

Data Types: `single` | `double` | `int8` | `int16` | `int32` | `int64` | `uint8` | `uint16` | `uint32` | `uint64`

Output Arguments

quatZeros — Quaternion zeros

scalar | vector | matrix | multidimensional array

Quaternion zeros, returned as a quaternion or array of quaternions.

Given a quaternion of the form $Q = a + bi + cj + dk$, a quaternion zero is defined as $Q = 0 + 0i + 0j + 0k$.

Data Types: quaternion

Version History

Introduced in R2020a

Extended Capabilities

C/C++ Code Generation

Generate C and C++ code using MATLAB® Coder™.

See Also

Functions

ones

Objects

quaternion

Topics

“Rotations, Orientations, and Quaternions for Automated Driving”

trackHistoryLogic

Confirm and delete tracks based on recent track history

Description

The `trackHistoryLogic` object determines if a track should be confirmed or deleted based on the track history. A track should be confirmed if there are at least Mc hits in the recent Nc updates. A track should be deleted if there are at least Md misses in the recent Nd updates.

The confirmation and deletion decisions contribute to the track management by a `multiObjectTracker` object.

Creation

Syntax

```
logic = trackHistoryLogic
logic = trackHistoryLogic(Name, Value, ...)
```

Description

`logic = trackHistoryLogic` creates a `trackHistoryLogic` object with default confirmation and deletion thresholds.

`logic = trackHistoryLogic(Name, Value, ...)` specifies the properties of the track history logic object using one or more `Name, Value` pair arguments. Any unspecified properties take default values.

Properties

ConfirmationThreshold — Confirmation threshold

[2 3] (default) | positive integer scalar | 2-element vector of positive integers

Confirmation threshold, specified as a positive integer scalar or 2-element vector of positive integers. If the logic score is above this threshold, the track is confirmed. `ConfirmationThreshold` has the form $[Mc Nc]$, where Mc is the number of hits required for confirmation in the recent Nc updates. When specified as a scalar, then Mc and Nc have the same value.

Example: [3 5]

Data Types: `single` | `double`

DeletionThreshold — Deletion threshold

[6 6] (default) | positive integer scalar | 2-element vector of positive integers

Deletion threshold, specified as a positive integer scalar or 2-element vector of positive integers. If the logic score is above this threshold, the track is deleted. `DeletionThreshold` has the form $[Md Nd]$, where Md is the number of misses required for deletion in the recent Nd updates. When specified as a scalar, then Md and Nd have the same value.

Example: [5 5]

Data Types: single | double

History — Track history

logical vector

This property is read-only.

Track history, specified as a logical vector of length N , where N is the larger of the second element in the `ConfirmationThreshold` and the second element in the `DeletionThreshold`. The first element is the most recent update. A `true` value indicates a hit and a `false` value indicates a miss.

Object Functions

<code>init</code>	Initialize track logic with first hit
<code>hit</code>	Update track logic with subsequent hit
<code>miss</code>	Update track logic with miss
<code>checkConfirmation</code>	Check if track should be confirmed
<code>checkDeletion</code>	Check if track should be deleted
<code>output</code>	Get current state of track logic
<code>reset</code>	Reset state of track logic
<code>sync</code>	Synchronize trackHistoryLogic objects
<code>clone</code>	Create copy of track logic

Examples

Create and Update History-Based Logic

Create a history-based logic. Specify confirmation threshold values M_c and N_c as the vector [3 5]. Specify deletion threshold values M_d and N_d as the vector [6 7].

```
historyLogic = trackHistoryLogic('ConfirmationThreshold',[3 5], ...
    'DeletionThreshold',[6 7])
```

```
historyLogic =
    trackHistoryLogic with properties:
        ConfirmationThreshold: [3 5]
        DeletionThreshold: [6 7]
        History: [0 0 0 0 0 0 0]
```

Initialize the logic, which records a hit as the first update to the logic.

```
init(historyLogic)
history = historyLogic.History;
disp(['History: ', num2str(history), '.']);
```

```
History: [1 0 0 0 0 0 0].
```

Update the logic four more times, where only the odd updates register a hit. The confirmation flag is `true` by the end of the fifth update, because three hits (M_c) are counted in the most recent five updates (N_c).

```

for i = 2:5
    isOdd = logical(mod(i,2));
    if isOdd
        hit(historyLogic)
    else
        miss(historyLogic)
    end

    history = historyLogic.History;
    confFlag = checkConfirmation(historyLogic);
    delFlag = checkDeletion(historyLogic,true,i);
    disp(['History: [' ,num2str(history),']. Confirmation Flag: ' ,num2str(confFlag), ...
        '. Deletion Flag: ' ,num2str(delFlag)']);
end

History: [0 1 0 0 0 0 0]. Confirmation Flag: 0. Deletion Flag: 0
History: [1 0 1 0 0 0 0]. Confirmation Flag: 0. Deletion Flag: 0
History: [0 1 0 1 0 0 0]. Confirmation Flag: 0. Deletion Flag: 0
History: [1 0 1 0 1 0 0]. Confirmation Flag: 1. Deletion Flag: 0

```

Update the logic with a miss six times. The deletion flag is true by the end of the fifth update, because six misses (Md) are counted in the most recent seven updates (Nd).

```

for i = 1:6
    miss(historyLogic);

    history = historyLogic.History;
    confFlag = checkConfirmation(historyLogic);
    delFlag = checkDeletion(historyLogic);
    disp(['History: [' ,num2str(history),']. Confirmation Flag: ' ,num2str(confFlag), ...
        '. Deletion Flag: ' ,num2str(delFlag)']);
end

History: [0 1 0 1 0 1 0]. Confirmation Flag: 0. Deletion Flag: 0
History: [0 0 1 0 1 0 1]. Confirmation Flag: 0. Deletion Flag: 0
History: [0 0 0 1 0 1 0]. Confirmation Flag: 0. Deletion Flag: 0
History: [0 0 0 0 1 0 1]. Confirmation Flag: 0. Deletion Flag: 0
History: [0 0 0 0 0 1 0]. Confirmation Flag: 0. Deletion Flag: 1
History: [0 0 0 0 0 0 1]. Confirmation Flag: 0. Deletion Flag: 1

```

Version History

Introduced in R2020a

References

- [1] Blackman, S., and R. Popoli. *Design and Analysis of Modern Tracking Systems*. Boston, MA: Artech House, 1999.

Extended Capabilities

C/C++ Code Generation

Generate C and C++ code using MATLAB® Coder™.

See Also

multiObjectTracker

checkConfirmation

Check if track should be confirmed

Syntax

```
tf = checkConfirmation(historyLogic)
```

Description

`tf = checkConfirmation(historyLogic)` returns a flag that is `true` when at least M_c out of N_c recent updates of the track history logic object `historyLogic` are `true`.

Examples

Check Confirmation of History-Based Logic

Create a history-based logic. Specify confirmation threshold values M_c and N_c as the vector `[2 3]`. Specify deletion threshold values M_d and N_d as the vector `[3 3]`.

```
historyLogic = trackHistoryLogic('ConfirmationThreshold',[2 3], ...
    'DeletionThreshold',[3 3])
```

```
historyLogic =
    trackHistoryLogic with properties:
```

```
    ConfirmationThreshold: [2 3]
    DeletionThreshold: [3 3]
    History: [0 0 0]
```

Initialize the logic, which records a hit as the first update to the logic. The confirmation flag is `false` because the number of hits is less than two (M_c).

```
init(historyLogic)
history = output(historyLogic);
confFlag = checkConfirmation(historyLogic);
disp(['History: ',num2str(history),']. Confirmation Flag: ',num2str(confFlag)]);
```

```
History: [1 0 0]. Confirmation Flag: 0
```

Update the logic with a hit. The confirmation flag is `true` because two hits (M_c) are counted in the most recent three updates (N_c).

```
hit(historyLogic)
history = output(historyLogic);
confFlag = checkConfirmation(historyLogic);
disp(['History: ',num2str(history),']. Confirmation Flag: ',num2str(confFlag)]);
```

```
History: [1 1 0]. Confirmation Flag: 1
```

Input Arguments

historyLogic — Track history logic

`trackHistoryLogic`

Track history logic, specified as a `trackHistoryLogic` object.

Output Arguments

tf — Track should be confirmed

`true` | `false`

Track should be confirmed, returned as `true` or `false`.

Version History

Introduced in R2020a

Extended Capabilities

C/C++ Code Generation

Generate C and C++ code using MATLAB® Coder™.

See Also

`trackHistoryLogic`

checkDeletion

Check if track should be deleted

Syntax

```
tf = checkDeletion(historyLogic)
tf = checkDeletion(historyLogic,tentativeTrack,age)
```

Description

`tf = checkDeletion(historyLogic)` returns a flag that is true when at least Md out of Nd recent updates of the track history logic object `historyLogic` are false.

`tf = checkDeletion(historyLogic,tentativeTrack,age)` returns a flag that is true when the track is tentative and there are not enough detections to allow it to confirm. Use the logical flag `tentativeTrack` to indicate if the track is tentative and provide `age` as a numeric scalar.

Examples

Check Deletion of History-Based Logic

Create a history-based logic. Specify confirmation threshold values M_c and N_c as the vector [2 3]. Specify deletion threshold values M_d and N_d as the vector [4 5].

```
historyLogic = trackHistoryLogic('ConfirmationThreshold',[2 3], ...
    'DeletionThreshold',[4 5])
```

```
historyLogic =
    trackHistoryLogic with properties:
        ConfirmationThreshold: [2 3]
        DeletionThreshold: [4 5]
        History: [0 0 0 0 0]
```

Initialize the logic, which records a hit as the first update to the logic. The confirmation flag is false because the number of hits is less than two (M_c).

```
init(historyLogic)
history = output(historyLogic);
checkConfirmation(historyLogic)
```

```
ans = logical
    0
```

```
delFlag = checkDeletion(historyLogic);
disp(['History: ',num2str(history),']. Deletion Flag: ',num2str(delFlag)]);
```

```
History: [1 0 0 0 0]. Deletion Flag: 1
```

Update the logic with a hit. The confirmation flag is `true` because two hits (M_c) are counted in the most recent three updates (N_c).

```
hit(historyLogic)
history = output(historyLogic);
checkConfirmation(historyLogic)

ans = logical
     1

delFlag = checkDeletion(historyLogic);
disp(['History: ',num2str(history),']. Deletion Flag: ',num2str(delFlag)]);

History: [1 1 0 0 0]. Deletion Flag: 0

miss(historyLogic)
history = output(historyLogic);
checkConfirmation(historyLogic)

ans = logical
     1

delFlag = checkDeletion(historyLogic);
disp(['History: ',num2str(history),']. Deletion Flag: ',num2str(delFlag)]);

History: [0 1 1 0 0]. Deletion Flag: 0

miss(historyLogic)
history = output(historyLogic);
delFlag = checkDeletion(historyLogic);
checkConfirmation(historyLogic)

ans = logical
     0

disp(['History: ',num2str(history),']. Deletion Flag: ',num2str(delFlag)]);

History: [0 0 1 1 0]. Deletion Flag: 0
```

Check Deletion of Tentative Track

Create a history-based logic. Specify confirmation threshold values M_c and N_c as the vector [2 3]. Specify deletion threshold values M_d and N_d as the vector [4 5].

```
historyLogic = trackHistoryLogic('ConfirmationThreshold',[2 3], ...
    'DeletionThreshold',5)

historyLogic =
    trackHistoryLogic with properties:

        ConfirmationThreshold: [2 3]
        DeletionThreshold: [5 5]
        History: [0 0 0 0 0]
```

Initialize the logic, which records a hit as the first update to the logic. Then, record two misses.

```
init(historyLogic)
miss(historyLogic)
miss(historyLogic)
history = output(historyLogic)

history = 1x5 logical array
    0    0    1    0    0
```

The confirmation flag is `false` because the number of hits in the most recent 3 updates (N_c) is less than 2 (M_c).

```
confirmationFlag = checkConfirmation(historyLogic)

confirmationFlag = logical
    0
```

Check the deletion flag as if the track were not tentative. The deletion flag is `false` because the number of misses in the most recent 5 updates (N_m) is less than 4 (M_c).

```
deletionFlag = checkDeletion(historyLogic)

deletionFlag = logical
    0
```

Recheck the deletion flag, treating the track as tentative with an age of 3. The tentative deletion flag is `true` because there are not enough detections to allow the track to confirm.

```
tentativeDeletionFlag = checkDeletion(historyLogic,true,3)

tentativeDeletionFlag = logical
    1
```

Input Arguments

historyLogic — Track history logic

trackHistoryLogic

Track history logic, specified as a trackHistoryLogic object.

tentativeTrack — Track is tentative

false | true

Track is tentative, specified as `false` or `true`. Use `tentativeTrack` to indicate if the track is tentative.

age — Number of updates

numeric scalar

Number of updates since track initialization, specified as a numeric scalar.

Output Arguments

tf — Track can be deleted

true | false

Track can be deleted, returned as true or false.

Version History

Introduced in R2020a

Extended Capabilities

C/C++ Code Generation

Generate C and C++ code using MATLAB® Coder™.

See Also

trackHistoryLogic

clone

Create copy of track logic

Syntax

```
clonedLogic = clone(logic)
```

Description

`clonedLogic = clone(logic)` returns a copy of the current track logic object, `logic`.

Examples

Clone Track History Logic

Create a history-based logic. Specify confirmation threshold values M_c and N_c as the vector [3 5]. Specify deletion threshold values M_d and N_d as the vector [6 7].

```
historyLogic = trackHistoryLogic('ConfirmationThreshold',[3 5], ...
    'DeletionThreshold',[6 7])
```

```
historyLogic =
    trackHistoryLogic with properties:

        ConfirmationThreshold: [3 5]
        DeletionThreshold: [6 7]
        History: [0 0 0 0 0 0 0]
```

Initialize the logic, which records a hit as the first update to the logic.

```
init(historyLogic)
```

Update the logic four more times, where only the odd updates register a hit.

```
for i = 2:5
    isOdd = logical(mod(i,2));
    if isOdd
        hit(historyLogic)
    else
        miss(historyLogic)
    end
end
```

Get the current state of the logic.

```
history = output(historyLogic)
```

```
history = 1x7 logical array
    1    0    1    0    1    0    0
```

Create a copy of the logic. The clone has the same confirmation threshold, deletion threshold, and history as the original history logic.

```
clonedLogic = clone(historyLogic)

clonedLogic =
  trackHistoryLogic with properties:

    ConfirmationThreshold: [3 5]
    DeletionThreshold: [6 7]
    History: [1 0 1 0 1 0 0]
```

Input Arguments

logic — Track history logic

trackHistoryLogic object

Track history logic, specified as a trackHistoryLogic object.

Output Arguments

clonedLogic — Cloned track logic

trackHistoryLogic object

Cloned track logic, returned as a trackHistoryLogic object.

Version History

Introduced in R2020a

Extended Capabilities

C/C++ Code Generation

Generate C and C++ code using MATLAB® Coder™.

See Also

trackHistoryLogic

hit

Update track logic with subsequent hit

Syntax

```
hit(historyLogic)
```

Description

`hit(historyLogic)` updates the track history with a hit.

Examples

Update History Logic with Hit

Create a history-based logic with the default confirmation and deletion thresholds.

```
historyLogic = trackHistoryLogic;
```

Initialize the logic, which records a hit as the first update to the logic. The first element of the 'History' property, which indicates the most recent update, is 1.

```
init(historyLogic)
history = historyLogic.History;
disp(['History: ', num2str(history), '.']);
```

```
History: [1 0 0 0 0 0].
```

Update the logic with a hit. The first two elements of the 'History' property are 1.

```
hit(historyLogic)
history = historyLogic.History;
disp(['History: ', num2str(history), '.']);
```

```
History: [1 1 0 0 0 0].
```

Input Arguments

historyLogic — Track history logic

`trackHistoryLogic`

Track history logic, specified as a `trackHistoryLogic` object.

Version History

Introduced in R2020a

Extended Capabilities

C/C++ Code Generation

Generate C and C++ code using MATLAB® Coder™.

See Also

`trackHistoryLogic`

init

Initialize track logic with first hit

Syntax

```
init(historyLogic)
```

Description

`init(historyLogic)` initializes the track history logic with the first hit.

Examples

Initialize History-Based Logic

Create a history-based logic with default confirmation and deletion thresholds.

```
historyLogic = trackHistoryLogic

historyLogic =
  trackHistoryLogic with properties:

    ConfirmationThreshold: [2 3]
    DeletionThreshold: [6 6]
    History: [0 0 0 0 0 0]
```

Initialize the logic, which records a hit as the first update to the logic.

```
init(historyLogic)
history = historyLogic.History;
disp(['History: ', num2str(history), '.']);

History: [1 0 0 0 0 0].
```

Input Arguments

historyLogic — Track history logic

`trackHistoryLogic` object

Track history logic, specified as a `trackHistoryLogic` object.

Version History

Introduced in R2020a

Extended Capabilities

C/C++ Code Generation

Generate C and C++ code using MATLAB® Coder™.

See Also

`trackHistoryLogic`

miss

Update track logic with miss

Syntax

```
miss(historyLogic)
```

Description

`miss(historyLogic)` updates the track history with a miss.

Examples

Update History Logic with Miss

Create a history-based logic with the default confirmation and deletion thresholds.

```
historyLogic = trackHistoryLogic;
```

Initialize the logic, which records a hit as the first update to the logic. The first element of the 'History' property, which indicates the most recent update, is 1.

```
init(historyLogic)
history = historyLogic.History;
disp(['History: ', num2str(history), '.']);
```

```
History: [1 0 0 0 0 0].
```

Update the logic with a miss. The first element of the 'History' property is 0.

```
miss(historyLogic)
history = historyLogic.History;
disp(['History: ', num2str(history), '.']);
```

```
History: [0 1 0 0 0 0].
```

Input Arguments

historyLogic — Track history logic

`trackHistoryLogic`

Track history logic, specified as a `trackHistoryLogic` object.

Version History

Introduced in R2020a

Extended Capabilities

C/C++ Code Generation

Generate C and C++ code using MATLAB® Coder™.

See Also

`trackHistoryLogic`

output

Get current state of track logic

Syntax

```
history = output(historyLogic)
```

Description

`history = output(historyLogic)` returns the recent history updates of the track history logic object, `historyLogic`.

Examples

Get Recent History of History-Based Logic

Create a history-based logic. Specify confirmation threshold values M_c and N_c as the vector [3 5]. Specify deletion threshold values M_d and N_d as the vector [6 7].

```
historyLogic = trackHistoryLogic('ConfirmationThreshold',[3 5], ...
    'DeletionThreshold',[6 7]);
```

Get the recent history of the logic. The history vector has a length of 7, which is the greater of N_c and N_d . All values are 0 because the logic is not initialized.

```
h = output(historyLogic)
```

```
h = 1x7 logical array
```

```
    0    0    0    0    0    0    0
```

Initialize the logic, then get the recent history of the logic. The first element, which indicates the most recent update, is 1.

```
init(historyLogic);
```

```
h = output(historyLogic)
```

```
h = 1x7 logical array
```

```
    1    0    0    0    0    0    0
```

Update the logic with a hit, then get the recent history of the logic.

```
hit(historyLogic);
```

```
h = output(historyLogic)
```

```
h = 1x7 logical array
```

```
    1    1    0    0    0    0    0
```

Input Arguments

historyLogic — Track history logic

`trackHistoryLogic`

Track history logic, specified as a `trackHistoryLogic` object.

Output Arguments

history — Recent history

logical vector

Recent track history of `historyLogic`, returned as a logical vector. The length of the vector is the same as the length of the `History` property of the `historyLogic`. The first element is the most recent update. A `true` value indicates a hit and a `false` value indicates a miss.

Version History

Introduced in R2020a

Extended Capabilities

C/C++ Code Generation

Generate C and C++ code using MATLAB® Coder™.

See Also

`trackHistoryLogic`

reset

Reset state of track logic

Syntax

```
reset(logic)
```

Description

`reset(logic)` resets the track logic object, `logic`.

Examples

Reset Track History Logic

Create a history-based logic using the default confirmation threshold and deletion threshold. Get the current state of the logic. The current and maximum score are both 0.

```
historyLogic = trackHistoryLogic;  
history = output(historyLogic)
```

```
history = 1x6 logical array
```

```
  0  0  0  0  0  0
```

Initialize the logic, then get the current state of the logic.

```
volume = 1.3;  
beta = 0.1;  
init(historyLogic);  
history = output(historyLogic)
```

```
history = 1x6 logical array
```

```
  1  0  0  0  0  0
```

Reset the logic, then get the current state of the logic.

```
reset(historyLogic)  
history = output(historyLogic)
```

```
history = 1x6 logical array
```

```
  0  0  0  0  0  0
```

Input Arguments

logic — Track history logic
trackHistoryLogic object

Track history logic, specified as a trackHistoryLogic object.

Version History

Introduced in R2020a

Extended Capabilities

C/C++ Code Generation

Generate C and C++ code using MATLAB® Coder™.

See Also

trackHistoryLogic

sync

Synchronize trackHistoryLogic objects

Syntax

```
sync(historyLogic1,historyLogic2)
```

Description

sync(historyLogic1,historyLogic2) synchronizes historyLogic1 based on historyLogic2 so that they have the same history value.

Examples

Synchronize Two trackHistoryLogic Objects

Create two trackHistoryLogic objects.

```
logic1 = trackHistoryLogic
```

```
logic1 =
  trackHistoryLogic with properties:
    ConfirmationThreshold: [2 3]
    DeletionThreshold: [6 6]
    History: [0 0 0 0 0 0]
```

```
logic2 = trackHistoryLogic('ConfirmationThreshold',[3 3],'DeletionThreshold',[5 6])
```

```
logic2 =
  trackHistoryLogic with properties:
    ConfirmationThreshold: [3 3]
    DeletionThreshold: [5 6]
    History: [0 0 0 0 0 0]
```

Initialize logic2 with a hit.

```
init(logic2)
logic2

logic2 =
  trackHistoryLogic with properties:
    ConfirmationThreshold: [3 3]
    DeletionThreshold: [5 6]
    History: [1 0 0 0 0 0]
```

Synchronize logic1 to logic2.

```
sync(logic1,logic2);
logic1

logic1 =
  trackHistoryLogic with properties:

    ConfirmationThreshold: [2 3]
    DeletionThreshold: [6 6]
    History: [1 0 0 0 0 0]
```

Input Arguments

historyLogic1 — Track history logic

trackHistoryLogic object

Track history logic, specified as a trackHistoryLogic object.

historyLogic2 — Track history logic

trackHistoryLogic object

Track history logic, specified as a trackHistoryLogic object.

Version History

Introduced in R2021a

labelDefinitionCreatorMultisignal

Object for storing, modifying, and creating label definitions table for multisignal workflow

Description

The `labelDefinitionCreatorMultisignal` object stores definitions of labels, sublabels, and attributes to label ground truth data for a multisignal workflow. Use “Object Functions” on page 4-1674 to add, remove, modify, or display label definitions. Use the `create` object function to create a label definitions table from the `labelDefinitionCreatorMultisignal` object. You can use this label definitions table with the **Ground Truth Labeler** app.

Creation

Syntax

```
ldc = labelDefinitionCreatorMultisignal
ldc = labelDefinitionCreatorMultisignal(labelDefs)
```

Description

`ldc = labelDefinitionCreatorMultisignal` creates an empty label definition creator object `ldc` for a multisignal workflow. Add label definitions to this object using “Object Functions” on page 4-1674. Use the `info` function to inspect details of stored labels, sublabels, and attributes.

`ldc = labelDefinitionCreatorMultisignal(labelDefs)` creates a label definition creator object `ldc` for a multisignal workflow and stores definitions from the label definitions table `labelDefs`. Use “Object Functions” on page 4-1674 to add new label definitions or modify the existing label definitions. Use the `info` function to inspect details of stored labels, sublabels, and attributes.

Input Arguments

labelDefs — Label definitions

table

Label definitions, specified as a table with up to eight columns. The possible columns are *Name*, *SignalType*, *LabelType*, *Group*, *Description*, *LabelColor*, *PixelLabelID*, and *Hierarchy*. This table specifies the definitions of labels, sublabels, and attributes for labeling ground truth data. For more details, see `LabelDefinitions` property of `groundTruthMultisignal` object.

Output Arguments

ldc — Label definition creator for multisignal workflow

`labelDefinitionCreatorMultisignal` object

Label definition creator for the multisignal workflow, returned as a `labelDefinitionCreatorMultisignal` object that contains information about label definitions associated with ground truth data.

Object Functions

<code>addLabel</code>	Add label to label definition creator object for multisignal workflow
<code>addSublabel</code>	Add sublabel to label in label definition creator object for multisignal workflow
<code>addAttribute</code>	Add attributes to label or sublabel in label definition creator object for multisignal workflow
<code>removeLabel</code>	Remove label from label definition creator object for multisignal workflow
<code>removeSublabel</code>	Remove sublabel from label in label definition creator object for multisignal workflow
<code>removeAttribute</code>	Remove attribute from label or sublabel in label definition creator object for multisignal workflow
<code>editLabelGroup</code>	Modify label group name in label definition creator object for multisignal workflow
<code>editGroupName</code>	Change group name in label definition creator object for multisignal workflow
<code>editLabelDescription</code>	Modify label or sublabel description in label definition creator object for multisignal workflow
<code>editAttributeDescription</code>	Modify attribute description in label definition creator object for multisignal workflow
<code>create</code>	Create label definitions table from label definition creator object for multisignal workflow
<code>info</code>	Display label, sublabel, or attribute information stored in label definition creator object for multisignal workflow

Examples

Create Label Definition Creator Object for Multisignal Workflow and Add Label Definitions

Create an empty `labelDefinitionCreatorMultisignal` object.

```
ldc = labelDefinitionCreatorMultisignal
```

```
ldc =  
labelDefinitionCreatorMultisignal
```

Add a label with the name 'Vehicle'. Specify the type as 'Rectangle'. Adding a 'Rectangle' also adds a 'Cuboid' entry to the label definitions table.

```
addLabel(ldc, 'Vehicle', 'Rectangle')
```

Add an attribute with the name 'Color' to the label 'Vehicle'. Specify the attribute type as a string with the value 'Red'.

```
addAttribute(ldc, 'Vehicle', 'Color', attributeType.String, 'Red')
```

Add a sublabel with the name 'Wheel' to the label 'Vehicle'. Specify the type of the sublabel as 'Rectangle'.

```
addSublabel(ldc, 'Vehicle', 'Wheel', 'Rectangle')
```

Add an attribute called 'Diameter' to the sublabel 'Wheel'. Specify the attribute value as a 'Numeric' scalar.

```
addAttribute(ldc, 'Vehicle/Wheel', 'Diameter', 'Numeric', 14)
```

Display the details of the updated `labelDefinitionCreatorMultisignal` object.

```
ldc
```

```
ldc =
labelDefinitionCreatorMultisignal contains the following labels:
```

```
    Vehicle with 1 sublabels and 1 attributes and belongs to None group.    (info)
```

For more details about attributes and sublabels, use the info method.

Create a label definitions table from the definitions stored in the object.

```
labelDefs = create(ldc)
```

```
labelDefs=2x7 table
```

Name	SignalType	LabelType	Group	Description	LabelColor	Hierarchy
{'Vehicle'}	Image	Rectangle	{'None'}	{' '}	{0x0 char}	{1x1 struct}
{'Vehicle'}	PointCloud	Cuboid	{'None'}	{' '}	{0x0 char}	{1x1 struct}

Create Label Definition Creator Object for Multisignal Workflow from Existing Label Definitions Table

Load an existing multisignal label definitions table into the workspace.

```
labelDefFile = fullfile(toolboxdir('driving'),'drivingdata','labelDefsMultiSignal.mat');
ld = load(labelDefFile)
```

```
ld = struct with fields:
    labelDefs: [6x6 table]
```

Create a labelDefinitionCreatorMultisignal object from the label definitions table.

```
ldc = labelDefinitionCreatorMultisignal(ld.labelDefs)
```

```
ldc =
labelDefinitionCreatorMultisignal contains the following labels:
```

```
    Car with 0 sublabels and 0 attributes and belongs to None group.    (info)
    LeftLane with 0 sublabels and 0 attributes and belongs to None group.    (info)
    Road with 0 sublabels and 0 attributes and belongs to None group.    (info)
    Sunny with 0 sublabels and 0 attributes and belongs to None group.    (info)
    Urban with 0 sublabels and 0 attributes and belongs to None group.    (info)
```

For more details about attributes and sublabels, use the info method.

Add a new attribute to the label 'Car'.

```
addAttribute(ldc,'Car','Color','List',{'Red','Green','Blue'})
```

Display the details of the updated labelDefinitionCreatorMultisignal object.

```
ldc
```

```
ldc =
labelDefinitionCreatorMultisignal contains the following labels:
```

Car with 0 sublabels and 1 attributes and belongs to None group. (info)
LeftLane with 0 sublabels and 0 attributes and belongs to None group. (info)
Road with 0 sublabels and 0 attributes and belongs to None group. (info)
Sunny with 0 sublabels and 0 attributes and belongs to None group. (info)
Urban with 0 sublabels and 0 attributes and belongs to None group. (info)

For more details about attributes and sublabels, use the info method.

Version History

Introduced in R2020a

See Also

Apps

Ground Truth Labeler

Objects

groundTruthMultisignal | labelType | attributeType

addAttribute

Add attributes to label or sublabel in label definition creator object for multisignal workflow

Syntax

```
addAttribute(ldc, labelName, attributeName, typeOfAttribute, attributeDefault)
addAttribute( ____, Name, Value)
```

Description

`addAttribute(ldc, labelName, attributeName, typeOfAttribute, attributeDefault)` adds an attribute with specified name and type to the indicated label or sublabel. The attribute is added under the hierarchy for the specified label or sublabel in the `labelDefinitionCreatorMultisignal` object `ldc`.

`addAttribute(____, Name, Value)` specifies options using one or more name-value pair arguments in addition to the input arguments in the previous syntax.

Examples

Add Attributes to Label and Sublabel in Label Definition Creator Object for Multisignal Workflow

Create an empty `labelDefinitionCreatorMultisignal` object.

```
ldc = labelDefinitionCreatorMultisignal;
```

Add a label with the name 'Car'. Specify the type of label as 'Rectangle'. Adding a 'Rectangle' also adds a 'Cuboid' entry to the label definitions table.

```
addLabel(ldc, 'Car', 'Rectangle');
```

Add an attribute 'Color' to the label 'Car'. Specify the attribute type as 'String' with the value 'Red'.

```
addAttribute(ldc, 'Car', 'Color', 'String', 'Red')
```

Add a label with the name 'TrafficLight'. Specify the type of the label as 'Rectangle'. Add a description to the label.

```
addLabel(ldc, 'TrafficLight', 'Rectangle', 'Description', 'Bounding boxes for stop signs');
```

Add a sublabel with the name 'RedLight' to the label 'TrafficLight'. Specify the type of the sublabel as 'Rectangle'.

```
addSublabel(ldc, 'TrafficLight', 'RedLight', 'Rectangle');
```

Add an attribute 'isOn' to the sublabel 'RedLight' in the label 'TrafficLight'. Specify the attribute type for the sublabel as 'logical' with the value false.

```
addAttribute(ldc, 'TrafficLight/RedLight', 'isOn', 'logical', false);
```

Display the details of the updated `labelDefinitionCreatorMultisignal` object.

```
ldc
```

```
ldc =
```

```
labelDefinitionCreatorMultisignal contains the following labels:
```

```
    Car with 0 sublabels and 1 attributes and belongs to None group.    (info)
    TrafficLight with 1 sublabels and 0 attributes and belongs to None group.    (info)
```

For more details about attributes and sublabels, use the `info` method.

Display information about the attribute under the label 'Car' using the object function `info`.

```
info(ldc, 'Car')
```

```
    Name: "Car"
    SignalType: Image
    LabelType: Rectangle
    Group: "None"
    LabelColor: {' '}
    Attributes: "Color"
    Sublabels: []
    Description: ' '
```

```
    Name: "Car"
    SignalType: PointCloud
    LabelType: Cuboid
    Group: "None"
    LabelColor: {' '}
    Attributes: "Color"
    Sublabels: []
    Description: ' '
```

Display information about the attribute under the label 'TrafficLight' using the object function `info`.

```
info(ldc, 'TrafficLight')
```

```
    Name: "TrafficLight"
    SignalType: Image
    LabelType: Rectangle
    Group: "None"
    LabelColor: {' '}
    Attributes: []
    Sublabels: "RedLight"
    Description: 'Bounding boxes for stop signs'
```

```
    Name: "TrafficLight"
    SignalType: PointCloud
    LabelType: Cuboid
    Group: "None"
    LabelColor: {' '}
    Attributes: []
    Sublabels: "RedLight"
    Description: 'Bounding boxes for stop signs'
```

Display information about the attribute under the sublabel 'RedLight' in the label 'TrafficLight' using the object function `info`.

```
info(ldc, 'TrafficLight/RedLight')
```

```
    Name: "RedLight"
    Type: Rectangle
LabelColor: ''
Attributes: "isOn"
Sublabels: []
Description: ''
```

Display information about the attribute 'isOn' under the sublabel 'RedLight' in the label 'TrafficLight' using the object function info.

```
info(ldc, 'TrafficLight/RedLight/isOn')
```

```
    Name: "isOn"
    Type: Logical
DefaultValue: 0
Description: ''
```

Input Arguments

ldc — Label definition creator for multisignal workflow

labelDefinitionCreatorMultisignal object

Label definition creator for the multisignal workflow, specified as a labelDefinitionCreatorMultisignal object.

labelName — Label or sublabel name

character vector | string scalar

Label or sublabel name, specified as a character vector or string scalar that uniquely identifies the label or sublabel to which the attribute is to be added.

- To specify a label, use the form '*labelName*'.

Example: `addAttribute(ldc, 'Car', 'Color')`

- To specify a sublabel, use the form '*labelName/sublabelName*'. In this case, the attribute associates with the sublabel.

Example: `addAttribute(ldc, 'TrafficLight/RedLight', 'isOn')`

attributeName — Attribute name

character vector | string scalar

Attribute name, specified as a character vector or string scalar that identifies the attribute to be added to the label or sublabel.

typeOfAttribute — Type of attribute

attributeType enumeration | character vector | string scalar

Type of attribute, specified as one of these values:

- `attributeType` enumeration — The type of the attribute must be one of these `attributeType` enumerators: `Numeric`, `Logical`, `String`, or `List`.

Example: `addAttribute(ldc, 'Car', 'Color', attributeType.String, 'Red');`

- Character vector or string scalar — This value must partially or fully match one of the enumerators in the `attributeType` enumeration.

Example: `addAttribute(ldc, 'Car', 'Color', 'Str', 'Red');`

attributeDefault — Default value of attribute

numeric scalar | logical scalar | character vector | string scalar | cell array of character vectors | cell array of string scalars

Default value of the attribute, specified as one of these:

- Numeric scalar — Specify this value when `typeOfAttribute` is `Numeric`.
- Logical scalar — Specify this value when `typeOfAttribute` is `Logical`.
- Character vector or string scalar — Specify this value when `typeOfAttribute` is `String`.
- Cell array of character vectors or cell array of string scalars — Specify this value when `typeOfAttribute` is `List`. The first entry in the cell array is the default value.

Name-Value Pair Arguments

Specify optional pairs of arguments as `Name1=Value1, ..., NameN=ValueN`, where `Name` is the argument name and `Value` is the corresponding value. Name-value arguments must appear after other arguments, but the order of the pairs does not matter.

Before R2021a, use commas to separate each name and value, and enclose Name in quotes.

Example: `addAttribute(ldc, 'Car/Wheel', 'Outsidediameter', attributeType.Numeric, 740, 'Description', 'Outside diameter in mm');`

Description — Attribute description

' ' (default) | character vector | string scalar

Attribute description, specified as a comma-separated pair consisting of `'Description'` and a character vector or string scalar. Use this name-value pair to describe the attribute.

Version History

Introduced in R2020a

See Also

Objects

`labelDefinitionCreatorMultisignal` | `attributeType`

Functions

`addLabel` | `addSublabel` | `removeAttribute` | `editAttributeDescription`

addLabel

Add label to label definition creator object for multesignal workflow

Syntax

```
addLabel(ldc, labelName, typeOfLabel)
addLabel( ____, Name, Value)
```

Description

`addLabel(ldc, labelName, typeOfLabel)` adds a label with the specified name and type to the `labelDefinitionCreatorMultesignal` object `ldc`.

`addLabel(____, Name, Value)` specifies options using one or more name-value pair arguments in addition to the input arguments in the previous syntax.

Examples

Add Label Using Label Definition Creator for Multesignal Workflow

Create an empty `labelDefinitionCreatorMultesignal` object.

```
ldc = labelDefinitionCreatorMultesignal;
```

Add a label named 'Car'. Specify the type of label as 'Cuboid'. Adding a 'Cuboid' also adds a 'Rectangle' entry to the label definitions table.

```
addLabel(ldc, 'Car', 'Cuboid');
```

Add another label named 'StopSign' in a group named 'TrafficSign'. Specify the type of label as a 'Rectangle'. Adding 'Rectangle' also adds a 'Cuboid' entry to the label definitions table. Add a description to the label.

```
addLabel(ldc, 'StopSign', 'Rectangle', 'Group', 'TrafficSign', 'Description', 'Bounding boxes for stop
```

Display the details of the updated `labelDefinitionCreatorMultesignal` object.

```
ldc
```

```
ldc =
labelDefinitionCreatorMultesignal contains the following labels:
```

```
    Car with 0 sublabels and 0 attributes and belongs to None group.      (info)
    StopSign with 0 sublabels and 0 attributes and belongs to TrafficSign group.  (info)
```

For more details about attributes and sublabels, use the `info` method.

Display information about the label 'Car' using the object function `info`.

```
info(ldc, 'Car')
```

```
Name: "Car"
SignalType: Image
LabelType: Rectangle
Group: "None"
LabelColor: {' '}
Attributes: []
Sublabels: []
Description: ' '
```

```
Name: "Car"
SignalType: PointCloud
LabelType: Cuboid
Group: "None"
LabelColor: {' '}
Attributes: []
Sublabels: []
Description: ' '
```

Display information about the label 'StopSign' using the object function `info`.

```
info(ldc, 'StopSign')
```

```
Name: "StopSign"
SignalType: Image
LabelType: Rectangle
Group: "TrafficSign"
LabelColor: {' '}
Attributes: []
Sublabels: []
Description: 'Bounding boxes for stop signs'
```

```
Name: "StopSign"
SignalType: PointCloud
LabelType: Cuboid
Group: "TrafficSign"
LabelColor: {' '}
Attributes: []
Sublabels: []
Description: 'Bounding boxes for stop signs'
```

Input Arguments

ldc — Label definition creator for multisignal workflow

`labelDefinitionCreatorMultisignal` object

Label definition creator for the multisignal workflow, specified as a `labelDefinitionCreatorMultisignal` object.

labelName — Label name

character vector | string scalar

Label name, specified as a character vector or string scalar that uniquely identifies the label to be added.

typeOfLabel — Type of label

`labelType` enumeration | character vector | string scalar

Type of label, specified as one of these values:

- `labelType` enumeration — You can use any of these `labelType` enumerators to specify the type of label: `Cuboid`, `Rectangle`, `Line`, `PixelLabel`, `Scene`, or `Custom`.

Note Adding a `Cuboid` or `Rectangle` also adds a `Rectangle` or `Cuboid` entry, respectively, to the label definitions table.

Example: `addLabel(ldc, 'Car', labelType.Cuboid);`

- Character vector or string scalar — This value must partially or fully match one of the `labelType` enumerators.

Example: `addLabel(ldc, 'Car', 'Cub');`

Name-Value Pair Arguments

Specify optional pairs of arguments as `Name1=Value1, ..., NameN=ValueN`, where `Name` is the argument name and `Value` is the corresponding value. Name-value arguments must appear after other arguments, but the order of the pairs does not matter.

Before R2021a, use commas to separate each name and value, and enclose `Name` in quotes.

Example:

```
addLabel(ldc, 'StopSign', 'Rectangle', 'Group', 'TrafficSign', 'Description', 'Bounding boxes for stop signs');
```

Group — Group name

'None' (default) | character vector | string scalar

Group name, specified as a comma-separated pair consisting of 'Group' and a character vector or string scalar. Use this name-value pair to specify a name for a group of labels.

Description — Label description

' ' (default) | character vector | string scalar

Label description, specified as a comma-separated pair consisting of 'Description' and a character vector or string scalar. Use this name-value pair to describe the label.

Version History

Introduced in R2020a

See Also

Objects

`labelDefinitionCreatorMultisignal` | `labelType`

Functions

`addSublabel` | `addAttribute` | `editLabelDescription` | `removeLabel`

addSublabel

Add sublabel to label in label definition creator object for multisignal workflow

Syntax

```
addSublabel(ldc, labelName, sublabelName, typeOfSublabel)
addSublabel( ____, Name, Value)
```

Description

`addSublabel(ldc, labelName, sublabelName, typeOfSublabel)` adds a sublabel with the specified name and type to the indicated label. The sublabel is added under the hierarchy for the specified label in the `labelDefinitionCreatorMultisignal` object `ldc`.

`addSublabel(____, Name, Value)` specifies options using one or more name-value pair arguments in addition to the input arguments in the previous syntax.

Examples

Add Sublabels to Labels in Label Definition Creator Object for Multisignal Workflow

Create an empty `labelDefinitionCreatorMultisignal` object.

```
ldc = labelDefinitionCreatorMultisignal;
```

Add a label with the name 'Vehicle'. Specify the type as 'Rectangle'. Adding a 'Rectangle' also adds a 'Cuboid' entry to the label definitions table.

```
addLabel(ldc, 'Vehicle', 'Rectangle');
```

Add a sublabel with the name 'Wheel' to the label 'Vehicle'. Specify the type of the sublabel as 'Rectangle'. Add a description to the sublabel.

```
addSublabel(ldc, 'Vehicle', 'Wheel', 'rect', 'Description', 'Bounding boxes for wheel');
```

Display the details of the updated `labelDefinitionCreatorMultisignal` object.

```
ldc
```

```
ldc =
labelDefinitionCreatorMultisignal contains the following labels:
```

```
    Vehicle with 1 sublabels and 0 attributes and belongs to None group.    (info)
```

For more details about attributes and sublabels, use the `info` method.

Display information about the label 'Vehicle' using the object function `info`.

```
info(ldc, 'Vehicle')
```

```
    Name: "Vehicle"
    SignalType: Image
```

```

    LabelType: Rectangle
      Group: "None"
    LabelColor: {' '}
    Attributes: []
    Sublabels: "Wheel"
    Description: ' '

    Name: "Vehicle"
    SignalType: PointCloud
    LabelType: Cuboid
      Group: "None"
    LabelColor: {' '}
    Attributes: []
    Sublabels: "Wheel"
    Description: ' '

```

Display information about the sublabel 'Wheel' in the label 'Vehicle' using the object function `info`.

```
info(ldc, 'Vehicle/Wheel')
```

```

    Name: "Wheel"
    Type: Rectangle
    LabelColor: ''
    Attributes: []
    Sublabels: []
    Description: 'Bounding boxes for wheel'

```

Add another label with the name 'TrafficLight'. Specify the type as 'Rectangle'. Add a description to the label.

```
addLabel(ldc, 'TrafficLight', 'Rectangle', 'Description', 'Bounding boxes for traffic light');
```

Add sublabels called 'RedLight' and 'GreenLight' to the label 'TrafficLight'. Specify the type of the sublabels as 'Rectangle'.

```
addSublabel(ldc, 'TrafficLight', 'RedLight', 'Rectangle');
addSublabel(ldc, 'TrafficLight', 'GreenLight', 'Rectangle');
```

Display the details of the updated `labelDefinitionCreatorMultisignal` object.

```
ldc
```

```
ldc =
labelDefinitionCreatorMultisignal contains the following labels:
```

```

    Vehicle with 1 sublabels and 0 attributes and belongs to None group.    (info)
    TrafficLight with 2 sublabels and 0 attributes and belongs to None group.  (info)

```

For more details about attributes and sublabels, use the `info` method.

Display information about the label 'TrafficLight' using the object function `info`.

```
info(ldc, 'TrafficLight')
```

```

    Name: "TrafficLight"
    SignalType: Image
    LabelType: Rectangle
    Group: "None"

```

```
LabelColor: {''}
Attributes: []
Sublabels: ["RedLight" "GreenLight"]
Description: 'Bounding boxes for traffic light'

Name: "TrafficLight"
SignalType: PointCloud
LabelType: Cuboid
Group: "None"
LabelColor: {''}
Attributes: []
Sublabels: ["RedLight" "GreenLight"]
Description: 'Bounding boxes for traffic light'
```

Input Arguments

ldc — Label definition creator for multisignal workflow

`labelDefinitionCreatorMultisignal` object

Label definition creator for the multisignal workflow, specified as a `labelDefinitionCreatorMultisignal` object.

labelName — Label name

character vector | string scalar

Label name, specified as a character vector or string scalar that uniquely identifies the label with which the sublabel is associated.

sublabelName — Sublabel name

character vector | string scalar

Sublabel name, specified as a character vector or string scalar that identifies the sublabel to be added.

typeOfSublabel — Type of sublabel

`labelType` enumeration | character vector | string scalar

Type of sublabel, specified as one of these values:

- `labelType` enumeration — The type of the sublabel must be one of these `labelType` enumerators: `Rectangle` or `Line`.

Example: `addSublabel(ldc, 'Car', 'Wheel', labelType.Rectangle);`

- Character vector or string scalar — This value must partially or fully match one of these `labelType` enumerators: `Rectangle` or `Line`.

Example: `addSublabel(ldc, 'Car', 'Wheel', 'Rec');`

Name-Value Pair Arguments

Specify optional pairs of arguments as `Name1=Value1, ..., NameN=ValueN`, where `Name` is the argument name and `Value` is the corresponding value. Name-value arguments must appear after other arguments, but the order of the pairs does not matter.

Before R2021a, use commas to separate each name and value, and enclose Name in quotes.

Example: `addSublabel(ldc,'Car','Wheel','Rec','Description','Bounding box for Wheel');`

Description – Sublabel description

' ' (default) | character vector | string scalar

Sublabel description, specified as a comma-separated pair consisting of 'Description' and a character vector or string scalar. Use this name-value pair to describe the sublabel.

Version History

Introduced in R2020a

See Also

Objects

labelDefinitionCreatorMultisignal | labelType

Functions

addLabel | addAttribute | removeSublabel

create

Create label definitions table from label definition creator object for multisignal workflow

Syntax

```
labelDefs = create(ldc)
```

Description

`labelDefs = create(ldc)` creates a label definitions table, `labelDefs`, from the `labelDefinitionCreatorMultisignal` object `ldc`. You can import the `labelDefs` table into the **Ground Truth Labeler** app to label ground truth data.

Examples

Create Label Definitions Table from Label Definition Creator Object for Multisignal Workflow

Create an empty `labelDefinitionCreatorMultisignal` object.

```
ldc = labelDefinitionCreatorMultisignal;
```

Add a label called 'Vehicle'. Specify the label type as 'Rectangle' and add a description to the label.

```
addLabel(ldc, 'Vehicle', 'Rectangle', 'Description', 'Bounding box for the vehicle. Use this label f
```

Add an attribute 'IsCar' to the label 'Vehicle'. Specify the attribute type as 'logical' with the value `true` and add a description for the attribute.

```
addAttribute(ldc, 'Vehicle', 'IsCar', 'logical', true, 'Description', 'Type of vehicle')
```

Add an attribute 'IsBus' to the label 'Vehicle'. Specify the attribute type as 'logical' with the value `false` and add a description for the attribute.

```
addAttribute(ldc, 'Vehicle', 'IsBus', 'logical', false, 'Description', 'Type of vehicle')
```

Create a label definitions table from the definitions stored in the object.

```
labelDefs = create(ldc)
```

`labelDefs=2×7 table`

Name	SignalType	LabelType	Group	Description
{'Vehicle'}	Image	Rectangle	{'None'}	{'Bounding box for the vehicle. Use th
{'Vehicle'}	PointCloud	Cuboid	{'None'}	{'Bounding box for the vehicle. Use th

Input Arguments

ldc — Label definition creator for multisignal workflow

`labelDefinitionCreatorMultisignal` object

Label definition creator for the multisignal workflow, specified as a `labelDefinitionCreatorMultisignal` object. The object defines the labels, sublabels, and attributes used for generating the label definitions table `labelDefs`.

Output Arguments

labelDefs — Label definitions

table

Label definitions, returned as a table with up to eight columns. The possible columns are *Name*, *SignalType*, *LabelType*, *Group*, *Description*, *LabelColor*, *PixelLabelID*, and *Hierarchy*. This table specifies the definitions of labels, sublabels, and attributes for labeling ground truth data. For more details, see `LabelDefinitions` property of `groundTruthMultisignal` object.

Version History

Introduced in R2020a

See Also

Objects

`labelDefinitionCreatorMultisignal`

Functions

`addLabel` | `addSublabel` | `addAttribute` | `info`

editAttributeDescription

Modify attribute description in label definition creator object for multisignal workflow

Syntax

```
editAttributeDescription(ldc, labelName, attributeName, description)
```

Description

`editAttributeDescription(ldc, labelName, attributeName, description)` modifies the description of an attribute under the label or sublabel identified by `labelName`. The label or sublabel must be associated with the `labelDefinitionCreatorMultisignal` object `ldc`.

Examples

Modify Attribute Description in Label Definition Creator Object for Multisignal Workflow

Create an empty `labelDefinitionCreatorMultisignal` object.

```
ldc = labelDefinitionCreatorMultisignal;
```

Add a label called 'TrafficLight'.

```
addLabel(ldc, 'TrafficLight', labelType.Rectangle);
```

Add a sublabel named 'RedLight' for label 'TrafficLight'.

```
addSublabel(ldc, 'TrafficLight', 'RedLight', labelType.Rectangle);
```

Add an attribute named 'Active' to the label 'TrafficLight'. Set the attribute type as 'Logical' with the default value true.

```
addAttribute(ldc, 'TrafficLight', 'Active', attributeType.Logical, true);
```

Add an attribute called 'isOn' to the sublabel 'RedLight'. Set the attribute type as 'Logical' with the default value false.

```
addAttribute(ldc, 'TrafficLight/RedLight', 'isOn', attributeType.Logical, false);
```

Modify the Attribute Description Under a Label

Display information about the label 'TrafficLight'.

```
info(ldc, 'TrafficLight')  
  
    Name: "TrafficLight"  
SignalType: Image  
LabelType: Rectangle  
Group: "None"  
LabelColor: {''}  
Attributes: "Active"
```

```

    Sublabels: "RedLight"
    Description: ' '

    Name: "TrafficLight"
    SignalType: PointCloud
    LabelType: Cuboid
    Group: "None"
    LabelColor: {' '}
    Attributes: "Active"
    Sublabels: "RedLight"
    Description: ' '

```

Modify the description of the attribute 'Active' under the label 'TrafficLight'.

```
editAttributeDescription(ldc, 'TrafficLight', 'Active', 'Is Active: true (DefaultValue: 1), false (DefaultValue: 0)')
```

Display information about the label 'TrafficLight' to verify the modified attribute description.

```
info(ldc, 'TrafficLight/Active')
```

```

    Name: "Active"
    Type: Logical
    DefaultValue: 1
    Description: 'Is Active: true (DefaultValue: 1), false (DefaultValue: 0)'

```

Modify the Attribute Description Under a Sublabel

Display information about the sublabel 'RedLight'.

```
info(ldc, 'TrafficLight/RedLight')
```

```

    Name: "RedLight"
    Type: Rectangle
    LabelColor: ' '
    Attributes: "isOn"
    Sublabels: []
    Description: ' '

```

Modify the description of the attribute 'isOn' under the sublabel 'RedLight'.

```
editAttributeDescription(ldc, 'TrafficLight/RedLight', 'isOn', 'Is On: true (DefaultValue: 1), false (DefaultValue: 0)')
```

Display information about the sublabel 'RedLight' to verify the modified attribute description.

```
info(ldc, 'TrafficLight/RedLight/isOn')
```

```

    Name: "isOn"
    Type: Logical
    DefaultValue: 0
    Description: 'Is On: true (DefaultValue: 1), false (DefaultValue: 0)'

```

Input Arguments

ldc — Label definition creator for multisignal workflow

labelDefinitionCreatorMultisignal object

Label definition creator for the multisignal workflow, specified as a labelDefinitionCreatorMultisignal object.

labelName — Label or sublabel name

character vector | string scalar

Label or sublabel name, specified as a character vector or string scalar that uniquely identifies the label or sublabel to which the attribute is associated.

- To specify a label, use the form *'labelName'*.

Example: `editAttributeDescription(ldc,'TrafficLight','Active','Is Active: true (DefaultValue: 1), false (DefaultValue: 0)')`

- To specify a sublabel, use the form *'labelName/sublabelName'*. In this case, the attribute is associated with the sublabel.

Example: `editAttributeDescription(ldc,'TrafficLight/RedLight','isOn','Is On: true (DefaultValue: 1), false (DefaultValue: 0)')`

attributeName — Attribute name

character vector | string scalar

Attribute name, specified as a character vector or string scalar that identifies the attribute for which the description is to be modified.

description — Description

character vector | string scalar

Description, specified as a character vector or string scalar that contains a new description for the attribute identified by `attributeName`.

Version History

Introduced in R2020a

See Also

Objects

labelDefinitionCreatorMultisignal

Functions

editLabelDescription

editGroupName

Change group name in label definition creator object for multisignal workflow

Syntax

```
editGroupName(ldc,oldname,newname)
```

Description

`editGroupName(ldc,oldname,newname)` changes the group name from `oldname` to `newname`. This function changes the group name in all the label definitions that have the `oldname`.

Examples

Rename Label Group in Label Definition Creator Object for Multisignal Workflow

Create an empty `labelDefinitionCreatorMultisignal` object.

```
ldc = labelDefinitionCreatorMultisignal;
```

Add labels named 'Car' and 'Truck' in a group named 'Vehicle'.

```
addLabel(ldc,'Car',labelType.Rectangle,'Group','Vehicle');
addLabel(ldc,'Truck',labelType.Rectangle,'Group','Vehicle');
```

Change the 'Vehicle' group name 'FourWheeler'.

```
editGroupName(ldc,'Vehicle','FourWheeler');
```

Display the details of the updated `labelDefinitionCreatorMultisignal` object.

```
ldc
```

```
ldc =
```

```
labelDefinitionCreatorMultisignal contains the following labels:
```

```
    Car with 0 sublabels and 0 attributes and belongs to FourWheeler group.    (info)
    Truck with 0 sublabels and 0 attributes and belongs to FourWheeler group.  (info)
```

For more details about attributes and sublabels, use the `info` method.

Input Arguments

ldc — Label definition creator for multisignal workflow

`labelDefinitionCreatorMultisignal` object

Label definition creator for the multisignal workflow, specified as a `labelDefinitionCreatorMultisignal` object.

oldname — Old group name

character vector | string scalar

Old group name, specified as a character vector or string scalar that uniquely identifies group name you want to modify.

newname — New group name

character vector | string scalar

New group name, specified as a character vector or string scalar that uniquely identifies the new group name.

Version History

Introduced in R2020a

See Also

Objects

labelDefinitionCreatorMultisignal

Functions

editLabelDescription | editLabelGroup

editLabelDescription

Modify label or sublabel description in label definition creator object for multisignal workflow

Syntax

```
editLabelDescription(ldc, labelName, description)
```

Description

`editLabelDescription(ldc, labelName, description)` modifies the description of a label or sublabel identified by `labelName`. The label or sublabel must be associated with the `labelDefinitionCreatorMultisignal` object `ldc`.

Examples

Modify Description of Label and Sublabel in Label Definition Creator Object for Multisignal Workflow

Create an empty `labelDefinitionCreatorMultisignal` object.

```
ldc = labelDefinitionCreatorMultisignal;
```

Add a label with the name 'TrafficLight'. Specify the type of label as 'Rectangle'.

```
addLabel(ldc, 'TrafficLight', 'Rectangle')
```

Add a sublabel called 'Light' to the label 'TrafficLight'. Specify the type of the sublabel as 'Rectangle'.

```
addSublabel(ldc, 'TrafficLight', 'Light', 'Rectangle')
```

Modify Label Description

Display information about the label 'TrafficLight'.

```
info(ldc, 'TrafficLight')
```

```

    Name: "TrafficLight"
SignalType: Image
  LabelType: Rectangle
    Group: "None"
LabelColor: {' '}
Attributes: []
  Sublabels: "Light"
Description: ' '
```

```

    Name: "TrafficLight"
SignalType: PointCloud
  LabelType: Cuboid
    Group: "None"
LabelColor: {' '}
Attributes: []
```

```
    Sublabels: "Light"  
    Description: ' '
```

Modify the description for the label 'TrafficLight'.

```
editLabelDescription(ldc, 'TrafficLight', 'Bounding box for the traffic light')
```

Display information about the label 'TrafficLight' to verify the modified label description.

```
info(ldc, 'TrafficLight')
```

```
    Name: "TrafficLight"  
    SignalType: Image  
    LabelType: Rectangle  
    Group: "None"  
    LabelColor: {''}  
    Attributes: []  
    Sublabels: "Light"  
    Description: 'Bounding box for the traffic light'
```

```
    Name: "TrafficLight"  
    SignalType: PointCloud  
    LabelType: Cuboid  
    Group: "None"  
    LabelColor: {''}  
    Attributes: []  
    Sublabels: "Light"  
    Description: 'Bounding box for the traffic light'
```

Modify Sublabel Description

Display information about the sublabel 'Light' under the label 'TrafficLight'.

```
info(ldc, 'TrafficLight/Light')
```

```
    Name: "Light"  
    Type: Rectangle  
    LabelColor: ''  
    Attributes: []  
    Sublabels: []  
    Description: ' '
```

Modify the description for the sublabel 'Light'.

```
editLabelDescription(ldc, 'TrafficLight/Light', 'Bounding box around each light of the Traffic light')
```

Display information about the sublabel 'Light' under the label 'TrafficLight' to verify the modified sublabel description.

```
info(ldc, 'TrafficLight/Light')
```

```
    Name: "Light"  
    Type: Rectangle  
    LabelColor: ''  
    Attributes: []  
    Sublabels: []  
    Description: 'Bounding box around each light of the Traffic light'
```

Input Arguments

ldc — Label definition creator for multisignal workflow

labelDefinitionCreatorMultisignal object

Label definition creator for the multisignal workflow, specified as a labelDefinitionCreatorMultisignal object.

labelName — Label or sublabel name

character vector | string scalar

Label or sublabel name, specified as a character vector or string scalar that uniquely identifies the label or sublabel for which the description is to be modified.

- To specify a label, use the form *'labelName'*.

Example: `editLabelDescription(ldc,'TrafficLight','Bounding box for the traffic light')`

- To specify a sublabel, use the form *'labelName/sublabelName'*.

Example: `editLabelDescription(ldc,'TrafficLight/Light','Bounding box around each light of the Traffic light')`

description — Description

character vector | string scalar

Description, specified as a character vector or string scalar that contains the new description for the label or sublabel identified by `labelName`.

Version History

Introduced in R2020a

See Also

Objects

labelDefinitionCreatorMultisignal | groundTruthMultisignal

Functions

editAttributeDescription

editLabelGroup

Modify label group name in label definition creator object for multisignal workflow

Syntax

```
editLabelGroup(ldc, labelName, groupName)
```

Description

`editLabelGroup(ldc, labelName, groupName)` modifies the group name that corresponds to the label identified by `labelName`. The label must be associated with the `labelDefinitionCreatorMultisignal` object `ldc`.

Examples

Modify Group Name for Labels in Label Definition Creator Object for Multisignal Workflow

Create an empty `labelDefinitionCreatorMultisignal` object.

```
ldc = labelDefinitionCreatorMultisignal;
```

Add a label named 'Car' in a group named 'Vehicle'. Set the type of the label as 'Rectangle'. Adding a 'Rectangle' also adds a 'Cuboid' entry to the label definitions table.

```
addLabel(ldc, 'Car', 'Rectangle', 'Group', 'Vehicle')
```

Display information about the group name of the label 'Car' using the object function `info`.

```
info(ldc, 'Car')
```

```

    Name: "Car"
SignalType: Image
  LabelType: Rectangle
    Group: "Vehicle"
LabelColor: {' '}
Attributes: []
  Sublabels: []
Description: ' '
```

```

    Name: "Car"
SignalType: PointCloud
  LabelType: Cuboid
    Group: "Vehicle"
LabelColor: {' '}
Attributes: []
  Sublabels: []
Description: ' '
```

Add a label named 'Truck' to group named 'FourWheeler'. Set the type of the label as 'Rectangle'.

```
addLabel(ldc, 'Truck', labelType.Rectangle, 'Group', 'FourWheeler')
```

Move the 'Car' label into the 'FourWheeler' group.

```
editLabelGroup(ldc, 'Car', 'FourWheeler')
```

Display information about the label 'Car' to confirm the group name of the label is changed from 'Vehicle' to 'FourWheeler' using the object function `info`.

```
info(ldc, 'Car')
```

```

    Name: "Car"
SignalType: Image
  LabelType: Rectangle
    Group: "FourWheeler"
LabelColor: {' '}
Attributes: []
  Sublabels: []
Description: ' '
```

```

    Name: "Car"
SignalType: PointCloud
  LabelType: Cuboid
    Group: "FourWheeler"
LabelColor: {' '}
Attributes: []
  Sublabels: []
Description: ' '
```

Input Arguments

ldc — Label definition creator for multisignal workflow

`LabelDefinitionCreatorMultisignal` object

Label definition creator for the multisignal workflow, specified as a `LabelDefinitionCreatorMultisignal` object.

labelName — Label name

character vector | string scalar

Label name, specified as a character vector or string scalar that uniquely identifies the label that corresponds to the `groupName` you want to modify.

groupName — Group name

character vector | string scalar

Group name, specified as a character vector or string scalar that identifies the group you want to modify, which corresponds to the label specified by `labelName`.

Version History

Introduced in R2020a

See Also

Objects

labelDefinitionCreatorMultisignal

Functions

editLabelDescription | editGroupName

info

Display label, sublabel, or attribute information stored in label definition creator object for multisignal workflow

Syntax

```
info(ldc,name)
infoStruct = info(ldc,name)
```

Description

`info(ldc,name)` displays information about the specified label, sublabel, or attribute stored in the `labelDefinitionCreatorMultisignal` object `ldc`.

`infoStruct = info(ldc,name)` returns the information as a structure.

Examples

Display Information On Definitions Stored in Label Definition Creator Object for Multisignal Workflow

Load an existing label definition table.

```
labelDefFile = fullfile(toolboxdir('driving'),'drivingdata','labelDefsMultiSignal.mat');
ld = load(labelDefFile)
```

```
ld = struct with fields:
    labelDefs: [6x6 table]
```

Create a `labelDefinitionCreatorMultisignal` object from the label definitions table.

```
ldc = labelDefinitionCreatorMultisignal(ld.labelDefs)
```

```
ldc =
labelDefinitionCreatorMultisignal contains the following labels:
```

```
    Car with 0 sublabels and 0 attributes and belongs to None group.    (info)
    LeftLane with 0 sublabels and 0 attributes and belongs to None group. (info)
    Road with 0 sublabels and 0 attributes and belongs to None group.    (info)
    Sunny with 0 sublabels and 0 attributes and belongs to None group.    (info)
    Urban with 0 sublabels and 0 attributes and belongs to None group.    (info)
```

For more details about attributes and sublabels, use the `info` method.

Add an attribute 'Color' to the label 'Car'. Specify the attribute type as 'List' and add items to the list.

```
addAttribute(ldc,'Car','Color','List',{'Red','Green','Blue'});
```

Display the details of the updated `labelDefinitionCreatorMultisignal` object.

```
ldc
```

```
ldc =
```

```
labelDefinitionCreatorMultisignal contains the following labels:
```

```
    Car with 0 sublabels and 1 attributes and belongs to None group.    (info)
    LeftLane with 0 sublabels and 0 attributes and belongs to None group. (info)
    Road with 0 sublabels and 0 attributes and belongs to None group.    (info)
    Sunny with 0 sublabels and 0 attributes and belongs to None group.    (info)
    Urban with 0 sublabels and 0 attributes and belongs to None group.    (info)
```

For more details about attributes and sublabels, use the `info` method.

Display information about the attribute 'Color' under the label 'Car'.

```
colorStruct = info(ldc, 'Car/Color')
```

```
colorStruct = struct with fields:
    Name: "Color"
    Type: List
    ListItems: {'Red' 'Green' 'Blue'}
    Description: ' '
```

Display the field `ListItems` in the 'Color' attribute of the label 'Car'.

```
colorStruct.ListItems
```

```
ans = 1x3 cell
    {'Red'}    {'Green'}    {'Blue'}
```

Input Arguments

ldc — Label definition creator for multisignal workflow

`labelDefinitionCreatorMultisignal` object

Label definition creator for the multisignal workflow, specified as a `labelDefinitionCreatorMultisignal` object.

name — Name of label, sublabel, or attribute

character vector | string scalar

Name of label, sublabel, or attribute in the `ldc` object, specified as a character vector or string scalar whose form depends on the type of name you specify.

- To specify a label, use the form '*labelName*'.

Example: `info(ldc, 'TrafficLight')`

- To specify a sublabel, use the form '*labelName/sublabelName*'.

Example: `info(ldc, 'TrafficLight/RedLight')`

- To specify an attribute, use the form '*labelName/attributeName*' or '*labelName/sublabelName/attributeName*'.

Example: `info(ldc, 'TrafficLight/Active')`

Example: `info(ldc, 'TrafficLight/RedLight/isOn')`

Output Arguments

infoStruct – Information structure

structure

Information structure, returned as a structure that contains the fields `Name`, `SignalType` (for labels), `LabelType` (for labels), `Type` (for sublabels and attributes), `Description`, `Attributes` (when pertinent), `Sublabels` (when pertinent), `DefaultValue` (for attributes), and `ListItems` (for List attributes).

Version History

Introduced in R2020a

See Also

Objects

`labelDefinitionCreatorMultisignal`

Functions

`addLabel` | `create`

removeAttribute

Remove attribute from label or sublabel in label definition creator object for multisignal workflow

Syntax

```
removeAttribute(ldc, labelName, attributeName)
```

Description

`removeAttribute(ldc, labelName, attributeName)` removes the specified attribute from the indicated label or sublabel in the `labelDefinitionCreatorMultisignal` object `ldc`.

Examples

Remove Attributes from Label and Sublabel in Label Definition Creator Object for Multisignal Workflow

Create an empty `labelDefinitionCreatorMultisignal` object.

```
ldc = labelDefinitionCreatorMultisignal;
```

Add a label with the name 'TrafficLight'. Specify the type of label as 'Rectangle'. Adding a 'Rectangle' also adds a 'Cuboid' entry to the label definitions table.

```
addLabel(ldc, 'TrafficLight', 'Rectangle')
```

Add attribute 'Active' to the label. Specify the attribute type as 'Logical' with the value `true`.

```
addAttribute(ldc, 'TrafficLight', 'Active', 'Logical', true)
```

Display information about the attributes under the label 'TrafficLight' using the object function `info`.

```
info(ldc, 'TrafficLight')
```

```
      Name: "TrafficLight"  
SignalType: Image  
LabelType: Rectangle  
Group: "None"  
LabelColor: {''}  
Attributes: "Active"  
Sublabels: []  
Description: ' '
```

```
      Name: "TrafficLight"  
SignalType: PointCloud  
LabelType: Cuboid  
Group: "None"  
LabelColor: {''}  
Attributes: "Active"  
Sublabels: []  
Description: ' '
```

Remove the attribute 'Active' from the label 'TrafficLight'.

```
removeAttribute(ldc, 'TrafficLight', 'Active')
```

Add a sublabel called 'RedLight' to the label 'TrafficLight'. Specify the type of the sublabel as 'Rectangle'.

```
addSublabel(ldc, 'TrafficLight', 'RedLight', 'Rectangle')
```

Add an attribute 'isOn' to the sublabel 'RedLight'. Specify the type for the attribute 'isOn' as 'Logical' with the value false.

```
addAttribute(ldc, 'TrafficLight/RedLight', 'isOn', 'Logical', false)
```

Display information about the attributes under the sublabel 'RedLight' in the label 'TrafficLight' using the object function info.

```
info(ldc, 'TrafficLight/RedLight')
```

```

    Name: "RedLight"
    Type: Rectangle
    LabelColor: ''
    Attributes: "isOn"
    Sublabels: []
    Description: ''

```

Remove the attribute 'isOn' from the sublabel 'RedLight'.

```
removeAttribute(ldc, 'TrafficLight/RedLight', 'isOn')
```

Display information about the label 'TrafficLight' using the object function info, to confirm that the attribute 'Active' has been removed from the label definitions.

```
info(ldc, 'TrafficLight')
```

```

    Name: "TrafficLight"
    SignalType: Image
    LabelType: Rectangle
    Group: "None"
    LabelColor: {' '}
    Attributes: []
    Sublabels: "RedLight"
    Description: ''

```

```

    Name: "TrafficLight"
    SignalType: PointCloud
    LabelType: Cuboid
    Group: "None"
    LabelColor: {' '}
    Attributes: []
    Sublabels: "RedLight"
    Description: ''

```

Display information about the sublabel 'RedLight' in the label 'TrafficLight' using the object function info, to confirm that the attribute 'isOn' has been removed from the label definitions.

```
info(ldc, 'TrafficLight/RedLight')
```

```

    Name: "RedLight"
    Type: Rectangle

```

```
LabelColor: ''  
Attributes: []  
Sublabels: []  
Description: ''
```

Input Arguments

ldc — Label definition creator for multisignal workflow

`labelDefinitionCreatorMultisignal` object

Label definition creator for the multisignal workflow, specified as a `labelDefinitionCreatorMultisignal` object.

labelName — Label or sublabel name

character vector | string scalar

Label or sublabel name, specified as a character vector or string scalar that uniquely identifies the label or sublabel from which the attribute is to be removed.

- To specify a label, use the form '*labelName*'.

Example: `removeAttribute(ldc, 'TrafficLight', 'Active')`

- To specify a sublabel, use the form '*labelName/sublabelName*'. In this case, the attribute associates with the sublabel.

Example: `removeAttribute(ldc, 'TrafficLight/RedLight', 'isOn')`

attributeName — Attribute name

character vector | string scalar

Attribute name, specified as a character vector or string scalar that identifies the attribute to be removed from the label or sublabel indicated by `labelName`.

Version History

Introduced in R2020a

See Also

Objects

`labelDefinitionCreatorMultisignal`

Functions

`removeLabel` | `addLabel` | `addAttribute`

removeLabel

Remove label from label definition creator object for multisignal workflow

Syntax

```
removeLabel(ldc, labelName)
```

Description

`removeLabel(ldc, labelName)` removes the specified label from the `labelDefinitionCreatorMultisignal` object `ldc`.

Note Removing a label also removes any sublabels or attributes associated with that label.

Examples

Remove Label from Label Definition Creator Object for Multisignal Workflow

Load an existing label definitions table into the workspace.

```
labelDefFile = fullfile(toolboxdir('driving'),'drivingdata','labelDefsMultiSignal.mat');
ld = load(labelDefFile)

ld = struct with fields:
    labelDefs: [6x6 table]
```

Create a `labelDefinitionCreatorMultisignal` object from the label definitions table.

```
ldc = labelDefinitionCreatorMultisignal(ld.labelDefs)
```

```
ldc =
```

`labelDefinitionCreatorMultisignal` contains the following labels:

```
    Car with 0 sublabels and 0 attributes and belongs to None group.    (info)
    LeftLane with 0 sublabels and 0 attributes and belongs to None group. (info)
    Road with 0 sublabels and 0 attributes and belongs to None group.   (info)
    Sunny with 0 sublabels and 0 attributes and belongs to None group.  (info)
    Urban with 0 sublabels and 0 attributes and belongs to None group.  (info)
```

For more details about attributes and sublabels, use the `info` method.

Remove the label called 'Car'.

```
removeLabel(ldc, 'Car');
```

Display the details of the updated `labelDefinitionCreatorMultisignal` object to confirm that the label has been removed.

```
ldc
```

```
ldc =  
labelDefinitionCreatorMultisignal contains the following labels:  
  
    LeftLane with 0 sublabels and 0 attributes and belongs to None group.    (info)  
    Road with 0 sublabels and 0 attributes and belongs to None group.        (info)  
    Sunny with 0 sublabels and 0 attributes and belongs to None group.        (info)  
    Urban with 0 sublabels and 0 attributes and belongs to None group.        (info)
```

For more details about attributes and sublabels, use the `info` method.

Input Arguments

ldc — Label definition creator for multisignal workflow

`labelDefinitionCreatorMultisignal` object

Label definition creator for the multisignal workflow, specified as a `labelDefinitionCreatorMultisignal` object.

labelName — Label name

character vector | string scalar

Label name, specified as a character vector or string scalar that uniquely identifies the label to be removed from the `ldc` object.

Version History

Introduced in R2020a

See Also

Objects

`labelDefinitionCreatorMultisignal`

Functions

`addLabel` | `removeSublabel` | `removeAttribute`

removeSublabel

Remove sublabel from label in label definition creator object for multisignal workflow

Syntax

```
removeSublabel(ldc, labelName, sublabelName)
```

Description

`removeSublabel(ldc, labelName, sublabelName)` removes the specified sublabel from the indicated label. This label must be associated with the `labelDefinitionCreatorMultisignal` object `ldc`.

Note Removing a sublabel also removes any attributes associated with that sublabel.

Examples

Remove Sublabel from Label in Label Definition Creator Object for Multisignal Workflow

Create an empty `labelDefinitionCreatorMultisignal` object.

```
ldc = labelDefinitionCreatorMultisignal;
```

Add a label with the name 'TrafficLight'. Specify the type of label as 'Rectangle' and add a description. Adding a 'Rectangle' also adds a 'Cuboid' entry to the label definitions table.

```
addLabel(ldc, 'TrafficLight', labelType.Rectangle, 'Description', 'Bounding boxes for traffic light')
```

Add sublabels called 'RedLight', 'GreenLight' and 'YellowLight' to the label 'TrafficLight'. Specify the type of the sublabels as 'Rectangle'.

```
addSublabel(ldc, 'TrafficLight', 'RedLight', 'Rectangle')
addSublabel(ldc, 'TrafficLight', 'GreenLight', 'rect')
addSublabel(ldc, 'TrafficLight', 'YellowLight', labelType.Rectangle)
```

Display information about the label 'TrafficLight' using the object function `info`, to confirm that the sublabels have been added to the label definitions.

```
info(ldc, 'TrafficLight')
    Name: "TrafficLight"
    SignalType: Image
    LabelType: Rectangle
    Group: "None"
    LabelColor: {''}
    Attributes: []
    Sublabels: ["RedLight" "GreenLight" "YellowLight"]
    Description: 'Bounding boxes for traffic light'

    Name: "TrafficLight"
```

```
SignalType: PointCloud
LabelType: Cuboid
Group: "None"
LabelColor: {''}
Attributes: []
Sublabels: ["RedLight" "GreenLight" "YellowLight"]
Description: 'Bounding boxes for traffic light'
```

Remove the sublabel 'YellowLight' from the label 'TrafficLight'.

```
removeSublabel(ldc, 'TrafficLight', 'YellowLight')
```

Display information about the label 'TrafficLight' using the object function `info`, to confirm that the sublabel 'YellowLight' has been removed from the label definitions.

```
info(ldc, 'TrafficLight')
```

```
      Name: "TrafficLight"
SignalType: Image
LabelType: Rectangle
Group: "None"
LabelColor: {''}
Attributes: []
Sublabels: ["RedLight" "GreenLight"]
Description: 'Bounding boxes for traffic light'
```

```
      Name: "TrafficLight"
SignalType: PointCloud
LabelType: Cuboid
Group: "None"
LabelColor: {''}
Attributes: []
Sublabels: ["RedLight" "GreenLight"]
Description: 'Bounding boxes for traffic light'
```

Input Arguments

ldc — Label definition creator for multisignal workflow

`labelDefinitionCreatorMultisignal` object

Label definition creator for the multisignal workflow, specified as a `labelDefinitionCreatorMultisignal` object.

labelName — Label name

character vector | string scalar

Label name, specified as a character vector or string scalar that uniquely identifies the label with which the sublabel is associated.

sublabelName — Sublabel name

character vector | string scalar

Sublabel name, specified as a character vector or string scalar that identifies the sublabel to be removed from the indicated label `labelName`.

Version History

Introduced in R2020a

See Also

Objects

labelDefinitionCreatorMultisignal

Functions

removeLabel | removeAttribute | addLabel | addSublabel

ROILabelData

Ground truth data for ROI labels

Description

The ROILabelData object stores ground truth data for region of interest (ROI) label definitions for each signal in a groundTruthMultisignal object.

Creation

When you export a groundTruthMultisignal object from a **Ground Truth Labeler** app session, the ROILabelData property of the exported object stores the ROI labels as an ROILabelData object. To create an ROILabelData object programmatically, use the vision.labeler.labeldata.ROILabelData function (described here).

Syntax

```
roiLabelData = vision.labeler.labeldata.ROILabelData(signalNames, labelData)
```

Description

roiLabelData = vision.labeler.labeldata.ROILabelData(signalNames, labelData) creates an object containing ROI label data for multiple signals. The created object, roiLabelData, contains properties with the signal names listed in signalNames. These properties store the corresponding ROI label data specified by labelData.

Input Arguments

signalNames — Signal names

string array

Signal names, specified as a string array. Specify the names of all signals present in the groundTruthMultisignal object you are creating. You can get the signal names from an existing groundTruthMultisignal object by accessing the DataSource property of that object. Use this command and replace gTruth with the name of your groundTruthMultisignal object variable.

```
gTruth.DataSource.SignalName
```

In an exported groundTruthMultisignal object, the ROILabelData object contains a label data property for each signal, even if some signals do not have ROI label data.

The properties of the created ROILabelData object have the names specified by signalNames.

Example: ["video_01_city_c2s_fcw_10s" "lidarSequence"]

labelData — ROI label data for each signal

cell array of timetables

ROI label data for each signal, specified as a cell array of timetables. Each timetable in the cell array contains data for the signal in the corresponding position of the `signalNames` input. The `ROILabelData` object stores each timetable in a property that has the same name as that signal.

The timetable format for each signal depends on data from the `groundTruthMultisignal` object that you exported or are creating.

Each timetable contains one column per label definition stored in the `LabelDefinitions` property of the `groundTruthMultisignal` object. Label definitions that the signal type does not support are excluded. For example, suppose you define a `Line` ROI label named `'lane'`. The timetable for a lidar point cloud signal does not include a `lane` column, because these signals do not support `Line` ROI labels. In the `DataSource` property of the `groundTruthMultisignal` object, the `SignalType` property of each data source lists the valid signal types.

The height of the timetable is defined by the number of timestamps in the signal. In the `DataSource` property of the `groundTruthMultisignal` object, the `Timestamp` property of each data source lists the signal timestamps.

For each label definition, all ROI labels marked at that timestamps are combined into a single cell in the table. Consider the ROI label data for a video signal stored in a `groundTruthMultisignal` object, `gTruth`. At each timestamp, `car` contains three labels, `truck` contains one label, and `lane` contains two labels.

```
gTruth.ROILabelData.video_01_city_c2s_fcw_10s
```

```
ans =
```

```
5x4 timetable
```

Time	car	truck	lane
0 sec	{3x4 double}	{1x4 double}	{2x1 cell }
0.05 sec	{3x4 double}	{1x4 double}	{2x1 cell }
0.1 sec	{3x4 double}	{1x4 double}	{2x1 cell }
0.15 sec	{3x4 double}	{1x4 double}	{2x1 cell }
0.2 sec	{3x4 double}	{1x4 double}	{2x1 cell }

The storage format for ROI label data depends on the label type.

Label Type	Storage Format for Labels at Each Timestamp
<code>labelType.Rectangle</code>	<p>M-by-4 numeric matrix of the form $[x, y, w, h]$, where:</p> <ul style="list-style-type: none"> <code>M</code> is the number of labels in the frame. <code>x</code> and <code>y</code> specify the upper-left corner of the rectangle. <code>w</code> specifies the width of the rectangle, which is its length along the x-axis. <code>h</code> specifies the height of the rectangle, which is its length along the y-axis.

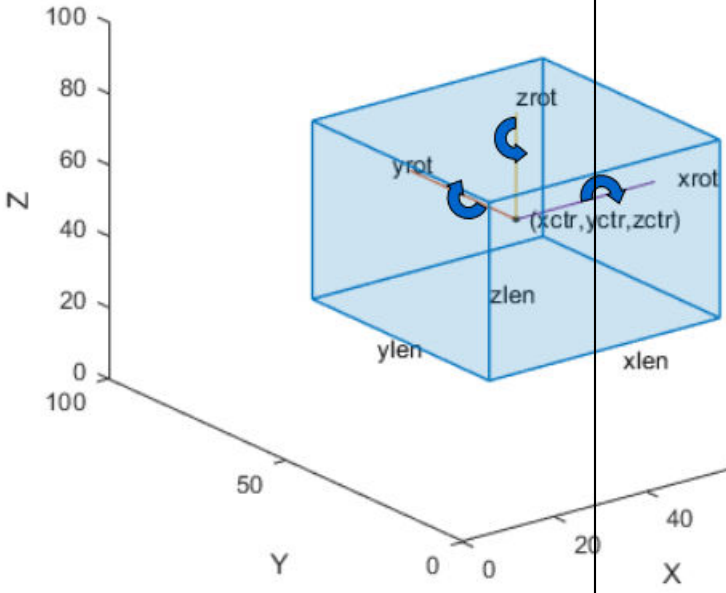
Label Type	Storage Format for Labels at Each Timestamp
labelType.Cuboid	<p>M-by-9 numeric matrix with rows of the form [xctr, yctr, zctr, xlen, ylen, zlen, xrot, yrot, zrot], where:</p> <ul style="list-style-type: none"> • M is the number of labels in the frame. • xctr, yctr, and zctr specify the center of the cuboid. • xlen, ylen, and zlen specify the length of the cuboid along the x-axis, y-axis, and z-axis, respectively, before rotation has been applied. • xrot, yrot, and zrot specify the rotation angles for the cuboid along the x-axis, y-axis, and z-axis, respectively. These angles are clockwise-positive when looking in the forward direction of their corresponding axes. <p>The figure shows how these values determine the position of a cuboid.</p> 

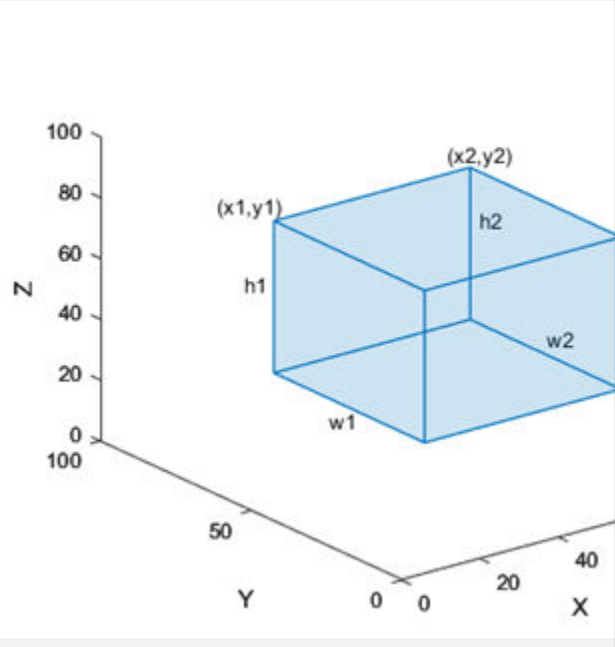
Label Type	Storage Format for Labels at Each Timestamp
labelType.ProjectectedCuboid	<p>M-by-8 vector of the form [x1, y1, w1, h1, x2, y2, w2, h2], where:</p> <ul style="list-style-type: none"> • M is the number of labels in the frame. • x1, y1 specifies the x,y coordinates for the upper-left location of the front-face of the projected cuboid • w1 specifies the width for the front-face of the projected cuboid. • h1 specifies the height for the front-face of the projected cuboid. • x2, y2 specifies the x,y coordinates for the upper-left location of the back-face of the projected cuboid. • w2 specifies the width for the back-face of the projected cuboid. • h2 specifies the height for the back-face of the projected cuboid. <p>The figure shows how these values determine the position of a cuboid.</p> 
labelType.Line	<p>M-by-1 vector of cell arrays, where M is the number of labels in the frame. Each cell array contains an N-by-2 numeric matrix of the form [x1 y1; x2 y2; ... ; xN yN] for N points in the polyline.</p>

Label Type	Storage Format for Labels at Each Timestamp
<code>labelType.PixelLabel</code>	Label data for all pixel label definitions is stored in a single M -by-1 <code>PixelLabelData</code> column for M images or frames. Each element contains a filename for a pixel label image. A pixel label image describes the label or labels contained in the corresponding image. The labels can be described as a 1- or 3- channel label matrix. To use <code>PixelLabelData</code> with any of the labeler apps, you must use a single-channel label matrix, where the values are of type <code>uint8</code> . You can convert a 3-channel pixel label data matrix to a single-channel label matrix programmatically to use with the labeler apps.
<code>labelType.Polygon</code>	M -by-1 vector of cell arrays, where M is the number of labels. Each cell array contains an N -by-2 numeric matrix of the form $[x1\ y1; x2\ y2; \dots; xN\ yN]$ for N points in the polygon.
<code>labelType.Custom</code>	Labels are stored exactly as they are specified in the timetable. If you import a <code>groundTruthMultisignal</code> object containing custom label data into the Ground Truth Labeler app, this data is not imported into the app. Use custom data when gathering label data for training and combining it with data labeled in the app.

If the ROI label data includes sublabels or attributes, then the labels at each timestamp must be specified as structures instead. The structure includes these fields.

Label Structure Field	Description
<code>Position</code>	Positions of the parent labels at the given timestamp The format of <code>Position</code> depends on the label type. These formats are described in the previous table.
<code>AttributeName1, ..., AttributeNameN</code>	Attributes of the parent labels Each defined sublabel has its own field, where the name of the field corresponds to the attribute name. The attribute value is a character vector for a <code>List</code> or <code>String</code> attribute, a numeric scalar for a <code>Numeric</code> attribute, or a logical scalar for a <code>Logical</code> attribute. If the attribute is unspecified, then the attribute value is an empty vector.

Label Structure Field	Description	
SublabelName1, ..., SublabelNameN	<p>Sublabels of the parent labels</p> <p>Each defined sublabel has its own field, where the name of the field corresponds to the sublabel name. The value of each sublabel field is a structure containing the data for all marked sublabels with that name at the given timestamp.</p> <p>This table describes the format of this sublabel structure.</p>	
	Sublabel Structure Field	Description
	Position	<p>Positions of the sublabels at the given timestamp</p> <p>The format of Position depends on the label type. These formats are described in the previous table.</p>
AttributeName1, ..., AttributeNameN	<p>Attributes of the sublabels</p> <p>Each defined sublabel has its own field, where the name of the field corresponds to the attribute name. The attribute value is a character vector for a List or String attribute, a numeric scalar for a Numeric attribute, or a logical scalar for a Logical attribute. If you leave an attribute unspecified, then the attribute value is an empty vector.</p>	

Properties

SignalName1, ..., SignalNameN — ROI label data for each signal (as separate properties)
timetables

ROI label data, specified as timetables. The ROILabelData object contains one property per signal, where each property contains a timetable of ROI label data corresponding to that signal.

When exporting an `ROILabelData` object from a **Ground Truth Labeler** app session, the property names correspond to the signal names stored in the `DataSource` property of the exported `groundTruthMultisignal` object.

When creating an `ROILabelData` object programmatically, the `signalNames` and `labelData` input arguments define the property names and values of the created object.

Suppose you want to create a `groundTruthMultisignal` object containing a video signal and a lidar point cloud sequence signal. Specify the signals in a string array, `signalNames`.

```
signalNames = ["video_01_city_c2s_fcw_10s" "lidarSequence"];
```

Store the video ROI labels, `videoData`, and lidar point cloud sequence ROI labels, `lidarData`, in a cell array of timetables, `labelData`. Each timetable contains the data for the corresponding signal in `signalNames`.

```
labelData = {videoData, lidarData}

    1×2 cell array

    {204×2 timetable}    {34×1 timetable}
```

The `ROILabelData` object, `roiData`, stores this data in the property with the corresponding signal name. You can specify `roiData` in the `ROILabelData` property of a `groundTruthMultisignal` object.

```
roiData = vision.labeler.labeldata.ROILabelData(signalNames, labelData)

roiData =

    ROILabelData with properties:

        video_01_city_c2s_fcw_10s: [204×2 timetable]
        lidarSequence: [34×1 timetable]
```

Examples

Create Ground Truth from Multiple Signals

Create ground truth data for a video signal and a lidar point cloud sequence signal that captures the same driving scene. Specify the signal sources, label definitions, and ROI and scene label data.

Create the video data source from an MP4 file.

```
sourceName = '01_city_c2s_fcw_10s.mp4';
sourceParams = [];
vidSource = vision.labeler.loading.VideoSource;
vidSource.loadSource(sourceName, sourceParams);
```

Create the point cloud sequence source from a folder of point cloud data (PCD) files.

```
pcSeqFolder = fullfile(toolboxdir('driving'), 'drivingdata', 'lidarSequence');
addpath(pcSeqFolder)
load timestamps.mat
rmpath(pcSeqFolder)
```



```
lidarSourceData = load(fullfile(pcSeqFolder, 'timestamps.mat'));

sourceName = pcSeqFolder;
sourceParams = struct;
sourceParams.Timestamps = timestamps;

pcseqSource = vision.labeler.loading.PointCloudSequenceSource;
pcseqSource.loadSource(sourceName, sourceParams);
```

Combine the signal sources into an array.

```
dataSource = [vidSource pcseqSource]
```

```
dataSource =
```

```
1x2 heterogeneous MultiSignalSource (VideoSource, PointCloudSequenceSource) array with properties:
```

```
    SourceName
    SourceParams
    SignalName
    SignalType
    Timestamp
    NumSignals
```

Create a table of label definitions for the ground truth data by using a `labelDefinitionCreatorMultisignal` object.

- The Car label definition appears twice. Even though Car is defined as a rectangle, you can draw rectangles only for image signals, such as videos. The `labelDefinitionCreatorMultisignal` object creates an additional row for lidar point cloud signals. In these signal types, you can draw Car labels as cuboids only.
- The label definitions have no descriptions and no assigned colors, so the `Description` and `LabelColor` columns are empty.
- The label definitions have no assigned groups, so for all label definitions, the corresponding cell in the `Group` column is set to 'None'.
- Road is a pixel label definition, so the table includes a `PixelLabelID` column.
- No label definitions have sublabels or attributes, so the table does not include a `Hierarchy` column for storing such information.

```
ldc = labelDefinitionCreatorMultisignal;
addLabel(ldc, 'Car', 'Rectangle');
addLabel(ldc, 'Truck', 'ProjectedCuboid');
addLabel(ldc, 'Lane', 'Line');
addLabel(ldc, 'Road', 'PixelLabel');
addLabel(ldc, 'Sunny', 'Scene');
labelDefs = create(ldc)
```

```
labelDefs =
```

```
7x7 table
```

Name	SignalType	LabelType	Group	Description	LabelColor	PixelLabelID
------	------------	-----------	-------	-------------	------------	--------------

{'Car' }	Image	Rectangle	{'None' }	{' ' }	{0x0 char}	{0x0 char}
{'Car' }	PointCloud	Cuboid	{'None' }	{' ' }	{0x0 char}	{0x0 char}
{'Truck' }	Image	ProjectedCuboid	{'None' }	{' ' }	{0x0 char}	{0x0 char}
{'Lane' }	Image	Line	{'None' }	{' ' }	{0x0 char}	{0x0 char}
{'Lane' }	PointCloud	Line	{'None' }	{' ' }	{0x0 char}	{0x0 char}
{'Road' }	Image	PixelLabel	{'None' }	{' ' }	{0x0 char}	{[
{'Sunny' }	Time	Scene	{'None' }	{' ' }	{0x0 char}	{0x0 char}

Create ROI label data for the first frame of the video.

```
numVideoFrames = numel(vidSource.Timestamp{1});
carData = cell(numVideoFrames,1);
laneData = cell(numVideoFrames,1);
truckData = cell(numVideoFrames,1);
carData{1} = [304 212 37 33];
laneData{1} = [70 458; 311 261];
truckData{1} = [309,215,33,24,330,211,33,24];
videoData = timetable(vidSource.Timestamp{1},carData,laneData, ...
    'VariableNames',{'Car','Lane'});
```

Create ROI label data for the first point cloud in the sequence.

```
numPCFrames = numel(pcseqSource.Timestamp{1});
carData = cell(numPCFrames, 1);
carData{1} = [27.35 18.32 -0.11 4.25 4.75 3.45 0 0 0];
lidarData = timetable(pcseqSource.Timestamp{1},carData, 'VariableNames',{'Car'});
```

Combine the ROI label data for both sources.

```
signalNames = [dataSource.SignalName];
roiData = vision.labeler.labeldata.ROILabelData(signalNames,{videoData,lidarData})
```

```
roiData =
```

```
ROILabelData with properties:
```

```
video_01_city_c2s_fcw_10s: [204x2 timetable]
lidarSequence: [34x1 timetable]
```

Create scene label data for the first 10 seconds of the driving scene.

```
sunnyData = seconds([0 10]);
labelNames = ["Sunny"];
sceneData = vision.labeler.labeldata.SceneLabelData(labelNames,{sunnyData})
```

```
sceneData =
```

```
SceneLabelData with properties:
```

```
Sunny: [0 sec 10 sec]
```

Create a ground truth object from the signal sources, label definitions, and ROI and scene label data. You can import this object into the **Ground Truth Labeler** app for manual labeling or to run a

labeling automation algorithm on it. You can also extract training data from this object for deep learning models by using the `gatherLabelData` function.

```
gTruth = groundTruthMultisignal(dataSource, labelDefs, roiData, sceneData)
```

```
gTruth =
```

```
groundTruthMultisignal with properties:
```

```
DataSource: [1x2 vision.labeler.loading.MultiSignalSource]  
LabelDefinitions: [7x7 table]  
ROILabelData: [1x1 vision.labeler.labeldata.ROILabelData]  
SceneLabelData: [1x1 vision.labeler.labeldata.SceneLabelData]
```

Version History

Introduced in R2020a

See Also

Apps

Ground Truth Labeler

Objects

SceneLabelData | groundTruthMultisignal

SceneLabelData

Ground truth data for scene labels

Description

The `SceneLabelData` object stores ground truth data for scene label definitions defined in a `groundTruthMultisignal` object.

Creation

When you export a `groundTruthMultisignal` object from a **Ground Truth Labeler** app session, the `SceneLabelData` property of the exported object stores the scene labels as a `SceneLabelData` object. To create a `SceneLabelData` object programmatically, use the `vision.labeler.labeldata.SceneLabelData` function (described here).

Syntax

```
sceneLabelData = vision.labeler.labeldata.SceneLabelData(labelNames,  
labelData)
```

Description

`sceneLabelData = vision.labeler.labeldata.SceneLabelData(labelNames, labelData)` creates an object containing scene label data for multiple signals. The created object, `sceneLabelData`, contains properties with the scene label names listed in `labelNames`. These properties store the corresponding scene label data specified by `labelData`.

Input Arguments

labelNames — Scene label names

string array

Scene label names, specified as a string array. Specify the names of all scene labels present in the `groundTruthMultisignal` object you are creating. You can get the scene label names from an existing `groundTruthMultisignal` object by accessing the `LabelDefinitions` property of that object. Use this code and replace `gTruth` with the name of a `groundTruthMultisignal` object variable.

```
isSceneLabel = gTruth.LabelDefinitions.LabelType == 'Scene';  
gTruth.LabelDefinitions.Name(isSceneLabel)
```

In an exported `groundTruthMultisignal` object, the `SceneLabelData` object contains a label data property for every scene label, even if some scene labels do not have label data.

The properties of the created `SceneLabelData` object have the names specified by `labelNames`.

Example: `["sunny" "rainy" "urban" "rural"]`

LabelData — Scene label data for each label

cell array of duration matrices

Scene label data for each label, specified as a cell array of duration matrices. Each matrix in the cell array contains data for the scene label in the corresponding position of the `labelNames` input. The `SceneLabelData` object stores each matrix in a property that has the same name as that signal.

Each scene label matrix is of size N -by-2. Each row in this matrix corresponds to a time range for which that scene label has been applied. N is the number of time ranges. Rows in the matrix are of the form `[rangeStart, rangeEnd]`, where `rangeStart` and `rangeEnd` specify the start and end of a time range for an applied scene label.

Row elements are of type `duration` and must be within the range of the minimum and maximum of all the timestamps in the `groundTruthMultisignal` object. If a scene label is not applied, then specify an empty matrix.

Example: `seconds([0 5; 10 20])` specifies a duration matrix corresponding to one scene label in a `groundTruthMultisignal` object. Units are in seconds. The scene label has been applied from 0 to 5 seconds and again from 10 to 20 seconds, across all signals in the object. Specify this matrix as part of a cell array containing matrices for additional scene labels.

Properties

SceneLabelName1, . . . , SceneLabelNameN — Scene label data for each label (as separate properties)

duration matrices

Scene label data, specified as duration matrices. The `SceneLabelData` object contains one property per scene label definition, where each property contains a duration matrix of scene label data corresponding to that scene label.

When exporting a `SceneLabelData` object from a **Ground Truth Labeler** app session, the property names correspond to the scene label names stored in the `LabelDefinitions` property of the exported `groundTruthMultisignal` object.

When creating a `SceneLabelData` object programmatically, the `labelNames` and `labelData` input arguments define the property names and values of the created object.

Suppose you want to create a `groundTruthMultisignal` object containing scene labels that describe whether the scene is sunny, rainy, urban, or rural. Specify the scene labels in a string array, `labelNames`.

```
labelNames = ["sunny" "rainy" "urban" "rural"];
```

Store the label data for each scene label in a cell array of matrices, `labelData`. Each matrix contains the data for the corresponding scene label in `labelNames`.

```
labelData = {sunnyData, rainyData, urbanData, ruralData}
```

```
1×4 cell array
```

```
{1×2 duration} {2×2 duration} {0×0 duration} {4×2 duration}
```

The `SceneLabelData` object, `sceneData`, stores this data in the property with the corresponding signal name. You can specify `sceneData` in the `SceneLabelData` property of a `groundTruthMultisignal` object.

```
sceneData = vision.labeler.labeldata.SceneLabelData(labelNames, labelData)
```

```
sceneData =
```

```
SceneLabelData with properties:
```

```
rainy: [2x2 duration]
sunny: [0 sec    10.15 sec]
rural: [4x2 duration]
urban: [0x0 duration]
```

Object Functions

labelDefinitionsAtTime Get scene label definition names at specified timestamp

labelDataAtTime Get scene label data at specified timestamps

Examples

Create Ground Truth from Multiple Signals

Create ground truth data for a video signal and a lidar point cloud sequence signal that captures the same driving scene. Specify the signal sources, label definitions, and ROI and scene label data.

Create the video data source from an MP4 file.

```
sourceName = '01_city_c2s_fcw_10s.mp4';
sourceParams = [];
vidSource = vision.labeler.loading.VideoSource;
vidSource.loadSource(sourceName, sourceParams);
```

Create the point cloud sequence source from a folder of point cloud data (PCD) files.

```
pcSeqFolder = fullfile(toolboxdir('driving'), 'drivingdata', 'lidarSequence');
addpath(pcSeqFolder)
load timestamps.mat
rmpath(pcSeqFolder)
```

```
lidarSourceData = load(fullfile(pcSeqFolder, 'timestamps.mat'));
```

```
sourceName = pcSeqFolder;
sourceParams = struct;
sourceParams.Timestamps = timestamps;
```

```
pcseqSource = vision.labeler.loading.PointCloudSequenceSource;
pcseqSource.loadSource(sourceName, sourceParams);
```

Combine the signal sources into an array.

```
dataSource = [vidSource pcseqSource]
```

```
dataSource =
```

```
1x2 heterogeneous MultiSignalSource (VideoSource, PointCloudSequenceSource) array with properties:
```

```
SourceName
```

```
SourceParams
SignalName
SignalType
Timestamp
NumSignals
```

Create a table of label definitions for the ground truth data by using a `labelDefinitionCreatorMultisignal` object.

- The Car label definition appears twice. Even though Car is defined as a rectangle, you can draw rectangles only for image signals, such as videos. The `labelDefinitionCreatorMultisignal` object creates an additional row for lidar point cloud signals. In these signal types, you can draw Car labels as cuboids only.
- The label definitions have no descriptions and no assigned colors, so the `Description` and `LabelColor` columns are empty.
- The label definitions have no assigned groups, so for all label definitions, the corresponding cell in the `Group` column is set to `'None'`.
- Road is a pixel label definition, so the table includes a `PixelLabelID` column.
- No label definitions have sublabels or attributes, so the table does not include a `Hierarchy` column for storing such information.

```
ldc = labelDefinitionCreatorMultisignal;
addLabel(ldc, 'Car', 'Rectangle');
addLabel(ldc, 'Truck', 'ProjectedCuboid');
addLabel(ldc, 'Lane', 'Line');
addLabel(ldc, 'Road', 'PixelLabel');
addLabel(ldc, 'Sunny', 'Scene');
labelDefs = create(ldc)
```

labelDefs =

7x7 table

Name	SignalType	LabelType	Group	Description	LabelColor	PixelLabelID
{'Car' }	Image	Rectangle	{'None'}	{' '}	{0x0 char}	{0x0 char}
{'Car' }	PointCloud	Cuboid	{'None'}	{' '}	{0x0 char}	{0x0 char}
{'Truck' }	Image	ProjectedCuboid	{'None'}	{' '}	{0x0 char}	{0x0 char}
{'Lane' }	Image	Line	{'None'}	{' '}	{0x0 char}	{0x0 char}
{'Lane' }	PointCloud	Line	{'None'}	{' '}	{0x0 char}	{0x0 char}
{'Road' }	Image	PixelLabel	{'None'}	{' '}	{0x0 char}	{0x0 char}
{'Sunny' }	Time	Scene	{'None'}	{' '}	{0x0 char}	{0x0 char}

Create ROI label data for the first frame of the video.

```
numVideoFrames = numel(vidSource.Timestamp{1});
carData = cell(numVideoFrames,1);
laneData = cell(numVideoFrames,1);
truckData = cell(numVideoFrames,1);
carData{1} = [304 212 37 33];
laneData{1} = [70 458; 311 261];
truckData{1} = [309,215,33,24,330,211,33,24];
```

```
videoData = timetable(vidSource.Timestamp{1},carData,laneData, ...  
                    'VariableNames',{'Car','Lane'});
```

Create ROI label data for the first point cloud in the sequence.

```
numPCFrames = numel(pcseqSource.Timestamp{1});  
carData = cell(numPCFrames, 1);  
carData{1} = [27.35 18.32 -0.11 4.25 4.75 3.45 0 0 0];  
lidarData = timetable(pcseqSource.Timestamp{1},carData,'VariableNames',{'Car'});
```

Combine the ROI label data for both sources.

```
signalNames = [dataSource.SignalName];  
roiData = vision.labeler.labeldata.ROILabelData(signalNames,{videoData,lidarData})
```

```
roiData =
```

```
ROILabelData with properties:
```

```
    video_01_city_c2s_fcw_10s: [204x2 timetable]  
        lidarSequence: [34x1 timetable]
```

Create scene label data for the first 10 seconds of the driving scene.

```
sunnyData = seconds([0 10]);  
labelNames = ["Sunny"];  
sceneData = vision.labeler.labeldata.SceneLabelData(labelNames,{sunnyData})
```

```
sceneData =
```

```
SceneLabelData with properties:
```

```
    Sunny: [0 sec    10 sec]
```

Create a ground truth object from the signal sources, label definitions, and ROI and scene label data. You can import this object into the **Ground Truth Labeler** app for manual labeling or to run a labeling automation algorithm on it. You can also extract training data from this object for deep learning models by using the `gatherLabelData` function.

```
gTruth = groundTruthMultisignal(dataSource,labelDefs,roiData,sceneData)
```

```
gTruth =
```

```
groundTruthMultisignal with properties:
```

```
    DataSource: [1x2 vision.labeler.loading.MultiSignalSource]  
    LabelDefinitions: [7x7 table]  
    ROILabelData: [1x1 vision.labeler.labeldata.ROILabelData]
```



```
SceneLabelData: [1x1 vision.labeler.labeldata.SceneLabelData]
```

Tips

- To create a `groundTruthMultisignal` object containing ROI label data but no scene label data, specify the `SceneLabelData` property as an empty array. To create this array, at the MATLAB command prompt, enter this code.

```
sceneData = vision.labeler.labeldata.SceneLabelData.empty
```

Version History

Introduced in R2020a

See Also

Apps

Ground Truth Labeler

Objects

ROILabelData | groundTruthMultisignal

labelDefinitionsAtTime

Get scene label definition names at specified timestamp

Syntax

```
labelNames = labelDefinitionsAtTime(sceneData,timestamp)
```

Description

`labelNames = labelDefinitionsAtTime(sceneData,timestamp)` returns the scene label definition names that are applied at the specified timestamp in a `SceneLabelData` object, `sceneData`.

Examples

Get Scene Label Definition Names at Timestamp

Get the scene label definition names that are applied at the first timestamp of a `SceneLabelData` object.

Create a `SceneLabelData` object. The object has labels for specifying whether a scene is sunny, rainy, urban, or rural. The scene labels are applied at these time ranges.

- "sunny" — 0 to 5 seconds
- "rainy" — 6 to 10 seconds
- "urban" — 0 to 8 seconds
- "rural" — 9 to 10 seconds

```
labelNames = ["sunny" "rainy" "urban" "rural"];
```

```
sunnyData = seconds([0 5]);  
rainyData = seconds([6 10]);  
urbanData = seconds([0 8]);  
ruralData = seconds([9 10]);
```

```
labelData = {sunnyData rainyData urbanData ruralData};  
sceneData = vision.labeler.labeldata.SceneLabelData(labelNames,labelData);
```

Get the scene labels that are applied at the start of the time range, that is, the first timestamp.

```
tsStart = 0;  
labelNamesAtStart = labelDefinitionsAtTime(sceneData,tsStart)
```

```
labelNamesAtStart = 1x2 string  
    "sunny"    "urban"
```

Input Arguments

sceneData — Scene label data

SceneLabelData object

Scene label data, specified as a SceneLabelData object.

timestamp — Timestamp

duration scalar

Timestamp, specified as a duration scalar.

Example: `seconds(9.5)` specifies a duration scalar of 9.5 seconds.

Output Arguments

labelNames — Scene label definition names

string vector

Scene label definition names, returned as a string vector. The vector contains the names of scene label definitions at the input `timestamp` in the input `sceneData`.

Version History

Introduced in R2020a

See Also

SceneLabelData | labelDataAtTime

labelDataAtTime

Get scene label data at specified timestamps

Syntax

```
labelData = labelDataAtTime(sceneData, labelNames, timestamps)
```

Description

`labelData = labelDataAtTime(sceneData, labelNames, timestamps)` returns the scene label data at the specified timestamps and for the specified label names present in a `SceneLabelData` object, `sceneData`.

Examples

Get Scene Label Data at Timestamps

Get the scene label data present at a specific time range in a `SceneLabelData` object.

Create a `SceneLabelData` object. The object has labels for specifying whether a scene is sunny, rainy, urban, or rural. The scene labels are applied at these time ranges.

- "sunny" — 0 to 5 seconds
- "rainy" — 6 to 10 seconds
- "urban" — 0 to 8 seconds
- "rural" — 9 to 10 seconds

```
labelNames = ["sunny" "rainy" "urban" "rural"];
```

```
sunnyData = seconds([0 5]);
rainyData = seconds([6 10]);
urbanData = seconds([0 8]);
ruralData = seconds([9 10]);
```

```
labelData = {sunnyData rainyData urbanData ruralData};
sceneData = vision.labeler.labeldata.SceneLabelData(labelNames, labelData);
```

Get the label data for the weather-related scene labels ("sunny" and "rainy") over the time range that the "urban" scene label is applied.

```
weatherLabelNames = ["sunny" "rainy"];
urbanTimestamps = seconds(0:8);
weatherLabelData = labelDataAtTime(sceneData, weatherLabelNames, urbanTimestamps)
```

```
weatherLabelData=9×2 timetable
    timeStamps    sunny    rainy
    _____    _____    _____
    0 sec         true     false
    1 sec         true     false
```

2 sec	true	false
3 sec	true	false
4 sec	true	false
5 sec	true	false
6 sec	false	true
7 sec	false	true
8 sec	false	true

Input Arguments

sceneData — Scene label data

SceneLabelData object

Scene label data, specified as a SceneLabelData object.

labelNames — Scene label names

string vector

Scene label names, specified as a string vector. The scene label names must be present in the sceneData input.

Example: ["sunny" "rainy"]

timestamps — Timestamps

duration vector

Timestamps, specified as a duration vector.

Example: seconds(5:10) specifies a duration vector from 5 to 10 seconds.

Output Arguments

labelData — Scene label data at specified timestamps

timetable

Scene label data at specified timestamps, returned as a timetable. The first column contains the timestamps specified by the timestamps input. The remaining columns correspond to the scene labels specified by the labelNames input. These columns contain logical 1 (true) and logical 0 (false) values that specify the scene labels present at each timestamp in the input sceneData.

Version History

Introduced in R2020a

See Also

SceneLabelData | labelDefinitionsAtTime

extendedObjectMesh

Mesh representation of extended object

Description

The `extendedObjectMesh` represents the 3-D geometry of an object. The 3-D geometry is represented by faces and vertices. Use these object meshes to specify the geometry of an actor for simulating lidar sensor data using `lidarPointCloudGenerator`.

Creation

Syntax

```
mesh = extendedObjectMesh('cuboid')
mesh = extendedObjectMesh('cylinder')
mesh = extendedObjectMesh('cylinder',n)
mesh = extendedObjectMesh('sphere')
mesh = extendedObjectMesh('sphere',n)
mesh = extendedObjectMesh(vertices,faces)
```

Description

`mesh = extendedObjectMesh('cuboid')` returns an `extendedObjectMesh` object, that defines a cuboid with unit dimensions. The origin of the cuboid is located at its geometric center.

`mesh = extendedObjectMesh('cylinder')` returns a hollow cylinder mesh with unit dimensions. The cylinder mesh has 20 equally spaced vertices around its circumference. The origin of the cylinder is located at its geometric center. The height is aligned with the z-axis.

`mesh = extendedObjectMesh('cylinder',n)` returns a cylinder mesh with n equally spaced vertices around its circumference.

`mesh = extendedObjectMesh('sphere')` returns a sphere mesh with unit dimensions. The sphere mesh has 119 vertices and 180 faces. The origin of the sphere is located at its center.

`mesh = extendedObjectMesh('sphere',n)` additionally allows you to specify the resolution, n , of the spherical mesh. The sphere mesh has $(n + 1)^2 - 2$ vertices and $2n(n - 1)$ faces.

`mesh = extendedObjectMesh(vertices,faces)` returns a mesh from faces and vertices. `vertices` and `faces` set the `Vertices` and `Faces` properties respectively.

Properties

Vertices — Vertices of defined object

N -by-3 matrix of real scalar

Vertices of the defined object, specified as an N -by-3 matrix of real scalars. N is the number of vertices. The first, second, and third element of each row represents the x -, y -, and z -position of each vertex, respectively.

Faces — Faces of defined object

M -by-3 matrix of positive integer

Faces of the defined object, specified as a M -by-3 array of positive integers. M is the number of faces. The three elements in each row are the vertex IDs of the three vertices forming the triangle face. The ID of the vertex is its corresponding row number specified in the `Vertices` property.

Object Functions

Use the object functions to develop new meshes.

<code>translate</code>	Translate mesh along coordinate axes
<code>rotate</code>	Rotate mesh about coordinate axes
<code>scale</code>	Scale mesh in each dimension
<code>applyTransform</code>	Apply forward transformation to mesh vertices
<code>join</code>	Join two object meshes
<code>scaleToFit</code>	Auto-scale object mesh to match specified cuboid dimensions
<code>show</code>	Display the mesh as a patch on the current axes

Examples

Create and Translate Cuboid Mesh

Create an `extendedObjectMesh` object and translate the object.

Construct a cuboid mesh.

```
mesh = extendedObjectMesh('cuboid');
```

Translate the mesh by 5 units along the negative y axis.

```
mesh = translate(mesh,[0 -5 0]);
```

Visualize the mesh.

```
ax = show(mesh);
ax.YLim = [-6 0];
```

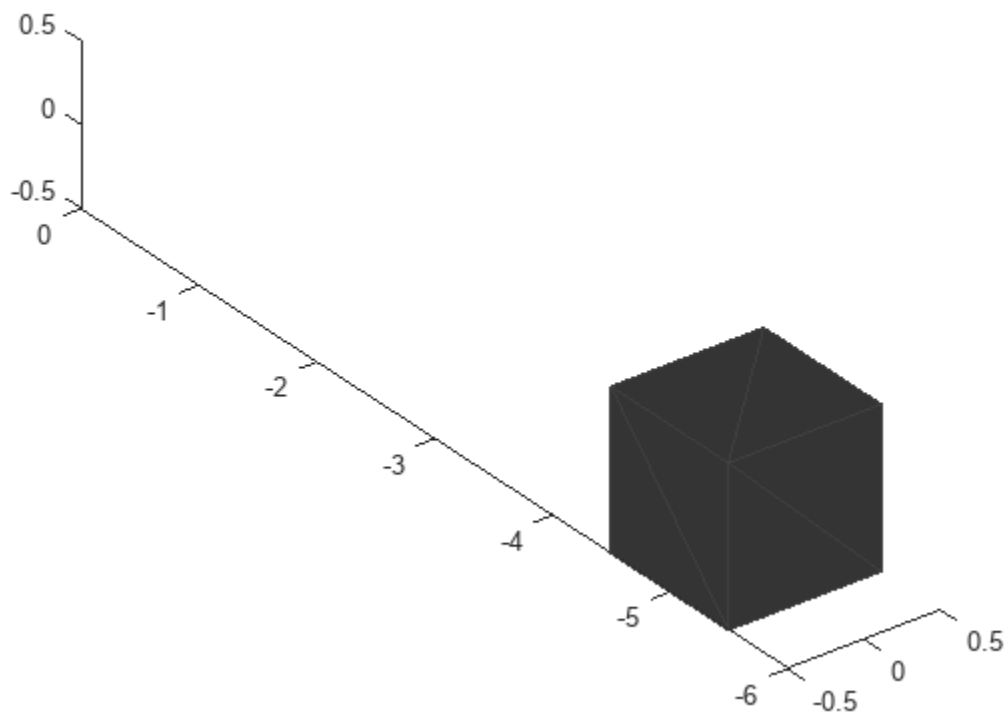

Create and Visualize Cylinder Mesh

Create an `extendedObjectMesh` object and visualize the object.

Construct a cylinder mesh.

```
mesh = extendedObjectMesh('cylinder');
```

Visualize the mesh.

```
ax = show(mesh);
```

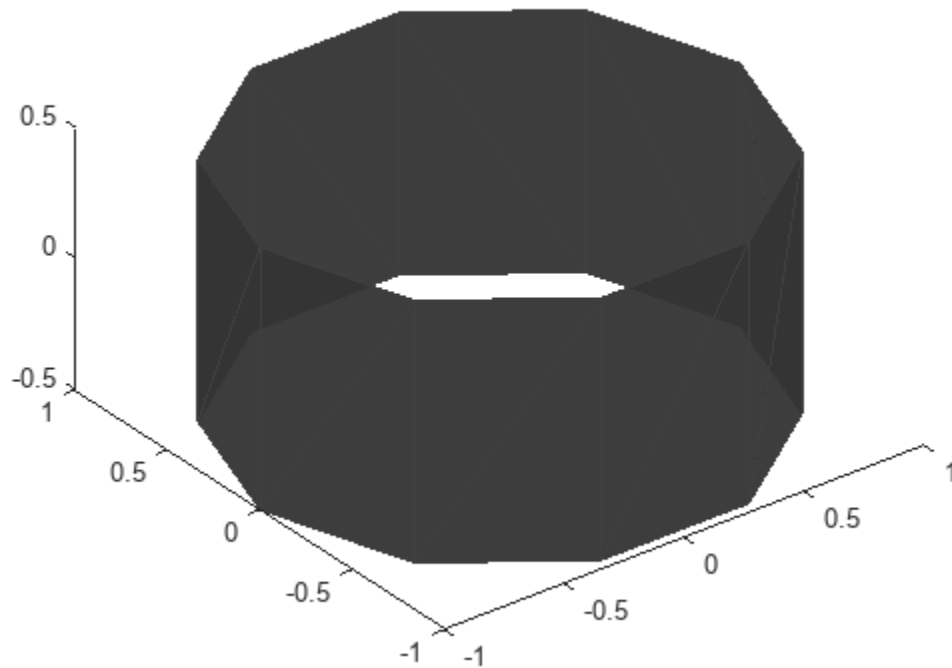
Create and Auto-Scale Sphere Mesh

Create an `extendedObjectMesh` object and auto-scale the object to the required dimensions.

Construct a sphere mesh of unit dimensions.

```
sph = extendedObjectMesh('sphere');
```

Auto-scale the mesh to the dimensions in `dims`.

```
dims = struct('Length',5,'Width',10,'Height',3,'OriginOffset',[0 0 -3]);  
sph = scaleToFit(sph,dims);
```

Visualize the mesh.

```
show(sph);
```

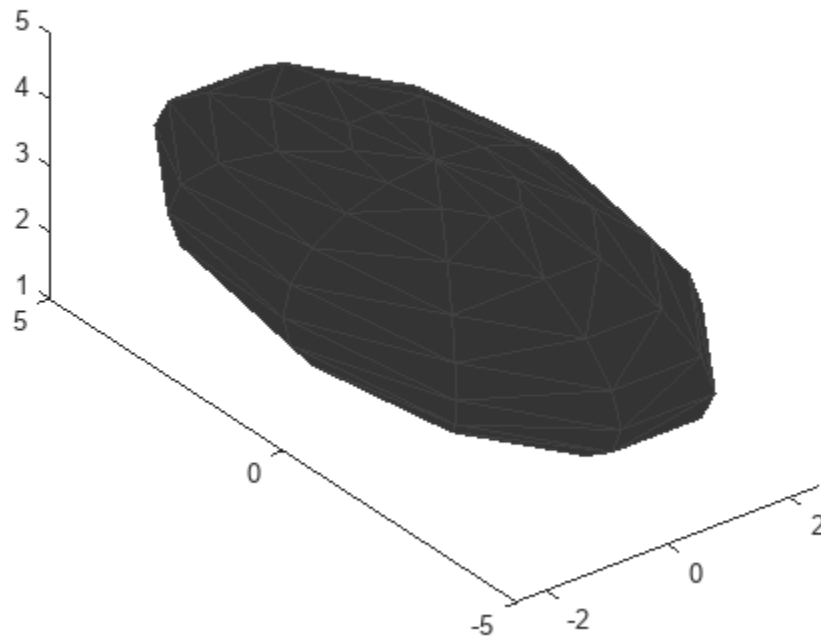

Pre-built Meshes

You can use the prebuilt meshes as a starting point to develop your own meshes. The table lists the details of the meshes.

<code>driving.scenario.bicycleMesh</code>	Mesh representation of bicycle in driving scenario
<code>driving.scenario.carMesh</code>	Mesh representation of car in driving scenario.
<code>driving.scenario.pedestrianMesh</code>	Mesh representation of pedestrian in driving scenario.
<code>driving.scenario.truckMesh</code>	Mesh representation of truck in driving scenario.

You can view the source files of the meshes to understand how to develop new meshes. At the MATLAB command line, enter:

```
edit driving.scenario.XXXMesh
```

Replace XXXMesh with the name of the mesh.

Version History

Introduced in R2020a

See Also

Objects

`drivingScenario` | `lidarPointCloudGenerator`

Functions

`driving.scenario.bicycleMesh` | `driving.scenario.carMesh` |
`driving.scenario.pedestrianMesh` | `driving.scenario.truckMesh` | `roadMesh` | `actor` |
`vehicle`

applyTransform

Apply forward transformation to mesh vertices

Syntax

```
transformedMesh = applyTransform(mesh,T)
```

Description

`transformedMesh = applyTransform(mesh,T)` applies the forward transformation matrix `T` to the vertices of the object mesh.

Examples

Create and Transform Cuboid Mesh

Create an `extendedObjectMesh` object and transform the object by using a transformation matrix.

Create a cuboid mesh of unit dimensions.

```
cuboid = extendedObjectMesh('cuboid');
```

Create a transformation matrix that is a combination of a translation, a scaling, and a rotation.

```
tform = makehgtform('translate',[0.2 -0.5 0.5], ...  
                  'scale',[0.5 0.6 0.7], ...  
                  'xrotate',pi/4);
```

Transform the mesh.

```
transformedCuboid = applyTransform(cuboid,tform);
```

Visualize the meshes.

```
subplot(1,2,1);  
show(cuboid);  
title('Initial Mesh')  
  
subplot(1,2,2);  
show(transformedCuboid);  
title('Transformed Mesh')
```

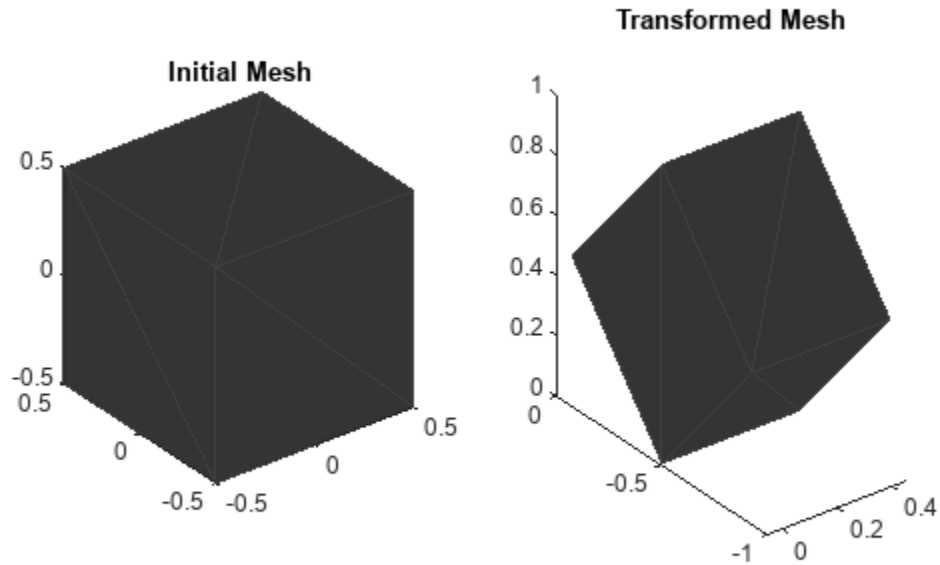

Input Arguments

mesh — Extended object mesh

`extendedObjectMesh` object

Extended object mesh, specified as an `extendedObjectMesh` object.

T — Transformation matrix

4-by-4 matrix

Transformation matrix applied on the object mesh, specified as a 4-by-4 matrix. The 3-D coordinates of each point in the object mesh is transformed according to this formula:

$$[x_T; y_T; z_T; 1] = T * [x; y; z; 1]$$

x_T , y_T , and z_T are the transformed 3-D coordinates of the point.

Data Types: `single` | `double`

Output Arguments

transformedMesh — Transformed object mesh

`extendedObjectMesh` object

Transformed object mesh, returned as an `extendedObjectMesh` object.

Version History

Introduced in R2020a

See Also

Objects

extendedObjectMesh

Functions

rotate | translate | scale | join | scaleToFit | show

join

Join two object meshes

Syntax

```
joinedMesh = join(mesh1,mesh2)
```

Description

`joinedMesh = join(mesh1,mesh2)` joins the object meshes `mesh1` and `mesh2` and returns `joinedMesh` with the combined objects.

Examples

Create and Join Two Object Meshes

Create `extendedObjectMesh` objects and join them together.

Construct two meshes of unit dimensions.

```
sph = extendedObjectMesh('sphere');  
cub = extendedObjectMesh('cuboid');
```

Join the two meshes.

```
cub = translate(cub,[0 0 1]);  
sphCub = join(sph,cub);
```

Visualize the final mesh.

```
show(sphCub);
```

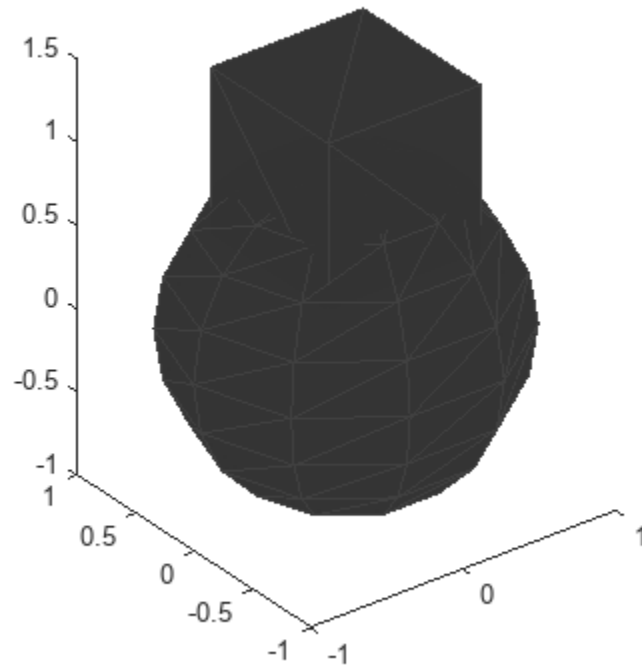

Input Arguments

mesh1 — Extended object mesh

`extendedObjectMesh` object

Extended object mesh, specified as an `extendedObjectMesh` object.

mesh2 — Extended object mesh

`extendedObjectMesh` object

Extended object mesh, specified as an `extendedObjectMesh` object.

Output Arguments

joinedMesh — Joined object mesh

`extendedObjectMesh` object

Joined object mesh, specified as an `extendedObjectMesh` object.

Version History

Introduced in R2020a

See Also

Objects

extendedObjectMesh

Functions

rotate | translate | scale | applyTransform | scaleToFit | show

rotate

Rotate mesh about coordinate axes

Syntax

```
rotatedMesh = rotate(mesh,orient)
```

Description

`rotatedMesh = rotate(mesh,orient)` rotate the mesh object by an orientation, `orient`.

Examples

Create and Rotate Cuboid Mesh

Create an `extendedObjectMesh` object and rotate the object.

Construct a cuboid mesh.

```
mesh = extendedObjectMesh('cuboid');
```

Rotate the mesh by 30 degrees around the z axis.

```
mesh = rotate(mesh,[30 0 0]);
```

Visualize the mesh.

```
ax = show(mesh);
```

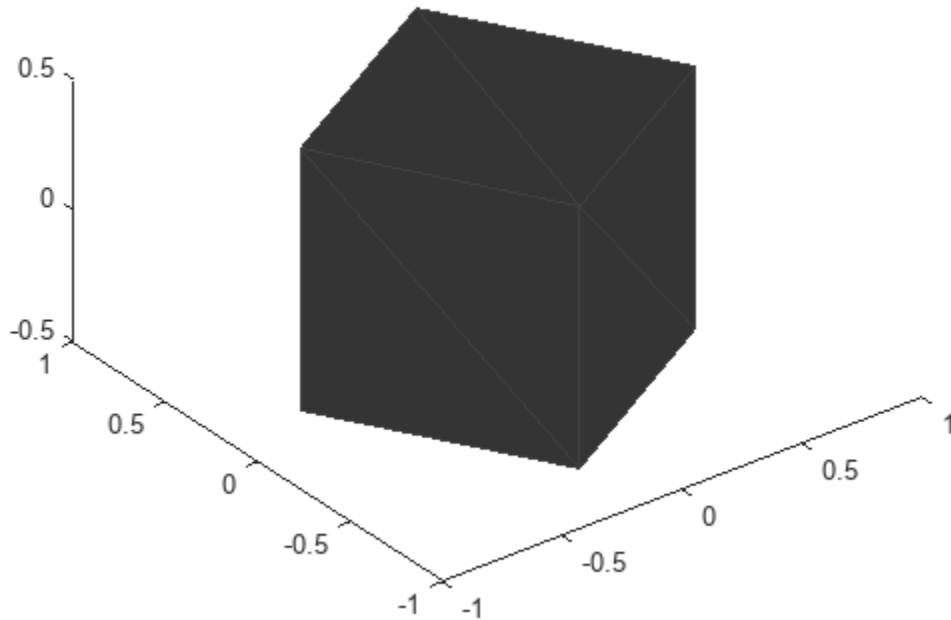

Input Arguments

mesh — Extended object mesh
extendedObjectMesh object

Extended object mesh, specified as an extendedObjectMesh object.

orient — Description of rotation
3-by-3 orthonormal matrix | quaternion | 1-by-3 vector

Description of rotation for an object mesh, specified as:

- 3-by-3 orthonormal rotation matrix
- quaternion
- 1-by-3 vector, where the elements are positive rotations in degrees about the z , y , and x axes, in that order.

Output Arguments

rotatedMesh — Rotated object mesh
extendedObjectMesh object

Rotated object mesh, returned as an extendedObjectMesh object.

Version History

Introduced in R2020a

See Also

Objects

extendedObjectMesh

Functions

translate | scale | applyTransform | join | scaleToFit | show

scale

Scale mesh in each dimension

Syntax

```
scaledMesh = scale(mesh,scaleFactor)
scaledMesh = scale(mesh,[sx sy sz])
```

Description

`scaledMesh = scale(mesh,scaleFactor)` scales the object mesh by `scaleFactor`. `scaleFactor` can be the same for all dimensions or defined separately as elements of a 1-by-3 vector in the order *x*, *y*, and *z*.

`scaledMesh = scale(mesh,[sx sy sz])` scales the object mesh along the dimensions *x*, *y*, and *z* by the scaling factors *sx*, *sy*, and *sz*.

Examples

Create and Scale Cuboid Mesh

Create an `extendedObjectMesh` object and scale the object.

Construct a cuboid mesh of unit dimensions.

```
cuboid = extendedObjectMesh('cuboid');
```

Scale the mesh by different factors along each of the three axes.

```
scaledCuboid = scale(cuboid,[100 30 20]);
```

Visualize the mesh.

```
show(scaledCuboid);
```

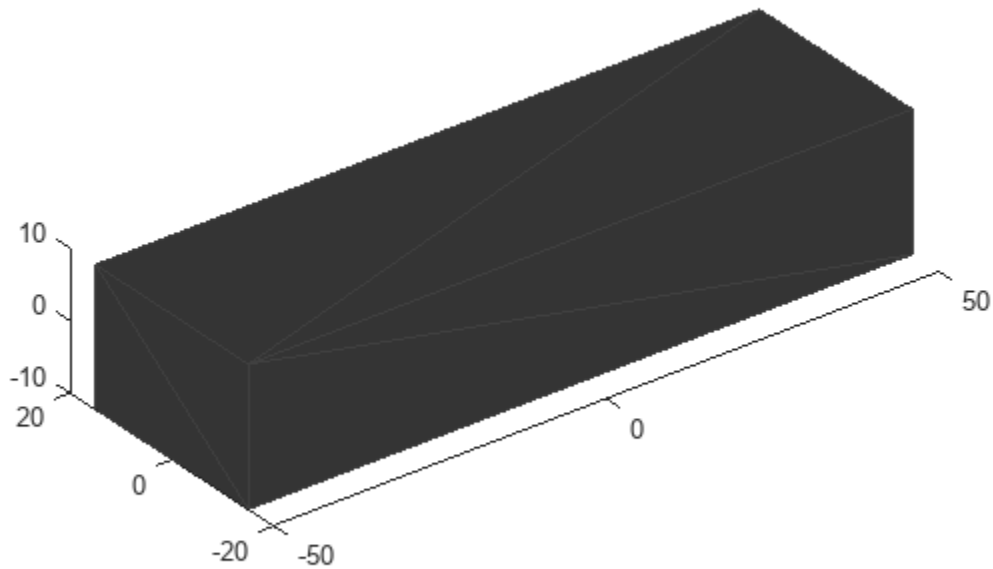

Input Arguments

mesh — Extended object mesh

`extendedObjectMesh` object

Extended object mesh, specified as an `extendedObjectMesh` object.

scaleFactor — Scaling factor

positive real scalar | 1-by-3 vector

Scaling factor for the object mesh, specified as a positive real scalar or as a 1-by-3 vector in the order x , y , and z .

Data Types: `single` | `double`

sx — Scaling factor for x-axis

positive real scalar

Scaling factor for x -axis, specified as a positive real scalar.

Data Types: `single` | `double`

sy — Scaling factor for y-axis

positive real scalar

Scaling factor for y -axis, specified as a positive real scalar.

Data Types: `single` | `double`

sz — Scaling factor for z-axis

positive real scalar

Scaling factor for z-axis, specified as a positive real scalar.

Data Types: `single` | `double`

Output Arguments

scaledMesh — Scaled object mesh

`extendedObjectMesh` object

Scaled object mesh, returned as an `extendedObjectMesh` object.

Version History

Introduced in R2020a

See Also

Objects

`extendedObjectMesh`

Functions

`rotate` | `translate` | `applyTransform` | `join` | `scaleToFit` | `show`

scaleToFit

Auto-scale object mesh to match specified cuboid dimensions

Syntax

```
scaledMesh = scaleToFit(mesh,dims)
```

Description

`scaledMesh = scaleToFit(mesh,dims)` auto-scales the object mesh to match the dimensions of a cuboid specified in the structure `dims`.

Examples

Create and Auto-Scale Sphere Mesh

Create an `extendedObjectMesh` object and auto-scale the object to the required dimensions.

Construct a sphere mesh of unit dimensions.

```
sph = extendedObjectMesh('sphere');
```

Auto-scale the mesh to the dimensions in `dims`.

```
dims = struct('Length',5,'Width',10,'Height',3,'OriginOffset',[0 0 -3]);  
sph = scaleToFit(sph,dims);
```

Visualize the mesh.

```
show(sph);
```

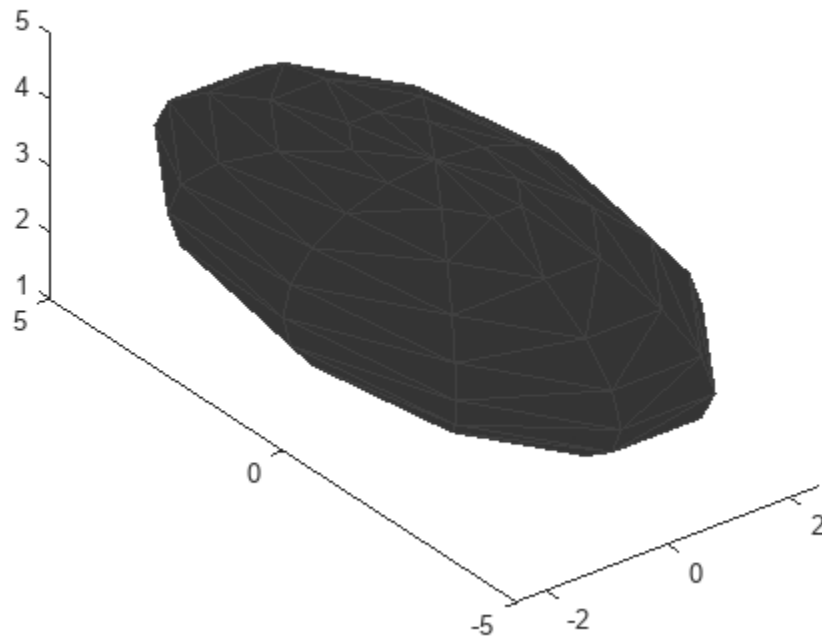
Input Arguments

mesh — Extended object mesh
`extendedObjectMesh` object

Extended object mesh, specified as an `extendedObjectMesh` object.

dims — Cuboid dimensions
`structure`

Dimensions of the cuboid to scale an object mesh, specified as a `struct` with these fields:

- `Length` - Length of the cuboid
- `Width` - Width of the cuboid
- `Height` - Height of the cuboid
- `OriginOffset` - Origin offset in 3-D coordinates

All the dimensions are in meters.

Data Types: `struct`

Output Arguments

scaledMesh — Scaled object mesh

extendedObjectMesh object

Scaled object mesh, returned as an extendedObjectMesh object.

Version History

Introduced in R2020a

See Also

Objects

extendedObjectMesh

Functions

rotate | translate | scale | applyTransform | join | show

show

Display the mesh as a patch on the current axes

Syntax

```
show(mesh)
show(mesh, ax)
ax = show(mesh)
```

Description

`show(mesh)` displays the `extendedObjectMesh` as a patch on the current axes. If there are no active axes, the function creates new axes.

`show(mesh, ax)` displays the object mesh as a patch on the axes `ax`.

`ax = show(mesh)` optionally outputs the handle to the axes where the mesh was plotted.

Examples

Create and Translate Cuboid Mesh

Create an `extendedObjectMesh` object and translate the object.

Construct a cuboid mesh.

```
mesh = extendedObjectMesh('cuboid');
```

Translate the mesh by 5 units along the negative y axis.

```
mesh = translate(mesh, [0 -5 0]);
```

Visualize the mesh.

```
ax = show(mesh);
ax.YLim = [-6 0];
```

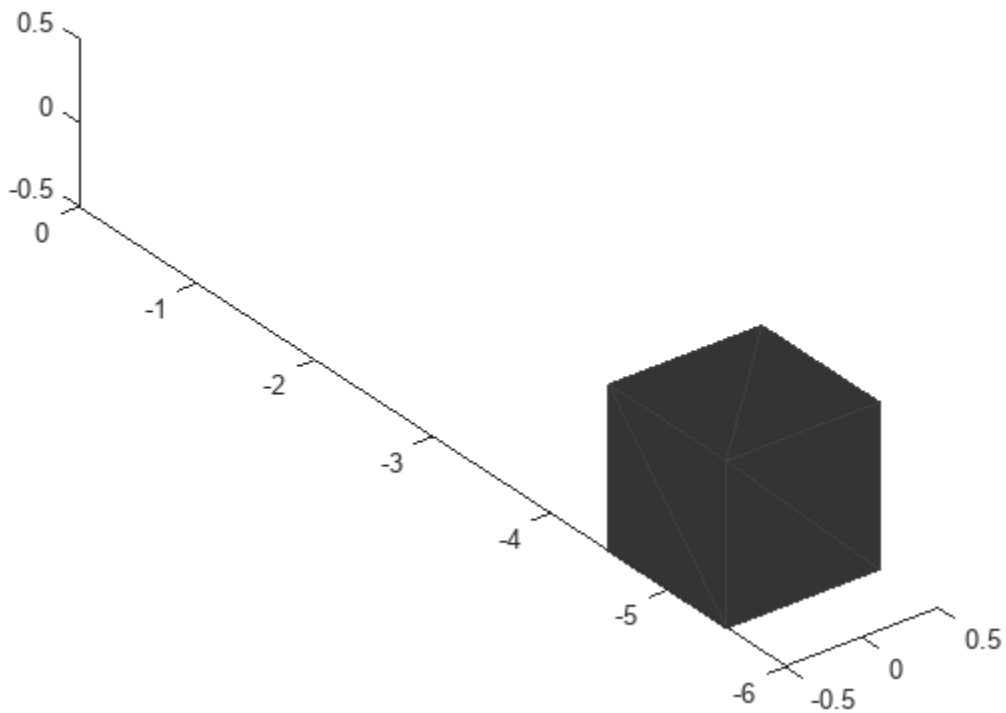

Input Arguments

mesh — Extended object mesh
`extendedObjectMesh` object

Extended object mesh, specified as an `extendedObjectMesh` object.

ax — Current axes
`axes` object

Current axes, specified as an `axes` object.

Version History

Introduced in R2020a

See Also

Objects
`extendedObjectMesh`

Functions
`rotate` | `translate` | `scale` | `applyTransform` | `join` | `scaleToFit`

translate

Translate mesh along coordinate axes

Syntax

```
translatedMesh = translate(mesh,deltaPos)
```

Description

`translatedMesh = translate(mesh,deltaPos)` translates the object mesh by the distances specified by `deltaPos` along the coordinate axes.

Examples

Create and Translate Cuboid Mesh

Create an `extendedObjectMesh` object and translate the object.

Construct a cuboid mesh.

```
mesh = extendedObjectMesh('cuboid');
```

Translate the mesh by 5 units along the negative y axis.

```
mesh = translate(mesh,[0 -5 0]);
```

Visualize the mesh.

```
ax = show(mesh);  
ax.YLim = [-6 0];
```

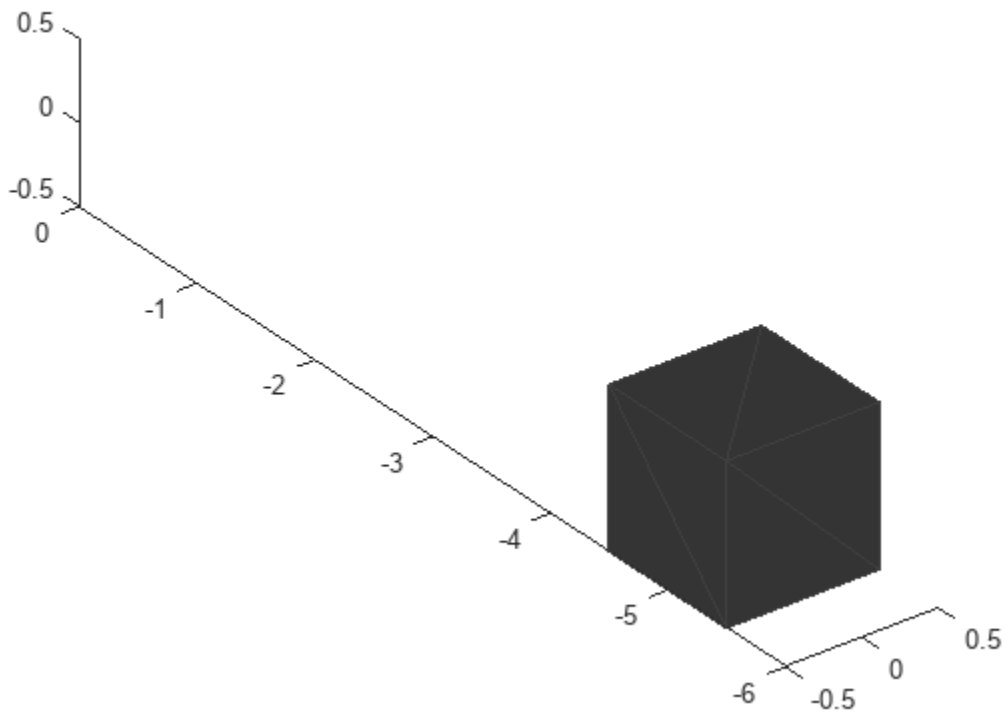

Input Arguments

mesh — Extended object mesh
extendedObjectMesh object

Extended object mesh, specified as an extendedObjectMesh object.

deltaPos — Translation vector
three-element real-valued vector

Translation vector for an object mesh, specified as a three-element real-valued vector. The three elements in the vector define the translation along the x, y, and z axes.

Data Types: single | double

Output Arguments

translatedMesh — Translated object mesh
extendedObjectMesh object

Translated object mesh, returned as an extendedObjectMesh object.

Version History

Introduced in R2020a

See Also

Objects

extendedObjectMesh

Functions

rotate | scale | applyTransform | join | scaleToFit | show

insSensor

Inertial navigation system and GNSS/GPS simulation model

Description

The `insSensor` System object models a device that fuses measurements from an inertial navigation system (INS) and global navigation satellite system (GNSS) such as a GPS, and outputs the fused measurements.

To output fused INS and GNSS measurements:

- 1 Create the `insSensor` object and set its properties.
- 2 Call the object with arguments, as if it were a function.

To learn more about how System objects work, see [What Are System Objects?](#)

Creation

Syntax

```
INS = insSensor  
INS = insSensor(Name,Value)
```

Description

`INS = insSensor` returns a System object, `INS`, that models a device that outputs measurements from an INS and GNSS.

`INS = insSensor(Name,Value)` sets properties on page 4-1758 using one or more name-value pairs. Unspecified properties have default values. Enclose each property name in quotes.

Properties

Unless otherwise indicated, properties are *nontunable*, which means you cannot change their values after calling the object. Objects lock when you call them, and the `release` function unlocks them.

If a property is *tunable*, you can change its value at any time.

For more information on changing property values, see [System Design in MATLAB Using System Objects](#).

MountingLocation — Location of sensor on platform (m)

[0 0 0] (default) | three-element real-valued vector of form [x y z]

Location of the sensor on the platform, in meters, specified as a three-element real-valued vector of the form [x y z]. The vector defines the offset of the sensor origin from the origin of the platform.

Tunable: Yes

Data Types: `single` | `double`

RollAccuracy — Accuracy of roll measurement (deg)

0.2 (default) | nonnegative real scalar

Accuracy of the roll measurement of the sensor body, in degrees, specified as a nonnegative real scalar.

Roll is the rotation around the x-axis of the sensor body. Roll noise is modeled as a white noise process. `RollAccuracy` sets the standard deviation of the roll measurement noise.

Tunable: Yes

Data Types: `single` | `double`

PitchAccuracy — Accuracy of pitch measurement (deg)

0.2 (default) | nonnegative real scalar

Accuracy of the pitch measurement of the sensor body, in degrees, specified as a nonnegative real scalar.

Pitch is the rotation around the y-axis of the sensor body. Pitch noise is modeled as a white noise process. `PitchAccuracy` defines the standard deviation of the pitch measurement noise.

Tunable: Yes

Data Types: `single` | `double`

YawAccuracy — Accuracy of yaw measurement (deg)

1 (default) | nonnegative real scalar

Accuracy of the yaw measurement of the sensor body, in degrees, specified as a nonnegative real scalar.

Yaw is the rotation around the z-axis of the sensor body. Yaw noise is modeled as a white noise process. `YawAccuracy` defines the standard deviation of the yaw measurement noise.

Tunable: Yes

Data Types: `single` | `double`

PositionAccuracy — Accuracy of position measurement (m)

[1 1 1] (default) | nonnegative real scalar | three-element real-valued vector

Accuracy of the position measurement of the sensor body, in meters, specified as a nonnegative real scalar or a three-element real-valued vector. The elements of the vector set the accuracy of the x-, y-, and z-position measurements, respectively. If you specify `PositionAccuracy` as a scalar value, then the object sets the accuracy of all three positions to this value.

Position noise is modeled as a white noise process. `PositionAccuracy` defines the standard deviation of the position measurement noise.

Tunable: Yes

Data Types: `single` | `double`

VelocityAccuracy — Accuracy of velocity measurement (m/s)

0.05 (default) | nonnegative real scalar

Accuracy of the velocity measurement of the sensor body, in meters per second, specified as a nonnegative real scalar.

Velocity noise is modeled as a white noise process. `VelocityAccuracy` defines the standard deviation of the velocity measurement noise.

Tunable: Yes

Data Types: `single` | `double`

AccelerationAccuracy — Accuracy of acceleration measurement (m/s²)

0 (default) | nonnegative real scalar

Accuracy of the acceleration measurement of the sensor body, in meters per second, specified as a nonnegative real scalar.

Acceleration noise is modeled as a white noise process. `AccelerationAccuracy` defines the standard deviation of the acceleration measurement noise.

Tunable: Yes

Data Types: `single` | `double`

AngularVelocityAccuracy — Accuracy of angular velocity measurement (deg/s)

0 (default) | nonnegative real scalar

Accuracy of the angular velocity measurement of the sensor body, in meters per second, specified as a nonnegative real scalar.

Angular velocity is modeled as a white noise process. `AngularVelocityAccuracy` defines the standard deviation of the acceleration measurement noise.

Tunable: Yes

Data Types: `single` | `double`

TimeInput — Enable input of simulation time

`false` or 0 (default) | `true` or 1

Enable input of simulation time, specified as a logical 0 (`false`) or 1 (`true`). Set this property to `true` to input the simulation time by using the `simTime` argument.

Tunable: No

Data Types: `logical`

HasGNSSFix — Enable GNSS fix

`true` or 1 (default) | `false` or 0

Enable GNSS fix, specified as a logical 1 (`true`) or 0 (`false`). Set this property to `false` to simulate the loss of a GNSS receiver fix. When a GNSS receiver fix is lost, position measurements drift at a rate specified by the `PositionErrorFactor` property.

Tunable: Yes

Dependencies

To enable this property, set `TimeInput` to `true`.

Data Types: `logical`

PositionErrorFactor — Position error factor without GNSS fix

`[0 0 0]` (default) | nonnegative scalar | 1-by-3 vector of scalars

Position error factor without GNSS fix, specified as a scalar or a 1-by-3 vector of scalars.

When the `HasGNSSFix` property is set to `false`, the position error grows at a quadratic rate due to constant bias in the accelerometer. The position error for a position component $E(t)$ can be expressed as $E(t) = 1/2\alpha t^2$, where α is the position error factor for the corresponding component and t is the time since the GNSS fix is lost. While running, the object computes t based on the `simTime` input. The computed $E(t)$ values for the x , y , and z components are added to the corresponding position components of the `gTruth` input.

Tunable: Yes

Dependencies

To enable this property, set `TimeInput` to `true` and `HasGNSSFix` to `false`.

Data Types: `single` | `double`

RandomStream — Random number source

`'Global stream'` (default) | `'mt19937ar with seed'`

Random number source, specified as one of these options:

- `'Global stream'` -- Generate random numbers using the current global random number stream.
- `'mt19937ar with seed'` -- Generate random numbers using the mt19937ar algorithm, with the seed specified by the `Seed` property.

Data Types: `char` | `string`

Seed — Initial seed

67 (default) | nonnegative integer

Initial seed of the mt19937ar random number generator algorithm, specified as a nonnegative integer.

Dependencies

To enable this property, set `RandomStream` to `'mt19937ar with seed'`.

Data Types: `single` | `double` | `int8` | `int16` | `int32` | `int64` | `uint8` | `uint16` | `uint32` | `uint64`

Usage

Syntax

```
measurement = INS(gTruth)
measurement = INS(gTruth, simTime)
```

Description

`measurement = INS(gTruth)` models the data received from an INS sensor reading and GNSS sensor reading. The output measurement is based on the inertial ground-truth state of the sensor body, `gTruth`.

`measurement = INS(gTruth, simTime)` additionally specifies the time of simulation, `simTime`. To enable this syntax, set the `TimeInput` property to `true`.

Input Arguments

`gTruth` — Inertial ground-truth state of sensor body

structure

Inertial ground-truth state of sensor body, in local Cartesian coordinates, specified as a structure containing these fields:

Field	Description
'Position'	Position, in meters, specified as a real, finite N -by-3 matrix of $[x\ y\ z]$ vectors. N is the number of samples in the current frame.
'Velocity'	Velocity (v), in meters per second, specified as a real, finite N -by-3 matrix of $[v_x\ v_y\ v_z]$ vector. N is the number of samples in the current frame.
'Orientation'	Orientation with respect to the local Cartesian coordinate system, specified as one of these options: <ul style="list-style-type: none"> N-element column vector of quaternion objects 3-by-3-by-N array of rotation matrices N-by-3 matrix of $[x_{roll}\ y_{pitch}\ z_{yaw}]$ angles in degrees Each quaternion or rotation matrix is a frame rotation from the local Cartesian coordinate system to the current sensor body coordinate system. N is the number of samples in the current frame.
'Acceleration'	Acceleration (a), in meters per second squared, specified as a real, finite N -by-3 matrix of $[a_x\ a_y\ a_z]$ vectors. N is the number of samples in the current frame.
'AngularVelocity'	Angular velocity (ω), in degrees per second squared, specified as a real, finite N -by-3 matrix of $[\omega_x\ \omega_y\ \omega_z]$ vectors. N is the number of samples in the current frame.

The field values must be of type `double` or `single`.

The `Position`, `Velocity`, and `Orientation` fields are required. The other fields are optional.

```
Example: struct('Position',[0 0 0],'Velocity',[0 0
0],'Orientation',quaternion([1 0 0 0]))
```

simTime — Simulation time

nonnegative real scalar

Simulation time, in seconds, specified as a nonnegative real scalar.

Data Types: single | double

Output Arguments

measurement — Measurement of sensor body motion

structure

Measurement of the sensor body motion, in local Cartesian coordinates, returned as a structure containing these fields:

Field	Description
'Position'	Position, in meters, specified as a real, finite N -by-3 matrix of $[x\ y\ z]$ vectors. N is the number of samples in the current frame.
'Velocity'	Velocity (v), in meters per second, specified as a real, finite N -by-3 matrix of $[v_x\ v_y\ v_z]$ vector. N is the number of samples in the current frame.
'Orientation'	Orientation with respect to the local Cartesian coordinate system, specified as one of these options: <ul style="list-style-type: none"> N-element column vector of quaternion objects 3-by-3-by-N array of rotation matrices N-by-3 matrix of $[x_{\text{roll}}\ y_{\text{pitch}}\ z_{\text{yaw}}]$ angles in degrees Each quaternion or rotation matrix is a frame rotation from the local Cartesian coordinate system to the current sensor body coordinate system. N is the number of samples in the current frame.
'Acceleration'	Acceleration (a), in meters per second squared, specified as a real, finite N -by-3 matrix of $[a_x\ a_y\ a_z]$ vectors. N is the number of samples in the current frame.
'AngularVelocity'	Angular velocity (ω), in degrees per second squared, specified as a real, finite N -by-3 matrix of $[\omega_x\ \omega_y\ \omega_z]$ vectors. N is the number of samples in the current frame.

The returned field values are of type `double` or `single` and are of the same type as the corresponding field values in the `gTruth` input.

Object Functions

To use an object function, specify the System object as the first input argument. For example, to release system resources of a System object named `obj`, use this syntax:

```
release(obj)
```

Specific to `insSensor`

`perturbations` Perturbation defined on object
`perturb` Apply perturbations to object

Common to All System Objects

`step` Run System object algorithm
`clone` Create duplicate System object
`isLocked` Determine if System object is in use
`reset` Reset internal states of System object
`release` Release resources and allow changes to System object property values and input characteristics

Examples

Generate INS Measurements from Stationary Input

Create a motion structure that defines a stationary position at the local north-east-down (NED) origin. Because the platform is stationary, you need to define only a single sample. Assume the ground-truth motion is sampled for 10 seconds with a 100 Hz sample rate. Create a default `insSensor` System object™. Preallocate variables to hold output from the `insSensor` object.

```
Fs = 100;  
duration = 10;  
numSamples = Fs*duration;  
  
motion = struct( ...  
    'Position', zeros(1,3), ...  
    'Velocity', zeros(1,3), ...  
    'Orientation', ones(1,1, 'quaternion'));  
  
INS = insSensor;  
  
positionMeasurements = zeros(numSamples,3);  
velocityMeasurements = zeros(numSamples,3);  
orientationMeasurements = zeros(numSamples,1, 'quaternion');
```

In a loop, call `INS` with the stationary motion structure to return the position, velocity, and orientation measurements in the local NED coordinate system. Log the position, velocity, and orientation measurements.

```
for i = 1:numSamples  
    measurements = INS(motion);  
  
    positionMeasurements(i,:) = measurements.Position;  
    velocityMeasurements(i,:) = measurements.Velocity;
```

```
orientationMeasurements(i) = measurements.Orientation;
```

```
end
```

Convert the orientation from quaternions to Euler angles for visualization purposes. Plot the position, velocity, and orientation measurements over time.

```
orientationMeasurements = eulerd(orientationMeasurements, 'ZYX', 'frame');
```

```
t = (0:(numSamples-1))/Fs;
```

```
subplot(3,1,1)
plot(t,positionMeasurements)
title('Position')
xlabel('Time (s)')
ylabel('Position (m)')
legend('North', 'East', 'Down')
```

```
subplot(3,1,2)
plot(t,velocityMeasurements)
title('Velocity')
xlabel('Time (s)')
ylabel('Velocity (m/s)')
legend('North', 'East', 'Down')
```

```
subplot(3,1,3)
plot(t,orientationMeasurements)
title('Orientation')
xlabel('Time (s)')
ylabel('Rotation (degrees)')
legend('Roll', 'Pitch', 'Yaw')
```

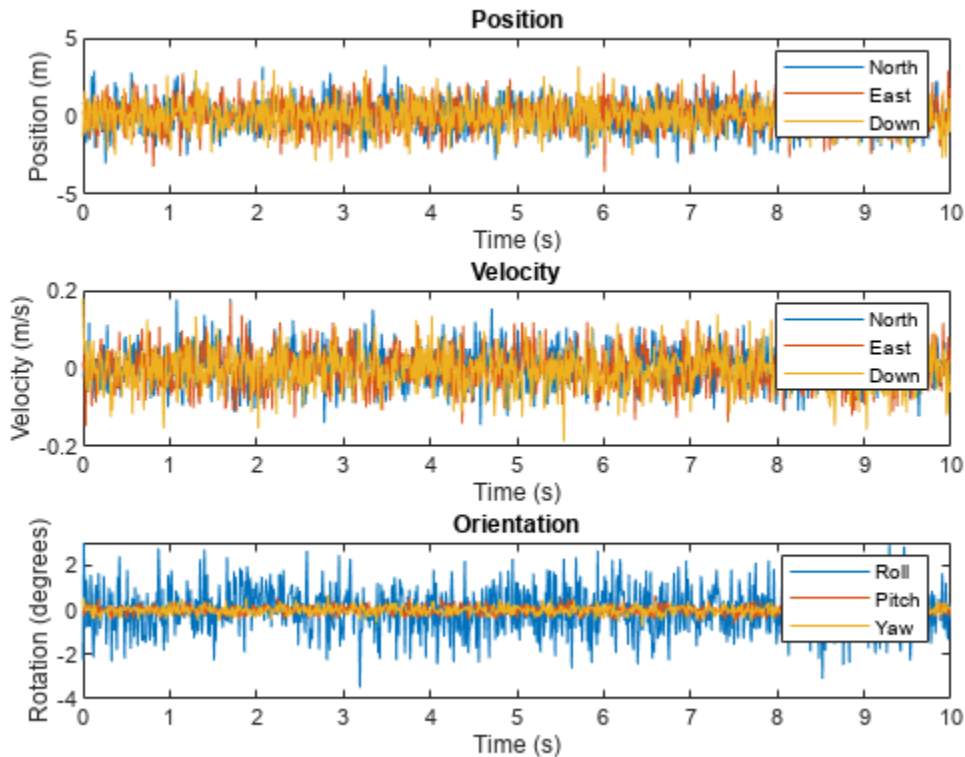

Generate INS Measurements from Driving Scenario

Generate measurements from an INS sensor that is mounted to a vehicle in a driving scenario. Plot the INS measurements against the ground truth state of the vehicle and visualize the velocity and acceleration profile of the vehicle.

Create Driving Scenario

Load the geographic data for a driving route at the MathWorks® Apple Hill campus in Natick, MA.

```
data = load('ahroute.mat');
latIn = data.latitude;
lonIn = data.longitude;
```

Convert the latitude and longitude coordinates of the route to Cartesian coordinates. Set the origin to the first coordinate in the driving route. For simplicity, assume an altitude of 0 for the route.

```
alt = 0;
origin = [latIn(1), lonIn(1), alt];
[xEast, yNorth, zUp] = latlon2local(latIn, lonIn, alt, origin);
```

Create a driving scenario. Set the origin of the converted route as the geographic reference point.

```
scenario = drivingScenario('GeoReference', origin);
```

Create a road based on the Cartesian coordinates of the route.

```
roadCenters = [xEast,yNorth,zUp];  
road(scenario,roadCenters);
```

Create a vehicle that follows the center line of the road. The vehicle travels between 4 and 5 meters per second (9 to 11 miles per hour), slowing down at the curves in the road. To create the trajectory, use the `smoothTrajectory` function. The computed trajectory minimizes jerk and avoids discontinuities in acceleration, which is a requirement for modeling INS sensors.

```
egoVehicle = vehicle(scenario,'ClassID',1);  
egoPath = roadCenters;  
egoSpeed = [5 5 5 4 4 4 5 4 4 4 4 5 5 5 5];  
smoothTrajectory(egoVehicle,egoPath,egoSpeed);
```

Plot the scenario and show a 3-D view from behind the ego vehicle.

```
plot(scenario)  
chasePlot(egoVehicle)
```

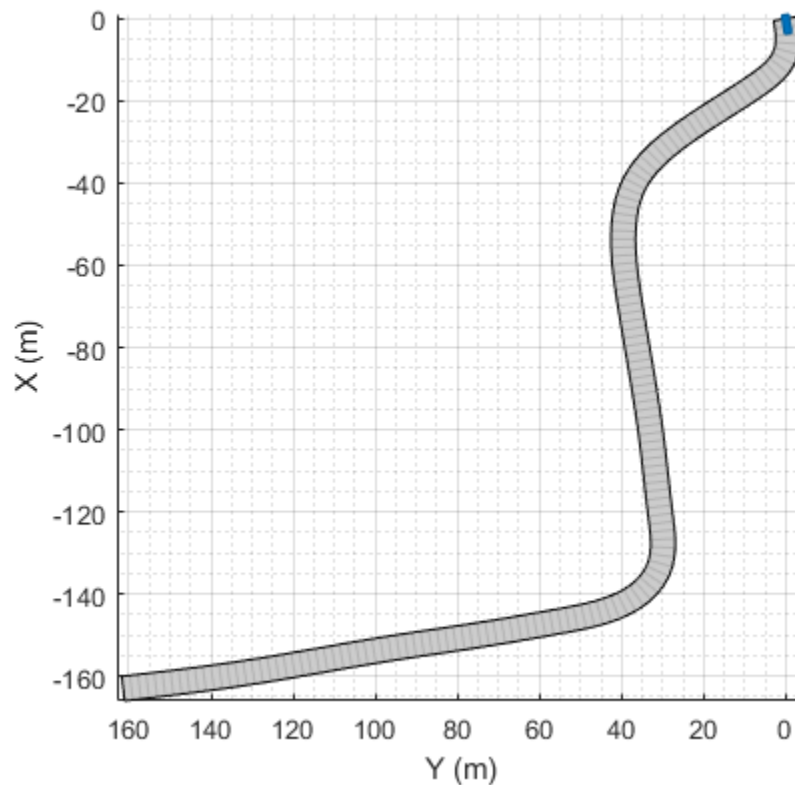

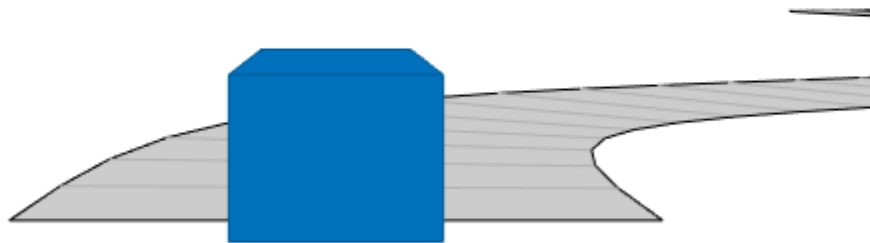

Create INS Sensor

Create an INS sensor that accepts the input of simulation times. Introduce noise into the sensor measurements by setting the standard deviation of velocity and accuracy measurements to 0.1 and 0.05, respectively.

```
INS = insSensor('TimeInput',true, ...  
               'VelocityAccuracy',0.1, ...  
               'AccelerationAccuracy',0.05);
```

Visualize INS Measurements

Initialize a geographic player for displaying the INS measurements and the actor ground truth. Configure the player to display its last 10 positions and set the zoom level to 17.

```
zoomLevel = 17;  
player = geoplayer(latIn(1),lonIn(1),zoomLevel, ...  
                  'HistoryDepth',10,'HistoryStyle','line');
```

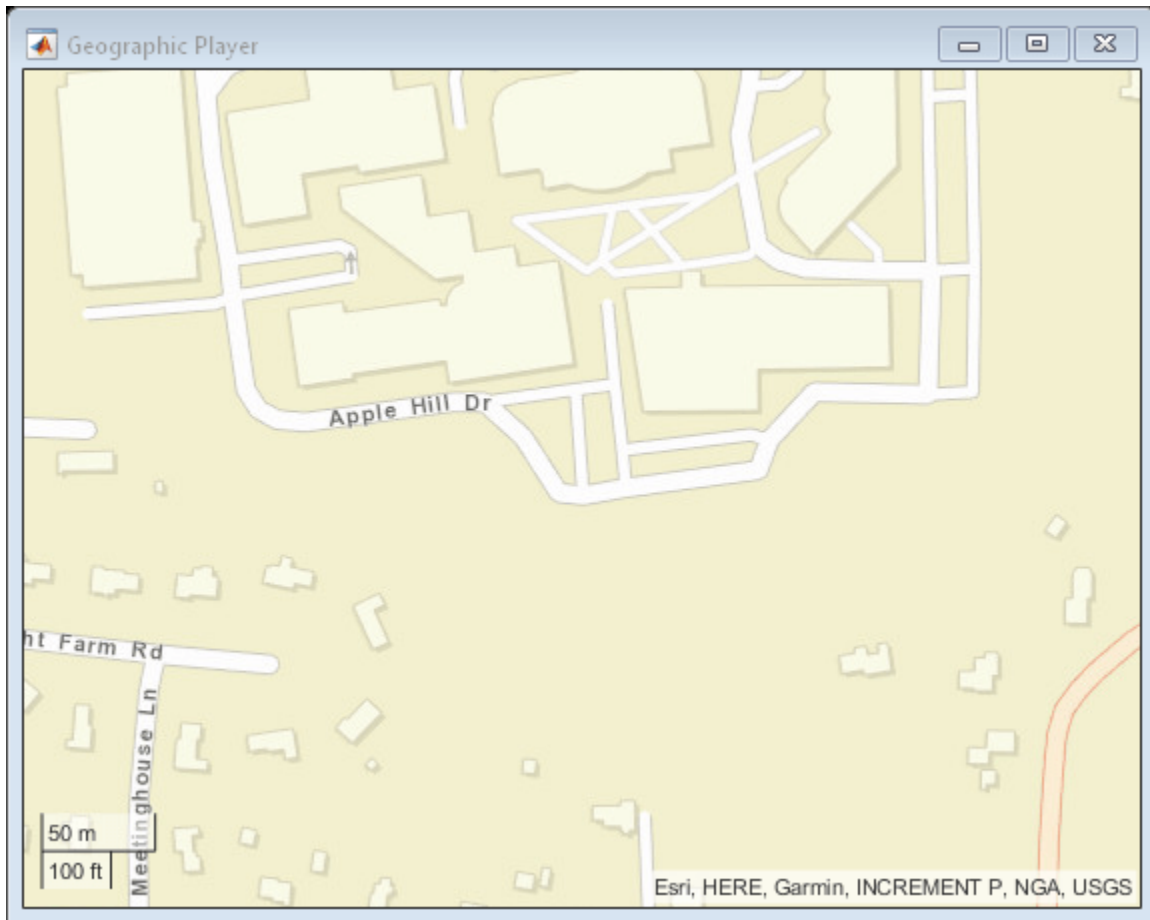

Pre-allocate space for the simulation times, velocity measurements, and acceleration measurements that are captured during simulation.

```
numWaypoints = length(latIn);
times = zeros(numWaypoints,1);
gTruthVelocities = zeros(numWaypoints,1);
gTruthAccelerations = zeros(numWaypoints,1);
sensorVelocities = zeros(numWaypoints,1);
sensorAccelerations = zeros(numWaypoints,1);
```

Simulate the scenario. During the simulation loop, obtain the ground truth state of the ego vehicle and an INS measurement of that state. Convert these readings to geographic coordinates, and at each waypoint, visualize the ground truth and INS readings on the geographic player. Also capture the velocity and acceleration data for plotting the velocity and acceleration profiles.

```
nextWaypoint = 2;
while advance(scenario)

    % Obtain ground truth state of ego vehicle.
    gTruth = state(egoVehicle);

    % Obtain INS sensor measurement.
    measurement = INS(gTruth,scenario.SimulationTime);

    % Convert readings to geographic coordinates.
```

```

[latOut,lonOut] = local2latlon(measurement.Position(1), ...
                              measurement.Position(2), ...
                              measurement.Position(3),origin);

% Plot differences between ground truth locations and locations reported by sensor.
reachedWaypoint = sum(abs(roadCenters(nextWaypoint,:) - gTruth.Position)) < 1;
if reachedWaypoint
    plotPosition(player,latIn(nextWaypoint),lonIn(nextWaypoint),'TrackID',1)
    plotPosition(player,latOut,lonOut,'TrackID',2,'Label','INS')

    % Capture simulation times, velocities, and accelerations.
    times(nextWaypoint,1) = scenario.SimulationTime;
    gTruthVelocities(nextWaypoint,1) = gTruth.Velocity(2);
    gTruthAccelerations(nextWaypoint,1) = gTruth.Acceleration(2);
    sensorVelocities(nextWaypoint,1) = measurement.Velocity(2);
    sensorAccelerations(nextWaypoint,1) = measurement.Acceleration(2);

    nextWaypoint = nextWaypoint + 1;
end

if nextWaypoint > numWaypoints
    break
end
end
end

```

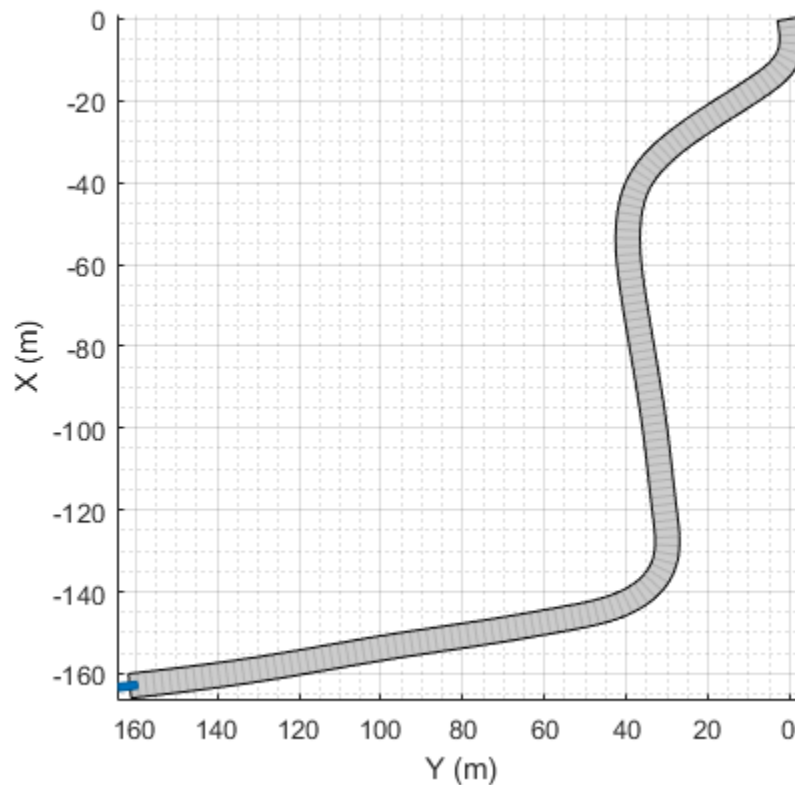

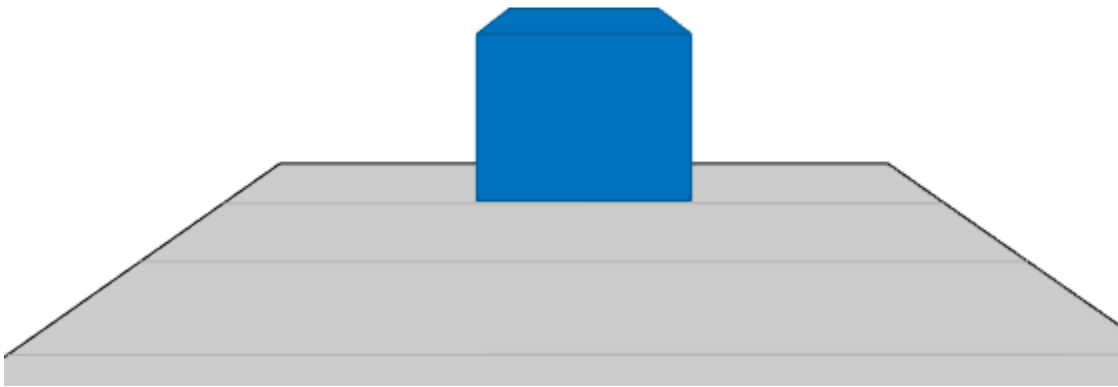

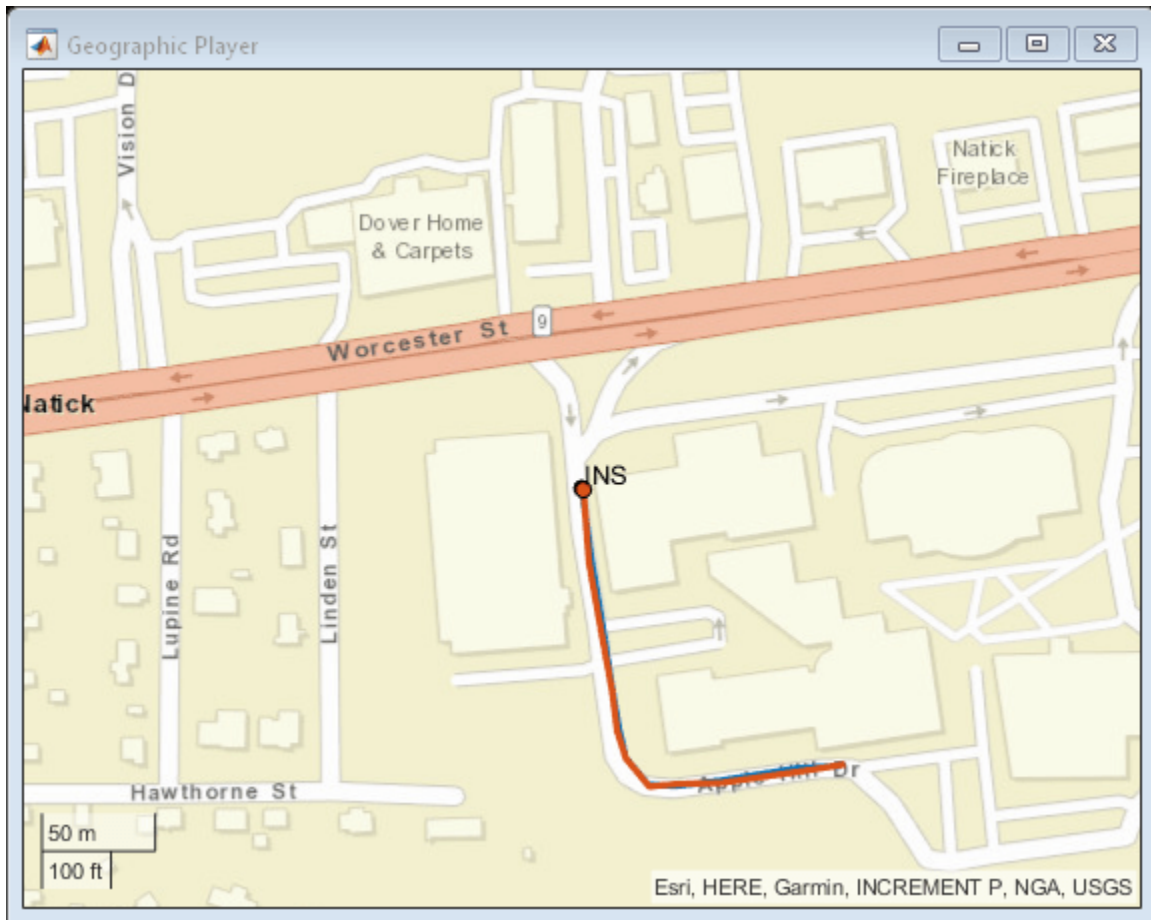

Plot Velocity Profile

Compare the ground truth longitudinal velocity of the vehicle over time against the velocity measurements captured by the INS sensor.

Remove zeros from the time vector and velocity vectors.

```
times(times == 0) = [];
gTruthVelocities(gTruthVelocities == 0) = [];
sensorVelocities(sensorVelocities == 0) = [];
```

```
figure
hold on
plot(times,gTruthVelocities)
plot(times,sensorVelocities)
title('Longitudinal Velocity Profile')
xlabel('Time (s)')
ylabel('Velocity (m/s)')
legend('Ground truth','INS')
hold off
```

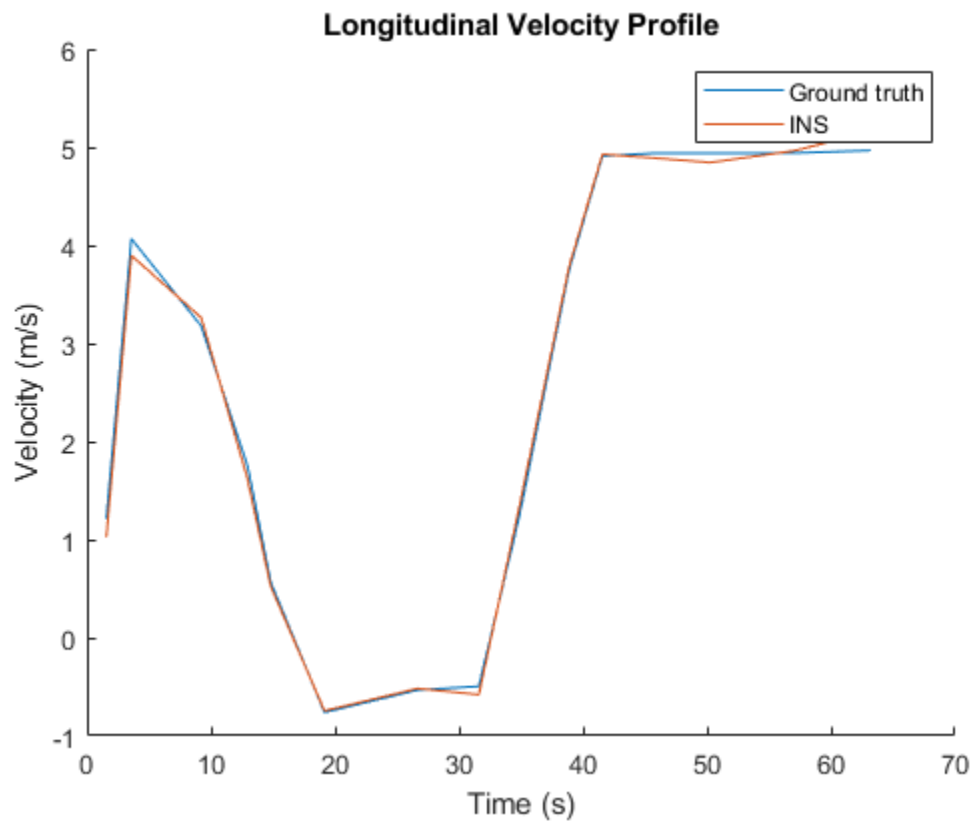

Plot Acceleration Profile

Compare the ground truth longitudinal acceleration of the vehicle over time against the acceleration measurements captured by the INS sensor.

```
gTruthAccelerations(gTruthAccelerations == 0) = [];
sensorAccelerations(sensorAccelerations == 0) = [];
```

```
figure
hold on
plot(times,gTruthAccelerations)
plot(times,sensorAccelerations)
title('Longitudinal Acceleration Profile')
xlabel('Time (s)')
ylabel('Acceleration (m/s^2)')
legend('Ground truth','INS')
hold off
```

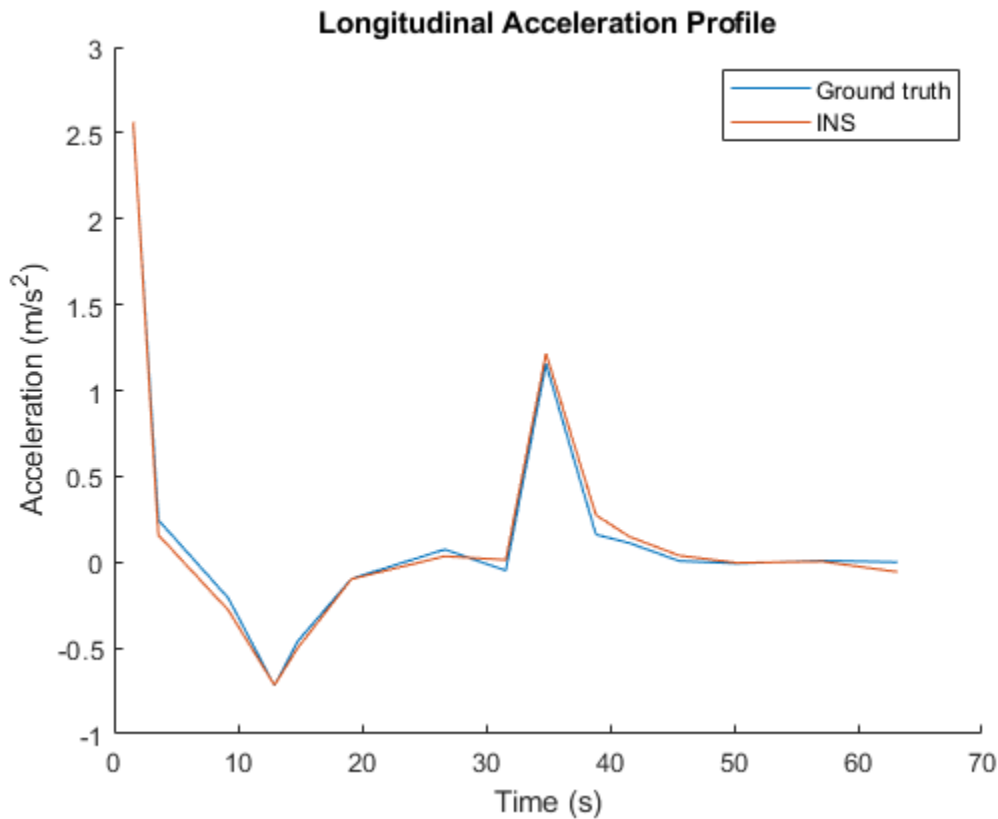

Tips

- To obtain the ground-truth state of actors in a driving scenario, use the `state` function.
- The sensor reports measurements in the local Cartesian coordinate system. To convert these measurements to geographic positions for visualization on a map, use the `local2latlon` function. To convert this data back to local coordinates, use the `latlon2local` function.

Version History

Introduced in R2021a

Extended Capabilities

C/C++ Code Generation

Generate C and C++ code using MATLAB® Coder™.

The object functions, `perturbations` and `perturb`, do not support code generation.

Usage notes and limitations:

See “System Objects in MATLAB Code Generation” (MATLAB Coder).

See Also

Objects

[drivingScenario](#) | [drivingRadarDataGenerator](#) | [visionDetectionGenerator](#) | [lidarPointCloudGenerator](#)

Objects

perturb

Apply perturbations to object

Syntax

```
offsets = perturb(obj)
```

Description

`offsets = perturb(obj)` applies the perturbations defined on the object, `obj` and returns the offset values. You can define perturbations on the object by using the `perturbations` function.

Examples

Perturb Accuracy of `insSensor`

Create an `insSensor` object.

```
sensor = insSensor
```

```
sensor =
```

```
  insSensor with properties:
```

```
      MountingLocation: [0 0 0]           m
      RollAccuracy: 0.2                   deg
      PitchAccuracy: 0.2                   deg
      YawAccuracy: 1                       deg
      PositionAccuracy: [1 1 1]           m
      VelocityAccuracy: 0.05               m/s
      AccelerationAccuracy: 0               m/s2
      AngularVelocityAccuracy: 0           deg/s
      TimeInput: 0
      RandomStream: 'Global stream'
```

Define the perturbation on the `RollAccuracy` property as three values with an equal possibility each.

```
values = {0.1 0.2 0.3}
```

```
values=1×3 cell array
  {[0.1000]}  {[0.2000]}  {[0.3000]}
```

```
probabilities = [1/3 1/3 1/3]
```

```
probabilities = 1×3
  0.3333  0.3333  0.3333
```

```
perturbations(sensor, 'RollAccuracy', 'Selection', values, probabilities)
```

```
ans=7x3 table
```

Property	Type	Value	
"RollAccuracy"	"Selection"	{1x3 cell}	{[0.3333 0.3333 0.3333]}
"PitchAccuracy"	"None"	{[NaN]}	{[NaN]}
"YawAccuracy"	"None"	{[NaN]}	{[NaN]}
"PositionAccuracy"	"None"	{[NaN]}	{[NaN]}
"VelocityAccuracy"	"None"	{[NaN]}	{[NaN]}
"AccelerationAccuracy"	"None"	{[NaN]}	{[NaN]}
"AngularVelocityAccuracy"	"None"	{[NaN]}	{[NaN]}

Perturb the sensor object using the perturb function.

```
rng(2020)
perturb(sensor);
sensor
```

```
sensor =
  insSensor with properties:
    MountingLocation: [0 0 0]          m
    RollAccuracy: 0.5                 deg
    PitchAccuracy: 0.2                deg
    YawAccuracy: 1                    deg
    PositionAccuracy: [1 1 1]         m
    VelocityAccuracy: 0.05            m/s
    AccelerationAccuracy: 0           m/s2
    AngularVelocityAccuracy: 0        deg/s
    TimeInput: 0
    RandomStream: 'Global stream'
```

The RollAccuracy is perturbed to 0.5 deg.

Input Arguments

obj — Object for perturbation

objects

Object for perturbation, specified as an object. The objects that you can perturb include:

- insSensor

Output Arguments

offsets — Property offsets

array of structure

Property offsets, returned as an array of structures. Each structure contains these fields:

Field Name	Description
Property	Name of perturbed property
Offset	Offset values applied in the perturbation
PerturbedValue	Property values after the perturbation

Version History

Introduced in R2021a

See Also

perturbations

perturbations

Perturbation defined on object

Syntax

```

perturbs = perturbations(obj)
perturbs = perturbations(obj,property)
perturbs = perturbations(obj,property,'None')
perturbs = perturbations(obj,property,'Selection',values,probabilities)
perturbs = perturbations(obj,property,'Normal',mean,deviation)
perturbs = perturbations(obj,property,'TruncatedNormal',mean,deviation,
lowerLimit,upperLimit)
perturbs = perturbations(obj,property,'Uniform',minVal,maxVal)
perturbs = perturbations(obj,property,'Custom',perturbFcn)

```

Description

`perturbs = perturbations(obj)` returns the list of property perturbations, `perturbs`, defined on the object, `obj`. The returned `perturbs` lists all the perturbable properties. If any property is not perturbed, then its corresponding `Type` is returned as "Null" and its corresponding `Value` is returned as `{Null,Null}`.

`perturbs = perturbations(obj,property)` returns the current perturbation applied to the specified property.

`perturbs = perturbations(obj,property,'None')` defines a property that must not be perturbed.

`perturbs = perturbations(obj,property,'Selection',values,probabilities)` defines the property perturbation offset drawn from a set of values that have corresponding probabilities.

`perturbs = perturbations(obj,property,'Normal',mean,deviation)` defines the property perturbation offset drawn from a normal distribution with specified mean and standard deviation.

`perturbs = perturbations(obj,property,'TruncatedNormal',mean,deviation,lowerLimit,upperLimit)` defines the property perturbation offset drawn from a normal distribution with specified mean, standard deviation, lower limit, and upper limit.

`perturbs = perturbations(obj,property,'Uniform',minVal,maxVal)` defines the property perturbation offset drawn from a uniform distribution on an interval `[minVal, maxVal]`.

`perturbs = perturbations(obj,property,'Custom',perturbFcn)` enables you to define a custom function, `perturbFcn`, that draws the perturbation offset value.

Examples

Perturb Accuracy of insSensor

Create an insSensor object.

```
sensor = insSensor
sensor =
  insSensor with properties:
      MountingLocation: [0 0 0]           m
      RollAccuracy: 0.2                 deg
      PitchAccuracy: 0.2                 deg
      YawAccuracy: 1                     deg
      PositionAccuracy: [1 1 1]         m
      VelocityAccuracy: 0.05            m/s
      AccelerationAccuracy: 0            m/s2
      AngularVelocityAccuracy: 0         deg/s
      TimeInput: 0
      RandomStream: 'Global stream'
```

Define the perturbation on the RollAccuracy property as three values with an equal possibility each.

```
values = {0.1 0.2 0.3}
values=1×3 cell array
    {[0.1000]}    {[0.2000]}    {[0.3000]}

probabilities = [1/3 1/3 1/3]
probabilities = 1×3
    0.3333    0.3333    0.3333
```

```
perturbations(sensor, 'RollAccuracy', 'Selection', values, probabilities)
```

```
ans=7×3 table
      Property      Type      Value
      _____      _____      _____
      "RollAccuracy"  "Selection"  {1×3 cell}  {[0.3333 0.3333 0.3333]}
      "PitchAccuracy"  "None"      {[ NaN]}   {[ NaN]}
      "YawAccuracy"    "None"      {[ NaN]}   {[ NaN]}
      "PositionAccuracy"  "None"      {[ NaN]}   {[ NaN]}
      "VelocityAccuracy"  "None"      {[ NaN]}   {[ NaN]}
      "AccelerationAccuracy"  "None"      {[ NaN]}   {[ NaN]}
      "AngularVelocityAccuracy"  "None"      {[ NaN]}   {[ NaN]}
```

Perturb the sensor object using the perturb function.

```
rng(2020)
perturb(sensor);
sensor
```

```

sensor =
  insSensor with properties:

      MountingLocation: [0 0 0]           m
      RollAccuracy: 0.5                   deg
      PitchAccuracy: 0.2                   deg
      YawAccuracy: 1                       deg
      PositionAccuracy: [1 1 1]           m
      VelocityAccuracy: 0.05              m/s
      AccelerationAccuracy: 0              m/s2
      AngularVelocityAccuracy: 0           deg/s
      TimeInput: 0
      RandomStream: 'Global stream'

```

The RollAccuracy is perturbed to 0.5 deg.

Input Arguments

obj — Object to be perturbed

objects

Object to be perturbed, specified as an object. The objects that you can perturb include:

- `insSensor`

property — Perturbable property

property name

Perturbable property, specified as a property name. Use `perturbations` to obtain a full list of perturbable properties for the specified `obj`.

values — Perturbation offset values

n-element cell array of property values

Perturbation offset values, specified as an *n*-element cell array of property values. The function randomly draws the perturbation value for the property from the cell array based on the values' corresponding probabilities specified in the `probabilities` input.

probabilities — Drawing probabilities for each perturbation value

n-element array of nonnegative scalar

Drawing probabilities for each perturbation value, specified as an *n*-element array of nonnegative scalars, where *n* is the number of perturbation values provided in the `values` input. The sum of all elements must be equal to one.

For example, you can specify a series of perturbation value-probability pair as $\{x_1, x_2, \dots, x_n\}$ and $\{p_1, p_2, \dots, p_n\}$, where the probability of drawing x_i is p_i ($i = 1, 2, \dots, n$).

mean — Mean of normal or truncated normal distribution

scalar | vector | matrix

Mean of normal or truncated normal distribution, specified as a scalar, vector, or matrix. The dimension of `mean` must be compatible with the corresponding property that you perturb.

deviation — Standard deviation of normal or truncated normal distribution

nonnegative scalar | vector of nonnegative scalar | matrix of nonnegative scalar

Standard deviation of normal or truncated normal distribution, specified as a nonnegative scalar, vector of nonnegative scalars, or matrix of nonnegative scalars. The dimension of `deviation` must be compatible with the corresponding property that you perturb.

lowerLimit — Lower limit of truncated normal distribution

scalar | vector | matrix

Lower limit of the truncated normal distribution, specified as a scalar, vector, or matrix. The dimension of `lowerLimit` must be compatible with the corresponding property that you perturb.

upperLimit — Upper limit of truncated normal distribution

scalar | vector | matrix

Upper limit of the truncated normal distribution, specified as a scalar, vector, or matrix. The dimension of `upperLimit` must be compatible with the corresponding property that you perturb.

minVal — Minimum value of uniform distribution interval

scalar | vector | matrix

Minimum value of the uniform distribution interval, specified as a scalar, vector, or matrix. The dimension of `minVal` must be compatible with the corresponding property that you perturb.

maxVal — Maximum value of uniform distribution interval

scalar | vector | matrix

Maximum value of the uniform distribution interval, specified as a scalar, vector, or matrix. The dimension of `maxVal` must be compatible with the corresponding property that you perturb.

perturbFcn — Perturbation function

function handle

Perturbation function, specified as a function handle. The function must have this syntax:

```
offset = myfun(propVal)
```

where `propVal` is the value of the property and `offset` is the perturbation offset for the property.

Output Arguments**perturbs — Perturbations defined on object**

table of perturbation property

Perturbations defined on the object, returned as a table of perturbation properties. The table has three columns:

- **Property** — Property names.
- **Type** — Type of perturbations, returned as "None", "Selection", "Normal", "TruncatedNormal", "Uniform", or "Custom".
- **Value** — Perturbation values, returned as a cell array.

More About

Specify Perturbation Distributions

You can specify the distribution for the perturbation applied to a specific property.

- Selection distribution — The function defines the perturbation offset as one of the specified values with the associated probability. For example, if you specify the values as [1 2] and specify the probabilities as [0.7 0.3], then the `perturb` function adds an offset value of 1 to the property with a probability of 0.7 and add an offset value of 2 to the property with a probability of 0.3. Use selection distribution when you only want to perturb the property with a number of discrete values.
- Normal distribution — The function defines the perturbation offset as a value drawn from a normal distribution with the specified mean and standard deviation (or covariance). Normal distribution is the most commonly used distribution since it mimics the natural perturbation of parameters in most cases.
- Truncated normal distribution — The function defines the perturbation offset as a value drawn from a truncated normal distribution with the specified mean, standard deviation (or covariance), lower limit, and upper limit. Different from the normal distribution, the values drawn from a truncated normal distribution are truncated by the lower and upper limit. Use truncated normal distribution when you want to apply a normal distribution, but the valid values of the property are confined in an interval.
- Uniform distribution — The function defines the perturbation offset as a value drawn from a uniform distribution with the specified minimum and maximum values. All the values in the interval (specified by the minimum and maximum values) have the same probability of realization.
- Custom distribution — Customize your own perturbation function. The function must have this syntax:

```
offset = myfun(propVal)
```

where `propVal` is the value of the property and `offset` is the perturbation offset for the property.

This figure shows probability density functions for a normal distribution, a truncated normal distribution, and a uniform distribution, respectively.

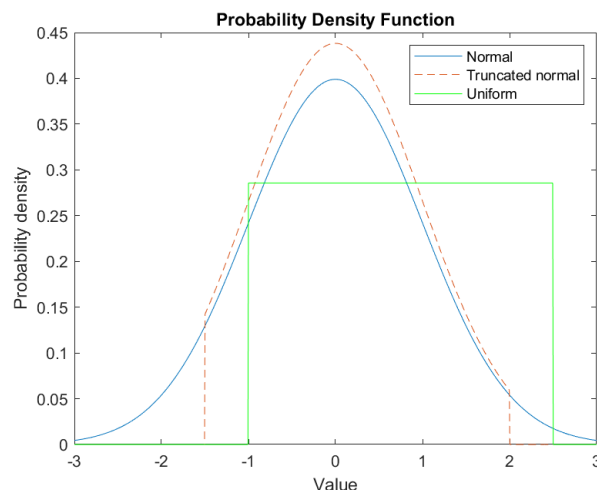

Version History

Introduced in R2021a

See Also

perturb

radarDetectionGenerator

Generate radar detections for driving scenario

Note `radarDetectionGenerator` is not recommended unless you require C/C++ code generation. Use `drivingRadarDataGenerator` instead. For more information, see “Compatibility Considerations”.

Description

The `radarDetectionGenerator` System object generates detections from a radar sensor mounted on an ego vehicle. All detections are referenced to the coordinate system of the ego vehicle. You can use the `radarDetectionGenerator` object in a scenario containing actors and trajectories, which you can create by using a `drivingScenario` object. The object can simulate real detections with added random noise and also generate false alarm detections. In addition, you can use the `radarDetectionGenerator` object to create input to a `multiObjectTracker`. When building scenarios using the **Driving Scenario Designer** app, the radar sensors mounted on the ego vehicle are output as `radarDetectionGenerator` objects.

To generate radar detections:

- 1 Create the `radarDetectionGenerator` object and set its properties.
- 2 Call the object with arguments, as if it were a function.

To learn more about how System objects work, see [What Are System Objects?](#)

Creation

Syntax

```
sensor = radarDetectionGenerator
sensor = radarDetectionGenerator(Name,Value)
```

Description

`sensor = radarDetectionGenerator` creates a radar detection generator object with default property values.

`sensor = radarDetectionGenerator(Name,Value)` sets properties on page 4-1786 using one or more name-value pairs. For example, `radarDetectionGenerator('DetectionCoordinates','SensorCartesian','MaxRange',200)` creates a radar detection generator that reports detections in the sensor Cartesian coordinate system and has a maximum detection range of 200 meters. Enclose each property name in quotes.

Properties

Unless otherwise indicated, properties are *nontunable*, which means you cannot change their values after calling the object. Objects lock when you call them, and the `release` function unlocks them.

If a property is *tunable*, you can change its value at any time.

For more information on changing property values, see *System Design in MATLAB Using System Objects*.

SensorIndex — Unique sensor identifier

positive integer

Unique sensor identifier, specified as a positive integer. This property distinguishes detections that come from different sensors in a multisensor system.

Example: 5

Data Types: `double`

UpdateInterval — Required time interval between sensor updates

0.1 (default) | positive real scalar

Required time interval between sensor updates, specified as a positive real scalar. The `drivingScenario` object calls the radar detection generator at regular time intervals. The radar detector generates new detections at intervals defined by the `UpdateInterval` property. The value of the `UpdateInterval` property must be an integer multiple of the simulation time interval. Updates requested from the sensor between update intervals contain no detections. Units are in seconds.

Example: 5

Data Types: `double`

SensorLocation — Sensor location

[3.4 0] (default) | [x y] vector

Location of the radar sensor center, specified as an [x y] vector. The `SensorLocation` and `Height` properties define the coordinates of the radar sensor with respect to the ego vehicle coordinate system. The default value corresponds to a radar mounted at the center of the front grill of a sedan. Units are in meters.

Example: [4 0.1]

Data Types: `double`

Height — Radar sensor height above ground plane

0.2 (default) | positive real scalar

Radar sensor height above the ground plane, specified as a positive real scalar. The height is defined with respect to the vehicle ground plane. The `SensorLocation` and `Height` properties define the coordinates of the radar sensor with respect to the ego vehicle coordinate system. The default value corresponds to a radar mounted at the center of the front grill of a sedan. Units are in meters.

Example: 0.3

Data Types: `double`

Yaw — Yaw angle of sensor θ (default) | real scalar

Yaw angle of radar sensor, specified as a real scalar. The yaw angle is the angle between the center line of the ego vehicle and the downrange axis of the radar sensor. A positive yaw angle corresponds to a clockwise rotation when looking in the positive direction of the z-axis of the ego vehicle coordinate system. Units are in degrees.

Example: -4

Data Types: double

Pitch — Pitch angle of sensor θ (default) | real scalar

Pitch angle of sensor, specified as a real scalar. The pitch angle is the angle between the downrange axis of the radar sensor and the x-y plane of the ego vehicle coordinate system. A positive pitch angle corresponds to a clockwise rotation when looking in the positive direction of the y-axis of the ego vehicle coordinate system. Units are in degrees.

Example: 3

Data Types: double

Roll — Roll angle of sensor θ (default) | real scalar

Roll angle of the radar sensor, specified as a real scalar. The roll angle is the angle of rotation of the downrange axis of the radar around the x-axis of the ego vehicle coordinate system. A positive roll angle corresponds to a clockwise rotation when looking in the positive direction of the x-axis of the coordinate system. Units are in degrees.

Example: -4

Data Types: double

FieldOfView — Azimuth and elevation fields of view of radar sensor

[20 5] | real-valued 1-by-2 vector of positive values

Azimuth and elevation fields of view of radar sensor, specified as a real-valued 1-by-2 vector of positive values, [azfov elfov]. The field of view defines the angular extent spanned by the sensor. Each component must lie in the interval (0,180]. Targets outside of the field of view of the radar are not detected. Units are in degrees.

Example: [14 7]

Data Types: double

MaxRange — Maximum detection range

150 | positive real scalar

Maximum detection range, specified as a positive real scalar. The radar cannot detect a target beyond this range. Units are in meters.

Example: 200

Data Types: double

RangeRateLimits — Minimum and maximum detection range rates

[-100 100] | real-valued 1-by-2 vector

Minimum and maximum detection range rates, specified as a real-valued 1-by-2 vector. The radar cannot detect a target out this range rate interval. Units are in meters per second.

Example: [-20 100]

Dependencies

To enable this property, set the `HasRangeRate` property to `true`.

Data Types: `double`**DetectionProbability — Probability of detecting a target**

0.9 | positive real scalar less than or equal to 1

Probability of detecting a target, specified as a positive real scalar less than or equal to one. This quantity defines the probability of detecting target that has a radar cross-section, `ReferenceRCS`, at the reference detection range, `ReferenceRange`.

FalseAlarmRate — False alarm rate

1e-6 (default) | positive real scalar

False alarm rate within a radar resolution cell, specified as a positive real scalar in the range $[10^{-7}, 10^{-3}]$. Units are dimensionless.

Example: 1e-5

Data Types: `double`**ReferenceRange — Reference range for given probability of detection**

100 (default) | positive real scalar

Reference range for a given probability of detection, specified as a positive real scalar. The reference range is the range when a target having a radar cross-section specified by `ReferenceRCS` is detected with a probability of specified by `DetectionProbability`. Units are in meters.

Data Types: `double`**ReferenceRCS — Reference radar cross-section for given probability of detection**

0 (default) | nonnegative real scalar

Reference radar cross-section (RCS) for given probability of detection, specified as a nonnegative real scalar. The reference RCS is the value at which a target is detected with probability specified by `DetectionProbability`. Units are in dBsm.

Data Types: `double`**RadarLoopGain — Radar loop gain**

real scalar

This property is read-only.

Radar loop gain, specified as a real scalar. Radar loop gain is related to the reported signal-to-noise ratio of the radar, *SNR*, the target radar cross section, *RCS*, and target range, *R* by

$$\text{SNR} = \text{RadarLoopGain} + \text{RCS} - 40 \cdot \log_{10}(R)$$

SNR and RCS units are in dB and dBsm, respectively and range units are in meters. RadarLoopGain depends on the DetectionProbability, ReferenceRange, ReferenceRCS, and FalseAlarmRate property values. Units are in dB.

Data Types: double

AzimuthResolution — Azimuth resolution of radar

4 (default) | positive real scalar

Azimuth resolution of the radar, specified as a positive real scalar. The azimuth resolution defines the minimum separation in azimuth angle at which the radar can distinguish two targets. The azimuth resolution is typically the 3dB-downpoint in azimuth angle beamwidth of the radar. Units are in degrees.

Data Types: double

ElevationResolution — Elevation resolution of radar

10 (default) | positive real scalar

Elevation resolution of the radar, specified as a positive real scalar. The elevation resolution defines the minimum separation in elevation angle at which the radar can distinguish two targets. The elevation resolution is typically the 3dB-downpoint in elevation angle beamwidth of the radar. Units are in degrees.

Dependencies

To enable this property, set the HasElevation property to true.

Data Types: double

RangeResolution — Range resolution of radar

2.5 (default) | positive real scalar

Range resolution of the radar, specified as a positive real scalar. The range resolution defines the minimum separation in range at which the radar can distinguish between two targets. Units are in meters.

Data Types: double

RangeRateResolution — Range rate resolution of radar

0.5 (default) | positive real scalar

Range rate resolution of the radar, specified as a positive real scalar. The range rate resolution defines the minimum separation in range rate at which the radar can distinguish between two targets. Units are in meters per second.

Dependencies

To enable this property, set the HasRangeRate property to true.

Data Types: double

AzimuthBiasFraction — Azimuth bias fraction

0.1 (default) | nonnegative real scalar

Azimuth bias fraction of the radar, specified as a nonnegative real scalar. The azimuth bias is expressed as a fraction of the azimuth resolution specified in AzimuthResolution. Units are dimensionless.

Data Types: `double`

ElevationBiasFraction — Elevation bias fraction

`0.1` (default) | nonnegative real scalar

Elevation bias fraction of the radar, specified as a nonnegative real scalar. Elevation bias is expressed as a fraction of the elevation resolution specified in `ElevationResolution`. Units are dimensionless.

Dependencies

To enable this property, set the `HasElevation` property to `true`.

Data Types: `double`

RangeBiasFraction — Range bias fraction

`0.05` (default) | nonnegative real scalar

Range bias fraction of the radar, specified as a nonnegative real scalar. Range bias is expressed as a fraction of the range resolution specified in `RangeResolution`. Units are dimensionless.

Data Types: `double`

RangeRateBiasFraction — Range rate bias fraction

`0.05` (default) | nonnegative real scalar

Range rate bias fraction of the radar, specified as a nonnegative real scalar. Range rate bias is expressed as a fraction of the range rate resolution specified in `RangeRateResolution`. Units are dimensionless.

Dependencies

To enable this property, set the `HasRangeRate` property to `true`.

Data Types: `double`

HasElevation — Enable radar to measure elevation

`false` (default) | `true`

Enable the radar to measure target elevation angles, specified as `false` or `true`. Set this property to `true` to model a radar sensor that can estimate target elevation. Set this property to `false` to model a radar sensor that cannot measure elevation.

Data Types: `logical`

HasRangeRate — Enable radar to measure range rate

`false` (default) | `true`

Enable the radar to measure target range rates, specified as `false` or `true`. Set this property to `true` to model a radar sensor which can estimate target range rate. Set this property to `false` to model a radar sensor that cannot measure range rate.

Data Types: `logical`

HasNoise — Enable adding noise to radar sensor measurements

`true` (default) | `false`

Enable adding noise to radar sensor measurements, specified as `true` or `false`. Set this property to `true` to add noise to the radar measurements. Otherwise, the measurements have no noise. Even if

you set `HasNoise` to `false`, the object still computes the `MeasurementNoise` property of each detection.

Data Types: `logical`

HasFalseAlarms — Enable creating false alarm radar detections

`true` (default) | `false`

Enable reporting false alarm radar measurements, specified as `true` or `false`. Set this property to `true` to report false alarms. Otherwise, only actual detections are reported.

Data Types: `logical`

HasOcclusion — Enable line-of-sight occlusion

`true` (default) | `false`

Enable line-of-sight occlusion, specified as `true` or `false`. To generate detections only from objects for which the radar has a direct line of sight, set this property to `true`. For example, with this property enabled, the radar does not generate a detection for a vehicle that is behind another vehicle and blocked from view.

Data Types: `logical`

MaxNumDetectionsSource — Source of maximum number of detections reported

'Auto' (default) | 'Property'

Source of maximum number of detections reported by the sensor, specified as 'Auto' or 'Property'. When this property is set to 'Auto', the sensor reports all detections. When this property is set to 'Property', the sensor reports no more than the number of detections specified by the `MaxNumDetections` property.

Data Types: `char` | `string`

MaxNumDetections — Maximum number of reported detections

50 (default) | positive integer

Maximum number of detections reported by the sensor, specified as a positive integer. Detections are reported in order of distance to the sensor until the maximum number is reached.

Dependencies

To enable this property, set the `MaxNumDetectionsSource` property to 'Property'.

Data Types: `double`

DetectionCoordinates — Coordinate system of reported detections

'Ego Cartesian' (default) | 'Sensor Cartesian' | 'Sensor Spherical'

Coordinate system of reported detections, specified as one of these values:

- 'Ego Cartesian' — Detections are reported in the ego vehicle Cartesian coordinate system.
- 'Sensor Cartesian' — Detections are reported in the sensor Cartesian coordinate system.
- 'Sensor Spherical' — Detections are reported in a spherical coordinate system. This coordinate system is centered at the radar and aligned with the orientation of the radar on the ego vehicle.

Data Types: `char` | `string`

ActorProfiles – Actor profiles

structure | array of structures

Actor profiles, specified as a structure or as an array of structures. Each structure contains the physical and radar characteristics of an actor.

- If `ActorProfiles` is a single structure, all actors passed into the `radarDetectionGenerator` object use this profile.
- If `ActorProfiles` is an array, each actor passed into the object must have a unique actor profile.

To generate an array of structures for your driving scenario, use the `actorProfiles` function. The table shows the valid structure fields. If you do not specify a field, that field is set to its default value. If no actors are passed into the object, then the `ActorID` field is not included.

Field	Description
<code>ActorID</code>	Scenario-defined actor identifier, specified as a positive integer.
<code>ClassID</code>	Classification identifier, specified as a nonnegative integer. 0 is reserved for an object of an unknown or unassigned class.
<code>Length</code>	Length of actor, specified as a positive real scalar. The default is 4.7. Units are in meters.
<code>Width</code>	Width of actor, specified as a positive real scalar. The default is 1.8. Units are in meters.
<code>Height</code>	Height of actor, specified as a positive real scalar. The default is 1.4. Units are in meters.
<code>OriginOffset</code>	Offset of the rotational center of the actor from its geometric center, specified as an [x y z] real-valued vector. The rotational center, or origin, is located at the bottom center of the actor. For vehicles, the rotational center is the point on the ground beneath the center of the rear axle. The default is [0 0 0]. Units are in meters.
<code>RCSPattern</code>	Radar cross-section pattern of actor, specified as a <code>numel(RCSElevationAngles)-by-numel(RCSAzimuthAngles)</code> real-valued matrix. The default is [10 10; 10 10]. Units are in decibels per square meter.
<code>RCSAzimuthAngles</code>	Azimuth angles corresponding to rows of <code>RCSPattern</code> , specified as a vector of real values in the range [-180, 180]. The default is [-180 180]. Units are in degrees.
<code>RCSElevationAngles</code>	Elevation angles corresponding to rows of <code>RCSPattern</code> , specified as a vector of real values in the range [-90, 90]. The default is [-90 90]. Units are in degrees.

For full definitions of the structure fields, see the `actor` and `vehicle` functions.

Usage

Syntax

```
dets = sensor(actors,time)
[dets,numValidDets] = sensor(actors,time)
[dets,numValidDets,isValidTime] = sensor(actors,time)
```

Description

`dets = sensor(actors,time)` creates radar detections, `dets`, from sensor measurements taken of `actors` at the current simulation `time`. The object can generate sensor detections for multiple actors simultaneously. Do not include the ego vehicle as one of the actors.

`[dets,numValidDets] = sensor(actors,time)` also returns the number of valid detections reported, `numValidDets`.

`[dets,numValidDets,isValidTime] = sensor(actors,time)` also returns a logical value, `isValidTime`, indicating that the `UpdateInterval` time has elapsed.

Input Arguments

actors — Scenario actor poses

structure | structure array

Scenario actor poses, specified as a structure or structure array. Each structure corresponds to an actor. You can generate these structures using the `actorPoses` function. You can also create these structures manually.

Field	Description
ActorID	Scenario-defined actor identifier, specified as a positive integer.
Position	Position of actor, specified as a real-valued vector of the form $[x\ y\ z]$. Units are in meters.
Velocity	Velocity (v) of actor in the x - y -, and z -directions, specified as a real-valued vector of the form $[v_x\ v_y\ v_z]$. Units are in meters per second.
Roll	Roll angle of actor, specified as a real-valued scalar. Units are in degrees.
Pitch	Pitch angle of actor, specified as a real-valued scalar. Units are in degrees.
Yaw	Yaw angle of actor, specified as a real-valued scalar. Units are in degrees.
AngularVelocity	Angular velocity (ω) of actor in the x -, y -, and z -directions, specified as a real-valued vector of the form $[\omega_x\ \omega_y\ \omega_z]$. Units are in degrees per second.

For full definitions of the structure fields, see the `actor` and `vehicle` functions.

time — Current simulation time

nonnegative real scalar

Current simulation time, specified as a nonnegative real scalar. The `drivingScenario` object calls the radar detection generator at regular time intervals. The radar detector generates new detections at intervals defined by the `UpdateInterval` property. The value of the `UpdateInterval` property must be an integer multiple of the simulation time interval. Updates requested from the sensor between update intervals contain no detections. Units are in seconds.

Example: 10.5

Data Types: `double`

Output Arguments

dets — Radar sensor detections

cell array of `objectDetection` objects

Radar sensor detections, returned as a cell array of `objectDetection` objects. Each object contains these fields:

Property	Definition
Time	Measurement time
Measurement	Object measurements
MeasurementNoise	Measurement noise covariance matrix
SensorIndex	Unique ID of the sensor
ObjectClassID	Object classification
MeasurementParameters	Parameters used by initialization functions of nonlinear Kalman tracking filters
ObjectAttributes	Additional information passed to tracker

For Cartesian coordinates, `Measurement`, `MeasurementNoise`, and `MeasurementParameters` are reported in the coordinate system specified by the `DetectionCoordinates` property of the `radarDetectionGenerator`.

For spherical coordinates, `Measurement` and `MeasurementNoise` are reported in the spherical coordinate system based on the sensor Cartesian coordinate system. `MeasurementParameters` are reported in sensor Cartesian coordinates.

Measurement

DetectionCoordinates Property	Measurement and Measurement Noise Coordinates		
'Ego Cartesian'	Coordinate Dependence on HasRangeRate		
'Sensor Cartesian'	HasRangeRate	Coordinates	
	true	[x;y;z;vx;vy;vz]	
	false	[x;y;z]	
'Sensor Spherical'	Coordinate Dependence on HasRangeRate and HasElevation		
	HasRangeRate	HasElevation	Coordinates
	true	true	[az;el;rng;rr]
	true	false	[az;rng;rr]
	false	true	[az;el;rng]
	false	false	[az;rng]

MeasurementParameters

Parameter	Definition
Frame	Enumerated type indicating the frame used to report measurements. When Frame is set to 'rectangular', detections are reported in Cartesian coordinates. When Frame is set 'spherical', detections are reported in spherical coordinates.
OriginPosition	3-D vector offset of the sensor origin from the ego vehicle origin. The vector is derived from the SensorLocation and Height properties specified in the radarDetectionGenerator.
Orientation	Orientation of the vision sensor coordinate system with respect to the ego vehicle coordinate system. The orientation is derived from the Yaw, Pitch, and Roll properties of the radarDetectionGenerator.
HasVelocity	Indicates whether measurements contain velocity or range rate components.
HasElevation	Indicates whether measurements contain elevation components.

ObjectAttributes

Attribute	Definition
TargetIndex	Identifier of the actor, ActorID, that generated the detection. For false alarms, this value is negative.
SNR	Detection signal-to-noise ratio in dB.

numValidDets — Number of detections

nonnegative integer

Number of detections, returned as a nonnegative integer.

- When the MaxNumDetectionsSource property is set to 'Auto', numValidDets is set to the length of dets.
- When the MaxNumDetectionsSource property is set to 'Property', dets is a cell array with length determined by the MaxNumDetections property. No more than MaxNumDetections number of detections are returned. If the number of detections is fewer than MaxNumDetections, the first numValidDets elements of dets hold valid detections. The remaining elements of dets are set to the default value.

Data Types: double

isValidTime — Valid detection time

0 | 1

Valid detection time, returned as 0 or 1. isValidTime is 0 when detection updates are requested at times that are between update intervals specified by UpdateInterval.

Data Types: logical

Object Functions

To use an object function, specify the System object as the first input argument. For example, to release system resources of a System object named obj, use this syntax:

```
release(obj)
```

Specific to radarDetectionGenerator

isLocked Determine if System object is in use

Common to All System Objects

step Run System object algorithm

release Release resources and allow changes to System object property values and input characteristics

reset Reset internal states of System object

Examples

Generate Radar Detections of Multiple Vehicles

Generate detections using a forward-facing automotive radar mounted on an ego vehicle. Assume that there are three targets:

- Vehicle 1 is in the center lane, directly in front of the ego vehicle, and driving at the same speed.
- Vehicle 2 is in the left lane and driving faster than the ego vehicle by 12 kilometers per hour.
- Vehicle 3 is in the right lane and driving slower than the ego vehicle by 5 kilometers per hour.

All positions, velocities, and measurements are relative to the ego vehicle. Run the simulation for ten steps.

```
dt = 0.1;
pos1 = [150 0 0];
pos2 = [160 10 0];
pos3 = [130 -10 0];
vel1 = [0 0 0];
vel2 = [12*1000/3600 0 0];
vel3 = [-5*1000/3600 0 0];
car1 = struct('ActorID',1,'Position',pos1,'Velocity',vel1);
car2 = struct('ActorID',2,'Position',pos2,'Velocity',vel2);
car3 = struct('ActorID',3,'Position',pos3,'Velocity',vel3);
```

Create an automotive radar sensor that is offset from the ego vehicle. By default, the sensor location is at (3.4,0) meters from the vehicle center and 0.2 meters above the ground plane. Turn off the range rate computation so that the radar sensor measures position only.

```
radar = radarDetectionGenerator('DetectionCoordinates','Sensor Cartesian', ...
    'MaxRange',200,'RangeResolution',10,'AzimuthResolution',10, ...
    'FieldOfView',[40 15],'UpdateInterval',dt,'HasRangeRate',false);
tracker = multiObjectTracker('FilterInitializationFcn',@initcvkf, ...
    'ConfirmationThreshold',[3 4],'DeletionThreshold',[6 6]);
```

Generate detections with the radar from the non-ego vehicles. The output detections form a cell array and can be passed directly in to the multiObjectTracker.

```
simTime = 0;
nsteps = 10;
for k = 1:nsteps
    dets = radar([car1 car2 car3],simTime);
    [confirmedTracks,tentativeTracks,allTracks] = updateTracks(tracker,dets,simTime);
```

Move the cars one time step and update the multi-object tracker.

```
simTime = simTime + dt;
car1.Position = car1.Position + dt*car1.Velocity;
car2.Position = car2.Position + dt*car2.Velocity;
car3.Position = car3.Position + dt*car3.Velocity;
end
```

Use `birdsEyePlot` to create an overhead view of the detections. Plot the sensor coverage area. Extract the X and Y positions of the targets by converting the `Measurement` fields of the cell array into a MATLAB array. Display the detections on the bird's-eye plot.

```
BEplot = birdsEyePlot('XLim',[0 220],'YLim',[-75 75]);
caPlotter = coverageAreaPlotter(BEplot,'DisplayName','Radar coverage area');
plotCoverageArea(caPlotter,radar.SensorLocation,radar.MaxRange, ...
```

```

    radar.Yaw, radar.FieldOfView(1))
detPlotter = detectionPlotter(BEplot, 'DisplayName', 'Radar detections');
detPos = cellfun(@(d)d.Measurement(1:2), dets, 'UniformOutput', false);
detPos = cell2mat(detPos)';
if ~isempty(detPos)
    plotDetection(detPlotter, detPos)
end

```

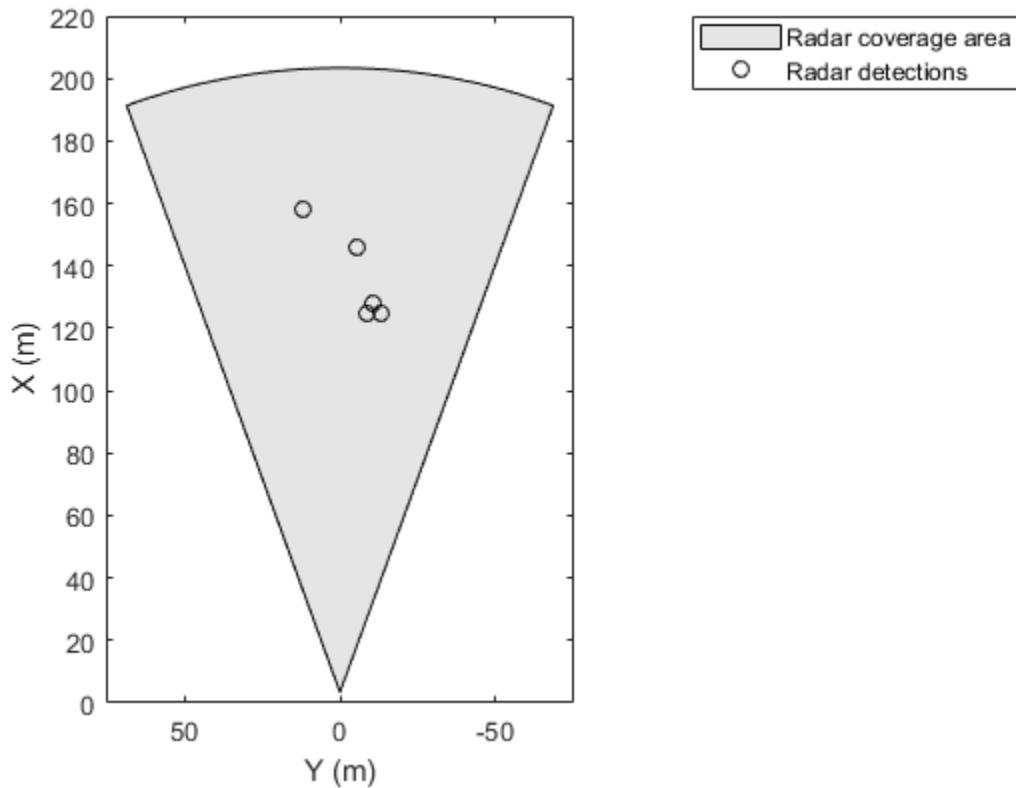

Version History

Introduced in R2017a

R2021a: radarDetectionGenerator System object and Radar Detection Generator block are not recommended

Not recommended starting in R2021a

The `radarDetectionGenerator` System object and Radar Detection Generator block are not recommended unless you require C/C++ code generation. Instead, use the `drivingRadarDataGenerator` System object and Driving Radar Data Generator, respectively. These new radar sensors provide additional properties for modeling radar sensors, including the ability to generate tracks and clustered detections.

There are no current plans to remove the `radarDetectionGenerator` System object or Radar Detection Generator block. MATLAB code and Simulink models that use these features will continue to run. You can still import `radarDetectionGenerator` objects into the **Driving Scenario Designer** app. However, the app updates the parameters of the imported sensor to reflect the

parameters of a `drivingRadarDataGenerator` object. In addition, when you export a scenario containing a `radarDetectionGenerator` sensor to MATLAB code or to a Simulink model, the app exports the sensor as a `drivingRadarDataGenerator` object or Driving Radar Data Generator block, respectively.

Update Code

In MATLAB code, replace all instances of `radarDetectionGenerator` with `drivingRadarDataGenerator`. In addition, update all `radarDetectionGenerator` properties with their equivalent `drivingRadarDataGenerator` properties, as shown in the table. The properties not listed in the table are either specific only to `drivingRadarDataGenerator` or identical in both objects.

radarDetectionGenerator Properties	Equivalent drivingRadarDataGenerator Properties
UpdateInterval	UpdateRate
SensorLocation	MountingLocation
Height	
Yaw	MountingAccuracy
Pitch	
Roll	
MaxRange	RangeLimits
MaxNumDetectionsSource	MaxNumReportsSource
MaxNumDetections	MaxNumReports
ActorProfiles	Profiles

This table shows sample code for creating a `drivingRadarDataGenerator` object instead of a `radarDetectionGenerator` object.

Discouraged Usage	Recommended Replacement
<pre>radar = radarDetectionGenerator(... 'SensorLocation',[-1 0], ... 'Height',0.2, ... 'Yaw',180, ... 'Pitch',0, ... 'Roll',0, ... 'MaxRange',50);</pre>	<pre>radar = drivingRadarDataGenerator(... 'MountingLocation',[-1 0 0.2], ... 'MountingAngles',[180 0 0], ... 'RangeLimits',[0 50]);</pre>

To generate detections from target poses at each simulation time step, replace the `dets = radarDetectionGenerator(targets,time)` syntax with `dets = drivingRadarDataGenerator(targets,time)`.

Update Models

In Simulink models, replace all Radar Detection Generator blocks with Driving Radar Data Generator blocks. In the Driving Radar Data Generator blocks, update the parameter values in the same way you would update the `drivingRadarDataGenerator` property values described in the “Update Code” on page 4-1799 section.

If your model contains a separate block that clusters detections, you can remove it because the Driving Radar Data Generator block clusters detections by default.

For example, in this model, the Sensor Simulation subsystem outputs concatenated detections from Radar Detection Generator blocks into a separate block that clusters the detections.

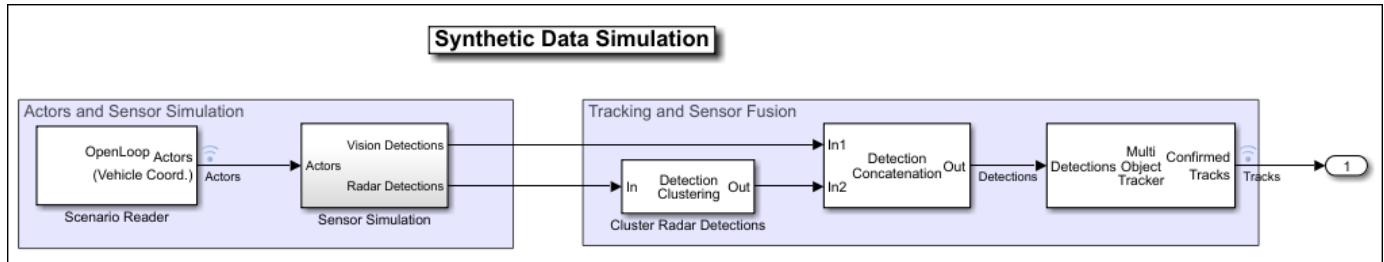

In this model, the Sensor Simulation subsystem outputs concatenated, clustered detections from Driving Radar Data Generator blocks directly into the next part of the model pipeline.

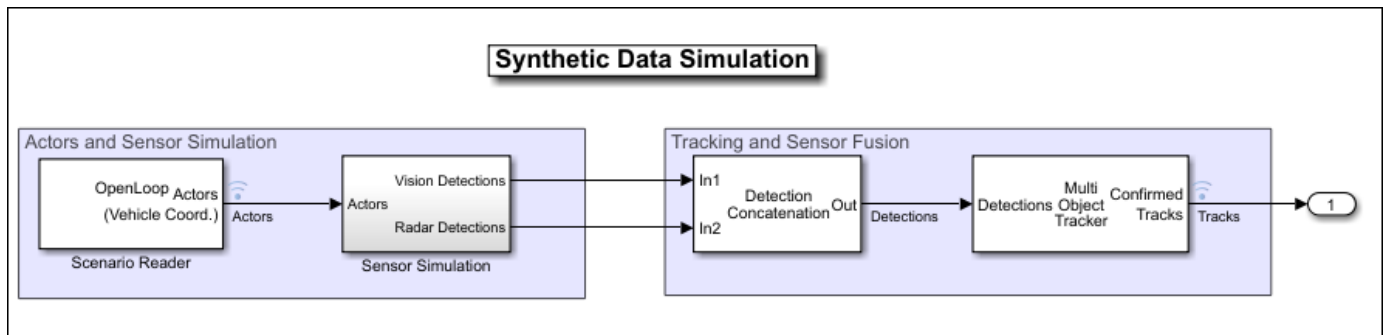

Extended Capabilities

C/C++ Code Generation

Generate C and C++ code using MATLAB® Coder™.

Usage notes and limitations:

See “System Objects in MATLAB Code Generation” (MATLAB Coder).

See Also

drivingRadarDataGenerator

sim3d.maps

Access additional scenes from the server

Description

Use the `sim3d.maps` to download and access additional scenes from the server so that they can be automatically available in the Simulation 3D Scene Configuration block.

Object Functions

<code>sim3d.maps.Map.download</code>	Download maps from the server
<code>sim3d.maps.Map.server</code>	List of maps available for download from the server
<code>sim3d.maps.Map.delete</code>	Delete local maps downloaded from the server
<code>sim3d.maps.Map.local</code>	List of locally available maps

Troubleshooting

- If you cannot reach the server, the download will fail due to a timeout.
- If the download fails while updating an existing map, the existing outdated file will remain functional.
- If you delete the CSV file, you will lose automatic tracking of updates for the existing maps.

Version History

Introduced in R2022b

See Also

Simulation 3D Scene Configuration

sim3d.maps.Map.delete

Delete local maps downloaded from the server

Syntax

```
sim3d.maps.Map.delete(Scene)
```

Description

`sim3d.maps.Map.delete(Scene)` deletes the map `Scene` from your local system.

Examples

Download Suburban Scene Map

This example shows how to download and access the Suburban scene map from the Simulation 3D Scene Configuration block.

To begin, check the maps available in the server.

Add the Simulation 3D Scene Configuration block to your model.

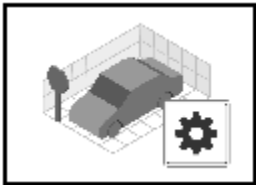

Open the block mask and select the suburban scene from **Scene name**.



Run the model.



Delete the model and check if the map is still available locally.

```
sim3d.maps.Map.delete('Suburban scene')
```

```
Suburban scene was successfully deleted
```

Input Arguments

Scene — Name of scene

string | character array

Name of the map being deleted, specified as a string or character array. Once the map is deleted, it automatically disappears from the Simulation 3D Scene Configuration block mask menu.

Version History

Introduced in R2022b

See Also

`sim3d.maps` | `sim3d.maps.Map.download` | `sim3d.maps.Map.server` |
`sim3d.maps.Map.local`

sim3d.maps.Map.download

Download maps from the server

Syntax

```
sim3d.maps.Map.download(Scene)
```

Description

`sim3d.maps.Map.download(Scene)` downloads the map `Scene` from the server.

Examples

Download Suburban Scene Map

This example shows how to download and access the Suburban scene map from the Simulation 3D Scene Configuration block.

To begin, check the maps available in the server.

```
sim3d.maps.Map.server
```

MapName	Description	Version	MinimumRelease
"Suburban scene"	"a suburban area beyond the city's border"	"1"	"R2022b"

Download the Suburban scene from the server.

```
sim3d.maps.Map.download('Suburban scene')
```

Map is susccesfully downloaded and is up-to-date

Check if the downloaded maps are available in your local machine.

```
sim3d.maps.Map.local
```

MapName	Description	Version	MinimumRelease
"Suburban scene"	"a suburban area beyond the city's border"	"1"	"R2022b"

Add the Simulation 3D Scene Configuration block to your model.

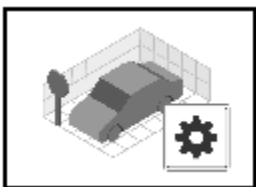

Open the block mask and select the suburban scene from **Scene name**.



Run the model.



Input Arguments

Scene — Name of scene

string | character array

Name of the map being downloaded from the server, specified as a string or character array. Maps are downloaded in the default folder that is added to MATLAB search path at startup.

Maps are stored by user profile. For multiuser setup with a single MATLAB installation, the maps will be downloaded multiple times.

If a new version of the map is available on the server, you will see a warning message asking you to download the map again to get the recent version.

Version History

Introduced in R2022b

See Also

[sim3d.maps](#) | [sim3d.maps.Map.server](#) | [sim3d.maps.Map.delete](#) | [sim3d.maps.Map.local](#)

sim3d.maps.Map.local

List of locally available maps

Syntax

```
sim3d.maps.Map.local
```

Description

`sim3d.maps.Map.local` lists the locally available maps.

Examples

Download Suburban Scene Map

This example shows how to download and access the Suburban scene map from the Simulation 3D Scene Configuration block.

To begin, check the maps available in the server.

```
sim3d.maps.Map.server
```

MapName	Description	Version	MinimumRelease
"Suburban scene"	"a suburban area beyond the city's border"	"1"	"R2022b"

Download the Suburban scene from the server.

```
sim3d.maps.Map.download('Suburban scene')
```

Map is susccesfully downloaded and is up-to-date

Check if the downloaded maps are available in your local machine.

```
sim3d.maps.Map.local
```

MapName	Description	Version	MinimumRelease
"Suburban scene"	"a suburban area beyond the city's border"	"1"	"R2022b"

Add the Simulation 3D Scene Configuration block to your model.

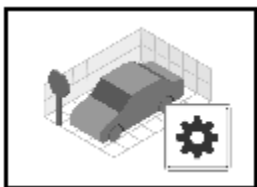

Open the block mask and select the suburban scene from **Scene name**.



Run the model.



Version History

Introduced in R2022b

See Also

[sim3d.maps](#) | [sim3d.maps.Map.download](#) | [sim3d.maps.Map.server](#) | [sim3d.maps.Map.delete](#)

sim3d.maps.Map.server

List of maps available for download from the server

Syntax

```
sim3d.maps.Map.server
```

Description

sim3d.maps.Map.server lists the available maps in the server.

Examples

Download Suburban Scene Map

This example shows how to download and access the Suburban scene map from the Simulation 3D Scene Configuration block.

To begin, check the maps available in the server.

```
sim3d.maps.Map.server
```

MapName	Description	Version	MinimumRelease
"Suburban scene"	"a suburban area beyond the city's border"	"1"	"R2022b"

Download the Suburban scene from the server.

```
sim3d.maps.Map.download('Suburban scene')
```

Map is susccesfully downloaded and is up-to-date

Check if the downloaded maps are available in your local machine.

```
sim3d.maps.Map.local
```

MapName	Description	Version	MinimumRelease
"Suburban scene"	"a suburban area beyond the city's border"	"1"	"R2022b"

Add the Simulation 3D Scene Configuration block to your model.

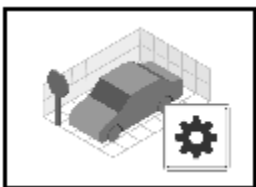

Open the block mask and select the suburban scene from **Scene name**.



Run the model.



Version History

Introduced in R2022b

See Also

[sim3d.maps](#) | [sim3d.maps.Map.download](#) | [sim3d.maps.Map.delete](#) | [sim3d.maps.Map.local](#)

copyExampleSim3dProject

Copy support package files and plugins to specified folders

Syntax

```
sim3d.utils.copyExampleSim3dProject(DestFldr)
sim3d.utils.copyExampleSim3dProject(DestFldr,Name=Value)
```

Description

`sim3d.utils.copyExampleSim3dProject(DestFldr)` copies the support package project files to the destination folder, `DestFldr`. By default, `copyExampleSim3dProject` copies the plugins to your Epic Games installation folder.

`sim3d.utils.copyExampleSim3dProject(DestFldr,Name=Value)` copies support package files to the destination with additional options specified by name-value arguments.

Running the `sim3d.utils.copyExampleSim3dProject` function configures your environment so that you can customize scenes. The support package contains these Automated Driving Toolbox Interface for Unreal Engine 4 Projects.

- An Unreal project, defined in `AutoVrtlEnv.uproject`, and its associated files. The project includes editable versions of the prebuilt 3D scenes that you can select from the **Scene name** parameter of the Simulation 3D Scene Configuration block.
- Three plugins, `MathWorkSimulation: RoadRunnerMaterials`, and `MathWorksAutomotiveContent`. These plugins establish the connection between MATLAB and the Unreal Editor and are required for co-simulation.
- A RoadRunner scene project defined in `RRscene.uproject` file, along with a `WindowsPackage` folder that contains supporting files and the executable `RRscene.exe`. This project contains the editable version of the scene and the executable with supporting files to co-simulate the “Highway Lane Following with RoadRunner Scene” example.

Input Arguments

DestFldr — Destination folder for Unreal project files

character vector

Destination folder name, specified as a character vector.

Running `copyExampleSim3dProject` copies the Unreal project, defined in `AutoVrtlEnv.uproject`, and its associated files to the destination folder.

Note You must have write permission for the destination folder.

Example: `C:\project`

Data Types: `char` | `string`

Name-Value Pair Arguments

Specify optional pairs of arguments as `Name1=Value1, ..., NameN=ValueN`, where `Name` is the argument name and `Value` is the corresponding value. Name-value arguments must appear after other arguments, but the order of the pairs does not matter.

Source — Support package source folder

character vector

Support package source folder, specified as a character vector. The folder contains the downloaded support packages files.

By default, if you do not specify the source folder, `copyExampleSim3dProject` copies the file from the support package installation folder, `matlabshared.supportpkg.getSupportPackageRoot()`.

Example: `Source="shared\sim3dprojects\spkg\"`

Data Types: `char` | `string`

PluginDestination — Option to change the plugin destination folder

character vector

Option to change the plugin destination folder, specified as a character vector.

By default, if you do not change the plugin installation folder location, `copyExampleSim3dProject` tries to copy the plugins to `C:\Program Files\Epic Games\UE_4.27\Engine\Plugins\MathWorks`.

Example: `PluginDestination="C:\Program Files\Epic Games\UE_4.27\Engine\Plugins\MathWorks"`

Data Types: `char` | `string`

VerboseOutput — Option to enable verbose logging

0 or false (default) | 1 or true

Option to enable verbose logging, specified as a logical 0 (false) or 1 (true). Verbose logging displays intermediate iteration information on the MATLAB command line.

Example: `VerboseOutput=true`

Data Types: `logical`

Examples

Copy Support Package Files to Destination Folder

Copy the support package files to `C:\project`.

```
sim3d.utils.copyExampleSim3dProject("C:\project");
```

Copy the support package files to `C:\project` with `VerboseOutput` set to `true`.

```
sim3d.utils.copyExampleSim3dProject("C:\project", VerboseOutput=true)
```

```
Copying ... \spkg\project\AutoVrtlEnv to C:\project\AutoVrtlEnv
Creating C:\project\AutoVrtlEnv\Plugins
```

```
Copying ...\\spkg\\plugins\\mw_aerospace\\MathWorksAerospace to C:\\project\\AutoVrtlEnv\\Plugins\\MathW
Copying ...\\spkg\\plugins\\mw_automotive\\MathWorksAutomotiveContent to C:\\project\\AutoVrtlEnv\\Plug
Copying ...\\spkg\\plugins\\mw_simulation\\MathWorksSimulation to C:\\project\\AutoVrtlEnv\\Plugins\\Matl
Copying ...\\spkg\\plugins\\mw_uav\\MathWorksUAVContent to C:\\project\\AutoVrtlEnv\\Plugins\\MathWorksU
Copying ...\\spkg\\plugins\\rr_materials\\RoadRunnerMaterials to C:\\project\\AutoVrtlEnv\\Plugins\\RoadR
Ensuring C:\\project\\AutoVrtlEnv\\AutoVrtlEnv.uproject is writable
Enabling plugin MathWorksSimulation in C:\\project\\AutoVrtlEnv\\AutoVrtlEnv.uproject
Enabling plugin MathWorksUAVContent in C:\\project\\AutoVrtlEnv\\AutoVrtlEnv.uproject
Enabling plugin MathWorksAutomotiveContent in C:\\project\\AutoVrtlEnv\\AutoVrtlEnv.uproject
Enabling plugin RoadRunnerMaterials in C:\\project\\AutoVrtlEnv\\AutoVrtlEnv.uproject
```

Version History

Introduced in R2022b

See Also

External Websites

Unreal Engine

Using Unreal Engine with Simulink

actorTracklist

Store recorded actor track list data with timestamps

Description

The actorTracklist object stores recorded actor track list data and associates it with the timestamps at which it was recorded.

Creation

Syntax

```
trackdata = actorTracklist
trackdata = actorTracklist(timestamp,trackID,classID,position)
trackdata = actorTracklist( ____,Name=Value)
```

Description

trackdata = actorTracklist creates an empty actorTracklist object, trackdata.

trackdata = actorTracklist(timestamp,trackID,classID,position) sets the TimeStamp, TrackIDs, ClassIDs, and Position properties of the returned actorTracklist object using the timestamp, trackID, classID, and position arguments, respectively.

trackdata = actorTracklist(____,Name=Value) sets properties on page 4-1815 using one or more name-value arguments in addition to any combination of input arguments from previous syntaxes. For example, Velocity={ [4 1 0; 2 2 1] } specifies velocities of the form [vx vy vz] for two actors at one timestamp. Because all actorTracklist properties are read-only, you must set them at object creation. To update them after creation, you must use the addData and removeData object functions.

Note This object requires the Scenario Builder for Automated Driving Toolbox support package. You can install Scenario Builder for Automated Driving Toolbox from the Add-On Explorer. For more information about installing add-ons, see Get and Manage Add-Ons.

Properties

TimeStamp — Timestamps of actor track information

[] (default) | *N*-element numeric column vector

This property is read-only.

Timestamps of actor track information, specified as an *N*-element numeric column vector. *N* is the number of timestamps. Each element indicates the time from the start of the simulation, in seconds, at which the associated track was captured.

When you initialize the object with timestamp data, the object arranges the input timestamps in increasing order. If the input data contains multiple rows of data with the same timestamp, the object merges that data into a single row.

Data Types: `single` | `double`

TrackIDs — Track IDs of actors

[] (default) | N -by-1 cell array

This property is read-only.

Track IDs of the actors, specified as an N -by-1 cell array. N is the number of timestamps. Each cell contains the track IDs of the actors detected at the corresponding timestamp, specified as a 1-by- M string array. M is the number of actors at the timestamp.

ClassIDs — Classification IDs of actors

[] (default) | N -by-1 cell array

This property is read-only.

Classification IDs of the actors, specified as an N -by-1 cell array. N is the number of timestamps. Each cell contains the class IDs of the actors detected at the corresponding timestamp, specified as an M -element row vector of nonnegative integers. M is the number of actors at the timestamp.

`classIDs` must be specified as one of these nonnegative integers:

- 1 — Car
- 2 — Truck
- 3 — Bicycle
- 4 — Pedestrian
- 0 — Others

Position — Positions of actors

[] (default) | N -by-1 cell array

This property is read-only.

Positions of the actors with respect to the ego frame, specified as an N -by-1 cell array. N is the number of timestamps. Each cell contains the positions of the actors detected at the corresponding timestamp, specified as an M -by-3 numeric matrix. M is the number of actors at the timestamp. Each row specifies the position of an actor in the form $[x\ y\ z]$. Units are in meters.

Dimension — Dimensions of actors

[] (default) | N -by-1 cell array

This property is read-only.

Dimensions of the actors, specified as an N -by-1 cell array. N is the number of timestamps. Each cell contains the dimensions of the actors detected at the corresponding timestamp, specified as an M -by-3 numeric matrix. M is the number of actors at the timestamp. Each row specifies the dimensions of an actor in the form $[length\ width\ height]$. Units are in meters.

Orientation — Orientations of actors

[] (default) | N -by-1 cell array

This property is read-only.

Orientations of the actors, specified as an N -by-1 cell array. N is the number of timestamps. Each cell contains the orientations of the actors detected at the corresponding timestamp, specified as an M -by-3 numeric matrix. M is the number of actors at the timestamp. Each row specifies the orientation of an actor in the form [yaw pitch roll]. Units are in degrees.

Velocity – Velocities of actors

[] (default) | N -by-1 cell array

This property is read-only.

Velocities of the actors with respect to the ego frame, specified as an N -by-1 cell array. N is the number of timestamps. Each cell contains the velocities of the actors detected at the corresponding timestamp, specified as an M -by-3 numeric matrix. M is the number of actors at the timestamp. Each row specifies the velocity of an actor in the form [vx vy vz]. Units are in meters per second.

Speed – Speeds of actors

[] (default) | N -by-1 cell array

This property is read-only.

Speeds of the actors with respect to the ego frame, specified as an N -by-1 cell array. N is the number of timestamps. Each cell contains the speeds of the actors detected at the corresponding timestamp, specified as an M -element numeric row vector. M is the number of actors at the timestamp. Units are in meters per second.

UniqueTrackIDs – Unique track IDs in recorded data

[] (default) | P -element column vector

This property is read-only.

Unique track IDs in the recorded data, specified as a P -element column vector. P is the number of unique track IDs in the recorded data.

Data Types: string

StartTime – Start time of actor track recording

[] (default) | scalar

This property is read-only.

Start time of actor track recording, specified as a scalar. Units are in seconds.

Data Types: single | double

EndTime – End time of actor track recording

[] (default) | scalar

This property is read-only.

End time of the actor track recording, specified as a scalar. Units are in seconds.

Data Types: single | double

NumSamples – Number of recorded actor track samples

0 (default) | positive integer

This property is read-only.

Number of recorded actor track samples, specified as a positive integer.

Data Types: double

Object Functions

`readData` Read actor data from track list
`addData` Add data to actor track list object
`removeData` Remove data from actor track list object
`findNearest` Find actor information nearest to specified timestamp in actor track list object
`updateTime` Update timestamps of actor track list object

Examples

Create Actor Track List Object

Load recorded actor track list data into the workspace.

```
data = load("actorTracklistData.mat");
```

Extract the recorded timestamps and the actor track IDs, class IDs, and position information from the data.

```
t = data.timestamps;  
trackids = data.actorTrackIDs;  
classids = data.actorClassIDs;  
pos = data.actorPosition;
```

Initialize an `actorTracklist` object by using the extracted data.

```
actorTrackData = actorTracklist(t,trackids,classids,pos);
```

Display the details of the `actorTracklist` object.

```
disp(actorTrackData)
```

```
actorTracklist with properties:  
  
    TimeStamp: [600x1 double]  
    TrackIDs: {600x1 cell}  
    ClassIDs: {600x1 cell}  
    Position: {600x1 cell}  
    Dimension: []  
    Orientation: []  
    Velocity: []  
    Speed: []  
    StartTime: 3.8300e-04  
    EndTime: 29.9514  
    NumSamples: 600  
    UniqueTrackIDs: [18x1 string]
```

Create Actor Track List Object with Actor Velocity Information

Load recorded actor track list data into the workspace.

```
data = load("actorTracklistData.mat");
```

Extract the recorded timestamps and the actor track IDs, class IDs, position, and velocity information from the data.

```
t = data.timestamps;  
trackids = data.actorTrackIDs;  
classids = data.actorClassIDs;  
pos = data.actorPosition;  
vel = data.actorVelocity;
```

Initialize an actorTracklist object by using the extracted data.

```
actorTrackData = actorTracklist(t,trackids,classids,pos,Velocity=vel);
```

Display the first eight rows of the velocity information from the actorTracklist object.

```
head(actorTrackData.Velocity)
```

```
{3x3 single}  
{3x3 single}  
{3x3 single}  
{3x3 single}  
{3x3 single}  
{3x3 single}  
{3x3 single}  
{3x3 single}
```

Tips

- Use an actorTracklist object as the tracklist input argument for the actorprops function.

Version History

Introduced in R2023a

See Also

actorprops | laneData

addData

Add data to actor track list object

Syntax

```
addData(trackdata,timestamps,trackID,classID,position)
addData( ____,Name=Value)
```

Description

`addData(trackdata,timestamps,trackID,classID,position)` adds the specified track ID data `trackID`, class ID data `classID`, and position data `position` with the corresponding timestamps `timestamps` to the `actorTracklist` object `trackdata`.

`addData(____,Name=Value)` specifies additional options using name-value arguments, in addition to all input arguments from the previous syntax. For example, `Velocity={[4 1 0; 2 2 1]}` adds velocities of the form `[vx vy vz]` for two actors at one timestamp.

Note This function requires the Scenario Builder for Automated Driving Toolbox support package. You can install Scenario Builder for Automated Driving Toolbox from the Add-On Explorer. For more information about installing add-ons, see [Get and Manage Add-Ons](#).

Examples

Create Empty Actor Track List Object and Add Data

Create an empty `actorTracklist` object.

```
actorObject = actorTracklist
actorObject =
  actorTracklist with properties:
    TimeStamp: []
    TrackIDs: []
    ClassIDs: []
    Position: []
    Dimension: []
    Orientation: []
    Velocity: []
    Speed: []
    StartTime: []
    EndTime: []
    NumSamples: 0
    UniqueTrackIDs: []
```

Load recorded actor track list data into the workspace.

```
data = load("actorTracklistData.mat");
```

Extract the recorded timestamps and the actor track IDs, class IDs, and position information from the data.

```
t = data.timestamps;           % Extract timestamps
trackids = data.actorTrackIDs; % Extract track IDs
classids = data.actorClassIDs; % Extract class IDs
pos = data.actorPosition;     % Extract position information
```

Add the first five rows of data to the empty actorTracklist object.

```
addData(actorObject,t(1:5),trackids(1:5),classids(1:5),pos(1:5))
```

Display the details of the actorTracklist object.

```
disp(actorObject)

actorTracklist with properties:

    TimeStamp: [5x1 double]
    TrackIDs: {5x1 cell}
    ClassIDs: {5x1 cell}
    Position: {5x1 cell}
    Dimension: []
    Orientation: []
    Velocity: []
    Speed: []
    StartTime: 3.8300e-04
    EndTime: 0.2003
    NumSamples: 5
    UniqueTrackIDs: [3x1 string]
```

Input Arguments

trackdata — Actor track list information

actorTracklist object

Actor track list information, specified as an actorTracklist object.

timestamps — Recording timestamps of track information to add

scalar | N -by-1 vector

Recording timestamps of track information to add, specified as a scalar or an N -element column vector. N is the number of timestamps. Units are in seconds.

Data Types: single | double

trackID — Track IDs of actors

N -by-1 string array | N -by-1 cell array

Track IDs of the actors, specified as an N -by-1 string array or an N -by-1 cell array. N is the number of timestamps for which you are adding information.

For a single recorded actor across each timestamp, specify trackID as an N -by-1 string array.

For a multiple recorded actors across each timestamp, specify trackID as an N -by-1 cell array. Each cell contains the track IDs of the actors to add at the corresponding timestamp, specified as a 1-by- M string array. M is the number of actors at the timestamp.

classID — Classification IDs of actors*N*-element column vector | *N*-by-1 cell array

Classification IDs of the actors, specified as an *N*-element column vector or an *N*-by-1 cell array. *N* is the number of timestamps for which you are adding information.

For a single recorded actor across each timestamp, specify `classID` as an *N*-by-1 vector.

For a multiple recorded actors across each timestamp, specify `classID` as an *N*-by-1 cell array. Each cell contains the class IDs of the detected actors to add at the corresponding timestamp, specified as an *M*-element row vector of nonnegative integers. *M* is the number of actors at the timestamp.

You must specify each class ID as one of these nonnegative integers:

- 1 — Car
- 2 — Truck
- 3 — Bicycle
- 4 — Pedestrian
- 0 — Others

position — Positions of actors*N*-by-1 cell array

Positions of actors with respect to the ego frame, specified as an *N*-by-1 cell array. *N* is the number of timestamps for which you are adding information. Each cell contains the positions of the actors detected at the corresponding timestamp, specified as an *M*-by-3 numeric matrix. *M* is the number of actors at the timestamp. Each row specifies the position of an actor in the form $[x\ y\ z]$. Units are in meters.

Name-Value Pair Arguments

Specify optional pairs of arguments as `Name1=Value1, ..., NameN=ValueN`, where `Name` is the argument name and `Value` is the corresponding value. Name-value arguments must appear after other arguments, but the order of the pairs does not matter.

Example: `addData(trackdata,timestamps,trackID,classID,position,Velocity={ [4 1 0; 2 2 1] })` adds velocities of the form $[v_x\ v_y\ v_z]$ for two actors at one timestamp.

Dimension — Dimensions of the actors*N*-by-1 cell array

Dimensions of the actors, specified as an *N*-by-1 cell array. *N* is the number of timestamps for which you are adding information. Each cell contains the dimensions of the actors detected at the corresponding timestamp, specified as an *M*-by-3 numeric matrix. *M* is the number of actors at the timestamp. Each row specifies the dimension of an actor in the form $[length\ width\ height]$. Units are in meters.

Orientation — Orientations of the actors*N*-by-1 cell array

Orientations of the actors, specified as an *N*-by-1 cell array. *N* is the number of timestamps for which you are adding information. Each cell contains the orientations of the actors detected at the corresponding timestamp, specified as an *M*-by-3 numeric matrix. *M* is the number of actors at the

timestamp. Each row specifies the orientation of an actor in the form [*yaw pitch roll*]. Units are in degrees.

Speed — Speeds of actors

N-by-1 cell array

Speeds of the actors with respect to the ego frame, specified as an *N*-by-1 cell array. *N* is the number of timestamps for which you are adding information. Each cell contains the speeds of the actors detected at the corresponding timestamp, specified as an *M*-element numeric row vector. *M* is the number of actors at the timestamp. Units are in meters per second.

Velocity — Velocities of actors

N-by-1 cell array

Velocities of the actors with respect to the ego frame, specified as an *N*-by-1 cell array. *N* is the number of timestamps for which you are adding information. Each cell contains the velocities of the actors detected at the corresponding timestamp, specified as an *M*-by-3 numeric matrix. *M* is the number of actors at a timestamp. Each row specifies the velocity of an actor in the form [*vx vy vz*]. Units are in meters per second.

Version History

Introduced in R2023a

See Also

[actorTracklist](#) | [actorprops](#) | [laneData](#)

findNearest

Find actor information nearest to specified timestamp in actor track list object

Syntax

```
data = findNearest(trackdata,timestamp)
data = findNearest(trackdata,timestamp,"lessThanEqual")
data = findNearest(trackdata,timestamp,"greaterThanEqual")
```

Description

`data = findNearest(trackdata,timestamp)` finds the actor information nearest to the specified timestamp `timestamp` in the `actorTracklist` object `trackdata`.

`data = findNearest(trackdata,timestamp,"lessThanEqual")` finds the actor information nearest to and less than the specified timestamp `timestamp`.

`data = findNearest(trackdata,timestamp,"greaterThanEqual")` finds the actor information nearest to and greater than the specified timestamp `timestamp`.

Note This function requires the Scenario Builder for Automated Driving Toolbox support package. You can install Scenario Builder for Automated Driving Toolbox from the Add-On Explorer. For more information about installing add-ons, see [Get and Manage Add-Ons](#).

Examples

Find Data Nearest to Timestamp in Actor Track List Object

Load an initialized `actorTracklist` object into the workspace.

```
actorObject = load("actorTracklistObject.mat");
actorObject = actorObject.actorObject;
```

Specify a timestamp for which to find data in the `actorTracklist` object.

```
t = 10;
```

Find the data nearest to the specified timestamp in the `actorTracklist` object.

```
nd = findNearest(actorObject,t);
```

Display the data.

```
disp(nd)
```

TimeStamp	ActorInfo
10.001	{3x1 struct}

Input Arguments

trackdata – Actor track list information

actorTracklist object

Actor track list information, specified as an actorTracklist object.

timestamp – Timestamp near which to read actor data

numeric scalar

Timestamp near which to read actor data, specified as a numeric scalar. Units are in seconds.

Data Types: single | double

Output Arguments

data – Actor track list data

1-by-2 table

Actor track list data, returned as a 1-by-2 table. Each row in the table represents track information relative to its recording time.

Each element of the first column of the table contains the timestamp at which the corresponding track information was captured, returned as a positive scalar. Units are in seconds.

Each element of the second column of the table contains the track information of non-ego actors, returned as an M -by-1 structure array. M is the number of actors with track information recorded at the corresponding timestamp. Each structure has these fields:

Field	Description
TrackID	Track ID of the actor, returned as a numeric scalar, a string scalar, or a character vector.
ClassID	Classification identifier of the actor, returned as one of these nonnegative integers: <ul style="list-style-type: none"> • 1 – Car • 2 – Truck • 3 – Bicycle • 4 – Pedestrian • 0 – Others
Position	Position of the actor with respect to the ego frame, returned as a three-element numeric row vector of the form $[x\ y\ z]$. Units are in meters.
Dimension	Dimensions of the actor, returned as a three-element numeric row vector of the form $[length\ width\ height]$. Units are in meters.

Field	Description
Yaw	Yaw angle of the actor with respect to the ego frame, returned as a numeric scalar. Units are in degrees.
Pitch	Pitch angle of the actor with respect to the ego frame, returned as a numeric scalar. Units are in degrees.
Roll	Roll angle of the actor with respect to the ego frame, returned as a numeric scalar. Units are in degrees.
Speed	Speed of the actor with respect to the ego frame, returned as a numeric scalar. Units are in meters per second.
Velocity	Velocity of the actor with respect to the ego frame, returned as a three-element numeric row vector of the form [vx vy vz]. Units are in meters per second.

Version History

Introduced in R2023a

See Also

actorTracklist | actorprops | laneData

readData

Read actor data from track list

Syntax

```
data = readData(trackdata,"all")
data = readData(trackdata,Name=Value)
```

Description

`data = readData(trackdata,"all")` reads all data from the `actorTracklist` object `trackdata`, and returns a table, `data`.

`data = readData(trackdata,Name=Value)` specifies additional options using name-value arguments. For example, `TrackIDs="4"` reads all data with track ID 4 from the input `actorTracklist` object `trackdata`.

Note This function requires the Scenario Builder for Automated Driving Toolbox support package. You can install Scenario Builder for Automated Driving Toolbox from the Add-On Explorer. For more information about installing add-ons, see [Get and Manage Add-Ons](#).

Examples

Read Data From Actor Track List Object Using Row Indices

Load recorded actor track list data into the workspace.

```
data = load("actorTracklistData.mat");
```

Extract the recorded timestamps and the actor track IDs, class IDs, and position information from the data.

```
t = data.timestamps;           % Extract timestamps
trackids = data.actorTrackIDs; % Extract track IDs
classids = data.actorClassIDs; % Extract class IDs
pos = data.actorPosition;      % Extract position information
```

Initialize an `actorTracklist` object by using the extracted data.

```
actorTrackData = actorTracklist(t,trackids,classids,pos);
```

Specify row indices for which to read data from the `actorTracklist` object.

```
idxs = (1:10)';
```

Read data for the specified row indices.

```
tab = readData(actorTrackData,RowIndices=idxs);
```

Display the first eight rows of the table containing actor track information.

```
head(tab)
```

TimeStamp	ActorInfo
0.000383	{3x1 struct}
0.050654	{3x1 struct}
0.10058	{3x1 struct}
0.1504	{3x1 struct}
0.20034	{3x1 struct}
0.25059	{3x1 struct}
0.30035	{3x1 struct}
0.35015	{3x1 struct}

Read Data From Actor Track List Object Using Timestamps

Load recorded actor track list data into the workspace.

```
data = load("actorTracklistData.mat");
```

Extract the recorded timestamps and the actor track IDs, class IDs, and position information from the data.

```
t = data.timestamps;           % Extract timestamps
trackids = data.actorTrackIDs; % Extract track IDs
classids = data.actorClassIDs; % Extract class IDs
pos = data.actorPosition;      % Extract position information
```

Initialize an actorTracklist object by using the extracted data.

```
actorTrackData = actorTracklist(t,trackids,classids,pos);
```

Specify the timestamps for which to read data from the actorTracklist object.

```
ts = t(1:3);
```

Read data for the specified timestamps.

```
tab = readData(actorTrackData,Timestamps=ts);
```

Display the data.

```
disp(tab)
```

TimeStamp	ActorInfo
0.000383	{3x1 struct}
0.050654	{3x1 struct}
0.10058	{3x1 struct}

Read Data From Actor Track List Object Using Track IDs

Load recorded actor track list data into the workspace.

```
data = load("actorTracklistData.mat");
```

Extract the recorded timestamps and the actor track IDs, class IDs, and position information from the data.

```
t = data.timestamps;           % Extract timestamps
trackids = data.actorTrackIDs; % Extract track IDs
classids = data.actorClassIDs; % Extract class IDs
pos = data.actorPosition;     % Extract position information
```

Initialize an actorTracklist object by using the extracted data.

```
actorTrackData = actorTracklist(t,trackids,classids,pos);
```

Specify a track ID for which to read data from the actorTracklist object.

```
tid = "4";
```

Read data for the specified track ID.

```
tab = readData(actorTrackData,TrackIDs=tid);
```

Display the first eight rows of the table containing actor track information.

```
head(tab)
```

TimeStamp	ActorInfo
0.000383	{1x1 struct}
0.050654	{1x1 struct}
0.10058	{1x1 struct}
0.1504	{1x1 struct}
0.20034	{1x1 struct}
0.25059	{1x1 struct}
0.30035	{1x1 struct}
0.35015	{1x1 struct}

Input Arguments

trackdata — Actor track list information

actorTracklist object

Actor track list information, specified as an actorTracklist object.

Name-Value Pair Arguments

Specify optional pairs of arguments as Name1=Value1, . . . , NameN=ValueN, where Name is the argument name and Value is the corresponding value. Name-value arguments must appear after other arguments, but the order of the pairs does not matter.

Example: `readData(trackdata,TrackIDs="4")` reads the data with track ID 4 from the input actorTracklist object trackdata.

RowIndices — Row indices for which to read track information

N-element column vector

Row indices for which to read track information, specified as an N -element column vector of positive integers. N is the number of row indices of the input `trackdata` from which to read data. Values must be in the range $[1, \text{NumSamples}]$, where `NumSamples` is the value of the `NumSamples` property of the input `trackdata`.

Data Types: `single` | `double` | `uint8` | `uint16` | `uint32` | `uint64`

Timestamps – Timestamps for which to read track information

N -element column vector

Timestamps for which to read track information, specified as an N -element column vector. N is the number of timestamps of the input `trackdata` from which to read data. Units are in seconds.

Data Types: `single` | `double`

TrackIDs – Track IDs of actors for which to read track information

N -by-1 string array

Track IDs of the actors for which to read track information, specified as an N -by-1 string array. N is the number of track IDs for which to read data from the input `trackdata`.

Data Types: `char` | `string`

Output Arguments

data – Actor track list data

K -by-2 table

Actor track list data, returned as a K -by-2 table. K is the number of actor track list samples. The table contains two columns specifying timestamps `TimeStamp` and actor information `ActorInfo`. Each row in the table represents track information relative to its recording time.

Each element of the first column of the table contains the timestamp at which the corresponding track information was captured, returned as a positive scalar. Units are in seconds.

Each element of the second column of the table contains the track information of non-ego actors, returned as an M -by-1 structure array. M is the number of actors with track information recorded at the corresponding timestamp. Each structure has these fields:

Field	Description
TrackID	Track ID of the actor, returned as a numeric scalar, a string scalar, or a character vector.
ClassID	Classification identifier of the actor, returned as one of these nonnegative integers: <ul style="list-style-type: none"> • 1 – Car • 2 – Truck • 3 – Bicycle • 4 – Pedestrian • 0 – Others

Field	Description
Position	Position of the actor with respect to the ego frame, returned as a three-element numeric row vector of the form [x y z]. Units are in meters.
Dimension	Dimensions of the actor, returned as a three-element numeric row vector of the form [<i>length width height</i>]. Units are in meters.
Yaw	Yaw angle of the actor with respect to the ego frame, returned as a numeric scalar. Units are in degrees.
Pitch	Pitch angle of the actor with respect to the ego frame, returned as a numeric scalar. Units are in degrees.
Roll	Roll angle of the actor with respect to the ego frame, returned as a numeric scalar. Units are in degrees.
Speed	Speed of the actor with respect to the ego frame, returned as a numeric scalar. Units are in meters per second.
Velocity	Velocity of the actor with respect to the ego frame, returned as a three-element numeric row vector of the form [vx vy vz]. Units are in meters per second.

Data Types: table

Version History

Introduced in R2013a

See Also

actorTracklist | actorprops | laneData

removeData

Remove data from actor track list object

Syntax

```
removeData(trackdata, Timestamp=timestamps)
removeData(trackdata, RowIndices=rowIndices)
removeData(trackdata, TrackIDs=trackIDs)
```

Description

`removeData(trackdata, Timestamp=timestamps)` removes actor information for the specified timestamps `timestamps` from the `actorTracklist` object `trackdata`.

`removeData(trackdata, RowIndices=rowIndices)` removes actor information for the specified row indices `rowIndices` from the `actorTracklist` object `trackdata`.

`removeData(trackdata, TrackIDs=trackIDs)` removes actor information for the specified track IDs `trackIDs` from the `actorTracklist` object.

Note This function requires the Scenario Builder for Automated Driving Toolbox support package. You can install Scenario Builder for Automated Driving Toolbox from the Add-On Explorer. For more information about installing add-ons, see [Get and Manage Add-Ons](#).

Examples

Remove Data from Actor Track List Object Using Row Indices

Load an initialized `actorTracklist` object into the workspace.

```
actorObject = load("actorTracklistObject.mat");
actorObject = actorObject.actorObject;
```

Display the details of the `actorTracklist` object.

```
disp(actorObject)

actorTracklist with properties:

    TimeStamp: [600x1 double]
      TrackIDs: {600x1 cell}
      ClassIDs: {600x1 cell}
      Position: {600x1 cell}
  Dimension: []
 Orientation: []
   Velocity: []
      Speed: []
 StartTime: 3.8300e-04
  EndTime: 29.9514
```

```

    NumSamples: 600
    UniqueTrackIDs: [18x1 string]

```

Specify the row indices for which to remove data from the actorTracklist object.

```
idxs = (1:5)';
```

Remove the first five rows of data from the actorTracklist object.

```
removeData(actorObject,RowIndices=idxs)
```

Display the details of the actorTracklist object after data removal.

```
disp(actorObject)
```

```

actorTracklist with properties:

    TimeStamp: [595x1 double]
    TrackIDs: {595x1 cell}
    ClassIDs: {595x1 cell}
    Position: {595x1 cell}
    Dimension: []
    Orientation: []
    Velocity: []
    Speed: []
    StartTime: 0.2506
    EndTime: 29.9514
    NumSamples: 595
    UniqueTrackIDs: [18x1 string]

```

Remove Data from Actor Track List Object Using Timestamp

Load an initialized actorTracklist object into the workspace.

```
actorObject = load("actorTracklistObject.mat");
actorObject = actorObject.actorObject;
```

Display the details of the actorTracklist object.

```
disp(actorObject)
```

```

actorTracklist with properties:

    TimeStamp: [600x1 double]
    TrackIDs: {600x1 cell}
    ClassIDs: {600x1 cell}
    Position: {600x1 cell}
    Dimension: []
    Orientation: []
    Velocity: []
    Speed: []
    StartTime: 3.8300e-04
    EndTime: 29.9514
    NumSamples: 600
    UniqueTrackIDs: [18x1 string]

```

Extract the timestamps for which to remove data from the actorTracklist object.

```
ts = actorObject.TimeStamp(1:10);
```

Remove the data from the actorTracklist object for the specified timestamps.

```
removeData(actorObject,TimeStamp=ts)
```

Display the details of the actorTracklist object after data removal.

```
disp(actorObject)
```

```
actorTracklist with properties:
    TimeStamp: [590x1 double]
    TrackIDs: {590x1 cell}
    ClassIDs: {590x1 cell}
    Position: {590x1 cell}
    Dimension: []
    Orientation: []
    Velocity: []
    Speed: []
    StartTime: 0.4998
    EndTime: 29.9514
    NumSamples: 590
    UniqueTrackIDs: [18x1 string]
```

Remove Data from Actor Track List Object Using Track IDs

Load an initialized actorTracklist object into the workspace.

```
actorObject = load("actorTracklistObject.mat");
actorObject = actorObject.actorObject;
```

Display the recorded track IDs for the first timestamp.

```
disp(actorObject.TrackIDs{1})
```

```
"4"    "13"    "22"
```

Specify a track ID for which to remove data from the actorTracklist object.

```
tid = "4";
```

Remove the data for the specified track ID from the actorTracklist object.

```
removeData(actorObject,TrackIDs=tid)
```

Display the recorded track IDs for the first timestamp after data removal.

```
disp(actorObject.TrackIDs{1})
```

```
"13"    "22"
```

Input Arguments

trackdata — Actor track list information

actorTracklist object

Actor track list information, specified as an actorTracklist object.

timestamps — Timestamps for which to remove track information

scalar | N -element column vector

Timestamps for which to remove track information, specified as a scalar or an N -element column vector. N is the number of recorded timestamps for which to remove data. Units are in seconds.

After timestamp removal, the trackdata object automatically arranges the remaining timestamps in increasing order.

Data Types: single | double

rowIndices — Row indices of actor track list data to remove

positive integer | N -element column vector of positive integers

Row indices of actor track list data to remove, specified as a positive integer or an N -element column vector of positive integers. N is the number of row indices of the trackdata input for which to remove data. Values must be in the range [1, NumSamples], where NumSamples is the value of the NumSamples property of the input actorTracklist object trackdata.

Data Types: single | double | uint8 | uint16 | uint32 | uint64

trackIDs — Track IDs of actors for which to remove data

scalar | N -by-1 string array

Track IDs of the actors for which to remove data, specified as a scalar or an N -by-1 string array. N is the number of track IDs for which to remove data from the input trackdata.

When you specify a track ID for removal, the function removes the ID from the UniqueTrackIDs property, as well as all data associated with the track ID in the ClassID, Position, Dimension, Orientation, Velocity, and Speed properties. This can result in empty elements in any property with its size determined by the number of timestamps in the data.

Version History

Introduced in R2023a

See Also

actorTracklist | actorprops | laneData

updateTime

Update timestamps of actor track list object

Syntax

```
updateTime(trackdata,timestamps)  
updateTime(trackdata,fhandle)
```

Description

`updateTime(trackdata,timestamps)` updates the timestamps of the `actorTracklist` object with the specified timestamps `timestamps`.

`updateTime(trackdata,fhandle)` updates the timestamps of the `actorTracklist` object with the specified function `fhandle`.

Note This function requires the Scenario Builder for Automated Driving Toolbox support package. You can install Scenario Builder for Automated Driving Toolbox from the Add-On Explorer. For more information about installing add-ons, see [Get and Manage Add-Ons](#).

Examples

Update Timestamps of Actor Track List Object Using Linear Offset

Load an initialized `actorTracklist` object into the workspace.

```
actorObject = load("actorTracklistObject.mat");  
actorObject = actorObject.actorObject;
```

Display the first few timestamps of the `actorTracklist` object.

```
head(actorObject.TimeStamp)
```

```
0.0004  
0.0507  
0.1006  
0.1504  
0.2003  
0.2506  
0.3003  
0.3502
```

Extract all recorded timestamps from the `actorTracklist` object.

```
t = actorObject.TimeStamp;
```

Offset each timestamp by 10 seconds.

```
t = t + 10;
```

Update the timestamps of the actorTracklist object.

```
updateTime(actorObject,t);
```

Display the first few updated timestamps of the actorTracklist object.

```
head(actorObject.TimeStamp)
```

```
10.0004  
10.0507  
10.1006  
10.1504  
10.2003  
10.2506  
10.3003  
10.3502
```

Update Timestamps of Actor Track List Object Using Function

Load an initialized actorTracklist object into the workspace.

```
actorObject = load("actorTracklistObject.mat");  
actorObject = actorObject.actorObject;
```

Display the first few timestamps of the actorTracklist object.

```
head(actorObject.TimeStamp)
```

```
0.0004  
0.0507  
0.1006  
0.1504  
0.2003  
0.2506  
0.3003  
0.3502
```

Update the timestamps of the actorTracklist object with a linear offset of 10 seconds by specifying a function handle.

```
updateTime(actorObject,@(t)t+10);
```

Display the first few updated timestamps of the actorTracklist object.

```
head(actorObject.TimeStamp)
```

```
10.0004  
10.0507  
10.1006  
10.1504  
10.2003  
10.2506  
10.3003  
10.3502
```

Input Arguments

trackdata — Actor track list information

actorTracklist object

Actor track list information, specified as an actorTracklist object.

timesteps — Timestamps with which to update actor information

N-element nonnegative column vector

Timestamps with which to update actor information, specified as an *N*-element nonnegative column vector. *N* must be the same as the value of the NumSamples property of the input actorTracklist object trackdata. The input timesteps must be in increasing order. Units are in seconds.

Data Types: single | double

fhandle — Timestamp update function

function handle

Timestamp update function, specified as a function handle. The updateTime function applies fhandle to every element of the TimeStamp property of the actorTracklist object. fhandle must have this function syntax:

```
timeout = newTime(timein),
```

where timein is the timestamps from the TimeStamp property, specified as an *N*-by-1 nonnegative column vector, and timeout is the updated timestamps.

Version History

Introduced in R2023a

See Also

actorTracklist | actorprops | laneData

laneData

Store recorded lane boundary data with timestamps

Description

The laneData object stores recorded lane boundary data and associates it with the timestamps at which it was recorded.

Creation

Syntax

```
lanedata = laneData
lanedata = laneData(timestamp,lbdata)
lanedata = laneData( ____,Name=Value)
```

Description

lanedata = laneData creates an empty laneData object lanedata.

lanedata = laneData(timestamp,lbdata) creates a laneData object initialized with the recorded lane boundaries lbdata at the associated timestamps timestamp. The timestamp argument sets the TimeStamp property, and the lbdata argument sets the LaneBoundaryData, StartTime, EndTime, and NumSamples properties of the returned laneData object lanedata.

lanedata = laneData(____,Name=Value) sets properties on page 4-1815 using one or more name-value arguments.

Note This object requires the Scenario Builder for Automated Driving Toolbox support package. You can install Scenario Builder for Automated Driving Toolbox from the Add-On Explorer. For more information about installing add-ons, see [Get and Manage Add-Ons](#).

Input Arguments

lbdata — Lane boundary data

[] (default) | N -by- M matrix | N -by-1 cell array | {[]}

Lane boundary data, specified as an N -by- M matrix or N -by-1 cell array. N is the number of timestamps. Empty elements represent missing lane boundary detections.

If you have an equal number of recorded lane boundaries across all timestamps, specify lbdata as an N -by- M array of parabolicLaneBoundary objects, cubicLaneBoundary objects, or clothoidLaneBoundary objects. M is the uniform number of detected lane boundaries for each sample.

If you have an unequal number of recorded lane boundaries across timestamps, specify lbdata as an N -by-1 cell array. Each cell must contain an M -element row vector of parabolicLaneBoundary

objects, `cubicLaneBoundary` objects, or `clothoidLaneBoundary` objects. M is the number of detected lane boundaries at the corresponding timestamp.

The movements of the ego vehicle and non-ego actors must follow the vehicle coordinate system used by Automated Driving Toolbox. For more information on the vehicle coordinate system, see “Vehicle Coordinate System”.

Note You must specify all lane boundaries using the same type of object.

Properties

TimeStamp — Timestamps of lane boundary information

[] (default) | N -element numeric column vector

This property is read-only.

Timestamps of lane boundary information, specified as an N -element numeric column vector. N is the number of timestamps. Each element indicates the time from the start of the simulation, in seconds, at which the associated track was captured.

When you initialize the object with timestamp data, the object arranges the input timestamps in increasing order. If the input data contains multiple rows of data with the same timestamp, the object merges that data into a single row.

Data Types: `double`

LaneBoundaryData — Lane boundary data

[] (default) | N -by-1 cell array

This property is read-only.

Lane boundary data, specified as an N -by-1 cell array. N is the number of timestamps. Each cell contains the lane boundary information recorded at the corresponding timestamp, specified as an M -element row vector of `parabolicLaneBoundary` objects, `cubicLaneBoundary` objects, or `clothoidLaneBoundary` objects. M is the number of detected lane boundaries at the timestamp.

The `laneData` object arranges lane boundaries for a timestamp in left-to-right order with respect to the travel direction of the ego vehicle.

LaneInformation — Lane information

[] (default) | N -by- M structure array

This property is read-only.

Lane information, specified as an N -by- M structure array. N is the number of timestamps. M is the greatest number of lane boundaries detected at any specified timestamp

StartTime — Start time of lane boundary detection

[] (default) | scalar

This property is read-only.

Start time of lane boundary detection, specified as a scalar. Units are in seconds.

Data Types: `single` | `double`

EndTime — End time of lane boundary detection

`[]` (default) | scalar

This property is read-only.

End time of lane boundary detection, specified as a scalar. Units are in seconds.

Data Types: `single` | `double`

NumSamples — Number of recorded lane boundary samples

`0` (default) | positive integer

This property is read-only.

Number of recorded lane boundary samples, specified as a positive integer.

Data Types: `double`

Object Functions

<code>readData</code>	Read lane boundary data from laneData object
<code>addData</code>	Add lane information to lane data object
<code>removeData</code>	Remove data from lane data object
<code>findNearest</code>	Find lane information nearest to specified timestamp in lane data object
<code>updateTime</code>	Update timestamps of lane data object

Examples

Create Lane Data Object

Load recorded lane boundary data into the workspace.

```
data = load("laneBoundaryData.mat");
```

Extract the recorded timestamps and the lane boundary information from the data.

```
t = data.timestamps; % Extract timestamps
lbdata = data.lbdata; % Extract lane boundary information
```

Initialize a laneData object by using the extracted data.

```
ld = laneData(t, lbdata);
```

Display the details of the laneData object.

```
disp(ld)
```

```
laneData with properties:
```

```
    TimeStamp: [1158x1 double]
 LaneBoundaryData: {1158x1 cell}
 LaneInformation: []
    StartTime: 0
    EndTime: 57.8515
    NumSamples: 1158
```

Create Lane Data Object with Additional Lane Information

Load recorded lane boundary data into the workspace.

```
data = load("laneBoundaryData.mat");
```

Extract the recorded timestamps, lane boundaries and lane boundary color information from the data.

```
t = data.timestamps; % Extract timestamps  
lbdata = data.lbdata; % Extract lane boundaries  
lbinfo = data.lbinfo; % Extract lane boundary color information
```

Initialize a laneData object by using the extracted data, including the additional lane information.

```
ld = laneData(t,lbdata,LaneInformation=lbinfo);
```

Display the details of the laneData object.

```
disp(ld)
```

```
laneData with properties:
```

```
    TimeStamp: [1158x1 double]  
 LaneBoundaryData: {1158x1 cell}  
 LaneInformation: [1158x2 struct]  
    StartTime: 0  
    EndTime: 57.8515  
    NumSamples: 1158
```

Version History

Introduced in R2023a

See Also

[actorTracklist](#) | [updateLaneSpec](#)

addData

Add lane information to lane data object

Syntax

```
addData(lanedata, timestamps, lbdata)
```

Description

`addData(lanedata, timestamps, lbdata)` adds the specified lane information `lbdata` to the `laneData` object `lanedata`.

Examples

Create Empty Lane Data Object and Add Lane Information

Create an empty `laneData` object.

```
ld = laneData
ld =
  laneData with properties:
      TimeStamp: []
  LaneBoundaryData: []
  LaneInformation: []
      StartTime: []
      EndTime: []
  NumSamples: 0
```

Load recorded lane boundary data into the workspace.

```
data = load("laneBoundaryData.mat");
```

Extract the recorded timestamps and the lane boundary information from the data.

```
t = data.timestamps;    % Extract timestamps
lbdata = data.lbdata;  % Extract lane boundary information
```

Add the first five rows of lane information to the `laneData` object.

```
addData(ld, t(1:5), lbdata(1:5, :))
```

Display the details of the `laneData` object.

```
disp(ld)
  laneData with properties:
      TimeStamp: [5x1 double]
  LaneBoundaryData: {5x1 cell}
```

```
LaneInformation: []
  StartTime: 0
  EndTime: 0.2000
  NumSamples: 5
```

Input Arguments

lanedata — Recorded lane data

laneData object

Recorded lane data, specified as a laneData object.

timestamps — Timestamps of lane information to add

N-element numeric column vector

Timestamps of lane information to add, specified as an *N*-element numeric column vector. *N* is the number of timestamps. Units are in seconds.

When you add lane data, the laneData object automatically arranges timestamps in increasing order. If the input data contains multiple rows of data with the same timestamp, the object merges that data into a single row.

Data Types: double

lbdata — Lane boundary data to add

N-by-*M* matrix | *N*-by-1 cell array

Lane boundary data to add, specified as an *N*-by-*M* matrix or *N*-by-1 cell array. *N* is the number of timestamps.

If you have an equal number of recorded lane boundaries across all timestamps, specify lbdata as an *N*-by-*M* array of parabolicLaneBoundary objects, cubicLaneBoundary objects, or clothoidLaneBoundary objects. *M* is the uniform number of detected lane boundaries for each sample.

If you have an unequal number of recorded lane boundaries across timestamps, specify lbdata as an *N*-by-1 cell array. Each cell entry must contain an *M*-element row vector of parabolicLaneBoundary objects, cubicLaneBoundary objects, or clothoidLaneBoundary objects. *M* is the number of detected lane boundaries at the timestamp.

The movements of the ego vehicle and non-ego actors must follow the vehicle coordinate system used by Automated Driving Toolbox. For more information on the vehicle coordinate system, see “Vehicle Coordinate System”.

Note You must specify all lane boundaries using the same type of object.

Version History

Introduced in R2023a

See Also

actorTracklist | updateLaneSpec

findNearest

Find lane information nearest to specified timestamp in lane data object

Syntax

```
data = findNearest(lanedata,timestamp)
data = findNearest(lanedata,timestamp,"lessThanEqual")
data = findNearest(lanedata,timestamp,"greaterThanEqual")
```

Description

`data = findNearest(lanedata,timestamp)` finds the lane information nearest to the specified timestamp `timestamp` in the `laneData` object `lanedata`.

`data = findNearest(lanedata,timestamp,"lessThanEqual")` finds the lane information nearest to and less than the specified timestamp `timestamp`.

`data = findNearest(lanedata,timestamp,"greaterThanEqual")` finds the lane information nearest and greater than the specified timestamp `timestamp`.

Note This function requires the Scenario Builder for Automated Driving Toolbox support package. You can install Scenario Builder for Automated Driving Toolbox from the Add-On Explorer. For more information about installing add-ons, see [Get and Manage Add-Ons](#).

Examples

Find Data Nearest to Timestamp in Lane Data Object

Load an initialized `laneData` object into the workspace.

```
data = load("laneDataObject.mat");
ld = data.ld;
```

Specify a timestamp for which to find data in the `laneData` object.

```
t = 10;
```

Find the data nearest to the specified timestamp in the `laneData` object.

```
nd = findNearest(ld,t);
```

Display the data.

```
disp(nd)
```

TimeStamp	LaneBoundary1	LaneBoundary2	LaneBoundary1_Inf
9.9998	{1x1 parabolicLaneBoundary}	{1x1 parabolicLaneBoundary}	{1x1 struct}

Input Arguments

lanedata — Recorded lane data

laneData object

Recorded lane data, specified as a laneData object.

timestamp — Timestamp near which to read lane information

numeric scalar

This property is read-only.

Timestamp near which to read lane information, specified as a numeric scalar. Units are in seconds.

Data Types: double

Output Arguments

data — Lane detection data

1-by-*P* table

Lane detection data, returned as an 1-by-*P* table. (*P*-1) is the greatest number of detected lane boundaries across all samples. This table shows an example of the data organization.

TimeStamp	LaneBoundary1	LaneBoundary2	LaneBoundary3
0	1x1 parabolicLaneBoundary	1x1 parabolicLaneBou ndary	1x1 parabolicLaneBou ndary

- The first column of the table is the recorded timestamp, in seconds, for each detection in the corresponding row. All other columns contain data for the detected lane boundaries as parabolicLaneBoundary objects, cubicLaneBoundary objects, or clothoidLaneBoundary objects. All lane boundaries in a table are of the same object type.
- Empty cells represent missing lane boundary detections.
- The table has at least three columns, and none of the first three columns can contain empty cells.
- The detected lane boundaries are in left-to-right order with respect to the travel direction of the ego vehicle.

Data Types: table

Version History

Introduced in R2023a

See Also

actorTracklist | updateLaneSpec

readData

Read lane boundary data from laneData object

Syntax

```
data = readData(lanedata,"all")  
data = readData(lanedata,Name=Value)
```

Description

`data = readData(lanedata,"all")` reads all data from the laneData object `lanedata`, and returns a table, `data`.

`data = readData(lanedata,Name=Value)` specifies additional options using name-value arguments. For example, `RowIndices=[1:10]'` reads the lane data from the first 10 timestamps in the input laneData object `lanedata`.

Note This function requires the Scenario Builder for Automated Driving Toolbox support package. You can install Scenario Builder for Automated Driving Toolbox from the Add-On Explorer. For more information about installing add-ons, see [Get and Manage Add-Ons](#).

Examples

Read Data From Lane Data Object Using Row Indices

Load recorded lane boundary data into the workspace.

```
data = load("laneBoundaryData.mat");
```

Extract the recorded timestamps and the lane boundaries from the data.

```
t = data.timestamps;    % Extract timestamps  
lbdata = data.lbdata;  % Extract lane boundaries
```

Initialize a laneData object by using the extracted data.

```
ld = laneData(t,lbdata);
```

Specify row indices for which to read data from the laneData object.

```
idxs = (1:10)';
```

Read data for the specified row indices.

```
tab = readData(ld,RowIndices=idxs);
```

Display the table containing the first 10 rows of lane information.

```
disp(tab)
```

TimeStamp	LaneBoundary1	LaneBoundary2
0	{1x1 parabolicLaneBoundary}	{1x1 parabolicLaneBoundary}
0.049887	{1x1 parabolicLaneBoundary}	{1x1 parabolicLaneBoundary}
0.099382	{1x1 parabolicLaneBoundary}	{1x1 parabolicLaneBoundary}
0.15034	{1x1 parabolicLaneBoundary}	{1x1 parabolicLaneBoundary}
0.19999	{1x1 parabolicLaneBoundary}	{1x1 parabolicLaneBoundary}
0.24967	{1x1 parabolicLaneBoundary}	{1x1 parabolicLaneBoundary}
0.30038	{1x1 parabolicLaneBoundary}	{1x1 parabolicLaneBoundary}
0.35012	{1x1 parabolicLaneBoundary}	{1x1 parabolicLaneBoundary}
0.40052	{1x1 parabolicLaneBoundary}	{1x1 parabolicLaneBoundary}
0.44945	{1x1 parabolicLaneBoundary}	{1x1 parabolicLaneBoundary}

Input Arguments

lanedata — Recorded lane data

laneData object

Recorded lane data, specified as a laneData object.

Name-Value Pair Arguments

Specify optional pairs of arguments as Name1=Value1, . . . , NameN=ValueN, where Name is the argument name and Value is the corresponding value. Name-value arguments must appear after other arguments, but the order of the pairs does not matter.

Example: `readData(lanedata, RowIndices=[1:10]')` reads the first 10 rows of lane data from the input laneData object lanedata.

RowIndices — Row indices for which to read lane information

N-element column vector

Row indices for which to read lane information, specified as an *N*-element column vector of positive integers. *N* is the number of rows of the lanedata input from which to read. Values must be in the range [1, NumSamples], where NumSamples is the value of the NumSamples property of the input laneData object lanedata.

Data Types: single | double | uint8 | uint16 | uint32 | uint64

Timestamps — Timestamps for which to read lane information

N-element column vector

Timestamps for which to read lane information, specified as an *N*-element column vector. *N* is the number of timestamps for which to read data from the input lanedata. Units are in seconds.

Data Types: single | double

Output Arguments

data — Lane detection data

M-by-*P* table

Lane detection data, returned as an M -by- P table. M is the number of lane-detection samples, and $(P-1)$ is the greatest number of detected lane boundaries across all samples. This table shows an example of the data organization.

TimeStamp	LaneBoundary1	LaneBoundary2	LaneBoundary3
0	1x1 parabolicLaneBoundary	1x1 parabolicLaneBoundary	1x1 parabolicLaneBoundary
0.05	1x1 parabolicLaneBoundary	1x1 parabolicLaneBoundary	[]
0.1	1x1 parabolicLaneBoundary	1x1 parabolicLaneBoundary	1x1 parabolicLaneBoundary

- The first column of the table is the recorded timestamp, in seconds, for each detection in the corresponding row. All other columns contain data for the detected lane boundaries as `parabolicLaneBoundary` objects, `cubicLaneBoundary` objects, or `clothoidLaneBoundary` objects. All lane boundaries in a table are of the same object type.
- Empty cells represent missing lane boundary detections.
- The table has at least three columns, and none of the first three columns can contain empty cells.
- The detected lane boundaries are in left-to-right order with respect to the travel direction of the ego vehicle.

Data Types: `table`

Version History

Introduced in R2023a

See Also

`actorTracklist` | `updateLaneSpec`

removeData

Remove data from lane data object

Syntax

```
removeData(lanedata, Timestamp=timestamps)  
removeData(lanedata, RowIndices=rowIndices)
```

Description

`removeData(lanedata, Timestamp=timestamps)` removes lane information for the specified timestamps `timestamps` from the `laneData` object `lanedata`.

`removeData(lanedata, RowIndices=rowIndices)` removes lane information for the specified row indices `rowIndices` from the `laneData` object `lanedata`.

Note This function requires the Scenario Builder for Automated Driving Toolbox support package. You can install Scenario Builder for Automated Driving Toolbox from the Add-On Explorer. For more information about installing add-ons, see [Get and Manage Add-Ons](#).

Examples

Remove Data from Lane Data Object Using Row Indices

Load an initialized `LaneData` object into the workspace.

```
data = load("laneDataObject.mat");  
ld = data.ld;
```

Display the details of the `laneData` object.

```
disp(ld)  
  
laneData with properties:  
  
    TimeStamp: [1158x1 double]  
LaneBoundaryData: {1158x1 cell}  
LaneInformation: [1158x2 struct]  
    StartTime: 0  
    EndTime: 57.8515  
    NumSamples: 1158
```

Specify the row indices for which to remove data from the `laneData` object.

```
idxs = (1:5)';
```

Remove the first five rows of data from the `laneData` object.

```
removeData(ld, RowIndices=idxs)
```

Display the details of this `laneData` object after data removal.

```
disp(ld)
```

```
laneData with properties:
    TimeStamp: [1153x1 double]
LaneBoundaryData: {1153x1 cell}
LaneInformation: [1153x2 struct]
    StartTime: 0.2497
    EndTime: 57.8515
    NumSamples: 1153
```

Remove Data from Lane Data Object Using Timestamp

Load an initialized `laneData` object into the workspace.

```
data = load("laneDataObject.mat");
ld = data.ld;
```

Display the details of the `laneData` object.

```
disp(ld)
```

```
laneData with properties:
    TimeStamp: [1158x1 double]
LaneBoundaryData: {1158x1 cell}
LaneInformation: [1158x2 struct]
    StartTime: 0
    EndTime: 57.8515
    NumSamples: 1158
```

Extract the timestamps for which to remove data from the `laneData` object.

```
t = ld.TimeStamp(1:10);
```

Remove the data from the `laneData` object for the specified timestamps.

```
removeData(ld, Timestamps=t)
```

Display the details of the `laneData` object after data removal.

```
disp(ld)
```

```
laneData with properties:
    TimeStamp: [1148x1 double]
LaneBoundaryData: {1148x1 cell}
LaneInformation: [1148x2 struct]
    StartTime: 0.4995
    EndTime: 57.8515
    NumSamples: 1148
```

Input Arguments

lanedata — Recorded lane data

laneData object

Recorded lane data, specified as a laneData object.

timestamps — Timestamps for which to remove lane information

scalar | N -element column vector

Timestamps for which to remove lane information, specified as a scalar or an N -element column vector. N is the number of timestamps. Units are in seconds.

After timestamp removal, the lanedata object automatically arranges the remaining timestamps in increasing order.

Data Types: double

rowIndices — Row indices of lane data to remove

N -element column vector of positive integers

Row indices of lane data to remove, specified as a positive integer or an N -element column vector of positive integers. N is the number of rows of the lanedata input from which to remove data. Values must be in the range $[1, \text{NumSamples}]$, where NumSamples is the value of the NumSamples property of the input laneData object lanedata.

Data Types: single | double | uint8 | uint16 | uint32 | uint64

Version History

Introduced in R2023a

See Also

actorTracklist | updateLaneSpec

updateTime

Update timestamps of lane data object

Syntax

```
updateTime(lanedata, timestamps)
updateTime(lanedata, fhandle)
```

Description

`updateTime(lanedata, timestamps)` updates the timestamps of the `laneData` object with the specified timestamps `timestamps`.

`updateTime(lanedata, fhandle)` updates the timestamps of the `laneData` object with the specified function `fhandle`.

Note This function requires the Scenario Builder for Automated Driving Toolbox support package. You can install Scenario Builder for Automated Driving Toolbox from the Add-On Explorer. For more information about installing add-ons, see [Get and Manage Add-Ons](#).

Examples

Update Timestamps of Lane Data Object Using Linear Offset

Load an initialized `laneData` object into the workspace.

```
data = load("laneDataObject.mat");
ld = data.ld;
```

Display the first few timestamps of the `laneData` object.

```
head(ld.TimeStamp)
```

```

    0
0.0499
0.0994
0.1503
0.2000
0.2497
0.3004
0.3501
```

Extract the recorded timestamps from the `laneData` object.

```
t = ld.TimeStamp;
```

Offset each timestamp by 10 seconds.

```
t = t + 10;
```

Update the timestamps of the laneData object.

```
updateTime(ld,t);
```

Display the first few updated timestamps of the laneData object.

```
head(ld.TimeStamp)
```

```
10.0000  
10.0499  
10.0994  
10.1503  
10.2000  
10.2497  
10.3004  
10.3501
```

Update Timestamps of Lane Data Object Using Function

Load an initialized laneData object into the workspace.

```
data = load("laneDataObject.mat");  
ld = data.ld;
```

Display the first few timestamps of the laneData object.

```
head(ld.TimeStamp)
```

```
0  
0.0499  
0.0994  
0.1503  
0.2000  
0.2497  
0.3004  
0.3501
```

Update the timestamps of the laneData object with a linear offset of 10 seconds by specifying a function handle.

```
updateTime(ld,@(t)t+10);
```

Display the first few updated timestamps of the laneData object.

```
head(ld.TimeStamp)
```

```
10.0000  
10.0499  
10.0994  
10.1503  
10.2000  
10.2497  
10.3004  
10.3501
```

Input Arguments

lanedata — Recorded lane data

laneData object

Recorded lane data, specified as a laneData object.

timestamps — Timestamps with which to update lane information

N-element nonnegative column vector

Timestamps with which to update lane information, specified as an *N*-element nonnegative column vector. *N* must be the same as the value of the NumSamples property of the input laneData object lanedata. The input timestamps must be in increasing order. Units are in seconds.

Data Types: single | double

fhandle — Timestamp update function

function handle

Timestamp update function, specified as a function handle. The updateTime function applies fhandle to every element of the TimeStamp property of the laneData object. fhandle must have this function syntax:

```
timeout = newTime(timein),
```

where timein is the timestamps from the TimeStamp property, specified as an *N*-element nonnegative column vector, and timeout is the updated timestamps.

Version History

Introduced in R2023a

See Also

actorTracklist | updateLaneSpec

laneBoundaryTracker

Track lane boundaries

Description

The laneBoundaryTracker System object tracks lane boundary detections. It can track multiple lane boundary detections in the form of parabolicLaneBoundary, cubicLaneBoundary, and clothoidLaneBoundary objects.

A lane boundary tracker confirms a track when the laneBoundaryTracker System object has enough evidence to determine that the track is an actual lane and its status is set to *confirmed*. For more information, see Confirmation Threshold property.

You can initialize and configure the tracker with an external Sensor Fusion and Tracking Toolbox tracker. Additionally, you can customize the preprocessing and postprocessing functions by using the PreProcessingFcn and PostProcessingFcn properties, respectively.

To use laneBoundaryTracker:

- 1 Create the laneBoundaryTracker object and set its properties.
- 2 Call the object with arguments, as if it were a function.

To learn more about how System objects work, see What Are System Objects?

Note This object requires the Scenario Builder for Automated Driving Toolbox support package and Sensor Fusion and Tracking Toolbox. You can install Scenario Builder for Automated Driving Toolbox from the Add-On Explorer. For more information about installing add-ons, see Get and Manage Add-Ons.

Creation

Syntax

```
tracker = laneBoundaryTracker
tracker = laneBoundaryTracker(customTracker)
tracker = laneBoundaryTracker(Name=Value)
```

Description

`tracker = laneBoundaryTracker` creates a laneBoundaryTracker System object, `tracker`, with default property values.

`tracker = laneBoundaryTracker(customTracker)` creates a laneBoundaryTracker System object, `tracker`, initialized with an external Sensor Fusion and Tracking Toolbox tracker, `customTracker`.

`tracker = laneBoundaryTracker(Name=Value)` sets properties for the laneBoundaryTracker object using one or more name-value arguments. For example,

AssignmentThreshold=2 creates a laneBoundaryTracker object with an AssignmentThreshold value of 2.

Input Arguments

customTracker — External custom tracker

multiObjectTracker object | trackerGNN object | trackerJPDA object | trackerTOMHT object

External custom tracker, specified as a multiObjectTracker, trackerGNN, trackerJPDA, or trackerTOMHT object. The external tracker specified when you construct the laneBoundaryTracker object must be compatible with the input lane boundary detection objects detections.

For example,

```
customTracker = trackerGNN(...
    FilterInitializationFcn=@initLaneTrackingFilter, ...
    AssignmentThreshold=[8 50], ...
    ConfirmationThreshold=[6 8], ...
    DeletionThreshold=[8 10]);
tracker = laneBoundaryTracker(customTracker)
```

initializes the laneBoundaryTracker object with the external Sensor Fusion and Tracking Toolbox tracker trackerGNN.

Note If you specify an external tracker, the laneBoundaryTracker object does not use the AssignmentThreshold, ConfirmationThreshold, and DeletionThreshold properties.

Properties

Unless otherwise indicated, properties are *nontunable*, which means you cannot change their values after calling the object. Objects lock when you call them, and the release function unlocks them.

If a property is *tunable*, you can change its value at any time.

For more information on changing property values, see System Design in MATLAB Using System Objects.

LaneBoundaryModel — Lane boundary model

"Parabolic" (default) | "Cubic" | "Clothoid"

Lane boundary model, specified as "Parabolic", "Cubic", or "Clothoid".

- "Parabolic" — Use when specifying lane detections as parabolicLaneBoundary objects.
- "Cubic" — Use when specifying lane detections as cubicLaneBoundary objects.
- "Clothoid" — Use when specifying lane detections as clothoidLaneBoundary objects.

Example: "Parabolic"

Data Types: char | string

AssignmentThreshold — Detection assignment threshold

20 (default) | real positive scalar

Detection assignment threshold, specified as a real positive scalar. Specify this threshold value to assign lane boundary detections to a track.

Increase the threshold value if the object does not assign detections to tracks that it should be. Decrease this value if the object assigns detections to tracks they must not be assigned to (too far away).

Example: 20

Data Types: single | double

ConfirmationThreshold — Threshold for track confirmation

0.95 (default) | scalar in range [0, 1]

Threshold for track confirmation, specified as a scalar in the range [0, 1]. The laneBoundaryTracker System object confirms a track if its probability of existence is higher than the specified threshold value.

Decrease the threshold value if the object fails to confirm tracks. Increase this value if the object confirms detections that it should not as tracks.

Example: 0.95

Data Types: single | double

DeletionThreshold — Threshold for track deletion

0.05 (default) | scalar in range [0, 1]

Threshold for track deletion, specified as a scalar in the range [0, 1]. The laneBoundaryTracker System object deletes a track if its probability of existence is lower than the specified threshold value.

Example: 0.05

Data Types: single | double

DetectionProbability — Probability of lane detection

0.9 (default) | scalar in range [0, 1]

Probability of lane detection, specified as a scalar in the range [0, 1].

Example: 0.9

Data Types: single | double

FalseAlarmDensity — Spatial density of false positive lane boundary detections

1e-6 (default) | positive scalar

Spatial density of false positive lane boundary detections, specified as a positive scalar.

Increase this value if the tracker creates false tracks, and decrease this value if the tracker fails to confirm tracks.

Example: 1e-6

Data Types: single | double

InitialExistenceProbability — Initial probability of track existence

0.9 (default) | scalar in range [0, 1]

Initial probability of track existence, specified as a scalar in the range [0, 1].

Example: 0.9

Data Types: single | double

MeasurementNoise — Measurement noise covariance

0.01 (default) | scalar | 3-by-3 matrix | 4-by-4 matrix

Measurement noise covariance, specified as a scalar, 3-by-3 matrix, or 4-by-4 matrix.

- 3-by-3 matrix — Use when you model lane detections as `parabolicLaneBoundary` objects or `clothoidLaneBoundary` objects.
- 4-by-4 matrix — Use when you model lane detections as `cubicLaneBoundary` objects.

Example: 0.01

Data Types: single | double

ProcessNoise — Process noise covariance

1e-5 (default) | scalar | 6-by-6 matrix | 8-by-8 matrix

Process noise covariance, specified as a scalar or 6-by-6 matrix or 8-by-8 matrix .

- 3-by-3 matrix — Use when you model lane detections as `parabolicLaneBoundary` object or `clothoidLaneBoundary` object.
- 3-by-3 matrix — Use when you model lane detections as `cubicLaneBoundary` object.

Example: 1e-5

Data Types: single | double

PreProcessingFcn — Preprocessing function

@laneBoundaryTracker.preProcessParabolicLaneBoundaries (default) | function handle

Preprocessing function, specified as a function handle. The function preprocesses the lane boundary detections. By default, the object sets the preprocessing function based on the `LaneBoundaryModel` property.

The function must support this syntax:

```
[detectionsOut,time] = preProcessingFunction(detectionsIn,time,varargin)
```

where the input arguments specify:

- `detectionsIn` — Custom input detections to the tracker, specified as a cell array of `parabolicLaneBoundary`, `clothoidLaneBoundary`, or `cubicLaneBoundary` objects.
- `time` — Time to update, specified as a scalar or row vector. Units are in seconds.
- `varargin` — Optional inputs passed from the tracker, required for custom preprocessing.

and the output arguments return:

- `detectionsOut` — Preprocessed object detections, returned as a cell array of `objectDetection` objects.
- `time` — Time to update, returned as a scalar or row vector. Units are in seconds.

Example: @myPreProcessFn

PostProcessingFcn — Postprocessing function

@laneBoundaryTracker.postProcessParabolicLaneBoundaries (default) | function handle

Postprocessing function, specified as a function handle. The function postprocesses the lane boundary tracks. By default, the object sets the postprocessing function based on the `LaneBoundaryModel` property. The function must support this syntax:

```
trackedBoundaries = postProcessingFunction(confirmedTracks,varargin)
```

where the input arguments specify:

- `confirmedTracks` — Confirmed lane boundary tracks, specified as an array of `objectTrack` objects.
- `varargin` — Optional inputs passed from the tracker, required for custom postprocessing.

and the `trackedBoundaries` output argument returns the tracked lane boundaries in the format specified by the `LaneBoundaryModel` property.

Example: @myPostProcessFn

Usage**Syntax**

```
confirmedTracks = tracker(detections,time)
confirmedTracks = tracker(detections,time,ShowProgress=showProgress)
confirmedTracks = tracker( ___,varargin)
```

Description

`confirmedTracks = tracker(detections,time)` returns a list of confirmed lane boundary tracks that are updated from a list of detections at the update time. Confirmed tracks are corrected and predicted to the update time, `time`.

`confirmedTracks = tracker(detections,time,ShowProgress=showProgress)` specifies whether to show the progress bar.

`confirmedTracks = tracker(___,varargin)` specifies a variable-length argument list as input arguments to the custom preprocessing and postprocessing functions, in addition to any combination of input arguments from previous syntaxes.

Note You can run the tracker in batch mode. For more information on batch mode tracking, see the `detections`, `time` and `confirmedTracks` argument descriptions.

Input Arguments**detections — Lane boundary detections**

cell array of lane boundary objects

Lane boundary detections, specified as a cell array of lane boundary objects. Each lane detection must be a `parabolicLaneBoundary` object, `cubicLaneBoundary` object, or `clothoidLaneBoundary` object.

Note In batch mode, you must specify `detections` as a cell array of lane boundary detections for each time step.

time — Time to update

scalar | row vector

Time to update, specified as a scalar or row vector. Units are in seconds.

If specified as a scalar, the tracker updates all tracks to this time. `time` must increase in value with each update to the tracker.

If specified as a row vector of times, the tracker runs in batch mode.

showProgress — Show progress bar status

false or 0 (default) | true or 1

Show progress bar status, specified as a logical 1 (true) or 0 (false). Specify 1 to display a progress bar in batch mode. Otherwise, specify 0.

varargin — Variable-length input argument list

comma-separated list

Variable-length input argument list, specified as a comma-separated list. The object passes this input as input arguments to the custom preprocessing and postprocessing functions specified by the `PreProcessingFcn` and `PostProcessingFcn` properties, respectively.

For example, if you specify the function syntax as:

```
confirmedTracks = tracker(detections,time,arg1,arg2)
```

MATLAB calls the preprocessing function as:

```
[detectionsOut,time] = preProcessingFunction(detectionsIn,time,arg1,arg2)
```

and the postprocessing function as:

```
trackedBoundaries = postProcessingFunction(confirmedTracks,arg1,arg2)
```

.

Output Arguments**confirmedTracks — Confirmed lane boundary tracks**

cell array of structures

Confirmed lane boundary tracks, returned as a cell array of structures. Each cell contains an array of structures, and each structure contains these fields:

- `TrackID` — Lane boundary track ID, returned as a nonnegative integer.
- `UpdateTime` — Time at which the lane boundary track was updated by a tracker, returned as a nonnegative real scalar.
- `LaneBoundary` — Confirmed lane boundary tracks, returned as a `parabolicLaneBoundary`, `cubicLaneBoundary`, or `clothoidLaneBoundary` object.

Note In batch mode, `confirmedTracks` is returned as a cell array of structures for each specified time step.

Object Functions

To use an object function, specify the System object as the first input argument. For example, to release system resources of a System object named `obj`, use this syntax:

```
release(obj)
```

Common to All System Objects

<code>step</code>	Run System object algorithm
<code>release</code>	Release resources and allow changes to System object property values and input characteristics
<code>isLocked</code>	Determine if System object is in use
<code>clone</code>	Create duplicate System object
<code>reset</code>	Reset internal states of System object

Examples

Track Parabolic Lane Boundaries Using laneBoundaryTracker

Model lane boundary detections using `parabolicLaneBoundary` objects.

```
llane=parabolicLaneBoundary([-0.001 0.01 0.5]);
rlane=parabolicLaneBoundary([-0.001 0.01 -0.5]);
```

Specify the size of the time steps.

```
dt=0.1;
```

Initialize a `laneBoundaryTracker` for tracking `parabolicLaneBoundary` objects.

```
tracker=laneBoundaryTracker(LaneBoundaryModel="Parabolic");
```

Update the tracker with the lane detections.

```
for i=1:2
    laneTracks=tracker({llane,rlane},i*dt)
end
```

```
laneTracks =
```

```
    0x1 empty cell array
```

```
laneTracks=2x1 cell array
    {1x1 struct}
    {1x1 struct}
```

Visualize the tracked lane boundaries.

```
bep=birdsEyePlot(XLimits=[0 30],YLimits=[-5 5]);
lbPlotter=laneBoundaryPlotter(bep,DisplayName="Laneboundaries");
plotLaneBoundary(lbPlotter,[laneTracks{1}.LaneBoundary laneTracks{2}.LaneBoundary])
```

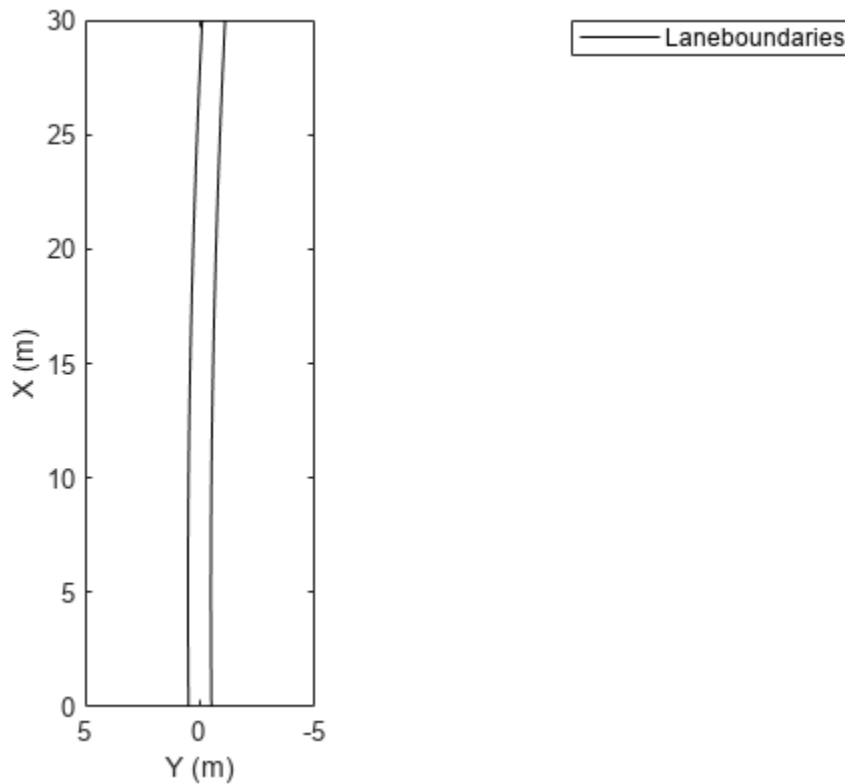

Track Lane Boundaries In Batch Mode Using laneBoundaryTracker

Specify the number of steps across which to track lane boundaries in batch mode.

```
n = 10;
```

Initialize a cell array and numeric array for storing lane detections and time for batch mode processing, respectively.

```
laneDets = cell(1,n);
time = zeros(1,n);
```

Define the sample time.

```
dt = 0.1;
```

Create a sequence of lane boundary detections using `parabolicLaneBoundary` objects. To use these detections with the `laneBoundaryTracker` object for batch processing, enclose the detections for each time step in a single cell of the cell array.

```
for i = 1:n
    a = -0.0015 - 0.0005*i;
```

```

    b = 0.01;
    c = 0.5;
    llane = parabolicLaneBoundary([a b c]);
    rlane = parabolicLaneBoundary([a b -c]);
    laneDets{i}= [llane, rlane];
    time(i) = dt *i;
end

```

Initialize a lane boundary tracker.

```
tracker = laneBoundaryTracker(AssignmentThreshold=2,MeasurementNoise=5e-3);
```

Track the lane boundaries in batch mode.

```
laneTracks = tracker(laneDets,time);
```

Create a bird's-eye plot and lane boundary plotter.

```

bep = birdsEyePlot(XLimits=[0 30],YLimits=[-5 5]);
lbDetPlotter = laneBoundaryPlotter(bep,DisplayName="Lane boundary detections");
lbTrackPlotter = laneBoundaryPlotter(bep,DisplayName="Lane boundary tracks",LineStyle="--",Color=

```

Plot the tracked lane boundaries.

```

for i = 1:n
    plotLaneBoundary(lbDetPlotter,laneDets{i})
    if ~isempty(laneTracks{i})
        for j = 1:numel(laneTracks{i})
            boundaries(j) = laneTracks{i}{j}.LaneBoundary;
        end
        plotLaneBoundary(lbTrackPlotter,boundaries)
    end
    drawnow
    pause(0.2)
end

```

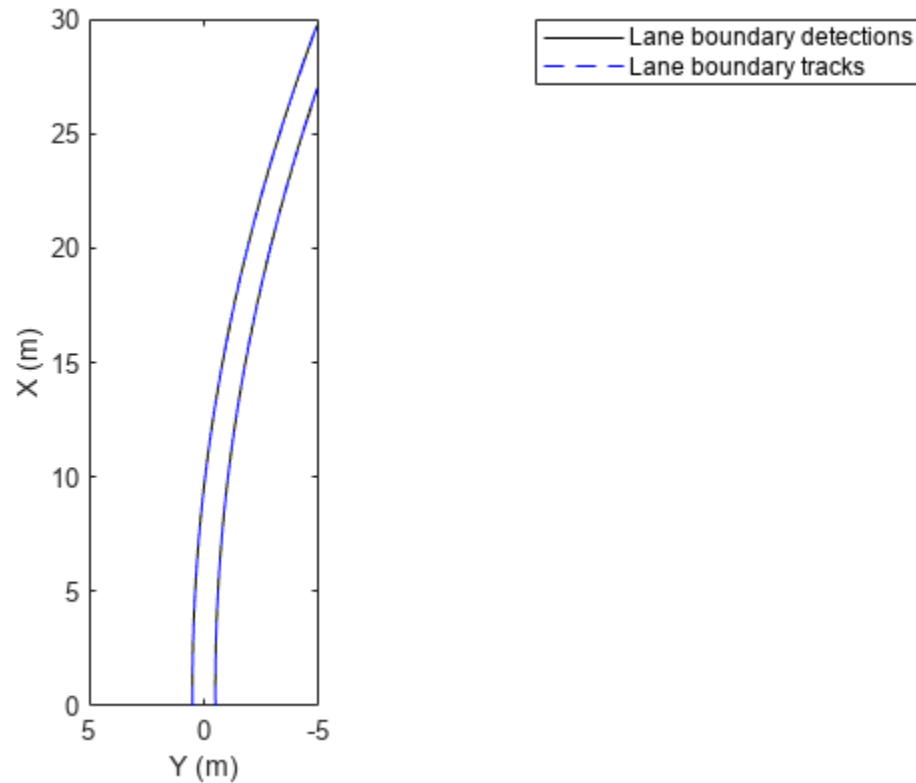

Algorithms

The `laneBoundaryTracker` System object uses a combination of the joint probabilistic data association tracker and extended Kalman filter. For more information on the joint probabilistic data association tracker, see the “Algorithms” (Sensor Fusion and Tracking Toolbox) section of the `trackerJPDA` System object. For more information on the extended Kalman filter, see the “Algorithms” (Sensor Fusion and Tracking Toolbox) section of the `trackingEKF` object.

Version History

Introduced in R2023a

See Also

`parabolicLaneBoundary` | `cubicLaneBoundary` | `clothoidLaneBoundary` | `multiObjectTracker` | `trackerGNN` | `trackerJPDA` | `trackerTOMHT`

Scene Dimensions

Curved Road

Curved road 3D environment

Description

The **Curved Road** scene is a 3D environment of a curved highway loop. The scene is rendered using RoadRunner.



Setup

To simulate a driving algorithm in this scene:

- 1 Add a Simulation 3D Scene Configuration block to your Simulink model.
- 2 In this block, set the **Scene source** parameter to Default Scenes.
- 3 Set the enabled **Scene name** parameter to Curved road.

Examples

Explore Curved Road Scene

Explore the 3D Curved Road scene and inspect its dimensions by using a corresponding 2D top-view image of the scene.

You can use this image to inspect the scene before simulation and choose starting coordinates for vehicles. For details on using these images to select waypoints for path-following applications, see the “Select Waypoints for Unreal Engine Simulation” example.

Load the 2D spatial referencing object that corresponds to the scene. This `imref2d` object describes the relationship between the pixels in the image and the world coordinates of the scene.

```
data = load('sim3d_SpatialReferences.mat');
spatialRef = data.spatialReference.CurvedRoad
```

```
spatialRef =
  imref2d with properties:
    XWorldLimits: [-1491 368]
    YWorldLimits: [-191 1668]
    ImageSize: [5020 5020]
    PixelExtentInWorldX: 0.3703
    PixelExtentInWorldY: 0.3703
    ImageExtentInWorldX: 1859
    ImageExtentInWorldY: 1859
    XIntrinsicLimits: [0.5000 5.0205e+03]
    YIntrinsicLimits: [0.5000 5.0205e+03]
```

Display the image corresponding to the scene. Use the spatial referencing object to display the axes in the world coordinates of the scene. Units are in meters.

By default, the `imshow` function displays *Y*-axis values that increase from top to bottom. To align with the Automated Driving Toolbox™ world coordinate system, set the *Y*-direction to 'normal' so that *Y*-axis values increase from bottom to top.

```
figure
fileName = 'sim3d_CurvedRoad.jpg';
I = imshow(fileName,spatialRef);
set(gca,'YDir','normal')
xlabel('X (m)')
ylabel('Y (m)')
```

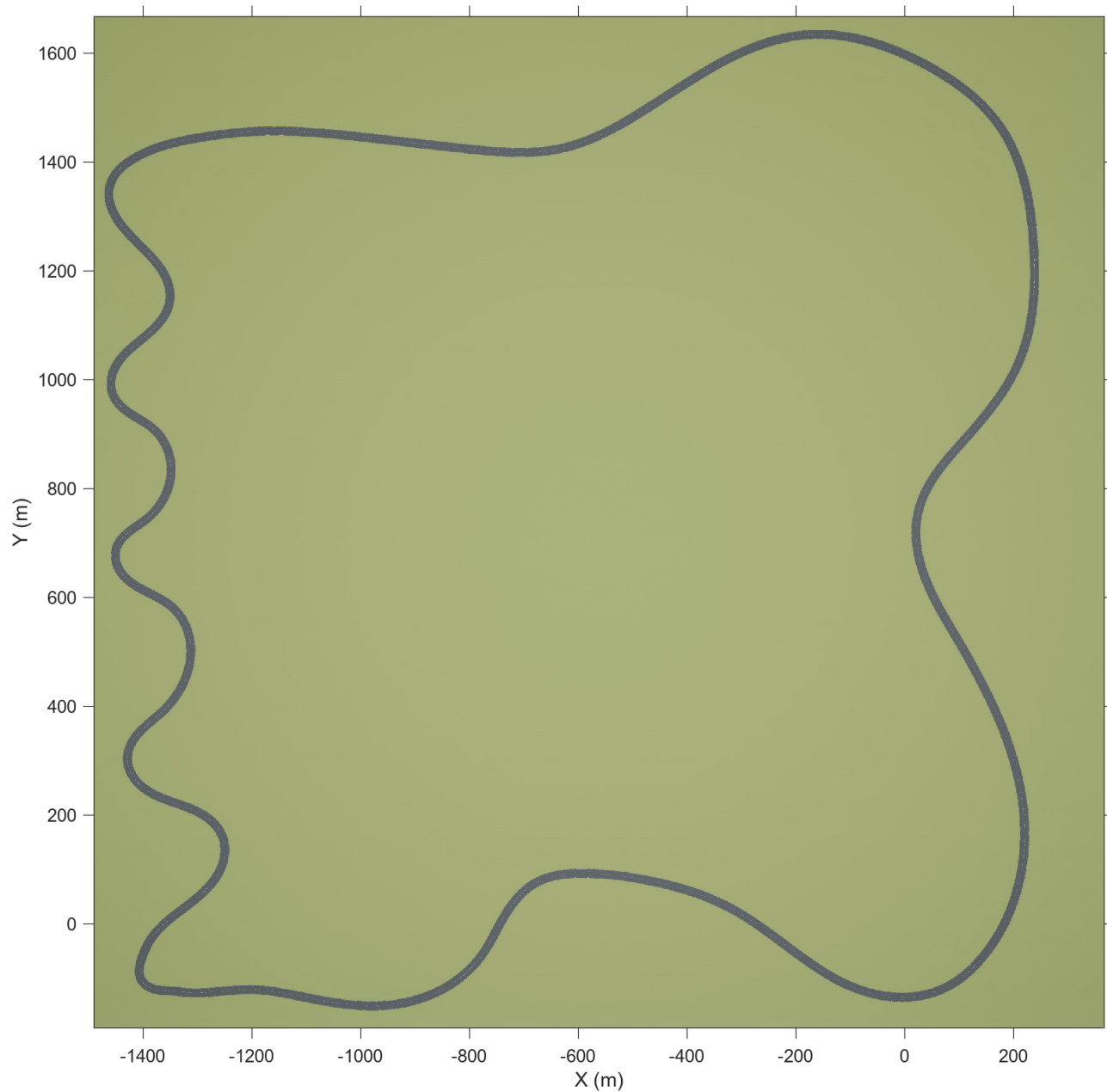

Zoom in on the origin of the scene. Place a marker at the origin.

```
xlim([-100 250])  
ylim([-200 150])
```

```
hold on  
plot(0,0,'o','MarkerFaceColor','r','MarkerEdgeColor','k','MarkerSize',8)  
offset = 5; % px  
text(offset,offset,'(0,0)','Color','k','FontWeight','bold','FontSize',12)  
hold off
```

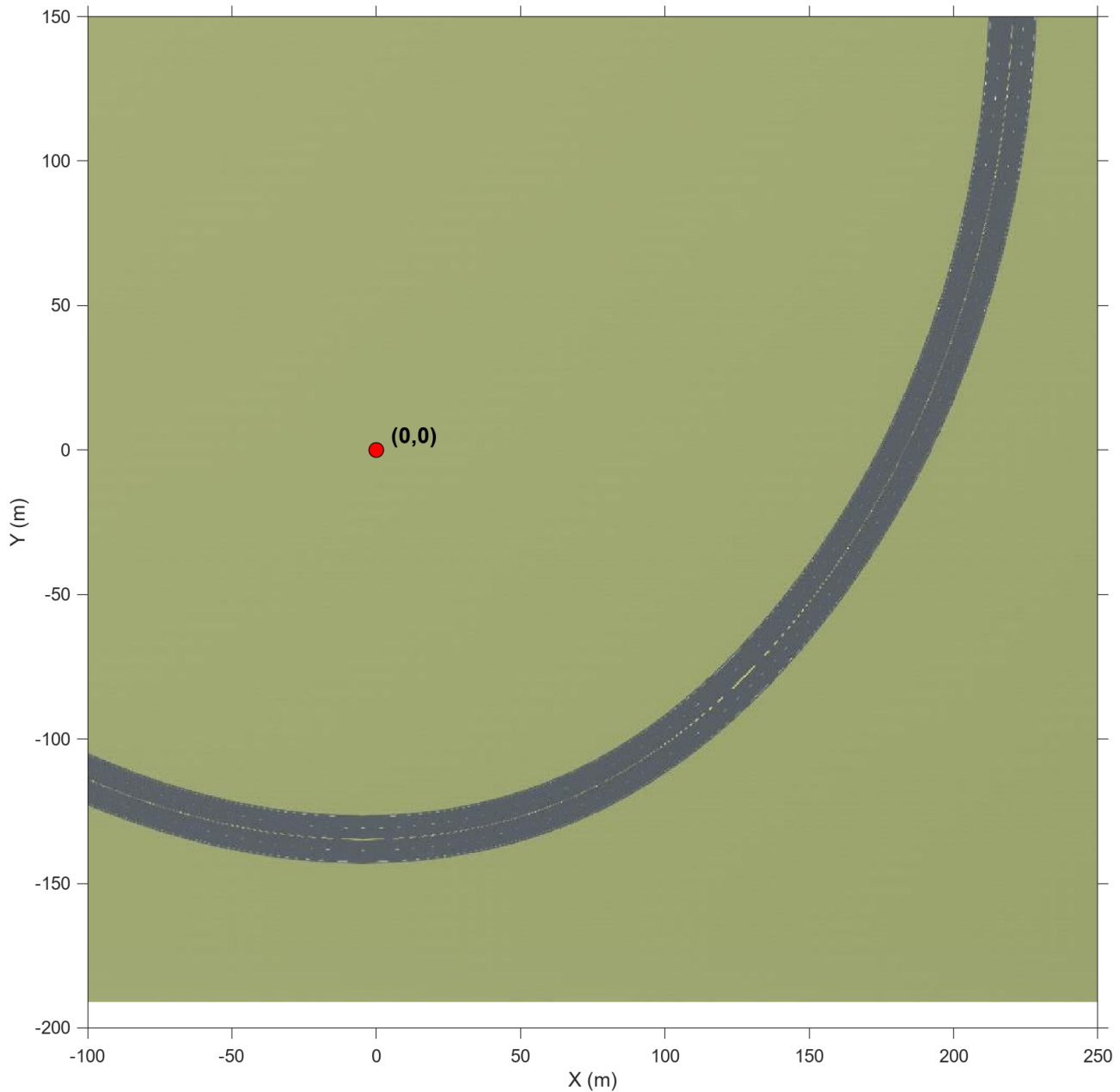
Tips

- If you have the Automated Driving Toolbox Interface for Unreal Engine 4 Projects support package, then you can modify this scene. In the Unreal Engine project file that comes with the support package, this scene is named `HwCurve`.

For more details on customizing scenes, see "Customize Unreal Engine Scenes for Automated Driving".

Version History

Introduced in R2019b

R2022b: Scene rendered using RoadRunner

Behavior changed in R2022b

Starting from R2022b, the Curved Road scene in the Unreal Engine 3D environment is rendered using RoadRunner. As a result, the locations of scene objects, including cones and parked vehicles, are moved from their pre-R2022b locations.

See Also

Straight Road | Parking Lot | Large Parking Lot | Open Surface | US City Block | US Highway | Virtual Mcity | Double Lane Change

Topics

“Unreal Engine Simulation for Automated Driving”

“Unreal Engine Simulation Environment Requirements and Limitations”

“Coordinate Systems for Unreal Engine Simulation in Automated Driving Toolbox”

“Cuboid Versions of 3D Simulation Scenes in Driving Scenario Designer”

Double Lane Change

Double lane change 3D environment

Description

The **Double Lane Change** scene is a 3D environment of a straight road containing cones, traffic signs, and barrels. The cones are set up for a vehicle to perform a double lane change maneuver. The scene is rendered using RoadRunner.



Setup

To simulate a driving algorithm in this scene:

- 1 Add a Simulation 3D Scene Configuration block to your Simulink model.
- 2 In this block, set the **Scene source** parameter to Default Scenes.
- 3 Set the enabled **Scene name** parameter to Double lane change.

Examples

Explore Double Lane Change Scene

Explore the 3D Double Lane Change scene and inspect its dimensions by using a corresponding 2D top-view image of the scene.

You can use this image to inspect the scene before simulation and choose starting coordinates for vehicles. For details on using these images to select waypoints for path-following applications, see the “Select Waypoints for Unreal Engine Simulation” example.

Load the 2D spatial referencing object that corresponds to the scene. This `imref2d` object describes the relationship between the pixels in the image and the world coordinates of the scene.

```
data = load('sim3d_SpatialReferences.mat');
spatialRef = data.spatialReference.DoubleLaneChange

spatialRef =
  imref2d with properties:

    XWorldLimits: [-1008 1008]
    YWorldLimits: [-1008 1008]
    ImageSize: [5080 5080]
    PixelExtentInWorldX: 0.3969
    PixelExtentInWorldY: 0.3969
    ImageExtentInWorldX: 2016
    ImageExtentInWorldY: 2016
    XIntrinsicLimits: [0.5000 5.0805e+03]
    YIntrinsicLimits: [0.5000 5.0805e+03]
```

Display the image corresponding to the scene. Use the spatial referencing object to display the axes in the world coordinates of the scene. Units are in meters.

By default, the `imshow` function displays Y-axis values that increase from top to bottom. To align with the Automated Driving Toolbox™ world coordinate system, set the Y-direction to `'normal'` so that Y-axis values increase from bottom to top.

The image displays only the area of the scene containing the parking lot. The full scene has a length and width of 2016 meters.

```
figure
fileName = 'sim3d_DoubleLaneChange.jpg';
I = imshow(fileName,spatialRef);
set(gca,'YDir','normal')
xlabel('X (m)')
ylabel('Y (m)')
```

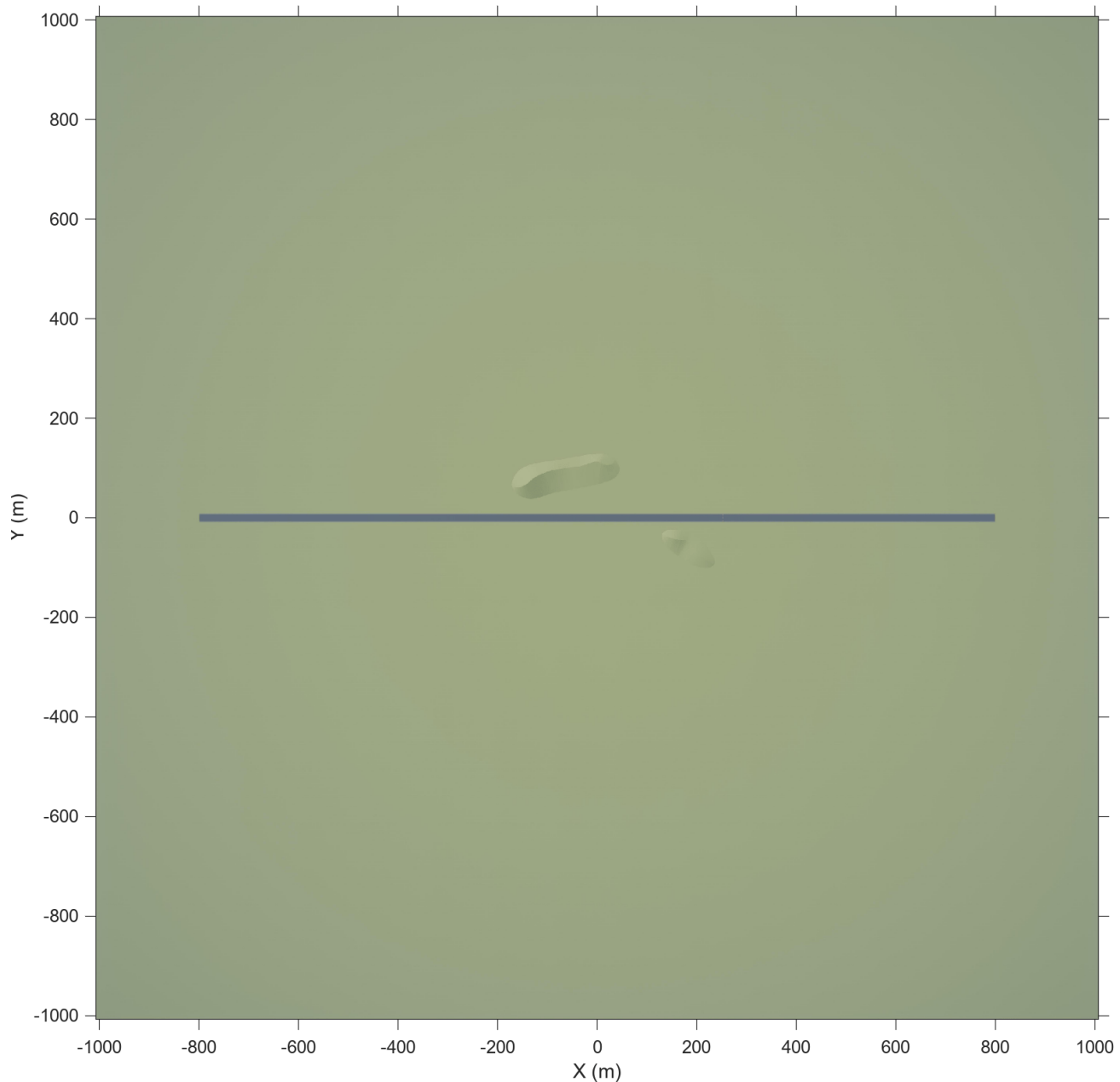

Zoom in on the origin of the scene. Place a marker at the origin. If you place a vehicle at the scene origin and set the vehicle's yaw angle to 0 , the traffic cones for performing the double lane change maneuver are directly in front of the vehicle.

```
xlim([-100 100])
ylim([-100 100])
```

```
hold on
plot(0,0,'o','MarkerFaceColor','r','MarkerEdgeColor','k','MarkerSize',8)
offset = 3; % px
text(offset,offset,'(0,0)','Color','w','FontWeight','bold','FontSize',12)
hold off
```

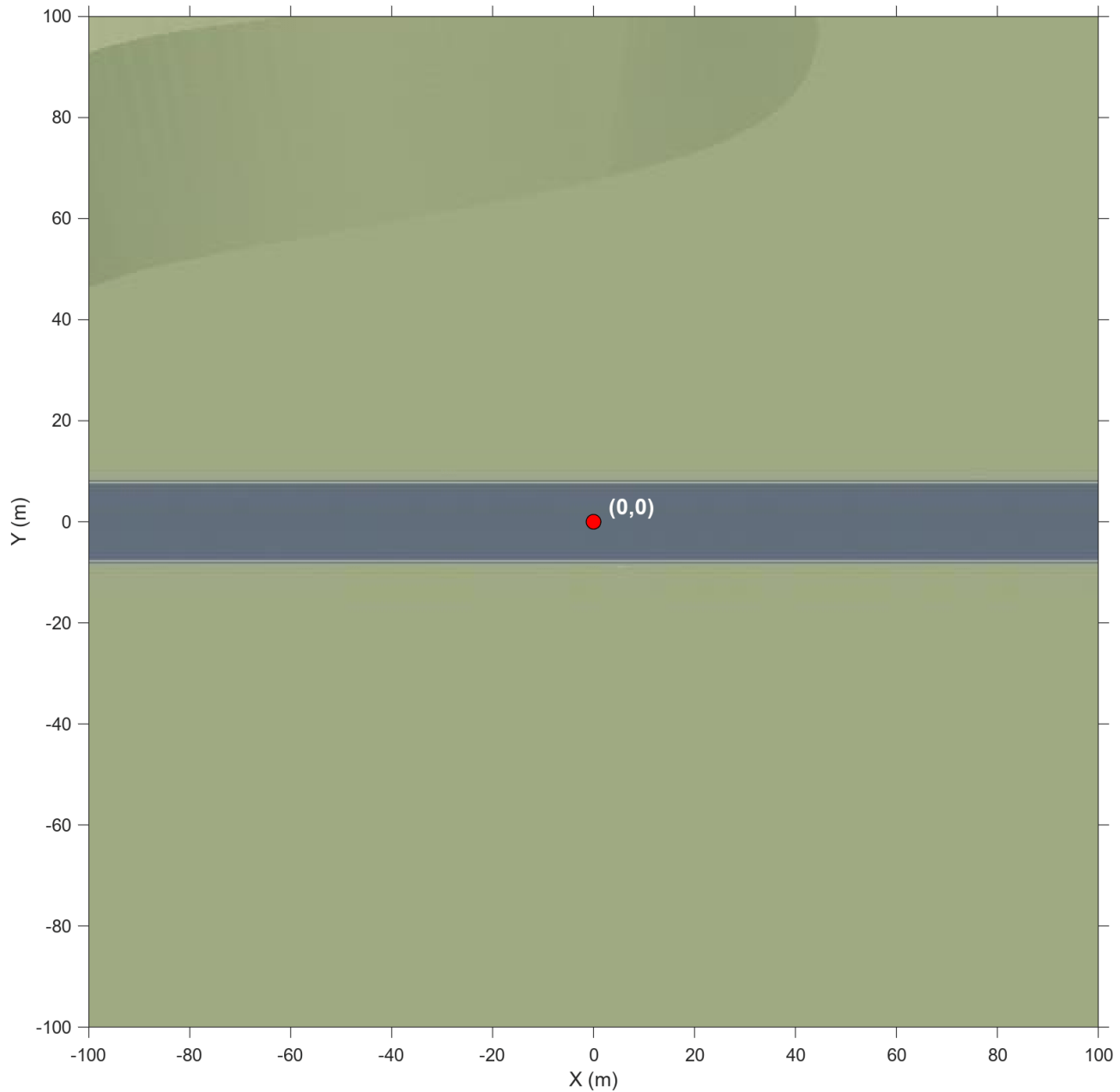

Tips

- If you have the Automated Driving Toolbox Interface for Unreal Engine 4 Projects support package, then you can modify this scene. In the Unreal Engine project file that comes with the support package, this scene is named `DbLLnChng`.

For more details on customizing scenes, see “Customize Unreal Engine Scenes for Automated Driving”.

Version History

Introduced in R2019b

R2022b: Scene rendered using RoadRunner

Behavior changed in R2022b

Starting from R2022b, the Double Lane Change scene in the Unreal Engine 3D environment is rendered using RoadRunner. As a result, the locations of scene objects, including cones and parked vehicles, are moved from their pre-R2022b locations.

See Also

[Straight Road](#) | [Curved Road](#) | [Parking Lot](#) | [Large Parking Lot](#) | [Open Surface](#) | [US City Block](#) | [US Highway](#) | [Virtual Mcity](#)

Topics

[“Unreal Engine Simulation for Automated Driving”](#)

[“Unreal Engine Simulation Environment Requirements and Limitations”](#)

[“Coordinate Systems for Unreal Engine Simulation in Automated Driving Toolbox”](#)

[“Cuboid Versions of 3D Simulation Scenes in Driving Scenario Designer”](#)

Large Parking Lot

Large parking lot 3D environment

Description

The **Large Parking Lot** scene is a 3D environment of a large parking lot that contains cones, curbs, traffic signs, and parked vehicles. The scene is rendered using RoadRunner.



Setup

To simulate a driving algorithm in this scene:

- 1 Add a Simulation 3D Scene Configuration block to your Simulink model.
- 2 In this block, set the **Scene source** parameter to Default Scenes.
- 3 Set the enabled **Scene name** parameter to Large parking lot.

Examples

Explore Large Parking Lot Scene

Explore the 3D Large Parking Lot scene and inspect its dimensions by using a corresponding 2D top-view image of the scene.

You can use this image to inspect the scene before simulation and choose starting coordinates for vehicles. For details on using these images to select waypoints for path-following applications, see the “Select Waypoints for Unreal Engine Simulation” example.

Load the 2D spatial referencing object that corresponds to the scene. This `imref2d` object describes the relationship between the pixels in the image and the world coordinates of the scene.

```
data = load('sim3d_SpatialReferences.mat');
spatialRef = data.spatialReference.LargeParkingLot
```

```
spatialRef =
  imref2d with properties:
    XWorldLimits: [-78.6000 72.6000]
    YWorldLimits: [-77.7000 73.5000]
    ImageSize: [5104 5104]
    PixelExtentInWorldX: 0.0296
    PixelExtentInWorldY: 0.0296
    ImageExtentInWorldX: 151.2000
    ImageExtentInWorldY: 151.2000
    XIntrinsicLimits: [0.5000 5.1045e+03]
    YIntrinsicLimits: [0.5000 5.1045e+03]
```

Display the image corresponding to the scene. Use the spatial referencing object to display the axes in the world coordinates of the scene. Units are in meters.

By default, the `imshow` function displays Y-axis values that increase from top to bottom. To align with the Automated Driving Toolbox™ world coordinate system, set the Y-direction to `'normal'` so that Y-axis values increase from bottom to top.

Place a marker at the origin of the scene.

```
figure
fileName = 'sim3d_LargeParkingLot.jpg';
I = imshow(fileName,spatialRef);
set(gca,'YDir','normal')
xlabel('X (m)')
ylabel('Y (m)')

hold on
plot(0,0,'o','MarkerFaceColor','r','MarkerEdgeColor','k','MarkerSize',8)
offset = 3; % px
text(offset,offset,'(0,0)','Color','w','FontWeight','bold','FontSize',12)
hold off
```



Tips

- If you have the Automated Driving Toolbox Interface for Unreal Engine 4 Projects support package, then you can modify this scene. In the Unreal Engine project file that comes with the support package, this scene is named `LargeParkingLot`.

For more details on customizing scenes, see “Customize Unreal Engine Scenes for Automated Driving”.

Version History

Introduced in R2019b

R2022a: Scene rendered using RoadRunner

Behavior changed in R2022a

Starting from R2022a, the Large Parking Lot scene in the Unreal Engine 3D environment is rendered using RoadRunner. As a result, the locations of scene objects, including cones and parked vehicles, are moved from their pre-R2022a locations.

See Also

[Straight Road](#) | [Curved Road](#) | [Parking Lot](#) | [Open Surface](#) | [Double Lane Change](#) | [US City Block](#) | [US Highway](#) | [Virtual Mcity](#)

Topics

[“Unreal Engine Simulation for Automated Driving”](#)

[“Unreal Engine Simulation Environment Requirements and Limitations”](#)

[“Coordinate Systems for Unreal Engine Simulation in Automated Driving Toolbox”](#)

Open Surface

Open surface 3D environment

Description

The **Open Surface** scene contains a 3D environment of an open, black road surface. The scene is rendered using RoadRunner.



Setup

To simulate a driving algorithm in this scene:

- 1 Add a Simulation 3D Scene Configuration block to your Simulink model.
- 2 In this block, set the **Scene source** parameter to `Default Scenes`.
- 3 Set the enabled **Scene name** parameter to `Open surface`.

Examples

Explore Open Surface Scene

Explore the 3D Open Surface scene and inspect its dimensions by using a corresponding 2D top-view image of the scene.

You can use this image to inspect the scene before simulation and choose starting coordinates for vehicles. For details on using these images to select waypoints for path-following applications, see the “Select Waypoints for Unreal Engine Simulation” example.

Load the 2D spatial referencing object that corresponds to the scene. This `imref2d` object describes the relationship between the pixels in the image and the world coordinates of the scene.

```
data = load('sim3d_SpatialReferences.mat');
spatialRef = data.spatialReference.OpenSurface
```

```
spatialRef =
  imref2d with properties:
      XWorldLimits: [-1010 1010]
      YWorldLimits: [-1010 1010]
      ImageSize: [4956 4956]
      PixelExtentInWorldX: 0.4076
      PixelExtentInWorldY: 0.4076
      ImageExtentInWorldX: 2020
      ImageExtentInWorldY: 2020
      XIntrinsicLimits: [0.5000 4.9565e+03]
      YIntrinsicLimits: [0.5000 4.9565e+03]
```

Display the image corresponding to the scene. Use the spatial referencing object to display the axes in the world coordinates of the scene. Units are in meters.

By default, the `imshow` function displays Y-axis values that increase from top to bottom. To align with the Automated Driving Toolbox™ world coordinate system, set the Y-direction to `'normal'` so that Y-axis values increase from bottom to top.

Place a marker at the origin of the scene.

```
figure
fileName = 'sim3d_OpenSurface.jpg';
I = imshow(fileName,spatialRef);
set(gca,'YDir','normal')
xlabel('X (m)')
ylabel('Y (m)')

hold on
plot(0,0,'o','MarkerFaceColor','r','MarkerEdgeColor','k','MarkerSize',8)
offset = 10; % px
text(offset,offset,'(0,0)','Color','w','FontWeight','bold','FontSize',12)
hold off
```

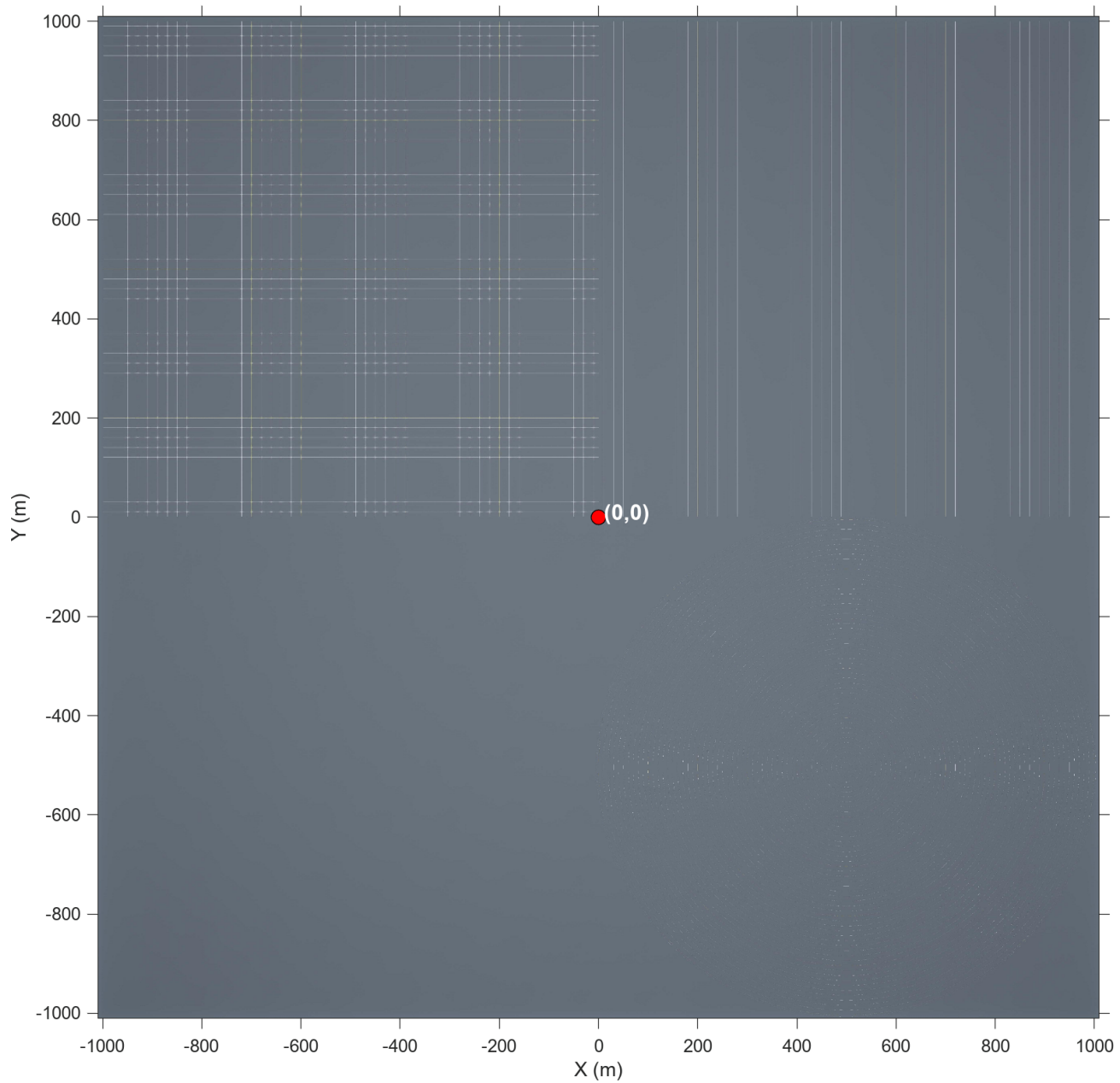

Tips

- If you have the Automated Driving Toolbox Interface for Unreal Engine 4 Projects support package, then you can modify this scene. In the Unreal Engine project file that comes with the support package, this scene is named `BlackLake`.

For more details on customizing scenes, see “Customize Unreal Engine Scenes for Automated Driving”.

Version History

Introduced in R2019b

R2022b: Scene rendered using RoadRunner

Behavior changed in R2022b

Starting from R2022b, the Open Surface scene in the Unreal Engine 3D environment is rendered using RoadRunner. As a result, the locations of scene objects, including cones and parked vehicles, are moved from their pre-R2022b locations.

See Also

Straight Road | Curved Road | Large Parking Lot | Parking Lot | Double Lane Change | US City Block | US Highway | Virtual Mcity

Topics

“Unreal Engine Simulation for Automated Driving”

“Unreal Engine Simulation Environment Requirements and Limitations”

“Coordinate Systems for Unreal Engine Simulation in Automated Driving Toolbox”

Parking Lot

Parking lot 3D environment

Description

The **Parking Lot** scene is a 3D environment of a parking lot. The scene is rendered using RoadRunner.



Setup

To simulate a driving algorithm in this scene:

- 1 Add a Simulation 3D Scene Configuration block to your Simulink model.
- 2 In this block, set the **Scene source** parameter to `Default Scenes`.
- 3 Set the enabled **Scene name** parameter to `Parking lot`.

Examples

Explore Parking Lot Scene

Explore the 3D Parking Lot scene and inspect its dimensions by using a corresponding 2D top-view image of the scene.

You can use this image to inspect the scene before simulation and choose starting coordinates for vehicles. For details on using these images to select waypoints for path-following applications, see the “Select Waypoints for Unreal Engine Simulation” example.

Load the 2D spatial referencing object that corresponds to the scene. This `imref2d` object describes the relationship between the pixels in the image and the world coordinates of the scene.

```
data = load('sim3d_SpatialReferences.mat');
spatialRef = data.spatialReference.ParkingLot

spatialRef =
  imref2d with properties:

      XWorldLimits: [-195.5000 8.9000]
      YWorldLimits: [-27.1000 177.3000]
      ImageSize: [5016 5016]
  PixelExtentInWorldX: 0.0407
  PixelExtentInWorldY: 0.0407
  ImageExtentInWorldX: 204.4000
  ImageExtentInWorldY: 204.4000
  XIntrinsicLimits: [0.5000 5.0165e+03]
  YIntrinsicLimits: [0.5000 5.0165e+03]
```

Display the image corresponding to the scene. Use the spatial referencing object to display the axes in the world coordinates of the scene. Units are in meters.

By default, the `imshow` function displays Y-axis values that increase from top to bottom. To align with the Automated Driving Toolbox™ world coordinate system, set the Y-direction to `'normal'` so that Y-axis values increase from bottom to top.

The image displays only the area of the scene containing the parking lot. The full scene has a length and width of 705.6 meters.

```
figure
fileName = 'sim3d_ParkingLot.jpg';
I = imshow(fileName,spatialRef);
set(gca,'YDir','normal')
xlabel('X (m)')
ylabel('Y (m)')
```

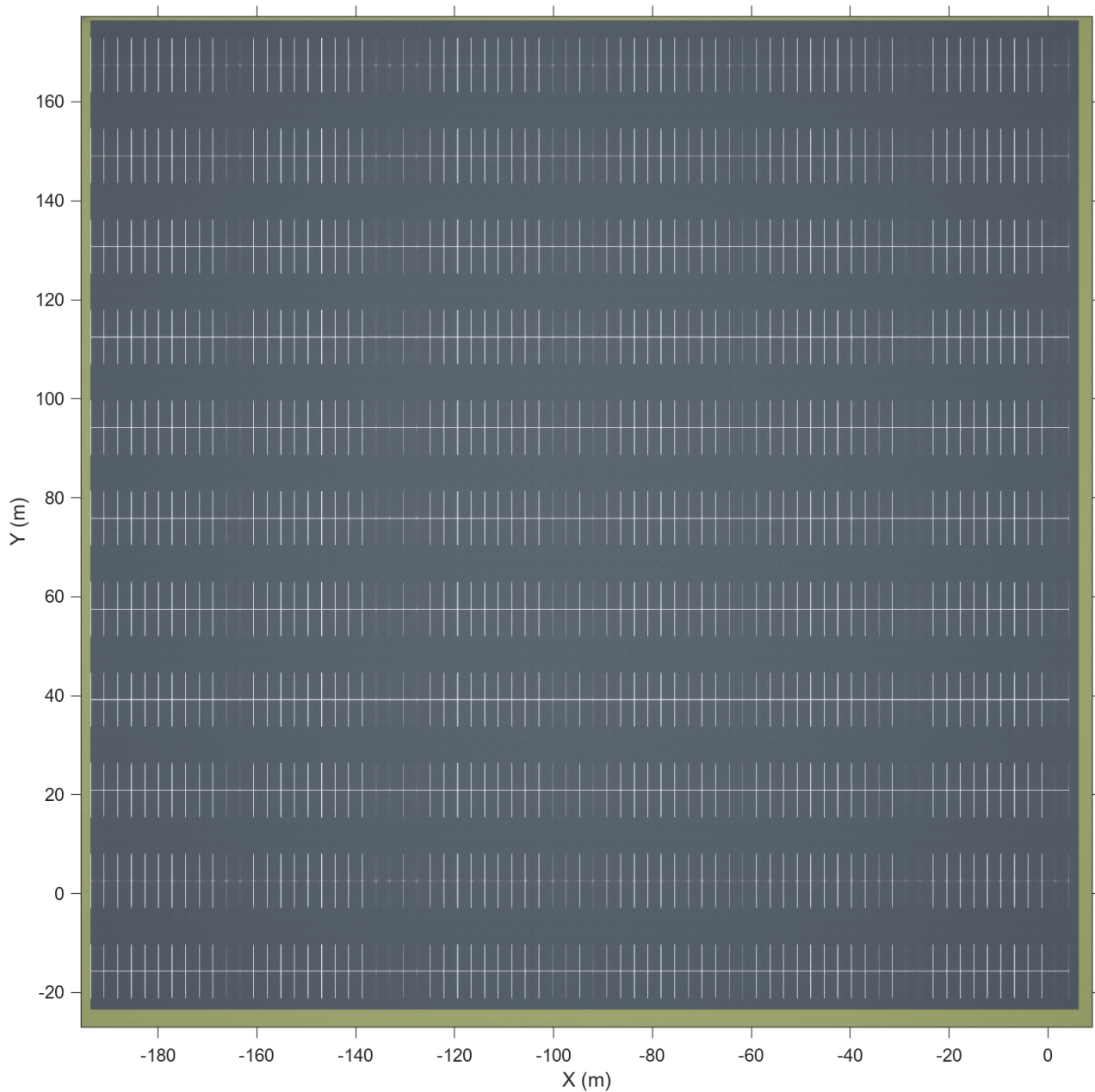

Zoom in on the origin of the scene. Place a marker at the origin.

```
xlim([-40 10])  
ylim([-30 20])
```

```
hold on  
plot(0,0,'o','MarkerFaceColor','r','MarkerEdgeColor','k','MarkerSize',8)  
offset = 1; % px  
text(offset,offset,'(0,0)','Color','w','FontWeight','bold','FontSize',12)  
hold off
```

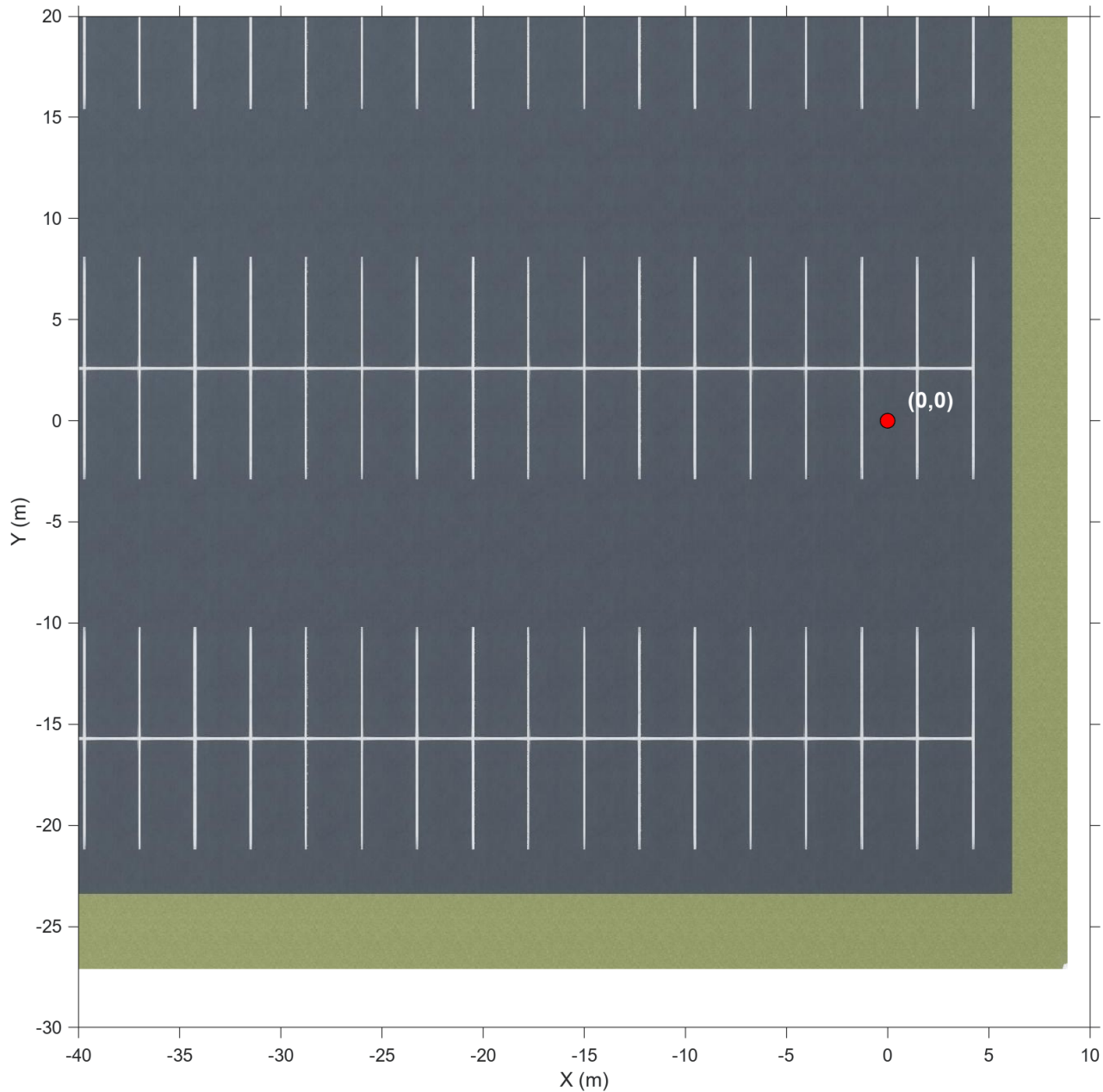

Tips

- If you have the Automated Driving Toolbox Interface for Unreal Engine 4 Projects support package, then you can modify this scene. In the Unreal Engine project file that comes with the support package, this scene is named `SimpleLot`.

For more details on customizing scenes, see “Customize Unreal Engine Scenes for Automated Driving”.

Version History

Introduced in R2019b

R2022b: Scene rendered using RoadRunner

Behavior changed in R2022b

Starting from R2022b, the Parking Lot scene in the Unreal Engine 3D environment is rendered using RoadRunner. As a result, the locations of scene objects, including cones and parked vehicles, are moved from their pre-R2022b locations.

See Also

Straight Road | Curved Road | Open Surface | Large Parking Lot | Double Lane Change | US City Block | US Highway | Virtual Mcity

Topics

“Unreal Engine Simulation for Automated Driving”

“Unreal Engine Simulation Environment Requirements and Limitations”

“Coordinate Systems in Automated Driving Toolbox”

Straight Road

Straight road 3D environment

Description

The **Straight Road** scene is a 3D environment of a straight four-lane divided highway. The scene is rendered using RoadRunner.



Setup

To simulate a driving algorithm in this scene:

- 1 Add a Simulation 3D Scene Configuration block to your Simulink model.
- 2 In this block, set the **Scene source** parameter to `Default Scenes`.
- 3 Set the enabled **Scene name** parameter to `Straight road`.

Examples

Explore Straight Road Scene

Explore the 3D Straight Road scene and inspect its dimensions by using a corresponding 2D top-view image of the scene.

You can use this image to inspect the scene before simulation and choose starting coordinates for vehicles. For details on using these images to select waypoints for path-following applications, see the “Select Waypoints for Unreal Engine Simulation” example.

Load the 2D spatial referencing object that corresponds to the scene. This `imref2d` object describes the relationship between the pixels in the image and the world coordinates of the scene.

```
data = load('sim3d_SpatialReferences.mat');
spatialRef = data.spatialReference.StraightRoad

spatialRef =
  imref2d with properties:

      XWorldLimits: [-1008 1008]
      YWorldLimits: [-1008 1008]
      ImageSize: [5040 5040]
  PixelExtentInWorldX: 0.4000
  PixelExtentInWorldY: 0.4000
  ImageExtentInWorldX: 2016
  ImageExtentInWorldY: 2016
  XIntrinsicLimits: [0.5000 5.0405e+03]
  YIntrinsicLimits: [0.5000 5.0405e+03]
```

Display the image corresponding to the scene. Use the spatial referencing object to display the axes in the world coordinates of the scene. Units are in meters.

By default, the `imshow` function displays Y-axis values that increase from top to bottom. To align with the Automated Driving Toolbox™ world coordinate system, set the Y-direction to 'normal' so that Y-axis values increase from bottom to top.

The image displays only the area of the scene containing the straight road. The full scene has a length and width of 2016 meters.

```
figure
fileName = 'sim3d_StraightRoad.jpg';
I = imshow(fileName,spatialRef);
set(gca,'YDir','normal')
xlabel('X (m)')
ylabel('Y (m)')
```

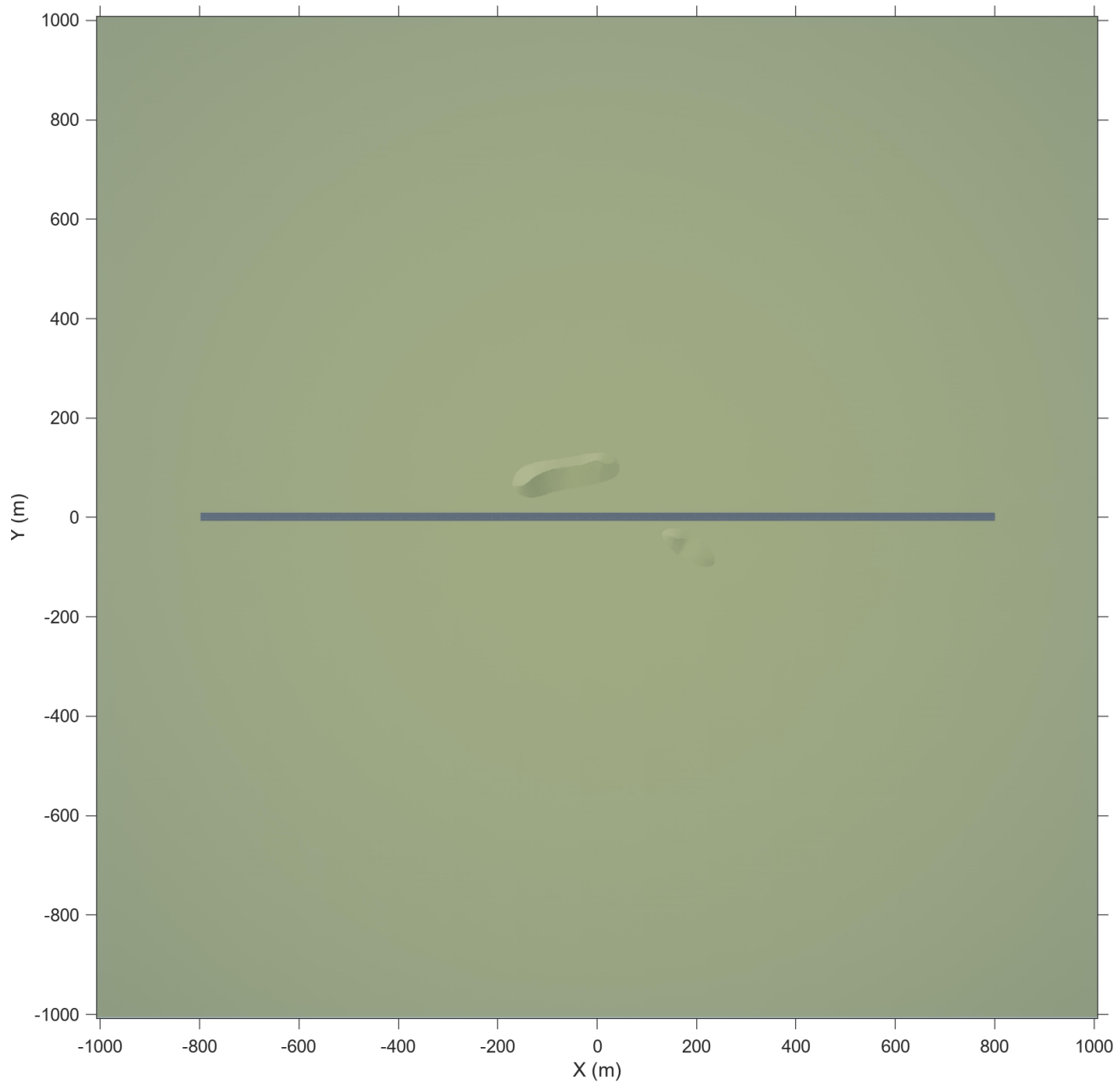

Zoom in on the origin of the scene. Place a marker at the origin.

```
xlim([-100 100])  
ylim([-100 100])
```

```
hold on  
plot(0,0,'o','MarkerFaceColor','r','MarkerEdgeColor','k','MarkerSize',8)  
offset = 3; % px  
text(offset,offset,'(0,0)','Color','w','FontWeight','bold','FontSize',12)  
hold off
```

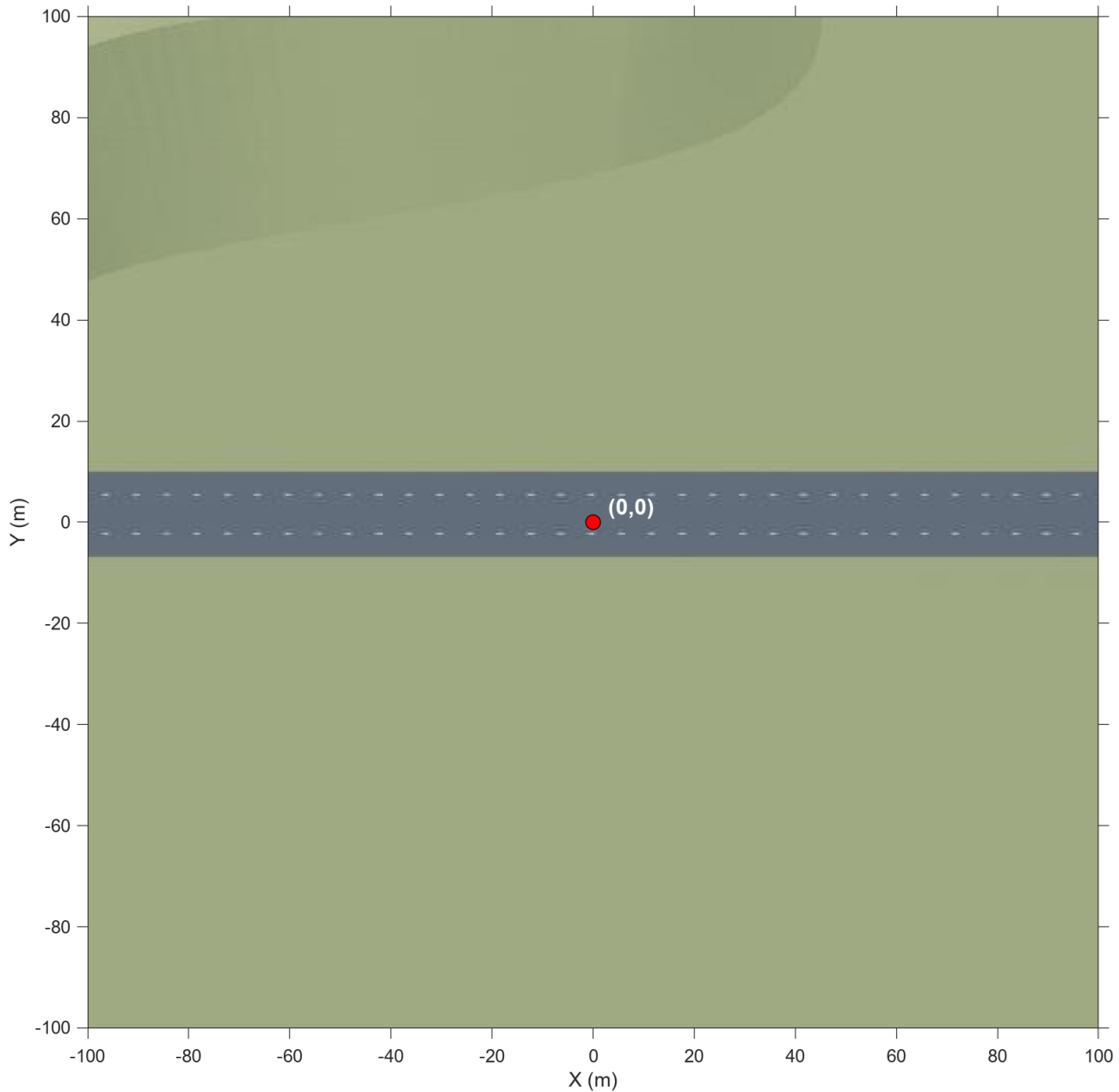

Tips

- If you have the Automated Driving Toolbox Interface for Unreal Engine 4 Projects support package, then you can modify this scene. In the Unreal Engine project file that comes with the support package, this scene is named `HwSt rght`.

For more details on customizing scenes, see “Customize Unreal Engine Scenes for Automated Driving”.

Version History

Introduced in R2019b

R2022b: Scene rendered using RoadRunner

Behavior changed in R2022b

Starting from R2022b, the Straight Road scene in the Unreal Engine 3D environment is rendered using RoadRunner. As a result, the locations of scene objects, including cones and parked vehicles, are moved from their pre-R2022b locations.

See Also

US Highway | Curved Road | Parking Lot | Large Parking Lot | Open Surface | Double Lane Change | US City Block | Virtual Mcity

Topics

“Unreal Engine Simulation for Automated Driving”

“Unreal Engine Simulation Environment Requirements and Limitations”

“Coordinate Systems for Unreal Engine Simulation in Automated Driving Toolbox”

“Cuboid Versions of 3D Simulation Scenes in Driving Scenario Designer”

US City Block

US city block 3D environment

Description

The **US City Block** scene is a 3D environment of a US city block that contains 15 intersections and 30 traffic lights. The scene is rendered using RoadRunner.



Setup

To simulate a driving algorithm in this scene:

- 1 Add a Simulation 3D Scene Configuration block to your Simulink model.
- 2 In this block, set the **Scene source** parameter to Default Scenes.
- 3 Set the enabled **Scene name** parameter to US city block.

Objects

Traffic Lights



The US City Scene contains 30 traffic lights, two at each of the 15 intersections. Each intersection has a traffic light group. If you use the “Traffic Light Negotiation with Unreal Engine Visualization” example, you can control the timing of the traffic lights.

Locations

This table provides the traffic light names and locations in the world coordinate system. Dimensions are in m. Only one of the traffic lights in the group can be green at a time. The traffic lights are green for 10 s and yellow for 3 s. At the start of the simulation, the first traffic lights in the group are green (for example, SM_TrafficLights1_3 and SM_TrafficLights2_3). The second lights in the group are red (for example, SM_TrafficLights1_4 and SM_TrafficLights2_4).

Intersection	Unreal Engine Editor Name		Location					
	Traffic Light Group	Traffic Light	X	Y	Z	Roll	Pitch	Yaw
1	TrafficLightGroup	SM_TrafficLight s1_3	-196.55	100.65	0	0	0	-90°
		SM_TrafficLight s1_4	-210.20	113.40	0	0	0	0
2	TrafficLightGroup2	SM_TrafficLight s2_3	-106.35	-98.35	0	0	0	90°
		SM_TrafficLight s2_4	-120.40	113.50	0	0	0	0

Intersect ion	Unreal Engine Editor Name		Location					
	Traffic Light Group	Traffic Light	X	Y	Z	Roll	Pitch	Yaw
3	TrafficLightGroup3	SM_TrafficLight s3_1	-13.10	116.20	0.2	0	0	-90°
		SM_TrafficLight s3_4	-30.60	113.80	0	0	0	0
4	TrafficLightGroup4	SM_TrafficLight s4_3	71.40	100.30	0	0	0	100°
		SM_TrafficLight s4_4	64.80	113.0	0	0	0	0
5	TrafficLightGroup5	SM_TrafficLight s5_1	171.50	115.70	0	0	0	-90°
		SM_TrafficLight s5_4	157.40	113.50	0	0	0	0
6	TrafficLightGroup6	SM_TrafficLight s6_2	-177.30	-5.70	0	0	0	-180°
		SM_TrafficLight s6_3	-189.60	-7.40	0	0	0	90°
7	TrafficLightGroup7	SM_TrafficLight s7_2	-105.20	-5.50	0	0	0	-180°
		SM_TrafficLight s7_3	-117.80	-7.70	0.2	0	0	90°

Intersection	Unreal Engine Editor Name		Location					
	Traffic Light Group	Traffic Light	X	Y	Z	Roll	Pitch	Yaw
8	TrafficLightGroup8	SM_TrafficLight_s8_1	-13.10	7.60	0.1	0	0	-90°
		SM_TrafficLight_s8_2	-10.90	-5.60	0	0	0	-180°
9	TrafficLightGroup9	SM_TrafficLight_s9_2	85.90	-7.60	0.2	0	0	-180°
		SM_TrafficLight_s9_3	70.90	-9.20	0	0	0	90°
10	TrafficLightGroup10	SM_TrafficLight_s10_1	172.10	7.70	0	0	0	-90°
		SM_TrafficLight_s10_2	173.70	-7.50	0	0	0	-180°
11	TrafficLightGroup11	SM_TrafficLight_s11_3	-189.80	-118.45	0	0	0	90°
		SM_TrafficLight_s11_4	-191.05	-104.55	0	0	0	0
12	TrafficLightGroup12	SM_TrafficLight_s12_3	-117.60	-117.60	0	0	0	90°
		SM_TrafficLight_s12_4	-120.50	-105.40	0	0	0	0

Intersection	Unreal Engine Editor Name		Location					
	Traffic Light Group	Traffic Light	X	Y	Z	Roll	Pitch	Yaw
13	TrafficLightGroup13	SM_TrafficLight_s13_1	-12.80	-102.50	0	0	0	-90°
		SM_TrafficLight_s13_4	-30.50	-105.30	0	0	0	0
14	TrafficLightGroup14	SM_TrafficLight_s14_3	70.90	-118.70	0	0	0	90°
		SM_TrafficLight_s14_4	69.30	-105.30	0	0	0	0
15	TrafficLightGroup15	SM_TrafficLight_s15_1	171.40	-105.20	0	0	0	-90°
		SM_TrafficLight_s15_4	158.40	-107.20	0	0	0	0

Examples

Explore US City Block Scene

Explore the 3D US City Block scene and inspect its dimensions by using a corresponding 2D top-view image of the scene.

You can use this image to inspect the scene before simulation and choose starting coordinates for vehicles. For details on using these images to select waypoints for path-following applications, see the “Select Waypoints for Unreal Engine Simulation” example.

Load the 2D spatial referencing object that corresponds to the scene. This `imref2d` object describes the relationship between the pixels in the image and the world coordinates of the scene.

```
data = load('sim3d_SpatialReferences.mat');
spatialRef = data.spatialReference.USCityBlock
```

```
spatialRef =
    imref2d with properties:
```

```
XWorldLimits: [-250 210]
YWorldLimits: [-235 225]
ImageSize: [4776 4776]
PixelExtentInWorldX: 0.0963
PixelExtentInWorldY: 0.0963
ImageExtentInWorldX: 460
ImageExtentInWorldY: 460
XIntrinsicLimits: [0.5000 4.7765e+03]
YIntrinsicLimits: [0.5000 4.7765e+03]
```

Display the image corresponding to the scene. Use the spatial referencing object to display the axes in the world coordinates of the scene. Units are in meters.

By default, the `imshow` function displays Y-axis values that increase from top to bottom. To align with the Automated Driving Toolbox™ world coordinate system, set the Y-direction to `'normal'` so that Y-axis values increase from bottom to top.

The image displays only the area of the scene containing the city block. The full scene has a length and width of 2040 meters.

```
figure
fileName = 'sim3d_USCityBlock.jpg';
I = imshow(fileName,spatialRef);
set(gca,'YDir','normal')
xlabel('X (m)')
ylabel('Y (m)')
```

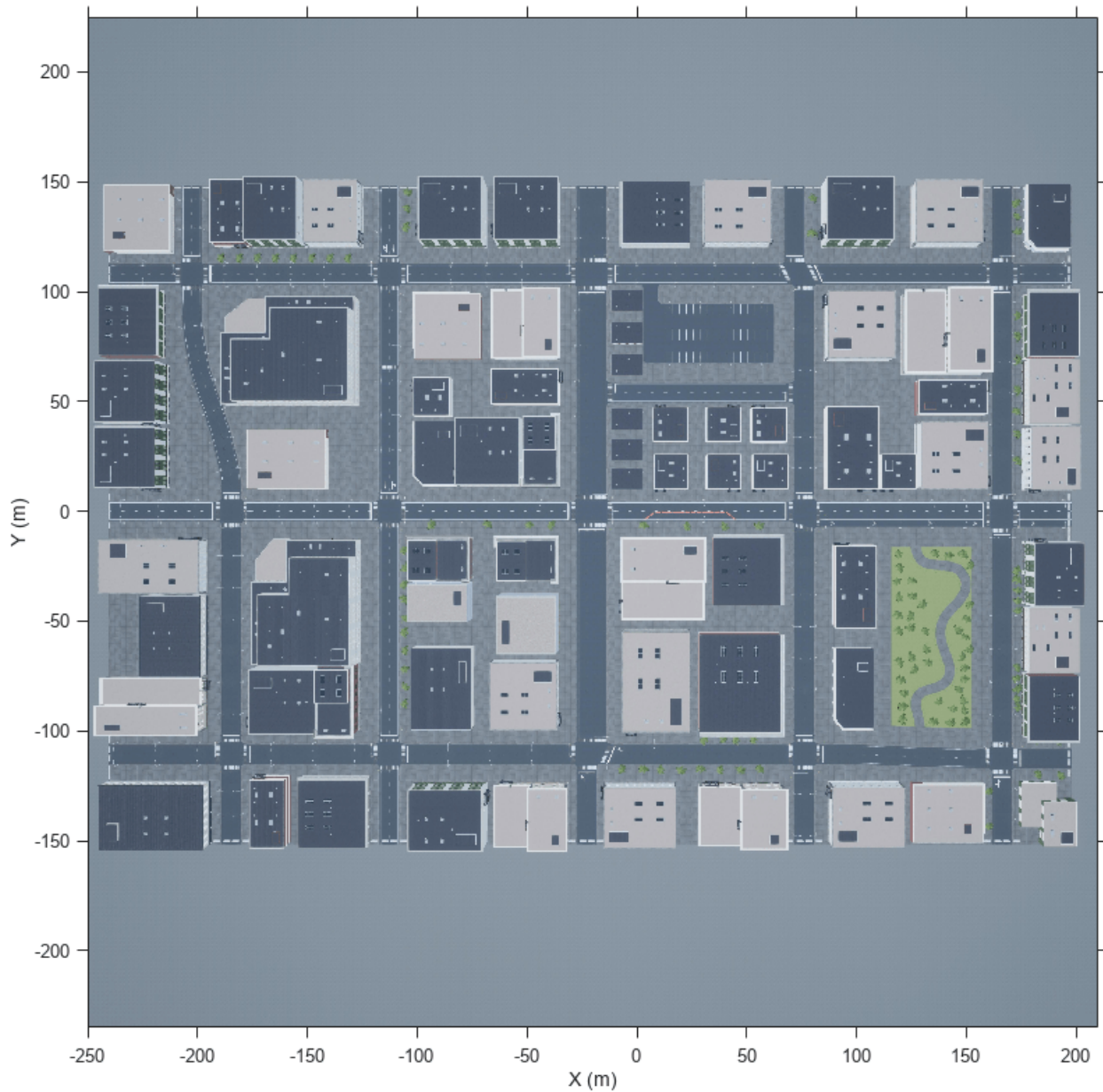

Zoom in on the origin of the scene. Place a marker at the origin.

```
xlim([-35 35])  
ylim([-35 35])
```

```
hold on  
plot(0,0,'o','MarkerFaceColor','r','MarkerEdgeColor','k','MarkerSize',8)  
offset = 1; % px  
text(offset,offset,'(0,0)','Color','w','FontWeight','bold','FontSize',12)  
hold off
```

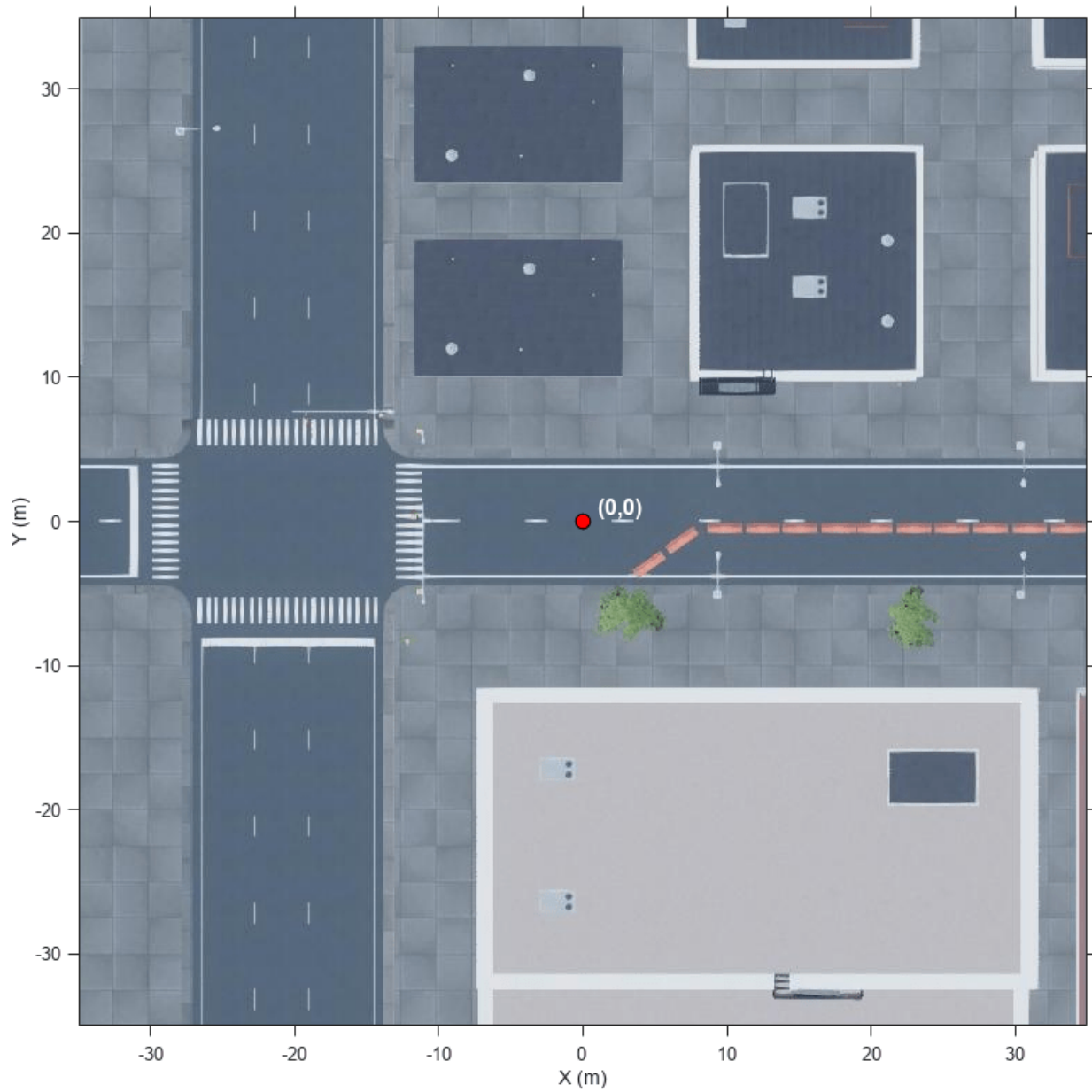
Each intersection in the scene contains two traffic light groups. These traffic lights change color based on common US traffic light patterns. All roads in the scene are one-way and follow the direction of traffic shown here.

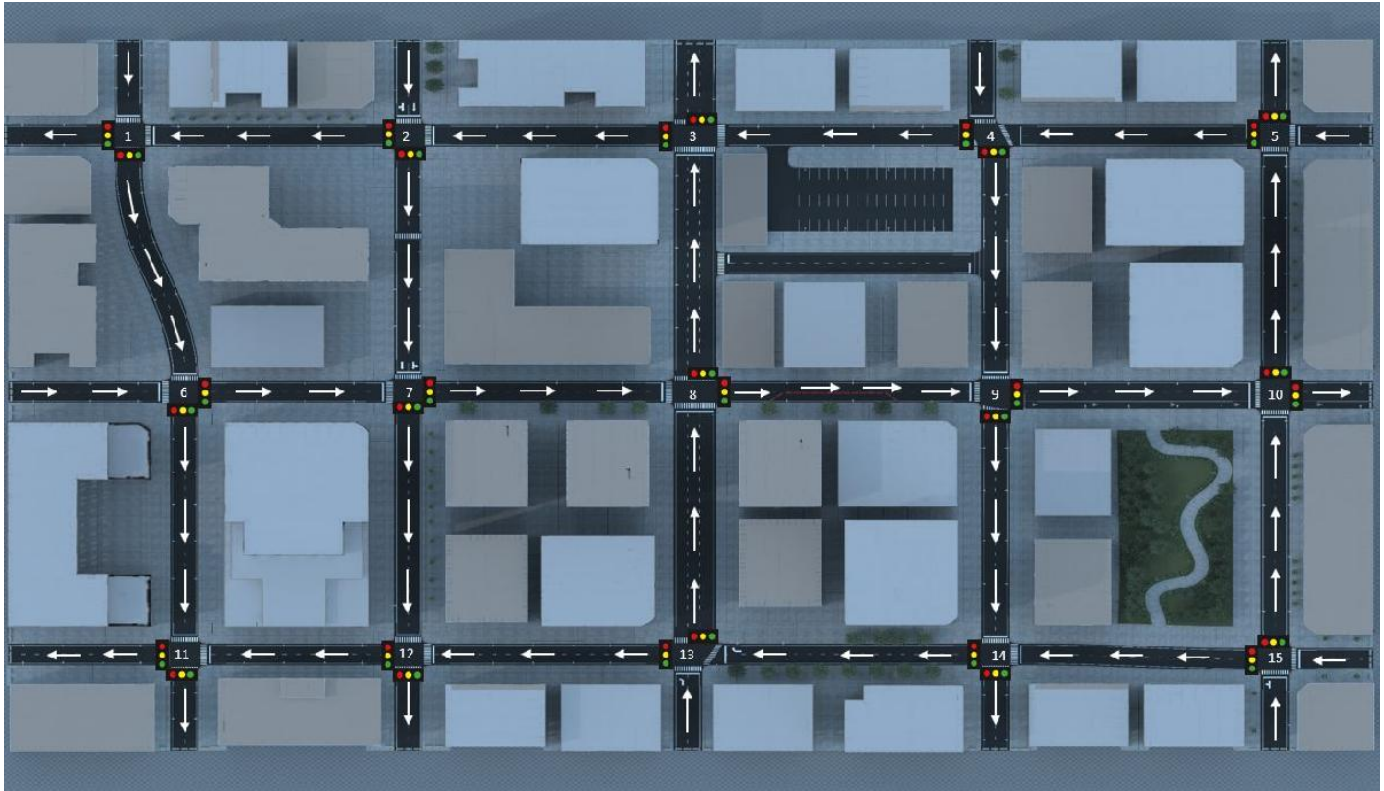

Tips

- If you have the Automated Driving Toolbox Interface for Unreal Engine 4 Projects support package, then you can modify this scene. In the Unreal Engine project file that comes with the support package, this scene is named USCityBlock.

For more details on customizing scenes, see “Customize Unreal Engine Scenes for Automated Driving”.

Version History

Introduced in R2019b

R2022b: Scene rendered using RoadRunner

Behavior changed in R2022b

Starting from R2022b, the US City Block scene in the Unreal Engine 3D environment is rendered using RoadRunner. As a result, the locations of scene objects, including cones and parked vehicles, are moved from their pre-R2022b locations.

See Also

Straight Road | Curved Road | Parking Lot | Large Parking Lot | Open Surface | Double Lane Change | US Highway | Virtual Mcity

Topics

“Unreal Engine Simulation for Automated Driving”

“Unreal Engine Simulation Environment Requirements and Limitations”

“Coordinate Systems for Unreal Engine Simulation in Automated Driving Toolbox”

“Cuboid Versions of 3D Simulation Scenes in Driving Scenario Designer”

US Highway

US highway 3D environment

Description

The **US Highway** scene is a 3D environment of a US highway that contains barriers, cones, and traffic signs. The scene is rendered using RoadRunner.



Setup

To simulate a driving algorithm in this scene:

- 1 Add a Simulation 3D Scene Configuration block to your Simulink model.
- 2 In this block, set the **Scene source** parameter to Default Scenes.
- 3 Set the enabled **Scene name** parameter to US highway.

Examples

Explore US Highway Scene

Explore the 3D US Highway scene and inspect its dimensions by using a corresponding 2D top-view image of the scene.

You can use this image to inspect the scene before simulation and choose starting coordinates for vehicles. For details on using these images to select waypoints for path-following applications, see the “Select Waypoints for Unreal Engine Simulation” example.

Load the 2D spatial referencing object that corresponds to the scene. This `imref2d` object describes the relationship between the pixels in the image and the world coordinates of the scene.

```
data = load('sim3d_SpatialReferences.mat');  
spatialRef = data.spatialReference.USHighway
```

```
spatialRef =  
  imref2d with properties:  
  
      XWorldLimits: [2820 5086]  
      YWorldLimits: [-3748 -1482]  
      ImageSize: [5096 5096]  
PixelExtentInWorldX: 0.4447  
PixelExtentInWorldY: 0.4447  
ImageExtentInWorldX: 2266  
ImageExtentInWorldY: 2266  
  XIntrinsicLimits: [0.5000 5.0965e+03]  
  YIntrinsicLimits: [0.5000 5.0965e+03]
```

Display the image corresponding to the scene. Use the spatial referencing object to display the axes in the world coordinates of the scene. Units are in meters.

By default, the `imshow` function displays Y-axis values that increase from top to bottom. To align with the Automated Driving Toolbox™ world coordinate system, set the Y-direction to `'normal'` so that Y-axis values increase from bottom to top.

The image displays only the area of the scene containing the highway. The full scene has a length and width of 10,160 meters. The origin of the scene is outside the range of the displayed image.

```
figure  
fileName = 'sim3d_USHighway.jpg';  
I = imshow(fileName,spatialRef);  
set(gca,'YDir','normal')  
xlabel('X (m)')  
ylabel('Y (m)')
```

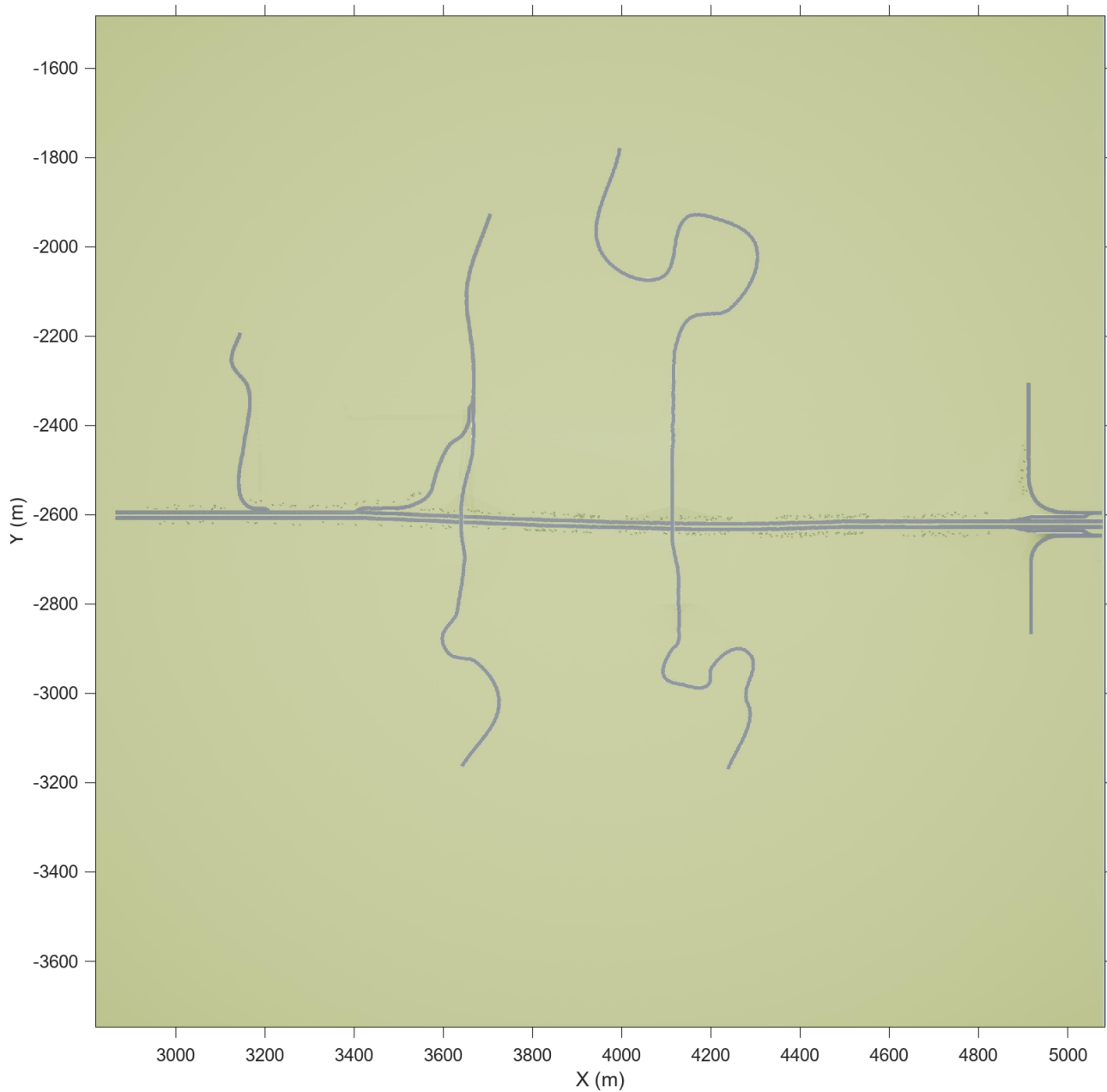

Tips

- If you have the Automated Driving Toolbox Interface for Unreal Engine 4 Projects support package, then you can modify this scene. In the Unreal Engine project file that comes with the support package, this scene is named USHighway.

For more details on customizing scenes, see “Customize Unreal Engine Scenes for Automated Driving”.

Version History

Introduced in R2019b

R2022b: Scene rendered using RoadRunner

Behavior changed in R2022b

Starting from R2022b, the US Highway scene in the Unreal Engine 3D environment is rendered using RoadRunner. As a result, the locations of scene objects, including cones and parked vehicles, are moved from their pre-R2022b locations.

See Also

Straight Road | Curved Road | Parking Lot | Large Parking Lot | Open Surface | Double Lane Change | US City Block | Virtual Mcity

Topics

“Unreal Engine Simulation for Automated Driving”

“Unreal Engine Simulation Environment Requirements and Limitations”

“Coordinate Systems for Unreal Engine Simulation in Automated Driving Toolbox”

“Cuboid Versions of 3D Simulation Scenes in Driving Scenario Designer”

Virtual Mcity

Virtual Mcity 3D environment

Description

The **Virtual Mcity** scene is a 3D environment containing a virtual representation of Mcity®, which is a testing ground belonging to the University of Michigan. For more details, see Mcity Test Facility.

The scene is rendered using the Unreal Engine from Epic Games.



Setup

To simulate a driving algorithm in this scene:

- 1 Add a Simulation 3D Scene Configuration block to your Simulink model.
- 2 In this block, set the **Scene source** parameter to Default Scenes.
- 3 Set the enabled **Scene name** parameter to Virtual Mcity.

Examples

Explore Virtual Mcity Scene

Explore the 3D Virtual Mcity scene and inspect its dimensions by using a corresponding 2D top-view image of the scene.

You can use this image to inspect the scene before simulation and choose starting coordinates for vehicles. For details on using these images to select waypoints for path-following applications, see the “Select Waypoints for Unreal Engine Simulation” example.

Load the 2D spatial referencing object that corresponds to the scene. This `imref2d` object describes the relationship between the pixels in the image and the world coordinates of the scene.

```
data = load('sim3d_SpatialReferences.mat');
spatialRef = data.spatialReference.VirtualMcity
```

```
spatialRef =
  imref2d with properties:
      XWorldLimits: [-159.3500 253.3500]
      YWorldLimits: [-94.4500 318.2500]
      ImageSize: [4645 4645]
      PixelExtentInWorldX: 0.0888
      PixelExtentInWorldY: 0.0888
      ImageExtentInWorldX: 412.7000
      ImageExtentInWorldY: 412.7000
      XIntrinsicLimits: [0.5000 4.6455e+03]
      YIntrinsicLimits: [0.5000 4.6455e+03]
```

Display the image corresponding to the scene. Use the spatial referencing object to display the axes in the world coordinates of the scene. Units are in meters.

By default, the `imshow` function displays Y-axis values that increase from top to bottom. To align with the Automated Driving Toolbox™ world coordinate system, set the Y-direction to `'normal'` so that Y-axis values increase from bottom to top.

The image displays only the area of the scene containing the city. The full scene has a length of 541.44 meters and a width of 342.98 meters.

```
figure
fileName = 'sim3d_VirtualMcity.jpg';
I = imshow(fileName,spatialRef);
set(gca,'YDir','normal')
xlabel('X (m)')
ylabel('Y (m)')
```

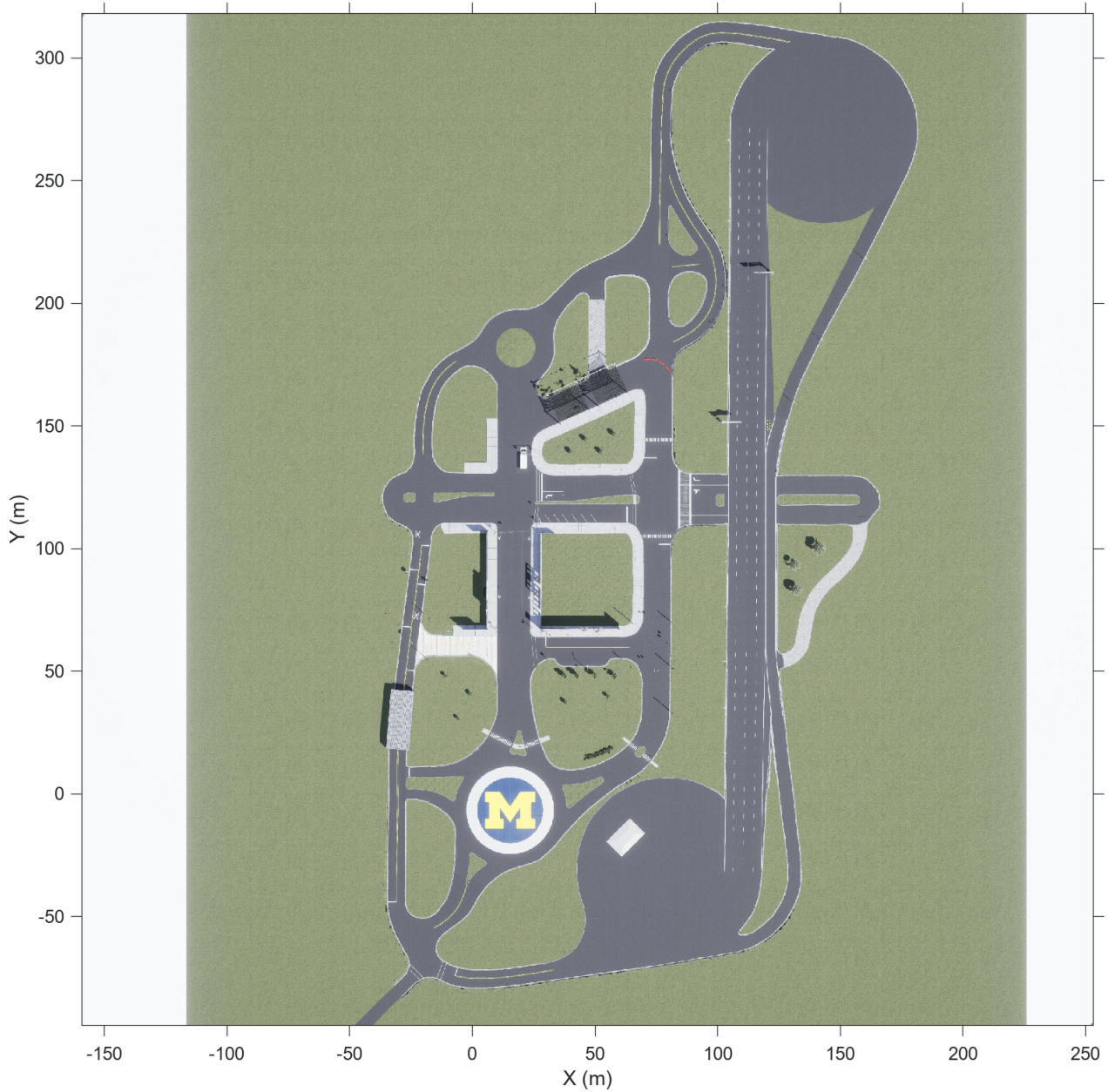

Zoom in on the origin of the scene. Place a marker at the origin.

```
xlim([-20 50])  
ylim([-40 30])
```

```
hold on  
plot(0,0,'o','MarkerFaceColor','r','MarkerEdgeColor','k','MarkerSize',8)  
offset = 1; % px  
text(offset,offset,'(0,0)','Color','k','FontWeight','bold','FontSize',12)  
hold off
```

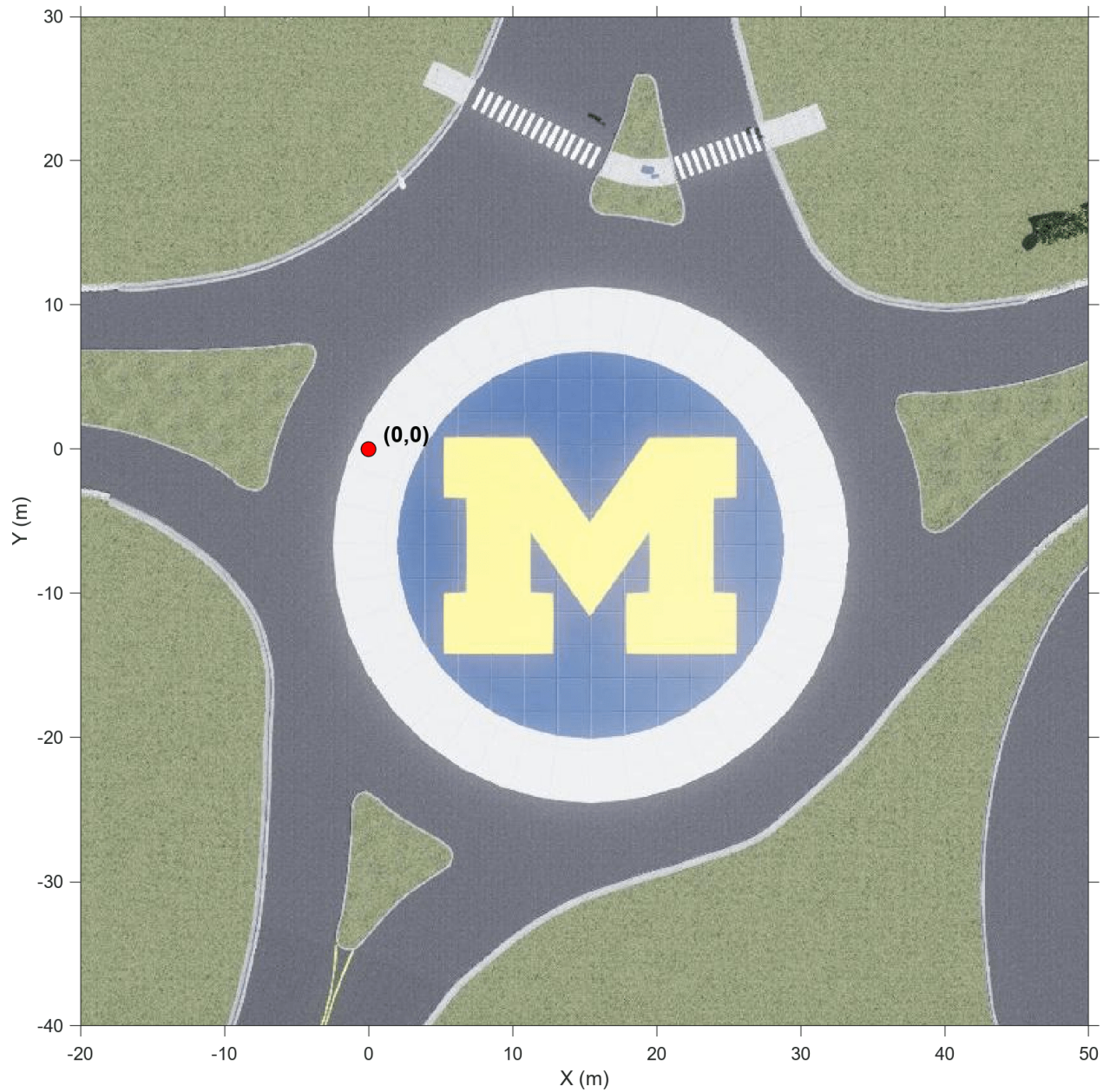

Limitations

- In the Automated Driving Toolbox Interface for Unreal Engine 4 Projects support package, this scene is not available for customization.

For details on which scenes you can customize, see “Customize Unreal Engine Scenes for Automated Driving”.

Version History

Introduced in R2019b

See Also

Straight Road | Curved Road | Large Parking Lot | Parking Lot | Open Surface | Double Lane Change | US City Block | US Highway

Topics

“Unreal Engine Simulation for Automated Driving”

“Unreal Engine Simulation Environment Requirements and Limitations”

“Coordinate Systems for Unreal Engine Simulation in Automated Driving Toolbox”

External Websites

Mcity Test Facility

Vehicle Dimensions

Hatchback

Hatchback vehicle dimensions

Description

Hatchback is one of the vehicles that you can use within the 3D simulation environment. This environment is rendered using the Unreal Engine from Epic Games. The diagram provides the dimensions of this vehicle. The height dimensions are with respect to the vertical ground plane. The length and width dimensions are with respect to the origin of the vehicle in the vehicle coordinate system. The origin is on the ground, at the geometric center of the vehicle. For more detailed views of these diagrams, see the **Dimensions** section.

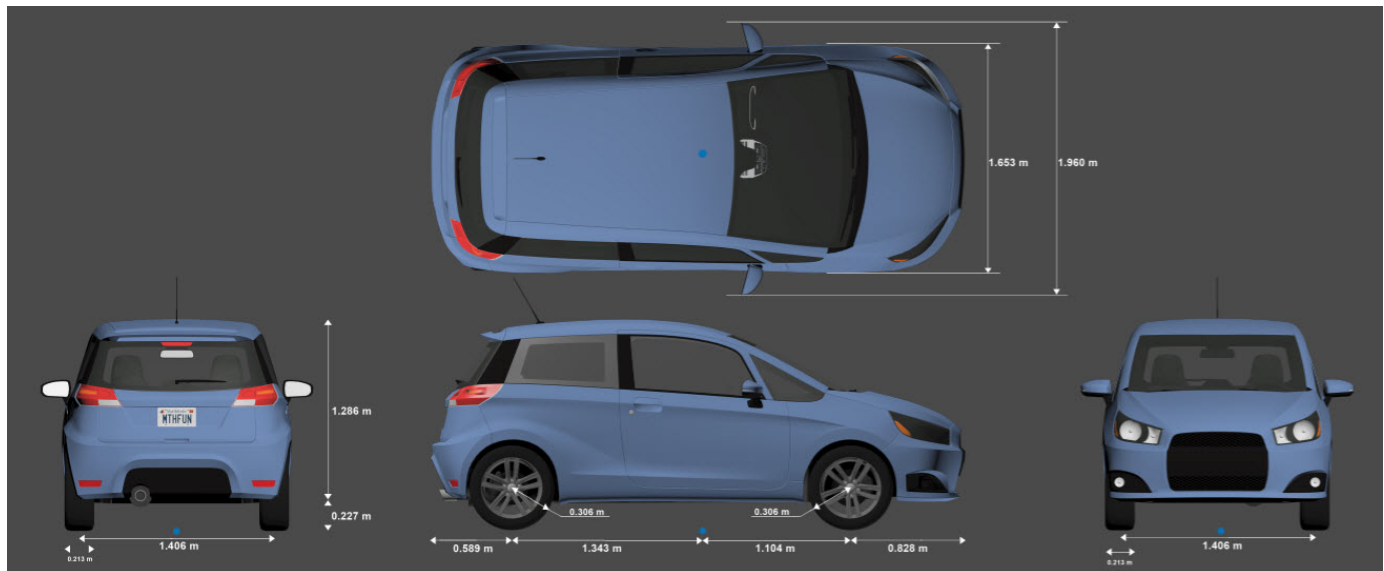

To add this type of vehicle to the 3D simulation environment:

- 1 Add a Simulation 3D Vehicle with Ground Following block to your Simulink model.
- 2 In the block, set the **Type** parameter to Hatchback.

Dimensions

Top-down view — Vehicle width dimensions diagram

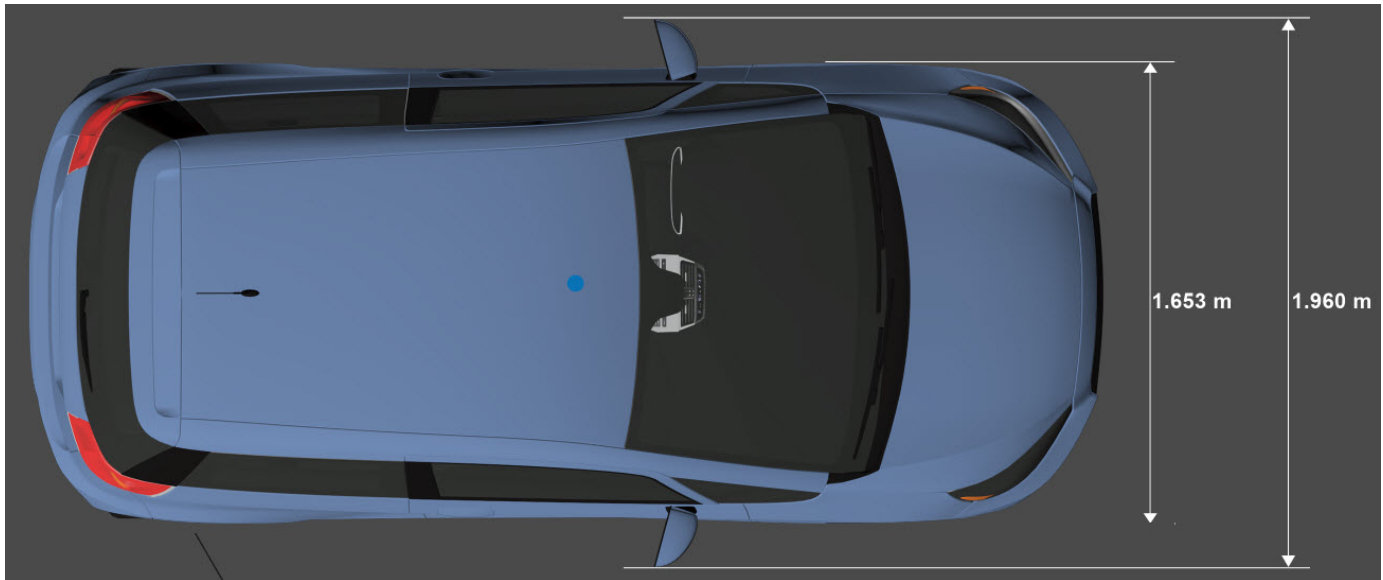

Side view — Vehicle length, front overhang, and rear overhang dimensions diagram

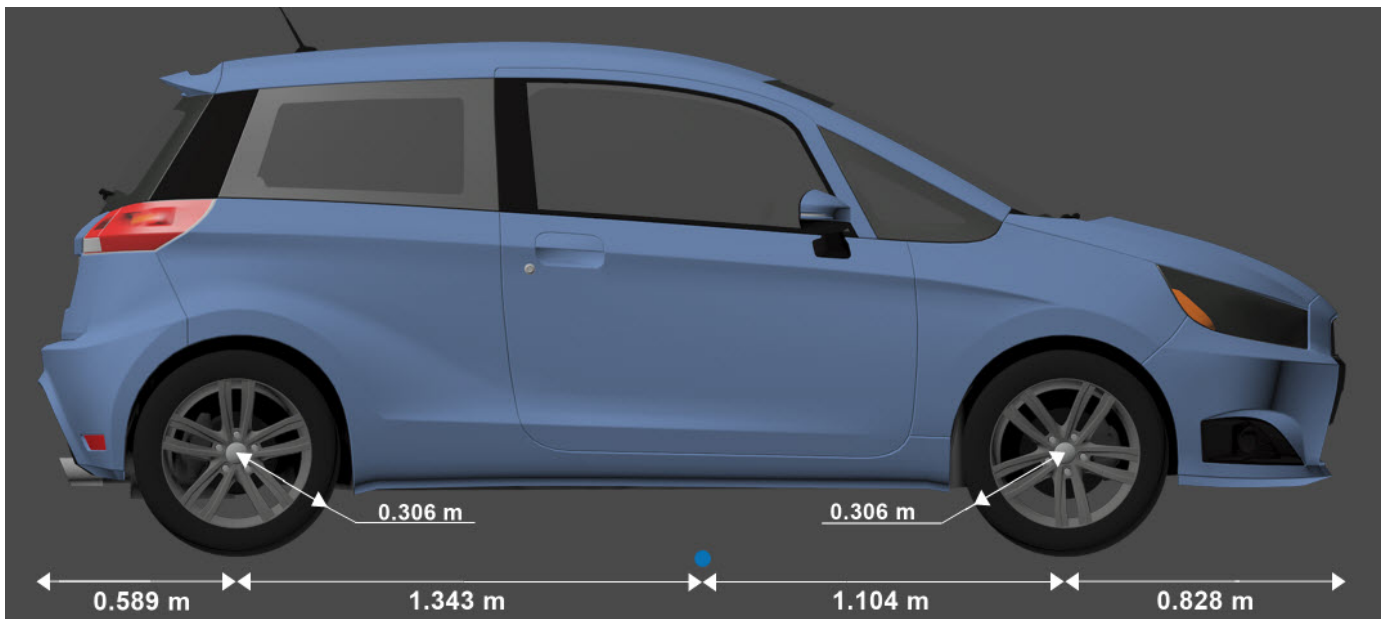

Front view — Tire width and front axle dimensions diagram

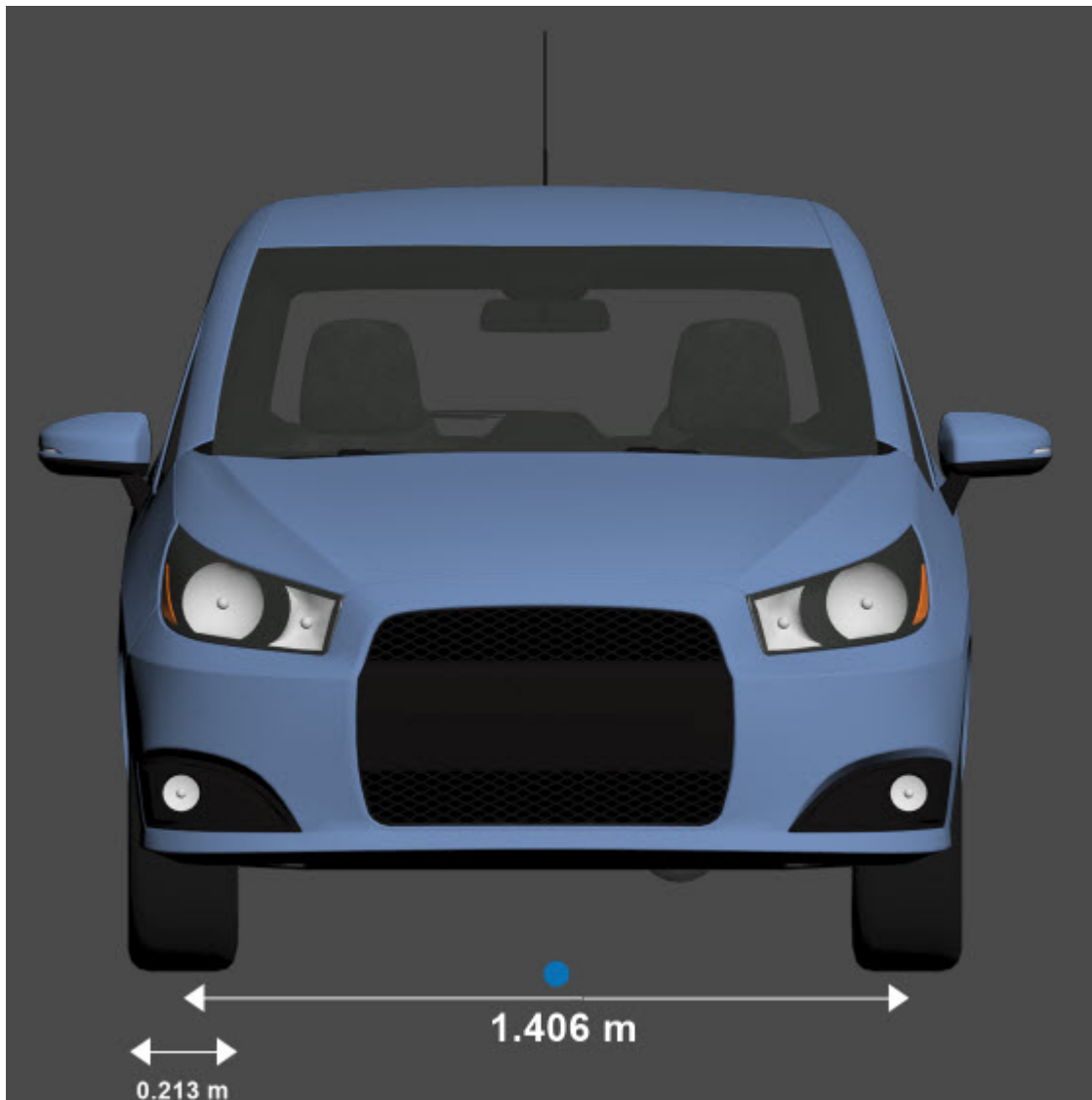

Rear view – Vehicle height and rear axle dimensions diagram

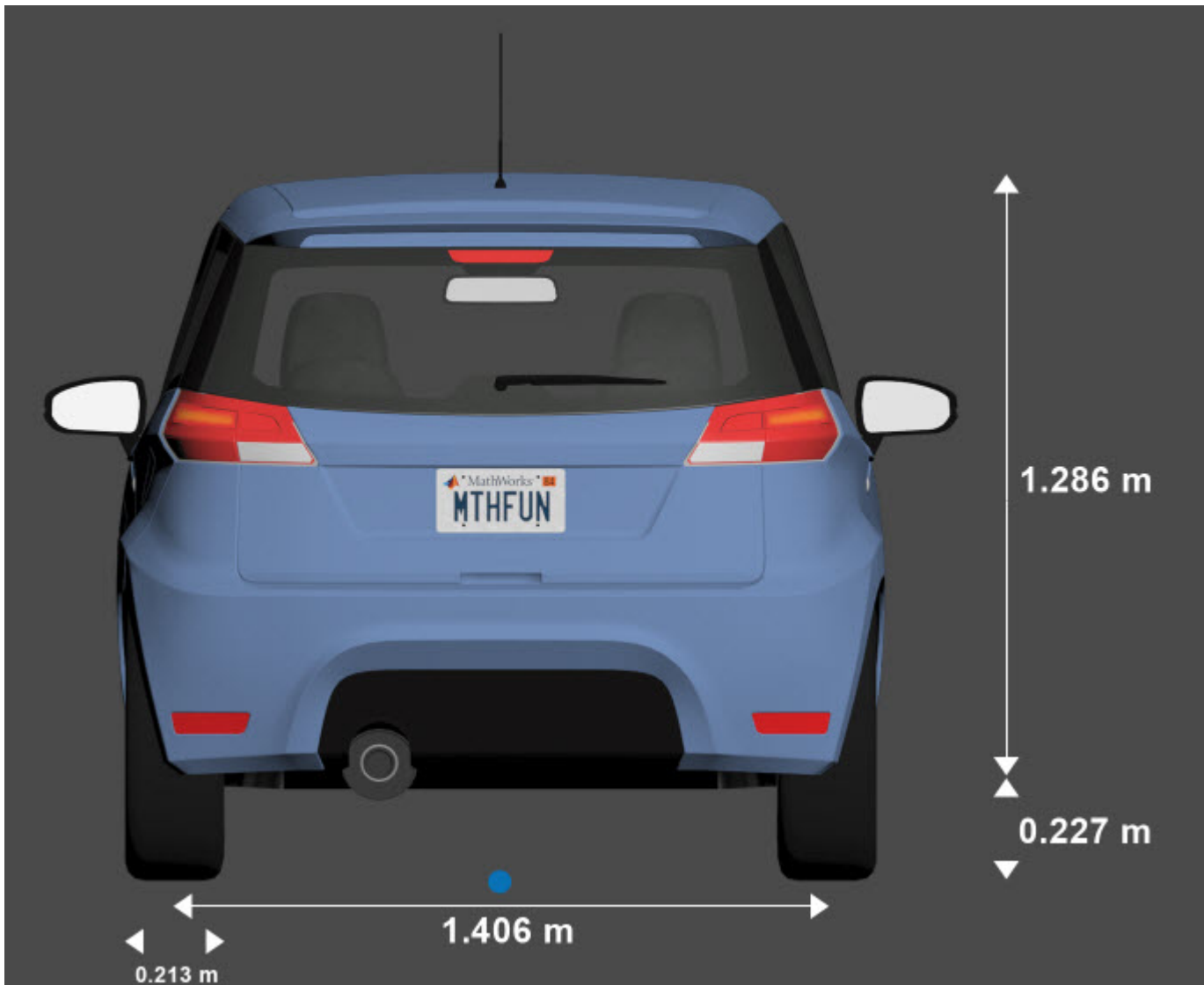

Sensor Mounting Locations

In the 3D simulation sensor blocks, use the **Mounting location** parameter to mount sensors at predefined locations on the vehicle. The table shows the *X*, *Y*, and *Z* positions of the mounting locations relative to the vehicle origin. These locations are in the vehicle coordinate system, where:

- The *X*-axis points forward from the vehicle.
- The *Y*-axis points to the left of the vehicle, as viewed when facing forward.
- The *Z*-axis points up from the ground.

Hatchback – Sensor Locations Relative to Vehicle Origin

Mounting Location	X (m)	Y (m)	Z (m)
Front bumper	1.93	0	0.51
Rear bumper	-1.93	0	0.51
Right mirror	0.43	-0.84	1.01
Left mirror	0.43	0.84	1.01
Rearview mirror	0.32	0	1.27
Hood center	1.44	0	1.01
Roof center	0	0	1.57

Specify Hatchback Vehicle Dimensions

When simulating a path planner in the 3D environment, the path planner must use a vehicle whose dimensions are consistent with one used in the 3D environment. To make these dimensions consistent, you can use a `vehicleDimensions` object.

Specify the dimensions of a Hatchback vehicle in a `vehicleDimensions` object. Units are in meters. For an example that uses this object in a path planner, see “Visualize Automated Parking Valet Using Unreal Engine Simulation”.

```
centerToFront = 1.104;
centerToRear = 1.343;
frontOverhang = 0.828;
rearOverhang = 0.589;
vehicleWidth = 1.653;
vehicleHeight = 1.513;
vehicleLength = centerToFront + centerToRear + frontOverhang + rearOverhang;

hatchbackDims = vehicleDimensions(vehicleLength,vehicleWidth,vehicleHeight, ...
    'FrontOverhang',frontOverhang,'RearOverhang',rearOverhang)

hatchbackDims =
    vehicleDimensions with properties:

        Length: 3.8640
        Width: 1.6530
        Height: 1.5130
        Wheelbase: 2.4470
        RearOverhang: 0.5890
        FrontOverhang: 0.8280
        WorldUnits: 'meters'
```

See Also

Box Truck | Small Pickup Truck | Sport Utility Vehicle | Sedan | Muscle Car

Topics

“Unreal Engine Simulation for Automated Driving”

“Coordinate Systems in Automated Driving Toolbox”

Muscle Car

Muscle car vehicle dimensions

Description

Muscle Car is one of the vehicles that you can use within the 3D simulation environment. This environment is rendered using the Unreal Engine from Epic Games. The following diagram provides the dimensions of this vehicle. The height dimensions are with respect to the vertical ground plane. The length and width dimensions are with respect to the origin of the vehicle in the vehicle coordinate system. The origin is on the ground, at the geometric center of the vehicle. For more detailed views of these diagrams, see the **Dimensions** section.

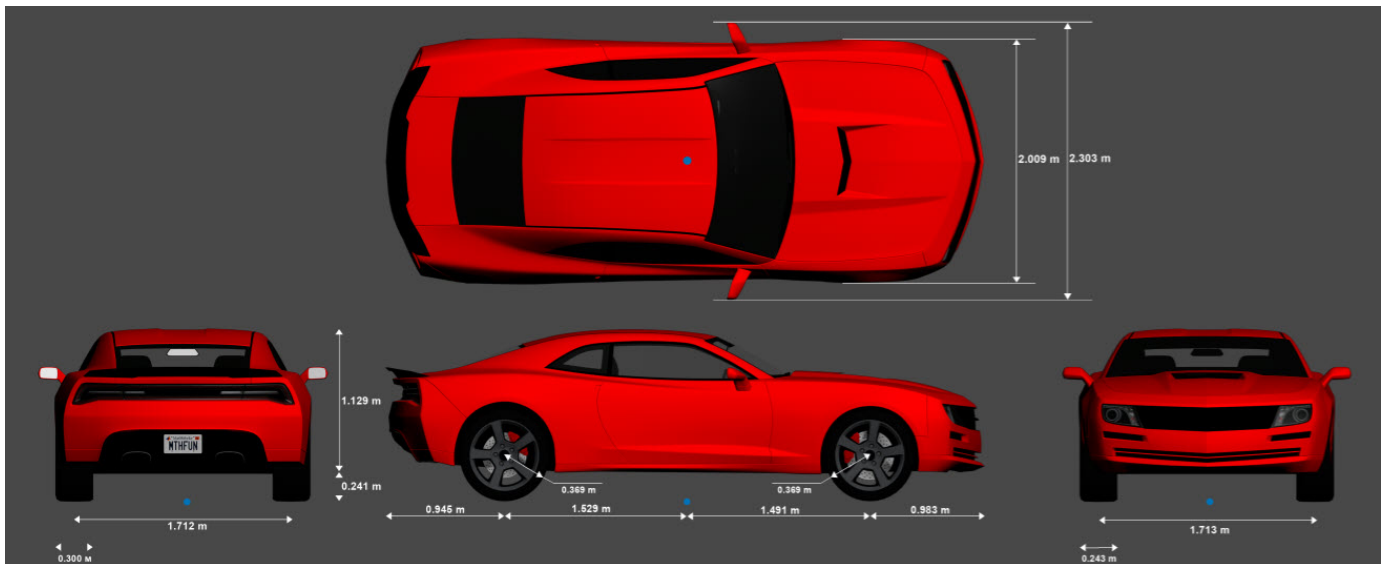

To add this type of vehicle to the 3D simulation environment:

- 1 Add a Simulation 3D Vehicle with Ground Following block to your Simulink model.
- 2 In the block, set the **Type** parameter to **Muscle car**.

Dimensions

Top-down view — Vehicle width dimensions diagram

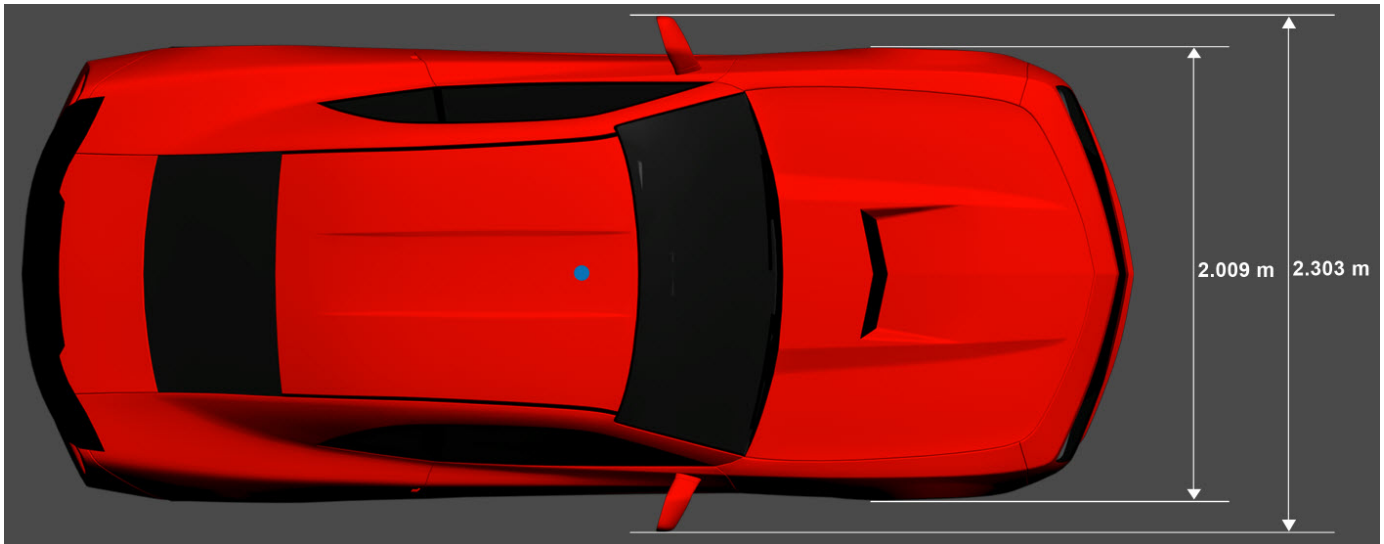

Side view — Vehicle length, front overhang, and rear overhang dimensions diagram

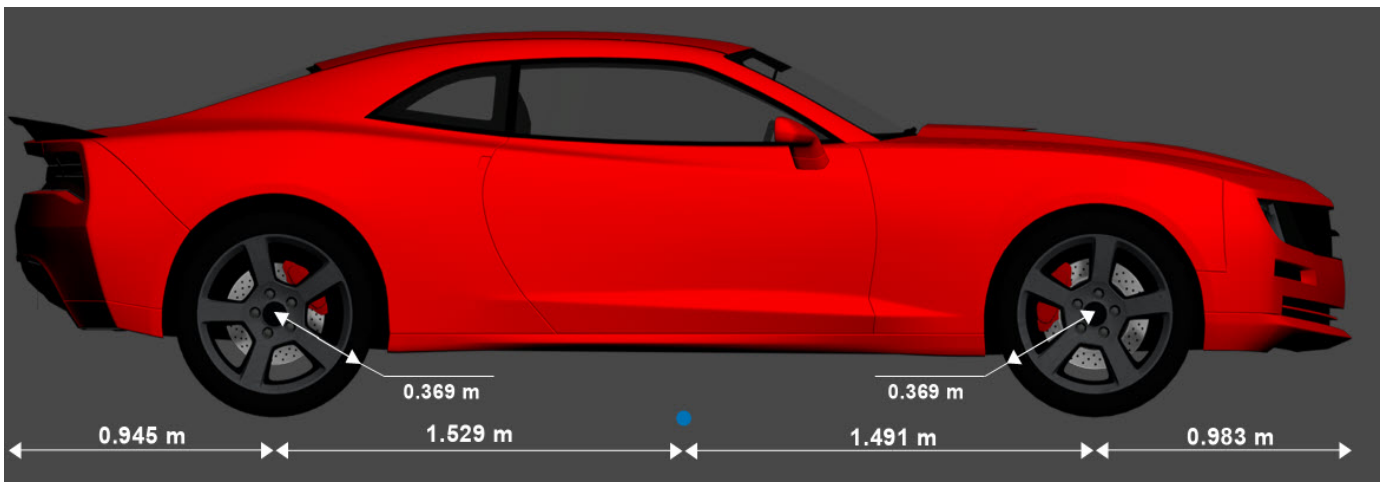

Front view — Tire width and front axle dimensions diagram

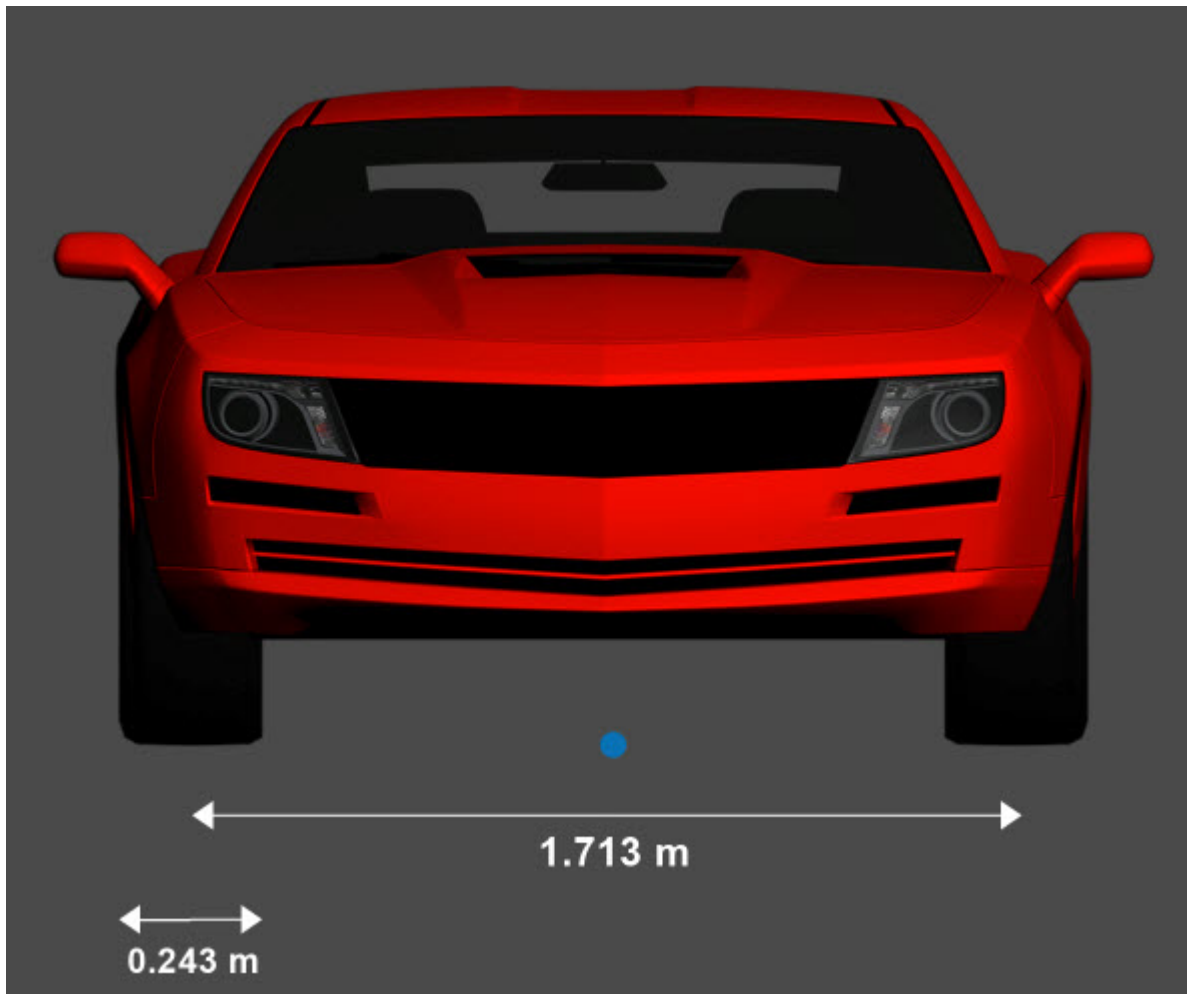

Rear view — Vehicle height and rear axle dimensions diagram

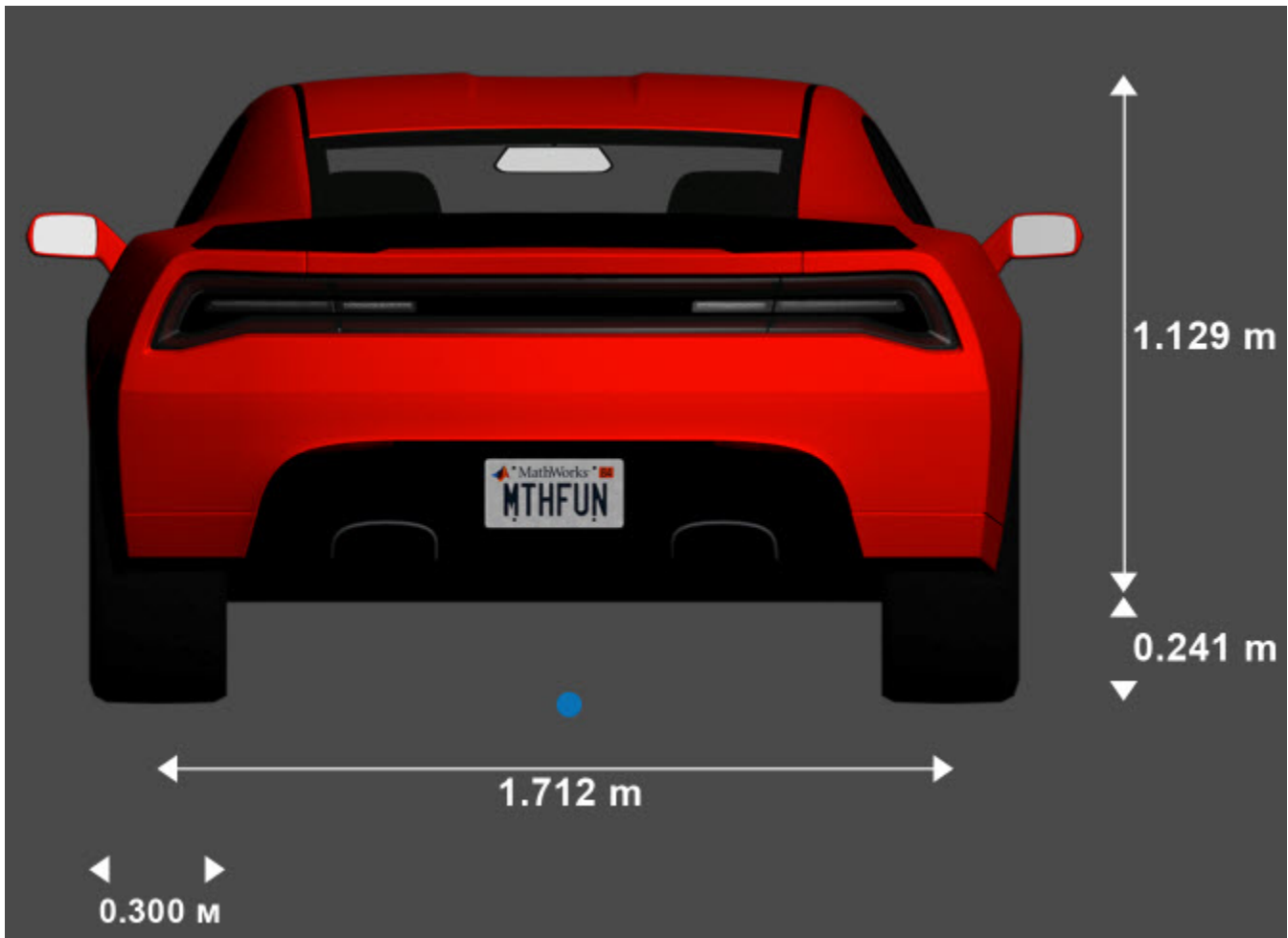

Sensor Mounting Locations

In the 3D simulation sensor blocks, use the **Mounting location** parameter to mount sensors at predefined locations on the vehicle. The table shows the *X*, *Y*, and *Z* positions of the mounting locations relative to the vehicle origin. These locations are in the vehicle coordinate system, where:

- The *X*-axis points forward from the vehicle.
- The *Y*-axis points to the left of the vehicle, as viewed when facing forward.
- The *Z*-axis points up from the ground.

Muscle Car – Sensor Locations Relative to Vehicle Origin

Mounting Location	X (m)	Y (m)	Z (m)
Front bumper	2.47	0	0.45
Rear bumper	-2.47	0	0.45
Right mirror	0.43	-1.08	1.01
Left mirror	0.43	1.08	1.01
Rearview mirror	0.32	0	1.20
Hood center	1.28	0	1.14
Roof center	-0.25	0	1.58

Specify Muscle Car Vehicle Dimensions

When simulating a path planner in the 3D environment, the path planner must use a vehicle whose dimensions are consistent with one used in the 3D environment. To make these dimensions consistent, you can use a `vehicleDimensions` object.

Specify the dimensions of a Muscle Car vehicle in a `vehicleDimensions` object. Units are in meters. For an example that uses this object in a path planner, see “Visualize Automated Parking Valet Using Unreal Engine Simulation”.

```
centerToFront = 1.491;
centerToRear = 1.529;
frontOverhang = 0.983;
rearOverhang = 0.945;
vehicleWidth = 2.009;
vehicleHeight = 1.370;
vehicleLength = centerToFront + centerToRear + frontOverhang + rearOverhang;

muscleCarDims = vehicleDimensions(vehicleLength,vehicleWidth,vehicleHeight, ...
    'FrontOverhang',frontOverhang,'RearOverhang',rearOverhang)

muscleCarDims =
    vehicleDimensions with properties:

        Length: 4.9480
        Width: 2.0090
        Height: 1.3700
        Wheelbase: 3.0200
        RearOverhang: 0.9450
        FrontOverhang: 0.9830
        WorldUnits: 'meters'
```

See Also

Box Truck | Small Pickup Truck | Sport Utility Vehicle | Sedan | Hatchback

Topics

“Unreal Engine Simulation for Automated Driving”

“Coordinate Systems for Unreal Engine Simulation in Automated Driving Toolbox”

Sedan

Sedan vehicle dimensions

Description

Sedan is one of the vehicles that you can use within the 3D simulation environment. This environment is rendered using the Unreal Engine from Epic Games. The diagram provides the dimensions of this vehicle. The height dimensions are with respect to the vertical ground plane. The length and width dimensions are with respect to the origin of the vehicle in the vehicle coordinate system. The origin is on the ground, at the geometric center of the vehicle. For more detailed views of these diagrams, see the **Dimensions** section.

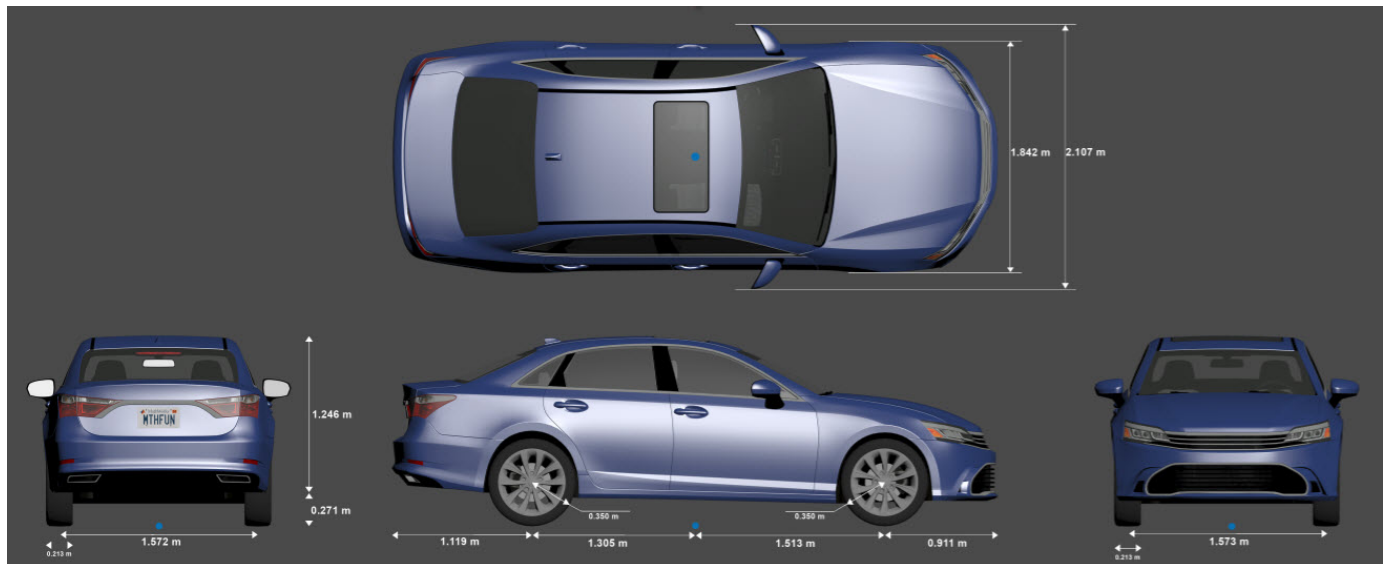

To add this type of vehicle to the 3D simulation environment:

- 1 Add a Simulation 3D Vehicle with Ground Following block to your Simulink model.
- 2 In the block, set the **Type** parameter to Sedan.

Dimensions

Top-down view — Vehicle width dimensions diagram

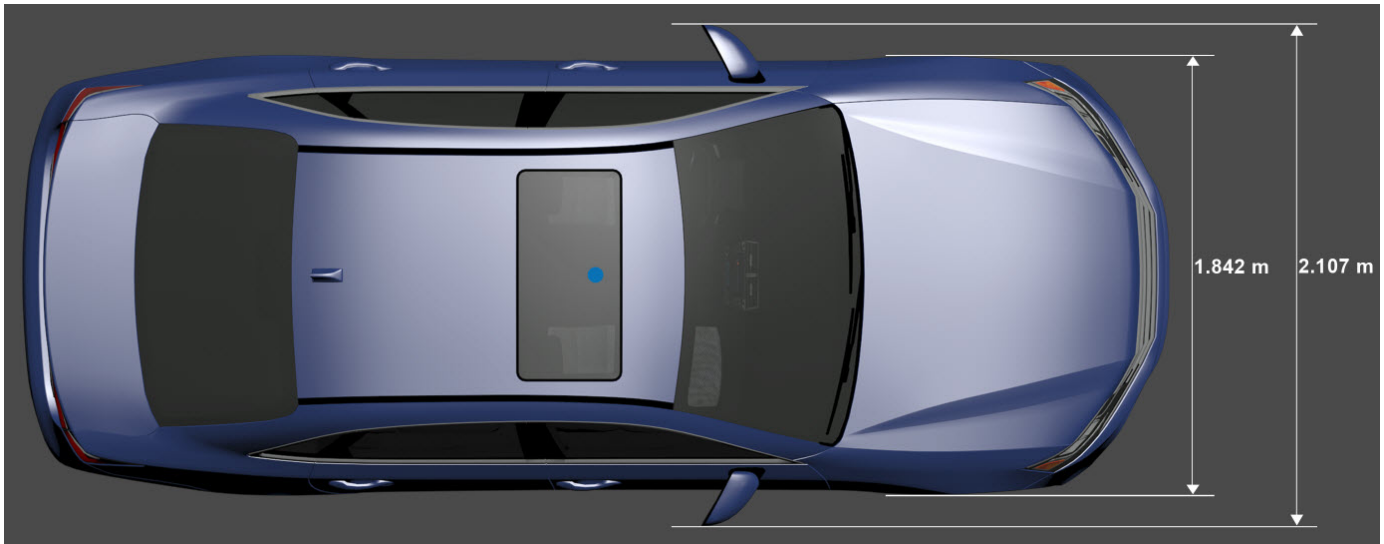

Side view — Vehicle length, front overhang, and rear overhang dimensions diagram

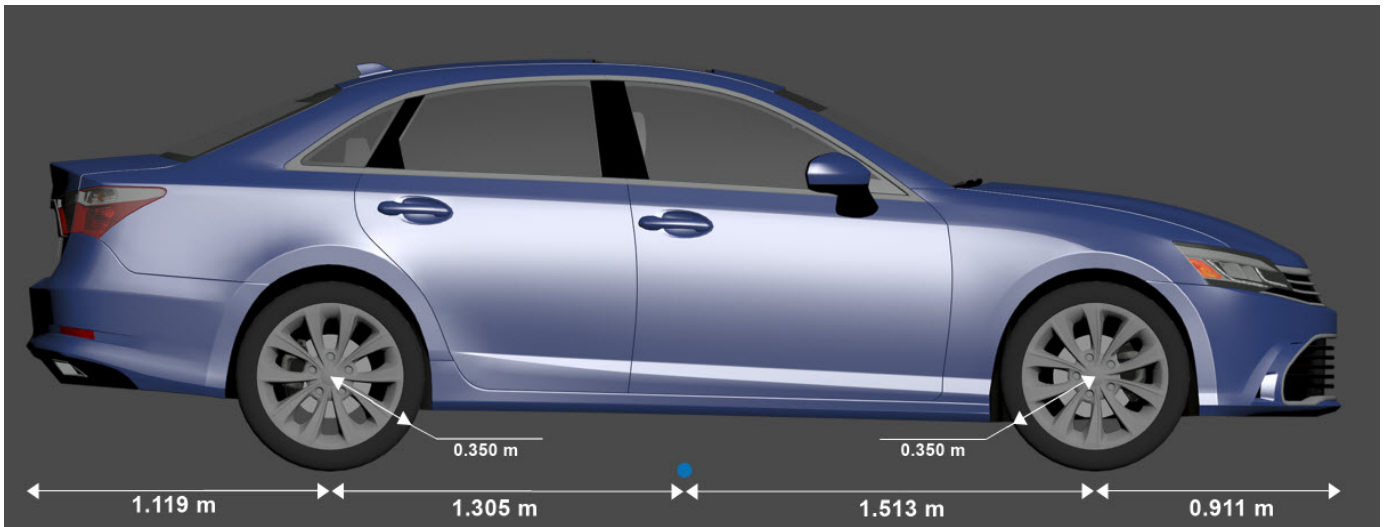

Front view — Tire width and front axle dimensions diagram

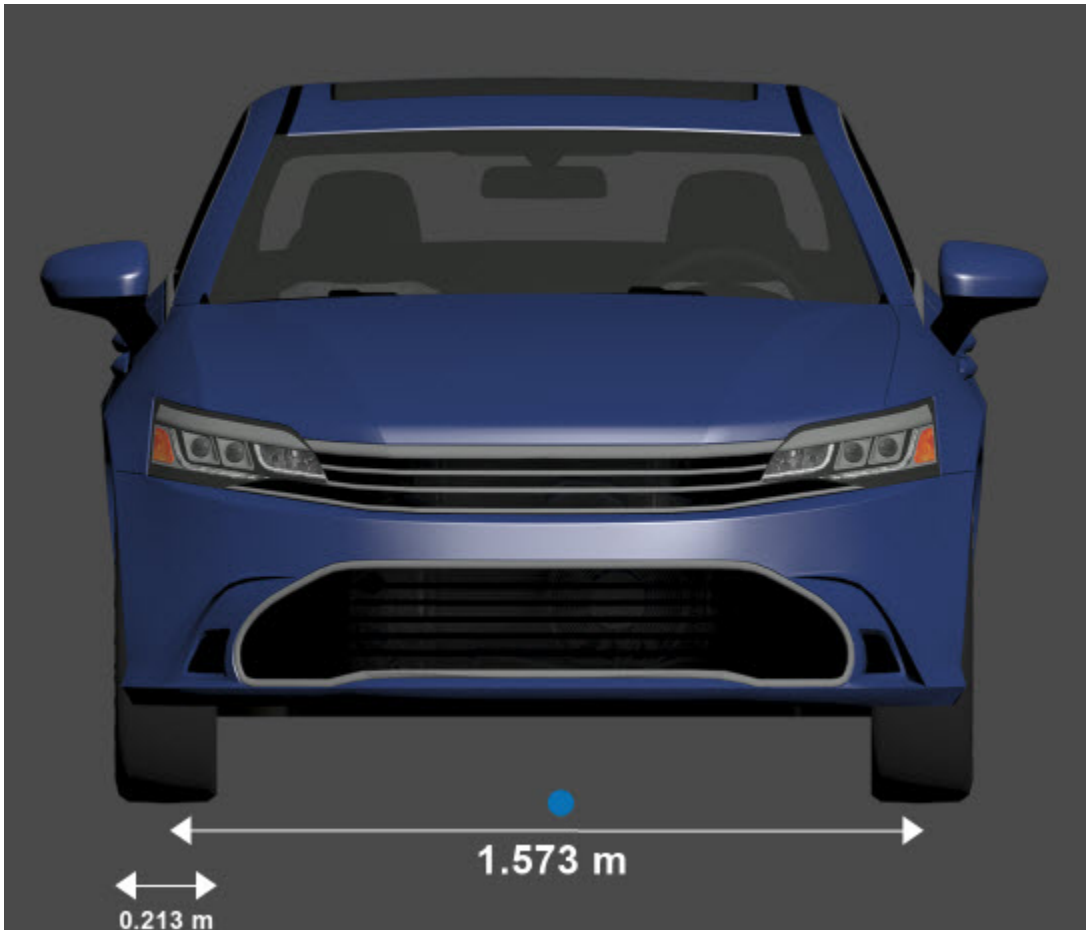

Rear view — Vehicle height and rear axle dimensions diagram

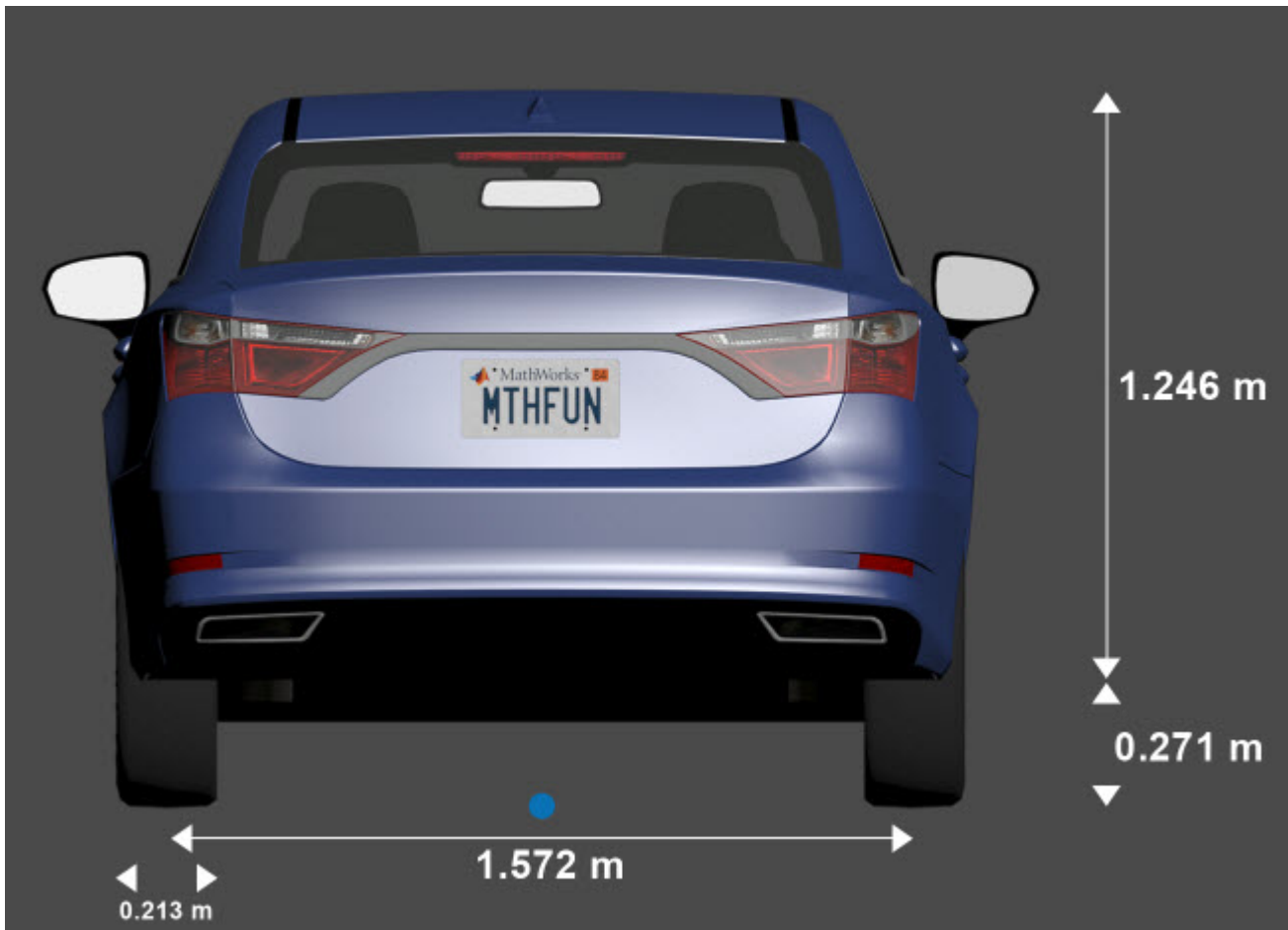

Sensor Mounting Locations

In the 3D simulation sensor blocks, use the **Mounting location** parameter to mount sensors at predefined locations on the vehicle. The table shows the *X*, *Y*, and *Z* positions of the mounting locations relative to the vehicle origin. These locations are in the vehicle coordinate system, where:

- The *X*-axis points forward from the vehicle.
- The *Y*-axis points to the left of the vehicle, as viewed when facing forward.
- The *Z*-axis points up from the ground.

Sedan — Sensor Locations Relative to Vehicle Origin

Mounting Location	X (m)	Y (m)	Z (m)
Front bumper	2.42	0	0.51
Rear bumper	-2.42	0	0.51
Right mirror	0.59	-0.94	1.09
Left mirror	0.59	0.94	1.09
Rearview mirror	0.43	0	1.31
Hood center	1.46	0	1.11
Roof center	-0.45	0	1.69

Specify Sedan Vehicle Dimensions

When simulating a path planner in the 3D environment, the path planner must use a vehicle whose dimensions are consistent with one used in the 3D environment. To make these dimensions consistent, you can use a `vehicleDimensions` object.

Specify the dimensions of a Sedan vehicle in a `vehicleDimensions` object. Units are in meters. For an example that uses this object in a path planner, see “Visualize Automated Parking Valet Using Unreal Engine Simulation”.

```
centerToFront = 1.513;
centerToRear = 1.305;
frontOverhang = 0.911;
rearOverhang = 1.119;
vehicleWidth = 1.842;
vehicleHeight = 1.517;
vehicleLength = centerToFront + centerToRear + frontOverhang + rearOverhang;

sedanDims = vehicleDimensions(vehicleLength,vehicleWidth,vehicleHeight, ...
    'FrontOverhang',frontOverhang,'RearOverhang',rearOverhang)

sedanDims =
    vehicleDimensions with properties:
        Length: 4.8480
        Width: 1.8420
        Height: 1.5170
        Wheelbase: 2.8180
        RearOverhang: 1.1190
        FrontOverhang: 0.9110
        WorldUnits: 'meters'
```

See Also

Box Truck | **Small Pickup Truck** | **Sport Utility Vehicle** | **Hatchback** | **Muscle Car**

Topics

“Unreal Engine Simulation for Automated Driving”

“Coordinate Systems in Automated Driving Toolbox”

Sport Utility Vehicle

Sport utility vehicle dimensions

Description

Sport Utility Vehicle is one of the vehicles that you can use within the 3D simulation environment. This environment is rendered using the Unreal Engine from Epic Games. The following diagram provides the dimensions of this vehicle. The height dimensions are with respect to the vertical ground plane. The length and width dimensions are with respect to the origin of the vehicle in the vehicle coordinate system. The origin is on the ground, at the geometric center of the vehicle. For more detailed views of these diagrams, see the **Dimensions** section.



To add this type of vehicle to the 3D simulation environment:

- 1 Add a Simulation 3D Vehicle with Ground Following block to your Simulink model.
- 2 In the block, set the **Type** parameter to Sport utility vehicle.

Dimensions

Top-down view — Vehicle width dimensions diagram

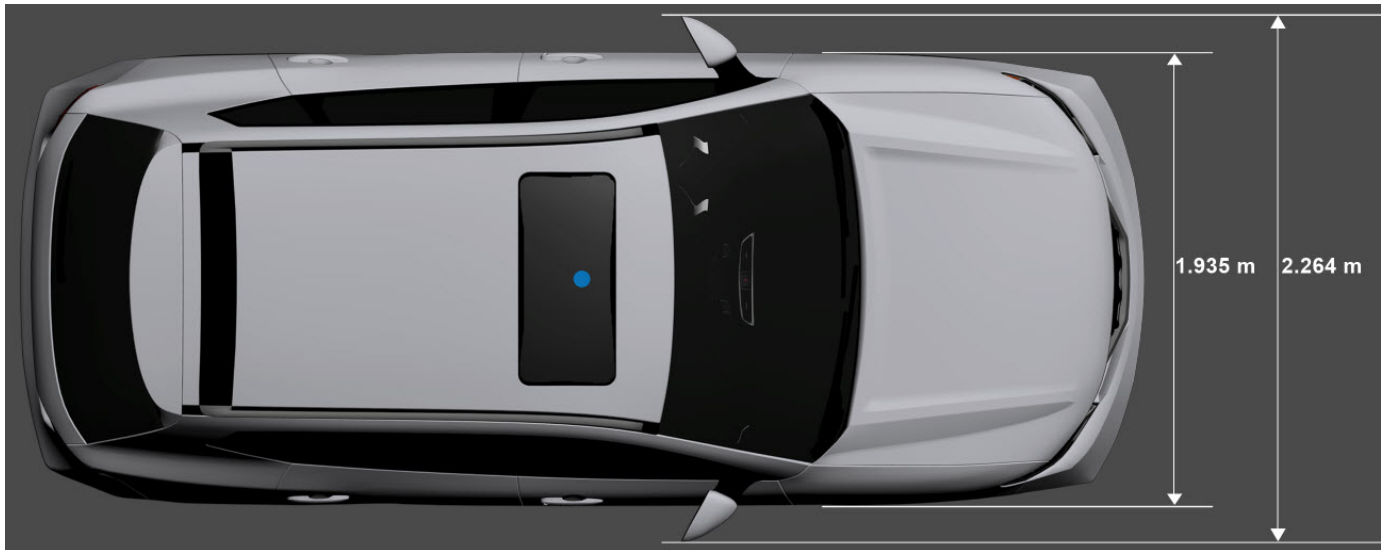

Side view — Vehicle length, front overhang, and rear overhang dimensions diagram

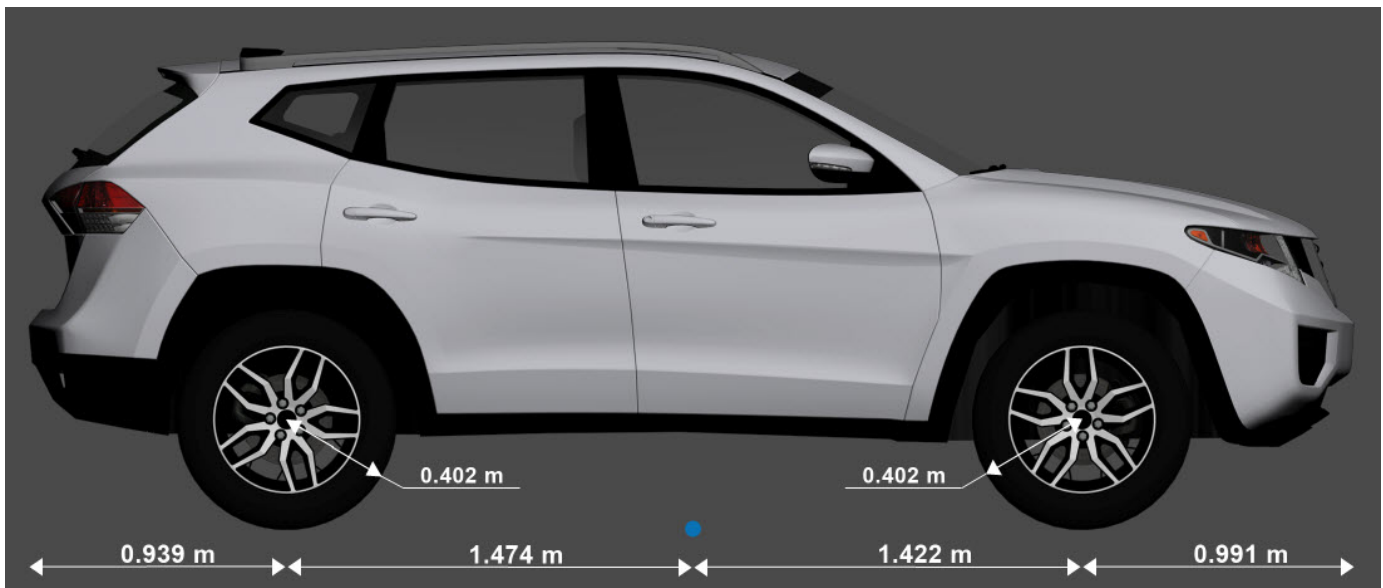

Front view — Tire width and front axle dimensions diagram

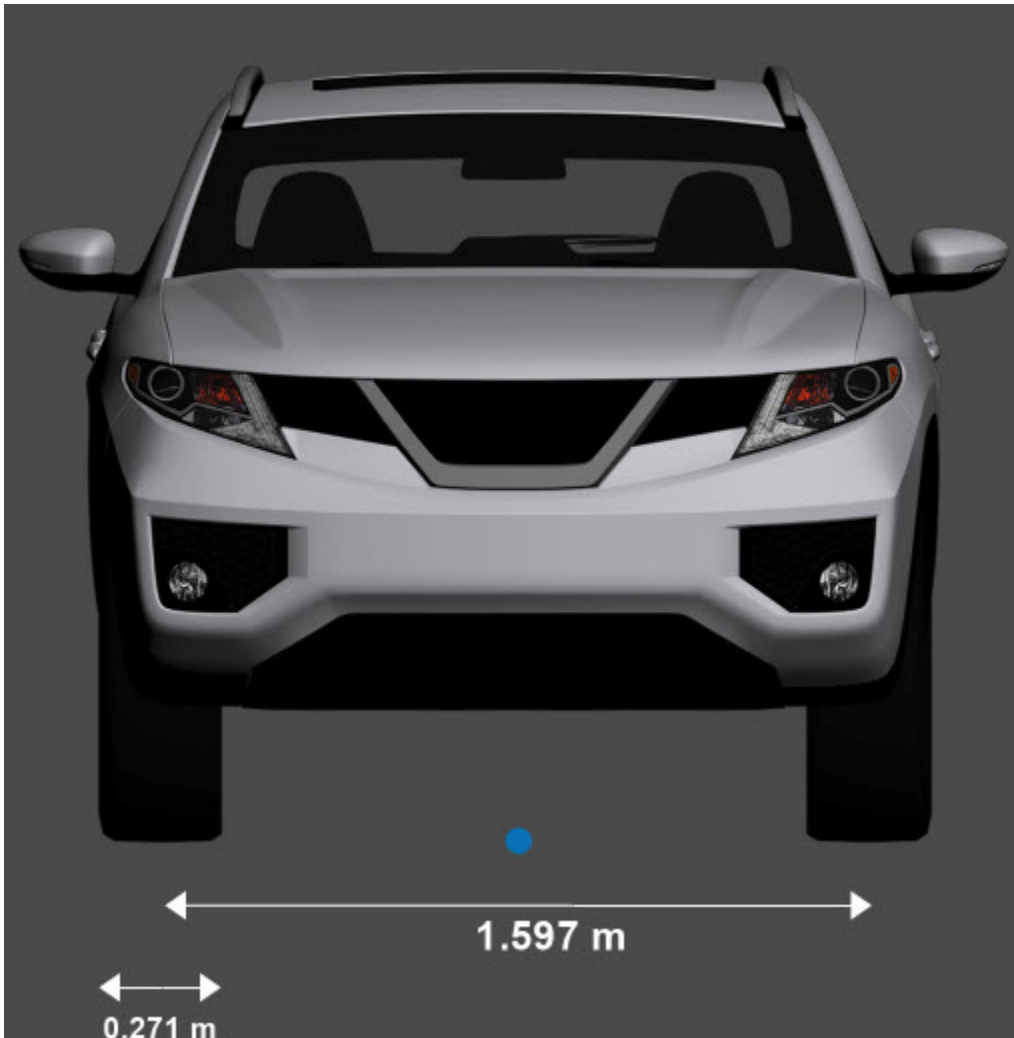

Rear view — Vehicle height and rear axle dimensions diagram

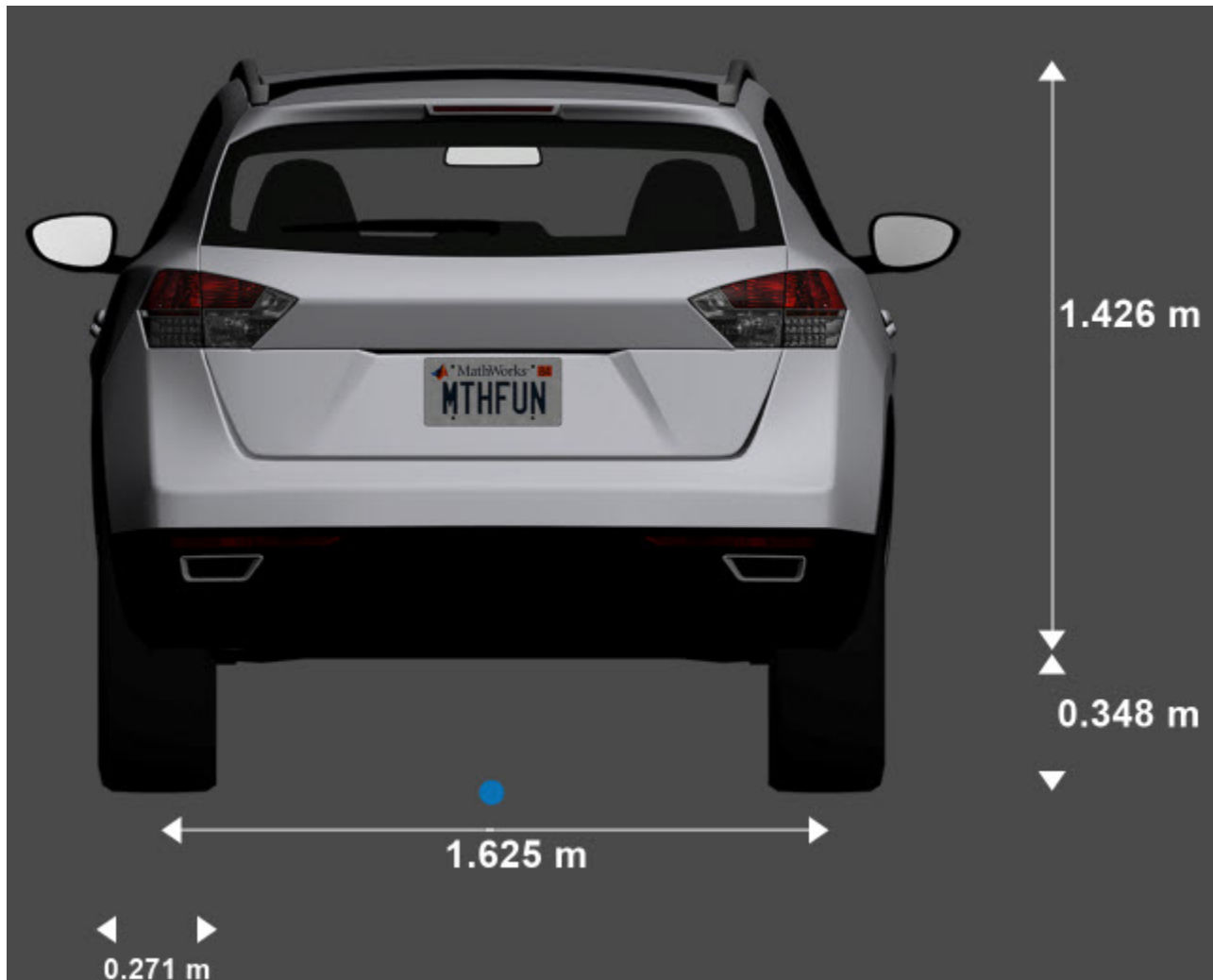

Sensor Mounting Locations

In the 3D simulation sensor blocks, use the **Mounting location** parameter to mount sensors at predefined locations on the vehicle. The table shows the *X*, *Y*, and *Z* positions of the mounting locations relative to the vehicle origin. These locations are in the vehicle coordinate system, where:

- The *X*-axis points forward from the vehicle.
- The *Y*-axis points to the left of the vehicle, as viewed when facing forward.
- The *Z*-axis points up from the ground.

Sport Utility Vehicle – Sensor Locations Relative to Vehicle Origin

Mounting Location	X (m)	Y (m)	Z (m)
Front bumper	2.42	0	0.51
Rear bumper	-2.42	0	0.51
Right mirror	0.60	-1	1.35
Left mirror	0.60	1	1.35
Rearview mirror	0.39	0	1.55
Hood center	1.58	0	1.39
Roof center	-0.56	0	2

Specify Sport Utility Vehicle Dimensions

When simulating a path planner in the 3D environment, the path planner must use a vehicle whose dimensions are consistent with one used in the 3D environment. To make these dimensions consistent, you can use a `vehicleDimensions` object.

Specify the dimensions of a Sport Utility Vehicle in a `vehicleDimensions` object. Units are in meters. For an example that uses this object in a path planner, see “Visualize Automated Parking Valet Using Unreal Engine Simulation”.

```
centerToFront = 1.422;
centerToRear = 1.474;
frontOverhang = 0.991;
rearOverhang = 0.939;
vehicleWidth = 1.935;
vehicleHeight = 1.774;
vehicleLength = centerToFront + centerToRear + frontOverhang + rearOverhang;
```

```
suvDims = vehicleDimensions(vehicleLength,vehicleWidth,vehicleHeight, ...
    'FrontOverhang',frontOverhang,'RearOverhang',rearOverhang)
```

```
suvDims =
    vehicleDimensions with properties:
```

```
    Length: 4.8260
    Width: 1.9350
    Height: 1.7740
    Wheelbase: 2.8960
    RearOverhang: 0.9390
    FrontOverhang: 0.9910
    WorldUnits: 'meters'
```

See Also

Box Truck | Small Pickup Truck | Hatchback | Sedan | Muscle Car

Topics

“Unreal Engine Simulation for Automated Driving”

“Coordinate Systems in Automated Driving Toolbox”

Small Pickup Truck

Small pickup truck vehicle dimensions

Description

Small Pickup Truck is one of the vehicles that you can use within the 3D simulation environment. This environment is rendered using the Unreal Engine from Epic Games. The following diagram provides the dimensions of this vehicle. The height dimensions are with respect to the vertical ground plane. The length and width dimensions are with respect to the origin of the vehicle in the vehicle coordinate system. The origin is on the ground, at the geometric center of the vehicle. For more detailed views of these diagrams, see the **Dimensions** section.

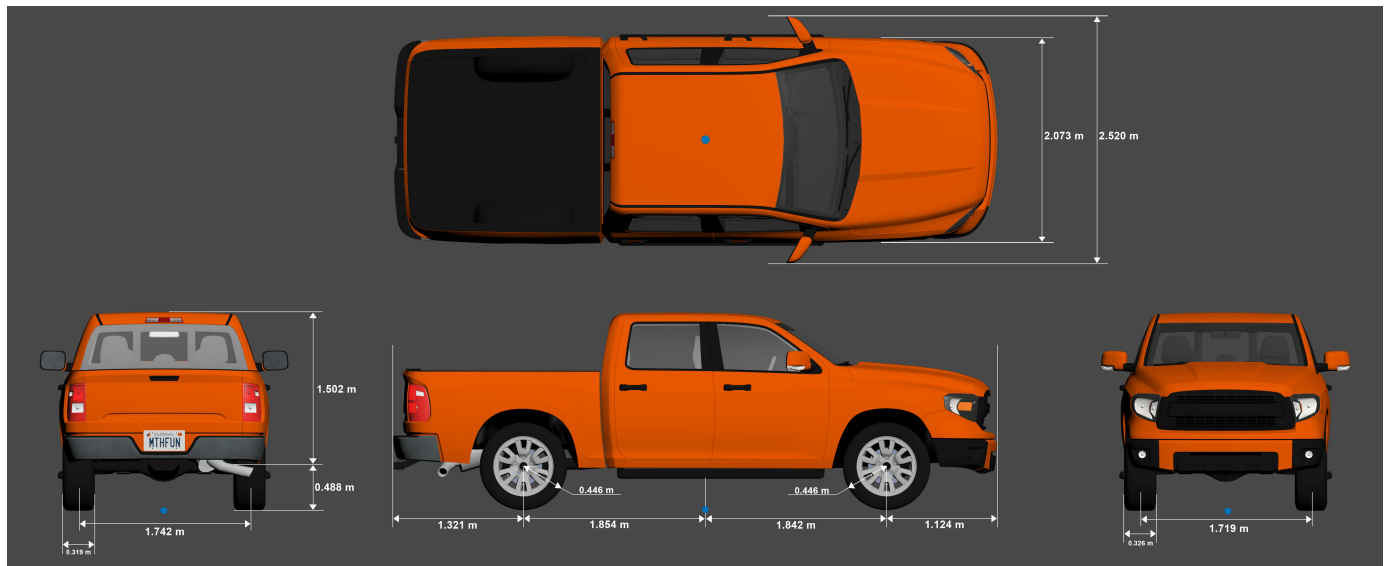

To add this type of vehicle to the 3D simulation environment:

- 1 Add a Simulation 3D Vehicle with Ground Following block to your Simulink model.
- 2 In the block, set the **Type** parameter to Small pickup truck.

Dimensions

Top-down view — Vehicle width dimensions diagram

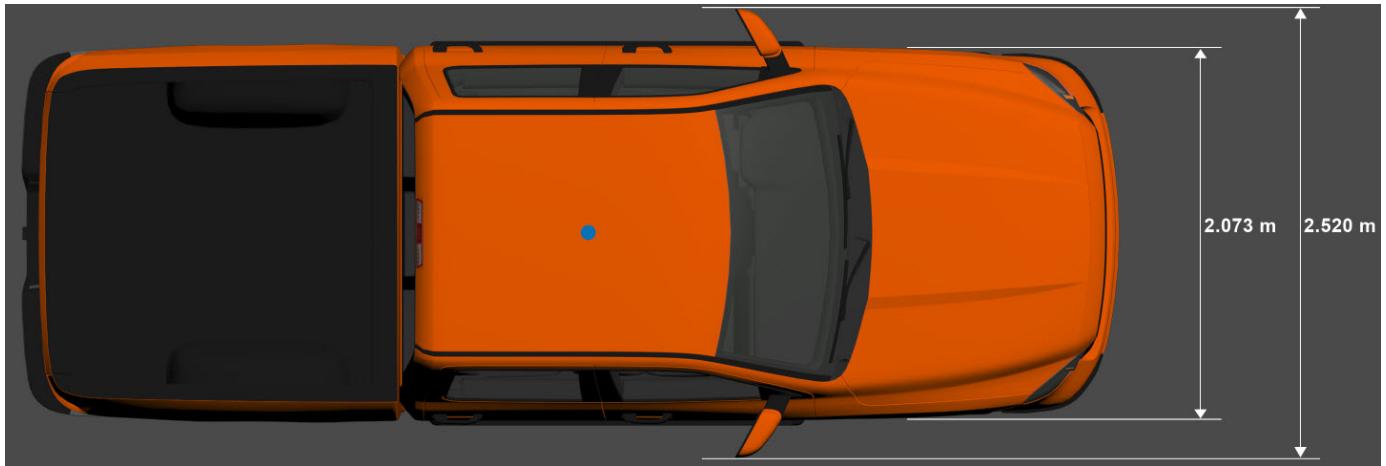

Side view — Vehicle length, front overhang, and rear overhang dimensions diagram

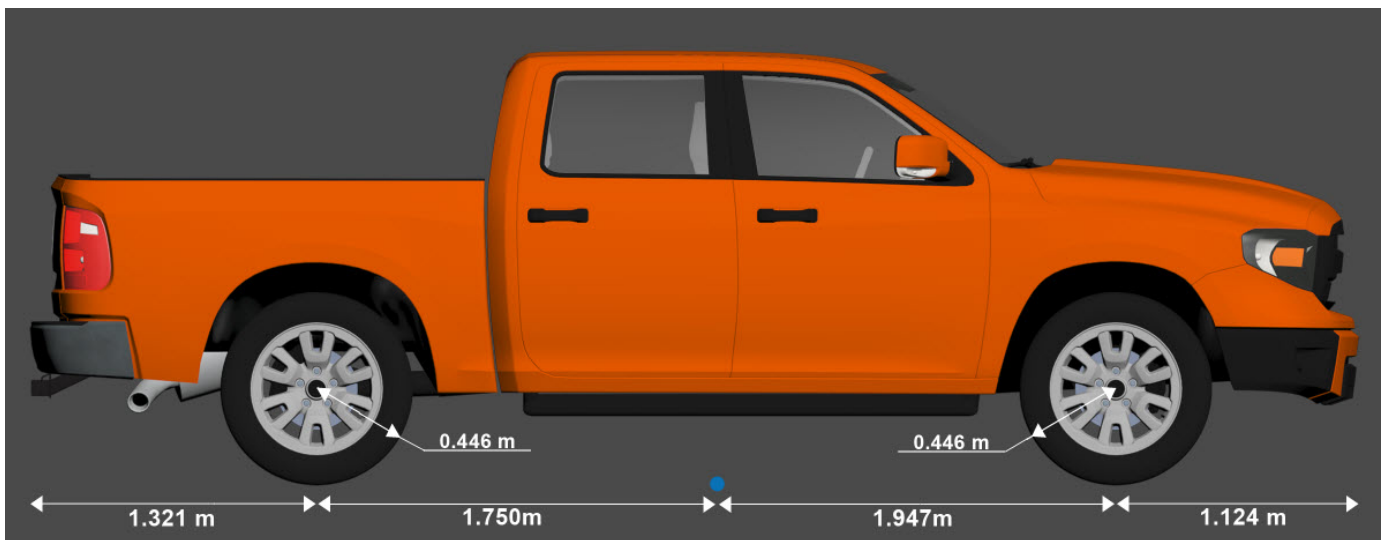

Front view — Tire width and front axle dimensions diagram

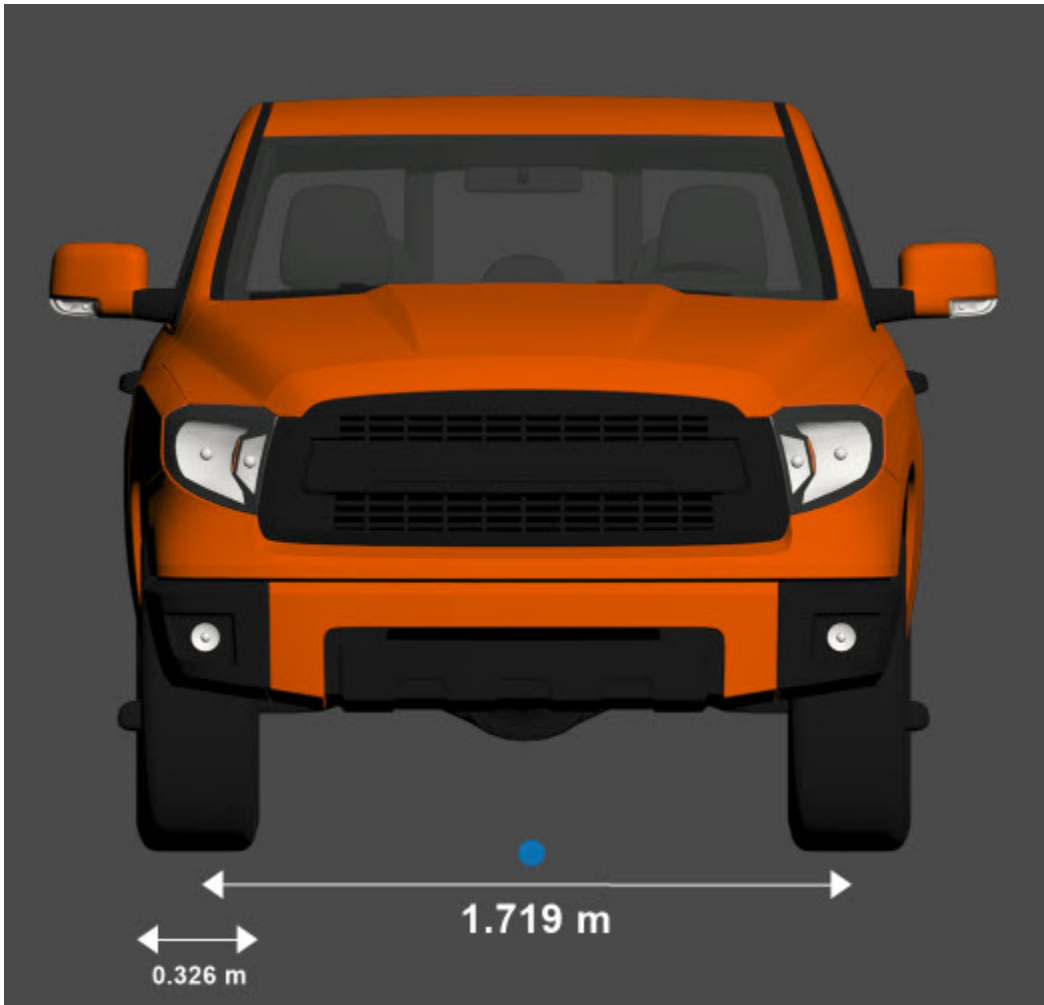

Rear view — Vehicle height and rear axle dimensions diagram

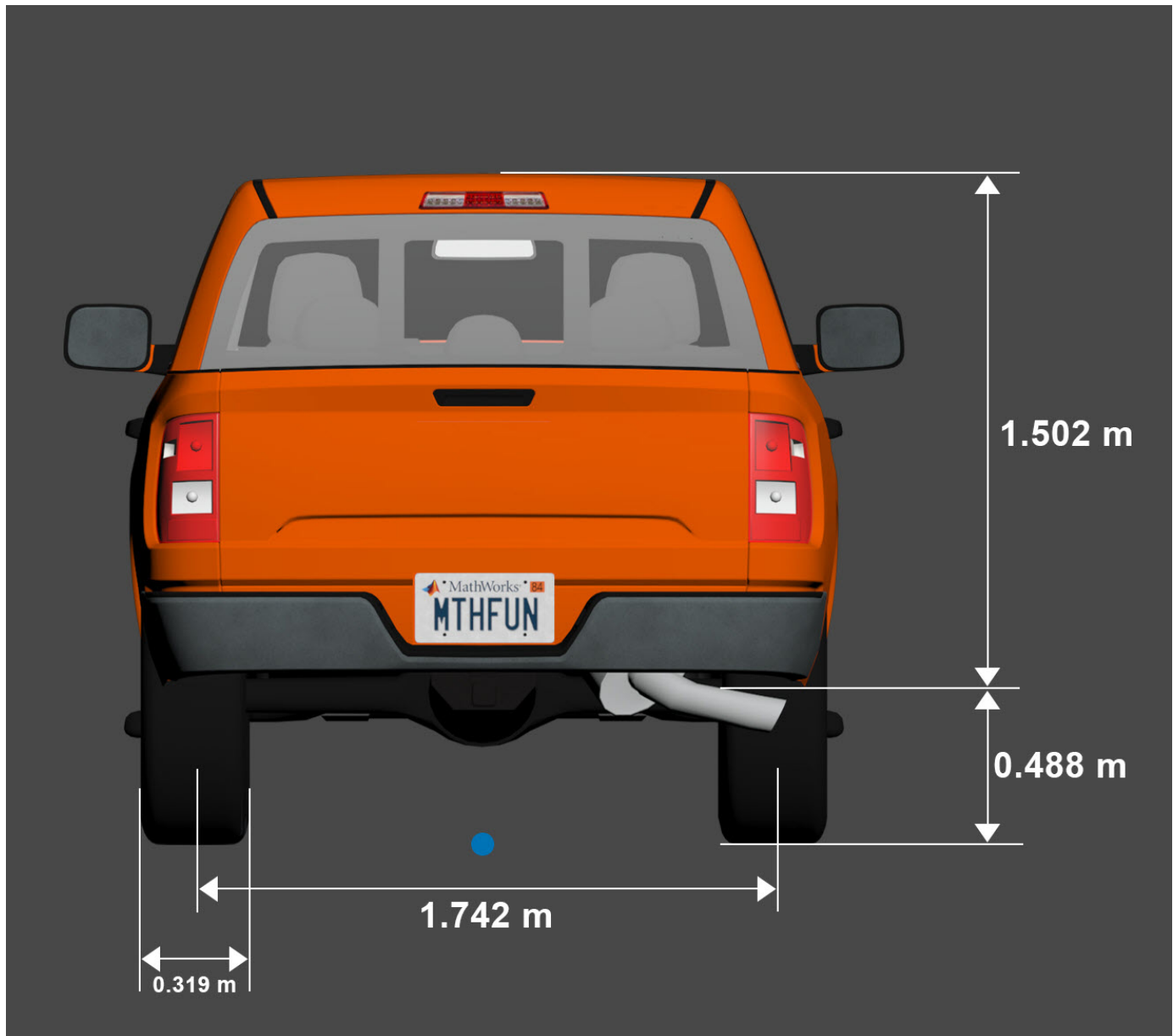

Sensor Mounting Locations

In the 3D simulation sensor blocks, use the **Mounting location** parameter to mount sensors at predefined locations on the vehicle. The table shows the X, Y, and Z positions of the mounting locations relative to the vehicle origin. These locations are in the vehicle coordinate system, where:

- The X-axis points forward from the vehicle.
- The Y-axis points to the left of the vehicle, as viewed when facing forward.
- The Z-axis points up from the ground.

Small Pickup Truck — Sensor Locations Relative to Vehicle Origin

Mounting Location	X (m)	Y (m)	Z (m)
Front bumper	3.07	0	0.51
Rear bumper	-3.07	0	0.51
Right mirror	1.10	-1.13	1.52
Left mirror	1.10	1.13	1.52
Rearview mirror	0.85	0	1.77
Hood center	2.22	0	1.59
Roof center	0	0	2.27

Specify Small Pickup Truck Vehicle Dimensions

When simulating a path planner in the 3D environment, the path planner must use a vehicle whose dimensions are consistent with one used in the 3D environment. To make these dimensions consistent, you can use a `vehicleDimensions` object.

Specify the dimensions of a Small Pickup Truck vehicle in a `vehicleDimensions` object. Units are in meters. For an example that uses this object in a path planner, see “Visualize Automated Parking Valet Using Unreal Engine Simulation”.

```
centerToFront = 1.947;
centerToRear = 1.750;
frontOverhang = 1.124;
rearOverhang = 1.321;
vehicleWidth = 2.073;
vehicleHeight = 1.990;
vehicleLength = centerToFront + centerToRear + frontOverhang + rearOverhang;

smallPickupTruckDims = vehicleDimensions(vehicleLength,vehicleWidth,vehicleHeight, ...
    'FrontOverhang',frontOverhang,'RearOverhang',rearOverhang)

smallPickupTruckDims =
    vehicleDimensions with properties:

        Length: 6.1420
        Width: 2.0730
        Height: 1.9900
        Wheelbase: 3.6970
        RearOverhang: 1.3210
        FrontOverhang: 1.1240
        WorldUnits: 'meters'
```

See Also

Box Truck | Hatchback | Sedan | Muscle Car | Sport Utility Vehicle

Topics

“Unreal Engine Simulation for Automated Driving”

“Coordinate Systems in Automated Driving Toolbox”

Box Truck

Box truck vehicle dimensions

Description

Box truck is one of the vehicles that you can use within the 3D simulation environment. This environment is rendered using the Unreal Engine from Epic Games. The following diagram provides the dimensions of this vehicle. The height dimensions are with respect to the vertical ground plane. The length and width dimensions are with respect to the origin of the vehicle in the vehicle coordinate system. The origin is on the ground, at the geometric center of the vehicle. For more detailed views of these diagrams, see the **Dimensions** section.

To add this type of vehicle to the 3D simulation environment:

- 1 Add a Simulation 3D Vehicle with Ground Following block to your Simulink model.
- 2 In this block, set the **Type** parameter to **Box truck**.

Dimensions

Top-down view — Vehicle width dimensions diagram

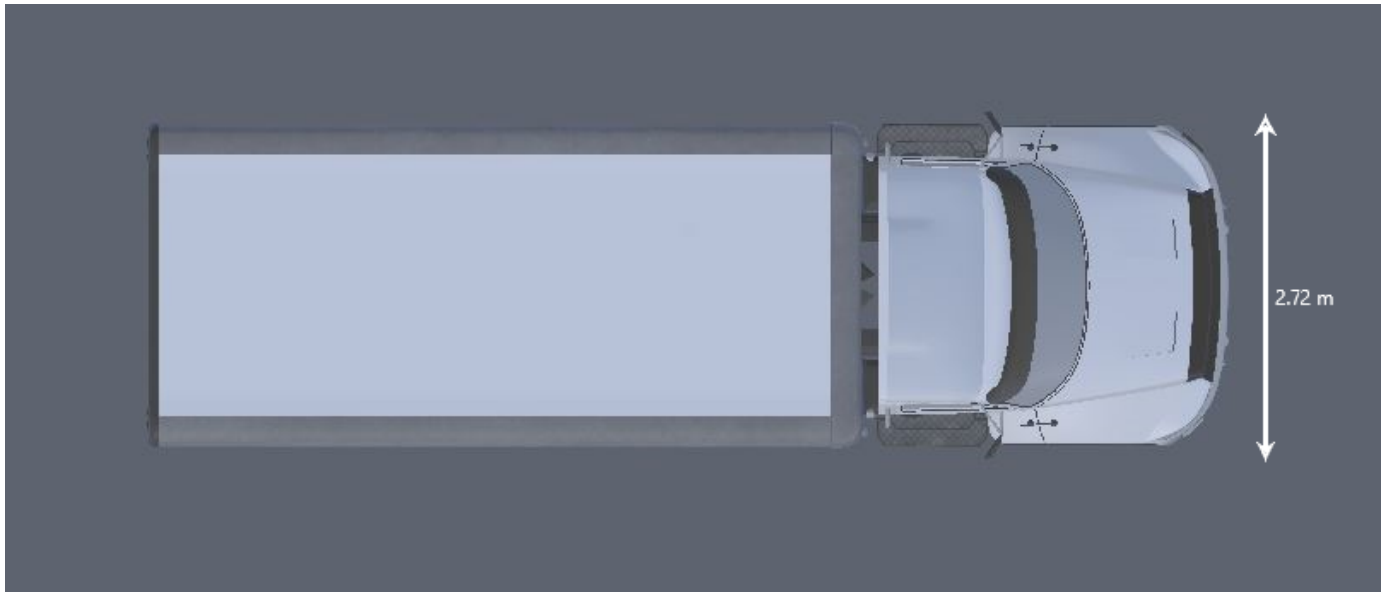

Side view — Vehicle length, front overhang, and rear overhang dimensions diagram

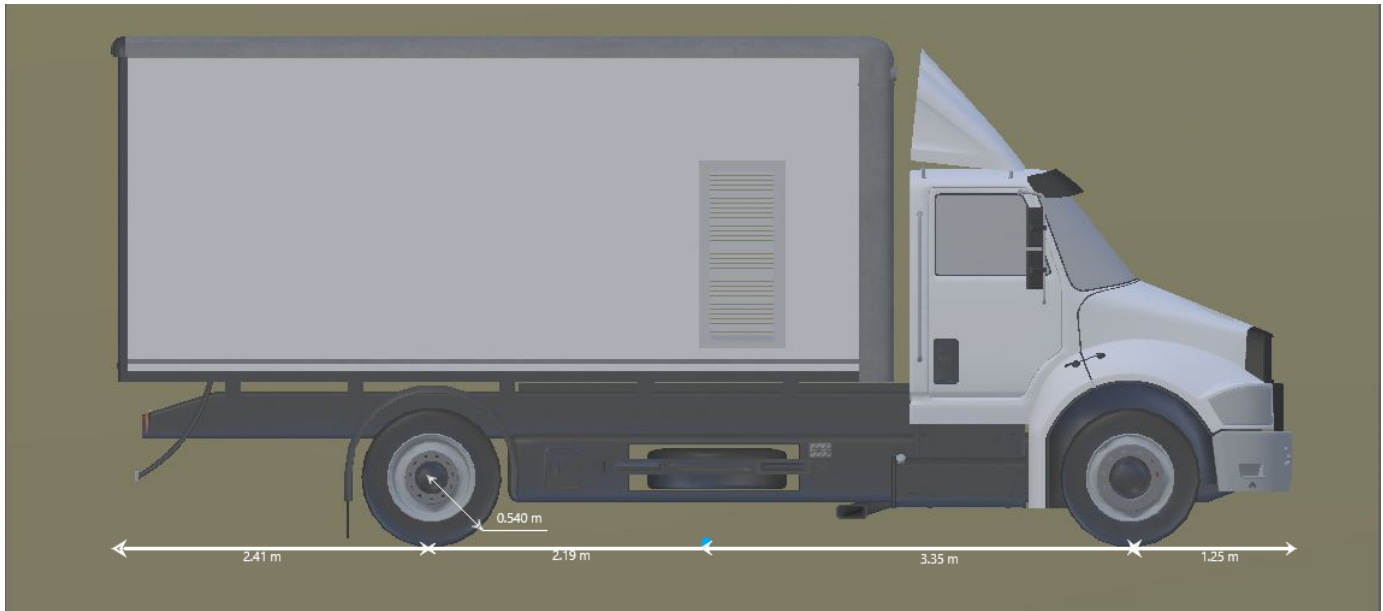

Front view — Tire width and front axle dimensions diagram

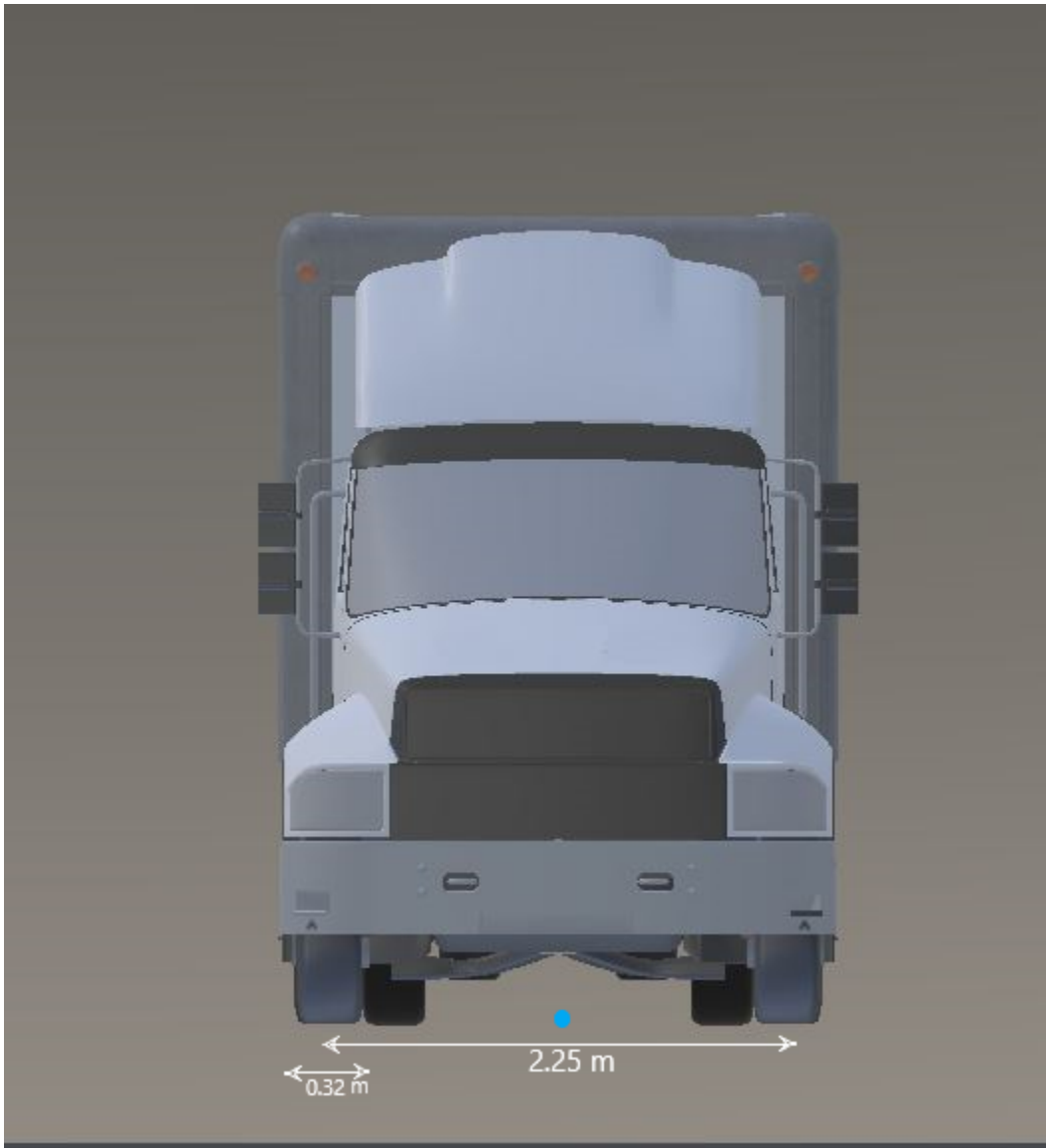

Rear view — Vehicle height and rear axle dimensions diagram



Sensor Mounting Locations

In the 3D simulation sensor blocks, use the **Mounting location** parameter to mount sensors at predefined locations on the vehicle. The table shows the X, Y, and Z positions of the mounting locations relative to the vehicle origin. These locations are in the vehicle coordinate system, where:

- The X-axis points forward from the vehicle.
- The Y-axis points to the left of the vehicle, as viewed when facing forward.
- The Z-axis points up from the ground.

Box Truck — Sensor Locations Relative to Vehicle Origin

Mounting Location	X (m)	Y (m)	Z (m)
Front bumper	5.10	0	0.60
Rear bumper	-5	0	0.60
Right mirror	2.90	1.60	2.10
Left mirror	2.90	-1.60	2.10
Rearview mirror	2.60	0.20	2.60
Hood center	3.80	0	2.10
Roof center	1.30	0	4.20

Specify Box Truck Vehicle Dimensions

When simulating a path planner in the 3D environment, the path planner must use a vehicle whose dimensions are consistent with the one used in the environment. To make these dimensions consistent, you can use a `vehicleDimensions` object.

Specify the dimensions of a Box Truck vehicle in a `vehicleDimensions` object. Units are in meters. For an example that uses this object in a path planner, see “Visualize Automated Parking Valet Using Unreal Engine Simulation”.

```
centerToFront = 3.35;
centerToRear = 2.19;
frontOverhang = 1.25;
rearOverhang = 2.41;
vehicleWidth = 2.72;
vehicleHeight = 4.01;
vehicleLength = centerToFront + centerToRear + frontOverhang + rearOverhang;
```

```
boxTruckDims = vehicleDimensions(vehicleLength,vehicleWidth,vehicleHeight, ...
    'FrontOverhang',frontOverhang,'RearOverhang',rearOverhang)
```

```
boxTruckDims =
    vehicleDimensions with properties:
```

```
    Length: 9.2000
    Width: 2.7200
    Height: 4.0100
    Wheelbase: 5.5400
    RearOverhang: 2.4100
    FrontOverhang: 1.2500
    WorldUnits: 'meters'
```

See Also

[Hatchback](#) | [Sedan](#) | [Muscle Car](#) | [Sport Utility Vehicle](#) | [Small Pickup Truck](#)

Topics

“Unreal Engine Simulation for Automated Driving”
“Coordinate Systems in Automated Driving Toolbox”

RoadRunner Scenario Blocks

RoadRunner Scenario

Define interface for Simulink actor model



Libraries:

Automated Driving Toolbox / RoadRunner Scenario

Description

The RoadRunner Scenario block defines the interface of a Simulink actor model. The Block Parameters dialog box contains these tabs under which inputs are grouped together.

- Actions
- Events

The RoadRunner Scenario block must be present at the root level of the model, otherwise model compilation results in an error.

Parameters

Action name — Name of user-defined action
string

Name of user-defined action to map to a bus object.

To add an action name, click the **Add** button below the **User-defined actions** input table and double-click on a cell in the **Action name** column to type a new table entry.

Dependencies

To use this parameter, select the **Actions** tab.

Event name — Name of user-defined event
string

Name of user-defined event to map to a bus object.

To add an event name, click the **Add** button below the **User-defined events** input table and double-click on a cell in the **Event name** column to type a new table entry.

Dependencies

To use this parameter, select the **Events** tab.

Bus object name — Name of bus object
string

Name of bus object that corresponds to a user-defined action or event.

To add a bus object name corresponding to a user-defined action or event, double-click on a cell in the **Bus object name** column at the same level of the user-defined action or event, and type a new table entry.

All added bus object names must have a corresponding bus object. Bus objects represent a user-defined action or event. You must define a bus object in MATLAB in such a way that it contains the same parameter names, data types and values as the user-defined action or event that it represents in RoadRunner Scenario. The RoadRunner Scenario Reader and RoadRunner Scenario Writer blocks rely on a bus object loaded to the MATLAB workspace to recognize the structure of incoming user-defined actions and events.

For more information about creating a bus object for a user-defined action or event, see “Author RoadRunner Actor Behavior Using User-Defined Actions or Events in Simulink”.

Dependencies

To use this parameter, select the **Actions** or **Events** tab.

Version History

Introduced in R2022a

See Also

RoadRunner Scenario Reader | RoadRunner Scenario Writer

RoadRunner Scenario Reader

Reads selected topic from RoadRunner scenario



Libraries:

Automated Driving Toolbox / RoadRunner Scenario

Description

The RoadRunner Scenario Reader block reads the selected topic from the RoadRunner scenario. You can set the **Topic Category** parameter to `Actor`, `Action` or `Sensor`. The block outputs data as messages.

When you select the `Actor` topic, the block outputs the data associated with the actor, such as `Actor Specifications` and `Actor Pose`. When you select the `Action` topic, the block outputs data such as `Speed Change` and `Lane Change`. The block returns the simulation states from the previous time step. You can filter data based on the actor associated with the Simulink actor model.

When you select the `Sensor` topic, the block outputs the data associated with the sensor of specified `Sensor ID`. You can select the type of sensor data the block must output by specifying `Target Poses` or `Lane Boundaries`.

Ports

Output

Message — State information from scenario
Simulink message

State information from scenario, returned as a Simulink message.

Parameters

Topic Category — Topic category
`Actor` (default) | `Action` | `Event`

Topic category, specified as one of these values:

- `Actor` — Reads the actor data from the scenario
- `Action` — Reads the action data from the scenario
- `Sensor` — Reads the sensor data from the scenario
- `Event` — Reads the event data from the scenario

Actor Type — Type of actor in scenario
`All Types` (default) | `Vehicle`

Type of actor in scenario, specified as `All Types` or `Vehicle`. The `Vehicle` type includes additional wheel information of the actor.

Dependencies

To enable this parameter, set **Topic Category** to `Actor`.

Action Type — Type of action

`Change Behaviour Parameter (default)` | `Lateral Offset` | `Path Following` | `Speed Change` | `Lane Change` | `Longitudinal Distance` | `User-Defined`

Type of action that can be read from the scenario, specified as one of these values:

- `Change Parameter` — Reads the user-created parameter from the scenario
- `Lateral Offset` — Reads the lateral offset action data from the scenario
- `Path Following` — Reads the path following action data from the scenario
- `Speed Change` — Reads the speed change action data from the scenario
- `Lane Change` — Reads the lane change action data from the scenario
- `Longitudinal Distance` — Reads the longitudinal distance action data from the scenario
- `User-Defined` — Reads the custom parameters of a user-defined action from the scenario

This table describes the output bus structure when you set **Topic Category** to `Action` and **Action Type** to `Change Behavior Parameter`.

Field Name	Description
<code>Actor Action</code>	Information about the current action of specified actor, returned as a <code>struct</code> .
<code>Parameter</code>	Information about the changed user-specified behavior parameter, returned as a <code>struct</code> .

The `Actor Action` structure is the same for all action types. This table describes the `Actor Action` structure of the above output bus structure.

Field Name	Description
<code>ActionID</code>	Action ID returned as a string.
<code>ActorID</code>	Identifier of actor performing the action, returned as a <code>uint64</code> .
<code>PhaseInterval</code>	Phase interval to which the action is applied. <ul style="list-style-type: none"> • <code>Unspecified</code> — Unknown phase interval for the action. • <code>AtStart</code> — Specified action is completed at the start of the current phase. • <code>AtEnd</code> — Specified action is completed by the end of the current phase. • <code>Invariant</code> — Specified action objective is maintained during the current phase.

Field Name	Description
ActionTypes	<p>Action type.</p> <ul style="list-style-type: none"> • Unspecified — Unknown action type. • LaneChange — Lane change action. • Path — Path action. • Speed — Speed action. • LateralOffset — Lateral offset action. • ChangeBehaviorParameter — Change behavior parameter action. • LongitudinalDistance — Longitudinal distance action. • User-Defined — Change user-defined parameters.

This table describes the Parameter structure of the above output bus structure.

Field Name	Description
Name	Name of the changed user-specified behavior parameter, returned as a string.
Value	New value of the user-specified behavior parameter, returned as a string.
ParameterType	Type of parameter.

This table describes the output bus structure when you set **Topic Category** to Action and **Action Type** to Lane Change.

Field Name	Description
ActorAction	Information about the current action of specified actor, returned as a struct.
LaneChangeTarget	Target lane after lane change, returned as a struct.
TransitionDynamics	Dynamics of the transition to the lane change, returned as a struct.

The ActorAction structure is the same for all action types and is described above.

This table describes the LaneChangeTarget structure of the above output bus structure.

Field Name	Description
LaneValue	Number of lanes to change before reaching the target lane, returned as an int32 value.

Field Name	Description
LaneComparison	Direction of the lane change. <ul style="list-style-type: none"> • Unspecified — Unknown lane change direction. • SameAs — Actor moves to the same lane as the reference actor. • LeftOf — Actor moves to the lane left of the reference actor. • RightOf — Actor moves to the lane right of the reference actor.
RefActorID	Identifier of reference actor, returned as a uint64.

This table describes the TransitionDynamics structure of the above output bus structure.

Field Name	Description
Dimension	Transition metric measuring the action change. <ul style="list-style-type: none"> • Unspecified — Unknown transition metric to measure specified action. • Rate — The action occurs within specified rate value. • Time — The action occurs within specified time value (seconds). • Distance — The action occurs within specified distance value (meters).
Shape	Shape of the transition curve. <ul style="list-style-type: none"> • Unspecified — The shape of the transition curve is unknown. • Linear — The transition curve is linear. • Cubic — The transition curve is cubic. • Step — The transition curve is step-shaped.
Value	Value of the chosen transition metric, returned as a double.

Note The TransitionDynamics structure is the same for all action types that employ its use.

This table describes the output bus structure when you set **Topic Category** to Action and **Action Type** to Lateral Offset.

Field Name	Description
ActorAction	Information about the current action of specified actor, returned as a struct.

Field Name	Description
LateralOffsetTarget	Lateral offset relative to the current path of specified actor, returned as a <code>struct</code> .
TransitionDynamics	Transition dynamics for the lateral offset change, specified as a <code>struct</code> .

The ActorAction structure is the same for all action types and is described above.

This table describes the LateralOffsetTarget structure of the above output bus structure.

Field Name	Description
OffsetValue	<p>Target lateral offset relative to the current path, returned as a <code>double</code>.</p> <ul style="list-style-type: none"> • A positive value indicates an offset to the right of the current path • A negative value indicates an offset to the left of the current path

The TransitionDynamics structure is the same for all action types that employ its use and is described above.

This table describes the output bus structure when you set **Topic Category** to Action and **Action Type** to Longitudinal Distance.

Field Name	Description
ActorAction	Information about the current action of the specified actor, returned as a <code>struct</code> .
DistanceTarget	Information about the longitudinal distance to the reference actor, returned as a <code>struct</code> .
ReferenceSamplingMode	<p>Phase interval at which the target longitudinal distance is achieved.</p> <ul style="list-style-type: none"> • <code>Unspecified</code> — Target longitudinal distance gap to reference actor is unknown. • <code>AtActionStart</code> — Target longitudinal distance gap to reference actor is achieved at the start of the current phase. • <code>Continuous</code> — Target longitudinal distance gap to reference actor is achieved and maintained until another action controlling longitudinal distance is activated.
DynamicConstraints	Dynamic constraints for the longitudinal distance change, returned as a <code>struct</code> .

The ActorAction structure is the same for all action types and is described above.

This table describes the DistanceTarget structure of the above output bus structure.

Field Name	Description
RefActorID	Identifier of reference actor, returned as a uint64.
DistanceDimensionType	<p>Type of distance to reference actor.</p> <ul style="list-style-type: none"> • Unspecified — Type of distance to reference actor is unknown. • Longitudinal — Type of distance to the reference actor is longitudinal. • Lateral — Type of distance to the reference actor is lateral. • Euclidean — Type of distance to the reference actor is Euclidean.
DistanceType	<p>Specification of longitudinal distance as either time distance or space distance.</p> <ul style="list-style-type: none"> • Unspecified — Unknown longitudinal distance specification • Space — Space distance • Time — Time distance
ActorCoordinateSystemType	<p>Coordinate system in which to measure required longitudinal distance.</p> <ul style="list-style-type: none"> • Unspecified — Unknown coordinate system • Lane — Lane-based <i>st</i> coordinate system (<i>s</i>-axis is the lane center line of the lane on which the entity is located) • Pose — Cartesian coordinate system
Value	Longitudinal distance, returned as a double.
PositionComparison	<p>Relative position to reference actor.</p> <ul style="list-style-type: none"> • Unspecified — Unknown relative position to reference actor • SameAs — Parallel to reference actor • AheadOf — Ahead of reference actor • Behind — Behind reference actor • Either — Ahead of or behind reference actor

Field Name	Description
MeasureFrom	<p>Longitudinal distance is either measured between the closest points on two actors' bounding boxes or between the origin point of both actors.</p> <ul style="list-style-type: none"> • Unspecified — Unknown distance measurement type. • BoundingBoxes — Distance is measured as the gap between the rear end of the leading vehicle and the front end of the trailing vehicle. • Origins — Distance is measured as the gap between the origin of the leading vehicle and the origin of the trailing vehicle.

This table describes the DynamicConstraints structure of the above output bus structure.

Field Name	Description
UnlimitedDynamics	Presence of dynamic constraints, returned as a Boolean value.
MaxSpeed	Maximum speed that an actor can attain while approaching target longitudinal distance to reference actor, returned as a double.
MaxAcceleration	Maximum acceleration that an actor can attain while approaching target longitudinal distance to reference actor, returned as a double.
MaxDeceleration	Maximum deceleration that an actor can attain while approaching target longitudinal distance to reference actor, returned as a double.

This table describes the output bus structure when you set **Topic Category** to Action and **Action Type** to Path Following.

Field Name	Description
ActorAction	Information about the current action of specified actor, returned as a struct.
PathTarget	Actor target path, returned as a struct.

The ActorAction structure is the same for all action types and is described above.

This table describes the PathTarget structure of the above output bus structure.

Field Name	Description
Path	Set of 3-D coordinates representing the target path, returned as an N -by-3 array where $N = NumPoints$. Each column value in the first row is the x -, y - and z - coordinate, respectively, of the first point in the target path, and so on.
NumPoints	Total number of points in the target path, returned as a positive integer. Tip Currently, the RoadRunner Scenario Reader block reads the first 500 points of a target path. To read longer paths, see the MATLAB System block, Path Action Adapter in the example, "Trajectory Follower with RoadRunner Scenario".
HasTimings	Indication of target path containing timing information, returned as a Boolean value.
Timings	Timing information for each point of the path, returned as an N -by-1 structure array where $N = NumPoints$.

This table describes the Timings structure of the above PathTarget structure.

Field Name	Description
Time	Time of arrival of the actor at this point, relative to the time at the starting point of the path. Returned in seconds.
Speed	Speed of actor at the time of arrival, returned in meters per second.
WaitTime	Waiting time period of actor at arrival, returned in seconds. If this value is non-zero, then the actor is at rest.

This table describes the output bus structure when you set **Topic Category** to Action and **Action Type** to Speed Change.

Field Name	Description
ActorAction	Information about the current action of specified actor, returned as a struct.
SpeedTarget	Target speed after speed change, returned as a struct.
TransitionDynamics	Transition dynamics for the speed change, specified as a struct.

The ActorAction structure is the same for all action types and is described above.

This table describes the SpeedTarget structure of the above output bus structure.

Field Name	Description
SpeedValue	Target speed value, returned as a <code>double</code> .
SpeedComparison	Comparison type of current speed with the target speed. <ul style="list-style-type: none"> • <code>Unspecified</code> — Unknown speed comparison type. • <code>Absolute</code> — The target speed is absolute. • <code>SameAs</code> — The speed difference is zero relative to the speed of the reference actor. • <code>FasterThan</code> — The target speed must be higher than the speed of the reference actor. • <code>SlowerThan</code> — The target speed must be lower than the speed of the reference actor. • <code>FromPath</code> — The target speed must match the speeds specified in the <code>PathPointTiming</code> structure of the <code>PathTarget</code> structure (within <code>PathAction</code> structure) of the actor reference path.
RefActorID	Identifier of reference actor, if any, returned as a <code>uint64</code> .
RefSamplingMode	Speed sampling mode of reference actor, if any. <ul style="list-style-type: none"> • <code>Unspecified</code> — Target speed comparison to reference actor speed is unknown. • <code>AtActionStart</code> — Indicates that the target speed compares with point speed of reference actor at start of the phase. • <code>Continuous</code> — Indicates that the target speed compares with point speed of reference actor continuously through entire phase or until another action controlling target speed is activated.

The `TransitionDynamics` structure is the same for all action types that employ its use and is described above.

This table describes the output bus structure when you set **Topic Category** to `Action` and **Action Type** to `User-Defined`.

Field Name	Description
ActorAction	Information about the current action of specified actor, returned as a <code>struct</code> .
Name	Action name, returned as a string.
Parameters	Custom parameters of the user-defined action, returned as a <code>struct</code> . This <code>struct</code> contains the name and value for each custom parameter.

The ActorAction structure is the same for all action types and is described above.

Dependencies

To enable this parameter, set **Topic Category** to Action.

Sensor View — Sensor data derived from scenario ground truth

Target Poses (default) | Lane Boundaries

Sensor data derived from the scenario ground truth, specified as one of these options:

- **Target Poses** — The block outputs poses of targets within sensor range in host vehicle coordinates. For the bus structure of the output target poses, see the output argument description of the `targetPoses` function.
- **Lane Boundaries** — The block outputs lane boundaries within sensor range in host vehicle coordinates. For the bus structure of the output lane boundaries, see the output argument description of the `laneBoundaries` function.

You can send the above outputs directly to sensor detection generator blocks and obtain detections.

Dependencies

To enable this parameter, set **Topic Category** to Sensor.

Event Type — Type of event

User-Defined

Type of event to read from a scenario.

The event being read must be mapped to the corresponding bus object in the RoadRunner Scenario block.

Dependencies

To enable this parameter, set **Topic Category** to Event.

Topic — Actor data for all types

Actor Specifications (default) | Actor Pose | Actor Pose (Driving Scenario compatible) | Actor Lane Location

Actor data for all types, specified as one of these options:

- **Actor Specifications** — Static attributes associated with the actor, such as actor ID, actor name, and bounding box
- **Actor Pose** — Dynamic data associated with the actor, such as pose, velocity, and angular velocity
- **Actor Pose (Driving Scenario compatible)** — Dynamic data associated with the actor, such as actor ID, position, velocity, roll, pitch, yaw, and angular velocity
- **Actor Lane Location** — Dynamic data associated with the lane location of actors.

This table describes the output bus structure when you set **Topic Category** to Actor, **Actor Type** to All Types and **Topic** to Actor Specifications.

Field Name	Description
ActorID	Actor identifier, returned as a uint64.
ActorName	Actor name, returned as a string.
BoundingBox	Bounding box of the actor, returned as a struct.

This table describes the BoundingBox structure of the above output bus structure.

Field Name	Description
Min	The bounding box corner with minimal x-, y- and z- values, returned as a 1-by-3 array.
Max	The bounding box corner with maximal x-, y- and z- values, returned as a 1-by-3 array.

This table describes the output bus structure when you set **Topic Category** to Actor, **Actor Type** to All Types and **Topic** to Actor Pose.

Field Name	Description
ActorID	Scenario-defined actor identifier, returned as a uint64.
Pose	Position and orientation of the actor, returned as a 4-by-4 array.
Velocity	Actor velocity, in meters per second, in the x-, y- and z- directions, returned as a 1-by-3 vector.
AngularVelocity	Angular velocity, in radians per second, of actor in the x-, y- and z- directions, returned as a 1-by-3 vector.

This table describes the output bus structure when you set **Topic Category** to Actor, **Actor Type** to All Types and **Topic** to Actor Pose(Driving Scenario compatible).

Field Name	Description
ActorID	Scenario-defined actor identifier, returned as a uint64.
Position	Position of actor, returned as a real-valued vector of the form [x y z]. Units are in meters.
Velocity	Velocity (v) of actor in the x-, y-, and z-directions, returned as a real-valued vector of the form [v_x v_y v_z]. Units are in meters per second.
Roll	Roll angle of actor, returned as a real-valued scalar. Units are in degrees.
Pitch	Pitch angle of actor, returned as a real-valued scalar. Units are in degrees.
Yaw	Yaw angle of actor, returned as a real-valued scalar. Units are in degrees.

Field Name	Description
AngularVelocity	Angular velocity (ω) of actor in the x-, y-, and z-directions, returned as a real-valued vector of the form $[\omega_x, \omega_y, \omega_z]$. Units are in degrees per second.

This table describes the output bus structure when you set **Topic Category** to Actor, **Actor Type** to All Types, and **Topic** to Actor Lane Location.

Field Name	Description
ActorID	Scenario-defined actor identifier, returned as a uint64.
IsOnLane	Boolean value indicating if the actor is located on a lane. An actor is considered to be on a certain lane if its model origin lies in between the left and right boundaries of this lane.
LocationOnLane	Current lane of actor, returned as a struct. If an actor straddles several lanes, the most aligned lane is returned.

This table describes the LocationOnLane structure of the Actor Lane Location.

Field Name	Description
LaneID	UUID identifier of the most aligned lane, returned as a string.
Position	Position of the actor on the lane-center polyline (in s-value). The s-value is a double value within $[0, 1]$ that indicates a position on a 3-D polyline with 0 at the start and 1 at the end of the polyline.
Angle	Angle between the actor travel direction and tangent at the lane position. Units are in radians.

You can use the RoadRunner Scenario Reader block to access the lane location of all the actors in your simulation by setting **Filter** to None. In this case, the block outputs a message associated with each actor and each message has a field for actor ID. You can use a Queue block to store and queue messages. See “Filter” on page 7-0 .

Dependencies

To enable these options for this parameter, set **Actor Type** to All Types.

Topic — Actor data for vehicle type

Vehicle Specifications (default) | Vehicle Pose

Actor data for vehicle type, specified as one of these options:

- **Vehicle Specifications** — Static attributes associated with the vehicle, such as paint color, and wheel specifications.
- **Vehicle Pose** — Dynamic data associated with the actor, such as wheel poses

This table describes the output bus structure when you set **Topic Category** to Actor, **Actor Type** to Vehicle and **Topic** to Vehicle Specifications.

Field Name	Description
ActorSpec	Actor specifications, returned as a struct.
PaintColor	Color of the actor, returned as a struct.
NumWheels	Number of wheels, returned as a uint64 value.
Wheels	Wheel specifications of vehicle-type actor, returned as a struct.

This table describes the ActorSpec structure of the above output bus structure.

Field Name	Description
ActorID	Actor identifier, returned as a uint64.
ActorName	Actor name, returned as a string.
BoundingBox	Bounding box of the actor, returned as a struct.

Note The ActorSpec structure is also returned when you set **Topic Category** to Actor, **Actor Type** to All Types and **Topic** to Actor Specifications.

This table describes the PaintColor structure of the above output bus structure.

Field Name	Description
r	Red color, returned as a uint32 value.
g	Green color, returned as a uint32 value.
b	Blue color, returned as a uint32 value.
a	Transparency of the color (alpha), returned as a uint32 value.

This table describes the Wheels structure of the above output bus structure.

Field Name	Description
AxleIndex	Axle index of a wheel. The front-most axle has the starting index value of zero, with index values increasing towards the vehicle rear. Returned as a uint32 value.
WheelOffset	x-, y- and z- coordinates of the wheel center, in the vehicle coordinate system. Returned as a 1-by-3 vector.
WheelRadius	Radius of the wheel in meters. Returned as a double.

This table describes the output bus structure when you set **Topic Category** to Actor, **Actor Type** to Vehicle and **Topic** to Vehicle Pose.

Field Name	Description
ActorRuntime	Actor runtime values, returned as a <code>struct</code> .
NumWheels	Number of wheels specified as a <code>uint64</code> .
WheelPoses	Runtime pose of each wheel of vehicle-type actor, returned as a multidimensional 4-by-4-by- <i>N</i> array. <i>N</i> is the number of wheels of the vehicle-type actor. WheelPoses is returned for wheels starting on the leftmost side of the front axle, and moving to the right. After the first axle is complete, the leftmost wheel on the second axle is taken into consideration before moving to the right, and so on.

This table describes the ActorRuntime structure of the above output bus structure.

Field Name	Description
ActorID	Scenario-defined actor identifier, returned as a <code>uint64</code> .
Pose	Position and orientation of the actor, returned as a 4-by-4 array.
Velocity	Actor velocity, in meters per second, in the <i>x</i> -, <i>y</i> - and <i>z</i> - directions, returned as a 1-by-3 vector.
AngularVelocity	Angular velocity, in radians per second, of actor in the <i>x</i> -, <i>y</i> - and <i>z</i> - directions, returned as a 1-by-3 vector.

Note The ActorRuntime structure is also returned when you set **Topic Category** to Actor, **Actor Type** to All Types and **Topic** to Actor Pose.

Dependencies

To enable these options for this parameter, set **Actor Type** to Vehicle.

Topic — Lane boundaries to output

Ego-Lane (default) | Ego and Adjacent Lanes | All Lanes

Lane boundaries to output, specified as one of these options:

- Ego-Lane — The block outputs the boundaries for the lane in which host vehicle actor is traveling.
- Ego and Adjacent Lanes — The block outputs the boundaries for the adjacent left and right lanes along with the lane in which host vehicle actor is traveling.
- All Lanes — The block outputs the boundaries for all lanes on the road.

Dependencies

To enable this parameter, set **Topic Category** to Sensor and **Sensor View** to Lane Boundaries.

Filter — Filter criteria

Self (default) | None

Filter criteria for relevant topic data, specified as `None` or `Self`. `None` outputs data for all actors in the scenario. `Self` outputs data for the Simulink model actor.

When you set **Filter** to `None`, the block outputs a message for each actor in your simulation. Messages carry data, including the actor ID. You can store messages in a Queue block. Then, you can process these messages. For example, you can use MATLAB System block. For more information, see “Process Message Payload Using MATLAB System Block” (Simulink).

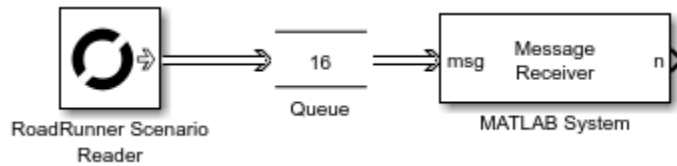
**Sensor ID** — Unique index of sensor

1 (default) | positive integer

Unique index of the sensor, specified as a positive integer. This ID must correspond to the

Sample Time — Sample time of simulation

positive real scalar

Sample time of simulation in seconds, specified as a positive real scalar.

Event Name — Name of event

string

Name of the user-defined event to read from a scenario.

Dependencies

To enable this parameter, set **Topic Category** to `Event` and **Event Type** to `User-Defined`.

Version History

Introduced in R2022a**R2023a: LaneLocation topic for all actors***Behavior changed in R2023a*

Starting in R2023a, `MapLocation` and its bus definition `BusVehicleMapLocation` are not supported, when you access `Vehicle Pose` using a RoadRunner Scenario Reader block. To read an actor location, use the new dedicated topic `Actor Lane Location`. The change allows you to access location data associated with any actor in your RoadRunner Scenario simulation.

See Also

RoadRunner Scenario | RoadRunner Scenario Writer

RoadRunner Scenario Writer

Write selected topic to RoadRunner scenario



Libraries:

Automated Driving Toolbox / RoadRunner Scenario

Description

The RoadRunner Scenario Writer block writes the selected topic to the RoadRunner scenario. You can set the **Topic Category** parameter to **Actor**, **Event**, or **Diagnostics**. The data is input as Simulink messages to the block. When you select the **Actor** topic, the block writes the data associated with the actor, such as **Actor Pose** and **Actor Pose (Driving Scenario Compatible)**.

If you are using an actor group in RoadRunner Scenario, you can use the RoadRunner Scenario Writer block to control the behavior of individual child actors in the following ways.

- Use one RoadRunner Scenario Writer block to send messages to different actors. For example, you can queue messages carrying results of different logic implementations within the model to the RoadRunner Scenario Writer block by using the Message Merge block. Each of these messages can carry a different value of **ActorID**.
- Use multiple RoadRunner Scenario Writer blocks. You can point the **ActorID** value of the **Actor Pose**, **Actor Pose (Driving Scenario compatible)**, or **Vehicle Pose** structure of each RoadRunner Scenario Writer block to a different child actor.

Ports

Input

Message — State information

Simulink message

State information to write to the scenario, specified as a Simulink message.

Parameters

Topic Category — Topic category

Actor (default) | Event | Diagnostics

Topic category, specified as one of these options:

- **Actor** — Writes the actor data to the scenario
- **Event** — Writes event data to the scenario

- **Diagnostics** — Writes custom diagnostic messages to the scenario

This **Diagnostics** structure contains data about the diagnostic type and the message. The table describes the fields of the **Diagnostics** structure.

Field Name	Description
DiagnosticType	Type of diagnostic message specified as an Enum.
DiagnosticMessage	Diagnostic message specified as a string.

Actor Type — Type of actor in scenario

All Types (default) | Vehicle

Type of actor in scenario, specified as **All Types** or **Vehicle**. The **Vehicle** type includes additional wheel information of the actor.

Note The **All Types** actor type also applies to pedestrians in a scenario.

Topic — Actor data

Actor Pose (default) | Actor Pose (Driving Scenario compatible)

Actor data, specified as one of these options:

- **Actor Pose** — Dynamic data associated with the actor, such as pose, velocity, and angular velocity
- **Actor Pose (Driving Scenario compatible)** — Dynamic data associated with the actor, such as actor ID, position, velocity, roll, pitch, yaw, and angular velocity

The table describes the input structure of the type **BusActorRuntime** when you set **Topic Category** to **Actor**, and **Topic** to **ActorPose**.

Field Name	Description
ActorID	Scenario-defined actor identifier, specified as a <code>uint64</code> .
Pose	Position and orientation of the actor specified as a 4-by-4 array.
Velocity	Actor velocity, in meters per second, in the x-, y- and z- directions, specified as a 1-by-3 vector.
AngularVelocity	Angular velocity, in radians per second, of actor in the x-, y- and z- directions, specified as a 1-by-3 vector.

The table describes the input structure of the type **BusActorPose** when you set **Topic Category** to **Actor**, and **Topic** to **Actor Pose (Driving Scenario compatible)**.

Field Name	Description
ActorID	Scenario-defined actor identifier, specified as a <code>double</code> .

Field Name	Description
Position	Position of actor, specified as a real-valued vector of the form $[x\ y\ z]$. Units are in meters.
Velocity	Velocity (v) of actor in the x - y -, and z -directions, specified as a real-valued vector of the form $[v_x\ v_y\ v_z]$. Units are in meters per second.
Roll	Roll angle of actor, specified as a real-valued scalar. Units are in degrees.
Pitch	Pitch angle of actor, specified as a real-valued scalar. Units are in degrees.
Yaw	Yaw angle of actor, specified as a real-valued scalar. Units are in degrees.
AngularVelocity	Angular velocity (ω) of actor in the x -, y -, and z -directions, specified as a real-valued vector of the form $[\omega_x\ \omega_y\ \omega_z]$. Units are in degrees per second.

Dependencies

To enable this parameter, set **Topic Category** to Actor and **Actor Type** to All Types.

Topic — Vehicle data

Vehicle Pose (default)

Vehicle data, specified as Vehicle Pose which contains the dynamic data associated with the vehicle, such as wheel poses.

The table describes the input structure when you set **Topic Category** to Actor, and **Actor Type** to Vehicle

Field Name	Description
ActorRuntime	Attributes of base actor during simulation specified as a structure of the type BusActorRuntime.
NumWheels	Number of wheels specified as a uint64.
WheelPoses	Poses of the wheels specified as a 4-by-4-by-18 array.

Dependencies

To enable this parameter, set **Topic Category** to Actor and **Actor Type** to Vehicle.

Event Type — Type of event

Action Complete (default) | User-Defined

Type of event written to the scenario, specified as one of the following.

- Action Complete — Indicates that a custom action has been processed.
- User-Defined — Indicates that a user-defined event has been returned to a scenario.

The event being written must be mapped to its corresponding bus object in the RoadRunner Scenario block.

This table describes the `Action Complete` structure, which is of the type `BusActionComplete`.

Field Name	Description
ActionID	Identifier of completed action, specified as a string.
ActorID	Identifier of actor executing action, specified as a uint64.
FinalStatus	Status of the action, specified as an enumeration variable of the <code>EnumActionStatus</code> enumeration class. The value of <code>EnumActionStatus</code> can be: <ul style="list-style-type: none"> • Unspecified — The action event is not dispatched. • Dispatched — The action event has been dispatched. • Skipped — The action has been skipped; no action event is to be dispatched. • Interrupted — After dispatch, the action is cancelled or interrupted. • Done — After dispatch, the action is completed.

Dependencies

To enable this parameter, set **Topic Category** to Event.

Version History

Introduced in R2022a

See Also

RoadRunner Scenario | RoadRunner Scenario Reader

RoadRunner Scenario Objects

addObserver

Add observer to scenario simulation

Syntax

```
observer = addObserver(ScenarioSim, 'ObserverName', sysObj)
```

Description

`observer = addObserver(ScenarioSim, 'ObserverName', sysObj)` adds an observer named `ObserverName`, represented by System object `sysObj`, to the scenario simulation `ScenarioSim`.

Examples

Add Observer to Read Simulation Pace and List of Actors

Create `ScenarioSim`, a `Simulink.ScenarioSimulation` object.

```
rrApp = roadrunner('C:\Project\TestRoute')
openScenario(rrApp, 'TrajectoryCutIn');
ScenarioSim = createSimulation(rrApp);
```

Create the class `mySysObserver`, which inherits from `matlab.System` base class. In the `stepImpl` method, get the list of actors, and the simulation pace of an existing simulation. Use the `resetImpl` method to reset values of the required variables.

```
classdef mySysObserver < matlab.System

    properties(Access=private)
        mScenarioSimObj;
        mScenarioSimActorList;
        mSimulationPace;
        mIsPacingTurnedOff;
    end

    methods
        % Constructor for the System object
        function obj = mySysObserver()
            end
    end

    methods(Access = protected)
        % Reset the values
        function resetImpl(obj)
            obj.mScenarioSimObj = Simulink.ScenarioSimulation.find('ScenarioSimulation', 'SystemObj');
            obj.mScenarioSimActorList = [];
            obj.mIsPacingTurnedOff = false;
        end

        % Get the required parameter values
        function stepImpl(obj)
```

```

        mSimulationPace = obj.mScenarioSimObj.get('SimulationPace');
        mScenarioSimActorList = obj.mScenarioSimObj.get('ActorSimulation')
    end

    % Release the object and its resources
    function releaseImpl(~)
    end
end
end
end

```

The System object represented by `mySysObserver` is added as an observer named `ReadPaceandActors` to the simulation `ScenarioSim`.

```
observer = addObserver(ScenarioSim, 'ReadPaceandActors', mysysObserver)
```

Input Arguments

ScenarioSim — RoadRunner Scenario simulation

Simulink.ScenarioSimulation object

RoadRunner Scenario simulation, specified as a Simulink.ScenarioSimulation object.

Example: `observer = addObserver(ScenarioSim, 'RedCarObserver', Obj)`

ObserverName — Name of observation actor

string | character vector

Name of observation actor, specified as a string or character vector.

Example: `'RedCarObserver'`

sysObj — Observer

System object

Observer to add to the simulation, specified as a MATLAB System object. You must inherit the code implementation of System object `sysObj` from the `matlab.System` base class.

Output Arguments

observer — Flag to indicate result of addition of observer

1 | 0

Flag to indicate result of addition of observer, returned as 0 or 1. If the observer is not added successfully, the value returned is 0.

Version History

Introduced in R2022a

See Also

`matlab.System` | `Simulink.ScenarioSimulation` | `Simulink.ScenarioSimulation.find` | `removeObserver`

convertToStruct

Convert actor to MATLAB structure

Syntax

```
actorStruct = convertToStruct(actorSim)
```

Description

`actorStruct = convertToStruct(actorSim)` converts the `Simulink.ActorSimulation` actor specified by `actorSim` to its equivalent MATLAB structure.

Examples

Convert Actor to Structure

Create `sim`, a `Simulink.ScenarioSimulation` object.

```
rrApp = roadrunner('C:\Project\TestHighwayRoute');  
openScenario(rrApp, 'myScenario1');  
sim = createSimulation(rrApp);
```

Start the simulation.

```
set(sim, 'SimulationCommand', 'Start');
```

Pause the simulation.

```
set(sim, 'SimulationCommand', 'Pause');
```

Retrieve one actor from the simulation.

```
actorsim = get(sim, 'ActorSimulation');  
actorOne = actorsim(1);
```

Convert the actor to a MATLAB structure.

```
actorStruct = convertToStruct(actorOne)
```

```
actorStruct =
```

```
struct with fields:
```

```
ActorID: 1  
Pose: [4x4 double]
```

```
Velocity: [0 0 0]
AngularVelocity: [0 0 0]
```

Input Arguments

actorSim — Actor

Simulink.ActorSimulation object

Actor, specified as a Simulink.ActorSimulation object.

Example: actorStruct = convertToStruct(actorSim)

Output Arguments

actorStruct — MATLAB structure equivalent to actor

struct

MATLAB structure equivalent to actor, returned as a struct. This MATLAB structure contains the runtime attributes of the specified actor.

The returned structure contains these fields.

Field	Description
ActorID	Actor identifier, returned as a positive integer.
Pose	Position and orientation of actor in the RoadRunner Scenario coordinate system, returned as a 4-by-4 array.
Velocity	Velocity of actor in the x-, y-and z- directions, returned as a 1-by-3 vector. Units are in meters per second.
AngularVelocity	Angular velocity of actor in the x-, y-and z- directions, returned as a 1-by-3 real-valued vector. Units are in radians per second.

Version History

Introduced in R2022a

See Also

Simulink.ActorSimulation | Simulink.ScenarioSimulation

get

Get scenario or static attribute of actor

Syntax

```
staticAttr = get(actorSim, 'ActorModel')  
scenario = get(actorSim, 'ScenarioSimulation')
```

Description

`staticAttr = get(actorSim, 'ActorModel')` gets the static attributes of the actor specified by `actorSim`.

`scenario = get(actorSim, 'ScenarioSimulation')` gets the scenario simulation containing the actor specified by `actorSim`.

Examples

Get Static Attributes of Actor

Create `sim`, a `Simulink.ScenarioSimulation` object.

```
rrApp = roadrunner('C:\Project\TestHighwayRoute');  
openScenario(rrApp, 'myScenario1');  
sim = createSimulation(rrApp);
```

Start the simulation.

```
set(sim, 'SimulationCommand', 'Start');
```

Pause the simulation.

```
set(sim, 'SimulationCommand', 'Pause');
```

Retrieve all actors from the simulation.

```
actorsim = get(sim, 'ActorSimulation');
```

Get the first actor in the list.

```
actorOne = actorsim(1);
```

Get the static specifications of `actorOne`.

```
staticAttr = get(actorOne, 'ActorModel')
```

Get the simulation containing `actorOne`.

```
scenario = get(actorOne, 'ScenarioSimulation')
```

Input Arguments

actorSim — Actor

Simulink.ActorSimulation object

Actor, specified as a Simulink.ActorSimulation object.

Example: staticAttr = get(actorSim, 'ActorModel')

Output Arguments

staticAttr — Static attributes of actor

Simulink.ActorModel object

Static attributes of actor, returned as a Simulink.ActorModel object.

scenario — Scenario simulation containing actor

Simulink.ScenarioSimulation object

Scenario simulation containing actor, returned as a Simulink.ScenarioSimulation object.

Version History

Introduced in R2022a

See Also

Simulink.ActorSimulation | Simulink.ActorModel | Simulink.ScenarioSimulation

get

Get logged scenario simulation data

Syntax

```
loggeddata = get(log, 'Parameter')  
loggeddata = get(log, 'Parameter', 'ActorID', 'ID')
```

Description

`loggeddata = get(log, 'Parameter')` returns simulation log data specified by `Parameter` from the `Simulink.ScenarioLog` object `log`.

`loggeddata = get(log, 'Parameter', 'ActorID', 'ID')` returns simulation log data specified by `Parameter` for actor with identifier `ID` from the `Simulink.ScenarioLog` object `log`.

Examples

Get Scenario Simulation Log

Set logging on for `ss`, a `Simulink.ScenarioSimulation` object.

```
set(ss, 'Logging', 'on')
```

Get the simulation log after it stops playing.

```
log = get(ss, 'SimulationLog')
```

Get the list of participating actors from the simulation.

```
actors = get(log, 'ActorIDs')
```

```
actors =
```

```
    1    2    3
```

Get the velocity of actor with actor ID 1.

```
vel = get(log, 'Velocity', 'ActorID', 1)
```

Input Arguments

log — Scenario simulation log

`Simulink.ScenarioLog` object

Scenario simulation log from which to return data, specified as a `Simulink.ScenarioLog` object.

Example: `actors = get(log, 'ActorIDs')`

Parameter — Information required from simulation log

ActorIDs | Time | Diagnostics | Actions | Events | Pose | Velocity | AngularVelocity | WheelPose

Information required from simulation log, specified as one of these parameters.

- ActorIDs
- Time
- Diagnostics
- Actions
- Events
- Pose
- Velocity
- AngularVelocity
- WheelPose

ID — Actor identifier

positive integer

Actor identifier, specified as a positive integer.

Example: `pose = get(log, 'Pose', 'ActorID', 5)`

Output Arguments**Loggeddata — Specific simulation log data**

array | structure array

Specific simulation log data, returned as an array or structure array.

This table describes the output returned for each **Parameter** input argument.

Input Argument	Output
ActorIDs	List of unique IDs of actors that participated in the simulation, returned as an array
Time	Each time step of the simulation, returned as an array.
Diagnostics	Diagnostics reported during the simulation, if any, returned as a structure array.
Actions	Actions of specified actor, if any, for each time step of the simulation, returned as a structure array.
Events	Events being sent by the specified actor, if any, for each time step of the simulation, returned as a structure array.
Pose	Pose of specified actor for each time step of the simulation, returned as a structure array.

Input Argument	Output
Velocity	Velocity of specified actor for each time step of the simulation, returned as a structure array.
AngularVelocity	Angular velocity of specified actor for each time step of the simulation, returned as a structure array.
WheelPose	Wheel pose of specified actor for each time step of the simulation, returned as a structure array.

This table describes the fields of each structure within the `Diagnostics` structure array.

Field Name	Description
Time	Simulation time step at which diagnostic message is reported.
MessageType	Type of reported message, returned as an enumeration variable of the <code>EnumDiagnosticType</code> enumeration class. The value of <code>EnumDiagnosticType</code> variable can be: <ul style="list-style-type: none"> • Unspecified — The diagnostic type of reported message is unknown. • Information — The reported message is at the information level. • Warning — The reported message is at the warning level. • Error — The reported message is at the error level.
Message	Diagnostic message text, returned as a string or character vector.

This table describes the fields of each structure within the `Actions` structure array.

Field Name	Description
Time	Each simulation time step, from start to end.
Action	Actions of the specified actor, if any, at each simulation time step.

This table describes the fields of each structure within the `Events` structure array.

Field Name	Description
Time	Each simulation time step, from start to end.
Events	Events being sent by the specified actor, if any, at each simulation time step.

This table describes the fields of each structure within the `Pose` structure array.

Field Name	Description
Time	Each simulation time step, from start to end.
Pose	Pose of the specified actor at each simulation time step.

This table describes the fields of each structure within the `Velocity` structure array.

Field Name	Description
Time	Each simulation time step, from start to end.
Velocity	Velocity of the specified actor at each simulation time step.

This table describes the fields of each structure within the `AngularVelocity` structure array.

Field Name	Description
Time	Each simulation time step, from start to end.
AngularVelocity	Angular velocity of the specified actor at each simulation time step.

This table describes the fields of a structure within the `WheelPose` structure array.

Field Name	Description
Time	Each simulation time step, from start to end.
WheelPose	<p>The wheel pose of the specified actor at each simulation time step.</p> <p><code>WheelPose</code> is returned for wheels starting from the leftmost side of the front axle, and moving to the right. After the first axle is complete, the leftmost wheel of the second axle is taken into consideration before moving to the right, and so on.</p>

Version History

Introduced in R2022a

See Also

`Simulink.ScenarioSimulation` | `Simulink.ScenarioLog` | `getAction` | `getAttribute`

get

Get value of scenario simulation parameter

Syntax

```
param = get(ScenarioSim,'Param')
```

Description

`param = get(ScenarioSim,'Param')` returns the value of the specified parameter `Param` from a scenario simulation `ScenarioSim` at runtime.

Examples

Get Specified Parameter Value

Create `ss`, a `Simulink.ScenarioSimulation` object.

```
rrApp = roadrunner('C:\Project\TestHighwayRoute');  
openScenario(rrApp,'myScenario1');  
ss = createSimulation(rrApp);
```

Get the current simulation status.

```
simstatus = get(ss,'SimulationStatus')
```

Get the log data history associated with the simulation.

```
loggeddata = get(ss,'SimulationLog')
```

Get all actors from a scenario.

```
actors = get(ss,'ActorSimulation')
```

Get a specific actor using its corresponding Simulink model handle.

```
actorsim = get(ss,'ActorSimulation', 'SimulinkModel', mdHdl)
```

Get a specific actor using the System object that represents its runtime behavior. This operation is possible only if an actor is already associated with a MATLAB System object.

```
actorsysobj = get(ss,'ActorSimulation', 'SystemObject', obj)
```

Get a specific actor using its corresponding `Simulink.ActorModel` object name.

```
actormod = get(ss,'ActorSimulation', 'ActorModel', actorModel)
```

Retrieve all the sensors from the simulation.

```
sensors = get(ss, 'SensorSimulation');
```

Input Arguments

ScenarioSim — RoadRunner Scenario simulation

Simulink.ScenarioSimulation object

RoadRunner Scenario simulation, specified as a Simulink.ScenarioSimulation object.

Example: `simstatus = get(ScenarioSim, 'SimulationStatus')`

Param — Scenario simulation parameter

StepSize | MaxSimulationTime | PacerStatus | SimulationPace | SimulationStatus | SimulationLog | ActorSimulation

Scenario simulation parameter, specified as one of these string values.

Parameter	Description
'StepSize'	Step size of simulation
'MaxSimulationTime'	Maximum simulation time of scenario
'PacerStatus'	Pacer status of simulation
'SimulationPace'	Pace of simulation
'SimulationStatus'	Status of simulation
'SimulationLog'	Logged simulation data
'ActorSimulation'	Actors in simulation
'ActorSimulation', 'SimulinkModel', mdHdl	Actor in simulation corresponding to specified Simulink model handle
'ActorSimulation', 'SystemObject', obj	Actor in simulation corresponding to specified System object
'ActorSimulation', 'ActorModel', actorModel	Actor in simulation corresponding to specified Simulink.ActorModel object
'SensorSimulation'	Sensors in simulation

Example: `simpace = get(ScenarioSim, 'SimulationPace')`

Output Arguments

param — Value of parameter

double | char | Simulink.ScenarioLog object | Simulink.ActorSimulation object

Value of parameter, returned as one of these data types.

Parameter	Data Type of Output
'StepSize'	double
'MaxSimulationTime'	double
'PacerStatus'	char or string

Parameter	Data Type of Output
'SimulationPace'	double
'SimulationStatus'	char or string
'SimulationLog'	Simulink.ScenarioLog object
'ActorSimulation'	Simulink.ActorSimulation object
'ActorSimulation', 'SimulinkModel', mdHdl	Simulink.ActorSimulation object
'ActorSimulation', 'SystemObject', obj	Simulink.ActorSimulation object
'ActorSimulation', 'ActorModel', actorModel	Simulink.ActorSimulation object
'SensorSimulation'	SensorSimulation object

Version History

Introduced in R2022a

See Also

[Simulink.ScenarioSimulation](#) | [Simulink.ActorSimulation](#) | [sensorSimulation](#) | [Simulink.ActorModel](#) | [set](#)

getAction

Get actions associated with actor

Syntax

```
action = getAction(actorSim, 'actionName')
action = getAction(actorSim, 'UserDefinedAction', 'UserDefinedActionName')
```

Description

`action = getAction(actorSim, 'actionName')` gets the specified action `actionName`, if present, for the actor represented by `actorSim` at the current simulation time step. If no action is configured at the current time step, an empty array is returned.

`action = getAction(actorSim, 'UserDefinedAction', 'UserDefinedActionName')` gets the user-defined action named `UserDefinedActionName` for the actor represented by `actorSim`.

Examples

Get Lateral Offset Action of Actor

Create `sim`, a `Simulink.ScenarioSimulation` object

```
rrApp = roadrunner('C:\Project\TestHighwayRoute');
openScenario(rrApp, 'myScenario1');
sim = createSimulation(rrApp);
```

Start the simulation.

```
set(sim, 'SimulationCommand', 'Start');
```

Pause the simulation.

```
set(sim, 'SimulationCommand', 'Pause');
```

Retrieve all actors from the simulation.

```
actorsim = get(sim, 'ActorSimulation');
```

Get the first actor from the list.

```
actorOne = actorsim(1);
```

Get the lateral offset action of the first actor at the current time step.

```
loAction = getAction(actorOne, 'LateralOffsetAction')
```

Input Arguments

actorSim — Actor

`Simulink.ActorSimulation` object

Actor from which to return action, specified as a `Simulink.ActorSimulation` object.

Example: `action = getAction(actorSim, 'PathAction')`

actionName — Actor action

`PathAction` | `SpeedAction` | `LaneChangeAction` | `LateralOffsetAction` | `ChangeParameterAction` | `LongitudinalDistanceAction` | `UserDefinedAction`

Actor action to be returned, specified as one of these values:

- `PathAction`
- `SpeedAction`
- `LaneChangeAction`
- `LateralOffsetAction`
- `ChangeParameterAction`
- `LongitudinalDistanceAction`
- `UserDefinedAction`

UserDefinedActionName — Name of user-defined action

`character vector` | `string`

Name of the user-defined action to be returned, specified as a character vector or string.

Output Arguments

action — Action

`struct`

Action of specified actor at current time step, returned as a `struct`.

The output is a `PathAction`, `SpeedAction`, `LaneChangeAction`, `LateralOffsetAction`, `ChangeParameterAction`, or `LongitudinalDistanceAction` structure depending on the input argument `Action`.

The `LaneChangeAction` structure contains information about a lane change action, if any, for the specified actor at the current time step. This table describes the fields of the `LaneChangeAction` structure.

Field Name	Description
<code>ActorAction</code>	Information about the current action of specified actor, returned as a <code>struct</code> .
<code>LaneChangeTarget</code>	Target lane after lane change, returned as a <code>struct</code> .
<code>TransitionDynamics</code>	Dynamics of the transition to the lane change, returned as a <code>struct</code> .

This table describes the fields of the `ActorAction` structure of the `LaneChangeAction` structure.

Field Name	Description
ActorID	Identifier of actor performing the action, returned as a positive integer.
PhaseInterval	<p>Phase interval to which the action is applied, returned as an enumeration variable of the EnumPhaseInterval enumeration class.</p> <p>The value of EnumPhaseInterval variable can be:</p> <ul style="list-style-type: none"> • Unspecified — Unknown phase interval for the action. • AtStart — Specified action is completed at the start of the current phase. • AtEnd — Specified action is completed by the end of the current phase. • Invariant — Specified action objective is maintained during the current phase.
ActionType	<p>Action type, returned as an enumeration variable of the EnumActionType enumeration class.</p> <p>The value of EnumActionType variable can be:</p> <ul style="list-style-type: none"> • Unspecified — Unknown action type. • LaneChange — Lane change action. • Path — Path action. • Speed — Speed action. • LateralOffset — Lateral offset action. • ChangeParameter — Change parameter action.

Note The ActorAction structure is also contained in other action output structures.

- PathAction
- SpeedAction
- LateralOffsetAction
- ChangeParameterAction
- LongitudinalDistanceAction
- UserDefinedAction

This table describes the fields of the LaneChangeTarget structure of the LaneChangeAction structure.

Field Name	Description
LaneValue	Number of lanes to change before reaching the target lane, returned as an int32 value.
LaneComparison	<p>Direction of the lane change, returned as an enumeration variable of the EnumLaneComparison enumeration class.</p> <p>The value of EnumLaneComparison variable can be:</p> <ul style="list-style-type: none"> • Unspecified — Unknown lane change direction. • SameAs — Actor moves to the same lane as the reference actor. • LeftOf — Actor moves to the lane left of the reference actor. • RightOf — Actor moves to the lane right of the reference actor.
RefActorID	Identifier of reference actor, returned as a positive integer.

This table describes the fields of the TransitionDynamics structure of the LaneChangeAction structure.

Field Name	Description
Dimension	<p>Transition metric measuring the action change, returned as an enumeration variable of the EnumDynamicsDimension enumeration class.</p> <p>The value of EnumDynamicsDimension variable can be:</p> <ul style="list-style-type: none"> • Unspecified — Unknown transition metric to measure specified change action. • Rate — The change action occurs within specified rate value. • Time — The change action occurs within specified time value (seconds). • Distance — The change action occurs within specified distance value (meters).

Field Name	Description
Shape	<p>Shape of the transition curve, returned as an enumeration variable of the EnumDynamicsShape enumeration class.</p> <p>The value of EnumDynamicsShape variable can be:</p> <ul style="list-style-type: none"> • Unspecified — The shape of the transition curve is unknown. • Linear — The transition curve is linear. • Cubic — The transition curve is cubic. • Step — The transition curve is step-shaped.
Value	Value of the chosen transition metric, returned as a double.

Note The TransitionDynamics structure is also contained in other action output structures.

- SpeedAction
- LateralOffsetAction

The PathAction structure contains information about a path change action, if any, for the specified actor at the current time step. This table describes the fields of the PathAction structure.

Field Name	Description
ActorAction	Information about the current action of specified actor, returned as a struct.
PathTarget	Actor target path, returned as a struct.

The fields of the ActorAction structure are described in the table under LaneChangeAction structure.

This table describes the PathTarget structure of the PathAction structure.

Field Name	Description
Path	<p>Set of 3-D coordinates representing the target path, returned as an N-by-3 array where $N = NumPoints$.</p> <p>Each column value in the first row is the x-, y- and z- coordinate, respectively, of the first point in the target path, and so on.</p>
NumPoints	Total number of points in the target path, returned as a positive integer.
HasTimings	Indication of target path containing timing information, returned as a Boolean value.

Field Name	Description
PathPointTiming	Timing information for each point of the path, returned as an N -by-1 structure array where $N = NumPoints$.

This table describes the fields of each structure in the PathPointTiming structure array of the PathTarget structure within the PathAction structure.

Field Name	Description
Time	Time of arrival of the actor at this point, relative to the time at the starting point of the path. Returned in seconds.
Speed	Speed of actor at the time of arrival, returned in meters per second.
WaitTime	Waiting time period of actor at arrival, returned in seconds. If this value is non-zero, then the actor is at rest.

The SpeedAction structure contains information about a speed change action, if any, for the specified actor at the current time step. This table describes the fields of the SpeedAction structure.

Field Name	Description
ActorAction	Information about the current action of specified actor, returned as a struct.
SpeedTarget	Target speed after speed change, returned as a struct.
TransitionDynamics	Transition dynamics for the speed change, specified as a struct.

The fields of the ActorAction structure are described in the table under LaneChangeAction structure.

This table describes the SpeedTarget structure of the SpeedAction structure.

Field Name	Description
SpeedValue	Target speed value, returned as a double.

Field Name	Description
SpeedComparison	<p>Comparison type of current speed with the target speed, returned as an enumeration variable of the EnumSpeedComparison enumeration class.</p> <p>The value of EnumSpeedComparison variable can be:</p> <ul style="list-style-type: none"> • Unspecified — Unknown speed comparison type. • Absolute — The target speed is absolute. • SameAs — The speed difference is zero relative to the speed of the reference actor. • FasterThan — The target speed must be higher than the speed of the reference actor. • SlowerThan — The target speed must be lower than the speed of the reference actor. • FromPath — The target speed must match the speeds specified in the PathPointTiming structure of the PathTarget structure (within PathAction structure) of the actor reference path.
RefActorID	<p>Identifier of reference actor, if any, returned as a positive integer</p>
RefSamplingMode	<p>Speed sampling mode of reference actor, if any, returned as an enumeration variable of the EnumReferenceSamplingMode enumeration class.</p> <p>The value of EnumReferenceSamplingMode variable can be:</p> <ul style="list-style-type: none"> • Unspecified — Target speed comparison to reference actor speed is unknown. • AtActionStart — Indicates that the target speed compares with point speed of reference actor at start of the phase. • Continuous — Indicates that the target speed compares with point speed of reference actor continuously through entire phase or until another action controlling target speed is activated.

The fields of the ActorAction structure are described in the table under LaneChangeAction structure.

The LateralOffsetAction structure contains information about lateral offset, if any, of the specified actor at the current time step. This table describes the fields of the LateralOffsetAction structure.

Field Name	Description
ActorAction	Information about the current action of specified actor, returned as a <code>struct</code> .
LateralOffsetTarget	Lateral offset relative to the current path of specified actor, returned as a <code>struct</code> .
TransitionDynamics	Transition dynamics for the lateral offset change, specified as a <code>struct</code> .

The fields of the ActorAction structure are described in the table under LaneChangeAction structure.

This table describes the LateralOffsetTarget structure of the LateralOffsetAction structure.

Field Name	Description
OffsetValue	Target lateral offset relative to the current path, returned as a <code>double</code> . <ul style="list-style-type: none"> • A positive value indicates an offset to the right of the current path • A negative value indicates an offset to the left of the current path

The fields of the TransitionDynamics structure are described in the table under LaneChangeAction structure.

The ChangeParameterAction structure contains information about a change in the custom behavior parameters, if any, of the specified actor at the current time step. This table describes the fields of the ChangeParameterAction structure.

Field Name	Description
ActorAction	Information about the current action of specified actor, returned as a <code>struct</code> .
Parameter	Information about the changed user-specified behavior parameter, returned as a <code>struct</code> .

The fields of the ActorAction structure are described in the table under LaneChangeAction structure.

This table describes the Parameter structure of the ChangeParameterAction structure.

Field Name	Description
Name	Name of the changed user-specified behavior parameter, returned as a string.
Value	New value of the user-specified behavior parameter, returned as a string.

The LongitudinalDistanceAction structure contains information about changes, if any, in the longitudinal distance of the specified actor at the current time step. The longitudinal distance between two actors can be measured either as a space distance or a time distance. This table describes the fields of the LongitudinalDistanceAction structure.

Field Name	Description
ActorAction	Information about the current action of the specified actor, returned as a <code>struct</code> .
DistanceTarget	Information about the longitudinal distance to the reference actor, returned as a <code>struct</code> .
ReferenceSamplingMode	<p>Phase interval at which the target longitudinal distance is achieved, returned as an enumeration variable of the <code>EnumReferenceSamplingMode</code> enumeration class.</p> <p>The value of <code>EnumReferenceSamplingMode</code> variable can be:</p> <ul style="list-style-type: none"> • Unspecified — Target longitudinal distance gap to reference actor is unknown. • AtActionStart — Target longitudinal distance gap to reference actor is achieved at the start of the current phase. • Continuous — Target longitudinal distance gap to reference actor is achieved and maintained until another action controlling longitudinal distance is activated.
DynamicConstraints	Dynamic constraints for the longitudinal distance change, returned as a <code>struct</code> .

The fields of the `ActorAction` structure are described in the table under `LaneChangeAction` structure.

This table describes the `DistanceTarget` structure of the `LongitudinalDistanceAction` structure.

Field Name	Description
RefActorID	Identifier of reference actor, returned as a positive integer.

Field Name	Description
DistanceDimensionType	<p>Type of distance to reference actor, returned as an enumeration variable of the EnumDistanceDimensionType enumeration class.</p> <p>The value of EnumDistanceDimensionType variable can be:</p> <ul style="list-style-type: none"> • Unspecified — Type of distance to reference actor is unknown. • Longitudinal — Type of distance to the reference actor is longitudinal. • Lateral — Type of distance to the reference actor is lateral. • Euclidean — Type of distance to the reference actor is Euclidean.
DistanceType	<p>Specification of longitudinal distance as either time distance or space distance, returned as an enumeration variable of the EnumDistanceType enumeration class.</p> <p>The value of EnumDistanceType variable can be:</p> <ul style="list-style-type: none"> • Unspecified — Unknown longitudinal distance specification • Space — Space distance • Time — Time distance
ActorCoordinateSystemType	<p>Coordinate system in which to measure required longitudinal distance, returned as an enumeration variable of the EnumActorCoordinateSystemType enumeration class.</p> <p>The value of EnumActorCoordinateSystemType variable can be:</p> <ul style="list-style-type: none"> • Unspecified — Unknown coordinate system • Lane — Lane-based <i>st</i> coordinate system (<i>s</i>-axis is the lane center line of the lane on which the entity is located) • Pose — Cartesian coordinate system
Value	Longitudinal distance, returned as a double.

Field Name	Description
PositionComparison	<p>Relative position to reference actor, returned as an enumeration variable of the EnumPositionComparison enumeration class.</p> <p>The value of EnumPositionComparison variable can be:</p> <ul style="list-style-type: none"> • Unspecified — Unknown relative position to reference actor • SameAs — Parallel to reference actor • AheadOf — Ahead of reference actor • Behind — Behind reference actor • Either — Ahead of or behind reference actor
MeasureFrom	<p>Longitudinal distance is either measured between the closest points on two actors' bounding boxes or between the origin point of both actors. Returned as an enumeration variable of the EnumMeasureFrom enumeration class.</p> <p>The value of EnumMeasureFrom variable can be:</p> <ul style="list-style-type: none"> • Unspecified — Unknown distance measurement type. • BoundingBoxes — Distance is measured as the gap between the rear end of the leading vehicle and the front end of the trailing vehicle. • Origins — Distance is measured as the gap between the origin of the leading vehicle and the origin of the trailing vehicle.

This table describes the DynamicConstraints structure of the LongitudinalDistanceAction structure.

Field Name	Description
UnlimitedDynamics	Presence of dynamic constraints, returned as a Boolean value.
MaxSpeed	Maximum speed that an actor can attain while approaching target longitudinal distance to reference actor, returned as a double.
MaxAcceleration	Maximum acceleration that an actor can attain while approaching target longitudinal distance to reference actor, returned as a double.
MaxDeceleration	Maximum deceleration that an actor can attain while approaching target longitudinal distance to reference actor, returned as a double.

The `UserDefinedAction` structure contains information about a user-defined action, if any, for the specified actor at the current time step. This table describes the fields of the `UserDefinedAction` structure.

Field Name	Description
<code>ActorAction</code>	Information about the current action of the specified actor, returned as a <code>struct</code> .
<code>Name</code>	Action name, returned as a <code>string</code> .
<code>Parameters</code>	Custom parameters of the user-defined action, returned as a <code>struct</code> . This structure contains the name and value of each custom parameter.

The fields of the `ActorAction` structure are described in the table under `LaneChangeAction` structure.

Version History

Introduced in R2022a

See Also

`Simulink.ActorSimulation`

load

Load saved simulation log

Syntax

```
log = load(ScenarioSim,'SimulationLog',FileName)
```

Description

`log = load(ScenarioSim,'SimulationLog',FileName)` loads saved file `FileName` that stores the log of scenario simulation `ScenarioSim`.

Input Arguments

ScenarioSim — Scenario simulation

`Simulink.ScenarioSimulation` object

Scenario simulation for which log file is loaded, specified as a `Simulink.ScenarioSimulation` object.

FileName — Name of file

string scalar | character vector

Name of log file to be loaded, specified as a string scalar or character vector.

Output Arguments

log — Simulation log

`Simulink.ScenarioLog` object

Simulation log, returned as a `Simulink.ScenarioLog` object. For more information on examining the contents of a log file, see `Simulink.ScenarioLog`.

Version History

Introduced in R2023a

See Also

`set` | `save`

sendEvent

Send event to scenario

Syntax

```
sendEvent(actorSim, 'ActionComplete', 'ActionID')  
sendEvent(actorSim, 'UserDefinedEvent', 'eventName', 'eventStruct')
```

Description

`sendEvent(actorSim, 'ActionComplete', 'ActionID')` sends an event indicating completion of the user-defined action `ActionID` by the actor `actorSim` to a scenario.

`sendEvent(actorSim, 'UserDefinedEvent', 'eventName', 'eventStruct')` sends a user-defined event by the actor `actorSim` to a scenario. `eventName` contains parameters in the structure `eventStruct`.

Examples

Send Action Completion Event to a Scenario

Send an action completion event for the user-defined action named `CustomBrakes`.

```
sendEvent(mActorHdl, 'ActionComplete', 'CustomBrakes');
```

Send User-Defined Event to a Scenario

Send a user-defined event named `UD1` to a scenario.

```
function interface = getInterfaceImpl(~)  
    import matlab.system.interface.*;  
    interface = ActorInterface();  
    attribute = struct('ActorID', 3);  
    overtakeTruckEvent = matlab.system.interface.UserDefinedEvent('LaneChange', attribute);  
    interface.addEvent('UserDefinedEvent', overtakeTruckEvent);  
function stepImpl(obj, ~)  
    for i = 1 : length(actorsim)  
        redCar = actorsim(i);  
        id = double(getAttribute(redCar, 'ID'));  
        if(obj.HasSentEvent)  
            obj.mActorSimulationHdl.sendEvent('UserDefinedEvent', 'LaneChange', attribute);  
        end  
    end
```

Input Arguments

actorSim — Actor

`Simulink.ActorSimulation` object

Actor for which an event is sent, specified as a `Simulink.ActorSimulation` object.

ActionID — Action identifier

string scalar | character vector

Identifier of the completed action, specified as a string or character vector.

eventName — Name of user-defined event

string scalar | character vector

Name of user-defined event sent to a scenario, specified as a string scalar or character vector. The user-defined event must be defined and added to the interface of a MATLAB System object actor model through the `getInterfaceImpl` function.

eventStruct — Name of event structure

string scalar | character vector

Name of event structure carrying parameters with corresponding values for a user-defined event, specified as a string scalar or character vector.

The parameters can be of the following data types.

- double
- uint16
- int32
- uint32
- string
- Boolean

Version History

Introduced in R2022b

R2023a: Send a user-defined event to all actors in a scenario

Starting in R2023a, you can use `sendEvent` to send user-defined events from an actor to a scenario, or from an actor to all other actors in a scenario.

See Also

`getAction` | `Simulink.ActorSimulation`

receiveEvent

Receive event from scenario

Syntax

```
eventStruct = receiveEvent(actorSim, 'UserDefinedEvent', 'eventName')
```

Description

`eventStruct = receiveEvent(actorSim, 'UserDefinedEvent', 'eventName')` listens for and returns event structure corresponding to received user-defined event `eventName` for actor `actorSim`.

Examples

Receive User-Defined Event from a Scenario

Receive user-defined event `Trigger0overtake` from a scenario.

```
receiveEvent(actorWhiteSedan, 'UserDefinedEvent', 'Trigger0overtake')
```

Input Arguments

actorSim — Actor

`Simulink.ActorSimulation` object

Actor that receives an event, specified as a `Simulink.ActorSimulation` object.

eventName — Name of user-defined event

string scalar | character vector

Name of user-defined event received from a scenario, specified as a string scalar or character vector. The user-defined event must be defined and added to the interface of a MATLAB System object actor model through the `getInterfaceImpl` function.

Output Arguments

eventStruct — Event structure

structure

User-defined event from a scenario, returned as a `struct`.

Field Name	Description
LogicEvent	Information about the specified user-defined event, returned as a <code>struct</code> .

Field Name	Description
Name	Name of the user-defined event, returned as a string.
Parameters	Parameters of the user-defined event, returned as a struct. This structure contains the name and value of each custom parameter.

This table describes the LogicEvent structure.

Field Name	Description
EventType	Type of event, returned as an enumeration variable. The value of the variable can be: <ul style="list-style-type: none"> • UserDefined — User-defined event type.
PublishType	Method of publishing, returned as an enumeration variable. The value of the variable can be: <ul style="list-style-type: none"> • Broadcast — User-defined event sent from an actor is broadcast to all other actors in a scenario.

Version History

Introduced in R2023a

See Also

getAction | Simulink.ActorSimulation

getAttribute

Return static attribute of actor

Syntax

```
a = getAttribute(actor, 'attribute')
```

Description

`a = getAttribute(actor, 'attribute')` returns the value of the specified static attribute for the `Simulink.ActorModel` object `actor`.

Examples

Get Specified Attributes of Actor

Create `ss`, a `Simulink.ScenarioSimulation` object.

```
rrApp = roadrunner('C:\Project\TestHighwayRoute');  
openScenario(rrApp, 'myScenario1');  
ss = createSimulation(rrApp);
```

Start the simulation.

```
set(ss, 'SimulationCommand', 'Start')
```

Pause the simulation.

```
set(ss, 'SimulationCommand', 'Pause')
```

Get all actors in the simulation.

```
actorsAll = get(ss, 'ActorSimulation')
```

Get the static specifications of the first actor.

```
actormodel = get(actorsAll(1), 'ActorModel')
```

Get the paint color of the first actor.

```
pc = getAttribute(actormodel, 'PaintColor')
```

Input Arguments

actor — Actor

`Simulink.ActorModel` object

Actor from which to return static attribute, specified as a `Simulink.ActorModel` object.

Example: `pc = getAttribute(actor, 'BoundingBox')`

attribute – Static attribute of actor

ID | Name | PaintColor | BoundingBox | WheelSpec

Static attribute of actor, specified as one of these values.

Parameter	Description
ID	Actor identifier, returned as a positive integer
Name	Actor name, returned as a string
PaintColor	Color of the actor
BoundingBox	Bounding box of the actor
WheelSpec	Wheel specifications of vehicle-type actor

Example: `pc = getAttribute(actormodel, 'PaintColor')`**Output Arguments****a – Value of static attribute of actor**

uint64 | character vector | string | struct

Value of static attribute of actor, returned as one of these data types.

Parameter	Output Data Type
ID	uint64
Name	char
PaintColor	struct
BoundingBox	struct
WheelSpec	struct

This table describes the fields of the `PaintColor` struct.

Field Name	Description
r	Red color, returned as a uint32 value.
g	Green color, returned as a uint32 value.
b	Blue color, returned as a uint32 value.
a	Transparency of the color (alpha), returned as a uint32 value.

This table describes the fields of the `BoundingBox` struct.

Field Name	Description
Min	The bounding box corner with minimal x-, y- and z- values, returned as a 1-by-3 array.
Max	The bounding box corner with maximal x-, y- and z- values, returned as a 1-by-3 array.

This table describes the fields of the `WheelSpec` struct.

Field Name	Description
AxleIndex	Axle index of a wheel. The front-most axle has the starting index value of zero, with index values increasing towards the vehicle rear. Returned as a uint32 value.
WheelOffset	x-, y- and z- coordinates of the wheel center, in the vehicle coordinate system. Returned as a 1-by-3 vector.
WheelRadius	Radius of the wheel in meters. Returned as a double.

Version History

Introduced in R2022a

See Also

`Simulink.ActorSimulation` | `Simulink.ActorModel` | `Simulink.ScenarioSimulation`

getAttribute

Get runtime attribute of actor

Syntax

```
runtimeAttr = getAttribute(actorSim, 'RuntimeAttrName')
```

Description

`runtimeAttr = getAttribute(actorSim, 'RuntimeAttrName')` returns the specified runtime attribute of the `Simulink.ActorSimulation` object `actorSim`. When you use this function inside the `stepImpl` method of MATLAB System object, the function returns the states from the previous time step except the actor ID.

Examples

Get Runtime Attributes of Actor

Create a `Simulink.ScenarioSimulation` object for a scenario with multiple actors.

```
rrApp = roadrunner('C:\Project\TestHighwayRoute');
openScenario(rrApp, 'myScenario1');
sim = createSimulation(rrApp);
```

Start the simulation.

```
set(sim, 'SimulationCommand', 'Start');
```

Pause the simulation.

```
set(sim, 'SimulationCommand', 'Pause');
```

Get all actors from the simulation.

```
actorsim = get(sim, 'ActorSimulation');
```

Get the first two actors from the list.

```
one = actorsim(1);
two = actorsim(2);
```

Get the ID of the first actor.

```
id = getAttribute(one, 'ID')
```

```
id =
```

```
uint64
```

```
1
```

Get the pose of the first actor.

```
pose = getAttribute(one, 'Pose')
```

```
pose =
```

```
    0.1096    0.9940   -0.0000  -28.1452
   -0.9940    0.1096    0.0000   -3.2291
    0.0000    0.0000    1.0000   -0.0000
         0         0         0     1.0000
```

Get the velocity of the second actor.

```
velocity = getAttribute(two, 'Velocity')
```

```
velocity =
```

```
    6.9507    2.8702    0.0000
```

Get the angular velocity of the first actor.

```
angvelocity = getAttribute(two, 'AngularVelocity')
```

```
angvelocity =
```

```
    0    0.23    0
```

Get the wheel poses of the second actor.

```
wheelposes = getAttribute(two, 'WheelPoses')
```

```
wheelposes = getAttribute(two, 'WheelPoses')
wheelposes(:, :, 1) =
```

```
    0.9972   -0.0671   -0.0330   -0.5672
   -0.0747   -0.8946   -0.4405    1.3838
         0    0.4417   -0.8971    0.3441
         0         0         0     1.0000
```

```
wheelposes(:, :, 2) =
```

```
    0.9974   -0.0650   -0.0320    0.5672
   -0.0725   -0.8948   -0.4406    1.3838
         0    0.4417   -0.8971    0.3441
         0         0         0     1.0000
```

```
wheelposes(:, :, 3) =
```

```
    1.0000         0         0   -0.5672
         0   -0.8971   -0.4417   -1.3295
         0    0.4417   -0.8971    0.3441
         0         0         0     1.0000
```

```
wheelposes(:, :, 4) =
```

```
    1.0000         0         0    0.5672
         0   -0.8971   -0.4417   -1.3295
         0    0.4417   -0.8971    0.3441
         0         0         0     1.0000
```

Get the map location of the first actor.

```
ml = getAttribute(one, 'LaneLocation')

ml =
    struct with fields:
        IsOnLane: 1
        LocationOnLane: [1x1 struct]

ml.IsOnLane

ans =
    logical
    1

ml.LocationOnLane

ans =
    struct with fields:
        LaneID: '{7c2e895c-6b90-4892-aa6e-9ed116db53b5}'
        Position: 0.5359
        Angle: 0.0014
```

Input Arguments

actorSim — Actor

Simulink.ActorSimulation object

Actor from which to return runtime attribute, specified as a Simulink.ActorSimulation object.

Example: actorSim

RuntimeAttrName — Name of runtime attribute

ID | Pose | Velocity | AngularVelocity | WheelPoses | LaneLocation | Children | Parent

Name of runtime attribute to be retrieved, specified as one of these strings.

- ID
- Pose
- Velocity
- AngularVelocity
- WheelPoses
- LaneLocation
- Children
- Parent

Output Arguments

runtimeAttr — Runtime attribute of actor

uint64 | double | struct

Runtime attribute of actor, returned as data type corresponding to input argument RuntimeAttrName.

Runtime Attribute	Description
ID	Actor identifier, returned as a <code>uint64</code> .
Pose	Position and orientation of actor in the RoadRunner Scenario coordinate system, returned as a 4-by-4 array.
Velocity	Velocity of actor in the <i>x</i> -, <i>y</i> - and <i>z</i> - directions, returned as a 1-by-3 vector. Units are in meters per second.
AngularVelocity	Angular velocity of actor in the <i>x</i> -, <i>y</i> - and <i>z</i> - directions, returned as a 1-by-3 vector. Units are in radians per second.
WheelPoses	<p>Runtime pose of each wheel of vehicle-type actor, returned as a multidimensional 4-by-4-by-<i>N</i> array. <i>N</i> is the number of wheels of the vehicle-type actor.</p> <p><code>WheelPoses</code> is returned for wheels starting on the leftmost side of the front axle, and moving to the right. After the first axle is complete, the leftmost wheel on the second axle is taken into consideration before moving to the right, and so on.</p>
LaneLocation	Location of actor with respect to the lane it is mapped to.
Children	<p>Immediate children of specified actor, if any, returned as an array of <code>Simulink.ActorSimulation</code> objects.</p> <p>If the specified actor does not have any child actors, then an empty array is returned.</p>
Parent	<p>Immediate parent of specified actor, returned as an <code>Simulink.ActorSimulation</code> object.</p> <p>If the specified actor itself is a parent, then the <code>Simulink.ActorSimulation</code> object corresponding to the world actor is returned.</p>

This table describes the fields of the `LaneLocation` structure.

Field Name	Description
IsOnLane	Boolean value indicating if the actor is located on a lane. An actor is considered to be on a certain lane if its model origin lies in between the left and right boundaries of this lane.
LocationOnLane	Current lane of actor, returned as a <code>struct</code> . If an actor straddles several lanes, the most aligned lane is returned.

The table describes the fields of the `LocationOnLane` structure of the `LaneLocation` structure.

Field Name	Description
LaneID	UUID identifier of the most aligned lane, returned as a string.
Position	Position of the actor on the lane-center polyline (in s-value). The s-value is a double value within [0, 1] that indicates a position on a 3-D polyline with 0 at the start and 1 at the end of the polyline.
Angle	Angle between the actor travel direction and tangent at the lane position. Units are in radians.

Version History

Introduced in R2022a

See Also

`Simulink.ActorSimulation` | `Simulink.ScenarioSimulation` | `setAttribute`

removeObserver

Remove observer from scenario simulation

Syntax

```
removeObserver(ScenarioSim, ObserverName)
```

Description

`removeObserver(ScenarioSim, ObserverName)` removes the observer named `ObserverName` from the `Simulink.ScenarioSimulation` object `ScenarioSim`.

Examples

Remove Observer from Scenario Simulation

Create `ScenarioSim`, a `Simulink.ScenarioSimulation` object.

```
rrApp = roadrunner('C:\RoadRunnerProject');  
openScenario(rrApp, 'TrajectoryCutIn');  
ScenarioSim = createSimulation(rrApp);
```

Create the class `mySysObserver`, which inherits from `matlab.System` base class. The `mySysObserver` class represents an observer.

```
classdef mysysobserver < matlab.System
```

```
properties(Access=private)
```

```
% ...
```

```
end
```

```
methods
```

```
% constructor for the System object
```

```
function obj = mysysobserver()
```

```
end
```

```
end
```

```
methods(Access = protected)
```

```
%reset the values
```

```
function resetImpl(obj)
```

```
obj.mScenarioSimObj = Simulink.ScenarioSimulation.find('ScenarioSimulation', 'SystemObject', obj)
```

```
obj.mScenarioSimActorList = [];
```

```
obj.mIsPacingTurnedOff = false;
```

```
end
```

```
% get the required parameter values
```

```
function stepImpl(obj)
```

```
mSimulationPace = obj.mScenarioSimObj.get('SimulationPace');
```

```
mScenarioSimActorList = obj.mScenarioSimObj.get('ActorSimulation');
```



```
end  
end  
end
```

Add the observer to the scenario.

```
obsStatus = addObserver(ScenarioSim, 'ReadPaceandActors',mysysObserver);
```

Remove the observer from the scenario.

```
removeObserver(ScenarioSim, 'ReadPaceandActors');
```

Input Arguments

ScenarioSim — RoadRunner Scenario simulation

Simulink.ScenarioSimulation object

RoadRunner Scenario simulation, specified as a Simulink.ScenarioSimulation object.

Example: `removeObserver(ScenarioSim, 'ObservingRedTruck')`

ObserverName — Name of observer

string | character vector

Name of observer to remove, specified as a string or character vector.

Example: `'ObservingRedTruck'`

Version History

Introduced in R2022a

See Also

`addObserver` | `matlab.System` | `Simulink.ScenarioSimulation` | `Simulink.ActorSimulation`

reportDiagnostic

Report information, warning or error message during scenario simulation

Syntax

```
reportDiagnostic(ss, 'MessageType', 'MessageString')
```

Description

`reportDiagnostic(ss, 'MessageType', 'MessageString')` reports a diagnostic message `MessageString` of `MessageType`: information, warning or error for the scenario simulation `ss`. The diagnostic message is displayed in the output window of RoadRunner Scenario.

Examples

Report Warning Message During Simulation

Create `ss`, a `Simulink.ScenarioSimulation` object.

```
rrApp = roadrunner('C:\Project\TestHighwayRoute');  
openScenario(rrApp, 'myScenario1');  
ss = createSimulation(rrApp);
```

Start the simulation.

```
set(ss, 'SimulationCommand', 'Start')
```

Report a warning during the simulation.

```
reportDiagnostic(ss, 'Warning', 'Vehicle A is running a red light!')
```

Input Arguments

ss — RoadRunner Scenario simulation

`Simulink.ScenarioSimulation` object

RoadRunner Scenario simulation, specified as a `Simulink.ScenarioSimulation` object. The diagnostic message is reported for this simulation.

Example: `reportDiagnostic(ss, 'Warning', 'Vehicle A is running a red light!')`

MessageType — Type of diagnostic message

Error | Warning | Information

Type of diagnostic message to be displayed in the output window of RoadRunner Scenario, specified as one of these string values.

- **Information** — Information message type. A reported information message does not affect progress of the simulation.

- **Warning** — Warning message type. A reported warning does not affect progress of the simulation.
- **Error** — Error message type. A reported error causes the simulation to stop.

MessageString — Diagnostic message

string | character vector

Diagnostic message to be displayed in the output window of RoadRunner Scenario, specified as a string or character vector.

Example: 'Vehicle A is running a red light!'

Version History

Introduced in R2022a

See Also

Simulink.ScenarioSimulation

save

Save simulation log to file for later replay

Syntax

```
save(ScenarioSim, 'SimulationLog', 'FileName')
```

Description

`save(ScenarioSim, 'SimulationLog', 'FileName')` saves the log for completed scenario simulation `ScenarioSim` into file `FileName`.

Examples

Save a Simulation Log to a File

Create `ScenarioSim`, a `Simulink.ScenarioSimulation` object.

```
rrApp = roadrunner('C:\Project\TestRoute');  
openScenario(rrApp, 'TrajectoryCutIn');  
ScenarioSim = createSimulation(rrApp);
```

Enable scenario simulation logging in MATLAB

```
set(ScenarioSim, Logging="On");
```

Start the simulation, and let it play to completion.

```
set(ScenarioSim, SimulationCommand="Start");
```

Save the scenario simulation log.

```
save(ScenarioSim, 'SimulationLog', 'scenarioRun1');
```

Input Arguments

ScenarioSim — Scenario simulation

`Simulink.ScenarioSimulation` object

Scenario simulation for which log is saved, specified as a `Simulink.ScenarioSimulation` object.

FileName — Name of file to which simulation log is saved

character vector | string

Name of file in which simulation log is stored, specified as a character vector or string. The `rrsimlog` extension of the file is not included. The name of the file must be unique in the current path.

`FileName` can be expressed in one of these ways, depending on the location in which you want to save the file.

Name of the file	The file is saved in the current folder Example: 'scenarioRun1'
Absolute path of the file	The file is saved in the specified path, which can be outside the current MATLAB search path. Example: 'C:\ScenarioSim\metadata\scenarioRun1.rrsimlog'

Version History

Introduced in R2023a

See Also

set | load

set

Set value of scenario simulation parameter

Syntax

```
set(ScenarioSim,Name=Value)  
set(ScenarioSim,Name=Value,FileName)
```

Description

`set(ScenarioSim,Name=Value)` sets the value of the specified parameter in the `Simulink.ScenarioSimulation` object `ScenarioSim`.

`set(ScenarioSim,Name=Value,FileName)` replays the scenario `ScenarioSim` from the file `FileName` when the simulation command is set to replay through the `Name=Value` argument.

Examples

Set Scenario Simulation Parameters

Create `ss`, a `Simulink.ScenarioSimulation` object

```
rrApp = roadrunner('C:\Project\TestHighwayRoute');  
openScenario(rrApp,'myScenario1');  
ss = createSimulation(rrApp);
```

Set the simulation step size.

```
set(ss,StepSize=0.02)
```

Set the maximum simulation time.

```
set(ss,MaxSimulationTime=1200)
```

Set the simulation pacer status.

```
set(ss,PacerStatus="On")
```

Set the simulation pace.

```
set(ss,SimulationPace=1)
```

Set command to pause the simulation.

```
set(ss,SimulationCommand="Pause")
```

Turn on logging for the simulation.

```
set(ss,Logging="On")
```

Input Arguments

ScenarioSim — RoadRunner Scenario simulation

Simulink.ScenarioSimulation object

RoadRunner Scenario simulation, specified as a Simulink.ScenarioSimulation object.

Example: `set(ss,MaxSimulationTime=1000)`

Name-Value Pair Arguments

Specify optional pairs of arguments as `Name1=Value1, ..., NameN=ValueN`, where `Name` is the argument name and `Value` is the corresponding value. Name-value arguments must appear after other arguments, but the order of the pairs does not matter.

Example: `set(ss,SimulationCommand='Start')` starts playing the specified simulation.

StepSize — Step size of the simulation

double

Step size of the simulation in seconds, specified as a double. The default value is 0.02 seconds.

MaxSimulationTime — Maximum simulation time

double

Maximum simulation time in seconds, specified as a double. The default value is 1000 seconds.

PacerStatus — Pacer status of the simulation

"On" | "Off"

Pacer status of the simulation, specified as one of these strings.

- "On" — Pacing is turned on. You can slow down or speed up the simulation.
- "Off" — Pacing is turned off. You cannot slow down or speed up the simulation.

SimulationPace — Pace of the simulation

double

Pace of the simulation, specified as a double. Indicates speed of the simulation run.

Logging — Logging status of the simulation

"On" | "Off"

Logging status of the simulation, specified as one of these strings.

- "On" — Logging is turned on. You can retrieve simulation and actor information at each time step.
- "Off" — Logging is turned off. You cannot retrieve simulation and actor information at each time step.

SimulationCommand — Command to control simulation

"Start" | "Pause" | "Continue" | "Stop" | "Replay"

Command to control simulation, specified as one of these strings.

- "Start" — Start playing an unstarted or stopped simulation.
- "Pause" — Pause a running simulation.
- "Continue" — Continue playing a paused simulation.
- "Stop" — Stop playing a running or paused simulation.
- "Replay" — Replay a scenario from the simulation log stored in FileName.

FileName — Name of file from which scenario is replayed

string scalar | character vector

Name of file with `rrsimlog` extension from which a scenario simulation is replayed.

Example: `set(ScenarioSim, SimulationCommand= "Replay", 'simulationLogFile1')` replays a scenario from a simulation log file named `simulationLogFile1.rrsimlog` that exists in the current folder.

Version History

Introduced in R2022a

R2023a: Replay a scenario simulation from a saved file

Starting in R2023a, you can use the `set` function to replay a scenario simulation from a saved `.rrsimlog` file.

See Also

`Simulink.ScenarioSimulation` | `get` | `save`

setAttribute

Set runtime attribute of actor

Syntax

```
setAttribute(actorSim,Name=Value)
```

Description

`setAttribute(actorSim,Name=Value)` sets the value of the specified runtime attribute for the `Simulink.ActorSimulation` actor `actorSim`. Using this command, you can set one runtime attribute at a time.

Examples

Set Runtime Attributes of Actor

Set the pose of an actor.

```
setAttribute(actorSim,Pose=[0.1694 0.9855 -0.0000 -90.7324; -0.9855 0.1694 -0.0000 -12.9314; -0.0000 0.0000 1.0000 -0.0000])
```

Set the velocity of an actor.

```
setAttribute(actorSim,Velocity=[2.6216 3.0288 0.0000])
```

Input Arguments

actorSim — Actor

`Simulink.ActorSimulation` object

Actor for which to set attribute, specified as a `Simulink.ActorSimulation` object.

Example: `setAttribute(actorSim,AngularVelocity=[0.4100 0.5000 0.0000])`

Name-Value Pair Arguments

Specify optional pairs of arguments as `Name1=Value1, ..., NameN=ValueN`, where `Name` is the argument name and `Value` is the corresponding value. Name-value arguments must appear after other arguments, but the order of the pairs does not matter.

Example: `setAttribute(actorSim, Pose=[0.1694 0.9855 -0.0000 -90.7324; -0.9855 0.1694 -0.0000 -12.9314; -0.0000 0.0000 1.0000 -0.0000; 0 0 0 1.0000])` sets the pose of an actor to the specified value.

Pose — Actor pose

array

Actor pose, specified as a 4-by-4 array. Indicates the position and orientation of an actor in the RoadRunner Scenario coordinate system.

Example: Pose=[0.1694 0.9855 -0.0000 -90.7324; -0.9855 0.1694 -0.0000 -12.9314; -0.0000 0.0000 1.0000 -0.0000; 0 0 0 1.0000]

Velocity – Actor velocity

array

Actor velocity in the x -, y - and z - directions, specified as a 1-by-3 vector. Units are in meters per second.

Example: Velocity=[17.6216 3.0288 0.0000]

AngularVelocity – Angular velocity of actor

array

Angular velocity of actor in the x -, y - and z - directions, specified as a 1-by-3 vector. Units are in radians per second.

Example: AngularVelocity=[0.6216 0.0288 1.0000]

WheelPoses – Runtime pose of each wheel of actor

array

Runtime pose of each wheel of actor, specified as a multidimensional 4-by-4-by- N array. N is the number of wheels of the vehicle-type actor.

`WheelPoses` is set for wheels starting from the leftmost side on the front axle, moving to the right. After the first axle is complete, the leftmost wheel on the second axle is taken into consideration before moving to the right, and so on

Version History

Introduced in R2022a

See Also

`Simulink.ActorSimulation | getAttribute`

Simulink.ActorModel

View static specifications of actor

Description

Use a `Simulink.ActorModel` object to view the static specifications of an actor in a scenario simulation.

Creation

Every `Simulink.ActorSimulation` object has one corresponding `Simulink.ActorModel` object that contains static actor properties such as `PaintColor`. Retrieve the `Simulink.ActorModel` object of an actor by using the `get` function of its corresponding `Simulink.ActorSimulation` object.

Object Functions

`getAttribute` Return static attribute of actor

Examples

View Static Specifications of Actor

Create `scenarioSim`, a `Simulink.ScenarioSimulation` object.

```
rrApp = roadrunner('C:\Project\TestRoute')
openScenario(rrApp, 'TrajectoryCutIn');
scenarioSim = createSimulation(rrApp);
```

Start the simulation.

```
set(scenarioSim, 'SimulationCommand', 'Start');
```

Pause the simulation.

```
set(scenarioSim, 'SimulationCommand', 'Pause');
```

Get all the actors from the scenario.

```
actorSim = get(scenarioSim, 'ActorSimulation');
```

Select a specific actor from the returned actors.

```
actorOne = actorSim(1);
```

Retrieve `Simulink.ActorModel` object of the selected actor.

```
actorModel = get(actorOne, 'ActorModel');
```

Version History

Introduced in R2022a

See Also

`roadrunner` | `openScenario` | `createSimulation` | `Simulink.ScenarioSimulation` | `Simulink.ActorSimulation` | `Simulink.ScenarioLog`

Simulink.ActorSimulation

Access and modify runtime specifications of actor

Description

A `Simulink.ActorSimulation` object represents an actor in a scenario simulation. Use a `Simulink.ActorSimulation` object to:

- Access and modify the runtime attributes of an actor.
- Access the actions of an actor in the current simulation time step.

Creation

Retrieve the list of `Simulink.ActorSimulation` objects from a simulation by using the `get` function of a `Simulink.ScenarioSimulation` object. If required, you can then retrieve specific actors.

Object Functions

<code>convertToStruct</code>	Convert actor to MATLAB structure
<code>get</code>	Get scenario or static attribute of actor
<code>getAction</code>	Get actions associated with actor
<code>getAttribute</code>	Get runtime attribute of actor
<code>setAttribute</code>	Set runtime attribute of actor

Examples

Get Actors of Scenario Simulation

Create `Sim`, a `Simulink.ScenarioSimulation` object.

```
rrApp = roadrunner('C:\RoadRunnerProject');
openScenario(rrApp, 'TrajectoryCutIn');
Sim = createSimulation(rrApp);
```

Start the simulation.

```
set(Sim, 'SimulationCommand', 'Start');
```

Get all actors while the simulation runs.

```
actorSim = get(Sim, 'ActorSimulation');
```

Get the first actor only.

```
actorOne = actorSim(1);
```

Version History

Introduced in R2022a

See Also

`roadrunner` | `openScenario` | `createSimulation` | `Simulink.ScenarioSimulation` | `sensorSimulation` | `Simulink.ActorModel` | `Simulink.ScenarioLog`

Simulink.ScenarioLog

View scenario simulation outcomes at any time step

Description

A `Simulink.ScenarioLog` object stores scenario simulation outcomes at all time steps of a simulation. Use a `Simulink.ScenarioLog` object to:

- View actor information, such as runtime attributes and actions, at any time step.
- View simulation information at any time step.
- View diagnostics reported during simulation.
- View values of user-defined action or event parameters at any time step.

Creation

Retrieve the `Simulink.ScenarioLog` object that represents a simulation log by using the `get` function of a `Simulink.ScenarioSimulation` object. You can get the log of a simulation only if it has logging enabled using the `set` function of the `Simulink.ScenarioSimulation` object. You can get the log of a simulation only after it stops playing.

Object Functions

`get` Get logged scenario simulation data

Examples

Get Simulation Log

Create `Sim`, a `Simulink.ScenarioSimulation` object.

```
rrApp = roadrunner('C:\RoadRunnerProject');
openScenario(rrApp, 'TrajectoryCutIn');
Sim = createSimulation(rrApp);
```

Enable logging for the simulation.

```
set(Sim, 'Logging', 'On');
```

Start the simulation.

```
set(Sim, 'SimulationCommand', 'Start');
```

Get the simulation log after the simulation stops playing.

```
simLog = get(Sim, 'SimulationLog');
```

Get Actor Pose at First and Last Time Step

Get IDs of all actors from the simulation log.

```
actorIDs = get(simLog, 'ActorIDs')
```

```
actorIDs =
```

```
    1    2    3
```

Get pose of actor with ID 1 at all time steps of the simulation run.

```
poseActor1 = get(simLog, 'Pose', 'ActorID', 1)
```

```
poseActor1 =
```

```
1×887 struct array with fields:
```

```
    Time  
    Pose
```

Get pose of Actor ID 1 at first time step of the simulation run.

```
poseActor1FirstTimeStep = poseActor1(1)
```

```
poseActor1FirstTimeStep =
```

```
struct with fields:
```

```
    Time: 0  
    Pose: [4×4 double]
```

```
poseActor1FirstTimeStep.Pose
```

```
ans =
```

```
    0.9515    0.3077   -0.0008    7.8466  
   -0.3077    0.9515   -0.0026  -133.5547  
         0    0.0027    1.0000   -5.5290  
         0         0         0    1.0000
```

Get pose of actor with ID 1 at the last time step of the simulation run.

```
poseActor1LastTimeStep = poseActor1(887)
```

```
poseActor1LastTimeStep =
```

```
struct with fields:
```

```
    Time: 17.7200  
    Pose: [4×4 double]
```

```
poseActor1LastTimeStep.Pose
```

```
ans =
```

```
    0.9515    0.3077   -0.0008    7.8466  
   -0.3077    0.9515   -0.0026  167.9377  
         0    0.0027    1.0000   -5.5290  
         0         0         0    1.0000
```

Version History

Introduced in R2022a

See Also

`roadrunner` | `openScenario` | `createSimulation` | `Simulink.ScenarioSimulation` | `Simulink.ActorSimulation` | `Simulink.ActorModel`

Simulink.ScenarioSimulation

Create, access, and control scenario simulation

Description

A `Simulink.ScenarioSimulation` object is the representation of a RoadRunner Scenario simulation in MATLAB. Use a `Simulink.ScenarioSimulation` object to perform these actions:

- Control a simulation: start, pause, resume, stop, or move the simulation a single step forward.
- Access and modify the runtime parameters of a simulation.
- Report custom diagnostic messages during a simulation.

Creation

You can create a `Simulink.ScenarioSimulation` object using the `createSimulation` function.

Object Functions

<code>addObserver</code>	Add observer to scenario simulation
<code>get</code>	Get value of scenario simulation parameter
<code>removeObserver</code>	Remove observer from scenario simulation
<code>reportDiagnostic</code>	Report information, warning or error message during scenario simulation
<code>set</code>	Set value of scenario simulation parameter
<code>Simulink.ScenarioSimulation.find</code>	Return scenario simulations or actors in current MATLAB session

Examples

Create Simulation

Create a RoadRunner Scenario object and open a scenario file.

```
rrApp = roadrunner('C:\Project\TestRoute');  
openScenario(rrApp, 'TrajectoryCutIn');
```

Create the corresponding `Simulink.ScenarioSimulation` object and start the simulation.

```
scenario = createSimulation(rrApp);  
set(scenario, 'SimulationCommand', 'Start');
```

Version History

Introduced in R2022a

See Also

`roadrunner` | `openScenario` | `createSimulation` | `Simulink.ActorSimulation` |
`sensorSimulation` | `Simulink.ActorModel` | `Simulink.ScenarioLog`

Simulink.ScenarioSimulation.find

Return scenario simulations or actors in current MATLAB session

Syntax

```
ss = Simulink.ScenarioSimulation.find('ScenarioSimulation')
ss = Simulink.ScenarioSimulation.find('ScenarioSimulation',Name=Value)
actor = Simulink.ScenarioSimulation.find('ActorSimulation',Name=Value)
```

Description

`ss = Simulink.ScenarioSimulation.find('ScenarioSimulation')` returns all scenario simulations in the current MATLAB session.

`ss = Simulink.ScenarioSimulation.find('ScenarioSimulation',Name=Value)` returns the scenario simulation in the current MATLAB session that contains the actor corresponding to the `Name` and `Value` input arguments.

`actor = Simulink.ScenarioSimulation.find('ActorSimulation',Name=Value)` returns the actor in the current MATLAB session that corresponds to the `Name` and `Value` input arguments.

Examples

Return Scenario Simulations and Actors in Session

Get all simulations in the current MATLAB session.

```
scenarios = Simulink.ScenarioSimulation.find('ScenarioSimulation')
```

Get the actor specified by a known System object handle.

```
actor = Simulink.ScenarioSimulation.find('ActorSimulation',SystemObject=obj)
```

Get the scenario containing the actor specified by a known System object handle.

```
actorScenario = Simulink.ScenarioSimulation.find('ScenarioSimulation',SystemObject=obj)
```

Input Arguments

Name-Value Pair Arguments

Specify optional pairs of arguments as `Name1=Value1, ..., NameN=ValueN`, where `Name` is the argument name and `Value` is the corresponding value. Name-value arguments must appear after other arguments, but the order of the pairs does not matter.

Example: `Simulink.ScenarioSimulation.find('ActorSimulation', SimulinkModel=12.03)` returns the actor with the specified Simulink model handle.

SimulinkModel — Simulink model handle of required actor

double

Simulink model handle of required actor, specified as a double value.

Run the following command to get the model handle of an open Simulink model file that represents an actor object.

```
get_param(gcs, 'Handle');
```

```
Example: Simulink.ScenarioSimulation.find('ActorSimulation',  
SimulinkModel=221.01)
```

SystemObject — System object representing actor

System object

System object representing actor, specified using the System object name.

```
Example: Simulink.ScenarioSimulation.find('ActorSimulation',  
SystemObject=WhiteCar)
```

Output Arguments

ss — Scenario simulation

Simulink.ScenarioSimulation object

Scenario simulation containing actor, returned as a Simulink.ScenarioSimulation object.

actor — Actor

Simulink.ActorSimulation object

Actor corresponding to input arguments, returned as a Simulink.ActorSimulation object.

Version History

Introduced in R2022a

See Also

Simulink.ScenarioSimulation | Simulink.ActorSimulation | Simulink.ActorModel

SensorSimulation

Add sensors and access sensor data from scenario simulation

Description

A `SensorSimulation` object represents a sensor in a scenario simulation. Use a `sensorSimulation` object to:

- Add sensors to actors in a scenario
- Retrieve sensor detection and lane boundary data during simulation

Creation

Retrieve the `SensorSimulation` object from a scenario simulation by using the `get` function of a `Simulink.ScenarioSimulation` object with the "SensorSimulation" option.

Object Functions

<code>addSensors</code>	Add sensors to vehicle actors in RoadRunner scenario
<code>targetPoses</code>	Get positions and orientations of targets in sensor range relative to host vehicle
<code>laneBoundaries</code>	Get lane boundaries relative to host vehicle

Examples

Add Sensors to RoadRunner Scenario Using MATLAB

Define sensor models in MATLAB®, and add them to vehicle actors in a RoadRunner Scenario. Then, obtain ground truth measurements from RoadRunner Scenario, process them into detections for visualization.

Set Up RoadRunner Scenario — MATLAB Interface

Configure your RoadRunner installation and project folder properties. Open the RoadRunner app.

```
rrInstallationPath = "C:\Program Files\RoadRunner R2022b\bin\win64";  
rrProjectPath = "D:\RR\TestProjects";  
  
s = settings;  
s.roadrunner.application.InstallationFolder.PersonalValue = rrInstallationPath;  
rrApp = roadrunner(rrProjectPath);
```

To open the scenario this example uses, you must add the `TrajectoryCutIn-longRun.rrscenario` file from the example folder to your RoadRunner project folder. Then, open the scenario.

```
openScenario(rrApp, "TrajectoryCutIn-longRun")
```

Create a `ScenarioSimulation` object to connect MATLAB to the RoadRunner Scenario simulation and set the step size.

```
scenarioSim = createSimulation(rrApp);  
stepSize = 0.1;  
set(scenarioSim, "StepSize", stepSize);
```

Create a `SensorSimulation` object to control the sensor configuration for the RoadRunner Scenario simulation.

```
sensorSim = get(scenarioSim, "SensorSimulation");
```

Configure Sensors and Add to RoadRunner Scenario

Configure the sensor model consisting of one vision sensor at the front of the ego vehicle using the `visionDetectionGenerator` object. If you want to add multiple sensors, specify unique IDs for each sensor.

```
sensorID = 1;  
sensor = visionDetectionGenerator(SensorIndex=sensorID, ...  
    SensorLocation=[2.4 0], ...  
    MaxRange=50, ...  
    DetectorOutput="Objects only", ...  
    UpdateInterval=stepSize);
```

Add the sensor to the ego vehicle actor in the RoadRunner scenario. Specify the `Actor ID` property for the vehicle.

```
egoVehicleID = 1;  
addSensors(sensorSim, sensor, egoVehicleID)
```

Set up bird's-eye-plot for visualization.

```
[lbPlotter, detPlotter, bepAxes] = helperSetupBEP(sensor);
```

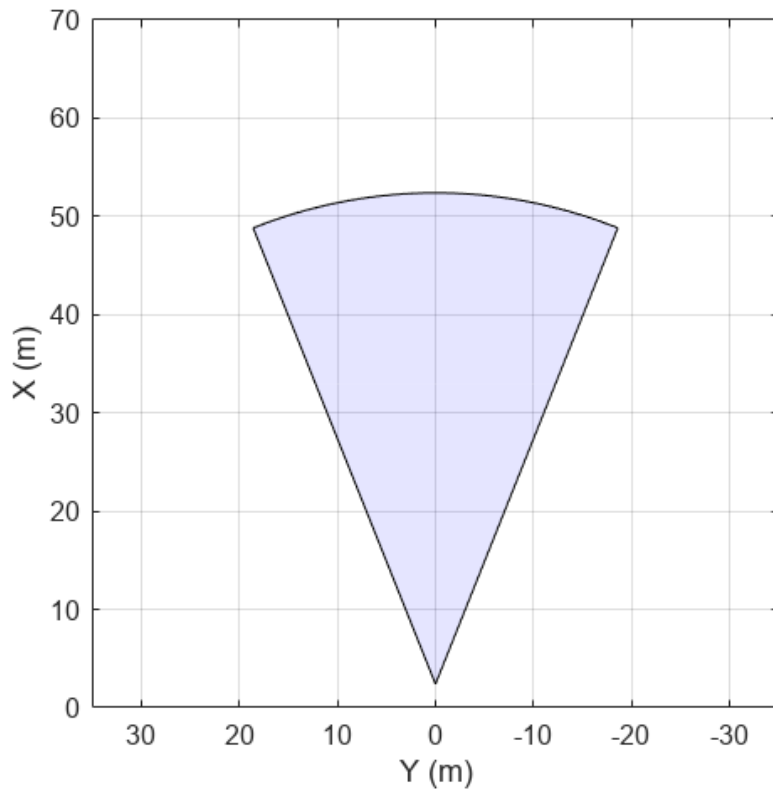

Simulate RoadRunner Scenario and Visualize Sensor Data

Use the `ScenarioSimulation` object to step through the RoadRunner scenario. Retrieve target poses in the sensor range using the `targetPoses` function, and process them into detections using the sensor model. Visualize detections and ground truth lane boundaries using `birdsEyePlot`.

```
simTime = 0.0;
set(scenarioSim,"SimulationCommand","Start");
set(scenarioSim,"SimulationCommand","Pause");
pause(0.5)
legend(bepAxes,"show")

while ~isequal(get(scenarioSim,"SimulationStatus"),"Stopped")

    % Get ground truth target poses and lane boundaries from the sensor
    tgtPoses = targetPoses(sensorSim,1);
```



```
gTruthLbs = laneBoundaries(sensorSim,1,OutputOption="EgoAdjacentLanes",inHostCoordinate=true);
if ~isempty(gTruthLbs)
    % Plot ground-truth lane boundaries
    helperPlotLaneBoundaries(lbPlotter,gTruthLbs)

    % Generate detections
    [objDets,numObjDets,objDetsValid] = sensor(tgtPoses,simTime);

    % Plot detections
    if objDetsValid
        detPos = cellfun(@(d)d.Measurement(1:2),objDets,UniformOutput=false);
        detPos = vertcat(zeros(0,2),cell2mat(detPos'))';
        plotDetection(detPlotter,detPos)
    end

end

if ~isequal(get(scenarioSim,"SimulationStatus"),"Stopped")
    set(scenarioSim,"SimulationCommand","Step");
end

simTime = simTime + stepSize;
pause(0.1)
end
```

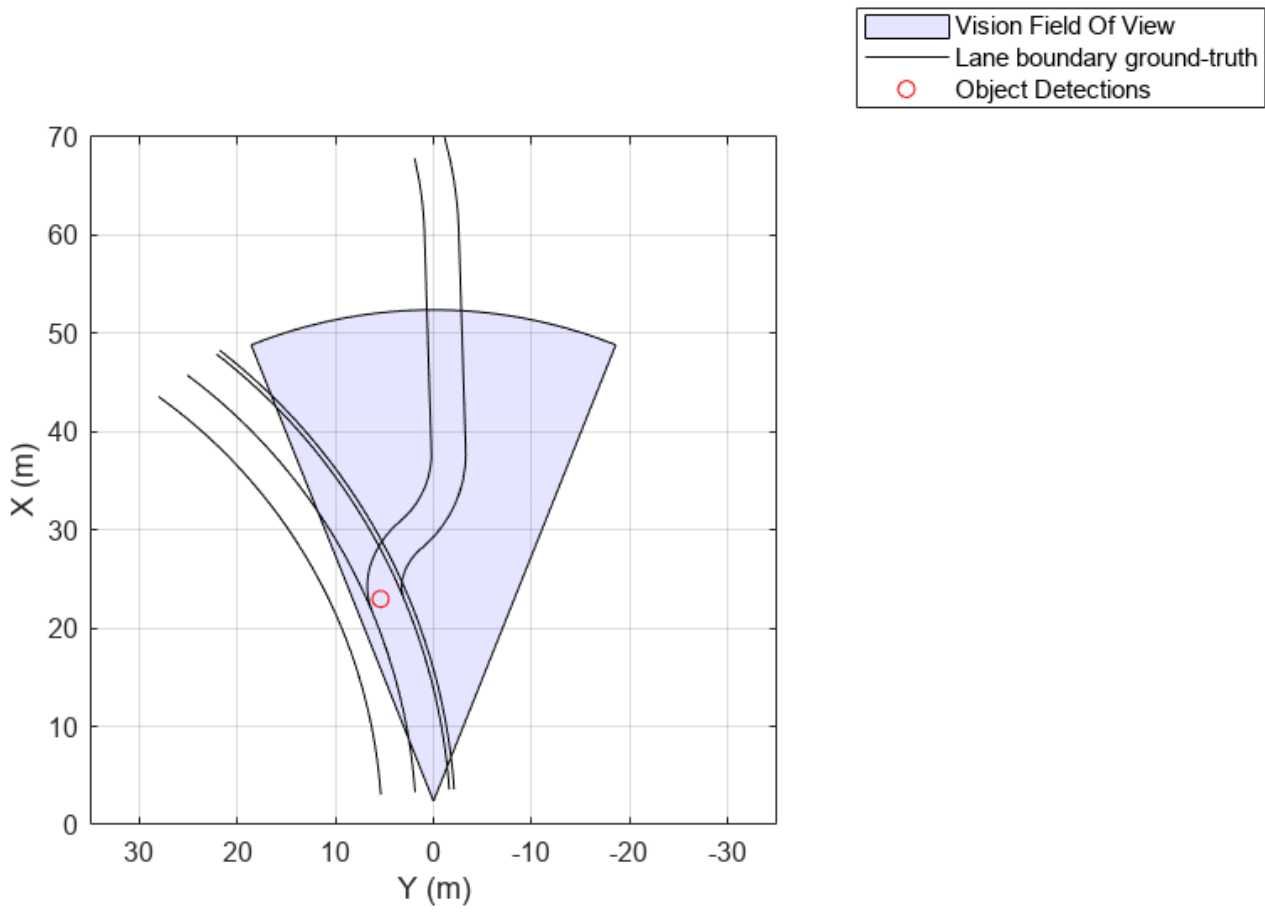

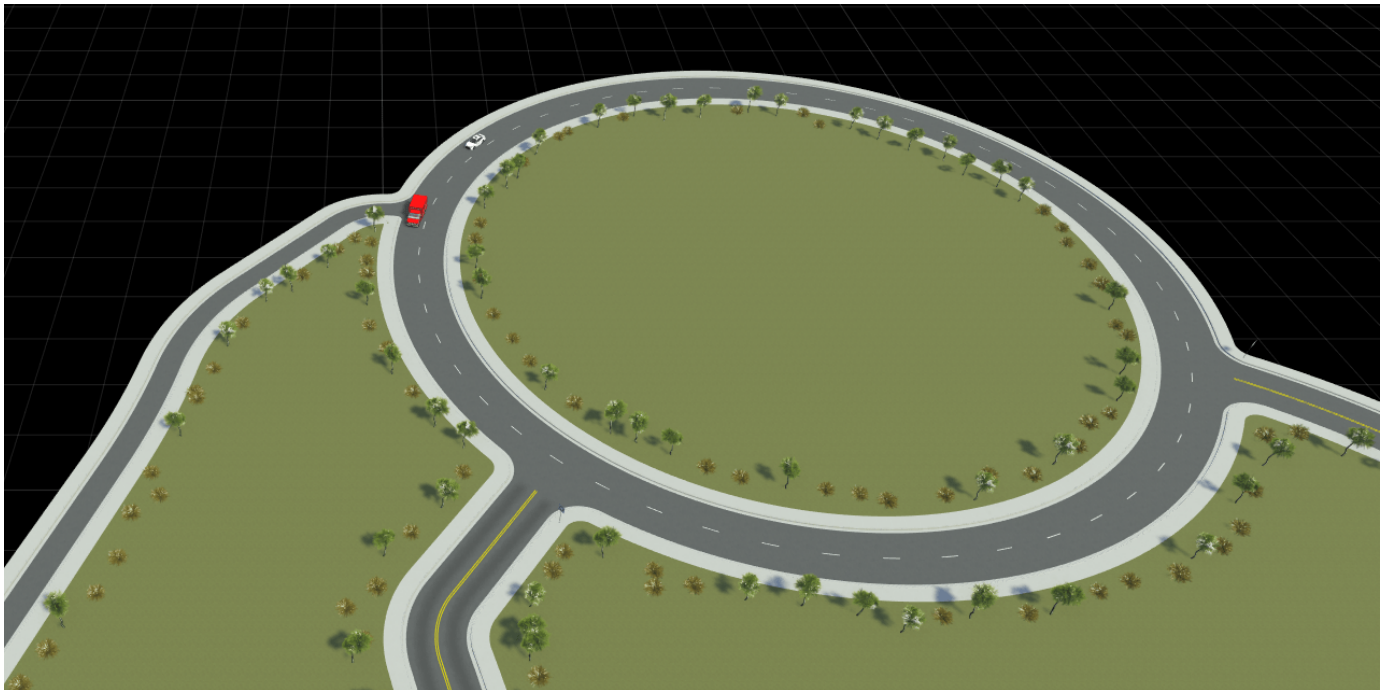

Helper Functions

helperSetupBEP function creates a bird's-eye-plot and configures all the plotters for visualization.

helperPlotLaneBoundaries function plots the lane boundaries on the birds'eye-plot.

Add Sensors to RoadRunner Scenario Using Simulink

Define sensor models in Simulink™, and add them to vehicle actors in a RoadRunner Scenario. Then, obtain ground truth measurements from RoadRunner Scenario, process them into detections in Simulink for visualization.

Set Up RoadRunner Scenario — Simulink Interface

Configure your RoadRunner installation and project folder properties. Open the RoadRunner app.

```
rrInstallationPath = "C:\Program Files\RoadRunner R2022b\bin\win64";
rrProjectPath = "D:\RR\TestProjects";

s = settings;
s.roadrunner.application.InstallationFolder.PersonalValue = rrInstallationPath;
rrApp = roadrunner(rrProjectPath);
```

To open the scenario this example uses, you must add these files from the example folder to your RoadRunner project folder:

- 1 straightCurvedFourLaneRoad.rrscene — RoadRunner scene file that describes the four lane highway.
- 2 SensorDerectionSimulation.rrscenario — RoadRunner scenario file that describes actors and their trajectories on the four lane highway scene.

- 3 `SensorIntegration.rrbehavior.rrmeta` — Behavior file that associates the sensor detection processing and visualization behavior using Simulink, to the ego vehicle in the RoadRunner scenario.

```
copyfile("straightCurvedFourLaneRoad.rrscene",fullfile(rrProjectPath,"Scenes/"));
copyfile("SensorDetectionSimulation.rrscenario",fullfile(rrProjectPath,"Scenarios/"));
copyfile("SensorIntegration.rrbehavior.rrmeta",fullfile(rrProjectPath,"Assets","Behaviors/"))
```

Open the scenario and create a `ScenarioSimulation` object to connect Simulink with the RoadRunner Scenario.

```
openScenario(rrApp,"SensorDetectionSimulation")
rrSim = createSimulation(rrApp);
```

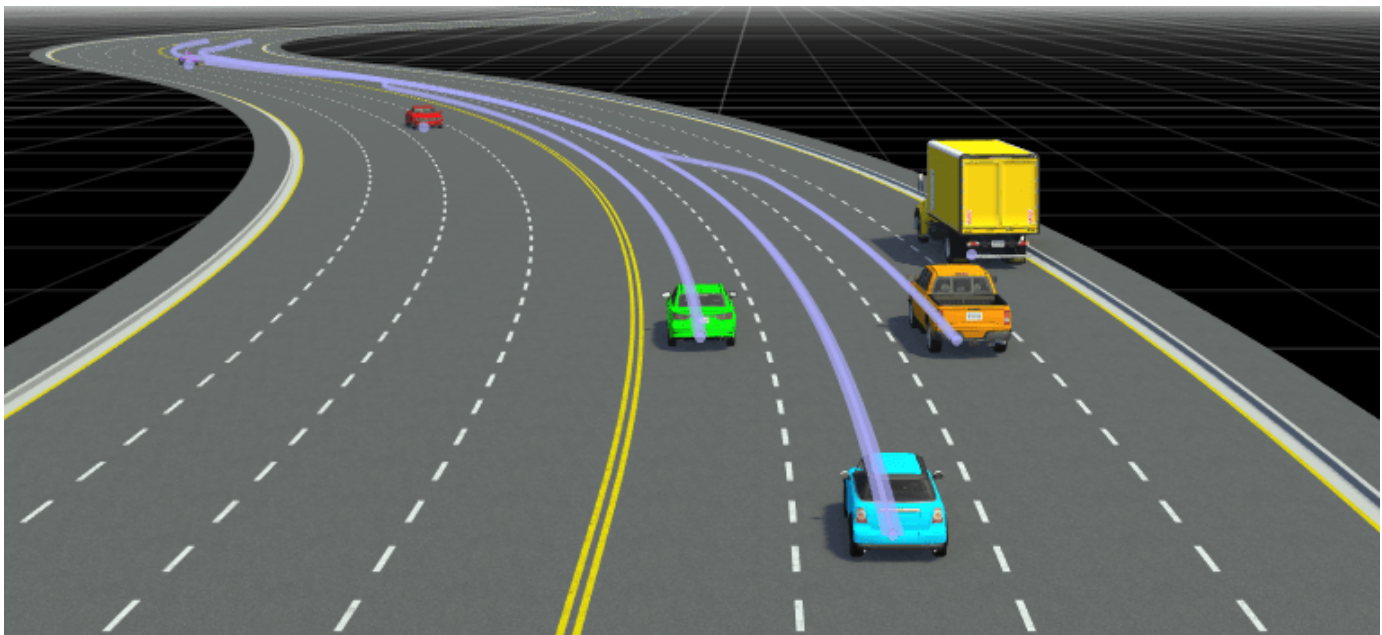

Specify the step size for the RoadRunner scenario simulation. The Simulink model also uses the same step size. Units are in seconds.

```
simStepSize = 0.1;
set(rrSim,"StepSize",simStepSize);
```

Inspect Simulink Model and Simulate Scenario

The Simulink model `rrScenarioSimWithSensors` configures sensor models for the vision and radar sensors to be added to the ego vehicle using Vision Detection Generator and Radar Detection Generator blocks respectively. The model reads ground truth data from the scenario and processes that into detections and visualizes the detections. It also reads the path defined for the ego vehicle from the RoadRunner Scenario, implements the path follower logic and controls the ego vehicle motion along the path.

Load the bus definitions and open the model.

```
load("busDefinitionsForRRSim.mat")
modelName = 'rrScenarioSimWithSensors';
open_system(modelName)
```

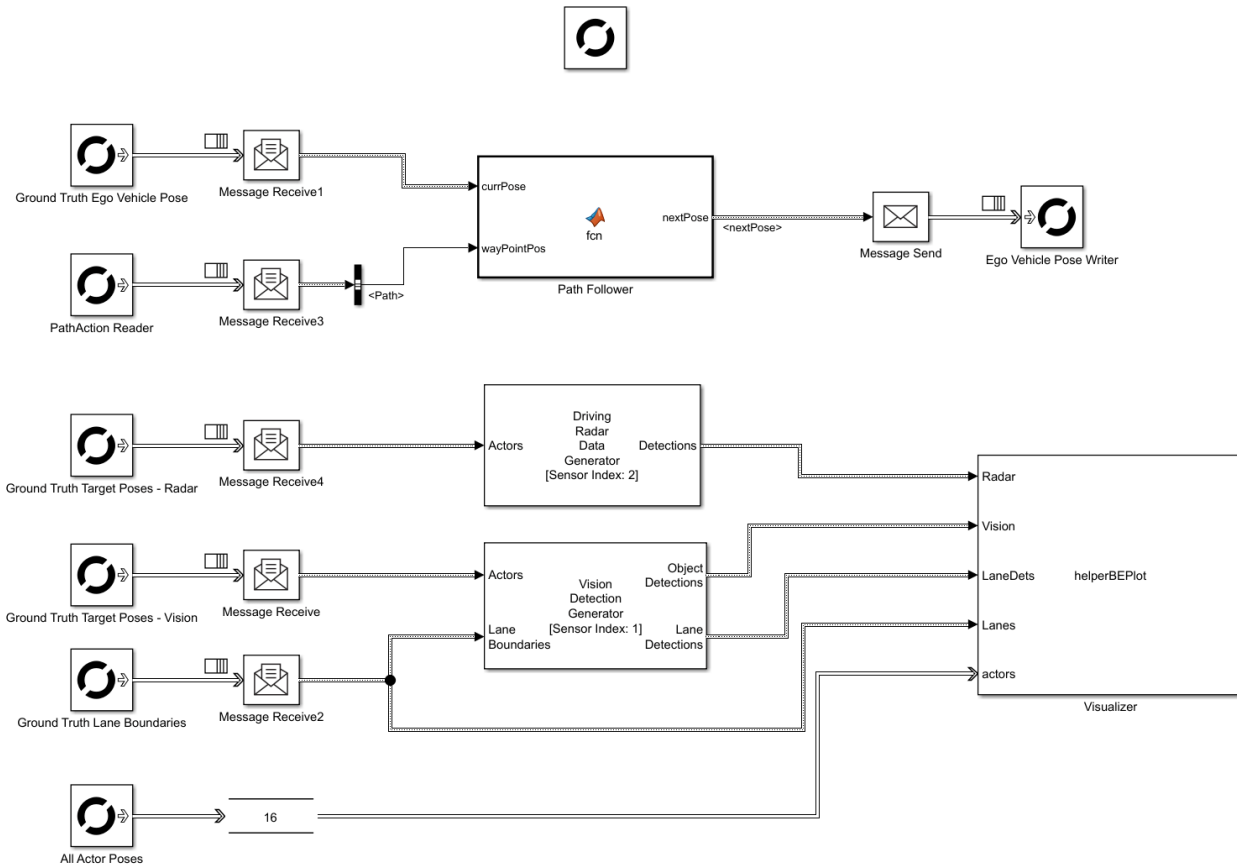

Create a `SensorSimulation` object. Specify the block paths for the radar and vision sensors in the model.

```
sensorSim = get(rrSim, "SensorSimulation");
visionSensorBlkPath = [modelName, '/Vision Detection Generator'];
radarSensorBlkPath = [modelName, '/Driving Radar Data Generator'];
```

Add the two sensors to the ego vehicle using the `addSensors` function.

```
egoVehicleId = 1;
addSensors(sensorSim, {visionSensorBlkPath, radarSensorBlkPath}, egoVehicleId);
```

Get the actor profiles of all the actors in the scenario for visualization.

```
rrScenario = getScenario(rrSim);
actorProfiles = helperGetActorProfiles(rrScenario);
numActors = length(actorProfiles);
numTargets = numActors - 1;
```

Start the scenario Simulation. You can visualize the object detections and lane detections alongside ground truth values.

```
set(rrSim, "SimulationCommand", "Start")
```

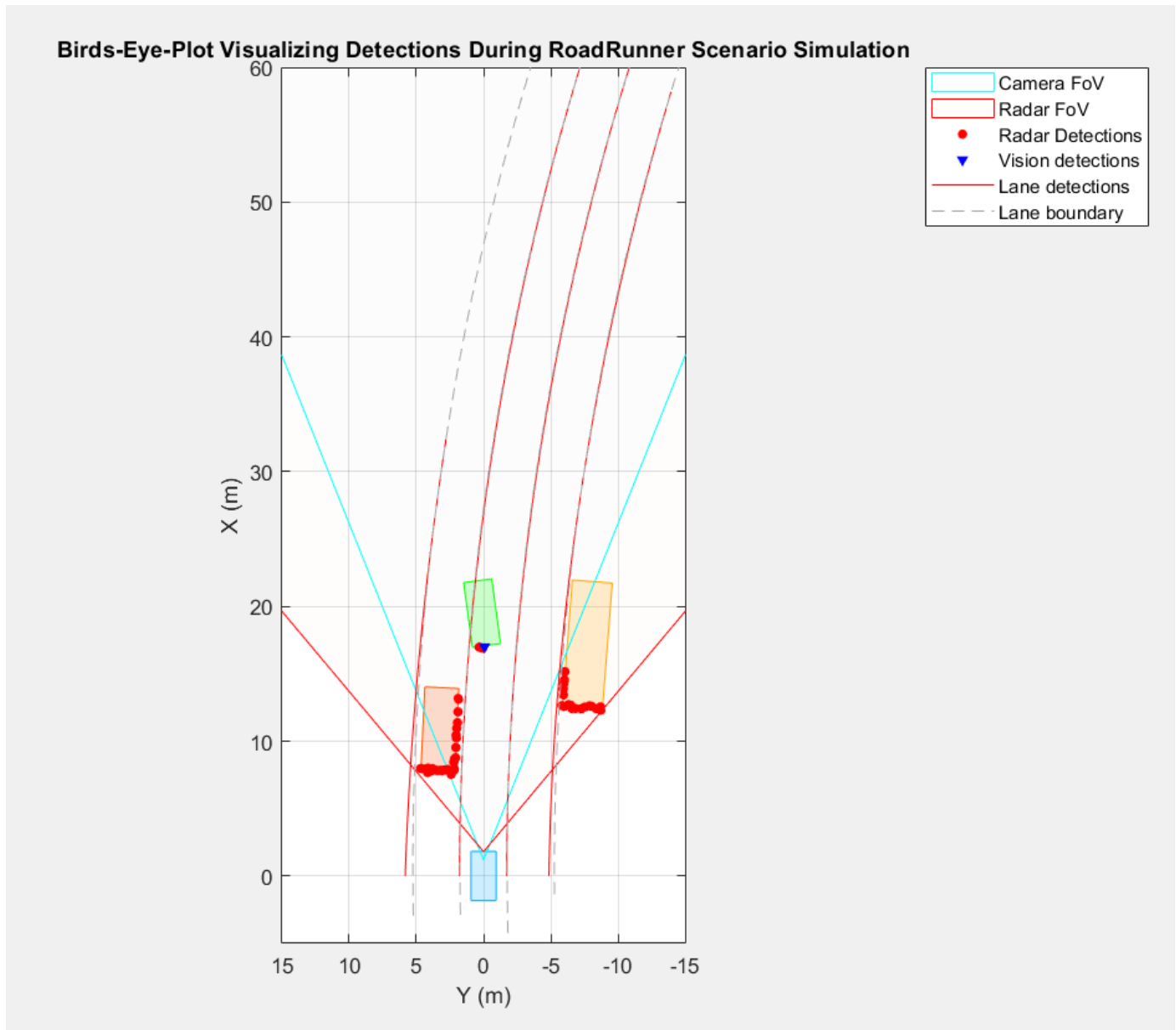

Version History

Introduced in R2023a

See Also

`Simulink.ScenarioSimulation` | `addSensors` | `targetPoses` | `laneBoundaries`

addSensors

Add sensors to vehicle actors in RoadRunner scenario

Syntax

```
addSensors(sensorSim,sensors,actorID)
addSensors(sensorSim,sensorBlkPath,actorID)
```

Description

`addSensors(sensorSim,sensors,actorID)` adds the specified sensors in `sensors` to the vehicle actor with ID `actorID` in the RoadRunner scenario specified by `scenarioSim`. Use this syntax when you define sensor models in MATLAB.

`addSensors(sensorSim,sensorBlkPath,actorID)` adds the sensors with the specified block paths `sensorBlkPath` to the vehicle actor with ID `actorID` in the roadrunner scenario specified by `scenarioSim`. Use this syntax when you define sensor models in Simulink.

Examples

Add Sensors to RoadRunner Scenario Using MATLAB

Define sensor models in MATLAB®, and add them to vehicle actors in a RoadRunner Scenario. Then, obtain ground truth measurements from RoadRunner Scenario, process them into detections for visualization.

Set Up RoadRunner Scenario — MATLAB Interface

Configure your RoadRunner installation and project folder properties. Open the RoadRunner app.

```
rrInstallationPath = "C:\Program Files\RoadRunner R2022b\bin\win64";
rrProjectPath = "D:\RR\TestProjects";

s = settings;
s.roadrunner.application.InstallationFolder.PersonalValue = rrInstallationPath;
rrApp = roadrunner(rrProjectPath);
```

To open the scenario this example uses, you must add the `TrajectoryCutIn-LongRun.rrscenario` file from the example folder to your RoadRunner project folder. Then, open the scenario.

```
openScenario(rrApp,"TrajectoryCutIn-LongRun")
```

Create a `ScenarioSimulation` object to connect MATLAB to the RoadRunner Scenario simulation and set the step size.

```
scenarioSim = createSimulation(rrApp);
stepSize = 0.1;
set(scenarioSim,"StepSize",stepSize);
```

Create a `SensorSimulation` object to control the sensor configuration for the RoadRunner Scenario simulation.

```
sensorSim = get(scenarioSim, "SensorSimulation");
```

Configure Sensors and Add to RoadRunner Scenario

Configure the sensor model consisting of one vision sensor at the front of the ego vehicle using the `visionDetectionGenerator` object. If you want to add multiple sensors, specify unique IDs for each sensor.

```
sensorID = 1;
sensor = visionDetectionGenerator(SensorIndex=sensorID, ...
    SensorLocation=[2.4 0], ...
    MaxRange=50, ...
    DetectorOutput="Objects only", ...
    UpdateInterval=stepSize);
```

Add the sensor to the ego vehicle actor in the RoadRunner scenario. Specify the Actor ID property for the vehicle.

```
egoVehicleID = 1;
addSensors(sensorSim, sensor, egoVehicleID)
```

Set up bird's-eye-plot for visualization.

```
[lbPlotter, detPlotter, bepAxes] = helperSetupBEP(sensor);
```

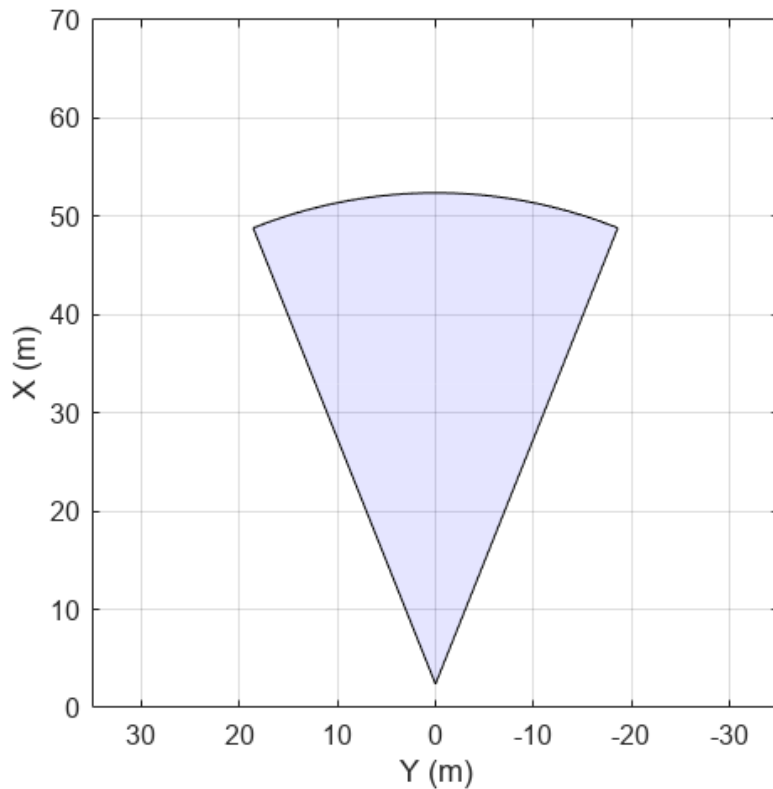
Simulate RoadRunner Scenario and Visualize Sensor Data

Use the `ScenarioSimulation` object to step through the RoadRunner scenario. Retrieve target poses in the sensor range using the `targetPoses` function, and process them into detections using the sensor model. Visualize detections and ground truth lane boundaries using `birdsEyePlot`.

```
simTime = 0.0;
set(scenarioSim,"SimulationCommand","Start");
set(scenarioSim,"SimulationCommand","Pause");
pause(0.5)
legend(bepAxes,"show")

while ~isequal(get(scenarioSim,"SimulationStatus"),"Stopped")

    % Get ground truth target poses and lane boundaries from the sensor
    tgtPoses = targetPoses(sensorSim,1);
```

```
gTruthLbs = laneBoundaries(sensorSim,1,OutputOption="EgoAdjacentLanes",inHostCoordinate=true);
if ~isempty(gTruthLbs)
    % Plot ground-truth lane boundaries
    helperPlotLaneBoundaries(lbPlotter,gTruthLbs)

    % Generate detections
    [objDets,numObjDets,objDetsValid] = sensor(tgtPoses,simTime);

    % Plot detections
    if objDetsValid
        detPos = cellfun(@(d)d.Measurement(1:2),objDets,UniformOutput=false);
        detPos = vertcat(zeros(0,2),cell2mat(detPos'))';
        plotDetection(detPlotter,detPos)
    end

end

if ~isequal(get(scenarioSim,"SimulationStatus"),"Stopped")
    set(scenarioSim,"SimulationCommand","Step");
end

simTime = simTime + stepSize;
pause(0.1)
end
```

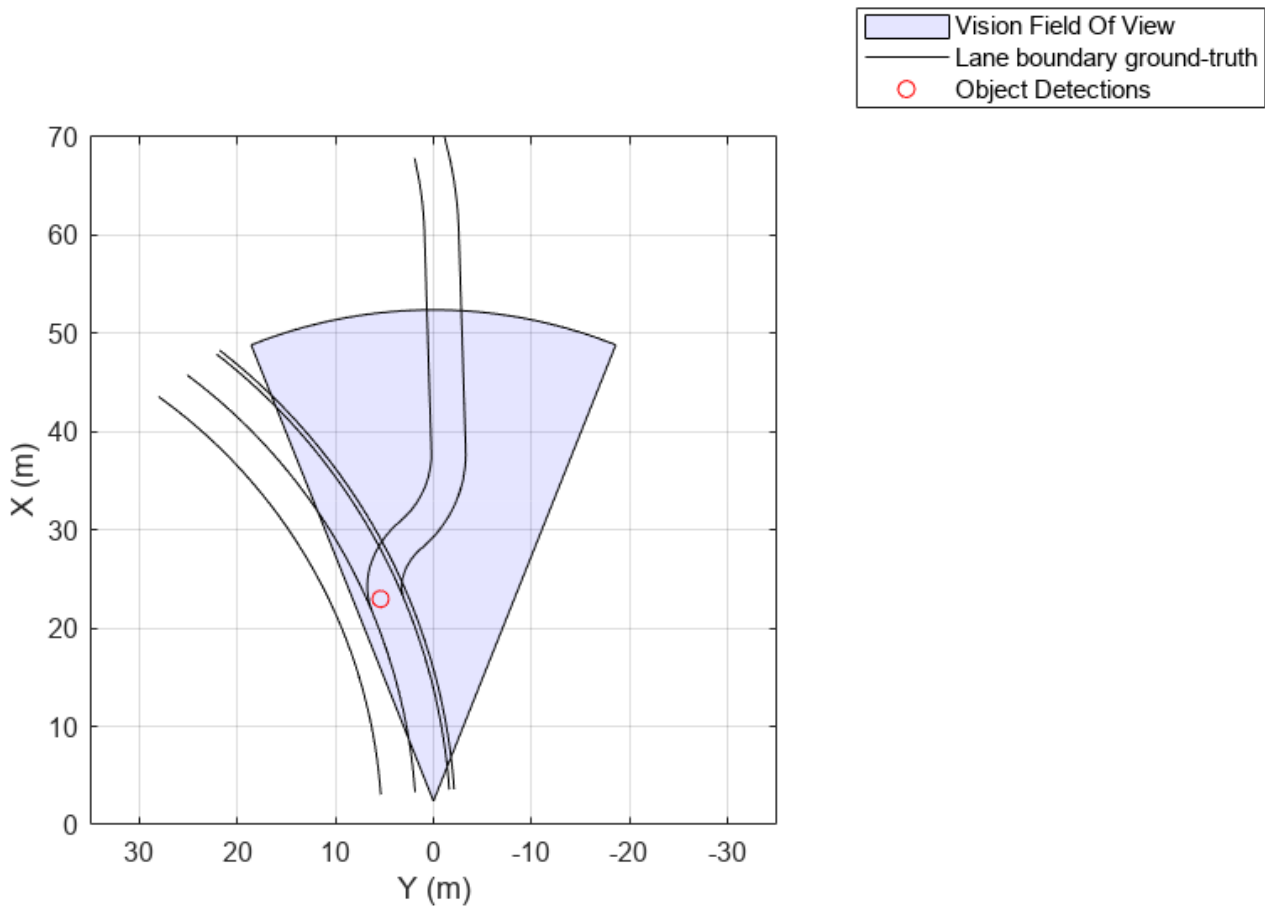

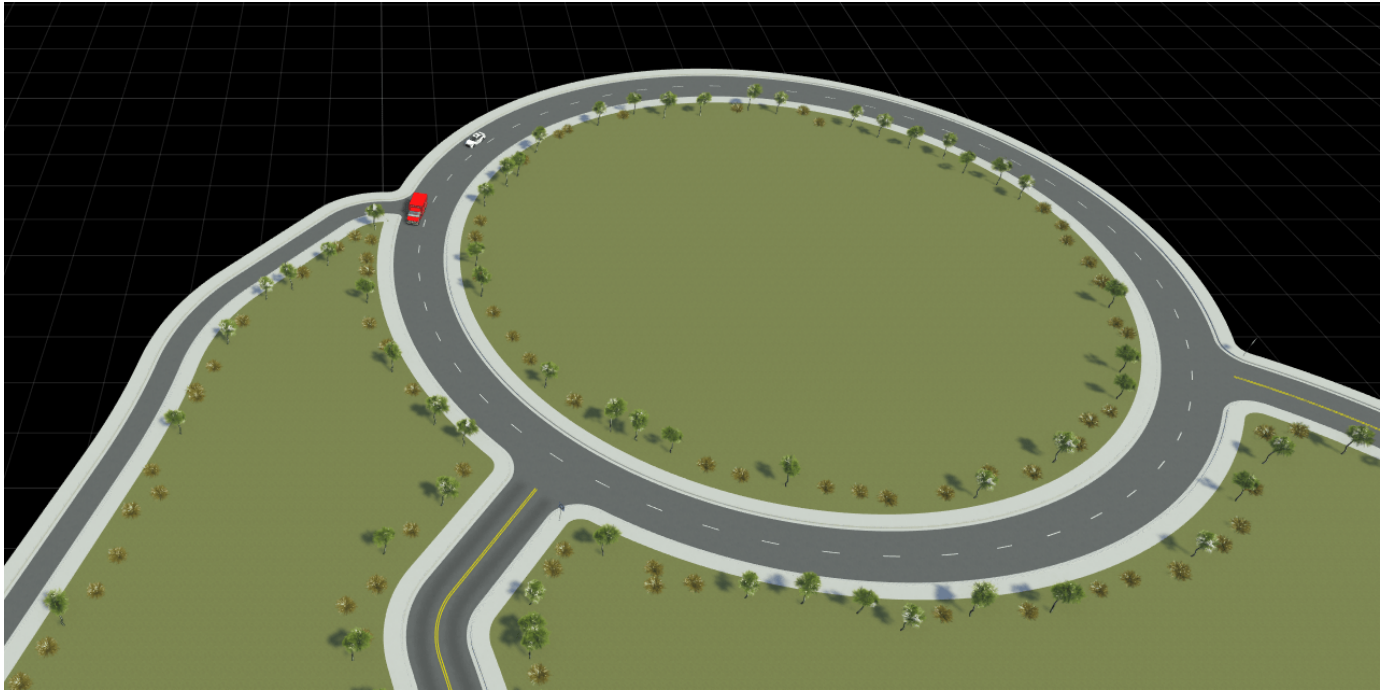

Helper Functions

`helperSetupBEP` function creates a bird's-eye-plot and configures all the plotters for visualization.

`helperPlotLaneBoundaries` function plots the lane boundaries on the birds'eye-plot.

Add Sensors to RoadRunner Scenario Using Simulink

Define sensor models in Simulink™, and add them to vehicle actors in a RoadRunner Scenario. Then, obtain ground truth measurements from RoadRunner Scenario, process them into detections in Simulink for visualization.

Set Up RoadRunner Scenario — Simulink Interface

Configure your RoadRunner installation and project folder properties. Open the RoadRunner app.

```
rrInstallationPath = "C:\Program Files\RoadRunner R2022b\bin\win64";
rrProjectPath = "D:\RR\TestProjects";

s = settings;
s.roadrunner.application.InstallationFolder.PersonalValue = rrInstallationPath;
rrApp = roadrunner(rrProjectPath);
```

To open the scenario this example uses, you must add these files from the example folder to your RoadRunner project folder:

- 1 `straightCurvedFourLaneRoad.rrscene` — RoadRunner scene file that describes the four lane highway.
- 2 `SensorDerectionSimulation.rrscenario` — RoadRunner scenario file that describes actors and their trajectories on the four lane highway scene.

- 3 `SensorIntegration.rrbehavior.rrmeta` — Behavior file that associates the sensor detection processing and visualization behavior using Simulink, to the ego vehicle in the RoadRunner scenario.

```
copyfile("straightCurvedFourLaneRoad.rrscene",fullfile(rrProjectPath,"Scenes/"));
copyfile("SensorDetectionSimulation.rrscenario",fullfile(rrProjectPath,"Scenarios/"));
copyfile("SensorIntegration.rrbehavior.rrmeta",fullfile(rrProjectPath,"Assets","Behaviors/"))
```

Open the scenario and create a `ScenarioSimulation` object to connect Simulink with the RoadRunner Scenario.

```
openScenario(rrApp,"SensorDetectionSimulation")
rrSim = createSimulation(rrApp);
```



Specify the step size for the RoadRunner scenario simulation. The Simulink model also uses the same step size. Units are in seconds.

```
simStepSize = 0.1;
set(rrSim,"StepSize",simStepSize);
```

Inspect Simulink Model and Simulate Scenario

The Simulink model `rrScenarioSimWithSensors` configures sensor models for the vision and radar sensors to be added to the ego vehicle using Vision Detection Generator and Radar Detection Generator blocks respectively. The model reads ground truth data from the scenario and processes that into detections and visualizes the detections. It also reads the path defined for the ego vehicle from the RoadRunner Scenario, implements the path follower logic and controls the ego vehicle motion along the path.

Load the bus definitions and open the model.

```
load("busDefinitionsForRRSim.mat")
modelName = 'rrScenarioSimWithSensors';
open_system(modelName)
```

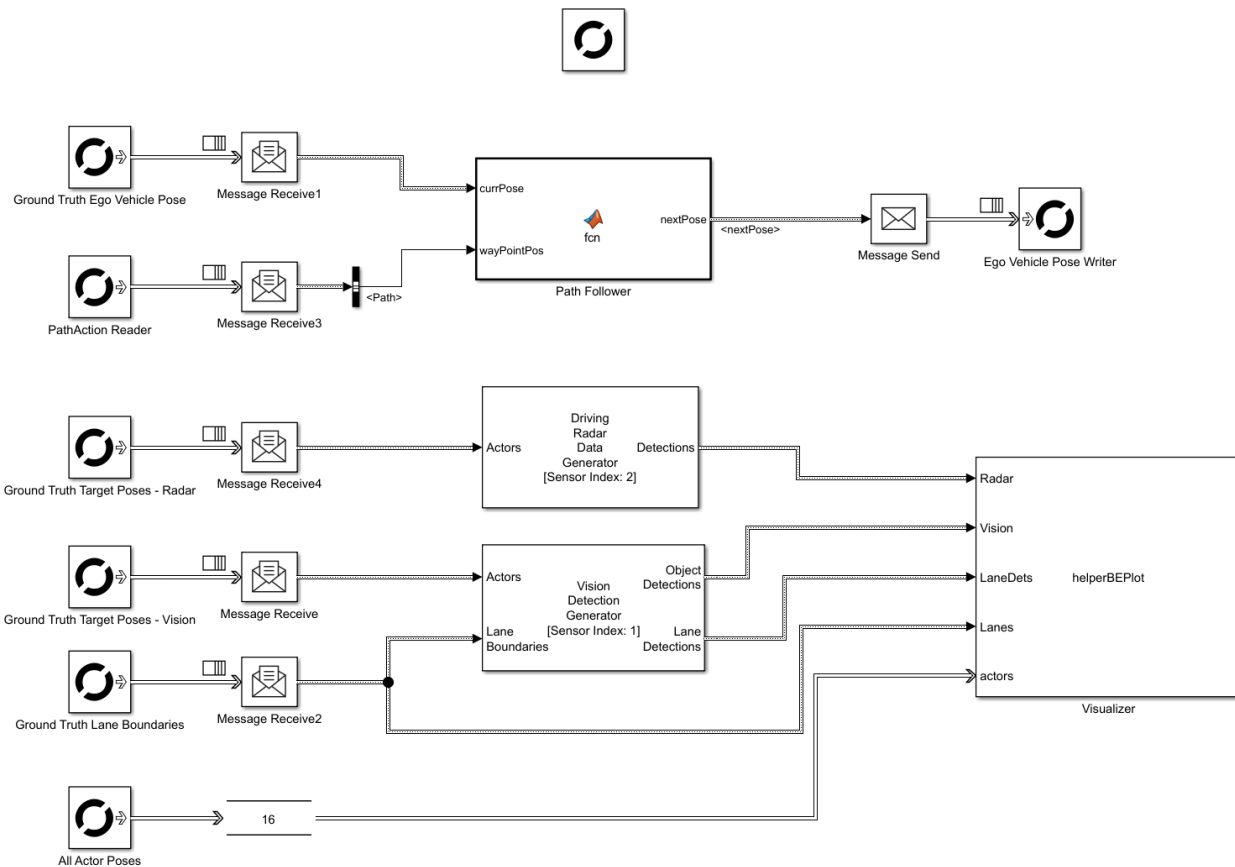

Create a `SensorSimulation` object. Specify the block paths for the radar and vision sensors in the model.

```
sensorSim = get(rrSim, "SensorSimulation");
visionSensorBlkPath = [modelName, '/Vision Detection Generator'];
radarSensorBlkPath = [modelName, '/Driving Radar Data Generator'];
```

Add the two sensors to the ego vehicle using the `addSensors` function.

```
egoVehicleId = 1;
addSensors(sensorSim, {visionSensorBlkPath, radarSensorBlkPath}, egoVehicleId);
```

Get the actor profiles of all the actors in the scenario for visualization.

```
rrScenario = getScenario(rrSim);
actorProfiles = helperGetActorProfiles(rrScenario);
numActors = length(actorProfiles);
numTargets = numActors - 1;
```

Start the scenario Simulation. You can visualize the object detections and lane detections alongside ground truth values.

```
set(rrSim, "SimulationCommand", "Start")
```

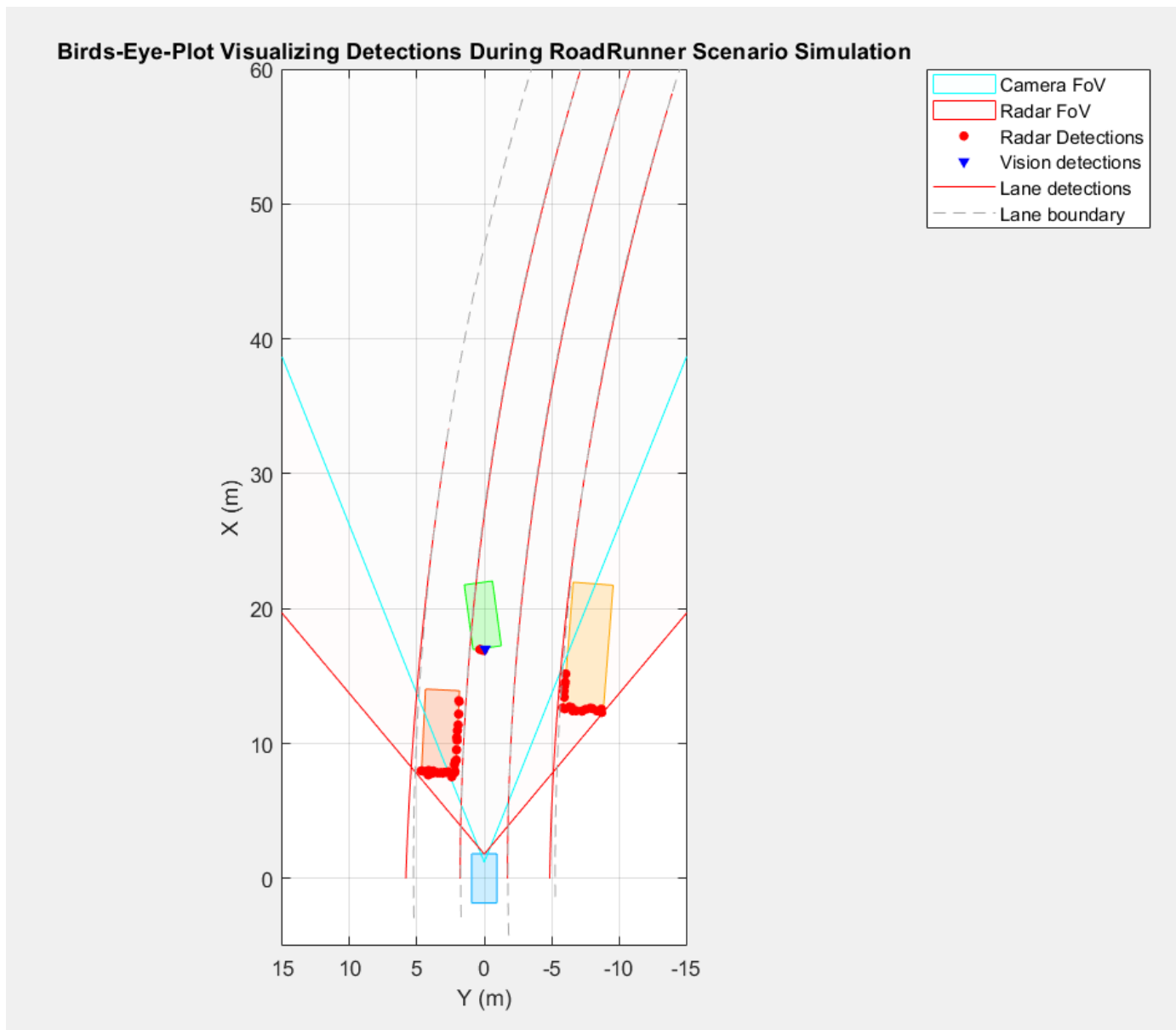

Input Arguments

sensorSim — Sensor simulation object

SensorSimulation object

Sensor simulation object, specified as a SensorSimulation object. The sensor simulation object must correspond to the desired scenario created in RoadRunner Scenario.

sensors — Sensors to add to RoadRunner Scenario simulation

visionDetectionGenerator object | drivingRadarDataGenerator object |
ultrasonicDetectionGenerator object | cell array of detection generator objects

Sensors to add to the RoadRunner Scenario simulation, specified as one of these options:

- A single `visionDetectionGenerator`, `drivingRadarDataGenerator` or `ultrasonicDetectionGenerator` object
- A cell array of any combination of the previously listed detection generator objects

Each detection generator must have a unique sensor ID, specified by its `SensorIndex` property.

sensorBlkPath — Block paths of sensors to add to RoadRunner Scenario simulation

cell array of character vectors

Block paths of sensors to add to the RoadRunner Scenario simulation, specified as a cell array of character vectors. Each block path must point to one of these detection generator blocks:

- Vision Detection Generator
- Ultrasonic Detection Generator
- Driving Radar Data Generator

Each detection generator must have a unique sensor ID, specified by its `Unique sensor identifier` block parameter.

actorID — Actor ID of vehicle in RoadRunner scenario

positive integer

Actor ID of the vehicle in the RoadRunner scenario, specified as a positive integer. The function adds sensors to the vehicle in the scenario with this actor ID.

Version History

Introduced in R2023a

See Also

`SensorSimulation` | `laneBoundaries` | `targetPoses` | `drivingRadarDataGenerator` | `visionDetectionGenerator` | `ultrasonicDetectionGenerator`

laneBoundaries

Get lane boundaries relative to host vehicle

Syntax

```
lbdrys = laneBoundaries(sensorSim,sensorID)
lbdrys = laneBoundaries(sensorSim,sensorID,Name=Value)
```

Description

`lbdrys = laneBoundaries(sensorSim,sensorID)` gets the lane boundaries `lbdrys` of the lane in which the vehicle actor hosting the sensor specified by `sensorID`, is traveling. The lane boundaries are in the coordinate system of the host vehicle.

`lbdrys = laneBoundaries(sensorSim,sensorID,Name=Value)` specifies additional options using one or more name-value arguments.

Examples

Add Sensors to RoadRunner Scenario Using MATLAB

Define sensor models in MATLAB®, and add them to vehicle actors in a RoadRunner Scenario. Then, obtain ground truth measurements from RoadRunner Scenario, process them into detections for visualization.

Set Up RoadRunner Scenario — MATLAB Interface

Configure your RoadRunner installation and project folder properties. Open the RoadRunner app.

```
rrInstallationPath = "C:\Program Files\RoadRunner R2022b\bin\win64";
rrProjectPath = "D:\RR\TestProjects";

s = settings;
s.roadrunner.application.InstallationFolder.PersonalValue = rrInstallationPath;
rrApp = roadrunner(rrProjectPath);
```

To open the scenario this example uses, you must add the `TrajectoryCutIn-longRun.rrscenario` file from the example folder to your RoadRunner project folder. Then, open the scenario.

```
openScenario(rrApp,"TrajectoryCutIn-longRun")
```

Create a `ScenarioSimulation` object to connect MATLAB to the RoadRunner Scenario simulation and set the step size.

```
scenarioSim = createSimulation(rrApp);
stepSize = 0.1;
set(scenarioSim,"StepSize",stepSize);
```

Create a `SensorSimulation` object to control the sensor configuration for the RoadRunner Scenario simulation.

```
sensorSim = get(scenarioSim, "SensorSimulation");
```

Configure Sensors and Add to RoadRunner Scenario

Configure the sensor model consisting of one vision sensor at the front of the ego vehicle using the `visionDetectionGenerator` object. If you want to add multiple sensors, specify unique IDs for each sensor.

```
sensorID = 1;  
sensor = visionDetectionGenerator(SensorIndex=sensorID, ...  
    SensorLocation=[2.4 0], ...  
    MaxRange=50, ...  
    DetectorOutput="Objects only", ...  
    UpdateInterval=stepSize);
```

Add the sensor to the ego vehicle actor in the RoadRunner scenario. Specify the `Actor ID` property for the vehicle.

```
egoVehicleID = 1;  
addSensors(sensorSim, sensor, egoVehicleID)
```

Set up bird's-eye-plot for visualization.

```
[lbPlotter, detPlotter, bepAxes] = helperSetupBEP(sensor);
```

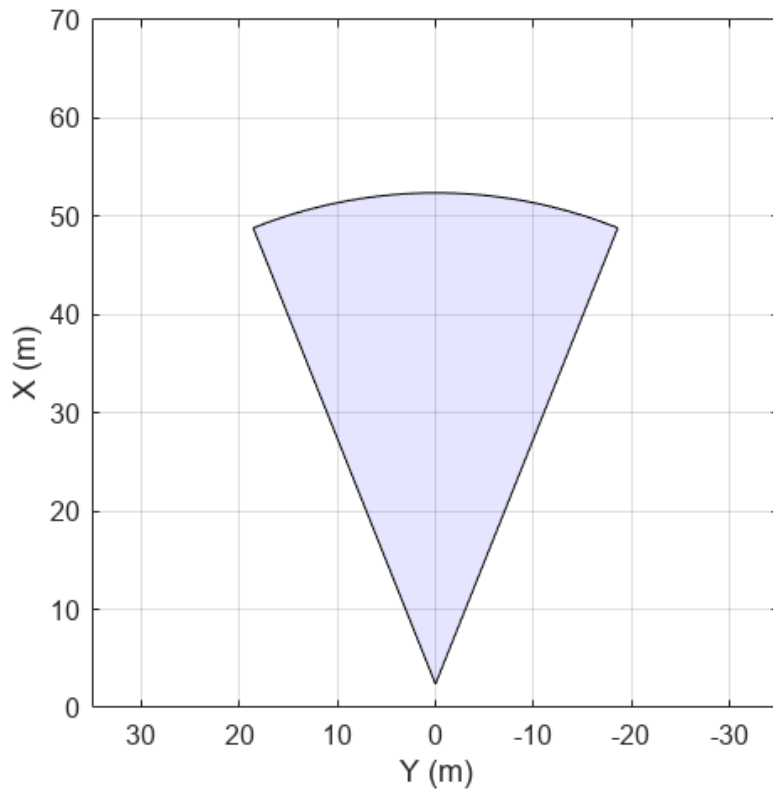

Simulate RoadRunner Scenario and Visualize Sensor Data

Use the `ScenarioSimulation` object to step through the RoadRunner scenario. Retrieve target poses in the sensor range using the `targetPoses` function, and process them into detections using the sensor model. Visualize detections and ground truth lane boundaries using `birdsEyePlot`.

```
simTime = 0.0;
set(scenarioSim,"SimulationCommand","Start");
set(scenarioSim,"SimulationCommand","Pause");
pause(0.5)
legend(bepAxes,"show")

while ~isequal(get(scenarioSim,"SimulationStatus"),"Stopped")

    % Get ground truth target poses and lane boundaries from the sensor
    tgtPoses = targetPoses(sensorSim,1);
```

```
gTruthLbs = laneBoundaries(sensorSim,1,OutputOption="EgoAdjacentLanes",inHostCoordinate=true);
if ~isempty(gTruthLbs)
    % Plot ground-truth lane boundaries
    helperPlotLaneBoundaries(lbPlotter,gTruthLbs)

    % Generate detections
    [objDets,numObjDets,objDetsValid] = sensor(tgtPoses,simTime);

    % Plot detections
    if objDetsValid
        detPos = cellfun(@(d)d.Measurement(1:2),objDets,UniformOutput=false);
        detPos = vertcat(zeros(0,2),cell2mat(detPos'))';
        plotDetection(detPlotter,detPos)
    end

end

if ~isequal(get(scenarioSim,"SimulationStatus"),"Stopped")
    set(scenarioSim,"SimulationCommand","Step");
end

simTime = simTime + stepSize;
pause(0.1)
end
```

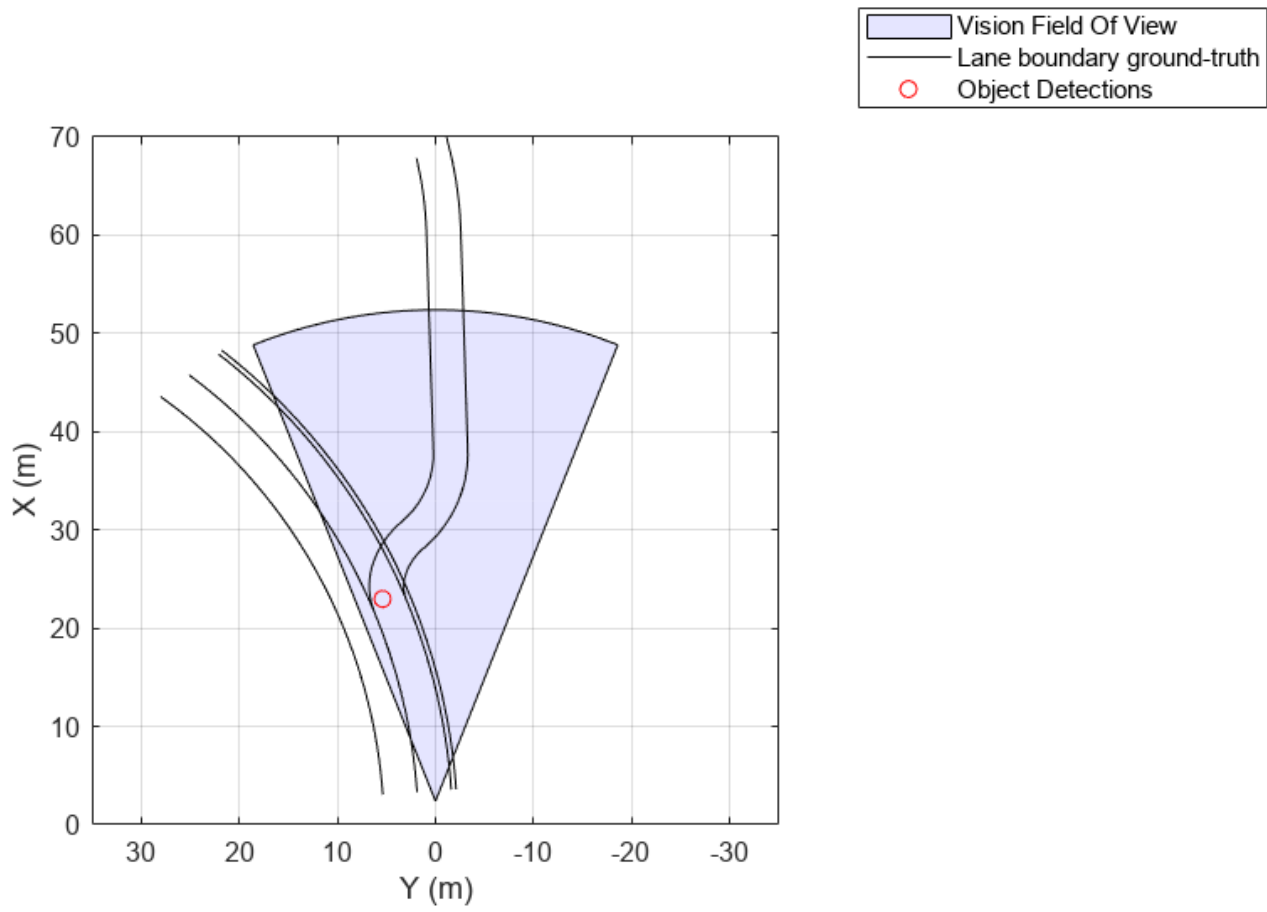

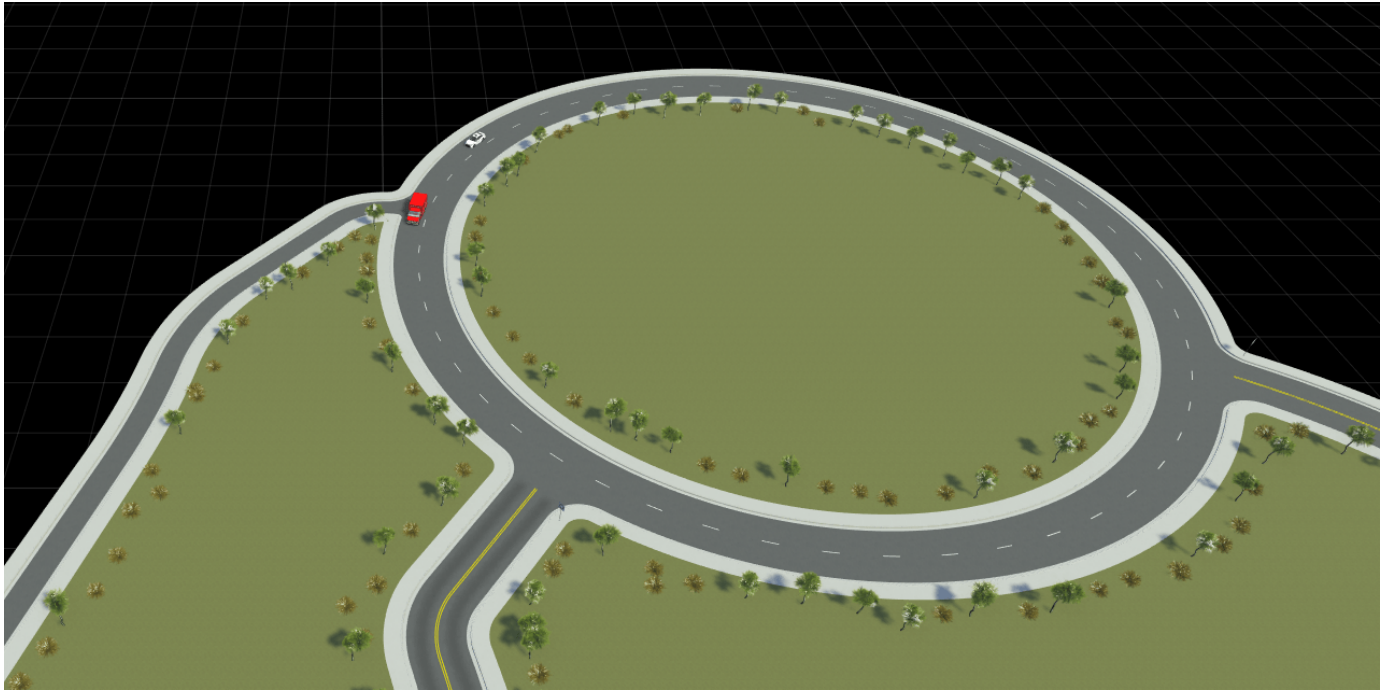

Helper Functions

`helperSetupBEP` function creates a bird's-eye-plot and configures all the plotters for visualization.

`helperPlotLaneBoundaries` function plots the lane boundaries on the birds'eye-plot.

Input Arguments

sensorSim — Sensor simulation object

`SensorSimulation` object

Sensor simulation object, specified as a `SensorSimulation` object. The sensor simulation object must correspond to the desired scenario created in RoadRunner Scenario.

sensorID — Unique index of sensor in RoadRunner Scenario

positive scalar

Unique index of the sensor in the RoadRunner Scenario, specified as a positive scalar. This must be same as the `SensorIndex` property of the detection generator object which corresponds to the desired sensor.

Name-Value Pair Arguments

Specify optional pairs of arguments as `Name1=Value1, ..., NameN=ValueN`, where `Name` is the argument name and `Value` is the corresponding value. Name-value arguments must appear after other arguments, but the order of the pairs does not matter.

Before R2021a, use commas to separate each name and value, and enclose Name in quotes.

OutputOptions — Lane boundaries to output

"EgoLane" (default) | "EgoAdjacentLanes" | "AllLanes"

Lane boundaries to output, specified as one of these options:

- "EgoLane" — The function returns the boundaries for the lane in which the host vehicle actor is traveling.
- "EgoAdjacentLanes" — The function returns the boundaries for the adjacent left and right lanes along with the lane in which host vehicle actor is traveling.
- "AllLanes" — The function returns the boundaries for all lanes on the road.

inHostCoordinate — Enable lane boundaries to be returned in host vehicle coordinates

true or 1 (default) | false or 0

Enable the lane boundaries to be returned in host vehicle coordinates, specified as a logical 1 (true) or 0 (false). Specify this argument as false or 0 to return the lane boundaries in the world coordinates of the RoadRunner scenario.

Output Arguments

lbdrys — Lane boundaries

array of lane boundary structures

Lane boundaries, returned as an array of lane boundary structures. This table shows the fields for each structure.

Field	Description
Coordinates	<p>Lane boundary coordinates, returned as a real-valued N-by-3 matrix, where N is the number of lane boundary coordinates. Lane boundary coordinates define the position of points on the boundary at returned longitudinal distances away from the ego vehicle, along the center of the road.</p> <ul style="list-style-type: none"> • In MATLAB, specify these distances by using the 'XDistance' name-value pair argument of the laneBoundaries function. • In Simulink, specify these distances by using the Distances from ego vehicle for computing boundaries (m) parameter of the Scenario Reader block or the Distance from parent for computing lane boundaries parameter of the Simulation 3D Vision Detection Generator block. <p>This matrix also includes the boundary coordinates at zero distance from the ego vehicle. These coordinates are to the left and right of the ego vehicle origin, which is located under the center of the rear axle. Units are in meters.</p>

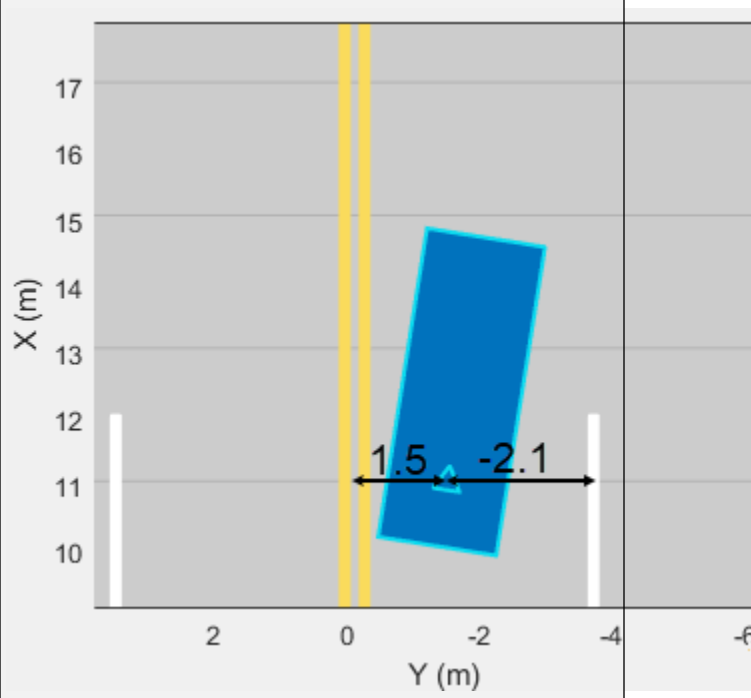
Curvature	Lane boundary curvature at each row of the <code>Coordinates</code> matrix, returned as a real-valued N -by-1 vector. N is the number of lane boundary coordinates. Units are in radians per meter.
CurvatureDerivative	Derivative of lane boundary curvature at each row of the <code>Coordinates</code> matrix, returned as a real-valued N -by-1 vector. N is the number of lane boundary coordinates. Units are in radians per square meter.
HeadingAngle	Initial lane boundary heading angle, returned as a real scalar. The heading angle of the lane boundary is relative to the ego vehicle heading. Units are in degrees.
LateralOffset	Lateral offset of the ego vehicle position from the lane boundary, returned as a real scalar. An offset to a lane boundary to the left of the ego vehicle is positive. An offset to the right of the ego vehicle is negative. Units are in meters. In this image, the ego vehicle is offset 1.5 meters from the left lane and 2.1 meters from the right lane. 

BoundaryType	Type of lane boundary marking, returned as one of these values: <ul style="list-style-type: none"> 'Unmarked' — No physical lane marker exists 'Solid' — Single unbroken line 'Dashed' — Single line of dashed lane markers 'DoubleSolid' — Two unbroken lines 'DoubleDashed' — Two dashed lines 'SolidDashed' — Solid line on the left and a dashed line on the right 'DashedSolid' — Dashed line on the left and a solid line on the right
Strength	Saturation strength of the lane boundary marking, returned as a real scalar from 0 to 1. A value of 0 corresponds to a marking whose color is fully unsaturated. The marking is gray. A value of 1 corresponds to a marking whose color is fully saturated.
Width	Lane boundary width, returned as a positive real scalar. In a double-line lane marker, the same width is used for both lines and for the space between lines. Units are in meters.
Length	Length of dash in dashed lines, returned as a positive real scalar. In a double-line lane marker, the same length is used for both lines.
Space	Length of space between dashes in dashed lines, returned as a positive real scalar. In a dashed double-line lane marker, the same space is used for both lines.

Version History

Introduced in R2023a

See Also

SensorSimulation | targetPoses | addSensors

targetPoses

Get positions and orientations of targets in sensor range relative to host vehicle

Syntax

```
poses = targetPoses(sensorSim,sensorID)
```

Description

`poses = targetPoses(sensorSim,sensorID)` returns poses of all the targets that are in the range of the sensor specified by `sensorID`, with respect to its host vehicle actor. The sensor simulation object `sensorSim` specifies the RoadRunner scenario that contains the host vehicle actor.

Examples

Add Sensors to RoadRunner Scenario Using MATLAB

Define sensor models in MATLAB®, and add them to vehicle actors in a RoadRunner Scenario. Then, obtain ground truth measurements from RoadRunner Scenario, process them into detections for visualization.

Set Up RoadRunner Scenario — MATLAB Interface

Configure your RoadRunner installation and project folder properties. Open the RoadRunner app.

```
rrInstallationPath = "C:\Program Files\RoadRunner R2022b\bin\win64";  
rrProjectPath = "D:\RR\TestProjects";  
  
s = settings;  
s.roadrunner.application.InstallationFolder.PersonalValue = rrInstallationPath;  
rrApp = roadrunner(rrProjectPath);
```

To open the scenario this example uses, you must add the `TrajectoryCutIn-longRun.rrscenario` file from the example folder to your RoadRunner project folder. Then, open the scenario.

```
openScenario(rrApp,"TrajectoryCutIn-longRun")
```

Create a `ScenarioSimulation` object to connect MATLAB to the RoadRunner Scenario simulation and set the step size.

```
scenarioSim = createSimulation(rrApp);  
stepSize = 0.1;  
set(scenarioSim,"StepSize",stepSize);
```

Create a `SensorSimulation` object to control the sensor configuration for the RoadRunner Scenario simulation.

```
sensorSim = get(scenarioSim,"SensorSimulation");
```

Configure Sensors and Add to RoadRunner Scenario

Configure the sensor model consisting of one vision sensor at the front of the ego vehicle using the `visionDetectionGenerator` object. If you want to add multiple sensors, specify unique IDs for each sensor.

```
sensorID = 1;
sensor = visionDetectionGenerator(SensorIndex=sensorID, ...
    SensorLocation=[2.4 0], ...
    MaxRange=50, ...
    DetectorOutput="Objects only", ...
    UpdateInterval=stepSize);
```

Add the sensor to the ego vehicle actor in the RoadRunner scenario. Specify the Actor ID property for the vehicle.

```
egoVehicleID = 1;
addSensors(sensorSim, sensor, egoVehicleID)
```

Set up bird's-eye-plot for visualization.

```
[lbPlotter, detPlotter, bepAxes] = helperSetupBEP(sensor);
```

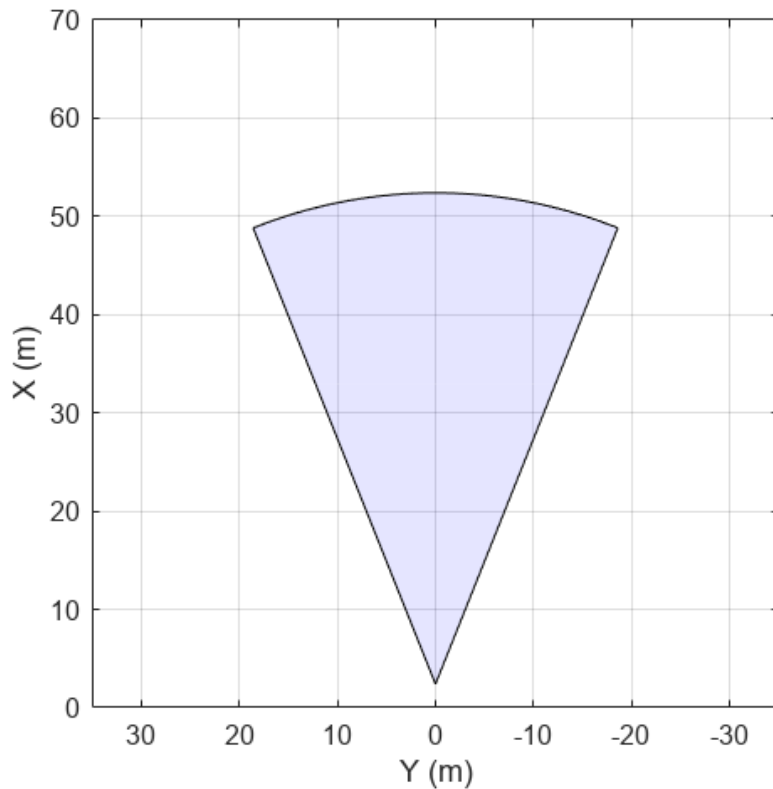

Simulate RoadRunner Scenario and Visualize Sensor Data

Use the `ScenarioSimulation` object to step through the RoadRunner scenario. Retrieve target poses in the sensor range using the `targetPoses` function, and process them into detections using the sensor model. Visualize detections and ground truth lane boundaries using `birdsEyePlot`.

```
simTime = 0.0;
set(scenarioSim,"SimulationCommand","Start");
set(scenarioSim,"SimulationCommand","Pause");
pause(0.5)
legend(bepAxes,"show")

while ~isequal(get(scenarioSim,"SimulationStatus"),"Stopped")

    % Get ground truth target poses and lane boundaries from the sensor
    tgtPoses = targetPoses(sensorSim,1);
```

```
gTruthLbs = laneBoundaries(sensorSim,1,OutputOption="EgoAdjacentLanes",inHostCoordinate=true);
if ~isempty(gTruthLbs)
    % Plot ground-truth lane boundaries
    helperPlotLaneBoundaries(lbPlotter,gTruthLbs)

    % Generate detections
    [objDets,numObjDets,objDetsValid] = sensor(tgtPoses,simTime);

    % Plot detections
    if objDetsValid
        detPos = cellfun(@(d)d.Measurement(1:2),objDets,UniformOutput=false);
        detPos = vertcat(zeros(0,2),cell2mat(detPos'))';
        plotDetection(detPlotter,detPos)
    end

end

if ~isequal(get(scenarioSim,"SimulationStatus"),"Stopped")
    set(scenarioSim,"SimulationCommand","Step");
end

simTime = simTime + stepSize;
pause(0.1)
end
```

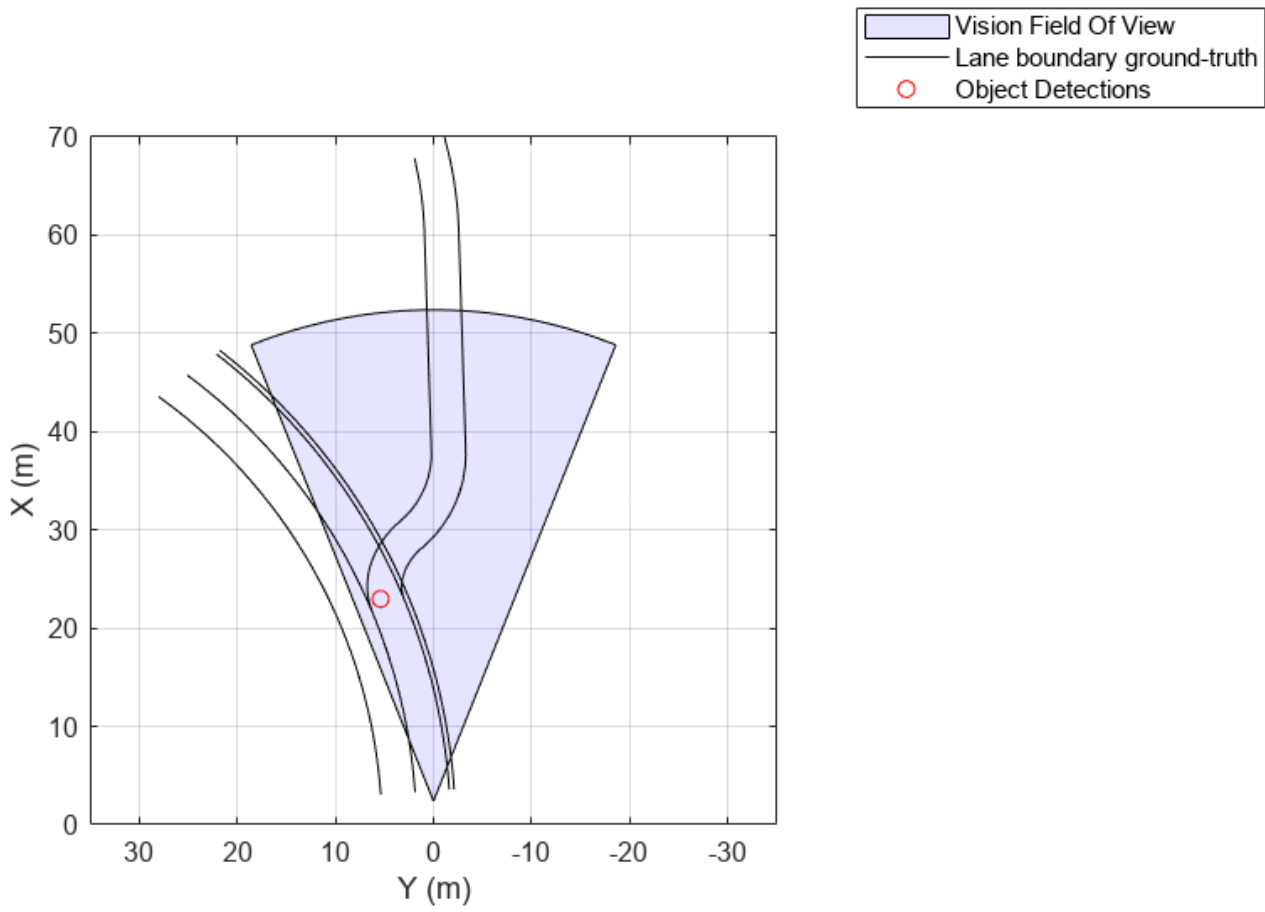

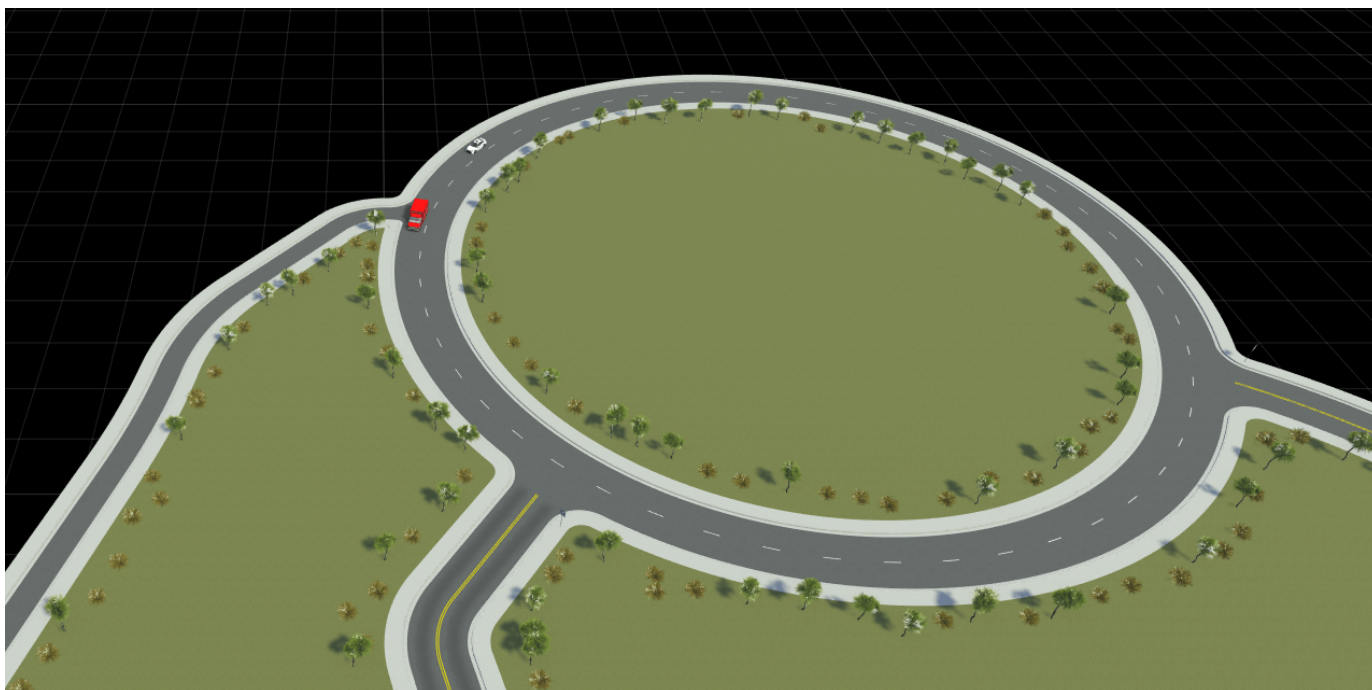

Helper Functions

`helperSetupBEP` function creates a bird's-eye-plot and configures all the plotters for visualization.

`helperPlotLaneBoundaries` function plots the lane boundaries on the birds'eye-plot.

Input Arguments

sensorSim — Sensor simulation object

`SensorSimulation` object

Sensor simulation object, specified as a `SensorSimulation` object. The sensor simulation object must correspond to the desired scenario created in RoadRunner Scenario.

sensorID — Unique index of sensor in RoadRunner scenario

positive integer

Unique index of the sensor in the RoadRunner scenario, specified as a positive integer. This must be same as the `SensorIndex` property of the detection generator object that corresponds to the desired sensor.

Output Arguments

poses — Target poses

structure | array of structures

Target poses, in ego vehicle coordinates, returned as a structure or as an array of structures. This output does not include the pose of the host vehicle actor.

A target pose defines the position, velocity, and orientation of a target in ego vehicle coordinates. Target poses also include the rates of change in actor position and orientation.

Each pose structure has these fields.

Field	Description
ActorID	Scenario-defined actor identifier, returned as a positive integer.
ClassID	Classification identifier, returned as a nonnegative integer. 0 represents an object of an unknown or unassigned class.
Position	Position of actor, returned as a real-valued vector of the form $[x \ y \ z]$. Units are in meters.
Velocity	Velocity (v) of actor in the x -, y -, and z -directions, returned as a real-valued vector of the form $[v_x \ v_y \ v_z]$. Units are in meters per second.
Roll	Roll angle of actor, returned as a real scalar. Units are in degrees.
Pitch	Pitch angle of actor, returned as a real scalar. Units are in degrees.
Yaw	Yaw angle of actor, returned as a real scalar. Units are in degrees.
AngularVelocity	Angular velocity (ω) of actor in the x -, y -, and z -directions, returned as a real-valued vector of the form $[\omega_x \ \omega_y \ \omega_z]$. Units are in degrees per second.

For full definitions of these structure fields, see the `actor` and `vehicle` functions.

Version History

Introduced in R2023a

See Also

`SensorSimulation` | `laneBoundaries` | `addSensors`